

UC-NRLF

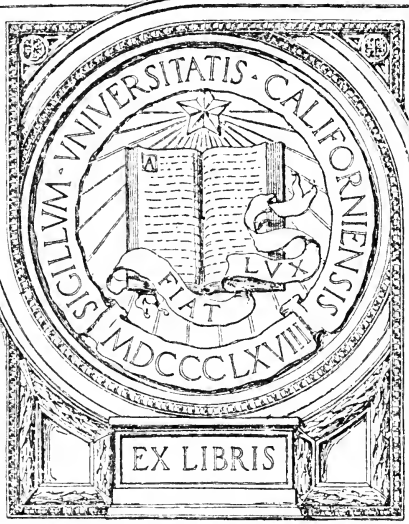

QB 26 777



EX LIBRIS

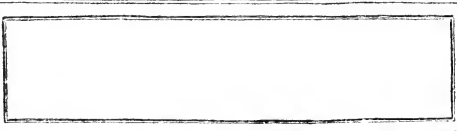











## WORKS OF PROF. M. A. HOWE

PUBLISHED BY

JOHN WILEY & SONS, Inc.

### **Masonry.**

A short Text-book on Masonry Construction, including Descriptions of the Materials Used, their Preparation and Arrangement in Structures. 8vo, ix + 160 pages. 115 figures. Cloth, \$1.50 net.

### **Foundations.**

A short Text-book on Ordinary Foundations, including a brief Description of the Methods Used for Difficult Foundations. 8vo, vii + 110 pages. 56 figures. Cloth, \$1.25 net.

### **Influence Diagrams for the Determination of Maximum Moments in Trusses and Beams**

8vo, vii + 65 pages, 42 figures. Cloth, \$1.25 net.

### **The Design of Simple Roof-trusses in Wood and Steel.**

With an Introduction to the Elements of Graphic Statics. Third edition, revised and enlarged. 8vo, vi + 173 pages, 124 figures and 3 folding plates. Cloth, \$1.80 net.

### **Retaining-walls for Earth.**

Including the theory of Earth-pressure as Developed from the Ellipse of Stress. With a Short Treatise on Foundations. Illustrated with Examples from Practice. Sixth edition, revised and enlarged. 12mo, xv + 194 pages, 110 figures. Cloth, \$1.25 net.

### **A Treatise on Arches.**

Designed for the use of Engineers and Students in Technical Schools. Second edition, revised and enlarged. 8vo, xxv + 369 pages, 74 figures. Cloth, \$4.00 net.

### **Symmetrical Masonry Arches.**

Including Natural Stone, Plain concrete and Reinforced concrete arches, for the use of Technical Schools, Engineers and Computers in Designing Arches according to the Elastic Theory. Second edition, revised and enlarged. 8vo, xxiv + 245 pages. Profusely illustrated with figures in the text and folding plates. Cloth, \$2.50 net.



# MASONRY

A Short Text-Book on Masonry Construction, Including  
Descriptions of the Materials Used, their Prepara-  
tion and Arrangement in Structures

BY

MALVERD A. HOWE, C. E.

Professor of Civil Engineering, Rose Polytechnic Institute; Member American Society  
of Civil Engineers, American Society for Testing Materials, Society for  
the Promotion of Engineering Education, Fellow American  
Association for the Advancement of Science

FIRST EDITION

FIRST THOUSAND



NEW YORK  
JOHN WILEY & SONS, INC.  
LONDON: CHAPMAN & HALL, LIMITED  
1915

TAG 70  
H6

Copyright, 1915, by  
MALVERD A. HOWE

THE  
PUBLISHERS  
PRINTING COMPANY

PUBLISHERS PRINTING COMPANY  
207-217 West Twenty-fifth Street, New York

## PREFACE

THE following pages have been written to furnish a concise treatment of masonry construction for use as a text in courses of instruction which do not provide sufficient time for the study of a more comprehensive treatise. The matter as presented, however, may serve as a skeleton for an extended course of study by making use of the references at the end of the book which suggest supplementary reading. The references are arranged in the order in which the subject matter is considered in the text.

Modern methods are described and modern tools and machinery are illustrated.

Reinforced concrete masonry has not been considered, as there are numerous books which treat this subject both in an elementary and in a thorough manner.

The specifications in Part III give the best modern methods of selecting materials and their use in structures.

M. A. H.

JANUARY, 1915.



# CONTENTS

## PART I. THE MATERIALS

### CHAPTER I

#### NATURAL BUILDING STONES

	PAGE
Natural Building Stone . . . . .	1
Geological Classification of Rocks . . . . .	1
Chemical Classification of Rocks . . . . .	2
Classification of Rocks According to Their Physical Structure . . . . .	2
Rocks Used for Building Stone . . . . .	2
Durability of Rocks . . . . .	2
Artificial Methods of Determining the Durability of Rocks . . . . .	3
The Absorption Test of Building Stones . . . . .	3
The Crushing Strength of Building Stones . . . . .	4
Freezing Tests of Building Stones . . . . .	5
Chemical Tests of Building Stones . . . . .	6
Microscopic Tests of Building Stones . . . . .	6
Determination of the Specific Gravity of Building Stones . . . . .	6
Minerals Which Are Injurious . . . . .	7
Granite . . . . .	7
Limestone . . . . .	8
Granular Limestone . . . . .	9
Compact Limestone . . . . .	9
Sandstones . . . . .	10
Slates . . . . .	10
Average Physical Properties of Building Stones . . . . .	11
Fire-Resisting Property of Stone . . . . .	12
Quarrying . . . . .	12
Joints in Relation to Quarrying . . . . .	12
Quarrying by Hand Tools . . . . .	13
Quarrying by Machinery . . . . .	14
The Use of Explosives in Quarrying . . . . .	14
Tools Used in Preparing Building Stones . . . . .	20
Power Tools for Finishing Stone . . . . .	24

	PAGE
Classification of Building Stones According to the Finish of the Surface .	28
Squared Stones . . . . .	29
Cut Stones . . . . .	30

## CHAPTER II

## ARTIFICIAL BUILDING MATERIALS

Building Brick . . . . .	33
Manufacture of Building Brick . . . . .	33
Drying Brick . . . . .	34
Burning Brick . . . . .	36
Modern Methods of Burning Brick . . . . .	37
Fuel Used in Burning Brick . . . . .	41
Annealing or Cooling Brick . . . . .	41
Classification of Brick . . . . .	41
Essential Requirements for Good Building Brick . . . . .	43
Ornamental Face Brick . . . . .	45
Sizes of Brick . . . . .	45
Sand Lime Brick . . . . .	45
Cement Bricks . . . . .	46
Hollow Terra-Cotta . . . . .	46
Plaster Blocks . . . . .	48
Fat or Quick Lime . . . . .	48
Burning Lime . . . . .	50
Natural Cement . . . . .	50
Portland Cement . . . . .	51
Iron-Ore Cement . . . . .	52
Magnesia Cement . . . . .	52
Puzzolan Cement . . . . .	52
Manufacture of Portland Cement . . . . .	53
Sand . . . . .	53
Testing Sand . . . . .	54
Gravel . . . . .	54
Voids in Sand and Gravel . . . . .	56
Mortar . . . . .	56
Lime Mortar . . . . .	57
Natural Cement Mortar . . . . .	57
Portland Cement Mortar . . . . .	57
Lime Paste Used with Cement Mortar . . . . .	57
Water-Tight Mortar . . . . .	58
Colored Cement Mortar . . . . .	58
Pointing Mortar . . . . .	58

## PART II. MASONRY

## CHAPTER III

## STONE MASONRY

	PAGE
Masonry . . . . .	59
Definitions . . . . .	59
Classification of Stone Masonry . . . . .	61
Ashlar Masonry . . . . .	61
Dressing Joint Surfaces for Ashlar . . . . .	62
Backing and Filling for Ashlar . . . . .	63
Bond . . . . .	64
Relative Dimensions of Stones . . . . .	66
Setting Stone . . . . .	66
Pointing . . . . .	70
Joint Mortar . . . . .	71
Pointing Mortar . . . . .	71
Squared-Stone Masonry . . . . .	71
Backing and Filling for Squared-Stone Masonry . . . . .	72
Bond, Mortar, Sizes of Stones, etc., for Squared-Stone Masonry . . . . .	72
Stope-Wall Masonry . . . . .	73
Stone Paving . . . . .	73
Specifications for Stone Paving . . . . .	73
Riprap . . . . .	73
Strength of Stone Masonry . . . . .	73
Measurement of Stone Masonry . . . . .	74
Water-proofing Stone Masonry . . . . .	75
Cleaning Stone Masonry . . . . .	75

## CHAPTER IV

## BRICK AND HOLLOW-TILE MASONRY

Brick Masonry . . . . .	76
Joints for Brick-work . . . . .	77
Mortar for Brick-work . . . . .	77
Pointing Joints of Brick-work . . . . .	77
Bond in Brick-work . . . . .	78
Crushing Strength of Brick-work . . . . .	81
Lintels Supporting Brick Masonry . . . . .	82
Efflorescence . . . . .	82
Measuring Brick-work . . . . .	83

	PAGE
Waterproofing Brick Masonry . . . . .	83
Cleaning Brick Masonry . . . . .	83
Hollow-Tile Masonry . . . . .	84

## CHAPTER V

## CONCRETE MASONRY

Concrete . . . . .	87
Reinforced Concrete . . . . .	87
Reinforcing Concrete for Shrinkage, etc. . . . .	87
Constituents of Concrete . . . . .	88
Proportions of Materials for Concrete . . . . .	88
Mixing Concrete . . . . .	89
Machines for Mixing Concrete . . . . .	90
Concrete Building Blocks . . . . .	91
Architectural Concrete . . . . .	93
Surface Finish for Concrete Blocks . . . . .	95
Monolithic and Mass Concrete . . . . .	95
Depositing Concrete in Mass Construction . . . . .	96
Mixing and Depositing Concrete by Compressed Air . . . . .	98
Mixing and Depositing Grout by Compressed Air . . . . .	100
Mixing and Depositing Concrete in Freezing Weather . . . . .	101
Depositing Concrete Under Water . . . . .	102
Finishing the Surface of Concrete . . . . .	104
Bush-Hammer Surface Finish . . . . .	105
Spaded Finish for Concrete Surfaces . . . . .	105
Brushed Concrete Surfaces . . . . .	105
Plaster Coats . . . . .	106
Sand-Blasted Surfaces . . . . .	107
Pebble Finish . . . . .	107
Special Surface Finish for Concrete . . . . .	107
Cement-Gun Surface Finish . . . . .	109
Forms for Mass Concrete . . . . .	110
Wetting and Oiling Forms . . . . .	111
Rubble Concrete . . . . .	112
Waterproofing Concrete . . . . .	113
Tests of the Absorptive and Permeable Properties of Portland Cement	
Mortars and Concretes . . . . .	114
Waterproofing with Asphalt and Coal Tar . . . . .	118
Joining Old and New Concrete . . . . .	119
Effect of Alkali and Sea-water on Concrete . . . . .	119
Physical Properties of Concrete . . . . .	120
Fire-Resisting Property of Concrete . . . . .	120



## PART III. SPECIFICATIONS

## CHAPTER VI

## RAILROAD MASONRY, BRICK CEMENT, ETC.

	PAGE
Classification of Railroad Masonry . . . . .	121
Definitions . . . . .	122
Specifications for Stone Masonry . . . . .	127
Specifications for Plain Concrete . . . . .	133
Specifications for Building Brick . . . . .	138
Specifications for Lime . . . . .	141
Specifications for Sand . . . . .	143
Specifications for Cement . . . . .	144

## REFERENCES

Periodicals . . . . .	150
Books . . . . .	153



# MASONRY

## PART I.—THE MATERIALS

### CHAPTER I

#### NATURAL BUILDING STONES

**Natural Building Stone** is obtained from rock which has been formed by natural processes. Its use for a particular purpose depends upon its chemical and physical properties. Rocks may be classified according to their geological position, their chemical composition, or their physical structure.

**Geological Classification of Rocks.**—The three geological divisions of rocks are igneous, sedimentary, and metamorphic.

*Igneous* rocks are those which have been formed by “cooling from fusion,” the melted rock having come up through fissures in the earth’s rocky crust. When the melted rock has solidified on the surface, it is designated as *extrusive* or *volcanic*. Lava is an example. When for some reason the solidification takes place below the surface the rock is designated as *intrusive* or *plutonic*. Granite is an example.

*Sedimentary* or *stratified* rocks are those which have, in general, been laid down under water by mechanical, organic, or chemical agents. This division also includes those rocks which have been formed through the action of winds. The shales and sandstones (water deposits) are examples of rocks having mechanical origin; gypsum, rock salt, and some limestones are examples of rocks having chemical origin formed from solution; and numerous limestones and coal are examples of organic origin.

*Metamorphic* rocks have been formed from original

igneous or sedimentary rocks chiefly through the action of heat, pressure, and water. Crystalline limestones are metamorphosed limestones.

**Chemical Classification of Rocks.**—Chemically, rocks are divided into argillaceous, calcareous, and siliceous.

*Argillaceous* rocks are those in which alumina gives the characteristic properties, slate being an example.

*Calcareous* rocks or limestones are those which are principally composed of carbonate of lime.

*Siliceous* rocks are those in which silica is the principal constituent. Granite, quartzite (a siliceous sandstone), and buhrstone (a cellular siliceous rock used for millstones) are examples.

**Classification of Rocks According to Their Physical Structure.**—Rocks are classified according to their physical structure as stratified and unstratified. A large number of the limestones and sandstones are examples of the stratified rocks, and basalt, granite, and lava examples of the unstratified rocks.

**Rocks Used for Building Stone.**—The principal rocks used for building purposes are granite, limestone, and sandstone. Trap-rock is used but little, owing to the difficulty with which it is quarried and cut.

The selection of stone for a particular structure depends upon a number of things which differ in different parts of the country. The durability of the stone, if exposed to the weather, is of prime importance. For footings of heavy structures it must have the proper strength, and for buildings, etc., the question of color may be an important factor governing the selection. The cost of quarrying, cutting, and transporting will, of course, govern the choice between two kinds of stone which are otherwise satisfactory.

**Durability of Rocks.**—The durability of a rock depends upon the closeness of its texture and the absence of anything in its make-up which is liable to oxidation. Any rock which is sufficiently porous to admit air or water will degrade more or less to the depth of penetration of the air

or water. This is due partly to chemical action, and, in cold climates, to alternate freezing and thawing.

Coarse-grained rocks are injured by alternate heating and cooling in the daily passage of the sun. Rock which has been protected by a layer of earth, and which shows the marks of glacial action, will disintegrate on the *surface* when exposed to the air, due to changes of temperature probably.

There is but one way, which is conclusive, to determine the durability of a building stone in a particular locality, and that is to examine it where it has been used in said locality. It does not follow if a stone is durable in one locality that it will be equally durable in another. This is well illustrated by the almost perfect condition of the obelisks in Egypt, and the disintegration of Cleopatra's Needle after it was transported, in 1880, to New York City.

In general, stones which absorb but little water, and those having smooth surfaces exposed to the weather, are more durable than those which absorb considerable water or have rough surfaces exposed. There are a few exceptions to this statement.

**Artificial Methods of Determining the Durability of Rocks.**—While not conclusive, artificial methods of determining the durability of rocks are, more or less, in general use. These methods comprise the determination of the amount of water the rock will absorb, the crushing strength, the resistance to the action of frost, the solubility in acids, a microscopical examination, and the determination of the specific gravity.

**The Absorption Test of Building Stones.**—To determine the amount of water which a stone will absorb in a given period of time, a small piece is dried for twenty-four hours at a temperature not lower than 212° F. The specimen is then weighed and placed in clean water for at least twenty-four hours; then it is removed from the water, its surface wiped fairly dry, and is again weighed. The difference between the wet and dry weights divided by the dry weight is the percentage of absorption. As this test is com-

parative, the specimens should be of about the same size and shape, and the time intervals the same for all specimens. As air imprisoned in the stone will prevent the entrance of water, the coefficient of absorption will be materially increased if the dry specimen is placed under the receiver of an air pump, and the air exhausted. Complete saturation of a specimen may be determined by repeated weighings while it is in the water.

The percentage of absorption should not exceed about 3 per cent. There are a few exceptions to this, however, where the percentage of absorption is as high as 6 per cent, and the stones very durable.

**The Crushing Strength of Building Stones.**—This is of prime importance only for very heavy structures, but it is an approximate guide to the durability of the stone, the stronger stones being more durable than the weaker stones.

To obtain the crushing strength of a stone, a specimen in the form of a cube is cut from the stone and crushed in a testing machine designed for compressive tests. A record is made when the first crack appears and when the specimen fails. For the best results, the specimens should be sawed approximately to shape and then ground to the proper size. The faces of the specimen should be planes, and the opposite faces should be parallel. Steel plates without any bedding between them and the specimen should be used to transmit the load. These conditions are difficult to obtain, so that it is more or less customary to bed the specimens in plaster of Paris, a piece of oiled paper being placed between the plaster and the specimen.

The use of cubical specimens is quite satisfactory when only comparative strengths are wanted. The strengths obtained from cubical specimens are in excess of the normal strengths as obtained from prisms which are one and one-half the least lateral dimension in height. Stratified stones are usually tested with the stratifications horizontal.

For all ordinary structures, the building stones in common

use are very much stronger than necessary to carry the superimposed loads.

**Freezing Tests of Building Stones.**—Two methods are followed for this test. In one, the stone is saturated with water, frozen and thawed; and in the other, the action of frost is artificially obtained by the action of Glauber's salts. There appears to be no standard course of procedure in either method. For the natural-freezing method, Baushinger used the practical process, "consisting in the exposure of the material twenty-five times to frost in the open air, the (crushing) strength, before and after the test, serving as a guide to the resisting power." (Van Nostrand's Engineering Magazine, Vol. XXXIV, 1886, p. 44.)

For the natural method, the specimens may be two-inch cubes. One set of specimens is thoroughly dried and tested in compression. The other set is thoroughly dried and placed in water for twelve hours, and then frozen. Cold-storage plants are so common now that the specimens can be sufficiently frozen in twelve hours. The soaking and freezing are repeated from ten to twenty-five times, and then the specimens are thoroughly dried and tested in compression. The same soaking and freezing routine is followed if the loss of weight is wanted. Usually, the loss of weight is very small.

The artificial-freezing test, or the sulphate of soda test, is made in several ways. The following method is recommended by Johnson (The Materials of Construction). The solution in which the specimens are immersed is a boiling solution of the sulphate of soda, commonly known as Glauber's salts. "The specimens should be heated before immersion in the boiling liquid, or they should be immersed before the liquid has come to the boiling temperature. The time of immersion need not be over thirty minutes, after which the specimens should be freely suspended in the open air for twenty-four hours. They are then sprayed from a wash-bottle and again immersed and boiled, this process being repeated for any desired number of times, generally

from seven to ten. The specimens should be small, about one-inch cubes being a suitable size, as the weighings have to be done with great care on delicate balances to secure reliable results. The specimens must be carefully dried for twenty-four hours, at a temperature above boiling, before the first weighing and after the long soaking in fresh water subsequent to the tests."

The artificial test is much more severe on stone than the natural test. Both tests are comparative and of little value. A description of methods with discussion is given in a paper entitled "The Relative Effects of Frost, and the Sulphate of Soda Efflorescence Tests on Building Stones," by Lea McI. Luquer, Transactions of the American Society of Civil Engineers, Vol. XXXIII, 1895, p. 235.

**Chemical Tests of Building Stones.**—These appear to have little value unless made for the determination of constituents which may stain the stone, or in connection with microscopical examinations.

**Microscopic Tests of Building Stones.**—This test, when made by an expert, is probably the most valuable of any of those mentioned. The structural arrangement, the identification of its constituent parts, and the character of the cementing material of the specimen are determined by this method.

**Determination of the Specific Gravity of Building Stones.**—The weight of building stone is of importance in all structures subjected to overturning forces and the pressure of water, the heavier stones being better suited to resist such forces.

A small specimen is thoroughly dried and weighed, then saturated with water, and weighed again in the manner described for the absorption test. The saturated specimen is then weighed in water. Letting  $W$  represent the dry weight,  $W_s$  the saturated weight, and  $W_w$  the weight in water, then the specific gravity, dry, equals  $W/(W_s - W_w)$ , and the specific gravity, wet, equals  $W_s/(W_s - W_w)$ . The weight per cubic foot is found by multiplying the weight



of a cubic foot of water (62.4 pounds, approximately) by the specific gravity.

**Minerals Which Are Injurious.**—Some minerals are injurious under all conditions, while others are only injurious when distributed in a particular manner.

*Chert*, or *flint*, forms the so-called *glass seams* in limestone. It is very much harder than the surrounding stone and, consequently, interferes with the cutting, and is much more resistant to the weather, forming ridges on weathered stone. A *glass seam* which extends completely through the stone does not affect its strength, but very often a seam which appears on the surface only extends into the stone a short distance, and beyond this point there may be an open seam. Therefore, for durability, all stone with *glass seams* should be rejected.

*Mica* occurs in granites, sandstones, and marbles, but usually it is not harmful, especially if uniformly distributed throughout the rock. In stratified rocks, it is harmful if it is segregated along the planes of stratification. It is also harmful in some of the crystalline limestones where it may occur as scattered grains or in bands. The scattered grains do not do much harm, but bands injure the polish of marbles, and also affect the durability of the stone, as the mica bands do not weather well.

*Pyrite* and other iron sulphides, in small quantities, as specks here and there in stone, do not do much harm. As the quantity increases, the exposure to the weather causes pits, and, in many cases, the stone is stained. Stones which contain iron as ferrous carbonate also stain.

**Granite.**—As commonly used, the term granite includes all igneous rocks and gneiss (gneiss has mica and other constituents more or less in layers). According to Ries and Watson, granite is an even granular, crystalline, plutonic, igneous rock composed of quartz and alkalic feldspar (common feldspar), with usually mica, hornblende, or pyroxene.

The quartz (oxygen and silica) is usually grayish white, glassy, and without any appearance of cleavage. The feld-

spar (silica, alumina, and potash) is whitish or flesh-colored, and is distinguished from the quartz by its cleavage surfaces which reflect light brilliantly. The mica (silica, alumina, potash +) is generally in small flat scales, either black, brownish black, or silvery. The combined silica in the quartz, feldspar, and mica constitutes over fifty per cent of the rock.

The *specific gravity* of granite ranges from 2.5 to 2.8, which corresponds to weights per cubic foot of 156 to 175 pounds.

The *crushing strength* of granite is very variable, even for stones from the same region. The range may be taken as 13,000 to 26,000 pounds per square inch, although some granites have considerably less strength, and some a strength as high as 43,000 pounds per square inch.

The *modulus of rupture* of granite, used as a beam over an opening, for example, is about 1,800 pounds per square inch. This is an average value.

*Young's modulus of elasticity* varies from 4,500,000 to 9,800,000 pounds per square inch in compression. This is a very uncertain property, as it does not vary directly with the compressive load. The loads corresponding to the above values lie between 100 and 1,000 pounds per square inch.

The *coefficient of expansion* for each degree Fahrenheit ranges from .00000324 to .00000461.

The *absorption* of water by granite seldom exceeds one per cent.

Granites make very excellent building stones, and can be used for all purposes from the bottom stones in a heavy footing to the carved statuary of a building. The material is one of the hardest to work, but modern methods have done away with many difficulties which formerly existed. The usual color of granite is gray, but pink and red granites are more or less common.

**Limestone** is stratified rock of sedimentary origin, and is the general name for all of the massive varieties of calcite

(lime, carbon-dioxide +) which occur in extensive beds. The principal constituent is carbonate of lime.

**Granular Limestone**, often called crystalline limestone, is of metamorphic origin, and is composed of crystalline grains. The coarser-grained stones are used in the construction of marble buildings and the finer-grained stones for statuary.

The colors have a wide range; some of the more common colors are white, gray, black, red, pink, green, and yellow.

**Compact Limestone** breaks with a smooth, dull surface, and does not show a distinct granular structure. When it can be polished, some of it is very beautiful and is used as marble. The famous oolitic limestones of Indiana belong to the compact limestones.

The *specific gravity* of limestone ranges from 2.52 to 2.69, corresponding to weights of 157 to 168 pounds per cubic foot.

The *crushing strength* of limestone is very variable. The greatest strength obtains for some stone when tested on edge, and for others when tested on the bed. When specific data are not obtainable, 10,000 pounds per square inch may be considered a fair average value for the crushing strength.

The *modulus of rupture* varies from 300 to 2,700 pounds per square inch.

*Young's modulus of elasticity* in compression ranges from 3,600,000 to 13,600,000 pounds per square inch, and, as is the case for all stones, the values are true only for certain compressive stresses.

The *coefficient of expansion*, for each degree Fahrenheit, varies from .00000058 to .00000634.

The *absorption* of water may be less than one per cent or over twelve per cent. The hard limestones usually absorb less than two per cent of water, but many stones, widely used and of excellent durability, have coefficients exceeding four per cent.

Limestone is used for nearly all purposes in construction where stone is suitable. The marbles are used for exterior walls, interior finish, and for decorative purposes.

**Sandstones** and quartzites are generally composed of grains of quartz cemented together by some substance. The quartz grains may be coarse or fine, and the cementing material may be clay, calcium carbonate, iron oxide, or silica. The cementing material affects the strength and color of the stone. The buff and yellow colors are due to limonite (brown hematite), the red and reddish brown colors are due to hematite (specular iron ore), and the bluish gray and black colors are due to clay or carbonaceous matter.

Sandstones always show a bedded structure. The layers are sometimes horizontal, and sometimes tipped.

The *specific gravity* varies from 2.34 to 2.649, corresponding to weights of 146 to 165 pounds per cubic foot.

The *crushing strength*, as in the case of limestones, is very variable, ranging from 4,300 to 19,000 pounds per square inch.

The *modulus of rupture* has a range of 700 to 2,300 pounds per square inch.

*Young's modulus of elasticity* for compression varies from 1,100,000 to 7,700,000 pounds per square inch, and, as stated for other stones, the values are only true for certain compressive stresses.

The *coefficient of expansion*, for each degree Fahrenheit, has a wide range, varying from .00000177 to .00000686.

The *absorption* coefficients have a range from less than one per cent, for quartzite, to over ten per cent, for the softer stones.

In general, the harder sandstones and quartzite make durable building stones. In all cases, however, the stones should be laid on their natural beds, and not on edge.

**Slates** are metamorphic rocks formed, usually, from clay or shale, and sometimes from fine-grained igneous rocks. They are used for roofing, stair treads, tubs, sinks, blackboards, etc. Locally, they are used for basement walls in buildings.

The colors are red, green, purple, and black. Some of the slates are unfading, and others are not. The only conclusive way to determine the unfading property is to com-

pare newly quarried slate with that which has been exposed to the weather for several years.

The *specific gravity* of slate varies from 2.7 to 2.9, corresponding to weights of 169 to 181 pounds per cubic foot.

The *crushing strength*, when tested normal to the cleavage planes, varies from 19,900 to 29,400 pounds per square inch, and when tested on edge, from 14,200 to 31,600 pounds per square inch, the specimens being cubes in both cases. (Tests of Metals, etc., 1902.)

The *modulus of rupture*, for the states upon which the above compression values are based, varies from 700 to 10,000 pounds per square inch.

*Young's modulus of elasticity* in compression, tests made on edge, averages about 14,000,000 pounds per square inch.

The *coefficient of expansion* is between .0000050 and .0000060, for each degree Fahrenheit.

The *absorption of water* is less than one-half of one per cent.

**Average Physical Properties of Building Stones.**—The several properties of stones given above at once show, by their range, that average values may be unsafe for some particular stone about which little is known. Stone from a new quarry should always be tested to the extent of showing that the stone is suitable for the purpose for which it is to be used.

The following table is given by Rudolph P. Miller, in the American Civil Engineer's Pocket Book, Mansfield Merri-man, Editor-in-Chief.

AVERAGE DATA FOR BUILDING STONES OF GOOD QUALITY

Kind of Stone	Pounds per Cubic Foot	Specific Gravity	Compressive Strength, Pounds per Square Inch	Shearing Strength, Pounds per Square Inch	Modulus of Rupture, Pounds per Square Inch	Young's Modulus of Elasticity, Pounds per Square Inch	Coefficient of Expansion per Degree Fahrenheit
Granite.....	170	2.72	15,000	2,000	1,500	7,000,000	.0000040
Sandstone...	150	2.40	8,000	1,500	1,200	3,000,000	.0000055
Limestone...	170	2.72	6,000	1,000	1,200	7,000,000	.0000045
Marble.....	170	2.72	10,000	1,400	1,400	8,000,000	.0000045
Slate.....	175	2.80	15,000	.....	8,500	14,000,000	.0000058
Trap.....	185	2.96	20,000	.....	.....	.....	.....

**Fire-Resisting Property of Stone.**—In general, *sandstone* is not seriously injured by the heat of a burning building, except it may be stained by smoke.

*Limestone* is uninjured in strength for temperatures which do not exceed about 900° F. The stone seldom cracks, but reduces to a powder under the application of water.

*Granite* appears to be a very poor fire-resistant, as it generally cracks.

The rapid change of temperature, due to throwing cold water on the heated stones, generally injures the faces of all building stones.

**Quarrying.**—All building stones, as a rule, are cut from rough blocks of stone which are separated from large masses of rock by quarrying. The particular method used in obtaining these rough blocks depends upon a number of conditions, such as the kind of rock, the amount required, the capital available, etc. For example, if a relatively small amount of stone is required, it is cheaper to use hand tools instead of power tools in quarrying, while for large quantities of stone the use of power tools is more economical.

The use of explosives is common in some localities, but where the stone is to be used for any purpose other than for rip-rap, broken stone, etc., it is better not to employ explosives.

**Joints in Relation to Quarrying.**—All rocks which are hard and firm are broken up into masses by joints. These may run in almost any direction, but usually they divide the rock into masses which are more or less regular in shape.

Joints in *bedded* rocks are generally in two systems running at right angles, and normal to the bedding planes.

In *igneous* rocks, there are usually two sets of joints, one horizontal and the other vertical, with sometimes an odd set running in a diagonal direction. The horizontal joints in granite are usually parallel to the surface of the rock (see Figs. 1 and 13). Basalt and lava are often divided by joints into vertical prismatic forms of columnar appearance.

The existence of joints greatly facilitates the quarrying of building stones, but they do not improve the quality of the stone, as all joint surfaces are more or less subjected to the action of deteriorating agencies.

**Quarrying by Hand Tools.**—Hand tools, such as the *crow-bar*, *pick*, *drill hammer*, *wedge*, and *plug and feathers*, are used



FIG. 1.—“Wood and Water,” or Wedging Up. Note Horizontal Joints.

in getting out all kinds of building stone (see Figs. 2, 3, 4, 5, 6, 7, 8, and 9), but such tools are more effective for rock in thin layers and somewhat soft. When the rock is in thin layers, these can be separated by the crow-bar and wedges, the vertical fracture following the jointing. If the pieces are too large, they are divided by drilling shallow holes a few inches apart along the line of proposed division, and then using the plug and feathers in each hole. The plug and feathers exert a tremendous pressure, and when properly used the hardest granite is easily separated. Where granites

are in large masses (that is, the joints are widely separated), the bed joints are opened by means of wooden wedges. These are driven dry and then wet with water (Fig. 1). This method was used by the Egyptians, and is now used in some of the largest granite quarries in the United States. Special steel wedges are also used for this work.

**Quarrying by Machinery.**—Marble is cut out in blocks of almost any desired size by the use of *channeling machines* (Figs. 10 and 11), which cut a narrow channel, either vertically or horizontally, for the full breadth of the face of the block to be cut out. This method saves a large waste and avoids the forming of incipient cracks which sometimes result from using other methods. In granite quarries of much magnitude and where large blocks are wanted, a series of vertical and horizontal holes are drilled a few inches apart along two faces by *machine drills* (Fig. 12), and then the block is separated from the rock mass by a "broach," a chisel used to break the stone between the holes, or plugs and feathers. The depth of the holes depends upon the nature of the rock and the amount of waste which can be permitted. Spires sixty feet long, and from four to five feet square in section, have been quarried by drilling and broaching (Figs. 13 and 14).

The channeling machines and the power drills are operated by steam, electricity, or compressed air. Pneumatic and electric hand drills are now extensively coming into use, and are very handy and serviceable (Fig. 15).

**The Use of Explosives in Quarrying.**—As stated above, the use of explosives is not advisable, where dimension stone is desired, on account of the waste which follows from the irregularity of the pieces detached by explosives and the danger of cracks. It is often economical, however, to use explosives in separating large blocks of rock which are afterward broken into smaller pieces by means of a series of plugs and feathers.

In using explosives, holes are drilled by hand or by power drills to the depth to which the rock is to be broken, and



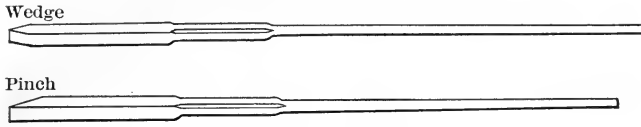

FIG. 2.—Crow Bars.

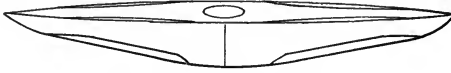

FIG. 3.—Stone Pick.

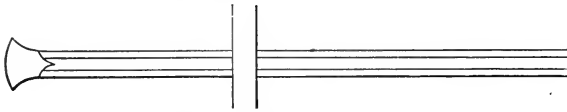

FIG. 4.—Common Drill.

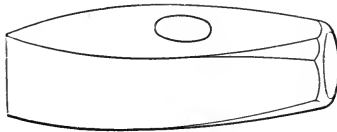

FIG. 5.—Flat Face Stone Sledge.

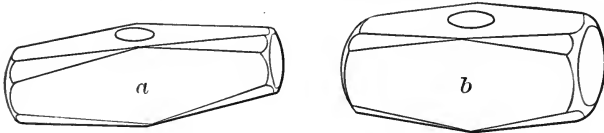

FIG. 6. Drilling or Striking Hammers. (*a*) Nevada Pattern. (*b*) Oregon Pattern.

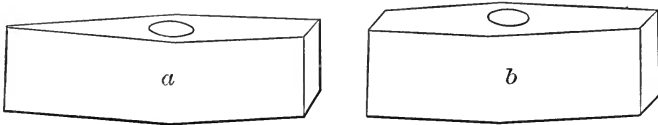

FIG. 7.—Spalling or Stone Hammers. (*a*) Single Face. (*b*) Double Face.

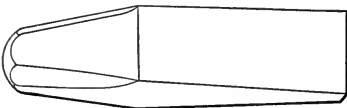

FIG. 8.—Stone Wedge.

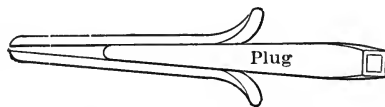

FIG. 9.—Plug and Feathers.

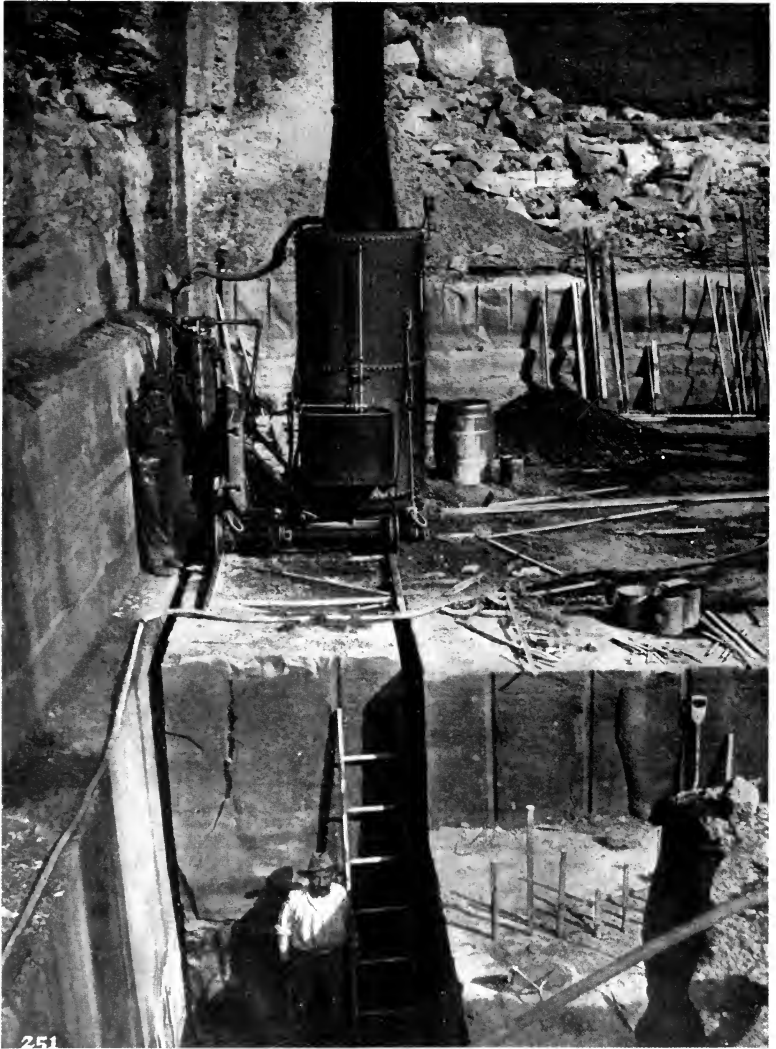

FIG. 10.—Channeling a 9-foot Key Block. Ingersoll-Sergeant Track Channeler. (Ingersoll-Rand Co.)

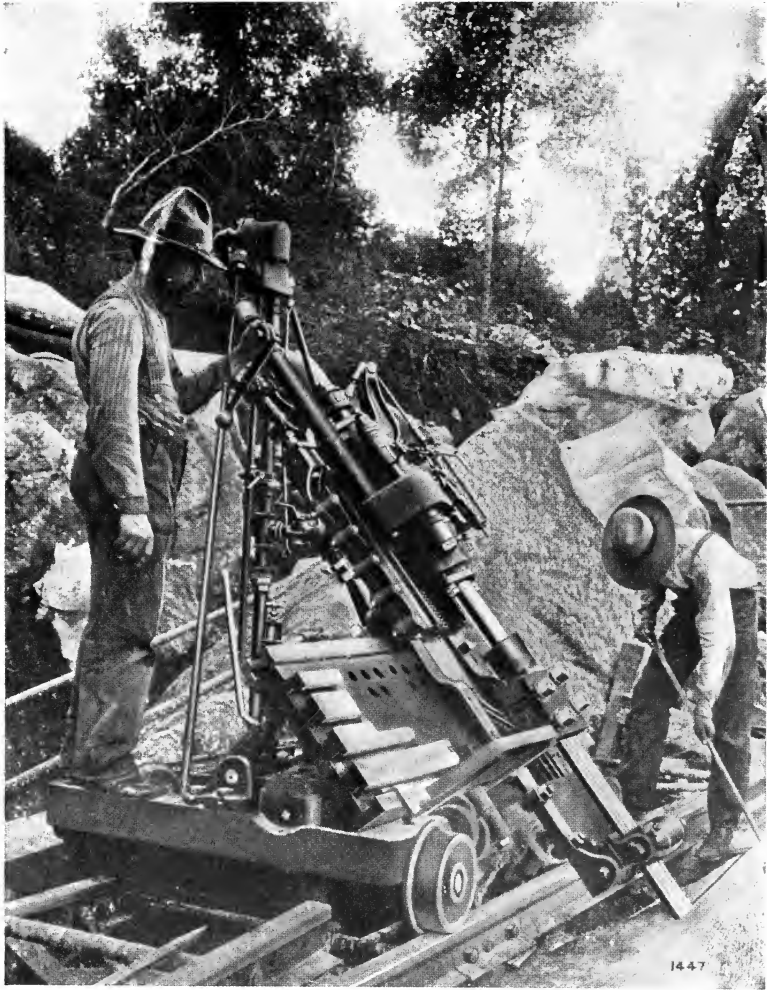

FIG. 11.—Swing Back Type of Ingersoll-Sergeant Track Channeler as Illustrated in a 5-inch "Marble" Channeler. (Ingersoll-Rand Co.)

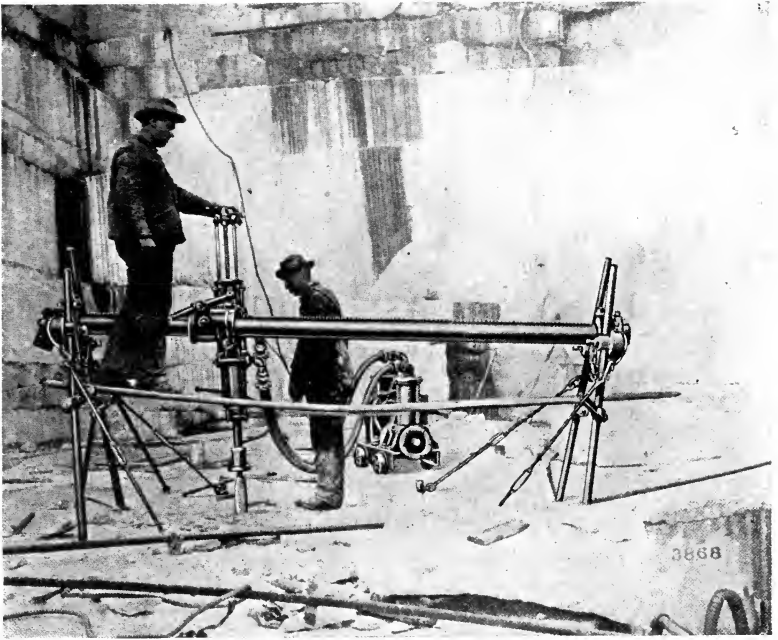

FIG. 12.—“Electric Air” Drill on a Quarry Bar Working in Barre Dark Granite. (Ingersoll-Rand Co.)



FIG. 13.—Spire of Granite Separated from Rock Mass on all Sides Except One End. Horizontal Joints of Rock Mass Are Clearly Shown.



FIG. 14.—A Spire of Barre (Vt.) Granite Over 60 Feet Long, Showing Marks of Drills, Also Showing Shallow Holes on End for Plug and Feathers.



FIG. 15.—“Jack-hammer” at Work Drilling Horizontal Holes at the Diamond Slate Company’s Quarries, Pen Argyl, Pa. (Ingersoll-Rand Company.)

then small charges of coarse black powder are put in the holes and fired. Several repetitions of small charges, lightly tamped, is better than the same amount of powder in one blast. A heavy explosion is liable to break up the rock and form incipient cracks. Quick-acting explosives like dynamite (nitro-glycerine mixed with a granular absorbent) are not as satisfactory as black powder, since their action shatters the rock.

**Tools Used in Preparing Building Stones.**—The following descriptions and names of tools were first published in the Transactions of the American Society of Civil Engineers, Vol. VI, pp. 297–304, and have been quoted in many publications since then.

“The *Double Face Hammer* (Fig. 7b) is a heavy tool weighing from 20 to 30 pounds, used for roughly shaping stones as they come from the quarry, and knocking off projections. This is used only for the roughest work.

“The *Face Hammer* (Fig. 7a) has one blunt and one cutting end, and is used for the same purpose as the double face hammer where less weight is required. The cutting end is used for roughly squaring stones, preparatory to the use of finer tools.

“The *Cavil* (Fig. 16) has one blunt and one pyramidal, or

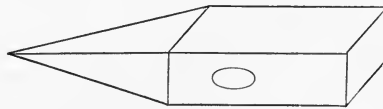

FIG. 16.—Cavil.

pointed, end, and weighs from 15 to 20 pounds. It is used in quarries for roughly shaping stones for transportation.

“The *Pick* (Fig. 17) somewhat resembles the pick used in digging, and is used for rough dressing, mostly on limestone and sandstone. Its length varies from 15 to 24 inches, the thickness at the eye being about two inches.

“The *Axe* or *Pean Hammer* (Fig. 18b) has two opposite cutting edges. It is used for making drafts around the arris,

or edge of stones, and in reducing faces, and, sometimes, joints to a level. Its length is about 10 inches, and the

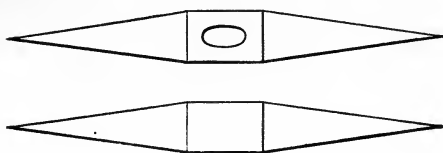

FIG. 17.—Stone Pick.

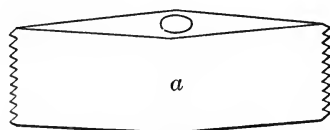
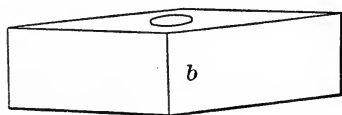

FIG. 18.—(a) Stone Axe with Teeth. (b) Stone Axe.

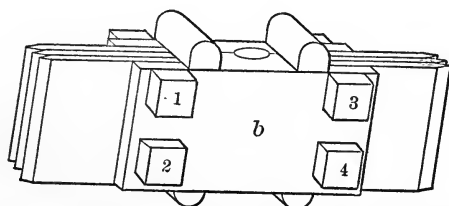
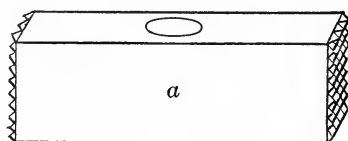

FIG. 19.—Bush Hammers. (a) Solid. (b) With Leaves. "Patent Hammer."

cutting edges about 4 inches. It is used after the point and before the patent hammer.

“The *Tooth Axe* (Fig. 18a) is like the axe, except that its cutting edges are divided into teeth, the number of which varies with the kind of work required. This tool is not used on granite and gneiss cutting.

“The *Bush Hammer* (Fig. 19a) is a square prism of steel whose ends are cut into a number of pyramidal points. The length of the hammer is from 4 to 8 inches, and the cutting face from 2 to 4 inches square. The points vary in number, and the size with the work to be done.

“The *Patent Hammer* (Fig. 19b) is a double-headed tool so formed as to hold at each end a set of wide thin chisels. The tool is in two parts which are held together by the bolts which hold the chisels. Lateral motion is prevented by four guards on one of the pieces. The tool without teeth is  $5\frac{1}{2} \times 2\frac{3}{4} \times 1\frac{1}{2}$  inches. The teeth are  $2\frac{3}{4}$  inches wide. Their thickness varies from  $\frac{1}{2}$  to  $\frac{1}{6}$  of an inch. This tool is used for giving a finish to the surface of stones.

“The *Crandall* (Fig. 20) is a malleable iron bar about two feet long, slightly flattened at one end. In this end is a slot 3 inches long and  $\frac{3}{8}$  inch wide. Through this slot are passed ten double-headed points of  $\frac{1}{4}$ -inch squared steel, 9 inches long, which are held in place by a key.

“The *Hand Hammer* (Fig. 21), weighing from 2 to 5 pounds, is used in drilling holes, and in pointing and chiseling the harder rocks.

“The *Mallet* (Fig. 22) is used where the softer limestones and sandstones are to be cut.

“The *Pitching Chisel* (Fig. 23) is usually of  $1\frac{1}{8}$ -inch octagonal steel, spread on the cutting edge to a rectangle of  $1 \times 2\frac{1}{2}$  inches. It is used to make a well-defined edge to the face of a stone, a line being marked on the joint surface to which the chisel is applied, and the portion of the stone outside of the line broken off by a blow with the hand hammer on the head of the chisel.

“The *Point* (Fig. 24) is made of round or octagonal rods of steel, from  $\frac{1}{4}$  to 1 inch in diameter. It is made about 12 inches long, with one end brought to a point. It is used



until its length is reduced to about 5 inches. It is employed for dressing off the irregular surface of stones, either for

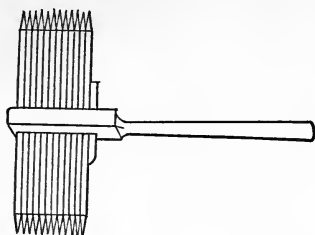

FIG. 20.—Crandall.

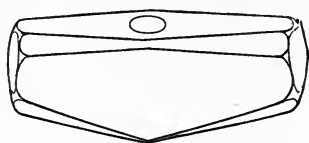
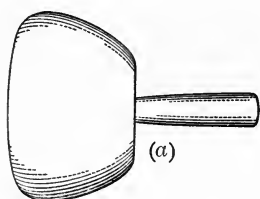
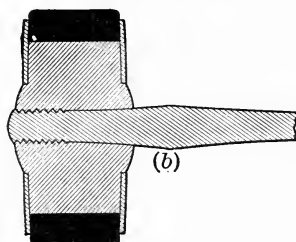

FIG. 21.—Stonecutter's Hammer.



(a)



(b)

FIG. 22.—Stonecutters' Mallets. (a) Hickory Mallet, 5 to 7½ Inches in Diameter. (b) Vulcanized Fiber-head Mallet, 2 to 3 Inch Face.

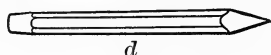

d

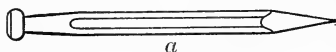

a

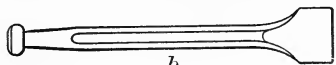

b

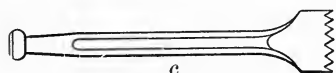

c

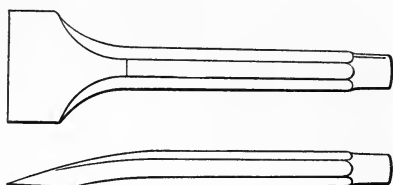

FIG. 23.—Pitching Chisel.

FIG. 24.—Stonecutters' Chisels. (a) Point. (b) Chisel. (c) Tooth Chisel. (d) Hammer-head Point. Chisels With Large Heads Are Used with the Wooden Mallet Shown in Fig. 22.

a permanent finish or preparatory to the use of the axe. According to the hardness of the stone, either the hand hammer or the mallet is used with it.

“The *Chisel* (Fig. 24) of round steel of  $\frac{1}{4}$  to  $\frac{3}{4}$  inch in diameter and about 10 inches long, with one end brought to a cutting edge from  $\frac{1}{4}$  inch to 2 inches wide, is used for cutting drafts or margins on the face of stones.

“The *Tooth Chisel* (Fig. 24) is the same as the chisel, except that the cutting edge is divided into teeth. It is used only on marbles and sandstones.

“The *Splitting Chisel* (Fig. 25) is used chiefly on the softer

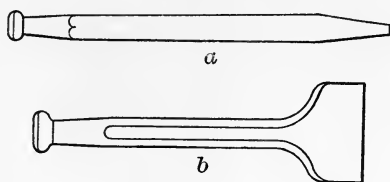

FIG. 25.—Stonecutters' Chisels. (a) Splitter. (b) Drove.

stratified stones, and sometimes on fine architectural carvings in granite.

“The *Plug*, a truncated wedge of steel, and the *Feathers*, of half-round malleable iron (Fig. 9), are used in splitting unstratified stone. A row of holes is made with the drill (Fig. 26) on the line on which the fracture is to be made; in each of these holes, two feathers are inserted and the plugs are driven in between them. The plugs are then gradually driven home by light blows of the hand hammer on each in succession until the stone splits.”

All of the above-described tools are for hand use, and the classification of masonry and kinds of finish are based upon their use. At the present time, however, there are in use a large number of machines for cutting, surfacing, polishing, etc., and for accomplishing the same end as reached with the use of hand tools.

**Power Tools for Finishing Building Stone.**—In extensive works, practically all of the work done on stone is accomplished with machinery. Large blocks are separated into smaller blocks by means of the *pneumatic plug driller* (Fig. 26), and plugs and feathers. The tools shown in Fig. 27 are

also used with the plug driller. For finer work and carving, the *pneumatic hammers* shown in Figs. 26*b* and 27 are used. A pneumatic hammer is also used on a portable *surfacing*

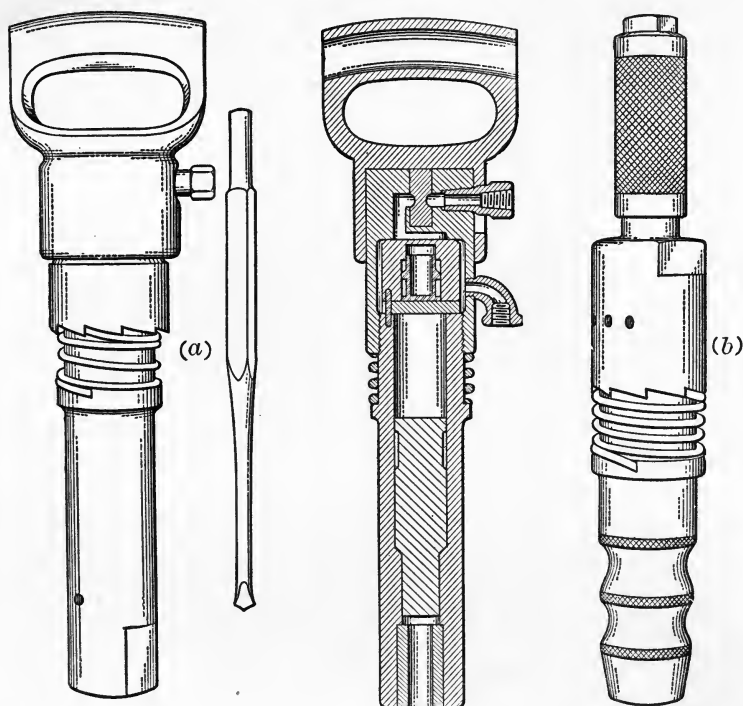

FIG. 26.—Pneumatic Hammers. (a) "Barre" Pneumatic Plug Drill. (b) "Barre" Pneumatic Bushing Tool. (Trow and Holden.)

*machine* (Fig. 29), with the tools shown in Fig. 28. With the above-mentioned tools, all of the work done by hand tools can be accomplished better, in less time, and at a less cost. There are numerous styles of pneumatic hammers and surfacing machines of which only one of each has been illustrated. The two machines shown are designed for working granite. The same devices are used in working limestone and sandstone, but with cutting tools of different shape. While the above descriptions have been confined to tools

operated by compressed air, similar devices are in use which are operated by electricity.

All of the rocks used for building stones can be sawed. The saws are diamond saws, soft iron saws, and wire rope,

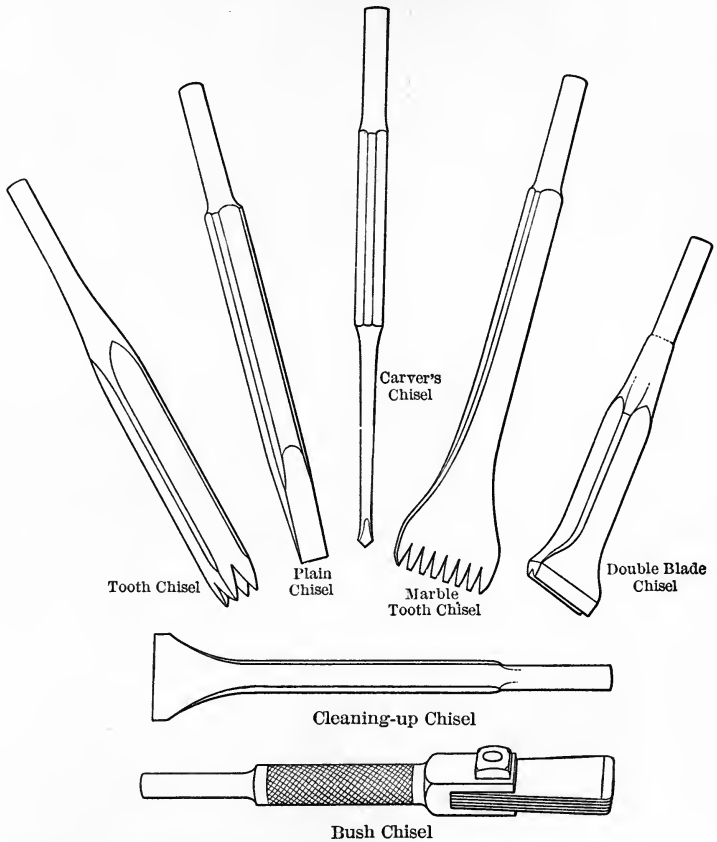

FIG. 27.—Pneumatic Tool Chisels. (George Oldham & Sons Co.)

the particular type depending upon the character of the stone. Thin slabs of marble and limestone are cut with the soft iron saws and wire rope, and slate is cut into blocks with the iron saws. The harder stones can be turned and polished in lathes, and the softer stones planed, where mouldings and similar forms are wanted. In fact, practically

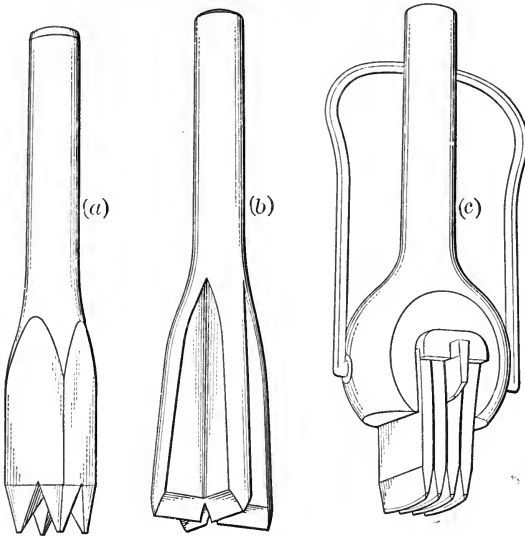

FIG. 28.—Pneumatic Surfacer Tools. (a) Tooth Chisel. (b) Cross Chisel. (c) Boltless Bush Chisel. (Trow and Holden.)

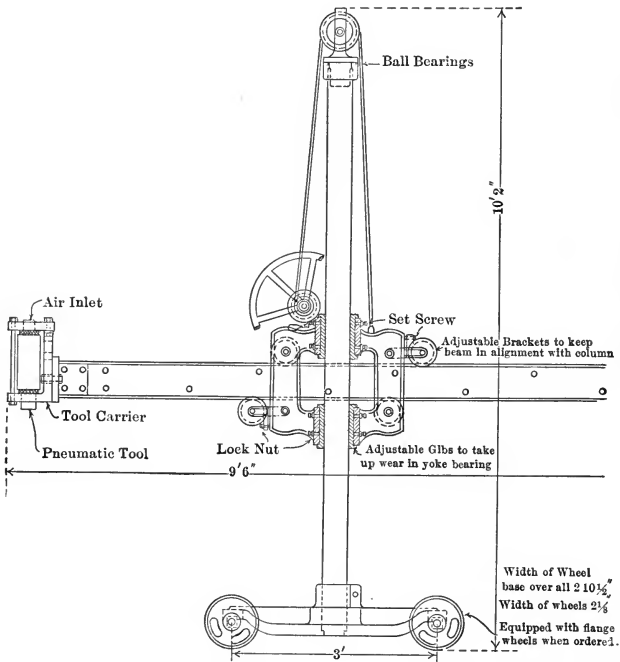

FIG. 29.—Portable Surfacing Machine Using Pneumatic Tools. (George Oldham & Son Co.)

every form of stone and surface finish used in building can be cut with power-operated tools.

**Classification of Building Stones According to the Finish of the Surface.**

“All stones used in building are divided into three classes, according to the finish of the surface, viz.:

“1. Rough stones that are used as they come from the quarry.

“2. Stones roughly squared and dressed.

“3. Stones accurately squared and finely dressed.

“In practice, the line of separation between them is not very distinctly marked, but one class merges into the next.

“**Unsquared Stones.**—This class covers all stones which are used as they come from the quarry, without other



FIG. 30.—Bridge at Ipswich, Mass. Built in 1764. Spandrel Wall Shows Unsquared Stones Laid as Random Coursed Rubble. Parapet Shows Coursed, Quarry-Faced Squared Stones.

preparation than the removal of very acute angles and excessive projections from the figure. The term *backing*, which is frequently applied to this class of stone, is inappropriate, as it properly designates material used in a certain relative

position in the wall, whereas stones of this kind may be used in any position (see Fig. 30).

“**Squared Stones.**—This class covers all stones that are roughly squared and roughly dressed on beds and joints. The dressing is usually done with the face hammer or axe, or, in soft stones, with the tooth hammer. In gneiss, it may sometimes be necessary to use the point. The distinction between this class and the third lies in the degree of closeness of joints. Where the dressing on the joints is such that the distance between the general planes of the surfaces of adjoining stones is one-half inch or more the stones properly belong to this class (see Fig. 30).

“Three subdivisions of this class may be made, depending on the character of the face of the stones.

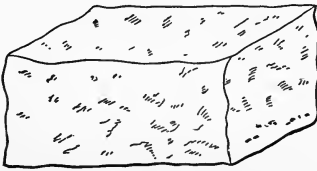

FIG. 31.—Quarry-Faced Squared Stone.

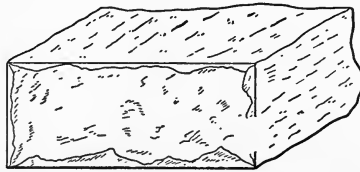

FIG. 32.—Pitched-Faced Squared Stone.

“*Quarry-faced* stones are those whose faces are left untouched as they come from the quarry (Fig. 31).

“*Pitch-faced* stones are those on which the arris is clearly

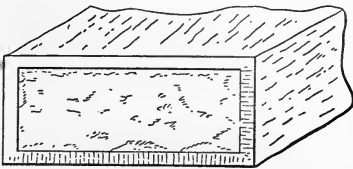

FIG. 33.—Drafted Stone.

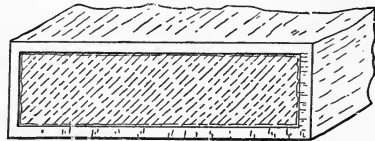

FIG. 34.—Rough-Pointed Face Finish.

defined by a line beyond which the rock is cut away by the pitching chisel, so as to give edges that are approximately true (Fig. 32).

“*Drafted Stones* are those on which the face is surrounded

by a chisel draft, the space within the draft being left rough. Ordinarily, however, this is done only on stones in which the cutting of the joints is such as to exclude them from this class (Fig. 33).

“In ordering stones of this class, the specifications should always state the width of the bed and end joints which are expected, and also how far the surface of the face may project beyond the plane of the edge. In practice, the proportion varies from 1 to 6 inches. It should also be specified whether or not the faces are to be drafted.

“**Cut Stones.**—This class covers all squared stones with smoothly dressed beds and joints. As a rule, all the edges of cut stones are drafted, and between the drafts the stone is smoothly dressed. The face, however, is often left rough where the construction is massive.

“In architecture, there are a great many ways in which the faces of cut stone may be dressed, but the following are those which will usually be met with in engineering work.

“*Rough-pointed.*—When it is necessary to remove an inch or more from the face of a stone, it is done by the pick or heavy point until the projections vary from  $\frac{1}{2}$  inch to 1 inch. The stone is then said to be rough-pointed (Fig. 34).

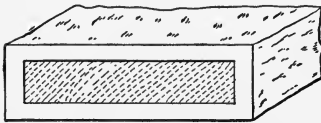

FIG. 35.—Fine-Pointed Face Finish.

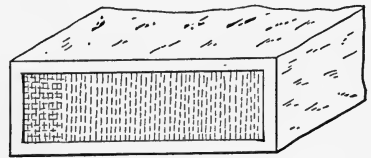

FIG. 36.—Crandalled Face Finish. Cross-Crandalled at Left End.

“*Fine-pointed* (Fig. 35).—If a smoother finish is desired, rough-pointing is followed by fine-pointing, which is done with a fine point. Fine-pointing is used only where the finish made by it is to be final, and never as a preparation for a final finish by another tool.

“*Crandalled.*—This is only a speedy method of pointing,



the effect being the same as fine-pointing, except that the dots on the stone are more regular. The variations of level are about  $\frac{1}{8}$  inch, and the rows are made parallel. When other rows at right angles to the first are introduced, the stone is said to be cross-crandalled (Fig. 36).

“*Axed or Pean-Hammered and Patent-Hammered.*—These two vary only in the degree of smoothness of the surface which is produced. The number of blades in a patent hammer varies from 6 to 12 to the inch; and, in precise specifications, the number of cuts to the inch must be stated, such as 6-cut, 8-cut, 10-cut, 12-cut. The effect of axing is to cover the surface with chisel marks, which are made parallel as far as practicable. Axing is a fine finish (Fig. 37).

“*Tooth-axed.*—The tooth-axe is practically a number of points, and leaves the surface of the stone in the same con-

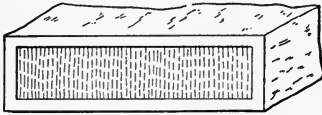

FIG. 37.—Axed or Pean-Hammered Face Finish.

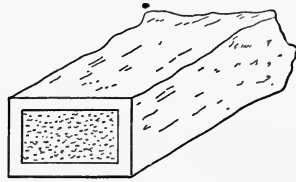

FIG. 38.—Bush-Hammered Face Finish.

dition as fine-pointing. It is usually, however, only a preparation for bush-hammering, and the work is done without regard to effect, as long as the surface of the stone is sufficiently level.

“*Bush-hammered.*—The roughness of the stone is pounded off by the bush hammer, and the stone is then said to be *bushed*. This kind of finish is dangerous on sandstone, as experience has shown that sandstone thus treated is very apt to scale. In dressing limestone which is to have a bush-hammered finish, the usual sequence of operations is: (1) rough-pointing, (2) tooth-axing, and (3) bush-hammering (Fig. 38).

“*Rubbed.*—In dressing sandstone and marble, it is very common to give the stone a plane surface at once by the use of the stone saw. Any roughnesses left by the saw are removed by rubbing with grit or sandstone. Such stones, therefore, have no margins. They are frequently used in architecture for string courses, lintels, door-jambs, etc., and they are also well adapted for use in facing the walls of lock-chambers and in other locations where a stone surface is liable to be rubbed by vessels or other moving bodies.

“*Diamond Panels.*—Sometimes the space between the margins is sunk immediately adjoining them, and then rises gradually until the four planes form an apex at the

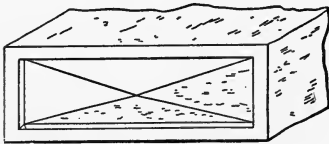

FIG. 39.—Sunk Diamond Panel.

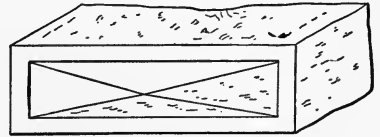

FIG. 40.—Raised Diamond Panel.

middle of the panel. In general, such panels are called diamond panels, and the one just described (Fig. 39) is called a sunk diamond panel. When the surface of the stone rises gradually from the inner lines of the margins to the middle of the panel, it is called a raised diamond panel (Fig. 40). Both kinds of finish are common on bridge-quoins and similar work. The details of this method should be given in the specifications.”

## CHAPTER II

### ARTIFICIAL BUILDING MATERIALS

#### *Brick, Lime, and Cement*

**Building Brick** is an artificial product manufactured from clay, and, when properly made, is one of the most durable and satisfactory of building materials. The use of brick is not general in engineering structures, but it is universally employed in buildings, and is a very valuable substitute for stone. Since the advent of concrete, however, the use of brick is being rapidly displaced, and, where employed, is often used only for facing the concrete construction.

**Manufacture of Building Brick.**—The manufacture of brick consists in mixing clay and water to the proper consistency, shaping the mixture by means of moulds or other methods, drying, burning, and cooling. Each step in the process has a bearing upon the quality of the product.

The *clay* used is of primary importance. Common building brick is made from the common clays, which consist principally of silicate of alumina. If iron is present in the form of oxide or carbonate, the bricks burn red, but if the iron is in the state of silicate, the bricks do not burn red (Milwaukee brick).

In *moulding* brick, the clay and water are mixed to a plastic state, and then the soft plastic material is pressed into moulds. In early days (and even now, the same process is used in small plants), the clay and water were brought to a state of plasticity by a primitive pug-mill, and the material placed in the moulds by hand. At the present time, the entire process can be performed by machinery.

The *machinery* used, while of great variety, may be divided into three classes, according to the plasticity of the clay mixture when moulded.

*Soft-mud* machines handle the clay mixed with about one-fourth of its volume of water. In the late machines, the clay is constantly being worked in a pug-mill attached to the machine, and is fed directly from the mill under the plunger which presses it into moulds. The moulds are then moved forward and struck off by hand with a special steel tool made for the purpose.

*Stiff-mud* machines handle a stiff mud which is delivered to the machine through a hopper (Fig. 41). A specially designed screw forces the clay forward through a metal die in the form of a continuous bar. This bar is pushed along to the table of a cutting machine, where it is separated by moving wires (Fig. 42) into bricks, which are then ready to be taken to the drying rooms or "dryers." If the bricks are "side cut," the cross section of the clay bar is the largest face of the brick; if "end cut," the cross section of the bar is the end face of the brick. The cutting machine shown in Fig. 42 is operated by hand. In large plants, automatic machines are used. The stiff-mud machine is used wherever the character of the clay permits.

*Dry-clay* machines use the clay with a very little moisture. The moulds are holes in a metal plate in which plungers move from below upward until flush with the top of the plate. Sufficient clay is placed above the plungers to fill the moulds, and then plungers from above move downward and force the clay into the moulds. The lower plungers move down to give the brick the proper thickness. The upper plungers now move upward and the bricks are forced up out of the moulds by the lower plungers and taken to the drying-rooms or "dryers."

**Drying Brick.**—Before the bricks are burned, they must be dried either before being placed in the kiln for burning or after they are in the kiln. In plants where little or no machinery is employed, the hand-moulded bricks are placed on the ground having a specially prepared smooth surface. The bricks are deposited flatwise and left for about six hours, or until the top surface is dry, and then they are turned on

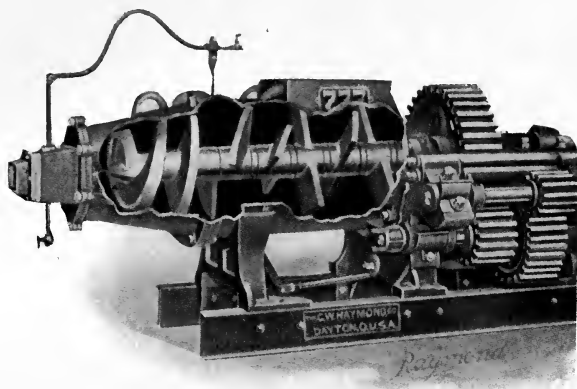

FIG. 41.—Interior of Brick Machine. (The C. W. Raymond Co.)

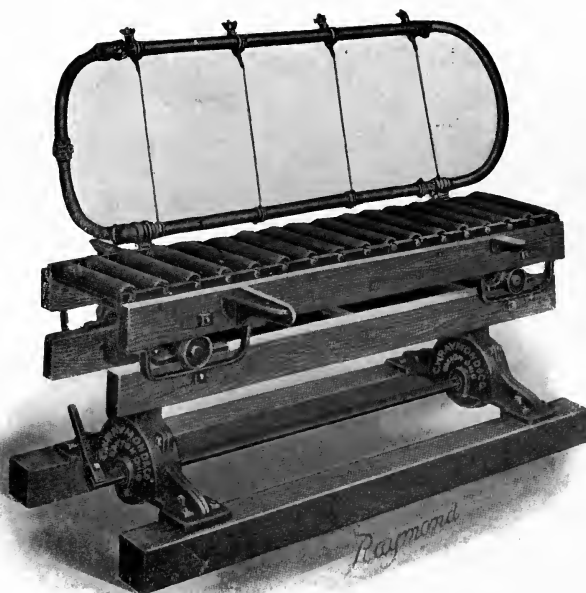

FIG. 42.—The Raymond Combination Cutting Table. "The Simplest Form of Cutter Made." (The C. W. Raymond Co.)

edge and left for several hours. When they are sufficiently hard, they are loaded into barrows and taken to drying racks which are under roof, where they remain from one to four weeks, or until enough bricks are on hand to burn.

In plants where modern machinery is employed, the bricks are set up on edge on racks which slip between uprights, forming shelves, on cars, which are then run into "dryers." The time required for drying depends upon the method of supplying heat and the character of the material used in making the bricks. For the ordinary stiff-mud brick, about twenty-four hours is sufficient to dry the brick when some of the modern "dryers" are used.

**Burning Brick.**—The operation of burning brick depends upon the clay, the form and size of the kilns, and the fuel.

In brick-yards where the bricks are moulded by hand, and which do not have permanent kilns, the burning is done in *clamp kilns*, which are constructed of the bricks to be burned. The kiln is built up in sections called "arches." Fig. 43 shows a transverse section of three arches, and Fig. 44 a longitudinal section of an "arch." Each arch is about  $3\frac{1}{2}$  feet wide, from 20 to 30 feet deep, and from 35 to 50 courses high. Each "arch" has an opening, called an "eye," at the bottom, in the center of the width running entirely through the kiln in which the fuel used in burning is placed. (The fuel is usually wood.) After the arches have been built, they are enclosed by a wall of green brick having all openings between them stopped with mud. The top is covered with bricks laid flatwise. In building the arches, there are certain arrangements of the bricks which must be followed in order to distribute the heat as uniformly as possible through the mass. The brick is first subjected to a slow fire, producing a moderate temperature, to expel the moisture, and then the temperature is gradually increased until the bricks next to the "eye" are at a white heat. This temperature is kept up until the burning is complete, and then all openings are closed and the mass allowed to cool. The process

of drying and burning takes from 6 to 15 days. The drying takes from 18 to 72 hours, depending upon the clay used.

This form of kiln is really a very simple up-draft kiln.

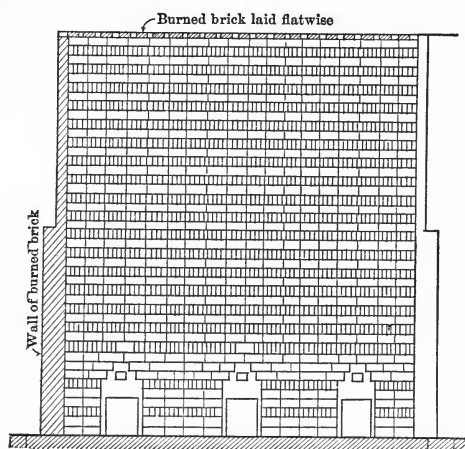

FIG. 43.—Cross-Section of Three "Arches" of a Clamp Kiln.

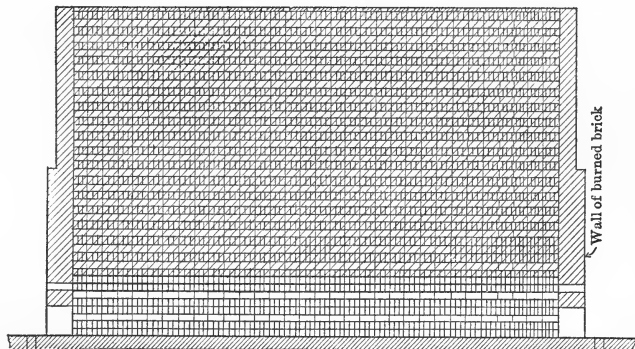

FIG. 44.—Longitudinal Section of an "Arch" of a Clamp Kiln.

Occasionally, permanent walls are built as shown in Fig. 43, but generally they are dispensed with.

**Modern Methods of Burning Brick.**—Modern methods use permanent kilns which are of various forms. They are divided in three classes: the up-draft, the down-draft, and the continuous.

The *up-draft* kiln may be either rectangular or circular in plan, and has fires at the bottom so arranged that the heat passes under and up through the floor of the kiln and thence up through the bricks to the top of the kiln, where it escapes through openings in the roof. The bricks at the bottom of the kiln receive too much heat and those at the top too little. The bricks in the center are the only bricks which receive the proper amount of heat. Under average conditions, it is seldom that 50 per cent of the bricks are No. 1 grade. As stated above, the clamp kiln, shown in Figs. 43 and 44, is an example of an up-draft kiln.

In the *down-draft* kiln, which may be either circular or rectangular in plan, the heat from the furnaces in the outside wall is led through flues to the top of the kiln, and is then drawn down through the brick and through the floor to

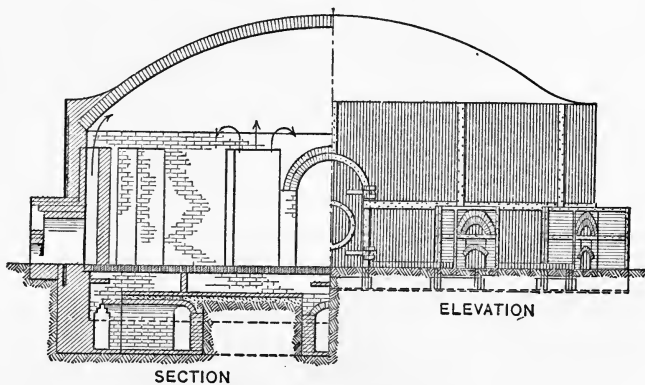

FIG. 45.—Down-Draft Kiln, Circular in Plan, Built of Brick in a Steel Shell.

ducts which lead to a stack. This form of kiln gives more brick of No. 1 grade than the up-draft kiln. Fig. 45 shows the general arrangement of a circular down-draft kiln. It is constructed of brick within a steel shell.

The **up-and-down-draft** kiln is so arranged that the heat can be made to pass up through the brick and also down through the brick. This requires two sets of furnaces, one for the up-draft and one for the down-draft. This type



of kiln burns a very uniform product. Fig. 46 shows a section of a circular kiln through the furnaces which furnish up-draft heat.

The *continuous* tunnel kiln, of the Raymond design (Figs. 47 and 48), consists of two parallel tunnels which are con-

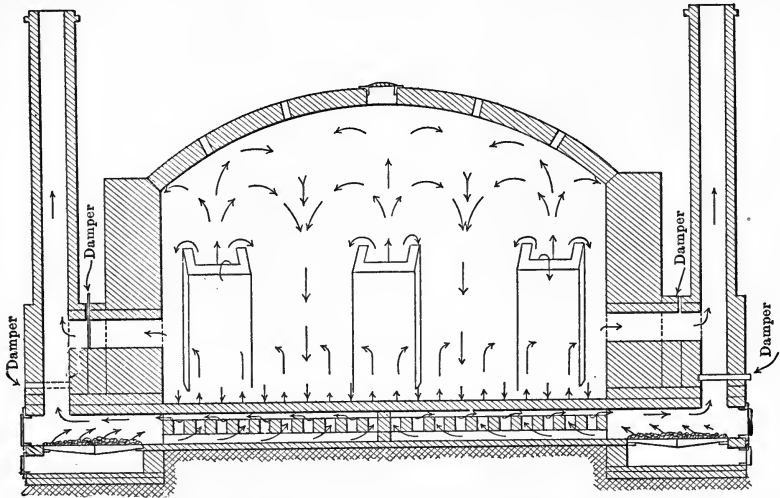

FIG. 46.—Section of a Circular Up-and-Down Draft Kiln. (Ohio Kiln Co.)

nected at the ends. Each tunnel is divided into sections by drop arches, and each section is provided with a side entrance and necessary flues. The space between the tunnels is utilized for draft and hot-air ducts. In filling a section, the deflection wall *V* is made tight of green brick up to the under side of the drop arch. Between this wall and the drop arches, the bricks are set up to form flues which connect with horizontal flues, built of the green brick, which extend the length of the chamber. Immediately in front of the drop arches a tight wall, *W*, of green brick is built, extending from the top of the horizontal flues just mentioned to the top of the chamber. The fuel used is producer gas admitted through the top of the kiln. The arrows, Fig. 48, show the route taken by the hot gases. By using the proper

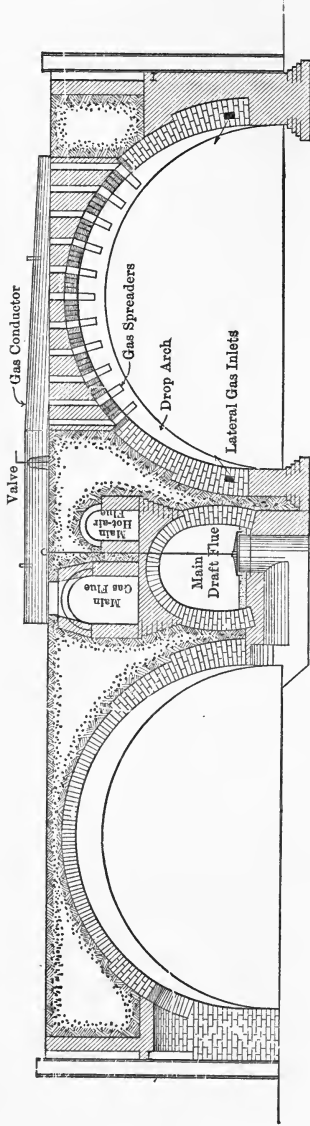

Fig. 47.—Transverse Section of Tunnel Kiln. (The C. W. Raymond Co.)

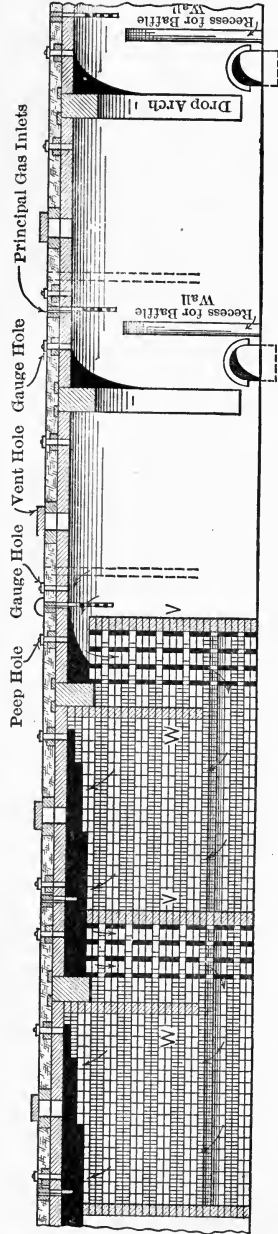

Fig. 48.—Longitudinal Section of Tunnel Kiln. (The C. W. Raymond Co.)

number of sections, the process of burning becomes continuous, as the bricks in different sections will be in various stages of the burning, from a section in which green brick is being set to one where the finished product is being taken out. The same result is obtained by properly connecting rectangular or circular down-draft kilns. Fig. 49 is a sketch showing the Schaffer "semi-continuous" kiln system, which is self-explanatory.

#### Fuel Used in Burning Brick.—

The fuel employed depends upon local conditions usually. Wood, coal, and gas may be used in any of the up- or down-draft kilns by building the proper furnaces.

#### Annealing or Cooling Brick.—

This is very important for all kinds of clay products. After the burning is completed, the fires in the furnaces are stopped and all cool currents of air excluded from the kiln. To obtain good results, the cooling should be slow, otherwise the brick will be brittle. While brick-makers are well aware of this, they claim that they cannot profitably spend the time to anneal the brick properly. Proper annealing is especially important in the manufacture of paving brick.

**Classification of Brick.**—According to the method of mould-

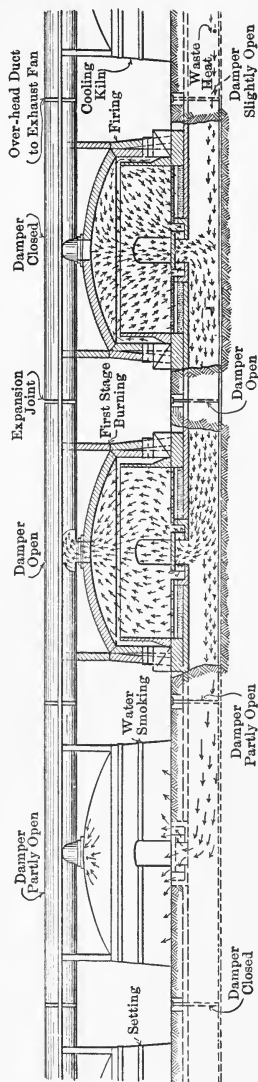

FIG. 49.—The Schaffer Semi-Continuous Kiln System. (The Schaffer Engineering and Equipment Co.)

ing, brick is classified as soft-mud brick, stiff-mud brick, pressed brick, repressed brick, slop brick, sanded brick, and machine-made brick.

*Soft-mud bricks* are moulded by hand or machinery from a soft mixture of clay and water.

*Stiff-mud bricks* are machine moulded from a stiff mixture of clay and water.

*Pressed bricks* are machine moulded from dry or nearly dry clay.

*Re-pressed bricks* are formed from soft-mud bricks and stiff-mud bricks, which have been partially dried, by subjecting them to great pressure in metal moulds. This makes them more regular in form. Formerly, it was thought that the density and strength were increased, but it is doubtful if the strength is materially changed.

*Slop bricks* are those moulded by hand, where the moulds are wet with water to prevent the clay from sticking.

*Sanded bricks* are soft-mud bricks moulded in moulds sprinkled with sand.

*Machine-made bricks* are those made by machinery, and now include all kinds of brick.

Brick is also classified according to its position in the kiln. The following classification strictly refers to the old-style clamp kiln, but where the quality is considered, it refers to any kiln.

*Arch or clinker bricks* are those which are in immediate contact with the fire. They are over-burned, hard, brittle, and twisted in shape.

*Body, cherry, or hard bricks* are those taken from the interior of the pile and are the best bricks in the kiln, or No. 1 grade. Cherry refers to the color of the product. As the color depends upon the kind of clay, cherry has no meaning for clays which do not burn red.

*Salmon, pale, or soft bricks* are those forming the exterior of the mass and, consequently, are under-burned. They are usually regular in shape but quite soft, and are only suitable

for the interior of walls. Soft bricks made from clay which burns red are salmon in color.

Depending upon their form and use, bricks are designated as compass bricks, feather-edge bricks, face bricks, sewer bricks, fire bricks, paving bricks, etc.

*Compass bricks* have one edge shorter than the other, and are used in walls with curved surfaces.

*Feather-edge bricks* have one edge thinner than the other, and are used in arches.

*Face bricks* are usually pressed or re-pressed bricks, regular in shape and size, and uniform in color, making them suitable for the outside of walls in buildings.

Fig. 50 shows a few of the many shapes in which brick is manufactured.

*Sewer bricks* are simply hard, common bricks used in the construction of sewers.

*Fire bricks* are made of pure clay and sand, and are used in places subjected to high temperatures. They are usually yellow in color.

*Paving bricks* are generally made of hard clays or shale and burned to a point a little below vitrification. For paving purposes, they are regular in shape and size, uniform in color, and tough. An inferior grade makes an excellent material for walls, piers, etc., where strength and water tightness are required.

**Essential Requirements for Good Building Brick.**—The bricks should be uniform in *size*, regular in *form*, with parallel faces and sharp corners. The structure of the bricks should be uniform and so dense that not over 12 per cent of their weight of water is absorbed.

The *crushing strength* of bricks is generally much greater than necessary, but a half-brick tested carefully between steel plates should have an ultimate crushing strength of at least 7,000 pounds per square inch (Baker).

The *modulus of rupture* of brick in cross-breaking is a fair measure of its quality, since it depends upon the toughness of the brick. Its determination is easy and quick. The

modulus for building brick should be at least 1,000 pounds per square inch (Baker).

The *absorption* test of brick is made in the manner explained for building stones. Soft brick, of little use in build-

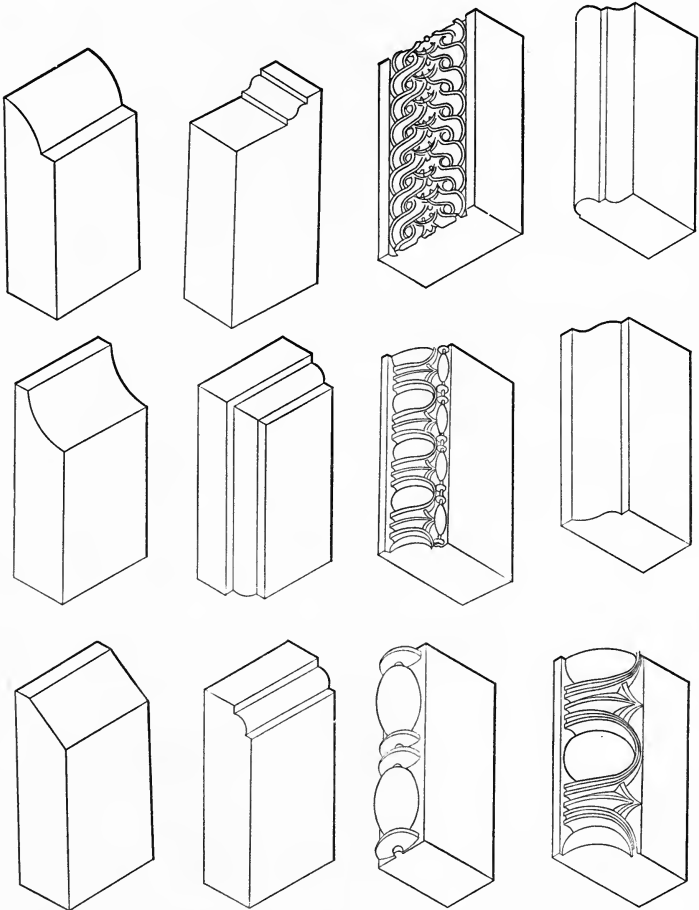

FIG. 50.—A Few Shapes in Which Building Bricks Are Made.

ings, will absorb as high as 33 per cent of its weight of water, while the best grade of paving brick absorbs less than one per cent of its weight.

**Ornamental Face Brick.**—Formerly, face bricks were simply selected brick, uniform in color and true in shape. Now, special face bricks are made with almost any color desired. Some manufacturers produce the colors by selecting the proper clay or shale and by proper burning. Others enamel the exposed faces of the bricks, and, by so doing, can obtain almost any shade wanted. Various textures are also given to the exposed faces by numerous processes. The sizes of the bricks are quite variable, and, therefore, it is advisable to purchase all brick for a particular structure from one maker. This difference in size is not always due to the use of different sizes of moulds, but to the shrinkage of the brick in drying and burning. Different clays and different methods of handling lead to bricks which have different coefficients of shrinkage.

**Sizes of Brick.**—As stated above, the sizes of brick are numerous. The following are the approximate standard sizes, in inches.

Common brick.....	$8\frac{1}{4} \times 4 \times 2\frac{1}{2}$
Paving brick.....	$8\frac{1}{2} \times 4 \times 2\frac{1}{2}$
	$9 \times 4 \times 3$
	$9 \times 5 \times 4$
Pressed brick.....	$8\frac{3}{8} \times 4 \times 2\frac{3}{8}$
Roman brick.....	$12 \times 4 \times 1\frac{1}{2}$
Norman brick.....	$12 \times 4 \times 2\frac{3}{8}$

**Sand-Lime Brick** consists of sand cemented together with lime. The lime is in the form of carbonate or silicate. When in the form of carbonate, the brick is simply lime mortar moulded, either with or without pressure, and dried in air rich in carbon dioxide. The brick is weak and of little use. When the lime is in the form of silicate, the bricks are moulded under pressure, placed in a closed cylinder, and dried under a steam pressure of from 100 to 150 pounds per square inch. Such bricks are now made which equal in quality and appearance the dry-clay bricks.

The crushing strength and the strength in cross-breaking of sand-lime brick are not as great as for clay brick, but they are sufficiently strong for all ordinary uses in buildings.

The absorption of water appears to be less than that of good clay brick.

**Cement Bricks.**—Bricks made of Portland cement and sand are quite extensively used in some localities. The bricks are machine-moulded in the shape and size of the common clay bricks. They can be made in various colors by the proper selection of cement and sand or by introducing coloring matter. The bricks are “cured” in the manner outlined for cement blocks.

**Hollow Terra-Cotta or Tile** is a clay product manufactured in an almost innumerable number of shapes and sizes, from the common rectangular blocks used in walls and partitions to elaborately carved designs used for ornamental purposes. For building purposes, the blocks have the desirable qualities of lightness and strength (see Fig. 51). For partitions, the blocks are made porous by mixing sawdust with the clay. This disappears during the burning, leaving a light and porous block having a crushing strength of a little over one-half that of the blocks in which sawdust is not used. There also is an under-burned terra-cotta which has properties between the hard-burned and the porous terra-cotta.

The color of terra-cotta depends to a great extent upon the clay used in its manufacture and the burning. Shades of red and gray are the predominating colors, although a glazed terra-cotta can be made with a surface of almost any color. Both glazed and unglazed products are used. For face-work, the terra-cotta is burned hard and has a smooth, impervious surface. Usually, this surface is not glazed. For backing, walls to be plastered, partition walls, etc., the tile blocks have corrugations to hold the plaster (Fig. 51), and both the glazed and unglazed tiles are used.

The tile is manufactured by machinery, very much in the manner employed in making wire-cut brick. The tempered clay is forced through dies, and cut off in lengths of about twelve inches by wires. The tile is burned in kilns of the same construction as those for brick.



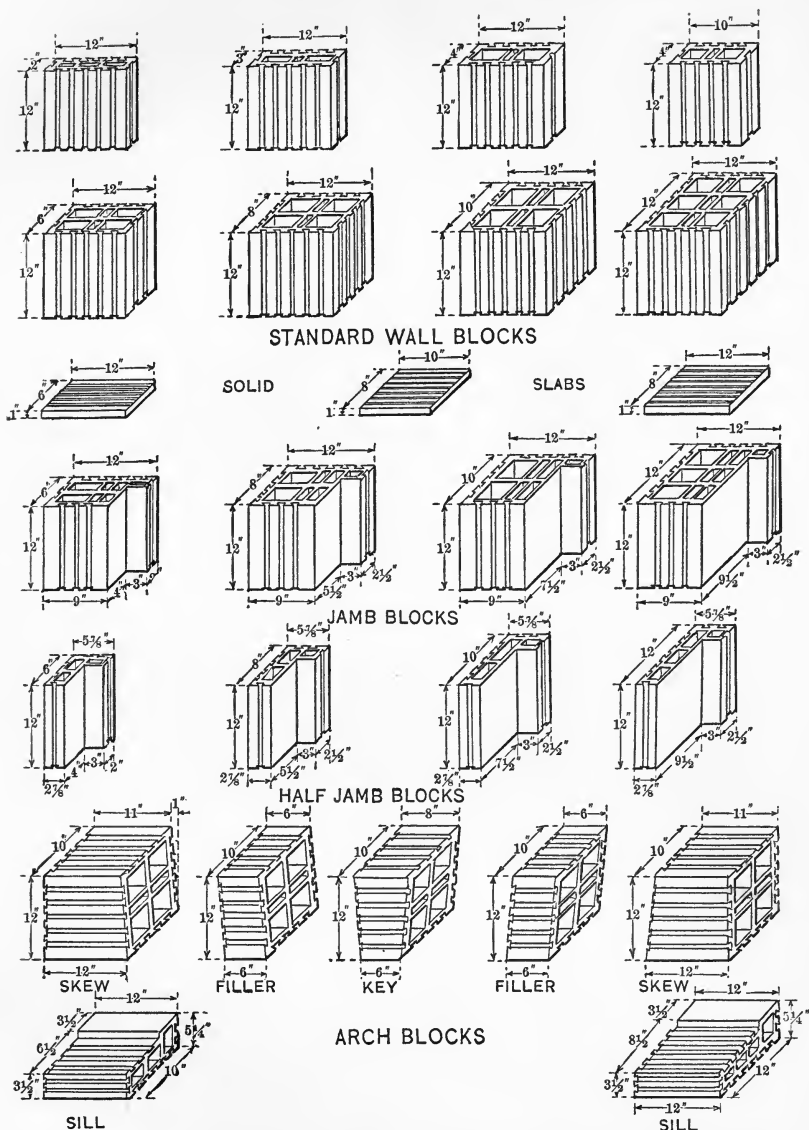

FIG. 51.—A Few Shapes and Sizes of Hollow-Tile Blocks. (National Fire-proofing Co.)

The *crushing strength* of dense terra-cotta ranges from 3,000 to 5,000 pounds per square inch, and its weight is about 120 pounds per cubic foot. The weight of hollow tile walls is from 40 to 50 pounds per cubic foot.

**Plaster Blocks.**—For partitions in buildings, a very light and serviceable hollow block is made of plaster of Paris

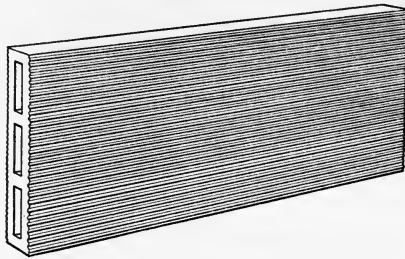

FIG. 52.—Hollow Fibered Plaster Partition Block.

combined with various materials such as cinders, asbestos, wood-chips, etc. Such blocks are cheaper than terra-cotta and are quite as good for ordinary partitions (Fig. 52).

**Fat or Quick-lime.**—If ordinary limestone is heated to a cherry red, the carbon dioxide is driven off, leaving the oxide of calcium which is called quick-lime. Since pure carbonate of lime is composed of 44 parts, by weight, of carbon dioxide and 56 parts, by weight, of oxide of calcium and with the hygroscopic moisture variable, the amount of quick-lime obtained in burning never exceeds one-half the original stone by weight.

Quick-lime has a great affinity for water, and, when water is added to it, it swells and breaks up into an impalpable powder. As the water is added there is a rapid rise in temperature and about a threefold increase in volume. Treating lime with water is called slacking, and the product is called *hydrated lime*, *fat-lime*, or *slacked lime*, and, if more water is added, it becomes *lime paste* or *putty*.

Since quick-lime will slack by absorbing moisture from the air, it cannot be stored in bulk for any great length of

time. It can, however, be kept for long periods in tightly closed vessels. Hydrated lime is now made and shipped in bags in the form of a dry powder which simply requires

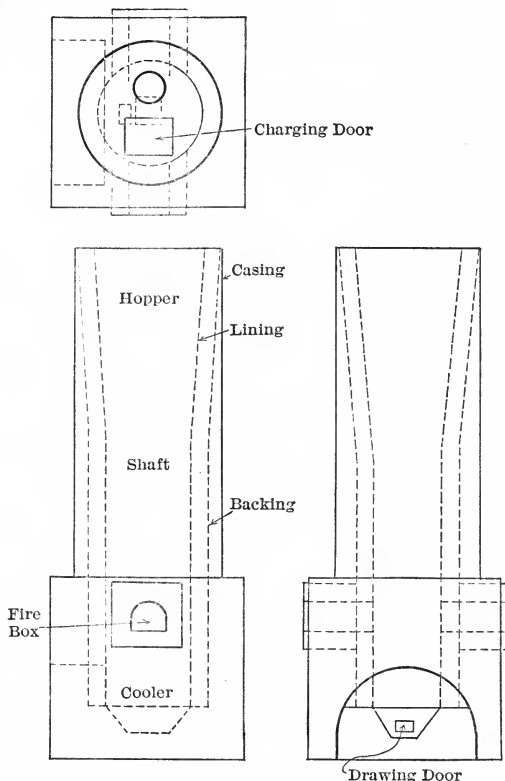

FIG. 53.—Round Kiln with Shaft Drawn In. Lime Kiln.

mixing with water when used. Hydrated lime will keep in bulk much longer than lump lime, as an impervious coating of air-slacked lime forms on the outside of the pile and protects the interior from the moisture in the air.

“In slacking, 18 parts by weight of water unite with 56 parts by weight of quick-lime, making 74 parts of calcic hydrate.” Limes which do not readily slack in cold water are called *poor*.

**Burning Lime.**—Practically all lime produced in the United States is burned in some form of kiln. The usual form is that known as the *shaft kiln* (Fig. 53). The limestone, broken into small fragments, is dumped into the top of the kiln, filling the *hopper* and *shaft*. The lime is burned in the *shaft*, and is removed through a special opening at the bottom. The stone in the hopper settles down into the shaft as the burning proceeds. The fire boxes are made to burn coal, wood, or gas, but the arrangement and dimensions vary according to the fuel used. It is generally conceded that wood fuel makes the best lime.

*Rotary kilns*, similar to those used in the manufacture of Portland cement, have been used, but as they require fine raw material the product cannot be sold as lump lime.

A very interesting and complete discussion of the "Manufacture of Lime" is given in "Technologic Papers of the Bureau of Standards," No. 16, by Warren E. Emley.

**Use of Lime.**—The principal use of lime is in making mortar for laying masonry, plastering houses, etc., where the mortar is exposed to the air. The mortar is made by combining slacked lime and sand. The sand is added since slacked lime or paste cannot be used neat because of its great shrinkage in drying.

In hardening, the lime mortar exposed to the air slowly unites with the carbon dioxide, and thereby changes a portion of the hydrated lime back to its original form. The process is slow, and takes place mostly on the exposed surfaces, the mortar inside a thick wall never becoming entirely hard.

**Natural Cement** is a "finely pulverized product resulting from the calcination of an argillaceous limestone at a temperature only sufficient to drive off the carbonic acid gas."

This powder, mixed with about 25 per cent of its weight of water, forms a combination which hardens quickly into an artificial stone which increases in strength as it ages. The powder is called *natural cement* because it is produced from the natural rock. There are numerous trade names given

to this product, usually being that of the locality in which it is manufactured.

Natural cements are rapidly being superseded by artificial mixtures, owing to their greater strength and uniformity. Natural cements vary in strength and uniformity, owing to the variability of the constituents which make up the rock from which they are manufactured.

According to the latest standard specifications, the *fineness* of natural cement shall be such that at least 90 per cent by weight passes a No. 100 sieve, and at least 60 per cent a No. 200 sieve.

The *time of setting* is important. The initial set should not take place in less than 10 minutes, and a hard set in less than 30 minutes or more than 3 hours.

The *minimum permissible tensile strength* of natural cement, as found from standard briquettes, is as follows:

## NEAT CEMENT

Age	Tensile Strength, Lbs. per Sq. In.
24 hours in moist air.....	75
7 days (1 day in moist air, 6 days in water).....	150
28 days (1 day in moist air, 27 days in water).....	250
ONE PART CEMENT, THREE PARTS STANDARD OTTAWA SAND	
7 days (1 day in moist air, 6 days in water).....	50
28 days (1 day in moist air, 27 days in water).....	125

**Portland Cement** is a "finely pulverized product resulting from the calcination to incipient fusion of an intimate mixture of properly proportioned argillaceous and calcareous materials, and to which no addition greater than 3 per cent has been made subsequent to calcination."

The principal constituents of Portland cement are 72 to 77 per cent of carbonate of lime, and 20 to 25 per cent of clay. Portland cement, when mixed with water, has the property of becoming very hard either in air or in water, and, consequently, its uses are innumerable.

The *specific gravity* of Portland cement should be at least 3.1, and its *fineness* such that at least 92 per cent by weight passes a No. 100 sieve, and at least 75 per cent the No. 200 sieve.

The *initial set* should not develop in less than 30 minutes, and a *hard set* in not less than 1 hour nor more than 10 hours.

The *minimum permissible tensile strength* of Portland cement, as found from standard briquettes, is as follows:

NEAT CEMENT		Tensile Strength, Lbs. per Sq. In.
Age		
24 hours in moist air.....		175
7 days (1 day in moist air, 6 days in water).....		500
28 days (1 day in moist air, 27 days in water).....		600
ONE PART CEMENT, THREE PARTS STANDARD OTTAWA SAND		
7 days (1 day in moist air, 6 days in water).....		200
28 days (1 day in moist air, 27 days in water).....		275

Standard specifications for cement, and methods for testing, are given in the Year Book of the American Society for Testing Materials.

**Iron-Ore Cement** is composed of limestone and iron ore, and, when ground to the fineness of Portland cement, it is slower in setting and attains greater strength. If iron-ore cement is ground much finer than Portland cement its setting is accelerated. It is claimed that mortar made with this cement is uninjured by sea water. It is principally of German manufacture.

**Magnesia Cement.**—"A mixture of magnesium oxide and magnesium chloride makes the strongest hydraulic cement known. This discovery was made in about 1853 by Sorel, a French chemist, and the cement is known as Sorel, or magnesia, cement. The magnesium oxide, or magnesia, is prepared either by calcining magnesite, a comparatively rare material, or from sea-salt. The cement is made by wetting the pulverized magnesium oxide with bittern water, the refuse of sea-side salt works, which contains magnesium chloride.

"Magnesium cement was used about 1870 to a considerable extent in making emery wheels, and, in a small way, in making artificial stone, Sorel stone; but at present it seems not to be in use, owing to its great cost, quick setting, and lack of durability" (Baker).

**Puzzolan Cement** as made in North America, or slag

cement, is "an intimate mixture obtained by finely pulverizing together granulated basic blast-furnace slag and slacked lime," *without previous calcination*. This cement is not safe for use in the open air, as it is likely to contain sulphur in the form of sulphides, which, upon exposure, change to sulphates and, in so doing, expand, and therefore this cement is liable to injure the structure. When contact with air is prevented, as in subaqueous structures or the interiors of large masses, the cement is suitable. The cement is light lilac in color, and, when rubbed between thumb and finger, the absence of grit is very noticeable. The specific gravity of slag cement ranges from 2.72 to 2.76.

**Manufacture of Portland Cement.**—Modern methods used in the manufacture of Portland cement (the general process does not differ greatly for other hydraulic cements) have so systematized the operations that the raw materials start at one end of the plant and the finished product is delivered to storage bins in a continuous process. From the storage bins, the cement is run into bags or barrels and automatically weighed.

The raw materials, consisting of limestone and clay-shale, are mixed in the proper proportions, and then ground to a very fine powder. This powder is burned in a rotary cylinder heated by a blast of air acting on oil as fuel (powdered coal is also used), the material being introduced at one end of the cylinder in a continuous stream and delivered at the other end in the form of *clinker*. The clinker is now ground to an impalpable powder, which is the cement of commerce. The method just outlined is called the dry process, and is now almost universally employed in the United States. For illustrations of the machinery used in the manufacture of cements, the student is referred to *Cements, Limes, and Plasters*, by Edwin C. Eckel.

**Sand** is an aggregation of small grains of hard rock used with lime or cement in making mortar. The grains should, in general, be composed of siliceous material. Sand is usually obtained from beds of streams, or by screening bank

or river gravel. It is also obtained from the shores of lakes, and, in some places, sea sand is used. The maximum size of the grains depends upon the use of the mortar. In masonry laid up with thin joints, fine sand is used in the mortar, while for ordinary joints exceeding  $\frac{1}{4}$  inch the sand grains all pass a  $\frac{1}{4}$ -inch screen.

Coarse sands are preferable to fine sands, as they make a stronger mortar and require less cementing material. It is generally conceded that a coarse sand having some fine material, or sand having the sizes of the grains graded, require the minimum amount of cementing materials and, consequently, are more economical than uniformly fine sands.

Sand should be clean, but 5 to 10 per cent of clay or loam, finely divided and uniformly distributed, appears to have little detrimental effect. Formerly specifications for sand called for sharp grains, but the present opinion is that the rounded grains make fully as good mortar as the sand with sharp grains. The rounded grains are much more easily coated with the cementing material. Fig. 54 shows a tubular sand and gravel washer.

**Testing Sand.**—There appears to be but one way of determining the suitability of a sand for mortar, and that is to compare the strengths of cement briquettes and blocks made with the sand with that of briquettes and blocks made with standard Ottawa sand, a natural bank sand obtained at Ottawa, Ill., and screened to size by means of a No. 20 and a No. 30 sieve. Sands which have grains of the proper size and are properly graded, and which appear to be excellent in every particular, sometimes fail to make good mortar when mixed with cement. The reason for this is not very clear, and, therefore, as stated above, a comparative test is the only safe method of procedure to determine the suitability of an untried sand.

**Gravel** is an aggregation of rock fragments worn by the action of air and water or other natural forces. In general, the fragments or pebbles will not pass a  $\frac{1}{4}$ -inch screen, but



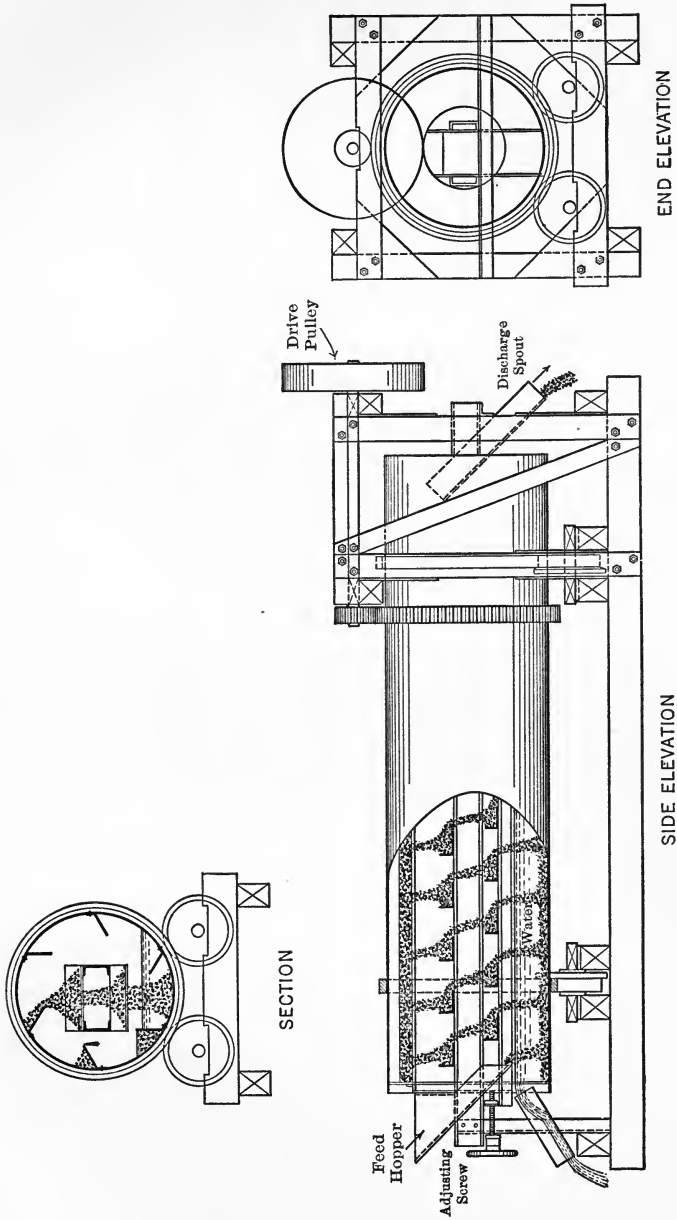

FIG. 54.—Tubular Sand and Gravel Washer. (The Raymond W. Dull Co.)

will pass a  $2\frac{1}{2}$ -inch screen. These two limits, however, are not fixed, and it is common practice to designate as gravel any aggregation of coarse and fine pebbles. The rock should be hard and, in most particulars, that which has been stated concerning sand applies equally as well to gravel.

In building operations, the principal use of gravel is in the making of concrete and "concrete blocks." The properties and use of concrete are considered in Chapter V.

**Voids in Sand and Gravel** are independent of the sizes of the grains, but dependent upon the gradation of the sizes. A mass of perfect spheres of the same size has the same proportion of voids regardless of the sizes of the spheres. The proportion of voids varies from 26 per cent for tightly packed spheres to about 48 per cent for those loosely packed.

The best sands and gravels are those where several sizes of grains are mixed. Sometimes this condition is found in "pit gravels," but, as a rule, it is necessary to grade sand and gravel to obtain the best results. This is especially true, from an economical standpoint, where cement is expensive.

The *proportion of voids* in any sand or gravel is quickly determined by weighing a known volume of the material thoroughly dried and shaken down. Taking the average specific gravity of the rock comprising the sand or gravel as 2.65, the percentage of voids equals  $100(1 - W/166)$ , where  $W$  is the weight of a cubic foot of the sand or gravel. This method is not rigidly exact, but is sufficiently so for all practical purposes.

Shaking down and drying the material decreases the percentage of voids for a given volume. A cubic foot of sand or gravel weighing 100 pounds when dry has 39.4% voids, and when it contains 8% of moisture it has 44.2% voids (Taylor and Thompson).

**Mortar.**—The quality of mortar depends upon that of its constituents, their proportions, and the method used in mixing them. Its principal use is to fill the spaces between the pieces of stone, brick, etc., in masonry, and thoroughly cement the mass together so that it will act more or less as

a monolithic structure. The Romans and Peruvians, in early times, built stone masonry without mortar by very carefully cutting the stones so that they fitted perfectly on adjacent faces. This entailed an expenditure of an enormous amount of time and labor. With the modern methods of cutting stone this can be done now, but at a prohibitive cost, in comparison with the cost of masonry laid up in mortar.

**Lime Mortar** is made by slacking lime, and mixing it with sand. The amount of sand used is variable, depending upon the size of the grains and the quality of the lime used. Probably the best guide in determining the proper amount of sand is to add sand until the mortar works well with a trowel. For thin joints, such as are required in pressed brickwork, a fine sand is used, and, where the joints are to show white, a natural or artificial white sand is employed. The maximum amount of sand used in lime mortar is about 4 parts to 1 part of lime. Lime mortar should not be used in freezing weather.

**Natural Cement Mortar** is made by thoroughly mixing one part of cement with about two parts of sand until the mass is uniform in color, and adding sufficient water to form a mortar of the desired consistency. The mortar is mixed in small batches as the cement is quick setting, and re-tempering is not permissible. The sand used depends upon the thickness of the mortar joints; thin joints requiring fine sand.

**Portland Cement Mortar** is made in the manner explained for natural cement mortar, using Portland cement. The amount of sand varies from three to five parts for one part of cement, the usual mixture being three parts sand to one part of cement. The cement and sand used in practice are quite variable, but probably a one-to-three mixture makes a mortar considerably stronger than is necessary in a great many structures. The actual strength is determined by testing standard briquettes and blocks.

**Lime Paste Used with Cement Mortar.**—Pure cement mortar is not easily handled on a trowel, and, to make it

more plastic and smooth, lime-paste is often used in the mixture. The amount of lime-paste is variable, but should not exceed one-half the volume of the mortar. The addition of the lime-paste reduces the strength of the mortar unless the amount is small; then it appears to have no appreciable effect.

**Water-Tight Mortar** used for plastering cisterns and similar structures is proportioned as follows, according to Dykeshoff as quoted by Richey.

Portland cement	1 part,	sand	1 part,	lime	0 parts.
Portland cement	1 part,	sand	2 parts,	lime	$\frac{1}{2}$ part.
Portland cement	1 part,	sand	3 parts,	lime	1 part.
Portland cement	1 part,	sand	5 parts,	lime	$1\frac{1}{2}$ parts.

**Colored Cement Mortars.**—Various substances are mixed with mortars to give them certain colors. Colored mortars are generally weaker than others, and, in the majority of cases, the colors are not permanent. Richey gives the following amounts of coloring matter for each barrel of cement. To produce

<i>Gray</i> . . . . .	use 2 pounds of Germantown lampblack.
<i>Black</i> . . . . .	use 45 pounds of manganese dioxide.
<i>Blue</i> . . . . .	use 19 pounds of ultramarine.
<i>Green</i> . . . . .	use 23 pounds of ultramarine.
<i>Red</i> . . . . .	use 22 pounds of iron oxide.
<i>Bright Red</i>	use 22 pounds of Pompeian or English red.
<i>Violet</i> . . . . .	use 22 pounds of violet oxide of iron.
<i>Yellow</i> . . . . .	use 22 pounds of yellow ochre.
<i>Brown</i> . . . . .	use 22 pounds of brown ochre.

**Pointing Mortar** is a special mortar used for protecting the joints in masonry. It is usually a very rich mixture of Portland cement and sand. Some contend that no sand should be used, but the cement be used neat.

## PART II.—MASONRY

### CHAPTER III

#### STONE MASONRY

**Masonry** may be designated as (1) stone masonry; (2) brick masonry; (3) concrete masonry; (4) mixed masonry, etc., according to the materials employed.

**Definitions.**—The following definitions of the parts of a wall are, in general, those recommended by the Committee of the American Society of Civil Engineers, referred to above,

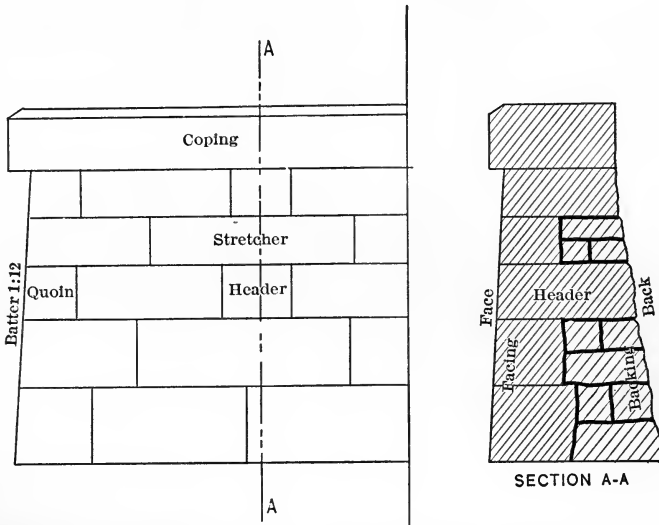

FIG. 55.—Range Masonry. Sketch Showing Arrangement and Names of Parts.

and conform to good practice, although they are not universally adopted (see Fig. 55). (Compare with definitions given in Chapter VI.)

*Back.*—The inside surface of a wall.

*Backing.*—The stones or material forming the back of a wall.

*Batter.*—The inclination of the surface of a wall, and is usually expressed as 1 : 12, 1 : 24, etc., the larger dimension being vertical.

*Bond.*—The arrangement of stones or other block materials in adjacent courses.

*Course.*—A horizontal layer of stones or other block materials in a wall.

*Coping.*—A course of heavy stones on the top of the wall to protect it. Coping stones usually project a few inches beyond the surface of the wall. Concrete is also used for copings.

*Cramps.*—Bars of metal, usually iron or steel, having their ends turned at right angles to the body of the bar. The turned ends enter holes in adjacent stones and keep them from separating (see Fig. 70).

*Dowels.*—Short bars of metal, usually iron or steel, which enter holes in adjacent stones which are one above the other (see Fig. 70).

*Face.*—The outside surface of a wall.

*Facing.*—The stones or other material which form the face, or outside, of a wall.

*Filling.*—The material between the backing and facing.

*Header.*—A stone or block which has its greatest dimension perpendicular to the face of the wall.

*Joints.*—The mortar layers between the stones or other block material. The horizontal joints are called *bed joints*, or simply *beds*, and the vertical joints are designated as *joints* or *builds*.

*Pointing.*—A special grade of mortar used in the face of joints to give better weathering qualities.

*Stretcher.*—A stone or other block material which has its greatest dimension parallel to the face of a wall.

*Quoin.*—A corner stone or block. A quoin is a header for one face of a wall and a stretcher for the other face.

*Range masonry* is the name given to masonry in which

the courses are uniform in thickness throughout their extent. Different courses may have different thicknesses, the thicker courses being at the bottom of the wall (Fig. 55).

*Broken range masonry* is that in which the courses are not continuous throughout the length of the structure (Fig. 56).

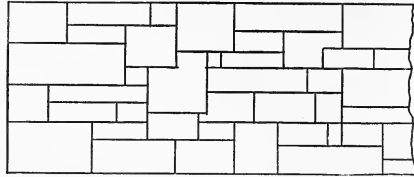

FIG. 56.—Sketch Showing Arrangement of Stone in Broken Range Masonry.

*Random masonry* is that where no attempt is made to form courses but the stones are simply cut according to the size and shape of the place they are to fit (Fig. 57).

Any of the above three terms can be used in connection with ashlar masonry and squared-stone masonry.

**Classification of Stone Masonry.**—There appears to be no classification of stone masonry which can be considered as standard. In general, the usual classifications depend upon the structure in which the stone is to be used, the nature of

the finish of the stones, the shape of the stones, the thickness of the joints, and the continuity of bed joints. (See classification in Chapter VI.)

The classification in general use, but with slightly different definitions, is: *ashlar* masonry, *squared-stone* masonry, and *rubble* masonry.

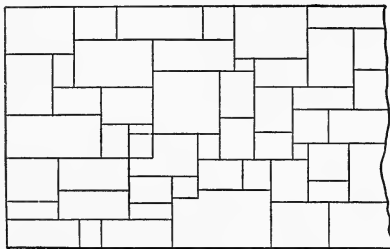

FIG. 57.—Sketch Showing Arrangement of Stone in Random Masonry.

**Ashlar Masonry**, or cut-stone masonry, is composed of stones which have their joint surfaces carefully dressed to approximate planes so that the joints do not exceed *one-half* of an inch in thickness; and which have their exposed faces finished in one of the several ways described in Chapter II.

The stones are usually rectangular on the face, but for architectural work and arches their shape depends upon their position in the structure. In the best cut-stone work, the joints do not exceed *one-eighth* of an inch in thickness. Figs. 58, 59, and 60 show three styles of ashlar masonry.

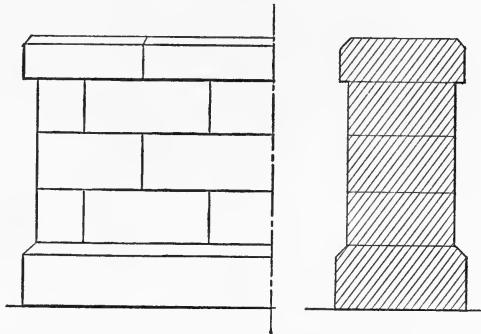

FIG. 58.—Regular Coursed Ashlar. All Stones of the Same Height.

**Dressing Joint Surfaces for Ashlar.**—The joint surfaces should be, practically, planes on the beds in order that the joints shall be uniform in thickness throughout. This in-

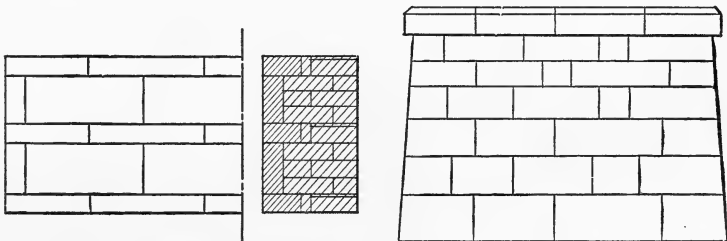

FIG. 59.—Coursed Ashlar, Using Two Sizes of Stone.

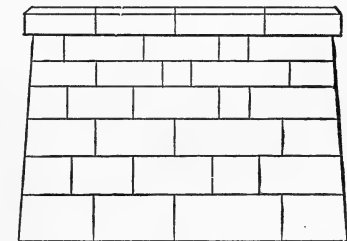

FIG. 60.—Irregular Coursed Ashlar, Courses Have Different Heights.

sures a uniform distribution of the pressure due to the loading. A slight roughness of the surfaces, such as left by tool marks, is desirable, as it increases the adhesion of the mortar. If the bed surface of a stone is concave, the edges are liable to be subjected to greater pressure than the central portion.



This condition sometimes leads to spalling on the face when the loading is heavy. If the bed surface is convex, the high portion will press through the mortar to a bearing, leaving the stone in an unstable condition until the mortar is hard. This condition usually leads to open joints on the face. The carefulness with which the bed surfaces are dressed should be governed by the nature of the structure and the position of the stone in the structure.

In all structures, the bed surfaces are dressed for the full depth of the stones. In thick walls, the vertical joint surfaces are dressed back for nine or more inches, the remainder of the surfaces being roughly dressed and permitting thicker joints. The distance back should always be stated in the specifications. The backs of the stones are not dressed, but no considerable overhang should be permitted, as it is difficult to fill the space under the overhang with the filling unless a sloppy concrete is employed.

**Backing and Filling for Ashlar.**—Only in very exceptional cases is *ashlar* masonry used throughout the body of a mass of masonry. Generally it is used only for the exposed faces, the back-

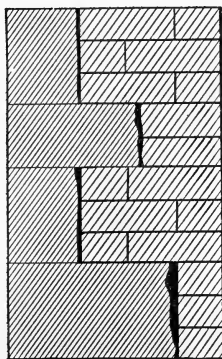

FIG. 61.—Ashlar Masonry with Brick Backing and Filling.

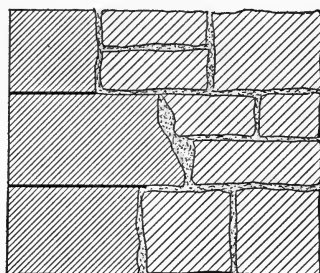

FIG. 62.—Ashlar Masonry with Rubble Backing and Filling.

ing and filling being composed of a cheaper masonry. In both architectural and engineering structures, concrete, brick, and stone are in common use for backing and filling (see Figs. 61, 62, and 63).

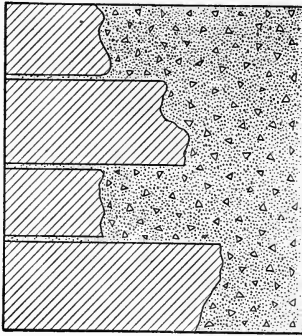

FIG. 63.—Ashlar Masonry with Concrete Backing and Filling.

In comparatively thin walls, the backing and filling are laid up to form courses equal in thickness to the face courses. This is done to permit of thoroughly bonding the face stones and the backing and filling. In large masses of masonry faced with ashlar, such as masonry dams, no attempt should be made to lay up the backing and filling in courses. In fact, it is preferable to have no bed joints extending through such structures (Fig. 64).

If the backing of a dam is of ashlar masonry, the courses need not correspond in thickness with those in the face.

**Bond.**—No two joints in adjacent courses of ashlar masonry (or any type of block masonry) should be continuous, but the stones should overlap, or

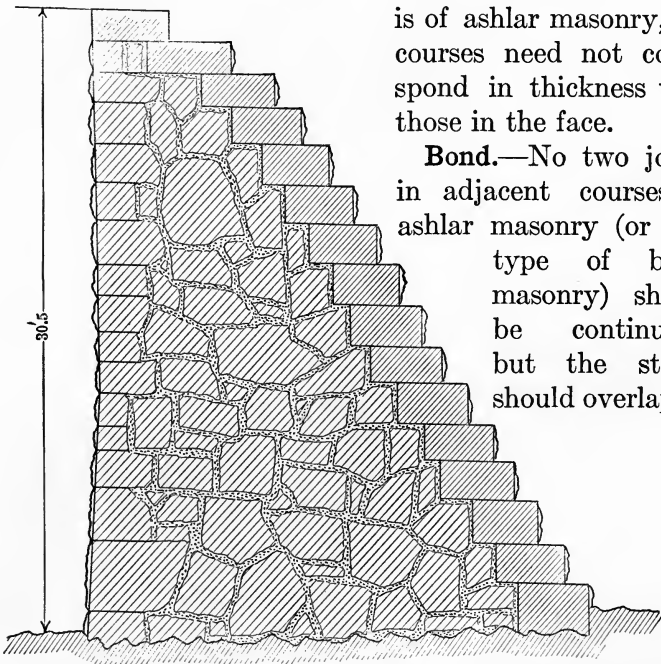

FIG. 64.—Ashlar Face Masonry and Rubble Filling without Horizontal or Vertical Joints. (Muscoot Dam. Reports on the New Croton Aqueduct, etc., 1895-1907.)

break joints. The amount of the overlap is a function of the depth of the course and the size of the stones. A common specification makes the overlap from one to one and one-half times the depth of the course. By this arrangement, each stone is supported by portions of at least two stones immediately below and supports portions of at least two stones im-

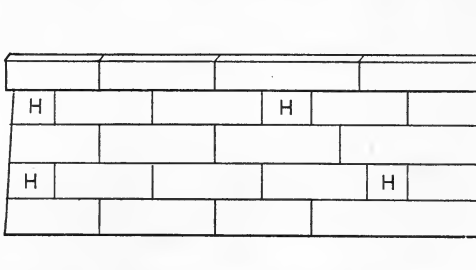

FIG. 65.—Ashlar Masonry with Few Headers.

mediately above. This statement applies only to stretchers, as no joint is permitted immediately above or below a header. The object of bonding is to bind the stones thoroughly together and distribute the pressures (Fig. 65).

The strongest bond is obtained by using an equal number

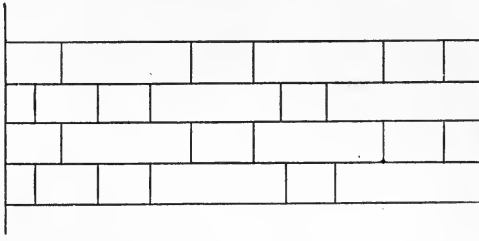

FIG. 66.—Ashlar Masonry with an Equal Number of Headers and Stretchers.

of headers and stretchers in the wall, each header in one course being in the center of a stretcher (Fig. 66) of an adjacent course. In thin walls, the headers should have a length equal to the thickness of the wall (Fig. 67). In thick walls, they should extend well into the filling (Figs. 61, 62, and 63). Headers in the back of a wall should not be opposite

headers in the face (Figs. 68 and 69). Preferably headers should be at least the size of the face for their entire length.

In the usual run of masonry from *one-third* to *one-fourth* the area of the face consists of headers.

Where masonry is subjected to heavy blows, as in the case of sea walls, lighthouses, etc., the stones are carefully cut with projections on one stone fitting depressions in adjacent stones, and iron cramps, dowels, and bolts used to tie the stone together thoroughly (see Fig. 70).

**Relative Dimensions of Stones.**—The actual dimensions of headers and stretchers are dependent upon the structure in which they are used, the kind of stone, and the facilities of the quarry from which the stone is obtained. In some structures and localities, thin stones are necessarily employed, while in others large stones are used. As a matter of strength and bond, custom and experience have specified with some variations the bed of a stretcher as not less than *one and one-fourth* times the depth of the course, and the length as not less than four feet. For headers the width of the face is specified as not less than the depth of the course and its length not less than four feet for thick walls. These specifications apply for heavy masonry.

In architectural work, such as the walls of buildings faced with ashlar, the relative sizes and bonding of the stones seldom follow the specifications given above. In buildings the ashlar facing is, sometimes, merely a veneer of thin stones set on edge. (This does not necessarily mean that the stones are not set on natural beds.) These stones are bonded to the body of the wall by metal ties unless a large number of headers are employed. This masonry is not expected to support very much load, as the body of the wall carries the floors and their loading.

**Setting Stone.**—In setting stone there are a number of things which must constantly be kept in mind. Assuming that the particular stone to be set is correctly cut for the position it is to occupy, it must be transported to the wall in a manner which does not injure it in any way. Stones

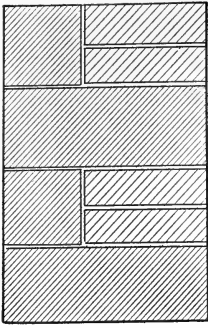

FIG. 67.—Section of Wall Showing Headers Extending from Face to Back.

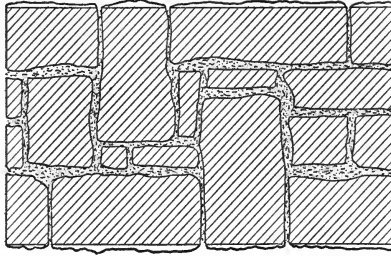

FIG. 68.—Sketch Showing Proper Arrangement of Headers.

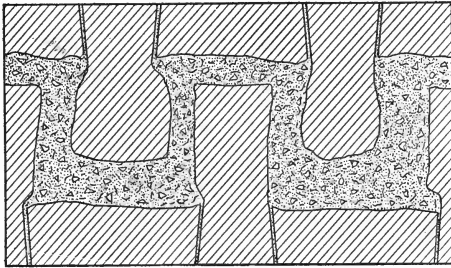

FIG. 69.—Sketch Showing Stretchers and Headers Dovetailed.

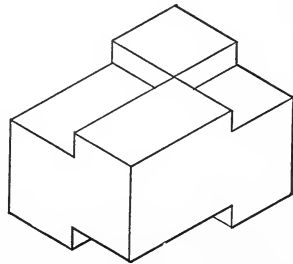
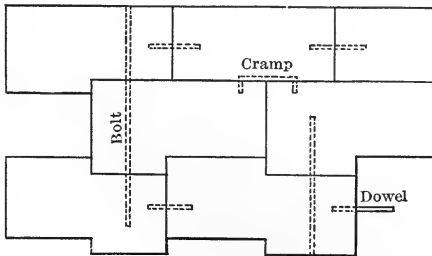

FIG. 70.—Sketch Showing Construction When Structure Is Subjected to Strong Wave Action.



FIG. 71.—Forged Steel Grab Hooks and Chain. X Varies from 7 to 10 Inches. Capacity Varies from  $2\frac{1}{2}$  to 25 Tons. (American Hoist and Derrick Co.)

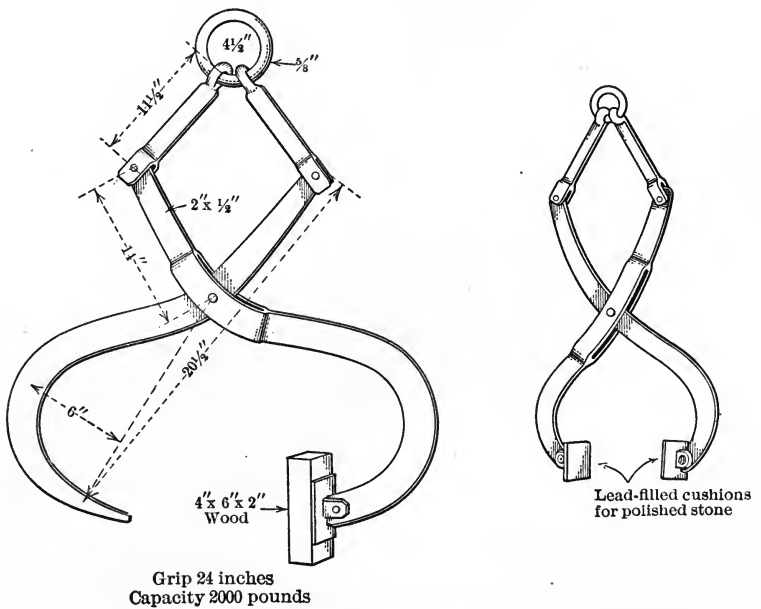

FIG. 72.—Clamps for Lifting Cut Stone.

may be lifted by derricks, the attachment to the stone being made by *grab-hooks*, *clamps*, *dowels*, or *lewis*.

*Grab-hooks* (Fig. 71) are favored by contractors, as they are quickly handled and can be used for very heavy stones. Generally, it is necessary to drill holes for the hooks which mar the face of the stone, and hence the use of grab-hooks is not permitted on good work. For the usual size stone used, the *clamp* (Fig. 72) is satisfactory. The wooden blocks bearing against the stone do not, in any way, mar the surface. *Dowels* (Fig. 74) and the *lewis* (Fig. 73) require holes in the top surface of the stone. Both are satisfactory, and have the advantage that by their use a stone can be lowered between other stones.

In setting a stone, a full bed of mortar is prepared and the stone drenched with water and lowered into place without in any way disturbing the adjacent masonry. It may be settled

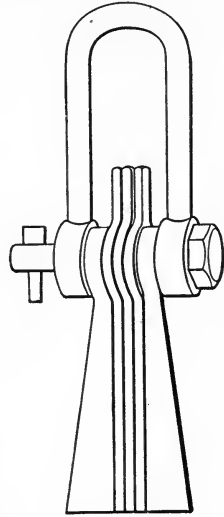

FIG. 73.—Lewis for Lifting Cut Stone.

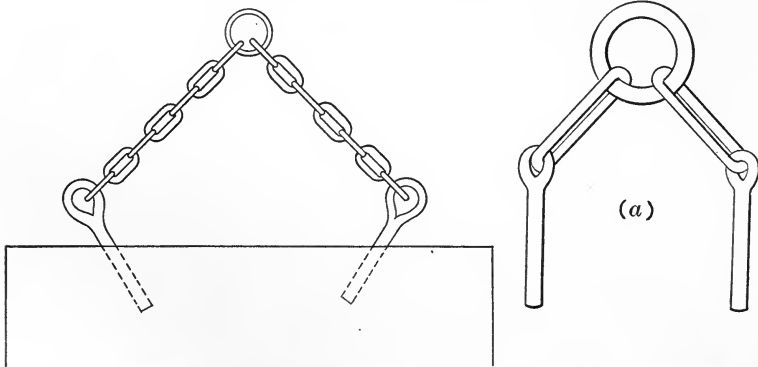

FIG. 74.—Dowels for Lifting Cut Stone. (a) Pin Lewis; Capacity, 1,000 to 6,000 Pounds.

into place by light blows with a sledge or stick of timber, but heavy blows should not be allowed. A good stone-setter seldom fails to place the stone in its proper position, as to line and elevation, as it is lowered by the derrick. Stones for the filling or backing are laid with less care. In ashlar masonry, where the joints do not exceed one-half inch, the joints must be filled with care. This is a tedious job when the stones are large, as the mortar must be tamped into place if the joint is filled. In rubble masonry, the joints are usually so large that there is little difficulty in filling them with mortar.

**Pointing.**—Regardless of the kind of mortar employed, that portion near the exposed face of the joint will be deficient in density and water-resisting qualities. To pro-

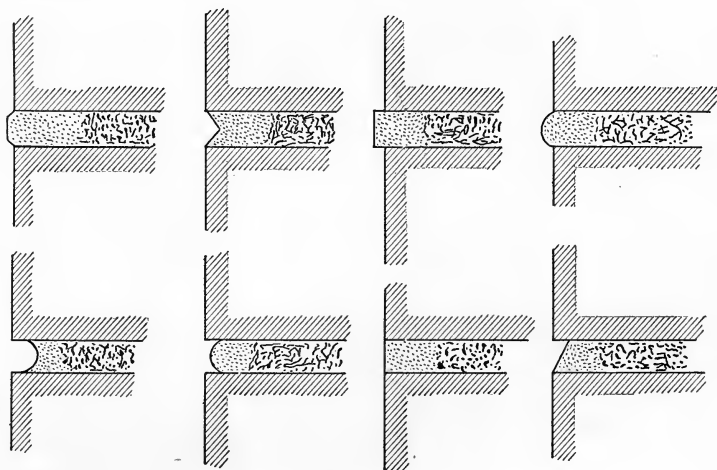

FIG. 75.—Joint Facings for Stone Masonry.

vide a complete protection of the joint, the mortar is raked out for a depth of about one inch before it has become hard. When the mortar in the joint is thoroughly set and hard, the raked-out space is filled with a special pointing mortar. This is usually composed of one part of Portland cement and one part of rather fine sand mixed with water to a very



stiff paste which can be put in place with a trowel, and tamped in with a special metal caulking tool. The face of the joint is finished to either a raised, flat, or sunken surface with a metal tool. Fig. 75 shows several forms of joint facings.

**Joint Mortar.**—The kind of mortar employed usually depends upon the character of the structure. If the masonry is subject to heavy loads and vibrations, Portland cement mortar should be used, the mixture being about one part of cement and from two to three parts of sand by measure. In architectural work, care must be exercised to select a cement which does not stain the particular kind of stone employed.

The amount of mortar required depends upon the size of the stones and the thickness of the joints. Baker states that for three-eighths to one-half inch joints and twelve to twenty inch courses there will be about two cubic feet of mortar for each cubic yard of masonry.

**Pointing Mortar.**—According to Patton, pointing mortar “should be neat cement, or at any rate not more than one sand to one cement, and before being applied should be allowed to take a set, and tempered with a little water when ready for use. Good pointing mortar of one sand and one Louisville cement was used at Point Pleasant, the mortar being mixed the night before and allowed to remain overnight, and tempered with a little water when used.”

Most engineers and architects are very much opposed to re-tempering mortar, but in the case of pointing mortar the old custom of permitting a set and then re-tempering appears to lead to good results. The re-tempering gives a consistency which permits of caulking and the working of a good finish on the face of the joint. The mortar is dense and has good weather-resisting properties. When fresh mortar is used, it is often put in place with a trowel, the only care being taken to form a good-looking face finish.

**Squared-Stone Masonry.**—The essential difference be-

tween squared-stone and ashlar masonry is in the thickness of the joints. In squared-stone masonry, the joints may be from one-half of an inch to one inch in thickness. This demands less care in dressing the joint surfaces of the stones. The faces of the stones are usually quarry-faced. It is not uncommon to find squared-stone masonry which would be classed as ashlar if the joints had been made less than one-half of an inch in thickness.

**Backing and Filling for Squared-Stone Masonry.**—The backing and filling are essentially the same as for ashlar masonry.

**Bond, Mortar, Sizes of Stones, etc., for Squared-Stone Masonry** are practically the same as for ashlar masonry. Of

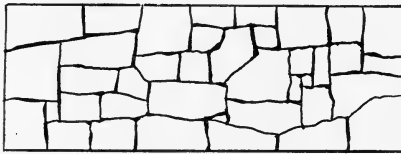

FIG. 76.—Sketch Showing Arrangement of Stones in Uncoursed Rubble.

course the thicker joints require more mortar. Baker states that one-sixth to one-fourth the mass of masonry is mortar.

**Rubble Masonry** is composed of unsquared

stones. The joint surfaces are not dressed, and the faces left as they were quarried. When no attempt is made to form courses the masonry is called *uncoursed rubble* (Fig. 76), and when the masonry is leveled at specified heights it is called *coursed rubble* (Fig. 77). Properly laid with regard to breaking joints and stability of bearing, rubble masonry is very

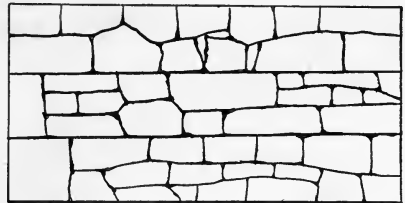

FIG. 77.—Sketch Showing Arrangement of Stones in Coursed Rubble.

durable either when laid in cement mortar or when laid dry. When mortar is employed, all joint spaces should be thoroughly filled with mortar and spalls. This makes a strong and durable wall at considerably less expense than ashlar or

squared-stone masonry. Dry rubble is generally used for walls retaining earth.

**Slope-Wall Masonry** is a thin layer of stone, or an inclined wall, placed on the slopes of embankments, excavations, river banks, etc., to protect them from the action of wind and water. (See Chapter VI.)

**Stone Paving** is used to protect the beds of streams from erosion, and is used to floor culverts and at the ends of culverts and similar structures.

**Specifications for Stone Paving.**—"Stone paving shall be made of flat stones from eight inches to fifteen inches in depth, set on edge, closely laid and well bedded in the soil, and shall present an even top surface" (Baker).

**Riprap** is stone of any shape and size placed around piers, abutments, and on the banks of streams to prevent scour. It is often dumped into place, but it is much more effective when arranged by hand.

**Strength of Stone Masonry.**—The strength of stone masonry depends upon the kind of stone, the care with which it is dressed and laid, the bond, the strength of the mortar, the thickness of the joints, etc. In general, however, the mortar is the governing feature for strength of good masonry.

As far as known, there is no record of a failure of masonry construction by crushing, but there are numerous examples where the face stones are spalled on the beds, due to the loads supported possibly, but more likely due to bad workmanship or unequal settlement. Little or nothing is known experimentally about the strength of stone masonry. Structures in existence, and which show no indications of failure, carry loads as great as *thirty tons* per square foot. (The granite columns of the Rookery Building, Chicago, Ill.)

The following may be considered as safe loads (American Civil Engineers' Pocket Book, Mansfield Merriman, Editor-in-Chief).

Rubble masonry .....	140-200	pounds per sq. in.
Squared-stone masonry.....	200-280	" " " "
Limestone Ashlar masonry.....	280-350	" " " "
Granite Ashlar masonry.....	350-400	" " " "

**Measurement of Stone Masonry.**—There are numerous rules for measuring stone masonry which usually vary in different localities. It is a safe precaution to state in the specifications how the measurements shall be made. In

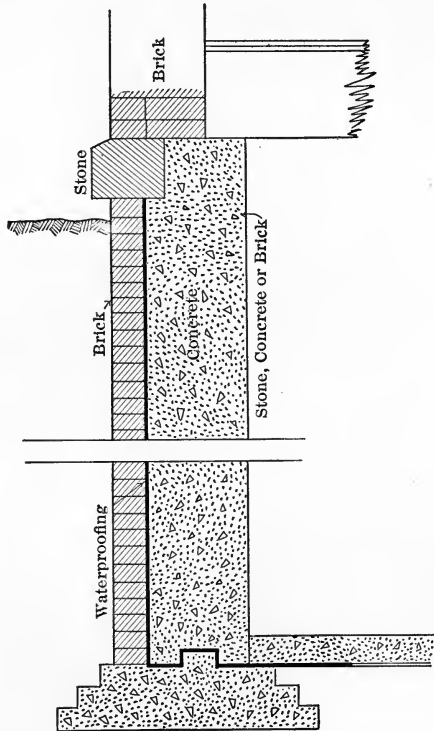

FIG. 78.—Sketch Showing Method of Waterproofing a Basement Wall.

engineering work, the actual content in cubic yards is usually taken, with an additional price per square foot of all surfaces dressed. In architectural work, it is customary to fix prices per square foot or per linear foot, according to the position occupied by the stone.

**Waterproofing Stone Masonry.**—Most of the stone in common use for masonry is practically impermeable, so that the weak part of the masonry is the joints. If good mortar is used, and all spaces between the stones are filled with mortar, no water will pass through the masonry. To make the surface of masonry impervious, all joints must be carefully pointed and all cracks carefully filled with pointing mortar, then some of the soap and alum washes described for brick masonry and concrete masonry may be used as a wash on the face.

When the back of a masonry wall is in contact with water-bearing soil it can be made impervious by the methods used for the face. Usually, however, a thin layer of felt and asphalt is used in the back, in the manner described for concrete masonry, and this protected by a layer of brick (Fig. 78).

**Cleaning Stone Masonry.**—After a piece of stone masonry has been completed, the face is often marred in appearance by little patches of mortar, dirt, etc. This is readily removed with stiff brushes and by washing with water. It is quite necessary that walls in buildings should be cleaned merely for general appearance.

In manufacturing cities, the stone-work in buildings, bridges, etc., becomes soiled from the dirt in the air which settles on the stone and is distributed in streaks by rains. For hard stones with smooth faces, this dirt can be removed with soap and water. For softer stones and irregular surfaces, a wire brush is sometimes very effective when followed with soap and water. The use of the sand blast is very efficient but somewhat expensive. For that matter, all methods of cleaning high walls are expensive, and, consequently, it is seldom that they are cleaned after the first cleaning, at the time the work is completed.

## CHAPTER IV

### BRICK AND HOLLOW-TILE MASONRY

**Brick Masonry** includes all forms of masonry composed of brick and mortar, such as walls of buildings, backing of stone or concrete masonry, sewers, tunnels, etc., and sometimes bridges, piers, and abutments.

Ordinary building brick is used above ground in walls of buildings; below ground a hard and nearly impervious brick,

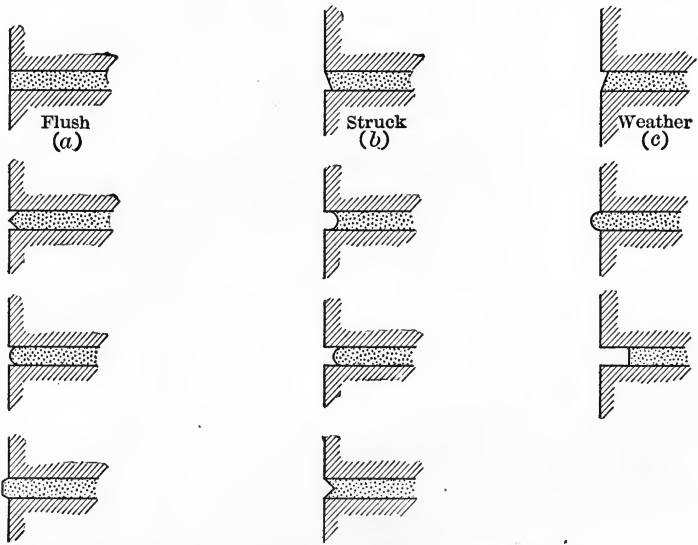

FIG. 79.—Finish of Joints in Brick Masonry. (a) Flush Joint. (b) Struck Joint. (c) Weather Joint.

such as paving brick, should be used, and this class of brick should also be employed for sewers, tunnels, bridge piers, abutments, etc.

Brick may be used simply as a facing, and some other kind of masonry used for the backing and filling, or an inferior grade of brick may be used for this purpose.

Ornamental brick-work in architectural structures is composed of special moulded brick laid in mortar. Such bricks are used only for facing (Fig. 50).

The terms header, stretcher, joint, bed, bond, etc., have the same significance in brick-work as in stone masonry.

**Joints for Brick-work.**—The joints in brick-work vary from one-eighth of an inch in thickness for pressed brick-work to three-fourths of an inch in the face brick-work of some modern buildings, the thick joint being used for architectural effect. If brick is used for the backing and filling, the joints are made from three-eighths to one-half of an inch in thickness. The thickness of the joints is adjusted so that the filling can be brought level with the facing at intervals to permit of bonding the two together (Fig. 84).

**Mortar for Brick-work.**—Formerly all brick-work was laid up in lime mortar, and even now it is extensively used in small buildings. For large buildings, basement walls, sewers, etc., cement mortar, or cement mortar containing lime paste, is employed. While natural cement mortars are used, yet Portland cement mortar is preferable.

Unless the brick used is hard and absorbs but little water, it must be thoroughly wet before it is laid, otherwise it will rob the mortar of its water.

Brick-work, properly laid with *all voids* filled with cement mortar, forms a monolithic mass which will break as readily through the bricks as along the joints.

No special pointing mortar is employed for brick-work, but the faces of the joints are formed from the mortar used in the joints as the work progresses. In some cases where raised joints are used a special mortar is employed.

**Pointing Joints of Brick-work.**—As just stated, the pointing usually comprehends shaping the mortar used in the joints to form the desired shape on the face. When the joint surface is a plane, flush with the surface of the wall, it is called a *flush joint* (Fig. 79a); when the plane surface is inclined backward and downward, forming a narrow shelf on the lower course of brick, it is called a *struck joint* (Fig. 79b); and

when the surface is inclined upward and backward it is called a *weather joint* (Fig. 79c). The first and third are preferable when weathering alone is considered, and the second when appearance is the governing quality.

Fig. 79 shows a number of styles more or less in common use.

**Bond in Brick-work.**—In ordinary work the bonding is done by making every fifth or sixth course a course of headers, and for walls more than one brick thick, care

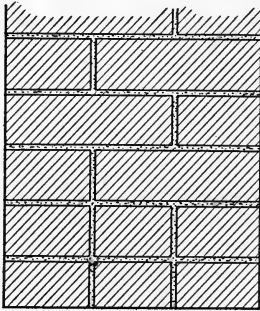

FIG. 80.—Sketch Showing Direct Bonding of Facing and Backing in Brick Masonry.

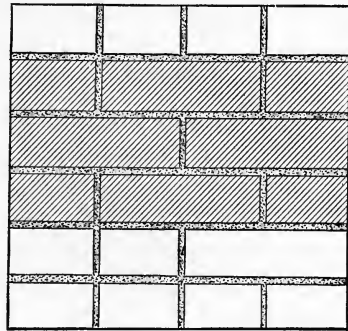

FIG. 81.—Sketch Showing Bonding of Facing and Backing Through the Filling in Brick Masonry.

should be taken that the headers of the face and back bond together either directly or through the filling, as shown in Figs. 80 and 81.

For face work where it is not desirable to have headers show, the secret bonds, shown in Figs. 82 and 83, are used. When the sizes of the bricks in the filling and the face differ, some form of metal bond is used, as shown in Fig. 84, or the filling is brought up level with the face and a secret bond employed, as shown in Fig. 85.

Fig. 86 shows the face of a wall where the ordinary arrangement of headers is used.

The bond shown in Fig. 87 is called the *Flemish bond*, where every alternate brick is a header.



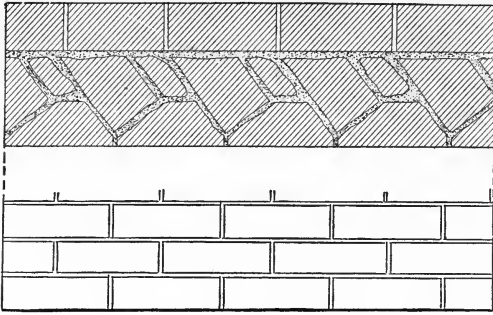

FIG. 82.—Diagonal Secret Bond in Brick Masonry.

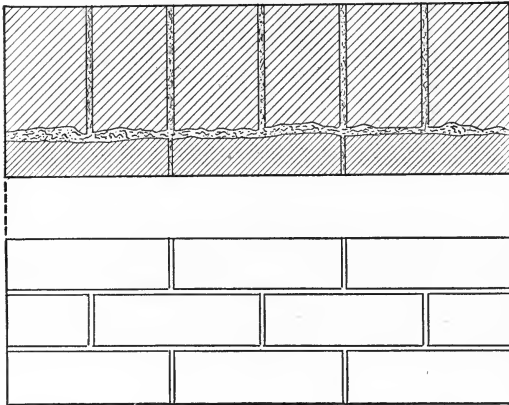

FIG. 83.—Another Type of Secret Bond in Brick Masonry.

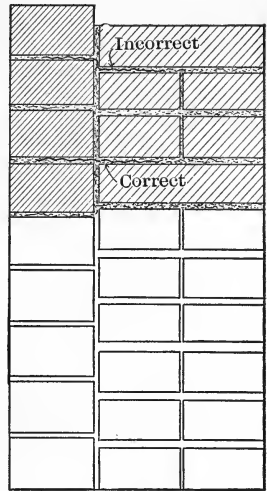

FIG. 84.—Sketch Showing Metal Tie Used to Bond Face Brick with Backing.

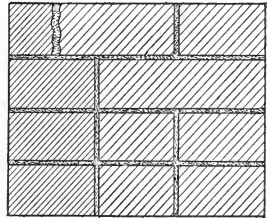

FIG. 85.—Sketch Showing Use of Secret Bond in Brick Masonry.

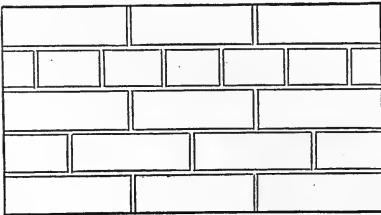

FIG. 86.—Sketch Showing Face of Brick Wall and Usual Arrangement of Headers.

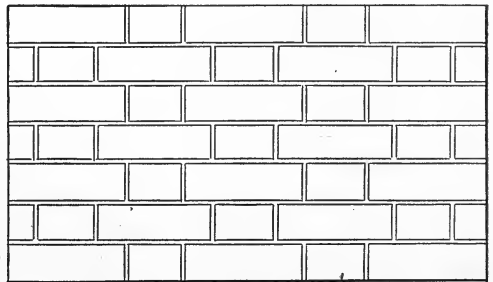

FIG. 87.—Sketch Showing Brick Wall with an Equal Number of Headers and Stretchers. Flemish Bond.

The *English bond*, where every alternate course is a header course, is illustrated in Fig. 88.

In backing up and filling behind ashlar masonry and terra-cotta it is important that there is a proper bond between

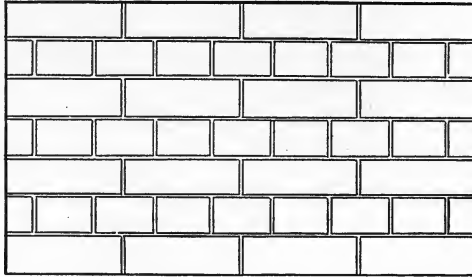

FIG. 88.—Sketch Showing Arrangement of Headers and Stretchers in a Brick Wall. English Bond.

the backing or filling brick and the face. The proper arrangement is shown in Fig. 61.

Sometimes the facing is made of uniform thickness for the full height of the wall, and metal ties used to form the bond.

*Arches*, in brick-work, which do not show are usually built of a series of header courses with the bricks laid on edge.

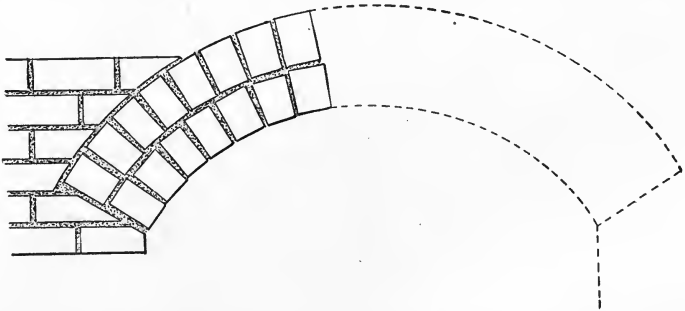

FIG. 89.—Sketch Showing Method of Arranging Common Brick in an Arch. "Row-Lock" Arch.

Such arches are called *row-lock* arches (Fig. 89). In face work the brick should be either ground to shape or especially moulded (Fig. 90).

**Crushing Strength of Brick-work.**—As in the case of stone masonry, the crushing strength of brick masonry depends upon the materials and workmanship, the mortar usually being the governing feature in good work. A number of experiments on brick columns have been made on the United

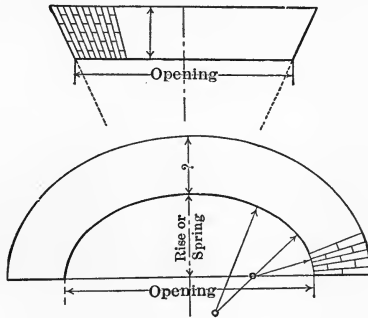

FIG. 90.—Sketch Showing the Use of Special Arch Brick.

States testing machine at Watertown, Mass., and published in the Reports of the Tests of Metals, etc., which show that the mortar is the governing factor. The brick piers were 12 inches square and 8 feet high, and the crushing strengths varied from a few hundred pounds per square inch for common brick laid in lime mortar to nearly 5,000 pounds per square inch for hard brick laid in neat cement.

The following safe compressive strengths for brick-work are given in the American Civil Engineers' Pocket Book, Mansfield Merriman, Editor-in-Chief.

COMMON BRICK HAVING A COMPRESSIVE STRENGTH OF 1,800 POUNDS PER SQUARE INCH

When laid in Portland cement mortar.....	175 lbs. per sq. in.
When laid in natural cement mortar.....	150 " " "
When laid in lime and cement mortar.....	125 " " "
When laid in lime mortar.....	100 " " "

SELECT HARD COMMON BRICK HAVING A COMPRESSIVE STRENGTH OF 2,500 POUNDS PER SQUARE INCH

When laid in 1 : 3 Portland cement mortar . . . . .	200 lbs. per sq. in.
When laid in 1 Portland cement, 1 lime paste, and 3 of sand mortar.....	175 " " "
Paving brick laid in 1 : 3 Portland cement mortar..	350 " " "

**Lintels Supporting Brick Masonry.**—The actual load on a lintel is very uncertain. If the masonry is considered to act as a fluid, then the load is the weight of all of the masonry above the lintel, including such loads as may be transmitted to the wall from floors, etc. While this assumption is on the side of safety, it undoubtedly leads to lintels very much heavier than necessary. The more usual assumption is to consider the weight of a triangle of masonry which has for its base the span of the lintel and its side making an angle of  $45^{\circ}$  to  $60^{\circ}$  with the base. This assumption may also be questioned, but for ordinary openings it is usually safe.

**Efflorescence.**—The white efflorescence often seen on the face of brick walls is usually due to water which dissolves the salts of soda, potash, magnesia, etc., contained in the lime or cement mortar. Sometimes the efflorescence appears on brick which has been burned with coal containing sulphur, or made from clay containing iron pyrites. When such bricks get wet, the water dissolves the sulphates of lime and magnesia, and, as the water evaporates, crystals of the salts are left on the surface of the brick. The principal objection to efflorescence is the appearance. It can be prevented by making the face of the wall water-proof. Sylvester's washes have given good results. "The process consists in using two washes or solutions for covering the surface of the walls—one composed of Castile soap and water, and one of alum and water—the proportions are three-fourths of a pound of soap to one gallon of water, and one-half pound of alum to four gallons of water; both solutions to be perfectly dissolved in water before using. The walls should be perfectly dry, and the temperature of the air not below  $50^{\circ}$  F. when the compositions are used.

"The first soap wash should be laid on when fairly hot, with a flat brush, taking care not to form a froth on the brick-work. This wash should remain 24 hours so as to become dry and hard before the second, or alum, wash is applied, which should be done in the same manner as the first. The temperature of this wash, when applied, may

be 60° or 70° F.; and this also should remain 24 hours before a second coat of soap-wash is put on. Then coats are applied alternately until the walls are made impervious to water. The alum and soap thus combined form an insoluble compound, filling the pores of the masonry, and entirely preventing the water from entering the wall."

Since most of the efflorescence is due to the mortar, a large portion of it may be prevented by using impervious mortar.

The Sylvester washes have been successfully used for water-proofing walls under ground and reservoir walls.

**Measuring Brick Masonry.**—In figuring the cost of brickwork, it is customary to base the estimate on the cost per thousand brick in the wall. The cost of laying different forms of masonry is provided for in the method of measurement.

In plain walls, no deductions for openings of less than 80 square feet in area are made, and when deductions are made for larger openings the width is taken as two feet less than the actual width of the opening. Hollow walls are measured as if solid. Footings are measured in the wall by adding the width of the projections to the height of the wall. Flues in chimneys are measured solid. Detached chimneys, etc., are measured as a wall having a length equal to the sum of one side and two ends, and a thickness equal to the width of the chimney (Kidder).

**Water-proofing Brick Masonry.**—All brick masonry which is in a damp location should be built of impervious brick, with good Portland cement mortar filling all voids. Such masonry will be "water-tight." If impervious brick cannot be used, then surface of the masonry may be treated with some of the washes described for concrete masonry, or a water-proof layer of asphalt and felt may be used in the same manner as for concrete masonry. Basement walls are often plastered with Portland cement mortar on the outside, but unless this is well done it is not very satisfactory.

**Cleaning Brick Masonry.**—As in the case of stone masonry,

all new work must be cleaned, and, for brick-work, stiff scrub brushes and water do the work very well. This is assuming that the face brick are hard. Mortar sometimes sticks to soft brick and requires a metal tool to remove it.

Enamelled brick can be cleaned with caustic soda or sodium carbonate, which does not have any effect upon the

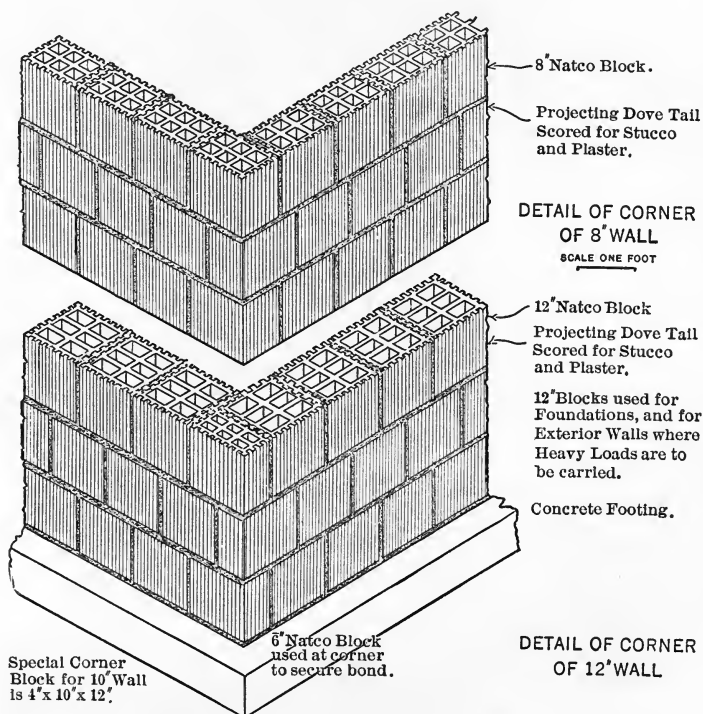

FIG. 91.—Detail of Foundation and Exterior Wall Construction. Exterior to be Finished with Stucco and Interior Plastered. (National Fire-proofing Co.)

brick or cement and lime mortar. Sulphuric, nitric, and hydrochloric acids do not affect enamelled brick, but do, even when diluted, affect both lime and cement mortar.

**Hollow-Tile Masonry** is composed of hollow blocks laid

in cement mortar. The masonry may be used for backing only, or it may form the entire wall. The blocks are laid

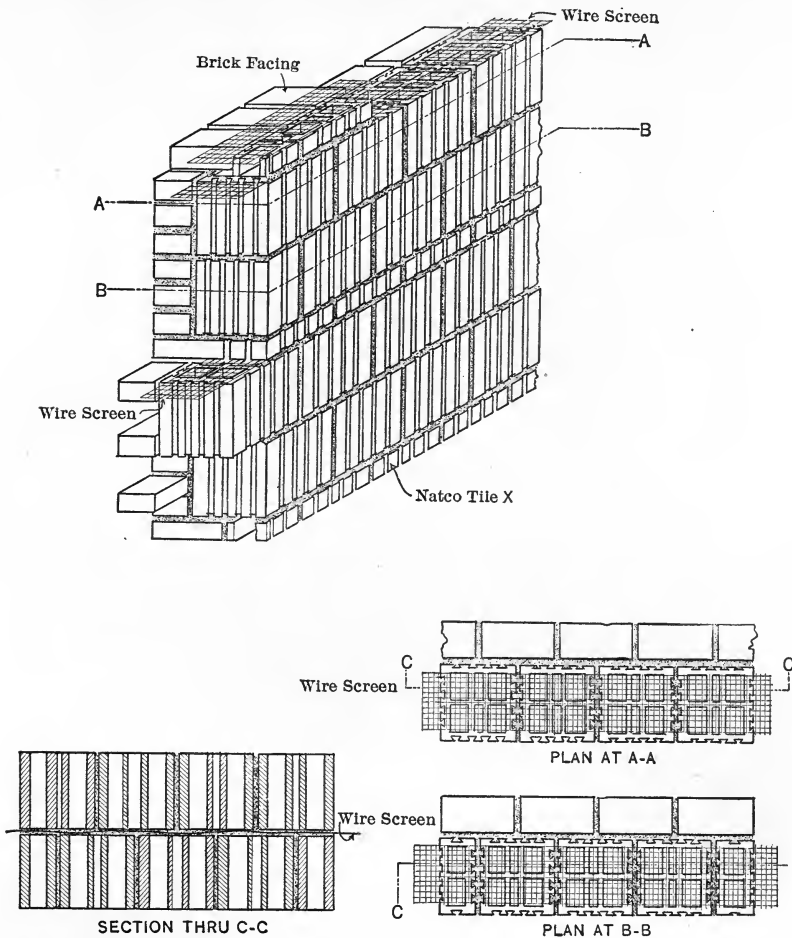

FIG. 92.—Section of Exterior Wall with Brick Facing and Hollow-Tile Backing. Showing Method of Bonding and Sealing Vertical Holes. (National Fireproofing Co.)

with the openings horizontal, and also with the openings vertical. When the openings are vertical, wire mesh is laid in the horizontal joints to hold the mortar in place. The

mortar is composed of one part cement, and two parts sand. Lime paste not exceeding ten per cent of the mass by volume may be used in the mortar. Figs. 91, 92, and 93 show a few details of hollow-block and terra-cotta construction.

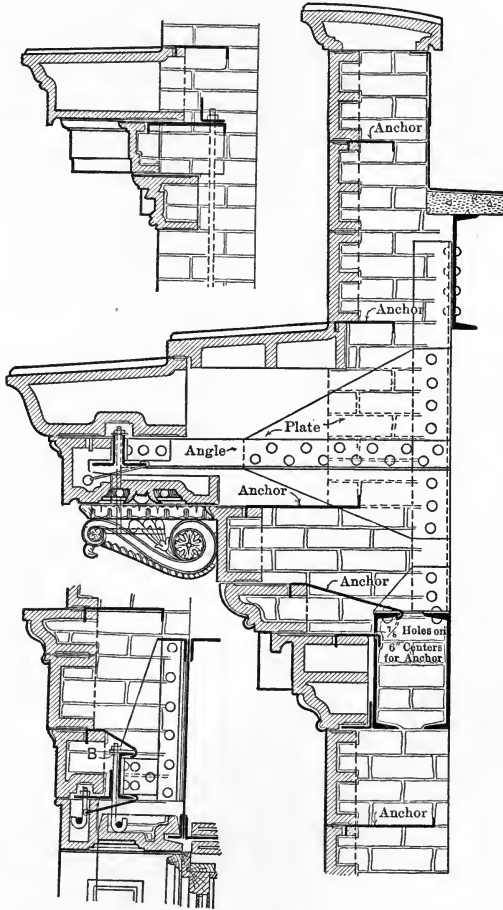

FIG. 93.—Details of Terra-Cotta Construction as Used in Steel Skeleton Buildings.



## CHAPTER V

### CONCRETE MASONRY

**Concrete** used in masonry construction is "a compact mass of broken stone, gravel, or other suitable material assembled together with cement mortar, and allowed to harden," thereby making an artificial stone. Concrete is being substituted for brick and stone in all classes of structures. Sometimes it is cast in the shape required and laid the same as stone masonry, and sometimes forms are built and the structure cast as a whole. Both methods have their advocates for many different classes of structures. At the present time, the casting of concrete in the place it is to occupy appears to be more in favor than the casting of small units which are afterward assembled. In many cases, the nature of the structure will govern the method used. For example, concrete which is to be subjected to the action of sea water must be allowed to harden before coming in contact with the salt water. If it is not feasible to construct a water-tight form in which to cast the concrete structure, then it must be cast in parts in the open air and the parts deposited in the sea water when they have become hard. Balustrades composed of rails and balusters are more economically cast in parts on account of the expensive moulds required.

**Reinforced Concrete** is concrete strengthened by the introduction of metal, usually in the form of woven wire mesh, expanded sheet metal, or metal rods. Reinforced concrete construction and design are considered in special works upon the subject, and, consequently, such constructions will not be treated here, except in a very limited way.

**Reinforcing Concrete for Shrinkage, etc.**—In order to prevent cracks in long walls, which are due to the shrinkage of the concrete in hardening, changes of temperature, and

slight settlements, longitudinal reinforcement composed, usually, of iron or steel rods is introduced. This reinforcement should be placed two or three inches from the exposed surfaces of the structure to resist cracks due to changes of temperature, but for preventing cracks produced by shrinkage it should be uniformly distributed over the cross-section of the concrete. If no settlement occurs, there will be no cracks due to settlement, and, consequently, no reinforcement will be required. The above conditions make the determination of the amount and the arrangement of the reinforcement quite uncertain. Some contend that from 0.1 to 0.2 per cent of the area of the concrete section, in steel, is sufficient to prevent cracks in long walls, while others believe that from 0.2 to 0.4 per cent of steel is necessary to prevent large cracks due to shrinkage and changes of temperature. The reinforcement should be in small units and placed near the surface of the concrete, with more reinforcement near the exposed surfaces than near those protected.

When no reinforcement is used, vertical joints are made every 25 or 30 feet to permit of slight changes of position of the blocks between the joints. To prevent lateral movements, the joints are usually made so that projections on the blocks enter recesses in the adjacent blocks.

**Constituents of Concrete.**—Concrete, as generally understood in building, is composed of Portland cement, sand, and broken stone. Gravel is often substituted for broken stone, and, when bank gravel contains the proper amount of sand, it is used as it comes from the bank.

In order to obtain the most economical concrete, the sand and broken stone or gravel should be screened to various sizes and then mixed so that the voids will be a minimum. This insures a uniform mixture requiring a minimum amount of cement and water. The coarse and fine aggregates should be clean, and the water free from dirt or any impurities which will have any deleterious action upon the cement or the aggregates.

**Proportions of Materials for Concrete.**—The materials

are usually proportioned by measure, using the cubic foot as a unit. That is, a 1 : 2 : 4 mixture means one part of cement, two parts of fine aggregate (sand), and four parts of coarse aggregate (broken stone or gravel) by measure. One bag of Portland cement, weighing not less than 94 pounds, is considered as one cubic foot of cement. The materials, including the water, should be measured separately and then combined.

The proportions of constituents for concrete depend upon the class of structure in which it is used. The following proportions are approximately those in common use.

For structures where mass is of more importance than strength, such as the interiors of abutments and piers for arch bridges, the interiors of large piers for bridges, etc., 1 : 3 : 6 to 1 : 4 : 8.

For piers, abutments, massive reinforced concrete work, etc., 1 : 2.5 : 5 to 1 : 3 : 6.

For thin-walled structures and impermeable concrete, 1 : 2 : 4 to 1 : 2.5 : 4.5.

For extra strong reinforced concrete, 1 : 1 : 2 to 1 : 1.5 : 3.

In all cases, enough water is added to make the mixture of the proper consistency.

**Mixing Concrete.**—Concrete may be mixed by hand or by machine. As far as quality is concerned, either method is satisfactory when the work is properly done. The materials must be thoroughly mixed so as to form a homogeneous mass. In hand mixing, the dry materials are mixed on a wooden platform until the mass is uniform in color, and then the water is added and the mass turned until it is of a uniform consistency. In machine mixing, the dry materials are placed in the drum of the machine, and water added as the drum revolves.

There is considerable difference of opinion as to the proper consistency of concrete. Considering the practical side of the question, a consistency of a fairly thin cream appears to lead to the best results. This consistency permits of easy handling, and the concrete readily flows into all parts of the

moulds or forms, and, if agitated near the surface of the forms, the outside surface of the concrete will be free from holes. For small pieces, and where the number of pieces of the same pattern is large, a relatively dry mix is used, in order that the moulds may be almost immediately removed and used over again.

**Machines for Mixing Concrete.**—Machines for mixing concrete are of many patterns and capacities, from the small

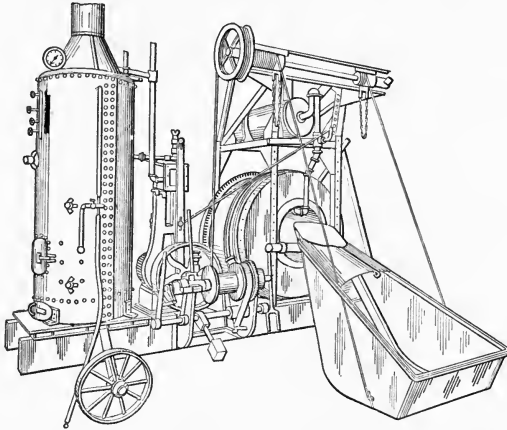

FIG. 94.—Ransome Concrete Mixer. (Ransome Concrete Machinery Co.)

mixer turned by hand and fed with shovels to the mixers operated by power which measure all of the materials and deliver the finished product in a continuous stream. In general, mixers may be divided into two classes, batch mixers, and continuous mixers. Continuous mixers are not approved by most engineers, owing to the difficulty in obtaining a homogeneous concrete by their use.

Batch mixers deliver a certain amount of concrete at intervals, and all operations are under control at all times. The modern forms consist of a movable skip, into which the measured ingredients are dumped, the skip is then elevated and the contents dumped into a drum which is kept constantly revolving. The proper amount of water is intro-

duced into the drum, and, when the mixing has progressed to the proper point, the drum is tilted and the concrete discharged into wheel-barrows, skips on cars, or other devices for transporting the concrete to its final destination. The movable skip and the revolving drum are operated by either

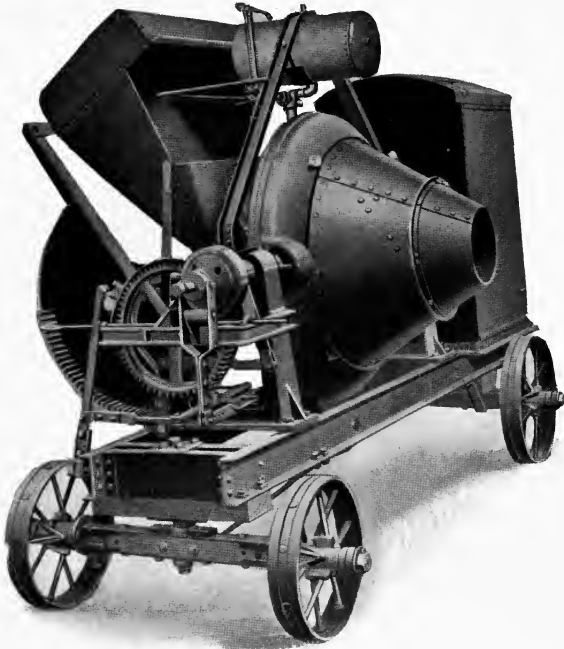

FIG. 95.—No. 104 Smith "Mascot" Mixer on Truck with Gasoline Engine, Power Charger, and Water-Tank. Skip in Discharging Position. (The T. L. Smith Co.)

a steam, gasoline, or oil engine. In case the drum of the machine does not tilt, a gate is opened for the discharge of the batch. Fig. 94 shows a non-tilting type, and Fig. 95 one where the drum tilts.

**Concrete Building Blocks** are moulded pieces of concrete, usually of the hollow-block type, having rectangular faces and walls from two to three inches thick. The size is such that they can be handled by one man. The finish of the

face is made to imitate any of the cut finishes on natural stone, but, as ordinarily executed, the imitation is quite evident, and therefore not pleasing. In exceptional cases, the faces are so well finished by hand that a close examination is necessary to detect the counterfeit, but such finishes are expensive and are seldom employed.

Practically all concrete building blocks are moulded by machines, and, in order that the block may be removed

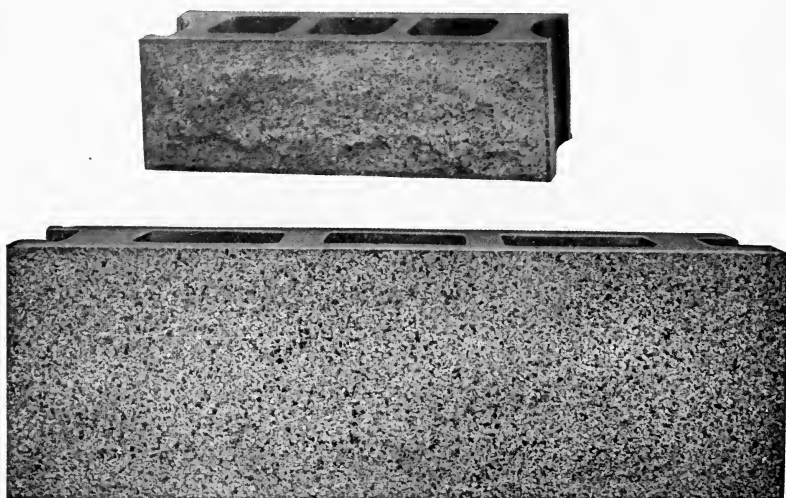

FIG. 96.—Concrete Block 8 x 8 x 24 Inch Granite Faced. Zagelmeyer Process.  
(Zagelmeyer Cast Stone Block Machine Co.)

from the machine as soon as formed, a minimum amount of water is used, often less than necessary for the complete setting of the cement; consequently, the blocks are quite porous and absorb moisture readily. Sometimes the face is formed from a thin layer of rich mortar which is backed with a lean mixture. This decreases the porosity of the face and makes a more durable block.

Dry casting can be employed, and excellent blocks made, if, after the blocks are removed from the moulds, they are

kept in a saturated atmosphere for 24 hours or longer, and then kept wet with water for a few days.

To secure good results, good materials properly proportioned must be used. There are thousands of concrete blocks being made and used which should be condemned owing to



FIG. 97.—Showing a Number of Different Face Patterns for Concrete Blocks.

the use of poor aggregates and not enough cement. Such blocks are very porous and absorb large amounts of water, making damp walls. The blocks are also lacking in strength and durability.

Various natural stones are imitated in color and structure by embedding in the face small clean chips of the stone to be imitated. The best results are obtained when the face is a plane surface. While quarry-face appears to be the universal finish for concrete blocks, it is almost impossible to get a satisfactory appearance from moulding. Figs. 93, 96, and 97 show a common shape for concrete blocks, and Fig. 98 shows another form in a wall.

**Architectural Concrete.**—By using the proper materials and moulds, and exercising care and judgment in their use, “stone concrete” can be cast in any form desired, from blocks to be laid as ashlar masonry to columns and their capitals. In fact, entire buildings of classic design have been constructed entirely of concrete, and, unless examined closely,

they have all characteristics and appearance of buildings constructed of cut stone. Such buildings, however, are exceptions. The usual construction is so poorly finished

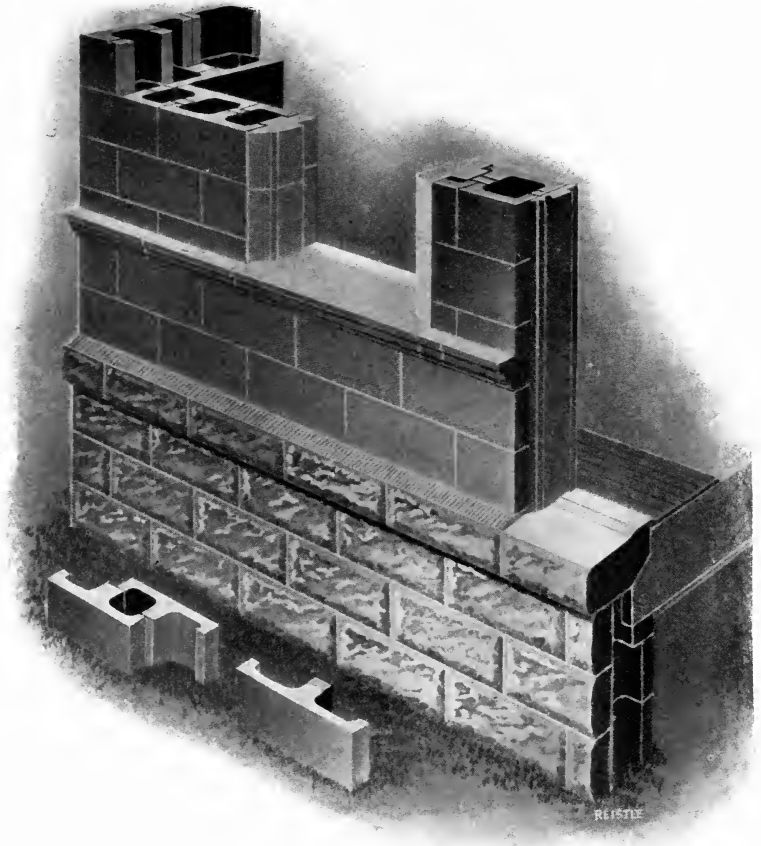

FIG. 98.—Showing Wall Constructed of Concrete Blocks. (American Hydraulic Stone Co. Barron and Harridge.)

that it has none of the characteristics of natural stone work. It is much better practice not to attempt the imitation of cut stone, unless well done, and simply let the structure show that it is made of concrete. This is accomplished by



having all surfaces planes, whether the walls are made of blocks or cast in place.

The moulds used in casting architectural concrete are made of wood, plaster of Paris, sand, or metal. Sand and metal moulds give very good results where a large number of pieces of simple patterns are to be cast.

**Surface Finish for Concrete Blocks.**—If the face of the block is made of 1 : 2 mixture of cement and limestone screenings, and it is finished by placing the block face down on a revolving metal disk covered with wet lake sand (or any clean hard and fine sand), the result will be a plane surface, smooth and uniform in appearance. This is not an expensive operation, and the excellent appearance of the blocks when laid in a wall is ample return for the expense. Of course, any rock other than limestone can be used.

A rock-face finish of natural stone can be made by first placing about a half-inch of sand over the bottom of a mould and then arranging spalls of natural stone on the sand, pressing each piece to a firm bed; then enough mortar (mixed wet) consisting of equal parts of sand and cement is poured over the spalls until they are covered, and then the body of the block is poured of the usual concrete mixture. The blocks are left in the moulds 24 hours. When properly done, the spall-face blocks are a great improvement over the usual cast rock-face.

The Zagelmeyer block (Fig. 96) is faced with very small pieces of natural rock (a coarse sand made by crushing the rock). This sand is bedded in glue on the face plate of the machine and then backed up with mortar and concrete. The moisture in the mortar softens the glue so that the block, when removed from the machine, carries the natural stone sand embedded in the mortar.

**Monolithic and Mass Concrete.**—When an entire structure is composed of concrete cast in place without joints it may be called monolithic concrete. If there are occasional joints to provide for contraction, expansion, etc., it may be called mass concrete. Nearly every structure which can be built

of stone or brick can be made of mass concrete. This includes buildings, footings for walls, bridge piers and abut-

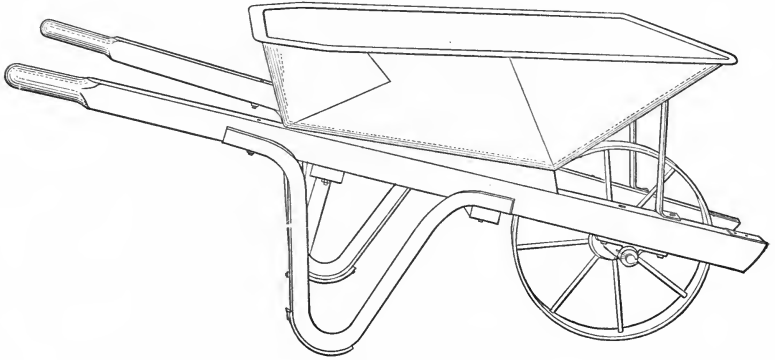

FIG. 99.—Ransome Steel Tray Barrow. Capacity, 3 Cubic Feet.

ments, water towers, reservoirs, dams, tunnel linings, sewers, arch bridges, etc.

Forms are so constructed that the concrete is cast in the exact shape desired.

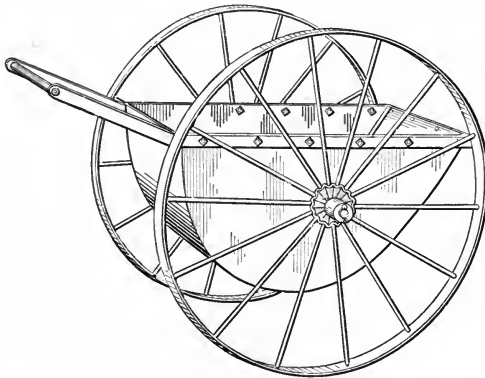

FIG. 100.—Ransome 6 Cubic Feet Capacity Concrete Cart.

**Depositing Concrete in Mass Construction.**—Concrete is deposited in a great many different ways, depending upon the magnitude of the work and the plant available. In small work, it is usually taken in wheel-barrows or special

carts (see Figs. 99 and 100) from the place of mixing to the forms where it is to be deposited, and dumped into the forms. Care must be taken to see that the coarse aggregate does not separate from the mortar. This is a function of the consistency and height of fall. If wheel-barrows are not

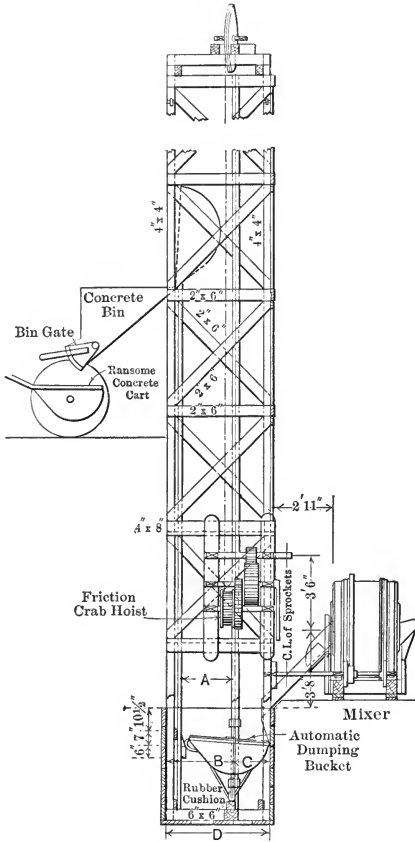

FIG. 101.—“Ransome” Plant for Mixing and Hoisting Concrete.

used, the mixing platform or the machine is moved as the work progresses, the concrete being shoveled directly into the forms from the mixing platform or as discharged from the machine.

For large buildings, walls, bridges, etc., the mixing plant is usually stationary, and the concrete is taken to its destination by first elevating it in a bucket in a tower (Figs. 101 and 102), and then dumping it into carts or troughs or chutes

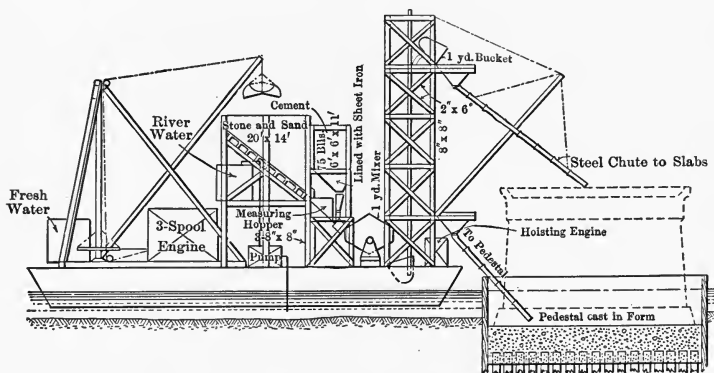

FIG. 102.—Floating Mixer Plant Delivering Concrete Through Chutes. Gunpowder River Bridge. (*Engineering Record*, May 2, 1914.)

of wood or metal leading to the place where it is to be deposited. The troughs are changed as the work progresses. Here, again, the question of consistency is important. The usual consistency is too thin in order that the concrete will flow readily in the troughs. Unless the consistency is right, and the inclinations of the troughs are carefully considered, the mortar and coarse aggregate are quite likely to separate, and must be re-mixed in the forms by "spading."

For bridge piers, the concrete is often mixed on land and transported in buckets on small cars running on rails supported by a light trestle, to the pier being built, where the bucket is lifted by a derrick and swung and lowered to the place where the concrete is to be deposited

**Mixing and Depositing Concrete by Compressed Air.**—This method has many advantages over the usual methods, especially when the concrete is to be transported long distances and the place where it is to be deposited is not easily accessible with buckets or chutes. The apparatus consists

of a pneumatic mixer (Fig. 103) and pipe for transportation. The mixer is a conical drum with a feeding hopper on top and a delivery elbow at the bottom. Pipes for compressed air are provided, one at the top of the machine and one at the heel of the delivery elbow. The concrete aggregates,



FIG. 103.—The Pneumatic Concrete Mixer. (Concrete Mixing & Placing Co.)

cement, and water are passed into the machine through the hopper at the top, which is then closed by a door operated by compressed air (the closing air cylinder is shown in Fig. 103). Air is admitted above the charge, which forces it downward into the elbow at the bottom where air, admitted at the heel of the elbow, assists in forcing the concrete

through the delivery pipe. The mixing of the materials takes place during the time it is moving forward under the action of air at not less than 80 pounds pressure. For the usual size broken stone or gravel used in mass concrete, an eight-inch delivery pipe is used. The mixers are made in

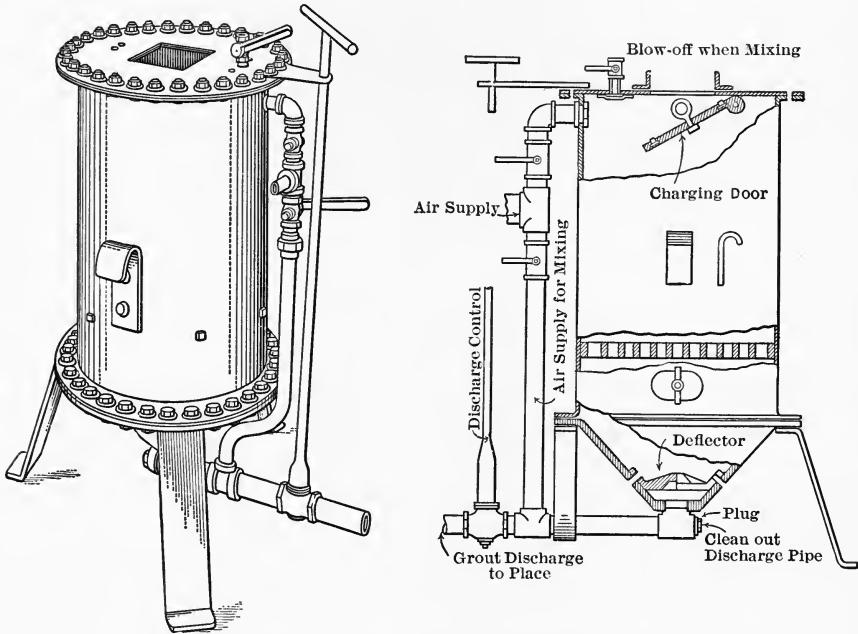

FIG. 104.—Ransome-Cannif Grout Mixer. (Ransome Concrete Machinery Co.)

one-quarter and one-half yard sizes and will deliver about 30 and 60 yards of concrete per hour.

**Mixing and Depositing Grout by Compressed Air.**—Small spaces back of tunnel linings, fissures in rock, etc., can be completely filled with grout composed of one part cement and one part sand by the Ransome-Cannif grout mixer. The construction of this mixer is shown in Fig. 104. The cement and sand are delivered to the mixer through the charging door, with the proper amount of water. The materials are mixed by permitting compressed air to enter at the bottom

of the mixer and blow through the mass, the blow-off valve at the top being open. When the grout is thoroughly mixed, the blow-off valve is closed and the air supply diverted to the top of the machine. This forces the grout into the distributing pipe and to its destination. When two or more mixers are used in a battery, it is possible to keep up a continuous flow of grout through a two-inch pipe. A battery of three mixers, working under an air pressure of 300 pounds, has delivered a batch of grout every 30 seconds for 24 hours a day for several months, without a stop.

#### **Mixing and Depositing Concrete in Freezing Weather.—**

Unless it is absolutely necessary, it is better not to mix and deposit concrete in freezing weather. If the work must be executed in such weather, then the aggregates and the water must be heated before being mixed. Since the chemical action of the setting of cement-paste produces a rise in temperature, if the warm concrete is deposited in forms it will become sufficiently hard before its temperature falls to that of freezing, to prevent any injury from freezing, especially if the top surface is protected with straw or other means after concreting has been stopped.

Sometimes salt is dissolved in the mixing water, the percentage depending upon the temperature. (See Chapter VI.)

The water is usually heated by turning steam into the water barrel or tank. The sand and broken stone may be heated by piling it over an old boiler shell in which a fire is kept burning, or steam may be turned into the pile through several pipes.

The following instructions should be carefully adhered to in doing work in freezing weather.

Do not use too much salt, as it affects the ultimate strength of the concrete.

See that the aggregates are uniformly heated and that they contain no lumps.

See that the forms are absolutely free from ice.

Deposit each batch of concrete as soon as it is mixed, and

do not let its temperature be less than 50° F. when it reaches the forms.

Do not remove the forms until the concrete has been carefully examined.

In the case of building construction, the work may be enclosed with canvas on the sides and top, and salamanders placed beneath the new work.

**Depositing Concrete Under Water.**—While it is possible to place concrete in running water, yet the results are far from certain. Unless a coffer-dam is very expensive, it is

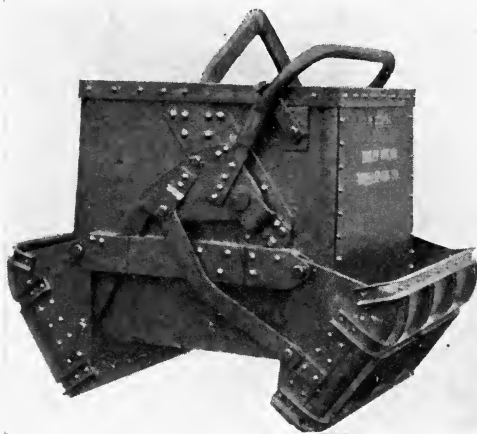

FIG. 105.—Bottom Dump Bucket. Capacity, in Cubic Feet, 15 to 75. (Insley Manufacturing Co.)

better to construct such a dam and place the concrete in still water. In case a metal or wooden dam cannot be built, a wall of concrete in sacks may be employed as a substitute.\* The concrete is made rich and not too wet, and is placed in gunny sacks, filling the sack about two-thirds full. The sacks are then lowered and placed by a diver who arranges

---

\* For methods employed in constructing coffer-dams, see Foundations: A Short Text-book on Ordinary Foundations, including a Brief Description of the Methods Used for Difficult Foundations. By Malverd A. Howe. John Wiley & Sons, Inc., New York.



them so as to form a well-bonded wall. Each sack is firmly pressed into place. The sacks are sufficiently loose in structure so that considerable mortar oozes through them, thereby cementing the units into one mass. Paper sacks have been used, but the gunny sacks are very much to be preferred. When the wall has reached a sufficient height to insure still

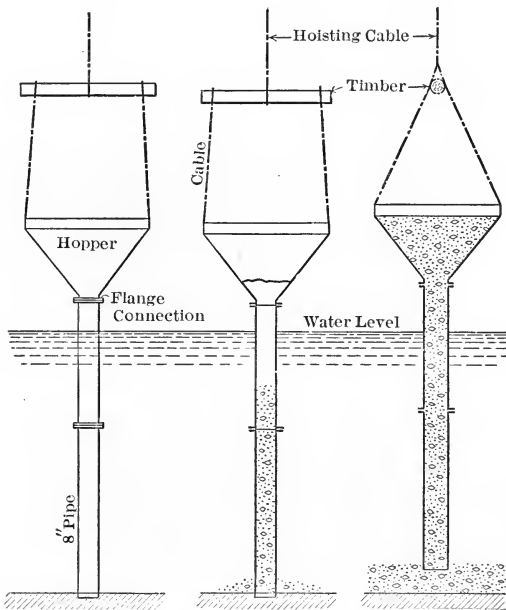

FIG. 106.—Tremie Empty, Sealed, and Ready to be Raised. (*Engineering Record*, August 15, 1914.)

water within its perimeter the concrete is deposited either by means of a drop-bottom bucket or a tremie. When a drop-bottom bucket (Fig. 105) is used, it should be lowered as far as possible and permit the opening of the bottom so that the concrete will be washed as little as possible.

A tremie (Fig. 106) is preferable to the drop-bottom bucket. This is simply a tube of wood or metal with a hopper at the top through which the concrete is passed. The tremie is usually suspended by a cable so that it can be raised and

lowered and also moved horizontally. To use the tremie, it is first lowered until the bottom is sealed, and then the water inside the tremie is displaced by concrete. When the tremie is full of concrete, it is raised a little to permit the concrete to run out at the bottom, displacing the water, and not passing through it. Concrete is placed in the hopper as fast as it runs out of the bottom. When the concrete stops flowing

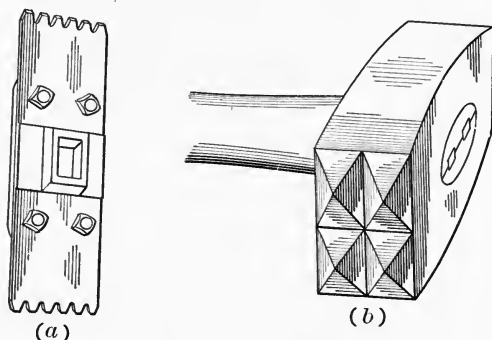

FIG. 107.—Tools for Finishing Concrete Surfaces. (a) Ransome Concrete Axe. (b) Bush Hammer with Four Points.

the tremie is moved a little horizontally, permitting the concrete to flow again. In this way layers of constant elevation are put in place. The thickness of a layer which can be successfully deposited depends upon the consistency of the concrete and the rate at which concrete can be supplied to the tremie. Thin layers are easier to manage than thick layers. The concrete should be quite wet so that it will spread laterally after leaving the bottom of the tremie. The top surface of each layer should be horizontal and free from holes. Properly managed, concrete deposited in still water through a tremie is as good as that deposited in the dry.

**Finishing the Surface of Concrete.**—In mass construction and, sometimes, in block work, the surface of the concrete is given an additional finish from that left by the forms. The marks left by the forms can be fairly well and easily removed by rubbing the surface with a brick of carborundum,

emery, concrete, or soft natural stone, if the forms are removed before the concrete becomes too hard. The surface may be given a similar finish by rubbing it with a wooden float, and using sand and water to cut the concrete.

**Bush-Hammer Surface Finish.**—The surfaces of mass concrete, walls of buildings, concrete blocks, etc., can be finished with the bush hammer operated by hand or by a pneumatic hammer. Fig. 107 shows two hand tools which have been successfully used. When the bush hammer is to be used, the concrete should stand at least three weeks after being deposited and several weeks longer if possible, as the harder the concrete becomes the better will be the surface produced. Various styles and weights of hammers are used. The hammer with four points, shown in Fig. 107, weighs three pounds, and the points are two-thirds of an inch apart. Any of the pneumatic tools used for dressing natural stone can be used on concrete, judgment being exercised in selecting the tool suitable for the age and texture of the concrete.

There are no objections to the use of bush hammers on concrete, provided the concrete is fairly rich. The hammer removes the mortar on the surface which decreases the imperviousness of lean mixtures.

**Spaded Finish for Concrete Surfaces.**—In mass concrete, if the forms are carefully built so as to have a smooth and even surface, the concrete can be "spaded"

against them so as to give a finished surface requiring no further treatment. Fig. 108 shows two tools used in "spading."

**Brushed Concrete Surfaces.**—To obtain a brushed finish, the forms must be removed as soon as can be done safely and the surface brushed with a wire brush or an ordinary

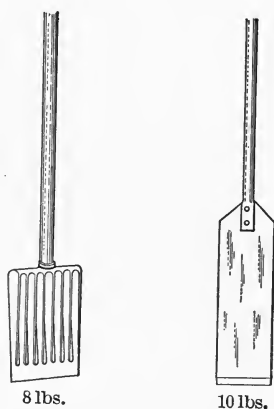

FIG. 108.—Ransome Tamper.

scrubbing brush, using water freely. The wire brush which gives satisfactory results is about four inches wide and is made by clamping together a sufficient number of sheets of wire cloth. After the surface has been brushed, the appearance can be greatly improved by washing it with a diluted

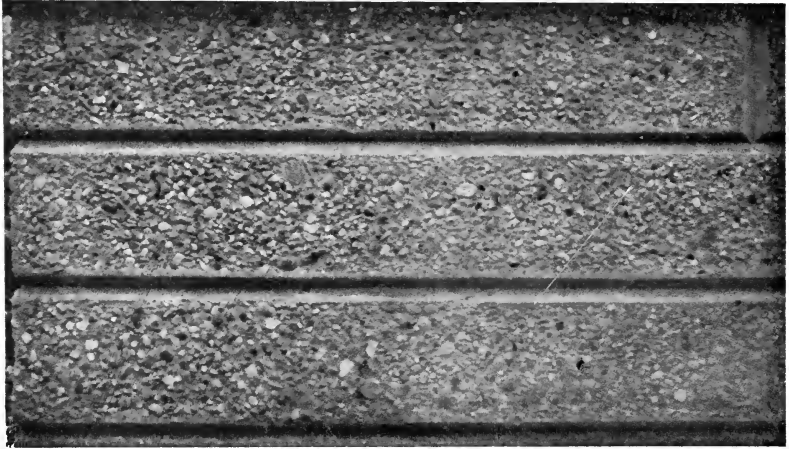

FIG. 109.—Brushed Concrete Surface. Foundation Indiana Tuberculosis Hospital. (Concrete Surfaces, Universal Portland Cement Co.)

solution of acid applied with a brush. While the surface is wet with the acid wash, it should be immediately scrubbed with a brush, and then the acid removed with water freely applied. The acid cleans the aggregate (Fig. 109).

“A solution of one part commercial muriatic acid to two or three parts of clean water should be used on surfaces in which standard Portland cement is used and a sulphuric-acid solution of the same strength when white Portland cement and white aggregates are used in the facing mixture.” (Universal Portland Cement Company.)

**Plaster Coats** are not as a rule very satisfactory, as they almost invariably crack unless in a locality where there is little change in temperature and moisture. The surface of the concrete, in all cases, must be thoroughly cleaned before

the plaster coat of mortar is applied, and the coat should be given only enough troweling to give an even surface.

**Sand-Blasted Surfaces.**—"A finish very much the same texture and appearance as that obtained by brushing while green may be obtained by sand-blasting a thoroughly hardened concrete surface. Any pronounced ridges or irregularities in surface, formed by cracks or open joints in the forms, should be removed by tooling, and any pointing that may be necessary should be done several days before the surface is sand-blasted.

"Upon a smooth, dense, thoroughly hardened concrete surface a three-eighth inch nozzle may be used, but under ordinary conditions one-quarter-inch or even one-eighth-inch nozzles have been found to give the best results. A clean, sharp, thoroughly dried silica sand or crushed quartz is most effective for sand-blasting, and for use with a one-quarter-inch nozzle the sand should be screened through a No. 8 screen, and through a No. 12 when a one-eighth-inch nozzle is used. The best results are apparently obtained on a thoroughly hardened concrete surface at least a month old, and for such work a nozzle pressure of from 50 to 80 pounds will be required." (Universal Portland Cement Company.)

With a special attachment, the *cement-gun*, described later, can be used for sand-blasting.

**Pebble Finish.**—A pebble finish is obtained by using rounded pebbles in the face concrete, and "spading" them against the forms. If the forms are removed before the concrete is too hard, the mortar between the pebbles can be brushed out until about half the surface of the pebbles is exposed. This finish is successfully accomplished when the mortar is about one day old, except in cold weather, when the age should be greater. The same results can be obtained by plastering the forms with clay and sticking the pebbles in the clay just before the concrete is deposited. In this case, the clay is washed out and this can be done any time after the forms are removed.

**Special Surface Finish for Concrete.**—"A method of

finishing exposed concrete surfaces has been developed by the engineers of the South Park Commissioners of Chicago, and successfully used by them in the erection of large monolithic concrete buildings. By using a comparatively lean, dry mixture for the entire thickness of their walls and as a facing for heavy walls, a concrete surface is obtained which

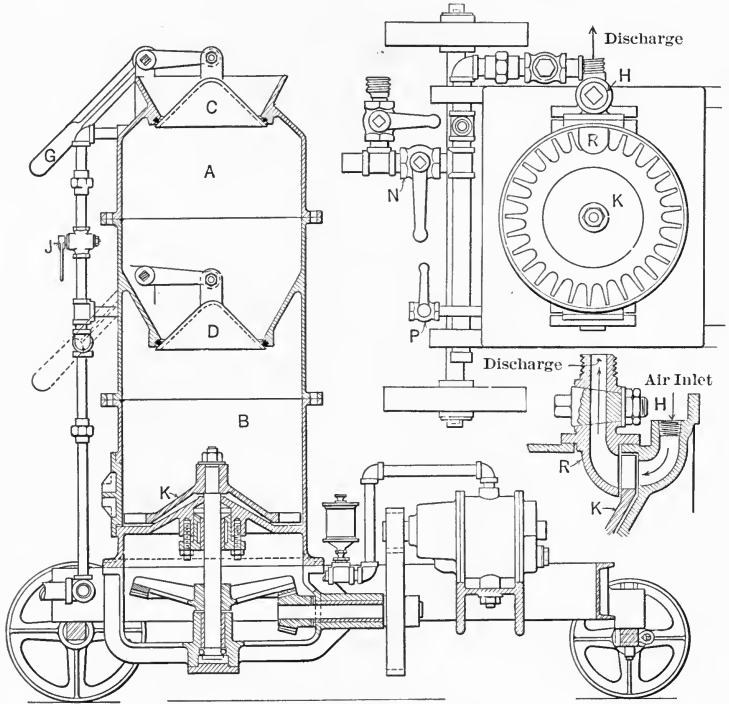

FIG. 110.—Sectional Views of Type G. L. Cement-Gun. Air Pressure, 100 Pounds. (Cement-Gun Company, Inc.)

does not take the imprint of the form imperfections, and which requires no further treatment after the removal of the forms. For this work, they use a mixture composed of about one part cement, one and one-half parts sand, and four and one-half parts crushed limestone screenings passing a one-half-inch screen, and from which the fine material has

been removed by re-screening through a quarter-inch screen. . . . The concrete is thoroughly mixed so dry that no mortar flushes to the surface when it is rammed into the forms which are constructed in the usual manner.

“The resulting surface has a rough, porous texture of a uniform, soft cement-gray color. Contrary to what might be expected of a surface which absorbs considerable moisture, work that is six years old shows no evidence of injury from frost. It is also possible to obtain sharp, clean-cut lines for architectural details and mouldings, and a surface which remains remarkably free from discolorations due to efflorescence.” (Universal Portland Cement Company.)

**Cement-Gun Surface Finish.**—A very dense, impervious, and satisfactory surface finish can be given mass concrete or architectural concrete by the use of the cement-gun (Figs. 110 and 111). This machine forms a cement mortar coating

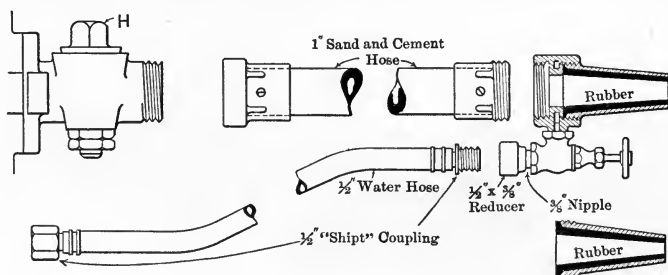

FIG. 111.—Details of Hose Connections and Nozzles Used with the Cement-Gun. (Cement-Gun Company, Inc.)

by blowing the materials through a nozzle against the surface to be covered. In operating the machine (Fig. 110), the sand and cement are passed into the chambers *A* and *B* through the cone valves *C* and *D*, which are opened by means of levers on the outside. After the chambers *A* and *B* are filled, the cone valve *C* is closed and compressed air admitted through the valve *N*, which holds the valve *C* closed in the position shown in Fig. 110. The air valve *P* is then opened, which makes the feed wheel *K* revolve. This wheel has pockets around the circumference which are filled with the dry

materials. As the wheel revolves, each pocket in turn passes through the goose-neck *R*, where its contents are blown into the hose leading to the nozzle (Fig. 111). The material remains in a dry state until it reaches the base of the nozzle, where water is admitted from the side. When the mixture reaches the surface to be covered, it immediately forms a dense coating of mortar. The final surface may be that left by the gun, or it may be brushed with a whisk broom. In case the concrete to be coated is old, it should be sand-blasted before the mortar is deposited. This can be done with the cement-gun by using the proper nozzle.

The cement-gun has been used to coat steel in buildings and bridges, to cover wooden piles, and to fill cracks in mass concrete.

**Forms for Mass Concrete** are usually constructed of wood, although there are a number of patented portable metal form in use. Wooden forms are made of vertical studs to which boards are nailed. The studs are usually two by four

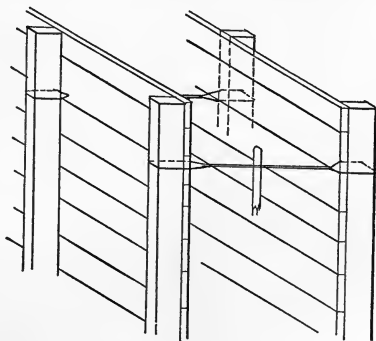

FIG. 112.—Sketch Showing Wire Ties in Concrete Forms.

inches or two by six inches spaced about two feet apart for inch boards. The inch boards are dressed on one side to a uniform thickness and with both edges straight and parallel. The boards are nailed to the studs so as to make as smooth and even a surface as possible without cracks. Matched lumber and boards beveled on one edge are sometimes used.



The walls of the forms are kept in position either by bracing on the outside or by ties running from the back to the front wall. For ordinary work, No. 8 wire is used for ties, and for very heavy work No. 7 or No. 6 wire is employed. Fig. 112 shows the arrangement of the wires, and Fig. 113 shows

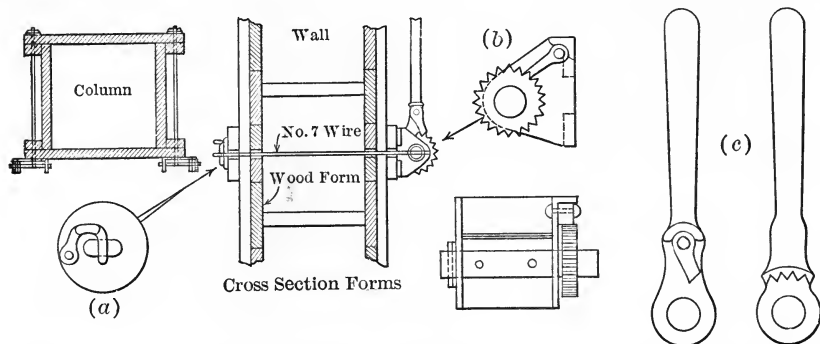

FIG. 113.—Ratchet Form Clamp. (a) Anchor for One End of Wire. (b) Ratchet Tightener at Other End of Wire. (c) Lever for Operating Ratchet. (Peerless Form Clamp Co.).

one mechanical device for tightening the wires. Where the surface of the concrete is exposed, the use of wires makes it difficult to produce a good surface appearance, as the wires extend through the surface and must be cut off, leaving ends more or less exposed. This difficulty is avoided by using the device shown in Fig. 114.

The lumber used in wooden forms can be used a second, and sometimes a third time, for unexposed surfaces, but for exposed surfaces it is better to use new lumber in order that it may be true to line and shape.

**Wetting and Oiling Forms.**—If the form boards are dry, they should be wet before the concrete is deposited to prevent the absorption of water from the surface concrete. If the forms are to be quickly removed, the boards may be oiled with crude oil to fill the pores and thereby prevent the concrete from sticking to the wood. For the same purpose, and also to make a smooth surface, oiled paper and sheet

metal have been used for mass work. Where the forms are not removed for several days, a thorough wetting is all that is necessary. Even if the planks are dry, the concrete will

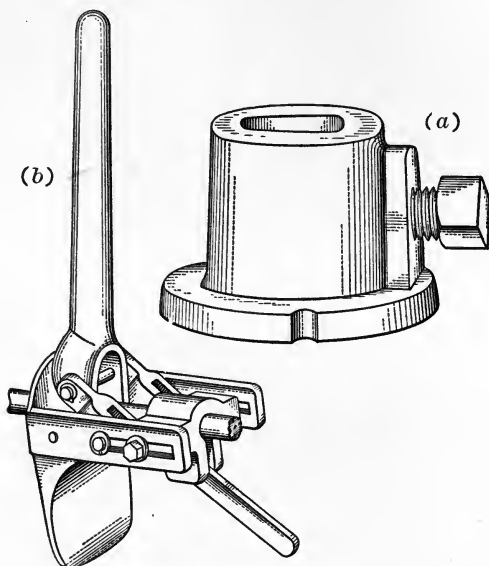

FIG. 114.—Universal Form Clamp Used with Round Rods with Nut on One End. (a) Clamp on Free End of Rod. (b) Device for Pulling Rod when Forms are Removed. (Universal Form Clamp Co.)

not stick to them, as its cohesion is greater than the adhesion to wood. The faces will show the marks of the forms.

**Rubble Concrete** is concrete in which are placed large and small stones. Where stone is plentiful, this makes a more economical structure than if composed entirely of concrete.

The stones should be far enough apart to insure that all spaces can be readily filled with concrete. The stones should be washed free of dirt, and be wet when placed in the concrete. They are usually dropped into the concrete, and the concrete "spaded" to remove entrained air. From 50 to 70 per cent of the structure may be stone. This kind of

construction is used for heavy piers, abutments, large walls, dams, etc. (Fig. 115).

**Waterproofing Concrete.**—Concrete structures may be waterproofed in two ways: (a) by making the concrete im-

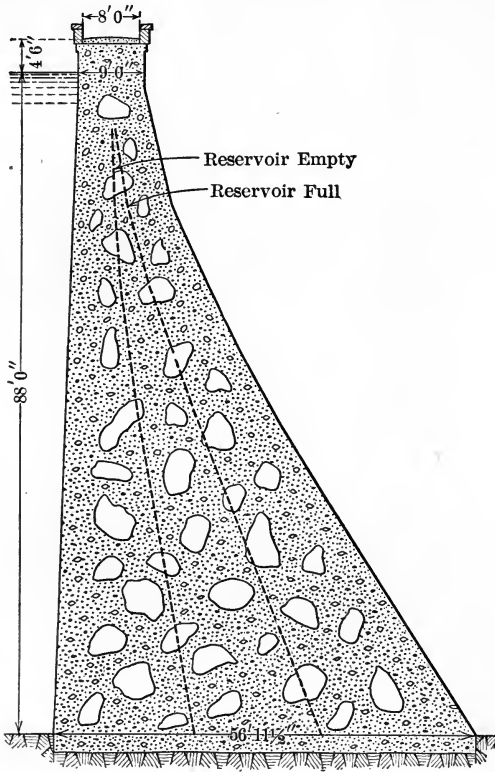

FIG. 115.—Cross-Section of Shirawata Dam, Showing Large Stones Embedded in Concrete. (For Description see *Engineering Record*, November 8, 1913.)

permeable, and (b) by making the surface of the concrete impervious.

In mass concrete, such as dams and large piers and walls, concrete with graded aggregates deposited very wet, that is, having a consistency of very thin cream, and well “spaded” to remove air bubbles, will usually be impermeable. If not

absolutely impermeable at first, it will become so after a short lapse of time. If, however, there is carelessness in the workmanship at any point, the concrete at that point will not be impermeable, and, if cracks occur, the structure, while composed of impermeable concrete, will not be impervious, as water will follow the cracks through the mass. To prevent shrinkage cracks and those due to changes of temperature, the concrete is generally reinforced longitudinally, unless special joints are made at intervals.

There are numerous compounds on the market which are designed to be mixed with the cement in making the concrete. These compounds are claimed to make the concrete impermeable. Such compounds are not necessary, and should be used with caution.

The following simple means are claimed to produce impermeable concrete.

(a) In mixing the concrete, use, in equal parts, "a five-per-cent solution of alum and water and a seven-per-cent solution of soap and water." (Hatt.)

(b) Baker states that an impervious mortar can be made by the following formula: "One per cent, by weight, of powdered alum is added to the dry cement and sand, and one per cent of potash soap (ordinary soft soap is good) is dissolved in the water used in mixing. The chemical action set up makes an insoluble compound which practically fills all pores, making an impervious concrete."

**Tests of the Absorptive and Permeable Properties of Portland Cement Mortars and Concretes.**—Following is a summary of the conclusions drawn from a series of experiments made on mortars and concretes given in Technologic Papers of the Bureau of Standards, No. 3, Tests of the Absorptive and Permeable Properties of Portland Cement Mortars and Concretes, Together with Tests of Damp-proofing and Waterproofing Compounds and Materials, by Rudolph J. Wig and P. H. Bates:

"Portland cement mortar and concrete can be made practically water-tight or impermeable (as defined below) to any

hydrostatic head up to 40 feet, without the use of any of the so-called 'integral' waterproofing materials; but, in order to obtain such impermeable mortar or concrete, considerable care should be exercised in selecting good materials as aggregate and proportioning them in such a manner as to obtain a dense mixture. The consistency of the mixture should be wet enough so that it can be puddled, the particles flowing into position without tamping. The mixture should be well spaded against the forms when placed, so as to avoid the formation of pockets on the surface.

"The addition of so-called 'integral' waterproofing compounds will not compensate for lean mixtures, nor for poor materials, nor for poor workmanship in the fabrication of the concrete. Since, in practice, the inert integral compounds (acting simply as void-filling material) are added in such small quantities, they have very little or no effect on the permeability of the concrete. If the same care be taken in making the concrete impermeable without the addition of waterproofing materials as is ordinarily taken when waterproofing materials are added, an impermeable concrete can be obtained.

"The terms 'permeability,' 'absorption,' and 'damp-proof' should not be confused. A mortar or concrete is impermeable (not necessarily damp-proof), as defined and used throughout this report, when it does not permit the passage or flow of water through its pores or voids. The absorption of a mortar or concrete is the property of drawing in or engrossing water into its pores or voids by capillary action or otherwise. If the pores or voids between the grains or particles, or in the individual grains, are sufficiently large and connected from surface to surface of the wall, the concrete will be permeable to water. If the pores or voids are very minute, but connected one with another, theoretically they may act as capillary tubes, absorbing or drawing in and filling themselves with water; but the capillary forces will tend to hold the water in the pores and will prevent the passage or flow of water, even though one surface of the wall may be exposed

to a considerable hydrostatic pressure. For all practical purposes, a wall under such conditions would be considered perfectly water-tight and impermeable, although it may be highly absorptive. If these minute pores do act as capillary tubes, and are never minute enough to prevent capillary action, the moisture either as water or water vapor would, in time, penetrate entirely through and fill a concrete wall, no matter what the thickness or composition. In such a case, the capillary forces would not permit an actual flow of water, but these forces may carry moisture, entirely filling the wall, and, unless evaporation is retarded, the opposite face of the wall would appear dry. In such a case, the concrete would be considered impermeable, but not damp-proof.

“The damp-proofing tests, as conducted, would indicate that Portland cement mortars can be made not only impermeable but damp-proof as well, as defined above, without the use of any damp-proofing or waterproofing compound. However, these tests should be interpreted with caution, as the evaporation may have been sufficient to care for the slight amount of moisture coming through the test pieces without indicating on the filter paper. Thus it cannot be stated that if a material were used which was damp-proof according to this test, if used as a basement wall, one surface being constantly exposed to moisture and the other surface in an inclosed room where there would be little or no circulation of air, the interior surface would not appear damp, and the atmosphere become saturated with moisture. The tests of coating materials as damp-proofing mediums can be considered as only preliminary, but the results, considered along with chemical discussion, throw some light on their comparative merits. The mortar used in these tests, perhaps, was too coarse and too absorptive for a fair test. The purpose of the rough surface was to test the flowing qualities of the coating, and it would seem that many of the failures may be due to the poor or imperfect spreading and adhesive quality. Several of the compounds deteriorated, and proved their unfitness for the purpose intended.

“Well-graded sands containing considerable graded fine material are preferable for making impermeable concrete, but if such is not to be had, fine material in the form of hydrated lime, finely ground clay, or an additional quantity of cement will be found of value.

“Where Portland cement mortar is used as a plaster coat, if sufficient cement be used and the sand contains sufficient fine material (or a fine material be added) and the mortar be placed without joints and well troweled (care being taken not to overtrowel, which may cause crazing), the coating will be effective as an impermeable medium without the use of any waterproofing compound.

“As a precaution, under certain conditions, it is undoubtedly desirable to use bituminous or similar coatings, even on new work, as a protection where cracks may occur, due to settling of foundation or expansion and contraction caused by temperature changes. In large or exposed work, it is practically impossible to prevent some cracks, but where cracks can be prevented no coating whatever is required to make the structure impermeable.

“The permeability of Portland cement mortars and concretes rapidly decreases with age.

“None of the integral compounds tested materially reduced the absorption of the mortars before they were dried by heating at 212° F. Thus they would have little or no practical value. But some of the so-called integral waterproofing compounds did decrease the absorption obtained after drying the mortars at 212° F., and the rate of absorption was much slower in these cases. The addition of hydrated lime and clays seemed to have little or no effect on the absorption.

“The addition of any of the compounds tested to a mortar in the quantities as used in these tests does not seriously affect the compressive or tensile strength. The addition of the inert void fillers to mortars, as used in these tests, up to 20 per cent of the volume of cement increases the compressive strength.” (Washington, D. C., Aug. 24, 1911.)

*Surface Coating of Mortar.*—A coating of rich cement mortar, made of one part Portland cement and one or two parts of fine sand, from 0.25 to 1 inch thick, is applied with a trowel to the concrete when it is still green. This makes an impermeable medium, and is successful under still water, but when exposed to the weather is liable to crack. To be successful, plaster coats require very careful treatment, and especially must the concrete to be plastered be perfectly clean. Coatings applied with the cement-gun are usually satisfactory.

*Surface Washes.*—A wash composed of alum, lye, cement, and water has been successfully used to make concrete surfaces "impervious." "Dissolve one pound of concentrated lye and five pounds of alum in two gallons of water, care being taken to have every particle dissolved. Heating to near the boiling-point will quickly insure this without injury to the mixture. This constitutes the stock mixture, and may be used in any quantity. To one pint of stock, add ten pounds of cement, thinning it with water until the mixture spreads easily and well on the surface to be treated, with a calcimine or whitewash brush, filling all the pores. The mixture will be found to be satisfactory when it lathers freely under the brush." This mixture should be applied within three or four days after the concrete has been deposited.

The *Sylvester* process can be applied to concrete in the same manner as explained for brick-work.

**Waterproofing with Asphalt and Coal Tar.**—One of the materials in general use for waterproofing concrete is asphalt, which is used alone or in conjunction with burlap, paper, felt, etc. This is supposed to form a barrier against water, and to be sufficiently flexible not to break when small cracks occur in the concrete. Coal tar is used in a similar manner.

Hot asphalt will not adhere to the surface of cold concrete, and, therefore, it must be heated with hot sand or some other means, and then cleaned. Usually, the asphalt is cut with



naphtha and applied as a paint with a swab to the cleaned concrete.

The ordinary method of procedure in waterproofing with asphalt and paper is, first, to paint the concrete surface with hot asphalt, and then spread a layer of paper or felt, lapping all joints. The layer of paper or felt is then thoroughly painted with the hot asphalt, and another layer of paper or felt spread. This process is continued until the requisite number of thicknesses of paper and asphalt has been laid. From two to six or seven layers are generally used, depending upon the structure and the amount of water expected.

There are a number of special compounds and felts on the market which are used very much in the manner outlined above.

Asphalt and coal tar are not permanent. The asphalt deteriorates rapidly when exposed to illuminating gas.

**Joining Old and New Concrete.**—In many cases it is necessary to join new concrete with concrete which has been deposited one or more days. As in the case of waterproofing, there is a large number of proprietary compounds which are claimed to make more or less perfect bond between new and old concrete. The use of such compounds is not advisable or necessary, as satisfactory results can be obtained by simply roughening and cleaning the surface of the old concrete and then coating it with a rich Portland cement mortar before the new concrete is deposited. This applies to vertical surfaces which are to receive a plaster coat applied by hand or by the cement-gun and to horizontal surfaces upon which concrete is to be placed. Vertical joints extending from top to bottom of a wall or similar structure should be reinforced with metal rods or dowels.

**Effect of Alkali and Sea-water on Concrete.**—If concrete is properly proportioned, carefully mixed, and deposited in moulds, and allowed to harden before it comes in contact with water containing alkali or sea-water, it will not be injured by such waters. An impermeable concrete with a smooth surface is practically uninjured by either the salts

in alkali water or sea-water. Of course the aggregates should be selected from materials which are inert to the action of the salts in alkali water and sea-water.

**Physical Properties of Concrete.**—The physical properties of concretes, necessarily, vary for concretes of different proportions of cement and aggregates, and with the quality of these materials.

The *crushing strength* of good 1 : 3 : 6 concrete at the end of one month is about 2,000 pounds per square inch, and at the end of six months about 2,600 pounds per square inch. For 1 : 2 : 4 concrete, these values become 2,400 and 3,300 respectively. The safe compressive strength is taken at about 400 pounds per square inch, and in some cases a compressive strength of 650 pounds per square inch is assumed.

*Young's modulus of elasticity* for a compressive load between 100 and 600 pounds per square inch is, for 1 : 3 : 6 concrete one month old, about 2,400,000 pounds per square inch, and for 1 : 2 : 4 concrete, 2,700,000 pounds per square inch.

The *weight* of gravel and broken-stone concrete varies from 145 to 155 pounds per cubic foot.

**Fire-Resisting Property of Concrete.**—While there is considerable difference of opinion concerning the ability of concrete to resist a hot fire successfully, its behavior in several large conflagrations indicates that it is superior to any of the natural building stones, and equal to if not superior to terra-cotta and hollow tile. The exposed surfaces and corners of concrete are injured by fire, but the injury apparently does not extend to any great depth below the surfaces.

## PART III.—SPECIFICATIONS

### CHAPTER VI

#### RAILROAD MASONRY, BRICK CEMENT, ETC.

**Railroad Masonry.**—The following abstracts (published by permission) are taken from the Manual of the American Railway Engineering Association. The classification of masonry definitions and specifications were recommended by a special committee on masonry, and adopted by the association.

The specifications apply particularly to bridge and retaining-wall masonry, but they can be easily modified to apply to masonry in buildings

#### CLASSIFICATION OF MASONRY

Kind	Material	Description	Manner of Work	Dressing	
				Joints or Beds	Face or Surface
Bridge and Retaining Wall	Stone	Dimension Ashlar	Coursed { Coursed Broken Coursed	Smooth { Smooth Fine-pointed Rough-pointed Rough-pointed Scabbled	{ Smooth Rock-faced Smooth Rock-faced Rock-faced
	Concrete	Rubble { Reinforced Plain Rubble	Uncoursed		
Arch	Stone	Ashlar	Coursed	{ Smooth Fine-pointed Rough-pointed Scabbled	{ Smooth Rock-faced Rock-faced
	Concrete • Brick	Rubble Reinforced Plain No. 1	Uncoursed { English Bond Flemish Bond		
Culvert	Stone Concrete	Rubble { Dry Reinforced Plain Rubble	Uncoursed	{ Rough-pointed Scabbled	Rock-faced
Dry	Stone	Rubble	Uncoursed		

## DEFINITIONS

**Masonry, Bridge and Retaining Wall.**—Masonry of stone or concrete designed to carry the end of a bridge span, or to retain the abutting earth, or both.

**Masonry, Arch.**—That portion of the masonry in the arch ring only, or between the intrados and the extrados.

**Masonry, Culvert.**—Flat-top masonry structure of stone or concrete designed to sustain the fill above, and to permit of the free passage of water.

**Masonry, Dry.**—Masonry in which stones are built up without the use of mortar.

**Concrete.**—A compact mass of broken stone, gravel, or other suitable material assembled together with cement mortar and allowed to harden.

**Reinforced Concrete.**—Concrete which has been reinforced by means of metal in some form, so as to develop the compressive strength of the concrete.

**Rubble Concrete.**—Concrete in which rubble stone are embedded.

**Brick, No. 1.**—Hard-burned brick, absorption not exceeding two per cent by weight.

**Cement.**—A material of one of the three classes, Portland, Natural, or Puzzolan, possessing the property of hardening into a solid mass when mixed with water.

**Portland Cement.**—This term shall be applied to the finely pulverized product resulting from the calcination to incipient fusion of an intimate mixture of properly proportioned argillaceous and calcareous materials, and to which no addition greater than three per cent has been made subsequent to calcination.

**Natural Cement.**—This term shall be applied to the finely pulverized product resulting from the calcination of an argillaceous limestone at a temperature only sufficient to drive off the carbonic acid gas.

**Puzzolan Cement as Made in North America.**—An in-

timate mixture obtained by finely pulverizing together granulated basic blast furnace slag and slacked lime.

### COURSES AND BOND

**Coursed.**—Laid with continuous bed joints.

**Broken Coursed.**—Laid with parallel, but not continuous, bed joints.

**Uncoursed.**—Laid without regard to courses.

**English Bond.**—That disposition of bricks in a structure in which each course is composed entirely of headers or of stretchers.

**Flemish Bond.**—That disposition of bricks in a structure in which the headers and stretchers alternate in each course, the header being so placed that the outer end lies on the middle of a stretcher in the course below.

### DRESSING

**Dressing.**—The finish given to the surface of stones or to concrete.

**Smooth.**—Having surface the variations of which do not exceed one-sixteenth inch from the pitch line.

**Fine Pointed.**—Having irregular surface the variations of which do not exceed one-quarter inch from the pitch line.

**Rough Pointed.**—Having irregular surface the variations of which do not exceed one-half inch from the pitch line.

**Scabbled.**—Having irregular surface the variations of which do not exceed three-quarters inch from the pitch line.

**Rock-Faced.**—Presenting irregular projecting face, without indications of tool mark.

### DESCRIPTIVE WORK

**Abutment.**—A supporting wall carrying the end of a bridge or span and sustaining the pressure of the abutting earth. The abutment of an arch is commonly called a bench wall.

**Arris.**—The external edge formed by two surfaces, whether plain or curved, meeting each other.

**Ashlar.**—A squared or cut block of stone with rectangular dimensions.

**Backing.**—That portion of a masonry wall or structure built in the rear of the face. It must be attached to the face and bonded with it. It is usually of a cheaper grade of work than the face.

**Batter.**—The slope or inclination of the face or back of a wall from a vertical line.

**Bed.**—The top and bottom of a stone. (See Course Bed, Natural Bed, Foundation Bed.)

**Bed Joint.**—A horizontal joint, or one perpendicular to the line of pressure.

**Bench Wall.**—The abutment from which an arch springs.

**Bond.**—The mechanical disposition of stone, brick, or other building blocks by overlapping to break joints.

**Build.**—A vertical joint.

**Centering.**—A temporary support used in arch construction. (Also called centers.)

**Clamp.**—An instrument for lifting stone so designed that its grip on the surface of the stone is increased as the load is applied. That portion engaging the stone is of wood attached to a steel shoe, which in turn is hinged to the shank of the clamp in such a manner as to adjust itself to the surface of the body lifted.

**Coping.**—A top course of stone or concrete, generally slightly projecting, to shelter the masonry from the weather, or to distribute the pressure from exterior loading.

**Course.**—Each separate layer of stone, concrete, or brick masonry.

**Course Bed.**—Stone, brick, or other building material in position, upon which other material is to be laid.

**Cramps.**—Bars of iron having the ends turned at right angles to the body of the bar which enter holes in the upper side of adjacent stones.

**Culvert.**—A small covered passage for water under a roadway or embankment.

**Dimension Stone.**—(1) A block of stone cut to specified dimensions. (2) Large blocks of stone quarried to be cut to specified dimensions.

**Dowels.**—(a) Straight bars of iron which enter a hole in the upper side of one stone and also a hole in the lower side of the stone next above. (b) A two-piece steel instrument used in lifting stone. The dowel engages the stone by means of two holes drilled into the stone at an angle of about  $45^{\circ}$  pointing toward each other. The dowel is not keyed in place.

**Draft.**—A line on the surface of a stone cut to the breadth of the chisel.

**Expansion Joint.**—A vertical joint or space to allow for temperature changes.

**Extrados.**—The upper or convex surface of an arch.

**Intrados.**—The inner or narrow concave surface of an arch.

**Face.**—The exposed surface in elevation.

**Facing.**—In concrete: (1) A rich mortar placed on the exposed surface to make a smooth finish. (2) Shovel facing by working the mortar of concrete to the face.

**Final Set.**—A stage of the process of setting marked by certain hardness. (See Cement Specifications.)

**Flush.**—(*Adj.*) Having the surface even or level with an adjacent surface. (*Verb*) (1) To fill. (2) To bring to a level. (3) To force water to the surface of mortar or concrete by compacting or ramming.

**Footing.**—A projecting bottom course.

**Form.**—A temporary structure for giving concrete a desired shape.

**Foundation.**—(1) That portion of a structure, usually below the surface of the ground, which distributes the pressure upon its support. (2) Also applied to the natural support itself; rock, clay, etc.

**Foundation Bed.**—The surface on which a structure rests.

**Grout.**—A mortar of liquid consistency which can be easily poured.

**Header.**—A stone which has its greatest length at right angles to the face of the wall, and which bonds the face stones to the backing.

**Initial Set.**—An early stage of the process of setting, marked by certain hardness. (See Cement Specifications.)

**Joint.**—The narrow space between adjacent stones, bricks, or other building blocks, usually filled with mortar.

**Lagging.**—Strips used to carry and distribute the weight of an arch to the ribs or centering during its construction.

**Lewis.**—A four-piece steel instrument used in lifting stone. (The lewis engages the stone by means of a triangular-shaped hole into which it is keyed.)

**Lock.**—Any special device or method of construction used to secure a bond in the work.

**Mortar.**—A mixture of fine aggregate, cement, or lime and water used to bind together the materials of concrete, stone, or brick in masonry, or to cover the surface of same.

**Natural Bed.**—The surfaces of a stone parallel to its stratification.

**Parapet.**—A wall or barrier on the edge of an elevated structure for protection or ornament.

**Paving.**—Regularly placed stone or brick forming a floor.

**Pier.**—An intermediate support for arches or other spans.

**Pitch.**—(*Verb*) To square a stone.

**Pitched.**—Having the arris clearly defined by a line beyond which the rock is cut away by the pitching chisel so as to make approximately true edges.

**Pointing.**—Filling joints or defects in the face of a masonry structure.

**Retaining Wall.**—A wall for sustaining the pressure of earth or filling deposited behind it.

**Voussoirs.**—The individual stones forming an arch. They are always of truncated wedge form.

**Ring Stones.**—The end voussoirs of an arch.



**Riprap.**—Rough stones of various sizes placed compactly or irregularly to prevent scour by water.

**Rubble.**—Field stone or rough stone as it comes from the quarry. When it is of a large or massive size, it is termed block rubble.

**Rubbed.**—A fine finish made by rubbing with grit or sandstone.

**Set.**—(*Noun*) The change from a plastic to a solid or hard state.

**Slope Wall.**—A wall to protect the slope of an embankment or cut.

**Soffit.**—The under side of a projection.

**Spall.**—(*Noun*) A chip or small piece of stone broken from a large block

**Spandrel Wall.**—The wall at the end of an arch above the springing line and extrados of the arch, and below the coping or the string course.

**Stretcher.**—A stone which has its greatest length parallel to the face of the wall.

**Wing Wall.**—An extension of an abutment wall to retain the adjacent earth.

## SPECIFICATIONS FOR STONE MASONRY

. . . . .

3. Stone shall be of the kinds designated, and shall be hard and durable, of approved quality and shape, free from seams or other imperfections. Unseasoned stone shall not be used where liable to injury by frost.

4. Dressing shall be the best of the kind specified.

5. Beds and joints, or builds, shall be square with each other, and dressed true and out of wind. Hollow beds shall not be permitted.

6. Stone shall be dressed for laying on the natural bed. In all cases, the bed shall not be less than the rise.

7. Marginal drafts shall be neat and accurate.

8. Pitching shall be done to true lines and exact batter.
9. Mortar shall be mixed in a suitable box, or in a machine mixer, preferably of the batch type, and shall be kept free from foreign matter. The size of the batch and the proportions and the consistency shall be as directed by the engineer. When mixed by hand, the sand and cement shall be mixed dry, the requisite amount of water then added, and the mixing continued until the cement is uniformly distributed and the mass is uniform in color and homogeneous.
10. The arrangement of courses and bond shall be as indicated on the drawings, or as directed by the engineer. Stone shall be laid to exact lines and levels to give the required bond and thickness of mortar in beds and joints.
11. Stone shall be cleansed and dampened before laying.
12. Stone shall be well bonded, laid on its natural bed, and solidly settled into place in a full bed of mortar.
13. Stone shall not be dropped or slid over the wall, but shall be placed without jarring stone already laid.
14. Heavy hammering shall not be allowed on the wall after a course is laid.
15. Stone becoming loose after the mortar is set shall be re-laid with fresh mortar.
16. Stone shall not be laid in freezing weather, unless directed by the engineer. If laid, it shall be freed from ice, snow, or frost by warming; and the sand and water used in the mortar shall be heated.
17. With precaution, a brine may be substituted for the heating of the mortar. The brine shall consist of one pound of salt to eighteen gallons of water, when the temperature is 32° F. For every degree of temperature below 32° F., one ounce of salt shall be added.
18. Before the mortar has set in beds and joints, it shall be removed to a depth of not less than one inch. Pointing shall not be done until the wall is complete and mortar set, nor when frost is in the stone.
19. Mortar for pointing shall consist of equal parts of sand, sieved to meet the requirements, and Portland cement.

In pointing, the joints shall be wet, and filled with mortar, pounded in with a "set-in" or caulking tool, and finished with a beading tool the width of the joint, used with a straight-edge.

## BRIDGE AND RETAINING WALL MASONRY

### *Ashlar Stone*

20. The stone shall be large and well proportioned. Courses shall not be less than 14 inches or more than 30 inches thick; thickness of courses to diminish regularly from the bottom to the top.

21. Beds and joints, or builds, of face stone shall be fine-pointed, so that the mortar layer should not be more than one-half inch thick when the stone is laid.

22. Joints in face stone shall be full to the square for a depth equal to at least one-half the height of the course, but in no case less than 12 inches.

23. Exposed surfaces of the face stone shall be rock-faced, and edges pitched to the true lines and exact batter; the face shall not project more than three inches beyond the pitch line.

24. Chisel drafts one and one-half inches wide shall be cut at exterior corners.

25. Holes for stone hooks shall not be permitted to show in exposed surfaces. Stone shall be handled with clamps, keys, lewis, or dowels.

26. Stretchers shall not be less than four feet long, and have at least one and a quarter times as much bed as thickness of course.

27. Headers shall not be less than four feet long, shall occupy one-fifth of face of wall, shall not be less than 18 inches wide in face, and, where the course is more than 18 inches high, width of face shall not be less than height of course.

28. Headers shall hold in heart of wall the same size shown in face, so arranged that a header in a superior course

shall not be laid over a joint, and a joint shall not occur over a header; the same disposition shall occur in back of wall.

29. Headers in face and back of wall shall interlock when thickness of wall will admit.

30. When the wall is three feet thick or less, the face stone shall pass entirely through. Backing shall not be permitted.

31. (a) Backing shall be large, well-shaped stone, roughly bedded and jointed; bed joints shall not exceed one inch. At least one-half of the backing stone shall be of the same size and character as the face stone and with parallel ends. The vertical joints in back of wall shall not exceed two inches. The interior vertical joints shall not exceed six inches. Voids shall be thoroughly filled with *concrete* (or) *spalls, fully bedded in cement mortar*. (b) Backing shall be of *concrete* (or) *headers and stretchers, as specified in paragraphs 26 and 27, and heart of wall filled with concrete*.

32. Where the wall will not admit of such arrangement, stone not less than four feet long shall be placed transversely in heart of wall to bond the opposite sides.

33. Where stone is backed with two courses, neither course shall be less than eight inches thick.

34. Bond of stone in face, back, and heart of wall shall not be less than 12 inches. Backing shall be laid to break joints with the face stone and with one another.

35. Coping stone shall be full size throughout, of dimensions indicated on drawings.

36. Beds, joints, and top shall be fine-pointed.

37. Location of joints shall be determined by the position of the bed plates, and be indicated on the drawings.

38. Where required, coping stone, stone in wings of abutments, and stone on piers, shall be secured together with iron cramps or dowels, to the position indicated on the drawings.

## BRIDGE AND RETAINING WALL MASONRY

*Rubble Stone*

39. The stone shall be roughly squared, and laid in irregular courses. Beds shall be parallel, roughly dressed, and the stone laid horizontal to the wall. Face joints shall not be more than one inch thick. Bottom stone shall be large, selected flat stone.

40. The wall shall be compactly laid, having at least one-fifth the surface of back and face headers arranged to interlock, having all voids in the heart of the wall thoroughly filled with *concrete* (or) *suitable stones and spalls, fully bedded in cement mortar*.

## ARCH MASONRY

*Ashlar Stone*

41. Voussoirs shall be full size throughout and dressed true to templet, and shall have bond not less than thickness of stone.

42. Joints of voussoirs and intrados shall be fine-pointed. Mortar joints shall not exceed three-eighths of an inch.

43. Exposed surface of ring stone shall be *smooth* (or) *rock faced with a marginal draft*.

44. Number of courses and depth of voussoirs shall be indicated on the drawings.

45. Voussoirs shall be placed in the order indicated on the drawings.

46. Backing shall consist of *concrete* (or) *large stone, shaped to fit the arch, bonded to the spandrel, and laid in a full bed of mortar*.

47. Where waterproofing is required, a thin coat of mortar or grout shall be applied evenly for a finishing coat, upon which shall be placed a covering of approved waterproofing material.

48. Centers shall not be struck until directed by the engineer.

49. Bench walls, piers, spandrels, parapets, wing walls, and copings shall be built under specifications for Bridge and Retaining Wall Masonry, Ashlar Work

### ARCH MASONRY

#### *Rubble Stone*

50. Voussoirs shall be full size throughout, and shall have bond not less than thickness of voussoirs.

51. Beds shall be roughly dressed to bring them to radial planes.

52. Mortar joints shall not exceed one inch.

53. Exposed surfaces of the ring stone shall be rock-faced, and edges pitched to true lines.

54. Voussoirs shall be placed in the order indicated on the drawings.

55. Backing shall consist of *concrete (or) large stone, shaped to fit the arch, bonded to the spandrel, and laid in full bed of mortar.*

56 and 57. (See 47 and 48.)

58. Bench walls, piers, spandrels, parapets, wing walls, and copings shall be built under the specifications for Bridge and Retaining Wall Masonry, Rubble Stone.

### CULVERT MASONRY

59. Culvert masonry shall be laid in cement mortar. Character of stone and quality of work shall be the same as specified for Bridge and Retaining Wall Masonry, Rubble Stone.

60. One-half the top stone of the side walls shall extend entirely across the wall.

61. Covering stone shall be sound and strong, at least 12 inches thick, or as indicated on the drawings. They shall be roughly dressed to make close joints with each other, and lap their entire width at least 12 inches over the side walls. They shall be doubled under high embankments, as indicated on the drawings.

62. End walls shall be covered with suitable coping, as indicated on the drawings.

#### DRY MASONRY

63. Dry masonry shall include dry retaining walls and slope walls.

64. Retaining walls and dry masonry shall include all walls in which rubble stone laid without mortar is used for retaining embankments or for similar purposes.

65. Flat stones at least twice as wide as thick shall be used. Beds and joints shall be roughly dressed square to each other and to face of stone.

66. Joints shall not exceed three-quarters of an inch.

67. Stone of different sizes shall be evenly distributed over entire face of wall, generally keeping the larger stone in lower part of wall.

68. The work shall be well bonded, and present a reasonably true and smooth surface, free from holes or projections.

69. Slope walls shall be built of such thickness and slope as directed by the engineer. Stone shall not be used in this construction which does not reach entirely through the wall. Stone shall be placed at right angles to the slopes. The wall shall be built simultaneously with the embankment which it is to protect.

#### SPECIFICATIONS FOR PLAIN CONCRETE

1. The cement shall be Portland, and shall meet the requirements of the standard specifications.

2. Fine aggregate shall consist of sand, crushed stone, or gravel screenings, graded from fine to coarse, and passing when dry a screen having one-quarter inch diameter holes; it shall preferably be of hard siliceous material, clean, free from dust, soft particles, vegetable loam or other deleterious matter, and not more than six per cent shall pass a sieve having 100 meshes per linear inch.

3. The fine aggregate shall be of such quality that mortar composed of one part Portland cement and three parts fine aggregate by weight when made into briquettes shall show a tensile strength at least equal to the strength of 1 : 3 mortar of the same consistency made with the same cement and standard Ottawa sand.

4. Coarse aggregate shall consist of material such as crushed stone or gravel which is retained on a screen having one-quarter inch diameter holes and having gradations of sizes from the smallest to the largest particles. Aggregates containing dust, soft, or elongated particles shall not be used.

5. The water used in mixing concrete shall be free from oil, acid, and injurious amounts of alkalis or vegetable matter.

. . . . .

22. The unit of measure shall be the cubic foot. A bag containing not less than 94 pounds of cement shall be assumed as one cubic foot of cement. Fine and coarse aggregates shall be measured separately as loosely thrown into the measuring receptacle.

23. The fine and coarse aggregates shall be used in such relative proportions as will insure maximum density.

. . . . .

25. For plain concrete, a proportion of 1 : 9 (unless otherwise specified) shall be used; *i.e.*, one part of cement to a total of nine parts of fine and coarse aggregates measured separately; for example, one part cement, three parts fine aggregate, and six parts coarse aggregate.

. . . . .

27. The ingredients of concrete shall be thoroughly mixed



to the desired consistency, and the mixing shall continue until the cement is uniformly distributed and the mass is uniform in color and homogeneous.

28. The various ingredients, including the water, shall be measured separately, and the methods of measurement shall be such as to secure the proper proportions at all times.

29. A machine mixer, preferably of the batch type, shall be used, wherever the volume of the work will justify the expense of installing the plant. The requirements demanded are that the product delivered shall be of the specified proportions and consistency, and thoroughly mixed.

30. When it is necessary to mix by hand, the mixing shall be on a water-tight platform of sufficient size to accommodate men and materials for the progressive and rapid mixing of at least two batches of concrete at the same time. Batches shall not exceed one-half cubic yard each. The mixing shall be done as follows: The fine aggregate shall be spread evenly upon the platform, then the cement upon the fine aggregate, and these mixed thoroughly until of an even color. The water necessary to mix a thin mortar shall then be added, and the mortar spread again. The coarse aggregates, which, if dry, shall first be thoroughly wetted down, shall then be added to the mortar. The mass shall then be turned with shovels or hoes until thoroughly mixed and all aggregate covered with mortar. Or, at the option of the engineer, the coarse aggregate may be added before, instead of after, adding the water.

31. The materials shall be mixed wet enough to produce a concrete of such consistency that it will flow into the forms and about the metal reinforcement, and which, on the other hand, can be conveyed from the place of mixing to the forms without separation of the coarse aggregate from the mortar.

32. Re-tempering mortar or concrete, *i.e.*, remixing with water after it has partially set, will not be permitted.

33. Concrete after the completion of the mixing shall be handled rapidly to the place of final deposit, and under no

circumstances shall concrete be used that has partially set before final placing.

34. The concrete shall be deposited in such a manner as will prevent the separation of the ingredients and permit the most thorough compacting. It shall be compacted by working with a straight shovel or slicing tool kept moving up and down until all the ingredients have settled in their proper place and the surplus water is forced to the surface. In general, except in arch work, all concrete must be deposited in horizontal layers of uniform thickness throughout.

35. In depositing concrete under water, special care shall be exercised to prevent the cement from floating away and to prevent the formation of laitance.

36. Before depositing concrete, the forms shall be thoroughly wetted (except in freezing weather) or oiled, and the space to be occupied by the concrete cleared of débris.

37. Before placing new concrete on or against concrete which has set, the surface of the latter shall be roughened, thoroughly cleansed of foreign material and laitance, drenched and slushed with a mortar consisting of one part Portland cement and not more than two parts fine aggregate.

38. The faces of concrete exposed to premature drying shall be kept wet for a period of at least three days.

39. Concrete shall not be mixed or deposited at a freezing temperature, unless special precautions, approved by the engineer, are taken to avoid the use of materials covered with ice crystals or containing frost and to provide means to prevent the concrete from freezing.

40. Where the concrete is to be deposited in massive work, clean, large stones, evenly distributed, thoroughly bedded, and entirely surrounded by concrete, may be used, at the option of the engineer.

41. Forms shall be substantial and unyielding, and built so that the concrete shall conform to the designed dimensions and contours, and so constructed as to prevent the leakage of mortar.

42. The forms shall not be removed until authorized by the engineer.

43. For all important work, lumber used for face work shall be dressed to a uniform thickness and width, shall be sound and free from loose knots, and secured to the studing or uprights in horizontal lines.

44. For backing and other rough work, undressed lumber may be used.

• 45. Where corners of masonry and other projections liable to injury occur, suitable mouldings shall be placed in the angles of the forms to round or bevel them off.

46. Lumber once used in forms shall be cleaned before being used again.

. . . . .

49. Concrete structures, wherever possible, shall be cast at one operation, but when this is not possible, the resulting joint shall be formed where it will least impair the strength and appearance of the structure.

50. Girders and slabs shall not be constructed over freshly formed walls or columns without permitting a period of at least four hours to elapse to provide for settlement or shrinkage in the supports. Before resuming work, the tops of such walls or columns shall be cleaned of foreign matter and laitance.

51. A triangular-shaped groove shall be formed at the surface of the concrete at vertical joints in walls and abutments.

52. Except where a special surface finish is required, a spade or special tool shall always be worked between the concrete and the form, to force back the coarse aggregates and produce a mortar face.

53. Top surfaces shall generally be "struck" with a straight-edge or "floated" after the coarse aggregates have been forced below the surface.

54. When a "sidewalk finish" is called for on the plans,

it shall be made by spreading a layer of 1 : 2 mortar at least three-quarters of an inch thick, troweling the same to a smooth surface. This finishing coat shall be put on before the concrete has taken its initial set.

## MONOLITHIC CONSTRUCTION

### *Definitions*

**Monolith of Concrete.**—A single mass of concrete made without joints by a continuous operation of construction.

**Monolithic Concrete Construction.**—Monolithic concrete construction is the building of a single mass of concrete without joints by a continuous operation.

### *Principles of Practice*

These conclusions are based upon the supposition that the structure is well designed, and that the foundation is good.

1. Monolithic concrete construction may be used without danger of cracking for abutments of any length that the working conditions will permit, provided the length does not exceed about three times the height.

2. Where abutments with wing walls are not of monolithic construction, joints should be provided at the intersections of the wing walls and the body of the abutments.

3. Reinforced concrete abutments may be built in units of any length that economic conditions will permit.

4. Monolithic concrete construction may be used for arches where the conditions will permit, otherwise the arch ring should be constructed with radial joints.

## PROPOSED STANDARD SPECIFICATIONS FOR BUILDING BRICK\*

**Sampling.**—For the purpose of tests, brick shall be selected to represent the commercial product by an experienced

---

\* Proceedings of American Society for Testing Materials, Vol. XIII, 1913, p. 286.

person agreed upon by the parties to the contract. All brick shall be carefully examined and their condition noted before being subjected to any kind of test.

For the purpose of the tests, ten bricks will be required, which shall be thoroughly dried to constant weight in a suitable oven at a temperature of from 225° F. (107° C.) to 250° F. (121° C.).

**Compression Test.**—Compression tests shall be made on at least five half-bricks, each taken from a different brick. The half-brick shall be prepared either by sawing or by breaking upon a yielding bed with a sharp mason's chisel, which shall be the full width of the brick. To secure a uniform bearing in the testing machine, they shall be bedded in a thin coat of plaster of Paris, spread upon a plate glass surface coated with a thin layer of oil. The brick shall be pressed firmly upon the surface, making the layer as thin as possible, and remain undisturbed until set. Before applying the plaster of Paris, the bearing surface of the brick shall receive a coat of shellac.

Recessed or panel brick should be brought to a full bearing surface by filling the depression with neat Portland cement mortar, which shall stand at least 24 hours before the plaster of Paris is applied.

The machine used for the compression test shall be equipped with a spherical bearing block kept thoroughly lubricated to insure accurate adjustment, and the adjustment should be made by hand under a small initial load. During the test, the beam of the testing machine shall be kept constantly in a floating position. The breaking load shall be divided by the area in compression and the results reported in pounds per square inch.

**Absorption.**—At least five dry bricks shall be weighed and completely submerged in water at a temperature between 60° and 80° F., the water heated to boiling within one hour, boiled continuously for four hours, then allowed to cool in the water to temperature between 60° and 80° F.

They should then be removed, the surface water wiped off

with a cloth and the brick quickly weighed. The percentage of absorption shall be computed on the dry weight.

### REQUIREMENTS

#### *Class A.—Vitrified Brick*

Average compressive strength not less than 5,000 pounds per square inch.

Minimum compressive strength, of any specimen in test, not less than 4,500 pounds per square inch.

Average absorption, not more than five per cent.

#### *Class B.—Hard-Burned Brick*

Average compressive strength not less than 3,500 pounds per square inch.

Minimum compressive strength, of any specimen in the test, not less than 3,000 pounds per square inch.

Average absorption not more than 12 per cent.

If subjected to the freezing test, they shall not show cracking or serious spalling in any of the bricks tested, or serious disintegration of the material.

#### *Class C.—Common Brick, First*

Average compressive strength not less than 2,000 pounds per square inch.

Minimum compressive strength of any specimen in the test, not less than 1,800 pounds per square inch.

Average absorption not more than 18 per cent.

(Freezing test same as for Class B.)

#### *Class D.—Common Brick, Second*

(These bricks to be used only for backing-up and for interior walls involving small loads.)

Average compressive strength not less than 1,500 pounds per square inch.

Minimum compressive strength of any specimen in the test not less than 1,200 pounds per square inch.

### *Miscellaneous*

Any brick other than clay brick may be included in Classes A, B, and C, provided they meet the specified requirements; and when the freezing test is required, it shall not show cracking or serious spalling in any of the bricks tested, or serious disintegration of material.

## PROPOSED STANDARD SPECIFICATIONS FOR LIME\*

1. Lime is a product resulting from the calcination, at a temperature below the cintering point, of a material containing carbonates of calcium or calcium and magnesium, which may be or has been converted to a paste or a dry flocculent powder, by slaking:

2. Limes may be divided into two commercial forms:

(a) *Quicklime*. A product coming from the kiln, without subsequent treatment other than sorting, crushing, or pulverization, which slakes on the addition of water. Quicklime may be shipped either as lump lime or pulverized lime. Lump lime shall be kiln size. Pulverized lime is lump lime reduced in size by mechanical means.

(b) *Hydrate*. A dry flocculent powder resulting from the hydration of quicklime.

3. (a) Quicklimes are divided into two grades:

*Selected*.—A well-burned lime, picked free from ashes, core, clinker, or other foreign material.

*Run-of-kiln*.—A well-burned lime without selection.

(b) Hydrates are divided into two classes.

*Building and Chemical*.—A lime hydrated to definite

---

\* Proceedings of American Society for Testing Materials, Vol. XIII, 1913, p. 315.

chemical proportions, and reduced to a fineness suitable for building purposes.

*Agricultural*.— . . .

#### CHEMICAL TESTS

8. (a) Selected quicklime shall contain not under 90 per cent of calcium and magnesium oxides, and not over three per cent of carbon dioxide. (b) Run-of-kiln quicklime shall contain not under 85 per cent of calcium and magnesium oxides, and not over five per cent of carbon dioxide.

9. Building and chemical hydrates shall contain not over five per cent of carbon dioxide, and not under one per cent of water in excess of that required to hydrate fully the calcium oxide present.

#### PHYSICAL PROPERTIES AND TESTS

##### (A) *Quicklime*

11. An average five-pound sample of selected or run-of-kiln quicklime shall be put in a box and slaked with sufficient water to produce a lime putty, which shall be allowed to stand 24 hours, then washed through a standard 10-mesh sieve. Not over three per cent of the weight of selected quicklime, nor over five per cent of the weight of run-of-kiln quicklime, shall be retained on the sieve. The sample taken for this test shall not be crushed finer than will pass a one-inch ring, either before being sent to the laboratory or at the laboratory.

##### (B) *Hydrated Lime*

12. (a) Building and chemical hydrates shall leave by weight a residue of not over five per cent on a standard 100-mesh sieve. . . . .



## PACKING AND MARKING

*(A) Lump Lime*

13. When not shipped in bulk, lump lime shall be packed in barrels, which may weigh either 200 pounds gross and contain approximately 185 pounds of lime, or 300 pounds gross and contain approximately 280 pounds of lime.

14. The name of the manufacturer, grade, and gross weight shall be legibly marked on each barrel. Marking shall be blue for selected and red for run-of-kiln quicklime.

*(B) Pulverized Lime*

15. Pulverized lime shall be packed either in cloth bags containing 167 pounds, or in paper sacks containing 80 pounds.

. . . . .

*(C) Hydrated Lime*

17. Hydrated lime may be packed either in cloth bags containing 100 pounds, or in paper sacks containing 40 pounds.

. . . . .

## A SPECIFICATION FOR SAND\*

The material shall be of such fineness that all shall pass a No. 4 sieve.

The material shall contain at least 95 per cent of silica.

Before acceptance of the sand, the contractor shall forward to the engineer an average sample, taken from the proposed source of supply, which sample shall be subject to analysis and comparative physical tests with standard Ottawa sand.

---

\* Proceedings of American Society for Testing Materials, Vol. X, 1910, p. 341.

*Requirement 1.*—The sand under examination, when tested, with a normal Portland cement as mortar in the proportion of one part cement to three parts sand, according to standard methods, shall develop at least 75 per cent of the strength developed in similarly proportional mortar of the same cement and Ottawa sand. But in no case shall such sample mortar under investigation, in a 1 : 3 mixture briquette, when tested in tension, fail at less than 150 pounds at 7 days or 200 pounds at 28 days.

*Requirement 2.*—The sand under examination, when tested as mortar in the proportion of one part cement to three parts sand, gauged by hand with 50 per cent excess of the normal quantity of water, shall develop at least 50 per cent of its strength at identical periods, when normally gauged. But in no case shall such sample mortar under investigation, in a 1 : 3 mixture briquette, 50 per cent excess gauge, when tested in tension, fail at less than 100 pounds at 7 days or 150 pounds at 28 days.

*Requirement 3.*—After complete tests have been made to determine the character of the representative sample, each carload of sand to be used shall be subjected to the above-described analysis and tests, and shall develop at seven days, under similar methods of testing and gauging, at least 80 per cent of the strength of the original sand sample shown by the preliminary tests under which the sand may have been accepted.

## STANDARD SPECIFICATIONS FOR CEMENT\*

ADOPTED AUGUST 16, 1909

### *General Observations*

1. These remarks have been prepared with a view of pointing out the pertinent features of the various requirements and the precautions to be observed in the interpretation of the results of the tests.

---

\* Year Book, 1914, American Society for Testing Materials.

2. The Committee would suggest that the acceptance or rejection under these specifications be based on tests made by an experienced person having the proper means for making the tests.

### *Specific Gravity*

3. Specific gravity is useful in detecting adulteration. The results of tests of specific gravity are not necessarily conclusive as an indication of the quality of a cement, but when in combination with the results of other tests may afford valuable indications.

### *Fineness*

4. The sieves should be kept thoroughly dry.

### *Time of Setting*

5. Great care should be exercised to maintain the test pieces under as uniform conditions as possible. A sudden change or wide range of temperature in the room in which the tests are made, a very dry or humid atmosphere, and other irregularities vitally affect the rate of setting.

### *Constancy of Volume*

6. The tests for constancy of volume are divided into two classes, the first normal, the second accelerated. The latter should be regarded as a precautionary test only, and not infallible. So many conditions enter into the making and interpreting of it that it should be used with extreme care.

7. In making the pats, the greatest care should be exercised to avoid initial strains due to moulding or to too rapid drying-out during the first 24 hours. The pats should be preserved under the most uniform conditions possible, and rapid changes of temperature should be avoided.

8. The failure to meet the requirements of the accelerated tests need not be sufficient cause for rejection. The cement

may, however, be held for 28 days, and a re-test made at the end of that period, using a new sample. Failure to meet the requirements at this time should be considered sufficient cause for rejection, although in the present state of our knowledge it cannot be said that such failure necessarily indicates unsoundness, nor can the cement be considered entirely satisfactory simply because it passes the tests.

## SPECIFICATIONS

### *General Conditions*

1. All cement shall be inspected.
2. Cement may be inspected either at the place of manufacture or on the work.
3. In order to allow ample time for inspecting and testing, the cement should be stored in a suitable weather-tight building having the floor properly blocked or raised from the ground.
4. The cement shall be stored in such a manner as to permit easy access for proper inspection and identification of each shipment.
5. Every facility shall be provided by the contractor, and a period of at least 12 days allowed for the inspection and necessary tests.
6. Cement shall be delivered in suitable packages with the brand and name of manufacturer plainly marked thereon.
7. A bag of cement shall contain 94 pounds of cement net. Each barrel of Portland cement shall contain four bags, and each barrel of natural cement shall contain three bags of the above net weight.
8. Cement failing to meet the 7-day requirements may be held awaiting the results of the 28-day tests before rejection.
9. All tests shall be made in accordance with the methods proposed by the Committee on Uniform Tests of Cement of the American Society of Civil Engineers, presented to the Society January 21, 1903, and amended January 20,

1904, and January 15, 1908, with all subsequent amendments thereto.

10. The acceptance or rejection shall be based on the following requirements:

NATURAL CEMENT

11. *Definition.*—This term shall be applied to the finely pulverized product resulting from the calcination of an argillaceous limestone at a temperature only sufficient to drive off the carbonic acid gas.

*Fineness*

12. It shall leave by weight a residue of not more than 10 per cent on the No. 100 and 30 per cent on the No. 200 sieve.

*Time of Setting*

13. It shall not develop initial set in less than 10 minutes; and shall not develop hard set in less than 30 minutes, or in more than 3 hours.

*Tensile Strength*

14. The minimum requirements for tensile strength for briquettes one square inch in cross section shall be as follows, and the cement shall show no retrogression in strength within the periods specified:

Age	NEAT CEMENT	Strength
24 hours in moist air.....		75 lbs.
7 days (1 day in moist air, 6 days in water).....		150 "
28 days (1 day in moist air, 27 days in water).....		250 "
ONE PART CEMENT, THREE PARTS STANDARD OTTAWA SAND		
7 days (1 day in moist air, 6 days in water).....		50 "
28 days (1 day in moist air, 27 days in water).....		125 "

*Constancy of Volume*

15. Pats of neat cement about three inches in diameter, one-half inch thick at center, tapering to a thin edge, shall be kept in moist air for a period of 24 hours.

(a) A pat is then kept in air at normal temperature.

(b) Another is kept in water maintained as near 70° F. as practicable.

16. These pats are observed at intervals for at least 28 days, and, to pass the tests satisfactorily, shall remain firm and hard and show no signs of distortion, checking, cracking, or disintegrating.

### PORTLAND CEMENT

17. *Definition.*—This term is applied to the finely pulverized product resulting from the calcination to incipient fusion of an intimate mixture of properly proportioned argillaceous and calcareous materials, and to which no addition greater than three per cent has been made subsequent to calcination.

#### *Specific Gravity*

18. The specific gravity of cement shall not be less than 3.10. Should the test of cement as received fall below this requirement, a second test may be made upon a sample ignited at a low red heat. The loss in weight of the ignited cement shall not exceed four per cent.

#### *Fineness*

19. It shall leave by weight a residue of not more than 8 per cent on the No. 100 and not more than 25 per cent on the No. 200 sieve.

#### *Time of Setting*

20. It shall not develop initial set in less than 30 minutes; and must develop hard set in not less than one hour, nor more than ten hours.

#### *Tensile Strength*

21. The minimum requirements for tensile strength for briquettes one square inch in cross-section shall be as follows,

and the cement shall show no retrogression in strength within the periods specified:

Age	NEAT CEMENT	Strength
24 hours in moist air.....		175 lbs.
7 days (1 day in moist air, 6 days in water).....		500 "
28 days (1 day in moist air, 27 days in water).....		600 "
ONE PART CEMENT, THREE PARTS STANDARD OTTAWA SAND		
7 days (1 day in moist air, 6 days in water).....		200 "
28 days (1 day in moist air, 27 days in water).....		275 "

*Constancy of Volume*

22. Pats of neat cement about three inches in diameter, one-half inch thick at the center, and tapering to a thin edge, shall be kept in moist air for a period of 24 hours.

(a) A pat is then kept in air at normal temperature and observed at intervals for at least 28 days.

(b) Another pat is kept in water maintained as near 70° F. as practicable, and observed at intervals for at least 28 days.

(c) A third pat is exposed in any convenient way in an atmosphere of steam, above boiling water, in a loosely closed vessel for five hours.

23. These pats, to pass the requirements satisfactorily, shall remain firm and hard, and show no signs of distortion, checking, cracking, or disintegrating.

*Sulphuric Acid and Magnesia*

24. The cement shall not contain more than 1.75 per cent of anhydrous sulphuric acid (SO<sub>3</sub>) nor more than 4 per cent of magnesia (MgO).

## REFERENCES \*

Nomenclature of Building Stones and Stone Masonry. Committee Report, T. A. S. C. E., Vol. VI, 1877.

Dimension Stone Quarrying: The Blasting Process. T. A. S. C. E., Vol. XXV, 1891.

Notes upon Testing Building Stones, with Bibliography. T. A. S. C. E., Vol. XXXII, 1894.

Relative Effects of Frost and Sulphate of Soda Efflorescence Tests on Building Stones. T. A. S. C. E., Vol. XXXIII, 1895.

The Strength of Stone as Affected by Different Methods of Quarrying. E. N., Nov. 1, 1906.

The Characteristics of Good Building Stones. *Ores and Metals*, March 20, 1907.

The Two Carraras. Description of Quarries in Italy and Vermont, U. S. A. *Architectural Record*, May, 1907.

Marbles: Their Ancient Application. The Modern Aspect of Marble-Work in Architecture. *Journal*, Royal Institute of British Architects, Jan. 26, 1907.

Sand Lime Brick Manufacture and Use. *Municipal Engineering*, Jan., 1907.

Sand Lime Brick, Historical. *Scientific American Supplement*, May 25, 1907.

Standard Specifications for Paving and Building Brick. Report of Committee, P. A. S. T. M., Vols. IX, X, and XIII, 1909, 1910, and 1913.

Tests of Brick Columns and Terra-Cotta Block Columns. University of Illinois, Bulletin No. 27, Sept., 1908.

Working Loads on Brick-Work. *Builder*, March 14, 1908.

Strength of Brick and Brick Piers. E. R., Feb. 23, 1907.

Tests and Theories in Their Relation to Specifications for Bricks. Proceedings of Engineers' Society of Western Pennsylvania, Nov., 1906.

Modern Methods of Brick Making. *Journal of Society of Arts*, Aug. 12, 1910.

Story of the Brick. *Scientific American*, April 6, 1907.

Brick Manufacture and Brick Pavements. T. A. S. C. E., Vols. XXVI (1892), XXIX, and XXX.

Terra Cotta: Its Character and Construction. *Brick Builder*, Oct., 1909.

Architectural Terra-Cotta Construction. *American Architect*, Nov. 15, 1911.

Proposed Specifications for Hollow Clay Tile Building Blocks. E. N., Feb. 8, 1912.

Manufacture of Plaster of Paris. *Engineering and Mining Journal*, Dec. 8, 1906.

Manufacture of Lime. Technological Papers of the Bureau of Standards, U. S. A., No. 12.

---

\* E. N. refers to *Engineering News*. E. R. refers to *Engineering Record*. E. C. refers to *Engineering-Contracting*. T. A. S. C. E. refers to Transactions of American Society of Engineers. P. A. S. T. M. refers to Proceedings of American Society for Testing Materials. P. A. R. E. A. refers to Proceedings of the American Railway Engineers' Association.



- Standard Sand for Cement Work. E. R., July 20, 1907.
- Sands: Their Relation to Mortar and Concrete. *Cement Age*, July, 1908.
- A Sand Specification and Its Specific Application. P. A. S. T. M., Vol. X, 1910.
- A Proposed Study of Concrete Sands. E. N., May 30, 1912.
- Testing Sand for Use in Concrete and Cement Mortar. *Cement and Engineering News*, Sept., 1912.; E. R., April 27, 1912.
- Sand and Gravel Washing Plants. *Cement and Engineering News*, July, 1913.
- A Portable Sand and Gravel Washer for Contractors' Use. E. C., June 17, 1914.
- Prevention of Freezing in Concrete by Calcium Chloride. E. R., April 20, 1907.
- Winter Construction of a Reinforced Concrete Building. E. N., Sept. 24, 1914.
- The Concrete Block and Its Advance to the Position of a First-Class Building Material. Journal Association Engineering Societies, March, 1907.
- Standard Rules and Regulations Governing Concrete Hollow Blocks Adopted by National Association of Cement Users. E. R., March 7, 1908; *Cement Age*, Feb., 1908.
- Proportioning Gravel Concrete. *Cement and Engineering News*, Aug., 1912.
- Effect of Oil on Cement Mortar. E. N., July 4, 1907.
- Simple Tests of Portland Cement. E. C.; July 17, 1907; *Cement Age*, Aug., 1907.
- Standard Specifications for Cement and Methods for Testing Cement. Year Book, American Society for Testing Materials.
- Efficiency of Cement Joints in Joining Old Concrete to New. E. N., Dec. 12, 1907.
- Strength of Concrete Joints. Results of Tests. Proceedings of Engineers' Society of Western Pennsylvania, Dec., 1908.
- Tests on Bonding New Concrete to Old. E. N., Aug. 13, 1908.
- The Bonding of New and Old Concrete. T. A. S. C. E., Vol. LXIV, 1909.
- Methods of Patching and Repairing Plain and Reinforced Concrete. P. A. R. E. A., Vol. XIII, 1913.
- Some Representative Concrete Mixing Plants with Records of Operating Costs. E. C., April 10, 1907.
- Proportions of Concrete and Methods of Mixing. E. R., Feb. 15, 1908.
- Pneumatic Rammers for Concrete. E. R., May 2, 1914.
- Lining Rondout Pressure Tunnel, New York. (Compressed Air Method.) E. R., Dec. 30, 1911, Sept. 17, 1910; E. N., June 1, 1911.
- Grouting Big Savage Tunnel, Using Air. E. R., Dec. 23, 1911.
- Olive Bridge Dam. (Grout and Compressed Air). E. R., April 8, 1911.
- Grouting Arches, Hamburg, Germany. (Air Method.) E. R., Sept. 3, 1910.
- French Methods and Machines. (Air Methods.) E. R., Oct. 30, 1909.
- Grouting a Water-Bearing Rock Seam on Catskill Aqueduct. (Air Method.) E. N., Feb. 8, 1912.
- Mixing and Conveying Concrete by Compressed Air. E. N., Aug. 10, 1911.

- Lining and Grouting a French Railway Tunnel in Water-Bearing Material. E. N., Nov. 25, 1909.
- Pneumatic Concreting, Stockton Street Tunnel. E. R., July 4, 1914.
- Use of Gunite in Protection of Face of Levee. E. N., Oct. 8, 1914.
- A Compressed Air Concrete Mixer and Conveyer. E. N., Aug. 8, 1912.
- Mixing and Distributing Concrete by Compressed Air. *Railway Age Gazette*, March 18, 1914.
- A Concrete Tunnel-Lining Car with Pneumatic Mixer and Placer. E. N., March 26, 1914.
- Pneumatic Placer of Concrete. Internal Wear on Pipe Lines and Methods of Efficient Air Propulsion. E. R., May 23, 1914.
- Cement for Sea-Water Construction. *Cement Age*, Jan., 1907.
- Action of Sea-Water on Mortar. *Cement Age*, March, 1907.
- The Action of Sea-Water on Concrete. *Railway Age Gazette*, Nov. 8, 1907.
- The Effect of Alkali Soils on Concrete. E. N., July 23, 1908.
- The Effect of Alkali on Portland Cement. E. R., July 25, 1908.
- Destruction of Cement Mortar and Concrete by Alkali at Great Falls, Montana. E. C., June 24, 1908.
- Effect of Alkali on Concrete. T. A. S. C. E., Vols. LXV, LXVI, LXVII, and LXVIII.
- The Effect of Sea-Water, Alkali Water, and Sewage on Portland Cement, and Methods Used for Counteracting Same. E. C., July 20, 1910.
- What Are the Facts Respecting the Disintegration of Concrete by Sea-Water, Alkali Sewage, etc. E. C., June, 1910.
- Concrete Subjected to the Action of Water Containing Alkalies. P. A. R. E. A., Vol. XIV, 1914.
- Action of Sea-Water on Concrete. Results of Six-Year Tests of Twenty-three Moulded Piles of Various Mixtures, Submerged in Boston Harbor, and Withdrawn Periodically for Examination. E. R., March 21, 1914; E. C., May 6, 1914.
- Action of the Salts in Alkali Water and Sea Water on Cements. Technologic Papers of the Bureau of Standards, U. S. A., No. 12.
- Tests on the Permeability of Concrete. Bulletin of the University of Wisconsin, Vol. VI, No. 1.
- Permeability of Concrete Under High-Water Pressures. E. N., June 26, 1902.
- Impervious Concrete: An Informal Discussion. T. A. S. C. E., Vol. LI, 1903.
- Notes on Concrete Construction in Government Fortifications, with Waterproofing Data. E. N., April 2, 1903.
- The Permeability of Concrete and Methods of Waterproofing. E. N., Sept. 26, 1907.
- Permeability Tests of Concrete with the Addition of Hydrated Lime. E. R., June 27, 1908.
- Investigation of Impermeable Concrete by the Laboratory of the Board of Water Supply, New York City. E. C., Feb. 26, 1908.
- Tests of Alum and Soap Waterproofing. E. R., Oct. 9, 1909.

Making Concrete Waterproof: Alum and Soap Mixture. *Technograph*, 1909.

Oil-Mixed Concrete as a Waterproofing Material. E. N., Dec. 15, 1910.

Tests on the Permeability of Concrete. Commercial Compounds. *Wisconsin Engineer*, Feb., 1910.

Tests of the Absorptive and Permeable Properties of Portland Cement Mortars and Concretes, and Waterproofing Compounds and Methods. Technical Papers of the Bureau of Standards, U. S. A., No. 3, Aug. 22, 1911.

Waterproofing Concrete Structures on the C. B. & Q. Track Elevation, Chicago. *Railway Age Gazette*, Feb. 16, 1912.

Waterproofing Materials. Committee Report. P. A. S. T. M., Vols. IX, X, and XIII.

Waterproofing of Masonry. P. A. R. E. A., Vols. XI, XII, XIII, and XIV. Bibliography in Vol. XII, pp. 564-578.

Manufacture, Test, and Use of Waterproofing Fabric. E. N., Sept. 24, 1914.

Methods of Depositing Concrete Under Water. Committee Report, P. A. R. E. A., Vol. XIII.

Deep-Water Concreting Through a Tremie. E. R., Aug. 15, 1914.

Cement Surfaces (Pamphlet). Universal Portland Cement Company.

Concrete Surface Finish. *The Concrete Review*, Vol. IV, No. 1.

The Method of Finishing the Concrete Surfaces of Philadelphia Bridges. E. N., Feb. 4, 1904.

Concrete Surface: Various Methods of Finishing. *Cement*, Jan., 1907.

Painting Cement Surfaces. *Municipal Engineering*, Oct., 1908.

Specifications for Scrubbed Concrete Surface. E. N., Dec. 22, 1910.

Exterior Treatment of Concrete Surfaces. Committee Report to National Association of Cement Users. E. N., Sept. 15, 1910.

Ornamental Treatment of Concrete Surfaces. *American Architect*, Jan. 24, 1912.

## BOOKS FOR REFERENCE

Marble and Marble Working. A Handbook for Architects, Sculptors, etc. By W. G. Renwick. 226 pp.

Building Stones and Clays. Their Origin, Character, and Examination. By Edwin C. Eckel. 264 pp.

Building Stones. Stone Formation, Quarrying, and Blasting, etc. By Paul N. Hasluck. 96 pp.

Building Stones and Clay Products. A Handbook for Architects. By Heinrich Ries. 415 pp.

Stones for Building and Decoration. By George P. Merrill. 557 pp.

Report on the Compressive Strength, Specific Gravity, and Ratio of Absorption of Building Stones. By Q. A. Gilmore.

Modern Brick-Making. By Alfred B. Searle. 441 pp.

Vitrified Paving Brick. A Review of the Practice in Manufacture and Testing and Uses of Vitrified Paving Brick. By H. A. Wheeler. 121 pp.

Bricklaying System. By Frank B. Gilbreth. 321 pp.

- Practical Brick-work. By Paul N. Hasluck. 160 pp.
- Practical Bricklaying Self-Taught. Especially Designed for Home Study. By Fred. T. Hodgson. 281 pp.
- Twentieth-Century Bricklayer's and Mason's Assistant. By Fred. T. Hodgson. 311 pp.
- Bricklaying. Illustrated by over 200 engravings. By Owen B. Maginnis. 85 pp.
- Bricklaying and Brick Cutting. By H. W. Richards. 139 pp.
- Clays: Their Occurrence, Properties, and Uses, etc. By Heinrich Ries. 554 pp.
- History of the Clay-Working Industry in the United States. By Heinrich Ries and Henry Leighton. 270 pp.
- Practical Cement Testing. By W. Purves Taylor. 320 pp.
- Experimental Research Upon the Construction of Hydraulic Mortar. By H. Le Chatelier, translated by J. L. Mack. 128 pp.
- A Practical Treatise on Limes, Hydraulic Cements, and Mortars. By Q. A. Gilmore.
- Mortars, Plasters, Stuccos, Artificial Marbles, etc. By Fred. T. Hodgson. 520 pp.
- Building Mechanic's Ready Reference-Book. Cement workers and plasterers' edition. By H. G. Richey. 458 pp.
- Hydraulic Cement. Its Properties, Testing, and Use. By Frederick P. Spalding. 300 pp.
- Portland Cement. Its Manufacture, etc. By D. B. Butler. 458 pp.
- Cements, Limes, and Plasters: Their Materials, Manufacture, and Properties. By Edwin C. Eckel. 712 pp.
- Portland Cement. Its Composition, Raw Materials, Manufacture, and Properties. By Richard K. Meade. 512 pp.
- Calcareous Cements: Their Nature, Manufacture, and Uses, etc. By Gilbert R. Redgrave. 310 pp.
- Modern Manufacture of Portland Cement. By Percy C. H. West. 262 pp.
- Manual of Cement Testing, for the Use of Engineers, Chemists, etc. By Wm. A. Richards and Henry B. North. 137 pp.
- Popular Handbook for Cement and Concrete Users. By Myron H. Lewis and Albert H. Chandler. 430 pp.
- Treatise on the Inspection of Concrete Construction. By Jerome Cochran. 595 pp.
- Concrete System. By Frank B. Gilbreth. 182 pp.
- Concrete Construction, Methods, and Cost. By Halbert P. Gillette and Charles H. Hill. 690 pp.
- Practical Concrete Block Making. By Charles Palliser. 74 pp.
- Cement and How to Use It. By William A. Radford. 369 pp.
- Cement Houses and How to Build Them. By William A. Radford. 171 pp.
- Concrete and Reinforced Concrete Construction. By Homer A. Reid. 884 pp.
- Concrete Block Manufacture, Processes, and Machines. By Harmon H. Rice. 152 pp.
- Cement and Concrete. By Louis T. Sabin. 572 pp.

- Concrete Costs. By F. W. Taylor and Sanford E. Thompson. 700 pp.
- Treatise on Concrete, Plain and Reinforced. By F. W. Taylor and Sanford E. Thompson. 807 pp.
- Concrete from Sand Moulds. By A. A. Houghton. 145 pp.
- Ornamental Concrete Without Moulds. By A. A. Houghton. 132 pp.
- Concrete Floors and Sidewalks. By A. A. Houghton. 63 pp.
- Modern Cement Sidewalk Construction. By Charles Pallister. 64 pp.
- Concrete Blocks. Their Manufacture and Use in Building Construction. By H. H. Rice and Wm. M. Torrance. 125 pp.
- Concrete. Its Use in Building from Foundation to Finish. By T. Potter. 358 pp.
- Modern Methods of Waterproofing. By Myron H. Lewis. 44 pp.
- Prevention of Dampness in Buildings. (Translated from second edition, revised.) By A. W. Keim. 115 pp.
- Treatise on Masonry Construction. By Ira O. Baker. 745 pp.
- Practical Stone Masonry Self-Taught. By Fred. T. Hodgson. 305 pp.
- Masonry Construction. By Alfred E. Phillips and Austin T. Byrne. 128 pp.
- Building Mechanic's Ready Reference. (Stone and brick masons' edition.) By H. G. Richey. 255 pp.
- Modern Stone Cutting and Masonry. By John S. Siebert and Frederic C. Biggin. 47 pp.
- Masonry and Reinforced Concrete. By Walter A. Webb and W. Herbert Gibson. 444 pp.
- Materials of Construction. Part I. By Adelbert P. Mills.
- Practical Masonry. By W. R. Purchase, 226 pp.
- Engineering Geology. By Heinrich Ries and Thomas L. Watson.
- Building Superintendence. By T. M. Clark.
- American Civil Engineer's Pocket-Book. Mansfield Merriman, Editor-in-Chief.
- Civil Engineer's Pocket-book. By Albert I. Frye.
- The Civil Engineer's Pocket-Book. By John C. Trautwine.
- Architect's and Builder's Pocket-Book. By Frank E. Kidder.



# INDEX

- Absorption, *see* Granite, Limestone, etc.  
Absorption tests, 3  
Alkali, effect of, 119  
Arches, brick, 80  
    row-lock, 80  
Ashlar masonry, 61, 62, 63  
Axe, 20
- Back, 59  
Backing, 60  
Batter, 60  
Bond, 60, 64  
    English, 80  
    Flemish, 78  
    in brickwork, 78  
Brick, absorption, 44  
    arch or clinker, 42  
    body or cherry, 42  
    building, 33  
    burning, 36  
    cement, 46  
    clamp-kiln, 36  
    classification, 41  
    compass, 43  
    continuous, kiln, 39  
    cooling, 41  
    crushing strength, 43  
    down-draft kiln, 38  
    dry-clay machines, 34  
    drying, 34  
    face, 43  
    feather-edge, 43  
    fire, 43  
    fuel, 41  
    machine made, 42  
    machines, 33  
    manufacture, 33  
    masonry, 76  
    modern methods of mfg., 37  
    modulus of rupture, 43  
    moulding, 33
- Brick, ornamental, 45  
    paving, 43  
    pressed, 42  
    re-pressed, 42  
    requirements for good, 43  
    salmon or pale, 42  
    sand lime, 45  
    sanded, 42  
    sewer, 43  
    sizes, 45  
    slop, 42  
    soft-mud, 34, 42  
    stiff-mud, 34, 42  
    up-and-down-draft kiln, 38  
    up-draft kiln, 38
- Brick-work, cleaning, 83  
    crushing strength, 81  
    joints, 77  
    measurement, 83  
    safe compressive strength, 81  
    water-proofing, 83
- Bucket, drop bottom, 102  
Building blocks of concrete, 91  
Building stones, absorption, 3  
    axed or pean-hammered, 31  
    bush-hammered, 31  
    chemical tests, 6  
    classification, 28  
    crandalled, 30  
    crushing strength, 4  
    cut, 30  
    diamond panels, 32  
    drafted, 29  
    fine-pointed, 30  
    fire-resisting properties, 12  
    freezing tests, 5  
    microscopic tests, 6  
    natural, 1  
    physical properties, 11  
    pitch-faced, 29  
    power tools, 24  
    quarry-faced, 29

- Building stones, rocks used for, 2  
     rough-pointed, 30  
     rubbed, 32  
     specific gravity, 6  
     squared, 29  
     tools used, 20  
     tooth-axed, 31  
     unsquared, 28  
 Bush hammer, 22  
  
 Cavel, 20  
 Cement, fineness, 51  
     iron-ore, 52  
     magnesia, 52  
     manufacture of, 53  
     natural, 50  
     Portland, 51  
     Puzzolan, 52  
     specific gravity, 51  
     tensile strength, 51, 52  
     time of setting, 51, 52  
 Cement-gun, 109  
 Channeling machines, 14  
 Chart, 7  
 Chemical tests, 6  
 Chisels, 24  
 Clamps, 69  
 Coefficient of expansion, *see* Granite,  
     Limestone, etc.  
 Concrete, 87  
     alkali effect, 119  
     architectural, 93  
     brushed, 105  
     bush-hammered, 105  
     cement-gun, 109  
     constituents, 88  
     crushing strength, 120  
     depositing, 96  
     depositing under water, 102  
     fire-resisting properties, 120  
     forms, 110  
     joining old and new, 119  
     machines for mixing, 90  
     mass, 95  
     mixing, 89  
     mixing and depositing by com-  
         pressed air, 98  
     mixing in freezing weather, 101  
     Concrete, modulus of elasticity, 120  
         pebble surface, 107  
         physical properties, 120  
         plaster surface, 106  
         proportion of materials, 88  
         reinforced, 87  
         rubble, 112  
         sand-blasted surface, 107  
         spaded surface, 105, 107  
         surface finish, 95, 104, 105, 106,  
             107, 109  
         tests of permeable properties, 114  
         water-proofing, 113, 118  
         weight, 120  
     Concrete blocks, surface finish, 95  
     Concrete building blocks, 91  
     Coping, 60  
     Course, 60  
     Cramps, 60  
     Crandall, 22  
     Crow-bar, 13  
     Crushing strength, *see* Granite, Lime-  
         stone, etc.  
  
     Double-face hammer, 20  
     Dowels, 60, 69  
     Drill hammer, 13  
     Drills, machine, 14  
     Durability of rocks, 2  
  
     Efflorescence, 82  
     Explosives, *see* Quarrying  
  
     Face, 60  
     Face hammer, 20  
     Facing, 60  
     Filling, 60  
     Fire-resisting properties of building  
         stones, 12  
     Forms, for concrete, 110  
         wetting and oiling, 111  
     Freezing tests, 5  
  
     Glass seams, 7  
     Grab hooks, 69  
     Granite, 7  
         absorption, 8  
         coefficient of expansion, 8



- Granite, crushing strength, 8  
 modulus of elasticity, 8  
 modulus of rupture, 8  
 specific gravity, 8
- Gravel, 54  
 voids, 56
- Grout, 100
- Hand hammer, 22
- Header, 60
- Hollow terra-cotta, 46
- Hollow tile masonry, 84
- Joints, 60, *see* Quarrying  
 brickwork, 77  
 flush, 77  
 stone masonry, 70  
 struck, 77  
 weather, 78
- Kilns, *see* Brick and Lime
- Lewis, 69
- Lime, 48  
 burning, 50  
 fat, 48  
 hydrated, 48  
 paste in cement mortar, 57  
 paste or putty, 48  
 shaft kiln, 50  
 use, 50
- Limestone, 8  
 absorption, 9  
 coefficient of expansion, 9  
 compact, 9  
 crushing strength, 9  
 granular, 9  
 modulus of elasticity, 9  
 modulus of rupture, 9  
 specific gravity, 9
- Mallet, 22
- Masonry, Ashlar, 61  
 classification, 121  
 definitions, 59, 122  
 random, 61  
 rubble, 72  
 Stone, 64
- Masonry, broken range, 61  
 classification, 61  
 filling, 72  
 range, 60  
 squared, 71
- Mica, 7
- Microscopic tests, 6
- Modulus of elasticity, *see* Granite,  
 Limestone, etc.
- Modulus of rupture, *see* Granite,  
 Limestone, etc.
- Monolithic or mass concrete, 95
- Mortar, 56  
 brickwork, 77  
 colored, 58  
 joint, 71  
 lime, 57  
 lime paste and cement, 57  
 natural cement, 57  
 pointing, 58, 71  
 Portland, 57  
 water-tight, 58
- Patent hammer, 22
- Pean hammer, 20
- Pick, 13, 20
- Pitching chisel, 22
- Plaster blocks, 48
- Plug and feathers, 13, 24
- Pneumatic hammer, 25
- Pneumatic plug driller, 24
- Point, 22
- Pointing, 60, 70, 77
- Pyrite, 7
- Quarrying, 12  
 explosives, 12  
 hand tools, 13  
 joints, 12  
 machinery, 14
- Quoin, 60
- References to books, 153  
 to periodicals, 150
- Rip-rap, 73
- Rocks, argillaceous, 2  
 calcareous, 2  
 classification, 1

- Rocks, durability, 2, 3  
 igneous, 1  
 metamorphic, 1  
 plutonic, 1  
 sedimentary, 1  
 siliceous, 2  
 stratified, 1  
 volcanic, 1
- Rubble concrete, 112
- Sand, 53  
 testing, 54  
 voids, 56
- Sandstone, 10  
 absorption, 10  
 coefficient of expansion, 10  
 crushing strength, 10  
 modulus of elasticity, 10  
 modulus of rupture, 10  
 specific gravity, 10
- Sea water, effect on concrete, 119
- Slate, 10  
 absorption, 11  
 coefficient of expansion, 11  
 colors, 10  
 crushing strength, 11  
 modulus of elasticity, 11  
 modulus of rupture, 11  
 specific gravity, 11
- Slope-wall masonry, 73
- Soft-mud, stiff-mud, etc., *see* Brick
- Specifications, arch masonry, 131  
 bridge and retaining wall-masonry, 129  
 building brick, 138  
 Specifications, cement, 144  
 culvert masonry, 132  
 dry masonry, 133  
 lime, 141  
 plain concrete, 133  
 sand, 143  
 stone masonry, 127
- Specific gravity of building stones, 6
- Splitting chisel, 24
- Stone masonry, cleaning, 75  
 measurement, 74  
 paving, 73  
 setting, 66  
 strength of, 73  
 water-proofing, 75
- Stones, dimensions of, 66
- Strength of building stones, 4  
 of stone masonry, 73
- Stretcher, 60
- Surface finish, concrete blocks, 95  
 concrete, 95, 104, 105, 106, 107,  
 109
- Surfacing machines, 25
- Sylvester's washes, 82
- Terra-cotta or tile, 46  
 crushing strength, 48
- Ties for forms, 111
- Tools, *see* Quarrying
- Tooth axe, 22  
 chisel, 24
- Tremie, 103
- Water-proofing, 75, 83, 113, 118
- Wedge, 13









width  
150 m

THIS BOOK IS DUE ON THE LAST DATE  
STAMPED BELOW

AN INITIAL FINE OF 25 CENTS  
WILL BE ASSESSED FOR FAILURE TO RETURN  
THIS BOOK ON THE DATE DUE. THE PENALTY  
WILL INCREASE TO 50 CENTS ON THE FOURTH  
DAY AND TO \$1.00 ON THE SEVENTH DAY  
OVERDUE.

DEC 11 1932

APR 19 1934

MAY 7 1938

APR 1 1941

28 Oct 1946

OCT 3 1946

MAR 2 1955 LD

AUG 25 1956

REC'D LD

AUG 14 1956

12 NOV 1953

REC'D LD

NOV 11 1959

FEB 29 1996

RECEIVED

MAR 05 1996

CIRCULAR DEPT.

LD 21-50m-8-32





C056069318

TAC 70  
HC 308521.

UNIVERSITY OF CALIFORNIA LIBRARY

