

UNIVERSITY OF CALIFORNIA
DEPARTMENT OF CIVIL ENGINEERING
BERKELEY, CALIFORNIA

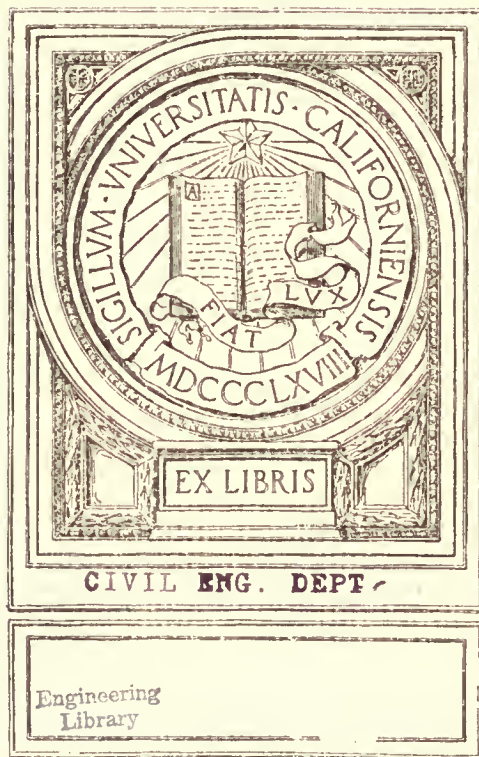

UNIVERSITY OF CALIFORNIA
DEPARTMENT OF CIVIL ENGINEERING
BERKELEY, CALIFORNIA

Material Handling Cyclopedia

A REFERENCE BOOK

C o v e r i n g

Definitions, Descriptions, Illustrations and Methods of
Use of Material Handling Machines
Employed In Industry

Compiled and Edited by

ROY V. WRIGHT, Editor-in-Chief

Managing Editor, Railway Age, and Editor of the Railway Mechanical Engineer, Car
Builders' Dictionary and Cyclopedia, and Locomotive
Dictionary and Cyclopedia

JOHN G. LITTLE, Managing Editor

Formerly Eastern Engineering Editor of the Railway Age
and

ROBERT C. AUGUR, Associate Editor

Contributing Editors

CHARLES N. WINTER

W. T. SPIVEY

PROF. E. F. CHURCH

FLOYD T. SMITH

HENRY J. EDSALL

DR. A. A. ADLER

P. R. HOOPES

PUBLISHED BY

SIMMONS-BOARDMAN PUBLISHING CO.

WOOLWORTH BUILDING, NEW YORK, N. Y.

Transportation Bldg.
Chicago, Ill.

34 Victoria St., Westminster
S. W. 1, London, England

Home Life Bldg.
Washington, D. C.

444 Maison Blanche Annex
New Orleans, La.

The Arcade
Cleveland, Ohio

First National Bank Bldg.
Cincinnati, Ohio

TJ 1350

M3

Engineering
Library

TO AMM
UNIVERSITY

Eng Dept.

Preface

This volume is designed to present in a comprehensive way, definitions, descriptions, illustrations, applications and methods of operation of the devices and equipment used in industry for the handling of materials. It is divided into three principal sections: Definition Section, Illustrated Text Section and Catalog Section.

The Definition Section is arranged in alphabetical order and in it are defined the devices, accessories and terms used in material handling. The Illustrated Text Section is subdivided into eight major divisions: Hoisting Machinery; Package Handling Conveyors and Elevators; Loose Material Conveyors and Elevators; Conveying Machinery Details; Elevators; Trackless Transportation; Industrial Rail Transportation and Handling Systems. The Catalog Section contains detailed information on specific devices and is designed to supplement the information shown elsewhere and, as well, to help the reader select from a class, the device best suited to his needs.

The compilation of the volume was undertaken by the editors in response to the expressed need of such a work by engineers, manufacturers of handling equipment and others interested in the handling of materials. At the beginning of the task it was realized that the field to be covered was so broad that the work could not be attempted by any single person or small group of individuals. Consequently, each of the major sections of the volume has been prepared by a specialist, particularly fitted by experience for the work undertaken. The Cyclopedia, in its completed form, is the work of eleven specialists and each contributor is to be considered responsible for the accuracy of the information presented in his section.

To insure greater accuracy and a broader treatment, a large part of the information presented has been submitted by the editors to other specialists for suggestions. The cooperation thus received, as well as the generous cooperation given by manufacturers of equipment, in furnishing detailed information and illustrations of their products, proved extremely valuable. In expressing appreciation of this cooperation the editors regret, because of the great number of individuals concerned, their inability of making this acknowledgment specific.

Acknowledgment and thanks for the continued inspiration and constructive assistance given by Fred R. Davis of the General Electric Company and Zenas W. Carter, formerly secretary-manager of the Material Handling Machinery Manufacturers' Association, now of the Austin Machinery Corporation, are gratefully rendered.

COPYRIGHT
SIMMONS-BOARDMAN PUBLISHING COMPANY
1921

To the Users of this Book

In the preparation of the MATERIAL HANDLING CYCLOPEDIA there have been two principal objectives: First, to present the information in easily understood terms and, second, to so arrange the text that the reader might be able to find the information he requires without loss of time.

To accomplish the second objective it was thought necessary to subdivide the editorial matter into two principal parts: A Definition Section and an Illustrated Text Section. Both of these sections have been further subdivided; the Definition Section into two parts—General Definitions and Electrical Definitions—thus making it possible to arrange the major portion of the definitions in alphabetical order and at the same time preserve a logical continuity in the treatment of electrical subjects.

The Illustrated Text is subdivided into eight principal sections: Hoisting Machinery; Package Handling Conveyors and Elevators; Loose Material Conveyors and Elevators; Conveying Machinery Details; Elevators; Trackless Transportation; Industrial Rail Transportation and Handling Systems. These subdivisions appear in the order named and each is further divided into sections corresponding with what was thought by the editors to be the logical classification of the great number of devices properly grouped under each major subdivision.

In addition to its purpose as a dictionary of material handling terms and devices the Definition Section serves also as an index to both the Illustrated Text Section and the Catalog Section. Following the definition of each device, term or subject which is treated in the other sections of the book, direct references are given to the Illustrated Text Section page, Catalog Section page, or both, where the further information appears. In using the volume the reader is thus referred from the definition to the Illustrated Text Section where the application, illustration and method of use of the device in question is covered in detail and, as well, to the page or pages in the Catalog Section where technical descriptions and illustrations of the device are presented by the manufacturers.

As a further aid in making the information readily available a General Index covering every subject treated in the Illustrated Text Sec-

tion appears on the pages next following this one. The general headings of this index correspond with the principal subdivisions of the Illustrated Text and the sub-headings with the classification of devices mentioned previously. The General Index thus provides a convenient reference to particular devices in any group.

To furnish further guidance to readers particularly interested in the information presented in the Catalog pages three indexes appear on the pages following the Catalog Section. These are: (1) An Alphabetical Index of Catalogs, (2) a Directory of Products and (3) a Trade Name Index.

In the Alphabetical Index is given a list of the firms represented in the Catalog Section and the numbers of the catalog page on which their products are described.

In the Directory of Products is given a list, alphabetically arranged, of the products of the firms whose catalogs appear in the Catalog Section.

In the Trade Name Index, are listed, in alphabetical order, the trade names of the various products shown in the Catalog Section. The name of the manufacturer of each product appears after each Trade Name.

General Subject Index

Definition Section

	Page		Page
General Definitions	9	Electrical Definitions	127

Hoisting Machinery

Cranes

Overhead Traveling Cranes: Construction.....	155
Code of Safety Standards.....	158
Hand Power Cranes.....	159, 773, 777, 778, 780
Power Operated Overhead Cranes: Floor-Controlled; Cab-Controlled; Outdoor; Foundry; Mill; Ladle; Charging; Stripping; Wall	161, 773, 781, 791, 793, 794, 795, 796, 797, 800
Gantry Cranes: Traveling; Stationary	167, 794, 797, 798, 828
Jib Cranes: Bracket; Column; Braced; Steam-Hydraulic	171, 780
Pillar Cranes	175
Pillar-Jib Cranes: Portable; Counterweight; Work-Car; Skeleton; Stacking; Walking....	175
Locomotive Cranes: Construction; Steam; Gasoline; Electric; Wrecking; Pile-Driver	179, 804, 805, 806
Wharf Cranes: Portal; Semi-Portal; Racking-Cantilever; Raised; Barge; Roof; Rotary	191, 797, 802
Shipbuilding Cranes: Hammerhead; Turntable; Folding-Jib; Revolving-Tower	197

Hoists

Chain Hoists.....	203, 774, 775, 776, 778, 800
Pneumatic Hoists	207
Electric-Motor Hoists..	211, 776, 781, 782, 784, 788, 800
Monorail Hoists and Telphers	213, 784, 786, 789, 792, 794, 800, 804

Derricks

Stationary Derricks: Guy; Stiff-Leg; Tower	219, 802, 803
Portable and Traveling Derricks: Floating; Car; Traveling; Pile-Driver; Jinniwink; Skid..	221, 802
Light Capacity Derricks: Counterweight; Pole; Gin-Pole; Breast; Tripod; Sulky; A-Frame; Mast and Gaff; Shear-Leg.....	227
Derrick Details	229
Cargo Handling Gear	231

Excavating Machines

Power Shovels: Railroad Steam Shovel; Revolving; Skimmer; Ditching Machine.....	235, 806
Drag Line Excavators.....	239, 801, 817, 833
Trenching Machines: Bucket; Wheel.....	239
Back-Filler	241
Dredges: Dipper; Placer; Hydraulic.....	241, 801

Cableways

Suspension Cableways: Endless-Rope; Rocking; Single-Rope; Dragline Scraper; Power Scraper; Cable Drag-Scraper	247, 815, 817, 821, 823, 824
Cable Tramways: Two-Bucket; Single-Bucket; Double-Cable; Stacking; Suspended-Rail; Cables; Carriers; Grips; Stations....	263, 821, 823

Loaders and Unloaders

Log Loaders and Skidders.....	273
Box Car Loaders: Conveyor; Projecting; Tilting	273
Box Car Unloaders: Scraper; Suction; Tilting..	277
Car Dumpers: Cane-Car Dumpers; Tandem Car-Dumpers.....	279, 825, 828
Hulett Unloader	283
Towers: Boston; One-Man.....	283, 828, 831
Mast and Gaff	286
Self-Loading Vessels	286

Trolleys and Carriers

Crane Trolleys: Trucks; Drums; Motors; Brakes	287, 756
---	----------

Overhead Trackage

Track; Switches; Turntables...291, 773, 778, 782, 790

Winches

Hand and Power	295, 787, 790, 803, 829
----------------------	-------------------------

GENERAL SUBJECT INDEX

Hoisting Machinery—Continued

	Page		Page
Accessories		Plain Buckets; Baskets; Nets.....	313
Grab Buckets: Clam-Shell; Motor; Orange-Peel; Dwarf Orange-Peel; Scraper 301, 808, 809, 810, 812, 813, 814, 816, 829		Skips; Cinch-Boards	313
Drag Line Buckets.....	309	Grapples; Hooks; Tongs; Slings.....	313
Self-Dumping Buckets: Turn-over; Bottom-Dump; Controllable Discharge; Bulk-Discharge	309	Counterweight Drums	315
		Lifting Magnets	315, 807
		Blocks	318
		Wire Rope	320

Package Handling Conveyors

Arm Elevators	331, 761, 765, 766	Gravity Roller Spirals.....	387, 759, 761, 765
Suspended Tray Elevators	336, 761, 765, 766	Spiral Chutes	390, 759, 761, 765, 767
Push-Bar Elevators and Conveyors.....	345	Special Elevators and Conveyors: Haulage; Overhead Track; Special Chain; Assembly; Sling; Live-Roll; Wire-Line; Pneumatic Tube; Carrousel	399, 762, 763, 772
Apron Elevators and Conveyors 352, 761, 765, 766, 768, 770, 799, 826			
Belt Conveyors and Elevators.....	369, 759, 761, 766		
Gravity Roller Conveyors.....	378, 759, 761, 765, 767		

Loose Material Conveyors

Bucket Elevators: Centrifugal Discharge; Perfect Discharge; Continuous Bucket.....	409, 826	Conveyors: Belt; Apron and Pan; Screw or Spiral; Flight and Drag; Reciprocating Trough and Flight.....	418, 770, 773, 826, 834
Elevators-Conveyors: Gravity Discharge V-Bucket; Pivoted Bucket Carriers 413, 828, 830, 836		Current Conveyors: Steam Jet; Pneumatic.....	430
		Loaders Portable: Bucket; Belt 432, 769, 770, 773, 837, 838, 840	

Conveying Machinery Details

Aprons; Arms	443	Gravity Roller Conveyors.....	454
Bearing Boxes; Belts; Boots; Brushes; Buckets.	445	Idlers	456
Cable Conveyors; Carriers; Chains; Chain Attachments	448	Pulleys; Push Bars.....	457
Drives	452	Releases	457
Flights	453	Screw Conveyors; Spiral Chutes; Sprockets; Stops	458
		Take-Ups; Tighteners; Trays; Troughs.....	462

Elevators

Development of the Elevator.....	467	Pneumatic Elevators	491
Factors of the Elevator Problem.....	468	Hand Power Elevators	491
Electric Elevators: Motors; Winding Engine; Control	477, 751, 754, 757	Portable Elevators	492, 770
Hydraulic Elevators	489	Elevator Details	493
Steam-Hydraulic Elevators	491	Elevator Installations	494
		Code of Safety Standards.....	495

GENERAL SUBJECT INDEX

Trackless Transportation

	Page		Page
Industrial Trucks, Tractors and Trailers		Platforms, Containers and Accessories; Skid	
Hand Trucks: Box; Baggage; Single-Handle;		Platforms; Live Platforms; Shop Boxes.	537, 746
Barrow; Push Cart; Large Wheel Cart;		Typical Methods of Moving Material.....	540
Stevedore; Platform; Lift	519	Factors Determining the Choice of Tractors.....	544
Storage Battery Trucks; Platform; Low-Plat-			
form; Elevating-Platform; Tiering; Baggage;			
Crane; Dump Body			
524, 726, 728, 730, 732, 733, 739, 741, 743, 744, 745			
Gasoline Engine Trucks: Cargo; Platform;			
Dump Body	527		
Storage Battery Tractors: Three-Wheel; Four-			
Wheel; Center Control			
530, 728, 733, 734, 739, 741, 743, 744, 745			
Gasoline Engine Tractors: Three-Wheel; Four-			
Wheel; Track-laying	531, 704		
Trailers: Four-Wheel Steer; Caster; Fifth-			
Wheel; Balanced; Baggage; Low Platform;			
Dump Body; Box.....	535, 729, 735, 739, 744		
		Motor Trucks, Tractors and Trailers	
		General Specifications: Frames; Wheels; Axles;	
		Drive; Transmission; Steering Gears;	
		Clutches; Engines	549
		Principles of Motor Selection.....	562
		Factors of Motor Truck Performance.....	563
		Motor Truck Applications.....	568
		Demountable Bodies	574
		Truck-Tractors	574
		Trailers: Four-Wheel; Two-Wheel; Semi-Trail-	
		ers; Pole	577

Industrial Rail Transportation

<p style="text-align: center;">Classes of Railways</p> <p>Inter-plant; Heavy Mill; Mine; Logging; Planta-</p> <p>tion; Long Sidings; Construction; Portable;</p> <p>Cable; Automatic; Inclined; Rack; Skip</p> <p>Hoists583, 826, 827, 830, 831, 832</p> <p style="text-align: center;">Industrial Cars</p> <p>Platform; V-Body Dump; Scoop-Body; Charg-</p> <p>ing; Square-Body Rotary Dump; Box-Body</p> <p>Dump; Hopper Bottom; Cable Bottom; In-</p> <p>clined Bottom; Creosoting; Charcoal; Ace-</p> <p>tone; Logging and Lumber; Cane and</p> <p>Plantation; Dryer; Car Transfers; Ore Mine;</p>	<p>Coal Mine; Mill; Ladle; Foundry; Self-Pro-</p> <p>pped; Larries; Skip..587, 721, 722, 725, 831, 833</p> <p style="text-align: center;">Industrial Locomotives</p> <p>Steam Locomotives; Geared; Fireless...623, 720, 721</p> <p>Compressed Air Locomotives.....627, 720</p> <p>Combustion Engine Locomotives: Gasoline;</p> <p> Kerosene</p> <p> 627, 724</p> <p>Electric Locomotives: Trolley and Third Rail;</p> <p> Storage Battery</p> <p> 627, 715, 718, 731</p> <p>Rack Locomotives</p> <p> 627</p> <p style="text-align: center;">Track</p> <p>Detail Devices</p> <p> 629, 721, 722, 725, 831</p>
--	---

Handling Systems

<p style="text-align: center;">Handling and Storing Coal</p> <p>Preparation Plants for Coal..... 635</p> <p>Large Central Coal Storage Plants..... 643</p> <p>Coal and Ash Handling Equipment for Boiler</p> <p> Houses</p> <p> 653</p> <p> Equipment for Large Central Power Stations 655</p> <p> Small and Moderate Sized Boiler House</p> <p> Equipment</p> <p> 657</p> <p> Reserve Coal Storage..... 661</p> <p> Bins and Bunkers..... 667</p> <p> Weighing Coal</p> <p> 668</p>	<p>Coal Yard Equipment..... 669</p> <p>Locomotive Coaling Stations..... 673</p> <p>Equipment for Coaling Steamships and Loading</p> <p> Coal to Vessels</p> <p> 675</p> <p style="text-align: center;">Sand and Gravel Washing Plants</p> <p>Sand and Gravel Washing Plants..... 679</p> <p style="text-align: center;">Stone and Lime Handling</p> <p>Stone and Lime Handling</p> <p> 683</p>
---	---

Catalog Section

Catalog Section	701
-----------------------	-----

DEFINITION SECTION

A Dictionary Covering the Devices, Accessories, and
Terms Used in Material Handling

By

E. F. CHURCH, JR.

Head of Mechanical Engineering Department Polytechnic Institute, Brooklyn, N. Y.
Associate Member, American Society Naval Engineers; Associate, Society of
Automotive Engineers; Member, American Society Mechanical Engineers

Assisted on Electrical Definitions

By

P. A. CUSHMAN

Assistant Professor Mechanical Engineering, Polytechnic Institute, Brooklyn, N. Y.

Definition Section

Accumulator, Hydraulic. A storage tank for water under heavy pressure, used in hydraulic power operations. It consists of a heavily weighted plunger in a cylinder, or a heavily weighted cylinder moving up and down on the plunger, the varying space in the cylinder constituting the storage reservoir.

Aerial Cableway. An aerial conveying installation consisting of a single or double track cable stretched between two towers, a carriage traveling on the track cable, ropes for hoisting the load and controlling the position of the carriage on the cable and operating machinery, generally located in one of the towers. If used for conveying only, it is called a transporting or conveying cableway, and is equivalent to a cable tramway of a single span. If used for hoisting and conveying, it is often called a hoisting transporting cableway, and is commonly used for construction work on dams and bridges, or for the handling of bulk material in storage plants.

The towers may be fixed, rocking or traveling; one may move on a circular track about the other, called a radial cableway; they may be at the same or different elevations. Under certain conditions the cableway may be made self-operative, but power is always required if hoisting is to be done.

Also called a suspension cableway. Cableways are distinguished from cable tramways by the fact that no hoisting is done by the latter, and that they consist of many spans over long distances, and are usually permanent installations.

Page 247, 815, 817, 821, 823.

Aerial Cableway, Dredging. An aerial cableway equipped for handling a grab bucket suitable for excavating submerged material. The towers usually travel parallel to the water, and a three-drum winch is required.

Page 817.

Aerial Cableway, Grab Bucket Handling. An aerial cableway arranged for the operation of a self-filling grab bucket. The bucket is lowered, open, into the material to be excavated or moved; winding of the hoisting rope causes it to close, filling its bowl as it does so. Continued hoisting raises it to or near the track cable; the carriage is then moved with the bucket until the discharge point is reached, when the bucket may be opened in mid air, or may be lowered until in contact with the pile before dumping.

Page 815.

Aerial Cableway, Gravity Transporting. An aerial transporting cableway in which the track cable has sufficient slope to cause the carriage to move down by gravity.

Page 821, 823.

Aerial Cableway, Hoisting-transporting. An aerial cableway which hoists, conveys and lowers material, moving it from one point to another beneath its elevated track cable. The points at which hoisting or lowering take place may be dependent on the position of adjustable

stops which are moved in accordance with the needs of the work.

A hoisting rope operated by a winch drum in one of the towers is led around a tower sheave to the carriage which moves along the track cable under the control of a traction rope. In the carriage, an arrangement of the hoisting rope around sheaves provides an increase of lifting power for handling the load hanging from the load hook of the fall block beneath.

Page 815, 817, 821, 823.

Aerial Cableway, Horizontal. The term applied to a cableway which has its ends at the same height, or which has so little difference in elevation between them that the carriage will not move by gravity. A power driven endless traction rope is generally used in such cases, though a tail rope may be led around guide sheaves to a counterweight in such a way as to assist the force of gravity on low grades.

Page 249, 815, 817, 821, 823.

Aerial Cableway, Inclined. A general term applied to an aerial cableway in which the two ends of the track cable have a sufficient difference in elevation to produce a slope of 20 per cent or more, down which loaded or unloaded carriages will move by gravity. Also called a gravity transporting cableway.

Page 815, 817, 821, 823.

Aerial Cableway, Radial. An aerial cableway having one traveling tower which may move on the arc of a circle at the center of which the other tower is located. A large storage area may thus be covered. The moving tower has a broad base and is loaded to prevent upsetting. The fixed tower may be pivoted, or may have merely a pivoted cap. It must be guyed in several directions to resist the corresponding pulls of the movable track cable, unless it is made self-supporting. Power is generally supplied to the cableway at the pivot tower, and the traveling tower may be moved along its track by power supplied from a winch drum at the pivot tower.

Page 815.

Aerial Cableway, Rocking. A cableway which is supported on two towers that can be rocked transversely in unison, thus moving the conveying cable from side to side and enabling material to be stored over a considerable area, or, when the carriage is equipped with a grab bucket, allowing it to be recovered directly from this area and delivered to any point within it. The towers have rocker bases and are controlled in position by rocking winches; main anchorages located on the axis of rotation remain taut whatever the position of the towers.

Page 249, 824.

Aerial Cableway, Transporting. An aerial cableway which merely transports or conveys material, as opposed to one which hoists, conveys and lowers. The loads are placed in a bucket or on a platform or skip, and are usually removed by dumping. In this respect a transport-

ing cableway is merely a cable tramway of a single span.

Page 247, 815, 817, 821, 823.

Aerial Cableway, Traveling. An aerial cableway having its two supporting towers mounted on wheeled bases which can move along parallel tracks. This enables the cableway to serve the whole of a rectangular area, rather than to limit it to a narrow area immediately beneath the track cable.

Aerial Wire Rope Tramway. A system of aerial conveying by which material is carried in buckets on a cable supported on a series of elevated towers, and passing for distances amounting sometimes to many miles over land, rivers, valleys and mountains. The loading and discharge stations are usually at opposite ends of the line, though discharge may be easily arranged at intermediate points, and some installations carry material in both directions. Two systems are in use; the single cable, in which the buckets are fixed to the cable and travel with it, and the double cable, in which one stationary rope supports the buckets and the other propels them. Either type may have any number of buckets; two special cases of the double cable system are called double bucket and single bucket installations; both are termed reversible.

Page 263, 815, 817, 821, 823.

Aerial Wire Rope Tramway Carrier. A truck composed of two steel sheave wheels mounted between steel side plates, and having a pendant frame attached to it, between the lower extremities of which is pivoted a turnover bucket. For extremely heavy loads two two-wheel trucks support an equalizing bar from which the bucket is suspended, thus dividing the load among four wheels.

Beside the dumping bucket for carrying bulk material other forms of carriers are also in use, for conveying bales, barrels, logs, cordwood, etc., each built especially for the material handled.

At the stations the carriers run from the cable on to fixed overhead track sometimes called shunt rails, and stay on these until sent out on the line again. Switches may be arranged, on which reserve buckets are held, and overhead rails also may be used for running buckets short distances away from the cable terminal, for collecting material, discharging to distributed locations, etc.

Page 267, 821, 823.

Aerial Wire Rope Tramway, Double Bucket. A reversible aerial double rope tramway consisting of two parallel track cables on which a pair of carriers and buckets are operated, by means of a reversible endless traction rope. The two buckets are attached at opposite sides of the traction rope loop so that they occupy the loading and the discharge stations at the ends of the line simultaneously, and always move in opposite directions. If the loaded buckets travel down a sufficient grade, the system is self-operative and requires no power; it is then often called a jig-back tramway.

Also called a twin line tramway.

Page 269, 821, 823.

Aerial Wire Rope Tramway, Single Bucket. A reversible aerial double rope tramway consisting of one track rope on which a carrier and bucket are pulled back and forth by a reversible endless traction rope, or, lowered down a grade by gravity and pulled back up to the loading station by power. It may be operated by one man at the loading station, the discharge being automatic.

Page 271, 821, 823.

Aerial Wire Rope Tramway Stations. The terminal structures and any intermediate supports, other than the ordinary towers supporting the line, of an aerial wire rope tramway. These include two terminal stations known as loading and discharge stations, also rail stations, tension stations and angle stations.

Page 269.

Air, Compressed. Compressed air may be considered as a system of power transmission, analogous to the generator, distributing system and motors of an electrical power transmission system, the air compressor corresponding to the generator, the piping to the wiring, and the air motors, hoists, etc., to the electric motor. Its efficiency falls so much below the electric system that it is seldom used solely for the transmission of mechanical power to a distant point, but is of great value in cases where air is required for the special purposes to which it is peculiarly suited, as in pneumatic tube conveying systems; conveying of fine materials like grain, sawdust and other manufacturing refuse; cleaning castings; pneumatic riveting; chipping and drilling; spraying, etc. It is also much used for handling liquids which cannot be moved by piston or centrifugal pumps because of their corrosive or clogging action, by exerting an air pressure on the liquid in a closed tank by pumping in compressed air, or by using an air lift pump. Where installed primarily for these special purposes, it may be utilized effectively for power development in addition, especially for hoists and even for elevators. Compressed air machinery is simple, cheap and usually easily operated; occasionally, as in mines, the exhaust is of use for ventilation, though the amount is really too small to be of importance. The total absence of any heat or possibility of sparks renders it preferable to steam and electricity in locations where combustible gases or explosives are present.

The power required to compress air is reduced if the air is kept from rising in temperature during compression. Water jacketing accomplishes this to a certain extent, but a more effective method is to use multi-stage compression, with thorough intercooling between the stages.

When compressed air is used to drive engines, tools, etc., the temperature is lowered considerably during the expansion in the working cylinder, and may go below 32 deg.; any water present will then freeze and gradually clog the passages. Water must therefore be thoroughly eliminated, or the air must be heated sufficiently before using it to insure its remaining above the freezing point. Such heating will also increase the efficiency of the system.

Low air pressures are usually expressed in inches of water, as would be measured by an U-tube with one leg connected to the discharge side of the compressor. Higher pressures, up to one pound, are expressed in ounces per sq. in., and still higher pressures in lb. per sq. in.

Air Compressor. Any machine or device which will continuously take in air at a low pressure and deliver it at a higher pressure. Compressors are classed as piston, centrifugal, rotary and hydraulic, according to the kind of power used; those in the first three classes may be designated as steam engine, internal combustion engine, (gas, gasoline or oil), electric motor or belt driven. Low pressure centrifugal compressors are commonly called fans or blowers; low pressure piston compressors (in large sizes, as used for blast furnaces) are termed blowing engines or blowers.

Cooling is an essential part of the mechanical compressing of air, as a large part of the power supplied appears as heat. For low pressures and small sizes, radiation is relied on to carry away enough heat to maintain a satisfactory working temperature. For high pressures in all medium and large sized compressors, water jacketing of metal parts exposed to the heat is arranged, and the compression is broken up into two or more stages with intercoolers between them, this being an especially effective method of cooling.

Air Compressor Aftercooler. In compressed air plants, the water cooled receiver through which the hot compressed air from the compressor passes before going into the distribution pipes. Aftercooling decreases the volume of the air so that smaller pipes can be used, precipitates much of the moisture which causes serious trouble in machines operated by compressed air, and also carries down much of the oil vapor with this water precipitation.

For the construction of Aftercoolers, see Intercooler.

Air Compressor, Centrifugal. A machine for compressing air by giving it a whirling motion through a rotating fan or impeller, and utilizing the centrifugal force thus created to make the air flow against a pressure. The impeller is mounted on a shaft and rotates within a casing; the air is admitted at or near the shaft, flows among blades or vanes on the impeller, and outward from their tips into the casing; fixed discharge vanes are often mounted in the casing around the impeller to aid in changing the kinetic energy of the air into pressure without its dissipation into heat through eddying.

Centrifugal compressors for pressures below one pound are usually known as blowers or fans. For pressures above five pounds, two or more impellers in series may be used, the discharge of the first stage leading to the intake of the second, etc.; these are known as multi-stage centrifugal compressors.

Centrifugal compressors require little space, may be coupled direct to high-speed driving units like steam turbines or motors, cause little or no vibration, have no reciprocating parts, valves or springs, and require a minimum of oiling and other care. They will not, however, deliver a constant quantity of air when running at constant speed under a varying resistance, and they also cause unpleasant throbbing or pulsations.

Centrifugal air compressors are most used where medium pressures are required, as for blast and other furnace blowing, pneumatic tube transportation, conveying of grain, coal, etc. They also find efficient application as first stage compressors where the second stage of compression is performed by a piston type compressor, enabling a large reduction to be made in the size of the latter.

They are cooled by radiation from the casing, by water circulating through diaphragms between the stages of a multi-stage machine, or by intercoolers between groups of stages.

Air Compressor, Hydraulic. A compressor which utilizes a head of flowing water for compressing air. Two vertical shafts are connected by a tunnel at their bottoms. Water flowing down one of these is allowed to suck air and carry it down to the horizontal tunnel; there it separates from the water, which passes on and up the other shaft. The air is led from the separation chamber to the surface by pipes. Sufficient head of water must be available to produce the desired quantity of flow, and to make up for the difference in density of the air laden descend-

ing stream and the ascending stream which has been freed of air.

Air Compressor Intercooler. In multi-stage air compressor plants, the water-cooled receiver through which the hot compressed air from one stage of the compressor is passed before going into the next stage for further compression. There are two reasons for using an intercooler; first, to keep the temperature low enough so that the cylinders can be properly lubricated, and second, to decrease the power required for compression.

Intercoolers are usually made with a shell of cylindrical or rectangular section, containing a bank of tubes whose ends fit tightly into two tube sheets. Chambers outside these tube sheets form a space for the entrance and exit of the cooling water, which makes from two to four passes through the tubes. The air to be cooled fills the space between the tube sheets among the tubes, and is made to pass back and forth across the tubes several times by suitably arranged baffle plates.

The usual construction is to bolt the two tube sheets to flanges on the ends of the shell; the greater expansion of the tubes than the shell, due to their higher temperature and higher coefficient of expansion, may make them leak. The back tube sheet may have a water chamber bolted to it, and be loose within the shell, thus allowing free expansion of the tube bank independently of the shell. This is called a floating head.

Tubes are made of brass of various grades or of aluminum; the latter possess greater heat conductivity.

Air Compressor, Piston Type. A machine consisting of a cylinder with a piston moving back and forth in it, drawing air into one end of the cylinder during motion in one direction, and compressing it during the return movement. Compressors are usually single-acting in small sizes, and double-acting in the large sizes. They are driven by steam engines, by gas, gasoline or oil engines, by electric motors, or by belts from line shafting. Many different varieties have been developed because of the varied requirements as to discharge pressure, capacity, economy of power, cost, speed of driving unit, weight and floor space.

Pressures up to 50 lb. per sq. in. are generally obtained in a single-stage; pressures above 100 lb. are obtained much more economically by two-stage compression with an intercooler between the two stages. For pressures above 200 lb., three stages with two intercoolers should be used.

Various arrangements of cylinders are in use; one with cylinders in line, or tandem, and another with cylinders side by side, or duplex, these being the two most common, and serving as a basis for the more complicated arrangements involving double or compound steam cylinders, double or two-stage air cylinders, and combinations of tandem and duplex arrangements.

Suitable regulation of air compressors is a very important matter. There is always some storage capacity in the shape of receivers on the discharge line, but if the demand for air falls off, the pressure will rise and air will be wasted by safety valves, unless the compressors cease to furnish air. Two methods of control are used; the first being to continually vary the speed of the compressor, keeping the discharge pressure as nearly constant as possible, and the second, to stop air compression entirely when the maximum pressure is reached, and wait until it has fallen a definite amount before delivering again. It is generally undesirable to stop the compressor completely, except in special cases where the demand is very intermittent, so it is slowed to the lowest prac-

ticable running speed at the same time that the device which controls the delivery of air, called the unloader, stops any compression of air.

An important detail of an air compressor is the air valve. In modern practice these are made of thin flexible steel plates, rings or strips, covering narrow ports. They are very strong and light, require little excess of pressure to lift them, and seat without slamming.

Air Compressor, Rotary. A machine in which air is compressed by one or more rotating impellers working in a casing, as distinguished from piston compressors. (See Air Compressor; Blower, Rotary.)

Air Compressor Unloader. The mechanism by which the delivery of air by a compressor is controlled. Several devices are in use, such as, first, closing of the intake pipe, so that no air is admitted to the cylinder; second, holding open admission valves so that air flows back and forth between the cylinder and intake; third, opening a by-pass between the discharge pipe and intake pipe, and "circulating" the air; and fourth, temporarily increasing the clearance volume. It is often combined with the governor controlling the speed of the driving engine.

In two-stage compressors, it is not enough to unload the low pressure cylinder, as the high pressure cylinder will speedily exhaust the air from the intercooler, and will then draw in air through stuffing box leaks and compress it with such a large compression ratio that the resulting high temperature may cause overheating or interfere with lubrication. This air may be discharged to the atmosphere by a special mechanism of the unloader, thus preventing the high compression, and allowing the piston to reciprocate in a partial vacuum.

Air Cylinder Hoist. See Hoist, Air Cylinder.

Air Hoist. See Hoist, Air; Hoist, Air Cylinder.

Air Lift Pump. A system of lifting liquids by the direct use of compressed air. As applied to water wells, a drop pipe is placed in the well with its lower end below the level of the water. An air line delivers air to the bottom of the drop pipe, and, mixing air with the water in the latter, makes it so much lighter than the solid water in the space surrounding the drop pipe that the water rises in the drop pipe, and, if the proportions are correct, reaches the surface, where the air can be separated from the water.

The efficiency is relatively low, but the first cost is also low. All machinery may be located at the top of the well, and it will handle gritty, dirty or chemically active waters as easily as clean water.

Air Receiver or Reservoir. A strong reservoir, generally a cylindrical steel tank, into which the discharge line of an air compressor leads, and which serves both as a storage reservoir, and as a means of eliminating the pulsations of the air due to the reciprocating compressor. If the demand for air at a distant point is intermittent, the receiver should be located near this point, or two receivers should be used. If an aftercooler is used, a receiver close to the compressor may be dispensed with.

The air receiver also serves as a chamber in which the air is cooled so that the water and oil may be precipitated and drained from the system.

Anchor. See Anchorage.

Anchorage. For derrick and other guy lines, an attachment at a fixed point on the ground. For permanent anchorages, masonry foundations or piles, singly or in clumps may be used. For temporary anchorages, short pieces of timber are buried in the ground at right angles to the line of pull, the guy being attached at the middle.

Or they may be laid on the surface and weighted with stones.

Outdoor cranes, exposed to the wind, such as overhead electric traveling crane on elevated runways, must be locked in a fixed position whenever the operator is not in the cage. Anchorages are arranged by which the crane is locked to the rail, or to a stop at the end of the rail.

For rope and chain on crane winding drums. The chain is fastened by a shackle, or a stud in the drum circumference. The wire rope has a solid eye spliced in the end, and attached to the drum by a bolt; it is sometimes passed diagonally through the drum barrel or flange, and fastened in a rope socket which seats in a tapered hole.

Apron. The name sometimes given to the clear space often left on a pier between the pier shed and the pier edge. It is generally used to allow the passage of trucks or cars close to the ship.

Asbestos. A non-combustible fibrous mineral material, principally silicate of magnesia, which can be woven into webbing and reinforced with metal wires, and used for lining brake bands, clutches, etc. It is also used in the soft fluffy condition or when pressed into sheets, as a protection against heat, being a constituent of most of the heat insulation preparations. As it is also a fair electric insulating substance, it is used in cases where electrical leads are exposed to heat from outside sources or where it is difficult to remove the heat generated by the electric current itself, as in totally enclosed electrical apparatus.

Ash Ejector. A form of current conveyor by which ashes are removed from the fire rooms of steamers and discharged into the sea, through the use of a jet of water. The usual form involves a hopper into which the ashes are shoveled, which may or may not be covered depending on whether the operation is intermittent or continuous, a control valve and nozzle through which a jet is delivered in such a way as to draw the ashes with the water, a discharge pipe which usually has one bend in it, and an outlet in the ship's side, above or below the water line according to the type of installation.

Ash Handling Equipment. Ashes may be handled mechanically with the apparatus suitable for any other bulk material, except that their abrasive character causes excessive wear on apparatus having moving joints and bearings with which they come into contact.

The types of equipment commonly used are: drag conveyors; carrying conveyors; chain and bucket elevators; current conveyors of the steam or air jet or the vacuum type; skip or grab bucket hoists; monorail or bridge traveling cranes, with grab or bottom dumping buckets.

Ash Hoist. Apparatus for the removal of ashes from a fire room, generally consisting of a bucket or can with means of raising and lowering it rapidly. Used on ship board, and on land when the fire room is so low that the ashes must be lifted out of it.

Types which are in use are winch hoists, chain block hoists, air, steam or hydraulic cylinder hoists, and skip hoists. In city locations where the ashes must be raised through a hole in the sidewalk, the frame work supporting the hoist usually telescopes downward and is kept below the sidewalk except when in use. (See Hoist, Telescoping.)

Ash Hoist, Marine. A hoist arranged to remove the ashes from the boiler room of a ship at sea. Three types are in common use: the steam ash hoist, the electric ash hoist, and the steam ram. The first two are similar in having a power-driven geared winding drum and hoisting

rope, and may or may not have a "follow-up" gear, by which the ash bucket is fully controlled by the rotation of a small hand wheel, rising when the wheel is rotated in one direction, falling in the other, and stopping when the wheel is stopped. The steam ram consists of a long stroke direct-acting vertical steam cylinder, having its piston rod connected to the bucket hoisting tackle in an inverted manner, so that the motion of the bucket is much greater than that of the steam piston.

The ash bucket is hoisted through a fire room ventilator, and is dumped into a hopper leading to an ash chute which discharges a little above the water line.

Ash Pit. The enclosure immediately beneath the grate or stoker of a boiler, in which ashes collect, and from which they must be removed by the fireman, or by automatic means. The old and most common ash pit has a level floor at or slightly below the fireroom level, and the fireman pulls out the ashes with a hoe; they may be wheeled away, or disposed of by a conveyor. Hopper bottom ash pits are commonly used with stokers, and the falling ashes are allowed to collect in the bottom of the hopper until removed, either by hoeing out into a truck or conveyor, or by dropping through an opened valve directly onto a conveyor beneath the hopper.

Assembling. The act of putting a mechanism or machine together, or placing the various parts in their proper relation to one another so that they will perform the required operations.

Assembly. The complete collection of parts of a machine or portion of a machine, as a brake assembly.

Assembly Drawing. A drawing showing all the parts of a machine or apparatus or definite portion of the same, in their proper relation to one another.

Automatic. Having the power of self-motion; self-acting.

Automatic Swing. The term applied to a grab bucket excavator when the boom is swung automatically by using the alternating pull in the bucket hoisting and lowering ropes rather than by a bull wheel. (See Excavator, Grab Bucket.)

Auxiliary. That which aids or gives assistance; that which is secondary or subsidiary, as auxiliary hoist, auxiliary girder.

Axial. Along or in a direction parallel to an axis, generally an axis of rotation, as an axial load.

Axis. The imaginary line about which a body rotates or turns. It is preferable to say that a body rotates about its own axis of symmetry, and revolves about an axis outside itself, as: the earth rotates on its axis and revolves about the sun, but this distinction is not always made.

Axis, Neutral. See Neutral Axis.

Axle, Live. An axle which turns in bearings, and has its wheels rigidly attached like a railway car axle. A car provided with such axles does not readily move around sharp curves in the track, and where this is very necessary, as in rubber-tired cars and trucks, or small industrial trucks, the axle is divided in the middle and the two halves connected by means of a differential gearing, which is usually combined with the power-driving gear. In some industrial cars, one wheel is loose and one is tight on the axle; this will allow easy movement on curves.

Back-filler. Any device used for replacing the excavated material into the trench from which it was dug. Buck, scoop or drag line scrapers are useful in the work; endless chain bucket conveyors are also arranged especially for the purpose, following closely after the ex-

cavating machine. In some cases the back filling is done by the rear end of the same machine which does the excavating; the laying of the drainage tile, or whatever it may be, being carried on between the two and beneath the machine.

Back-filling. The replacing of the excavated material in a trench or similar excavation after the accomplishment of the operation for which the trench was dug.

Back Gearing. A geared speed reduction mechanism, consisting of a driving pinion *A*, keyed to a shaft on which also turns loosely a gear *D* connected to the machine to be driven. Another gear *B* and pinion *C* are arranged to rotate together on a parallel shaft, *B* meshing with *A* and *C* with *D*. The speed of the driving pinion is reduced in the ratio $(A \div B) \times (C \div D)$. The term "back gear" refers to the gear train coming back to the original shaft. It is used on machine tools, and also on some motors for winch drives.

Back-lash. In a mechanism, the amount of movement or play one part may have without moving another, due to fits not being absolutely perfect, allowances for expansion, running fits, etc. In gearing, the distance, measured along the pitch line, by which a tooth is narrower than the corresponding space.

Back Stop. A ratchet device or its equivalent used to prevent bucket elevators from running backward in case of accident to the drive. A friction device holds the pawl out of the ratchet wheel during regular elevating motion, but a reversal of the motion throws it into the teeth and stops rotation.

Baffle Plate. A plate suspended in front of the discharge pipe of a steam jet or air suction ash conveyor, or fixed on the wall of the bin opposite it for receiving the impact of the highly abrasive material. It may be made of the hardest steel obtainable, and even then be worn rapidly. One type, called the pocket type, has a number of pockets about 6 in. square and 9 in. deep, with a backing plate. The ashes pack into the pockets, and present to the discharge pipe practically a baffle plate of ashes, and wear is very slow.

Bagger. Any machine which mechanically aids the placing of bulk material in bags for purposes of transportation. It is often combined with a weighing scale to automatically deliver a definite amount to each bag. (See also Chute, Bagging.)

Bail. A curved strap or bar, pivoted at its two ends to the rim of a bucket scoop, tub, etc., and with an eye, loop or other arrangement for attaching a rope or chain, at its middle. When made of chain it is usually called a bridle, and is often provided with a spreader to counteract the tendency to deform the bucket rim. Fixed bails are riveted to the bucket, instead of being pivoted, and are only used where they will not interfere with filling or dumping.

Bale. A package of soft or non-rigid material generally more or less rectangular in form, compressed, wrapped with burlap or other fibrous material and secured by wires, straps, ropes, or other fastenings. Baled material occupies less space than when placed in boxes.

Ball, Downhaul. See Downhaul Ball.

Ball and Socket Joint. A flexible connection between two pieces of a mechanism, consisting of a partial sphere attached to one part, and a spherical seat partially (more than half) enclosing it attached to the other, the combination permitting freedom of relative motion of the two parts about the center of the sphere. These joints are used in some cases for connecting links to rockers

and levers; for some types of flexible tie rods or radius rods; and also to give flexibility to pipe lines, notably the discharge lines from hydraulic dredges.

Band Friction. A type of friction clutch applied among other places, to the drums of winches, consisting of a band carried by one part which can be contracted externally or expanded internally in a rim on the other part, making them rotate as one. (See Clutch, Friction; Drum, Friction.)

Barge. A floating craft of full body and heavy construction, designed for the carriage of cargo, but without means of self-propulsion. Cranes or other cargo handling gear are often mounted on barges. The distinction between a barge and a lighter is more in the manner of use than in form and equipment, the term barge being more often used when the load is carried to its destination, or a long distance, while the term lighter refers to a short haul, generally in connection with loading or unloading operations of vessels.

Barge, Coaling. A barge containing equipment for rapidly filling the bunkers of a vessel with coal. There are many types, but practically all include a tower-like structure on the barge, with elevating mechanism and means of discharging the coal into coaling ports in the sides or decks of the ship by spouts or chutes. Some types carry the load of coal in their own holds; others simply contain the elevating and conveying machinery, are placed between the loaded coal barge and the ship to be coaled, and transfer the coal from the loaded barge to the ship's bunker by machinery. This last arrangement may save one handling of the coal, but requires a wide slip if coaling is to be done while the ship is in a dock.

Barrel Cradle. A pair of concave stands, braced together, and designed for supporting a barrel laid on its side. They may be set on an ordinary elevator or conveyor for temporary use, or be built into the chain of a chain elevator or conveyor for permanent barrel handling installations.

Barrel Shop. A steel barrel, with or without a lid or cover, for holding castings, chips, dirt, etc., in industrial establishments.

Barrow. See Wheelbarrow; Hand Barrow.

Batch Box. A box used for holding the materials for making a batch of concrete, or for holding and conveying a batch of concrete after mixing. It is usually made of steel or of wood reinforced with steel. Some are supported on trunnions on a car or by a crane, and discharge by turning over (see Bucket, Turnover); others dump at the bottom when the doors are opened by releasing toggles or operating levers. (See Bucket, Bottom Dump; Bucket, Controllable Discharge.)

To make it possible to use common labor for measuring the materials with a minimum chance for error, some batch boxes are divided by partitions into three compartments for cement, sand and broken stone, respectively. In one type a watertight box with a cover holds the cement, and it is fixed in the batch box in such a position that it divides the latter into two parts of the proper proportions for the sand and stone. Alteration in the position of the cement box varies the proportions of sand and stone.

Batch Mixer. A mixer which receives definite quantities by weight or measure of various ingredients and mixes them by stirring, rotation or other means to make concrete, glass, etc.

Battery. See Electrical Definitions.

Beam. A single piece (generally straight) or a distinct portion of a structure which is so supported and loaded that it is subjected to transverse forces tending to bend it. The term is also sometimes applied to a heavy unfabricated timber or steel structural shape, without reference as to how it is to be placed in a structure, as I-beam. Also, the extreme breadth of a vessel.

Beam Clamp. See Clamp, Beam.

Beam, Ladle Crane. A strong beam suspended at the ends by two sets of load ropes from the trolley of an overhead traveling crane, and having hanging from it two long steel hooks supporting the ladle by trunnions at the sides. (See Crane, Ladle.)

Beam, Lifting. Any long bar or girder used as an auxiliary in connection with hoisting machinery, when lifting long objects like bars, plates or pipe, by hooks, slings or magnets.

Beam of Uniform Strength. A beam designed to support a given load or system of loads, and formed with such dimensions that the maximum stress existing at a section of the beam is the same wherever in the length of the beam the section may be taken. In designing the girders of overhead traveling cranes, this method results in the fish-bellied or parabolic form of the bottom chord; in bridge structures where the load is carried on the lower chord, the upper chord is thus curved.

Bearing. That part of a machine frame or other member which encloses a rotating part like a shaft and holds it in place. The part of the shaft which rotates within the bearing is usually called the journal when it is loaded transversely, and the bearing a journal bearing. When the load on the shaft is axial, the bearing is called a thrust bearing. (See Bearing, Thrust.) Many bearings are designed to carry both loads simultaneously.

Bearings in which both parts have smooth surfaces in contact with each other are sometimes known as plain bearings as distinguished from those in which the surfaces are kept apart by balls or rollers. (See Bearing, Ball; Bearing, Roller.) Ball and roller bearings turn much more freely, consume less power and have certain advantages as regards lubrication; they are less suitable for very heavy loads, however, and where shocks must be withstood, should not be used.

The term bearing often includes both the part which immediately encloses the journal, or box, and the supporting frame, called the body, bracket, hanger, pedestal, etc. As regards their adjustability to take up wear, boxes are either solid or split (divided); solid bearings can be adjusted for wear only by renewing the bearing, the journal, or a removable lining for the former. Split bearings may be adjusted as they wear by numerous methods—more complicated forms have the box divided into three or four parts which can be separately or simultaneously adjusted to take up looseness due to wear. These special bearings are common in engines and motors and other large machinery, but not in bearings for ordinary shafting.

Many bearings are formed directly in the frame of the machine, and their form is dependent on the arrangement of the latter. Other bearings much used in conveying installations are independent and are more or less standard. As regards adjustability for location of the shaft center and for alignment, they are known as: rigid, in which no adjustment is provided; adjustable, in which the location of the shaft center may be changed horizontally, vertically or both; trunnion, in which the bearing may swing about a transverse axis in one plane

(generally vertical); and swiveling or universal, in which it may swing in any direction.

Rigid bearings are usually provided with slotted holes in the supporting frame for transverse adjustment.

Bearings are adjusted vertically by wedges beneath the supporting frame or by screws placed above and below the box, which clamp it between them. Horizontal adjustment is obtained by moving the supporting frame sideways, by wedges, or by screws.

Trunnion bearings usually have lugs cast on opposite sides of the box, held in corresponding holes in the supporting frame. They may also be suspended between pointed set screws passing through threaded holes in the frame.

Universal bearings are usually arranged with spherical seats in the boxes held between spherical surfaces in the supporting frame. In one type these surfaces are on the top and bottom only, are small in size, and are clamped between spherical hollows in the ends of the same screws (sometimes called plunger screws) that are used to provide for vertical adjustment; in another type spherical zones or segments are formed completely around the box, and held in corresponding hollow spherical surfaces in the supporting frame, this making a very substantial swiveling arrangement, though without transverse adjustment.

The form of supporting frame for the box has also given rise to a variety of names. Often the box and frame are formed in one, like the common flat box, which is simply a bearing box having a flat bottom with flanged edges having holes for two bolts. Somewhat larger ones of similar construction, with four holes, are called pillow blocks; these may be divided horizontally or angularly, the latter being desirable to receive an inclined pull. Still larger and more elaborate forms, with perhaps renewable bearing shells, and even boxes in portions and adjustable by means of wedges are known as pedestal blocks or pedestal bearings. When the shaft is located a considerable distance above the floor on which the bearing stands, and the frame is made open, it is called a floor stand.

Where the bearing is hung from the ceiling, the frame is called a drop hanger; it is similar in construction to the floor stand, and one can often be converted into the other by turning over the box, thus changing the location of the oil reservoir. When the bearing is supported by a vertical surface of a post or wall, the frame is called a post hanger or wall bracket, the latter type locating the shaft further away from the wall than the post hanger.

When a bearing is desired at the point where a shaft goes through a wall, a rectangular frame called a wall frame is built into the wall and the box mounted in it.

Bearing boxes are often distinguished according to their method of lubrication. Self-oiling bearings are those in which a reservoir is provided, generally below the shaft, into which a supply of oil is placed and fed automatically to the rubbing surfaces from which it drains back to the reservoir and is thus used over and over. The means of feeding the oil are: by slender rings or chains dipping into the oil and hanging over the shaft in notches cut in the top box; by collars fast to the shaft within the boxes, or by capillary attraction through pieces of wood with fine openings, dipping in the oil and pressing up against the bottom of the journal. Other bearings which are not self-oiling are plain bearings with oil holes for oil from a squirt can; wick oiling bearings in which small oil reservoirs are formed in the cap, and wicks dipping into the oil and then extending from it up

over the edge of tubes leading down to the bearings, carry the oil by capillary attraction; grease pocket bearings, in which a large pocket formed in the top box and connected with the bearing surfaces by a liberal opening, is filled with grease which will melt and give additional lubrication whenever the temperature rises, due to excessive friction; and grease cup lubricated bearings, in which grease is occasionally forced into the bearing by a hand fed grease cup.

Bearing boxes are usually lined with babbitt or an equivalent anti-friction metal. For very light work where low cost is important, unlined cast iron boxes may be used; for very heavy pressures and important work bronze liners in the bearings are desirable. Babbitt lining is usually poured directly in the bearing, but separate interchangeable white metal shells are now obtainable in various standard sizes, and can be substituted for worn ones when needed, provided the bearing is originally designed for this arrangement.

Page 731, 740, 783.

Bearing, Ball. A bearing in which the surfaces of the two parts having relative motion, and which would otherwise rub together, are kept separated by an assemblage of steel balls. As the balls are always hardened, special hardened surfaces are provided for them to roll on to prevent wear, and these are called races; one turns with the rotating part and the other is fast to the stationary part. The balls are often held in place by a retainer, or they may be actually inserted in spaces in a part called a cage, which, while allowing them to roll freely, keeps them spaced the proper distance apart.

Three classes of ball bearings are usually recognized: radial (sometimes called annular) bearings, suited for carrying a transverse load on the shaft, and corresponding to an ordinary journal bearing; thrust bearings, for carrying an axial load on the shaft (see Bearing, Ball Thrust); and a combination of the two in a single bearing which is able to carry both axial and radial loads, sometimes called an angular bearing.

As regards the manner in which each ball carries its load, ball bearings are termed two point, three point and four point; the first is the most commonly used, and the last is seldom found. The fundamental principle underlying the design of the races is that the ball should have as nearly as possible a pure rolling action with a minimum of spinning. Two point bearings have the points of contact between race and ball so located that tangents there intersect each other on the axis of rotation, this point of intersection being at an infinite distance in the case of pure radial bearings. Three point bearings have two points of contact on one race and one on the other; the tangent at the last must intersect the chord drawn through the other two at a point on the axis of rotation.

Both balls and races should be made of very hard steel, and should be polished to a high degree. Ball bearings fail by a flaking or pitting of the surfaces of balls and races, at loads far below the crushing strength of the ball. While adjustments are often provided, a bearing which has worn to the point at which adjustment is necessary has failed and it needs replacement. It is therefore desirable that the setting be made permanent at the factory and that no possibility of adjustment be furnished.

Theoretically, lubrication is unnecessary if pure rolling contact is obtained, but because there is a very slight spinning or twisting of the surfaces in contact even in the best bearings, a certain amount of it is advisable. In addition, it prevents corrosion and tends to exclude for-

eign matter, both being very destructive to the bearings.

Page 740.

Bearing, Ball, Angular. A ball bearing which will carry a combination of axial and radial loads on a shaft. Two such bearings are required to carry a shaft in a definite position against loads from any direction.

The races usually take the form of a cone which is forced on to the shaft, and a cup which is fast in the bearing, with the balls between them. With two point contact, the two conical surfaces on the cone and in the cup are concaved; with three point contact, the cone is straight or curved, and the cup has angular sides. The three points of contact must be properly related. (See Bearing, Ball.) A plain radial bearing and a thrust bearing may be combined to serve the same purpose as an angular bearing.

Page 740.

Bearing, Ball, Radial. A ball bearing for supporting a shaft which is subject to transverse loads. A hardened sleeve or race is usually forced on the shaft, and another in the hub of the bearing box; a shallow groove is turned in the inside of the outer race, or on the outside of the inner race in addition, and a complete circle of balls is inserted to fill the space between the two races. Two rows of balls spaced some distance apart are sometimes used to carry a heavy load, but care must be taken that the load is equalized between them.

Also called an annular ball bearing.

Page 740.

Bearing, Ball Thrust. A ball bearing arranged to carry an axial load on a shaft. Two point bearings usually consist of two hardened steel plates having between them a cage or a plate with numerous holes, in which the balls are inserted and held loosely; one of the hardened plates is attached to and turns with the shaft, and the other rests in the bearing. In the three point type, one plate is flat and the other has an annular groove whose sides are so sloped that the three points of contact bear the proper relation to each other as for pure rolling. (See Bearing, Ball.)

For proper distribution of the load among the balls, a spherical seat for one of the hardened plates is necessary.

Where the axial load is small, discs like the above may be inserted in a step bearing at the end of the shaft. Where larger thrusts must be carried, annular plates or rings are used and held relatively to the shaft by collars formed, clamped or screwed on it. Thrust in either direction may be carried by a duplication of the arrangement.

Page 740.

Bearing, Dust Proof. A bearing which is constructed in such a manner as to exclude dust. One method of doing this is to clamp felt rings around the shaft against the end of the bearing; another is to place felt rings around the shaft in recesses turned in the box at each end just within the bearing. One end of a bearing may sometimes be completely closed, and is naturally completely dust proof at that end.

Bearing, Oil Impregnated. A bearing made of hard wood impregnated with oil, and used in places where lubrication can not be easily accomplished, or where oil would be detrimental, as in bearings of screw conveyors handling food products, etc.

Bearing, Roller. A bearing in which the surfaces of the two parts are kept from coming into contact with each other by means of a number of small rollers, which are usually mounted loosely in a part called a cage, to keep them properly spaced, and to make it easier to

assemble the bearing. Special hardened surfaces are often provided for the rollers to run on, to prevent wear, one being attached to the moving and the other to the stationary part.

Roller bearings have the same three classes as ball bearings, radial, axial or thrust, and combination or angular. The bearing is in line contact along the full length of the roller, hence these bearings will carry much heavier loads than ball bearings, which have point contact. It is equally important that surfaces of rollers and races be true and polished, and adjustments for wear are not often advisable. Lubrication is desirable, to prevent corrosion and to exclude foreign matter.

(See also Bearing, Roller, Radial; Bearing, Roller, Thrust.)

Page 731, 783.

Bearing, Roller, Radial. A roller bearing for supporting a shaft which is loaded transversely. As the load is distributed along a line, hardened wearing surfaces for it to roll on are not so necessary as with ball bearings, but are advisable; usually hardened sleeves are pressed onto the shaft and into the bore of the bearing, with the rollers in their cage between, all lying parallel to the shaft, and spaced equally around it. The rollers may be plain cylinders necked down at the ends where they fit into the cage, or may be formed of a strip of steel wound into helical form and ground cylindrical on the outside, the latter construction giving a flexible roller that will not be so easily fractured if it becomes slightly skewed.

Page 731, 783.

Bearing, Roller, Thrust. A roller bearing arranged to carry a thrust or axial load on a shaft. For pure rolling contact, conical rollers are required, but the cost of cylindrical rollers and flat thrust rings is so much less that they are much used. In order to avoid excessive wear, the cylinders are made short in length resembling discs, and a number are assembled along the same axis; each may then take its own speed independently of the others. These disc rollers may be mounted in a cage for convenience in handling.

Roller thrust bearings are usually made with hardened steel plates, and the rollers themselves are hardened.

When conical rollers are used, the thrust rings must both be conical, or one may be flat and the other more steeply coned, and the angles should be such that the apexes of the rollers, should they be extended so far, would lie at the center of rotation of the shaft; this will secure pure rolling. A thrust ring must be added around the bases of the rollers to keep them from being forced outward by the pressures on the inclined surfaces, and a cage is required to hold them in a true radial position.

Roller thrust bearings are used for carrying very heavy loads, as in turntables for some forms of cranes. (See Bearing, Roller, for Locomotive Cranes.)

Bearing, Thrust. A bearing designed to prevent an axial motion of a shaft, and which is used either for adjusting purposes or to carry an actual axial load. Two types are commonly distinguished, one in which the end of the shaft or a part attached to it for that special purpose is used as a rubbing surface, called a step thrust bearing, and the other in which rings or collars are formed on or attached to the shaft, revolving between similar collars or rings carried by the supporting frame, called a collar thrust bearing.

The step bearing is often used for vertical shafts, and

is made adjustable for vertical wear. Alternating discs of dissimilar wearing metals are usually placed between the end of the shaft and the bottom of the step, and oil is preferably fed at the center of the bottom of the step, passing gradually outward through radial grooves in the discs. Step bearings are also used for carrying the thrust of worms.

Collar thrusts are used for the largest loads, as all necessary bearing surface can be obtained by multiplying the number of collars.

Many journal bearings are arranged to take end thrust from a collar on the shaft, by having a babbitted and finished surface on the end of the bearing.

Thrust bearings are also made in the ball and roller styles. (See Bearing, Ball Thrust; Bearing, Roller Thrust.)

Bedding and Reclaiming Equipment. A combination of a bridge storage crane for uniformly distributing material in a long heap or bed, and a reclaiming machine which works from one end of the bed, slicing down a cross section and thoroughly mixing it as it reclaims, and delivering a very uniform material as required for certain smelting and chemical industries using raw material which varies from time to time.

Bell Crank. A bent lever pivoted at the bend, for changing the line of application of a force.

Bending Moment. The total bending tendency to which a beam is subject, expressed generally in inch-pounds. The bending moment at any transverse section of a beam is equal to the algebraic sum of the products of each of the forces acting to produce bending, multiplied by the perpendicular distance of the line of action of the force from the section.

Bight (of a rope). A loop or bend in a rope; any part of the rope between the two ends.

Bin. An enclosure for the storage of material in bulk, or of package or similar material which may be temporarily treated as if it were in bulk. Three types may be distinguished: hopper bottom square or rectangular bins, cylindrical bins and suspension bins. Bins are usually on or above the ground, being termed overhead bins in the latter case; where an opening is made in the ground for holding bulk material, even if it is lined with steel or concrete, it is usually termed a pit.

The term bin is also often employed to designate a compartment formed by vertical partitions and shelving in a store-room where bulk material, machine parts, etc., are kept.

Bin, Ash. An enclosure to which ashes are delivered from time to time from the ash pits of coal fired furnaces, to be discharged into a car or barge when a sufficient amount has accumulated. If the bin is elevated so that it may discharge easily, the ashes are delivered to it by an elevating conveyor, a skip hoist or a steam or air jet conveyor. If the bin is located below the ground level, the ashes are transferred from it to a car by a grab bucket. Also called ash bunker.

Bin, Coal. A bin used for storing coal. When this is just prior to burning it is usually called a coal bunker. Where used for temporary storage during transit, or for selling at retail, it is usually termed a coal pocket (see Pocket, Storage).

Large storage bins for coal are sometimes used at mines to adjust the variable supply of railway cars to a constant daily mine output. Railways often supply an excess of cars during the early part of the week and too few toward the end.

(See also Storage, Coal.)

Bin, Cylindrical. A bin for the storage of bulk material, circular in plan, and often of considerable height. It is built of wood, steel, terra cotta or concrete, the last becoming more and more common for the storage of material like grain, coal, etc. Material is dumped in at the top, usually by elevator conveyors, and is drawn off through the bottom or from the side near the bottom as needed, through a gate controlled spout, into cars, wagons, etc., or through a feeder onto a discharge conveyor. The bottoms are flat, hemispherical or funnel shaped; the structure is supported directly on a foundation or on a circular girder supported by columns which rest on a foundation. These columns may be of considerable height in cases where it is desired to deliver the material to distant points by chutes.

These bins may be built in separate rows, or in groups of four, nine or sixteen, the group arrangement being preferable on account of the additional storage space afforded by the spaces exterior to the circular sections, and between the points of tangency, these amounting to more than one-fourth the internal capacity when the walls are of a thickness appropriate for concrete.

Cylindrical concrete bins are built with fixed forms, or with movable ones which are gradually slid up as the work progresses. The wall thicknesses are about one-fiftieth of the diameter, with a minimum of 7 in.

Bin, Hopper or Hopper-Bottom. A bin which is square or rectangular in plan, and has a bottom shaped like an inverted frustrum of a pyramid, with the slope of the sides such that the material will slide completely out. The opening at the apex leads to a gate controlled spout, or a feeder for a conveyor. A true hopper bin has no vertical sides; a hopper bottom bin has vertical sides of any height depending on the capacity required. If large capacity is desired without excessive height, it is common to build the bin as a series of adjoining hopper-bottom units, rather than a single large unit; material can then be drawn off at a number of points.

Bin, Overhead. A bin supported in an elevated position so that a car, conveyor, truck, wagon, etc., may pass beneath or beside it and receive material from it by gravity, or so that the contents may pass by gravity through a spout or chute directly to a desired location, as to a stoker hopper.

(See Bin, Suspended.)

Bin, Silo Storage. A term often applied to a circular bin used for storage of bulk material. (See Bin, Cylindrical.)

Bin, Suspended or Suspension. An overhead bin made of steel plates, or of steel straps with plate linings, suspended from two longitudinal parallel steel girders which are themselves supported by steel columns and braced apart by suitable struts, or are suspended from overhead trusses. The transverse section of the bin is usually approximately parabolic, and spouts attached to openings in the bottom are used to draw off the contents.

While solid steel plates are often used, a cheaper modification is to have a series of equidistant steel straps bent into the suspension form and attached at the ends to the girders, these straps being strong enough to carry the weight of the lining and the material placed within the bin. The lining, which is either plain or corrugated steel plate, is laid within the straps, being curved to fit them, and is covered inside and out with a mixture of cement and sand. Such a construction is smooth, fire resistant, and less liable to corrosion than when built with exposed plate.

If the bin has either a flat or hopper shaped bottom,

the lining must be carried on longitudinal or transverse beams strong enough to resist the bending tendency.

Bin Bottom. A part bolted to the bottom of a hopper or bin for the attachment of a spout. It is usually a casting, is often provided with a gate or valve, and with a turnhead or swiveling connection to the spout. The latter is also often flexibly connected to the bin bottom, so that it may be swung outward in any direction desired. (See Turnhead; Spout, Flexible.)

When shaped to fit the bottom of a hopper, it is often called a hopper bottom, the term bin bottom being reserved for the form fitted to the flat bottom of a bin.

Two-way or four-way bin bottoms are those having two or four separate gates which may be operated independently to deliver material to as many compartments beneath.

Block. A metal or wooden frame, or shell, containing one or more pulleys or sheaves, generally set side by side and turning freely on the same axis, and used in connection with a rope as a means of hoisting heavy weights. If two or more sheaves are used, they are generally separated by division plates similar in form to the outer shell or cheeks.

Portable blocks, portions of "block and tackle" gear, generally have wooden cheeks, reinforced by metal. They are furnished with swiveling or fixed eyes, shackles or hooks depending on the way they are to be used and supported. (See Block and Tackle.)

Page 318.

Large blocks used for heavy loads in cranes are built entirely of metal. The sheaves, of which there may be any number, are often on ball or roller bearings for light loads and on hardened steel pins and bushings for heavy ones. The pin is of forged steel. The frame may be of cast steel, and the yoke, which connects the frame to the hook or eye used for attaching the block to the load or hoist, is of cast or forged steel. The frames are also held together by bolts and distance pieces.

Single, double, triple, etc., block, refers to the number of sheaves.

Block, Bottom. The lower block of the two in a block-and-tackle hoist. (Also called load block, fall block, lower block.)

The hook is usually a permanent part of the lower bottom block, and, in most hoisting machinery, is of the swiveling type, mounted on ball or roller bearings, with hardened steel wearing surfaces.

Block, Gin. A single block having a sheave of large diameter to give ease in overhauling; used where a hoisting operation has to be repeated many times, as in loading or unloading cargo.

Block, Hook, Shackle, Swivel, Plain, etc. Terms signifying the method of connection of a block to its support or load. (See Block.)

Block, Rotating. An upper block used in handling pieces which must be rotated about their longitudinal horizontal axis, like shaft forgings, etc. It usually consists of a very heavy pitch chain passing around the forging at the bottom, and around a sprocket wheel at the top, which is mounted in a frame suspended from the top hook. This sprocket can be rotated by gearing from an electric motor also mounted on the frame. As the hook is usually arranged to swivel in the frame, in addition, collector rings are provided to bring power into the block. Springs are also often built into the frame to decrease shocks. (See Springs, Shock.)

Block, Running. A single sheave block supported in a bight and provided at the bottom with a load hook.

Block, Snatch. A single block, generally used as a guide block, and having one side of the frame arranged with a hinge and lock so that it may be opened to allow the bight of a rope to be placed on the sheave, without the necessity of reeving the rope end through the block.

Block, Strap. A block having as a shell or casing, two iron straps connected by distance pieces and bolts, and with holes for the sheave pin.

Block, Upper. The upper block of the two in a block-and-tackle hoist. In cranes, this is carried by the trolley girt, and often has its frame specially shaped for ease of attachment to it.

Block-and-Block, Chock-a-Block. The name given to the condition of a tackle when the two blocks have been drawn together, and no more hoisting can be done with them.

Block and Tackle. A mechanism much used for hoisting, consisting of two pulley blocks, or blocks, as they are usually called, with a rope rove around the sheaves and back and forth between the two blocks. One end of the rope is secured or "dead-ended" to one of the blocks at a becket or eye, and the other end is wound on a drum, or pulled by hand or other means. In hoisting, the upper block is fastened to an elevated point on a crane, trolley, derrick, etc.; the lower block has a hook on which the load is hung. According to the number of pulleys and direction the free end is led, the multiplying power of the tackle may be from two, up to any number, neglecting friction. The load lifted is equal to the pull on the free end multiplied by the number of parts of the rope that support the load.

Small block and tackle of the portable type usually have wooden or wood covered blocks with lignum vite or metal sheaves, and manila or hemp rope; larger sizes, as used in cranes, have steel blocks of elaborate construction fitted with wire rope. Chain is sometimes used, but only with single blocks.

In addition to hoisting, this mechanism may be used for exerting a pull in any direction, including especially horizontal haulage.

Block and tackle is occasionally used in a reversed sense, with the movable pulley attached to the piston of a hydraulic, steam or air cylinder capable of applying great force, and the free end of the rope led to a hoisting hook, around one or more guide sheaves if necessary, and moved through a considerable distance, though at the expense of lifting power. (See Hoist, Air Cylinder.)

Block Carriage. A type of trolley used for light loads, having two sheaves in line in the direction of motion of the trolley. The load rope or chain is attached to the end of the jib (or bridge), passes down over the nearer trolley sheave, around a sheave at the load block, up over the other sheave, and along the jib to a drum at the end, or around another fixed pulley and down to a winch drum below. The trolley may be racked in or out without vertical movement of the load.

This device was formerly much used, before the advent of electrical operation, and afforded a simple and satisfactory means of operating a hoist on a movable trolley, without having the source of power (steam engine, man power) also mounted on the trolley. It is still often used in small cranes, and in some traveling wall cranes of good size. Sometimes called trolley with pendent sheave.

Block Fittings. Special straps, swivels, eyes, shackles, bands, etc., which may be mounted on blocks to adapt

them to special purposes. The form used depends on the direction the block is to face, whether it is to have the rope dead-ended on it, whether it must swivel, be easily detached, etc.

Blower, Rotary. A machine for compressing air consisting of two lobed rotors or impellers rotating on parallel shafts in a casing and meshing into each other in such a way that air is caught in spaces at the intake and delivered to the discharge side at which a higher pressure is maintained. It is suitable for pressures from 6 oz. to 10 lb. and is much used for producing blast for cupolas and furnaces, where the delivery of a constant quantity of air under varying discharge pressure is desirable. It is also suitable for operating pneumatic tube conveying installations.

Body, Motor Truck. A wooden or metal framework or enclosure designed to meet the requirements of the load carried, and fastened to the chassis; it may or may not include the driver's seat, wind shield and other parts provided for his protection. It is generally mounted on sills to bring it to the proper level, and it can extend over the sides and the rear of the steel framework of the chassis. The section housing the driver is called the cab, when not integral with the body. The following forms are common. Dump-body; hinged to the chassis at the rear and arranged to lift in front. Platform body; straight or curved flooring with detachable stakes on all sides. Rack body; a curved or straight platform with detachable or fixed sides made of a lattice of vertical and horizontal slats. Sections of the side are often, and the tail board always, made removable, and canvas tarpaulin is used as a cover for the goods. Express body; built with a canopy top made of canvas laid on light slats and supported by four or more uprights of wood or metal, and provided with rack sides, wire screens or canvas curtains to protect the goods. Flare boards are usually mounted at an angle at the top of the fixed side boards, to increase the carrying capacity. Closed panel body; entirely enclosed and provides complete protection for the goods carried. The larger sizes of this type are called van bodies. Refrigerating equipment is sometimes built into properly lined bodies to maintain a low temperature. On the other hand, heat from the exhaust or hot water from the cooling system may be used for heating when desired.

Page 702.

Boiler, Vertical. The type of internally fired fire tube boiler commonly used in operating derricks, locomotive cranes, steam winches, etc., consisting of a cylindrical shell set with the axis vertical. The combustion chamber or fire box is set within the lower part of the shell and surrounded on the sides by a narrow water space sometimes termed a water leg. The circular bottom opening is closed by the grate bars on which the fire rests, and the top, called the lower tube sheet, (or sometimes crown sheet), has numerous tubes through it extending to the upper tube sheet at the top of the boiler. Gases pass upward through these tubes and out of the stack, heating the water surrounding them. Sometimes the upper tube sheet is submerged, or placed at the bottom of a chamber formed within the upper part of the boiler and open at the top, the water level being above the level of the tube sheet and within the annular space surrounding this chamber.

Necessary accessories are: the fire door, closing the opening through which fuel is supplied; the gage cocks and water column by which the level of the water in the

boiler is determined in two ways; stop and safety valves; blow off cock; steam gauge; smoke stack and steam jet or blower.

Bolt. A fastening usually consisting of a metallic bar with a head or collar at one end and a threaded portion to receive a nut at the other. This type is sometimes known as a through-bolt. The nut may be omitted and the threaded portion screwed directly into one of the parts to be held, when it is called a tap bolt or cap screw. If there is no head on either end, but one end is screwed into a tapped hole, and a nut is placed on the other end after the part to be attached has been passed over the body of the bolt, is called a stud. If both ends are threaded and nuts are used at both ends, it is called a stud-bolt.

Bolt, Eye. A fastening consisting of a bar formed into an eye or ring at one end, with or without a shoulder at the junction of the eye with the shank, and threaded at the other end for a nut or for screwing into a threaded hole, or it may be left smooth for riveting.

Bolt, Foundation. Long iron or steel rods for holding machines to their masonry foundations. The lower end may be threaded and provided with a nut and large washer, or it may be bent over L shape; the upper end is generally threaded for a nut.

Bolt, Holding Down. See Bolt, Foundation.

Bolt, Key. A bolt which has a threaded portion at one end and instead of a head at the other, a straight portion with a slot cut through it to receive a transverse key or cotter. A key bolt can be used in places through which it would not be possible to enter a bolt with a head, as in a method of supporting an I-beam mono-rail runway by a series of bolts along the centerline of the beam in line with the web.

Bolt, Ring. An eye-bolt having a ring worked through the eye.

Bolt, Through. A bolt which passes completely through holes in the two parts to be bolted together, with the bolt head on one side, and the nut on the other. Distinguished from a stud or tap bolt. (See Bolt.)

Boom. The principal moving part of a kind of crane of which the derrick is a good example. It is a long spar or strut, of wood or steel, pivoted or hinged at one end at a point fixed in height on a frame, mast or vertical post, and with its other end supported by chains or ropes. The load is carried by ropes passing over sheaves at the boom point, and there is no trolley or traveler by which the load may be carried in or out on the boom, this motion being accomplished by changing the boom inclination.

In some types of cranes having booms the mast or pillar is very short compared with the boom; in these cases the boom hoisting gear is often attached part way out on the boom instead of at its extreme point. The boom may also be curved or have a "goose-neck," and may be built of structural shapes in such a way that it has little resemblance in appearance to the ordinary derrick boom. (See Crane, Wrecking.) If, however, it has no trolley, can revolve about or with the mast or post to which it is hinged, and moves the load radially only by changing its own inclination, it is a boom.

Boom, Extensible. See Jib, Retracting.

Boom, Gooseneck. A crane boom, often used with locomotive cranes, in which the outer part is bent outward at a considerable angle, in order to give increased clearance between the suspended load and the boom, or to

enable the boom to reach over high obstacles like the sides of freight cars without being made excessively long.

Boom, Latticed. A boom made of rolled structural shapes laced together with diagonal steel strips, as distinguished from one which consists of a single rolled member, or several riveted directly together. By separating the longitudinal members and lacing them together, the strength and stiffness of the boom are increased without a corresponding increase in the weight.

Boom, Loading. A lowering or retarding conveyor section mounted on a long frame having a horizontal hinge at its upper end, and used to lower coal to the bottom of hopper bottom or gondola cars in loading operations at a coal tippie or elsewhere, the object being to avoid breakage. The height of lower end is controlled by a power hoist, and it is gradually raised with the level in the car; the car is then moved along the track (generally down grade, controlled by its brakes or by a car retarder), the boom lowered to the bottom and a new pile started. Also called a lowering boom.

The loading boom is usually contained in a building directly over the loading tracks, and receives its coal from a shaking screen or picking table. A moderately steep slope is necessary if the boom is to distribute throughout the length of a deep hopper bottom car, and this may necessitate cleats on a conveyor belt, or beads or ridges on the plates of an apron type of conveyor, or even shallow buckets.

Also, a portion of a machine used for loading coal into vessels. A car dumper discharges coal into the hopper of a loading tower. From the hopper the coal passes onto a conveyor carried on a hinged boom; at the end of the boom it is dumped down a telescopic chute with a quarter turn swiveling elbow at its end, through which the coal can be discharged in any direction in the hold of the vessel, making hand trimming unnecessary.

Boom, Lowering. See Boom, Loading.

Boom, Luffing. A boom which can have its inclination changed, the outer end or point being raised or lowered. Sometimes called a luffing boom. (See Crane, Luffing.)

Boom, Parabolic. A locomotive crane boom which has its side members curved in an approximately parabolic curve, for the purpose of gaining uniform strength throughout the length of the boom, to resist stresses caused by slewing. (See Beam of Uniform Strength.)

Boom, Retracting. See Jib, Retracting.

Boom, Shovel. See Shovel Boom.

Boom, Tie-rod. See Boom, Trussed.

Boom, Trussed. A boom which has its straight main member stiffened by tie rods running from end to end, and passing over short perpendicular struts or king posts near the middle. The tie rods are tightened as desired by turnbuckles. The construction is generally applied to wooden booms, but steel booms consisting of a single I-beam may be similarly stiffened against side yielding. A single truss is often placed below a wooden boom to prevent sagging due to its weight.

Trussed wooden booms may be made in two parts, as the tie-rods can be adjusted to prevent bending and keep it straight. Also called Tie-rod Boom.

Boom Band. An iron band encircling a wooden derrick boom, and furnished with an eye or other means by which a rope, block or other part may be attached to the boom.

Boom Fall. See Topping Lift.

Boom Fittings. See Fittings, Derrick.

Boom Heel. The lower end of a boom where it is pivoted to the mast or pillar.

Boom Point. The upper or outer end of a boom, furthest away from the pivoted end.

Boom Seat. The metal fitting or socket at the base of a derrick mast which receives the heel of the boom and permits the inclination of the boom to be changed (See Derrick Bottom.)

Boom Suspension. See Topping Lift.

The term is also applied to the ties by which crane or dredge booms of fixed inclination are attached to the top of the mast or A-frame.

Boom Swinger, Bcom Slewler. See Winch, Derrick Slewing.

Boom Table. An outrigger or shelf built around a derrick mast or post to support the heels of a number of booms. This is necessary when several booms are used, in order to provide proper clearance. Used principally on shipboard in connection with cargo handling gear.

Booster. A short section of inclined, power driven, apron, belt, power roller or roller push bar conveyor, used for raising packages to the high end of a gravity conveyor, down which they move by gravity. Several boosters may be inserted at intervals in a long line of gravity conveyors, whenever the grade brings the runway too close to the floor level. Such a line would then consist of a series of gravity conveyors, with power driven boosters at regular intervals furnishing the power to lift the packages to the top of each gravity section. With this arrangement there is no limit to the horizontal distance which can be covered by a gravity conveyor, and in addition passageways can be arranged beneath the runway, or it can be carried over obstacles.

Each booster usually has its own power unit. Where portable gravity sections are used, the boosters are also portable, and are often merely portable elevator-conveyors temporarily placed in the conveyor run.

In order to properly support the belt of a belt booster at the lower gooseneck where packages first come into contact with it from the roller conveyor, the rollers are spaced closely together, or smooth steel plates are used beneath.

Also called live conveyor, humper and booster elevator.

Booster, Push Bar. A booster consisting of a short inclined section of push bar conveyor, which will receive packages delivered to its lower end by a gravity roller (or other) conveyor, or by a loading platform, elevate them by sliding them up the runway bed between power driven push-bars, and deliver them to another conveyor.

Booster Steam Unit. The name given to a fitting containing steam jets to give additional propelling action in steam jet ash conveyors, where the discharge line is so long or has so many curves that the resistance is greater than can be overcome by the principal steam unit. In straight runs of pipe two jets on opposite sides of the pipe are used to prevent the flow from being deflected against one side of the pipe. At elbows only one jet is necessary, as it can deliver directly into the center of the discharge run.

Boston Tower. See Tower, Horizontal Boom.

Box. A cubical or rectangular container, usually closed by a lid which may or may not be hinged and which may be fastened by various means. Special forms of boxes are called chests, trucks, tanks, etc.

Box End, Crane. An overhead travelling crane end truck built up of plates and rolled structural sections in box section form. (See Crane End Truck.) It carries one end of the bridge girders.

Brace. A structural member placed diagonally between and near the junction of two other members, to stiffen their connection. Also a strut, or compression member.

Bracket. A triangular plate or frame placed at the angle of crossing or joining of two pieces, to stiffen their connection; a brace. A triangular plate or frame fastened against a wall to support either a weight at its projecting apex, or a platform laid along its top.

Bracket, Post. One of the two hinge plates of a bracket jib crane, arranged in the form of a pad to fit partly around a post, and to be secured to it by bolts.

Also, in a tower derrick, one of the two step bearings for holding the top and bottom of the mast, allowing it to rotate, and securing it to the corner post of the tower. Known as top and bottom post brackets.

Brake. A mechanism in which, by means of the pressure of one part rubbing against another causing friction, the relative motion of the two parts may be diminished or stopped entirely. In the majority of cases the brake acts on a rotating part, controlling its speed of rotation. Its function is primarily to absorb the mechanical energy, change it into heat and get rid of it by radiation, therefore for heavy work the ability of the mechanism to radiate the heat is exceedingly important. Various materials are used for the rubbing surfaces, depending on the relative importance of low cost, durability, reliability, compactness, relative speeds of rubbing surfaces, frequency of use and size and importance of the machine. For slow speeds, and where large pressures must be exerted, cast iron, wood or bronze blocks or steel or iron bands are used on steel or cast iron rubbing surfaces; for high speeds and lighter pressures one of the rubbing surfaces is often faced with fibrous material called a brake lining.

Brakes may be classified in several ways, according to the form taken by the element which is pressed against the rotating part as band, disc, cone, block, post; according to the force used for applying as hand, foot, spring, gravity, air, steam, solenoid, magnetic, automatic; according to the mechanism for applying the pressure, as lever, toggle, screw, differential; and according to the use made in the machine as one-way, two-way, emergency, safety, lowering, holding, self-locking, self-releasing and power releasing.

Brake, Band. A brake in which the element by which force is applied takes the form of an internally expanding or externally contracting band of flat or V-shaped cross section. Flat bands are often lined with fibrous material, or with wooden blocks; V-bands may have linings of wooden or bronze blocks formed in the V-shape. Brakes made of plain flat bands are often called strap brakes.

The pressure against the drum is usually produced by tension in the band, and this is caused by a lever acting on the ends of the band. One end of the band may be fixed and the other attached to the lever, or both ends may be attached to the lever on opposites of the fulcrum, but at different distances from it; this is called a differential brake, and with proper dimensions will act as a one-way brake.

Brake, Block. A brake in which a rigid block is fitted to the face of a rotating wheel and forced against it in order to exert a braking effect. In simple forms, the block is pressed against the wheel by a lever; where braking can be done on two adjacent wheels as in railway cars, the two blocks may be placed between the wheels and pressed apart by a toggle arrangement. A

single block brake produces pressure on the wheel shaft when applied.

When two blocks are applied on opposite sides of the wheel and pulled together to exert the braking effect, they are called double block, clam-shell, clasp or post brakes. In the clam-shell type the two blocks are hinged together at their adjacent ends at a fixed point and the other ends are drawn together by lever operated toggles; in the post brake the blocks are separately supported on the foundation or machine frame, usually standing vertically, and are pulled together by toggle-operated levers at their tops and bottoms.

Brake, Clam-shell. See Brake, Block.

Brake, Coil. A type of brake used in cranes as a lowering brake, consisting of a helical steel or bronze coil of rectangular cross-section, fitting inside of a casing and outside of a drum. One end of the coil is fastened to a disc which is keyed to the motor shaft at one end of the drum; the other end of the coil is fastened to the other end of the drum, and the drum is keyed at this same end to the shaft on which is located the pinion driving the winding or hoisting drum. The outer casing is free to revolve in one direction, that for hoisting, but a ratchet prevents reverse rotation.

In hoisting, the motor turns the disc in such a direction that it expands the coil against the inside of the casing, rotating it and also the brake drum by reason of its connection at the far end; thus all parts move as one, and the hoisting drum is rotated by the pinion. When power is shut off of the motor, the ratchet keeps the casing from rotating backward, and the load is held. If the motor is run in the lowering direction, the disc tightens turn after turn of the coil onto the drum, until the friction of the remaining ones pressing against the inside of the casing is insufficient, and can be overcome by the load tending to rotate the drum backward. When this happens, the coil is immediately expanded again, arresting the motion. During lowering this action is continuous.

The casing is made tight and filled with oil, lubricating all parts. Lugs are often placed on both the disc and the brake drum so that they will come into contact in case the coil is broken, and loads can be handled; some other brake must then be used for lowering.

Brake, Cone. A brake in which two concentric conical surfaces, one on a rotating part and one fixed, and one fitting within the other, can be pressed together for braking purposes. The angle may be such that only a small amount of axial pressure will be required to produce a large amount of friction, but should not stick, or require a pull to disengage the parts. Multiple conical surfaces may be used on the same discs, but at different radial distances, or, a preferable arrangement is an assemblage of single conical pieces on the same shaft, alternate ones being keyed to the shaft and to the surrounding casing. A slight axial pressure will then produce a large amount of friction on account of the many surfaces. This is called a multiple cone brake.

Brake, Disc. A brake in which a flat disc is mounted concentrically with a corresponding flat surface of the part to be controlled, and which can be moved axially and pressed against it for braking purposes. The arrangement is often modified so that the fixed disc is squeezed between two surfaces on the rotating part, giving double the braking effect for the same axial pressure. A further extension of the same principle leads to an assemblage of discs on one axis, alternate ones being fixed to the shaft and to the containing casing; slight

longitudinal pressure will produce a large amount of friction on account of the numerous surfaces. These are called multi-disc, multiple disc or multiple washer brakes; the principle is the same as used in the Weston clutch.

Brake, Electric. See Brake, Solenoid; Brake, Magnetic; Electric Braking, Electrical Definitions.

Brake, Load. See Brake, Lowering.

Brake, Lowering. A type of brake much used in cranes and other hoisting machinery, designed to keep the load from descending if the hoisting effect be removed, and to require an actual reversal of the direction of rotation of the hoisting motor to accomplish lowering. The braking elements are of the cone, disc or multiple disc types; the driving effort is usually delivered from the motor through one part of the brake which is threaded onto a screw attached to a second part which drives the hoisting drum. Between the friction surfaces of these two is a third part which has a ratchet and can rotate freely in one direction only. In hoisting, part one moves along the screw on part two, pressing the friction surfaces together harder and harder until they start to move as one, the ratchet on part three permitting this. There is no slipping during the hoisting operation. If the motor power is cut off and the motor comes to rest, the ratchet prevents part three, and therefore the drum and motor, from being rotated backward, and the load is held. If the motor is rotated by power in a lowering direction, it first starts to move part one along the screw away from part two; this removes the pressure from the friction surfaces, and the drum starts to turn in a direction to lower the load. This action, however, immediately screws the two parts together again, restoring the pressure on the friction surfaces until the braking effect is equal to the torque of the load, and it comes to rest. During lowering, this action is continuous, and the load is kept from lowering faster than the speed corresponding to that of the motor, without the latter being in any way driven or "overhauled" by the load. The ratchet holds part three in a fixed position during lowering.

The mechanism is arranged in numerous ways, but always involves the three parts, a screw or equivalent cam-shaped or helical surfaces, a ratchet and ring and friction surfaces. Also called screw brake, mechanical brake, load brake.

Brake, Magnetic. A brake in which the eddy-currents produced in copper or aluminum discs by the movement of one or more magnets having motion relative to each other, is used to produce a retarding effect on the rotating part. Either magnets or discs can be rotating, and the amount of braking may be controlled by the strength of the field produced by the electro-magnets. This device is expensive and complicated, and will not act satisfactorily to hold the load in a fixed position.

Also called an eddy-current brake.

Page 713.

Brake, Mechanical. See Brake, Lowering.

Brake, One-way. A brake which is automatically applied whenever a shaft starts to reverse its direction of rotation, but which offers no resistance to forward running, whether under power or "drifting." A solenoid brake for hoisting motor may be made a one-way brake by a suitable arrangement of the levers between the plunger and the brake, and will allow drifting in one direction only. An ordinary band brake with its ends connected to a lever at different distances on opposite sides of the pivot called a differential brake, will also

act as a one-way brake. A spring exerts a slight pull in the direction of application; forward rotation relieves practically all the friction due to this spring.

Friction ratchets (see Ratchet and Wheel) also prevent reverse rotation, but act practically instantaneously and allow no slipping whatever; one way brakes are less violent in their action and may be set to act as strongly as desired.

Also called irreversible or single way brakes.

Brake, Pinion. A brake applied to the pinion shaft of a hoist.

Brake, Post. A form of double block brake in which the blocks or shoes are placed on opposite sides of the wheel, in a vertical position, and are supported at points near their centers or at their lower ends by ties or struts to the foundation. The blocks or posts are connected at the top and bottom by ties in which there is an adjustable toggle connection by which the posts can be drawn together against the drum. The toggle lever may be worked by hand or foot, by a piston in an air or steam cylinder, by gravity or by a solenoid, a common and safe arrangement being to have the brake applied by gravity and released by some power means, so that any failure of the power will result in the hoist coming to a standstill rather than running free.

The rubbing surfaces of the posts are usually lined with wood blocks; if metal to metal contact exists, the post may be water cooled.

Post brakes are inherently two-way brakes, that is, they exert their braking effort equally in either direction of rotation.

Brake, Prony. A form of absorption dynamometer consisting of pulley, drum or brake wheel driven by the machine which is to have its output measured, with a band or block brake applied to it. The brake is supported in such a manner that its tendency to rotate with the wheel can be measured, and from this force, the radius at which it is applied and the speed of rotation, the power developed can be measured.

Brake, Screw. See Brake, Lowering.

Brake, Solenoid. A brake, usually of the band type, which is operated by the force exerted by an electric solenoid on its plunger or core. It is customary to have one of these brakes on the driving motor shaft of hoisting machinery, so arranged that the braking effort is applied by springs, but is relieved by passing the main hoisting current through the solenoid. Thus any interruption of the motor current, intentional or otherwise, will cause the brake to be immediately applied, and may prevent accident.

Page 713.

Breaking Pin, Break Pin. A pin used as a fastening at some point in a machine where it can be easily replaced, and intentionally made weak so that it will break under excessive stress, and save the machine from being wrecked by an accidental overload.

Bridge. To arch across or pack so as to stop flow; said of bulk material in a hopper or bin from which it is drawn off at the bottom.

Bridge, Ore. A term sometimes applied to a cantilever gantry crane especially adapted to handling iron ore to and from storage. (See Gantry, Cantilever Bridge; Crane, Bridge Storage.)

Bridge, Pick-up. A term sometimes applied to a bridge crane spanning a storage space for bulk material like ore and coal, and used as a means of reclaiming the material by lifting and conveying it by a grab bucket or by other means. The same bridge is usually the means

of placing the material into storage in the first place. (See Crane, Bridge Storage.)

Bridge, Rehandling, Stocking, Stocking and Reclaiming, Ore, Etc. See Crane, Bridge Storage.

Bridge Crane. See Crane, Bridge.

Bridge Drive. The motor, gearing, brake, shafting, and wheels by which the bridge of a traveling crane of the overhead or the gantry type is driven. One of the most important requirements of this drive is, that it shall move both ends at the same rate of speed. As the only resistances are rolling and axle friction, small power is needed, but on account of possible settling and unevennesses of the runways, and also on account of possible lack of "squareness" on the runways, with the consequent binding of the wheels on the track, considerable excess power must be provided.

The motor is usually mounted on the bridge drive girder, at or near the middle of the span, in order to equalize the effect of the twist of the shafting on the two ends of the bridge. There is usually a single gear reduction at the motor, and sometimes a double reduction. A further reduction takes place at the end truck wheels, where pinions on the bridge drive shaft mesh with gears attached to the wheels.

Bridge End, Bridge Truck. See Crane, End Truck.

Bridge Tramway. See Crane, Bridge Storage.

Bridge Unloader. See Unloader, Bridge Type.

Buck, to Break. To divide up or parcel out a material which has been in a bulk state, either for purposes of transportation or distribution. A grab bucket unloading a coal barge breaks bulk once if it delivers the coal directly to the storage pile; bulk is broken twice if the coal is dumped into a temporary storage bin from which it is removed by another grab bucket on a storage bridge.

Buck Scraper. See Scraper, Buck.

Bucket. A container for temporarily holding quantities of material in bulk while being conveyed from one point to another. They may be classified according to the method of filling, as top-filling buckets, bottom-filling or grab-buckets, and drag or drag-line scraper buckets; according to the method of dumping, as bottom-dumping, including grab-buckets, and top-dumping or turn-over buckets; according to the controllability of discharge, as bulk or automatic-discharge, or controllable-discharge; according to the form, as rectangular, flaring, round, etc.; and according to the material or use for which they are especially designed, as coal, ore, concrete, water, excavating, handling, mining, etc. They are sometimes provided with casters for rolling on the floor, and usually have a bail or rope attachment for handling by a crane, cableway, or some special form of hoisting device.

Page 301.

Bucket Back Plate. The steel plate forming the back of a shell of a clam-shell grab bucket. Its height is dependent upon the nature of the material to be lifted and the action of the closing mechanism. It is omitted in some types of scraper buckets.

Bucket, Bottom-Dump. A bucket which is emptied by opening or removing the bottom to allow the load to drop out. Strictly speaking, grab-buckets are included in this classification, but the term is usually applied to buckets having sides which are vertical or slightly flaring downward, and a removable bottom in one or more parts. One type has a bottom consisting of a door hinged at one side and kept closed by a latch which is released to allow dumping. Another type, rectangular in form, has two doors meeting along the middle of the bottom, which

in dumping move outward and downward under the control of a linkage. (See Bucket, Controllable-Discharge; Bucket, Center Dump.) Another type, called a gable bottom bucket, has two bottom doors meeting in an elevated ridge along the center, and opening downward and toward each other under the control of a linkage, dumping at the two sides of the bottom. Still another type is composed of two halves hinged at the top, something like a clam-shell bucket, but without the digging power possessed by this type. (See Bucket, Split.)

Page 311, 812-814.

Bucket Bottom Plate. The steel plate forming the bottom of a shell of a clam-shell grab-bucket. It is often reinforced with longitudinal strips to take the wear.

Bucket, Center-Dump. A bottom dumping bucket which has two doors meeting along the middle of the bottom, which when released move outward and downward under the control of a linkage, discharging the load through a middle longitudinal opening. The bucket is often operated by two ropes, one being attached to a bail fixed to the body, and the other to a sliding bail attached to the bottom door linkage. Hoisting on the latter closes the doors, and lifts the bucket by force applied directly to the bottom. Relative motion of the two ropes can be made to open the bucket to any extent desired. (See Bucket, Controllable-Discharge.) The doors may also be operated by hand levers.

When intended for concrete handling, it is often called a controllable-form bucket. It has legs to hold it upright when resting on the ground, and to support it when resting on the form, so as to prevent movement while being discharged.

Bucket, Clean-up. A grab bucket, usually of the clam-shell type, which is especially designed to recover all the material from the space in which it is working, as the hold of a ship, and leave the floor practically clean, without hand shoveling. These buckets have a very long reach, the lips are straight and close together tightly, and turntables are often used on the trolleys from which they are operated to enable them to reach every point of the floor space. They are often used in the holds of ships carrying ore or coal, and follow after the regular unloading grab bucket. Also called a "clean-up clam."

Bucket, Clam-shell. A grab-bucket in which the bowl is formed by two parts which close together like the shells of a clam, as distinguished from the orange-peel bucket, in which three or four segments come together at a point to make a truly spherical bowl.

The two parts of the bowl are termed shells, scoops, spades, bowls or blades. They are of various forms differing in details, but all have flat or nearly flat sloping bottoms and straight cutting edges, with the backs or back plates turned upward, and the sides sharply bent up at right angles. They are connected by arms formed as suitable stiffened continuations of the ends, pivoted together to a hinge shaft, or separately to a lower head. Corner arms (also called corner bars, links, purchase arms) from the back corners of the shells are pivoted together or to the top head at their upper ends, and the closing gear usually works by powerfully pulling the hinge shaft or the lower head toward the upper head. (For arrangements of closing gear, see Bucket, Grab; for methods of supporting and operating, see Bucket, Single-rope, Two-rope, Three-rope, Four-rope.)

Two-rope grab-buckets usually have their ropes in the

plane of opening and closing. The position at right angles may be secured by a different arrangement of sheaves in the boom point, trolley or traveler, or, in one or two types of buckets, by guide sheaves at the bucket head.

Page 305, 809-816, 829.

Bucket Closing Cam. See Bucket, Power-Wheel.

Bucket Closing Chain, Yoke End. A special arrangement of flat closing chain for a power-wheel grab-bucket, which is divided for a portion of its length, the two smaller portions being connected to the larger by a yoke, used to give greater closing power when the bucket is nearly closed. (See Bucket, Power-Wheel.)

Bucket, Concrete Elevator. A special tipping bucket used to elevate concrete in a temporary tower in the course of construction work, from which it is dumped into a receiving hopper and distributed by carts, chutes, etc. Some types are so shaped that they tend to tip forward all the time, but are prevented from doing so by a board along which slides a shoe or roller on the bucket; when this board is cut away, the bucket dumps forward. Another type is formed to keep its upright position unless tipped by a roller projecting from each end of the bucket near the bottom; these rollers run into curved cam grooves on reaching the dumping point.

The ordinary type of bucket requires that the receiving hopper project within the tower to receive the discharge. In one arrangement intended to obviate this, the bucket tips forward on two arms which are themselves pivoted and swing forward, thus moving the bucket forward so far that it reaches through the side of the tower and dumps into an outside hopper.

Bucket, Controllable-Discharge. A bucket which can be discharged gradually under the full control of the operator. Two-rope grab buckets have a controllable discharge, also two-line bottom dumping buckets either center dump or side dump. Center dump buckets may also be opened or closed by hand levers and give a controllable discharge.

Bucket Corner Bar. In clam-shell grab-buckets, one of the links which are pivoted at the lower end to points near the rear corners of the shells, and at the top to the top bucket head. These links guide the rear portions of the bucket shells during closing and opening, and force them to travel in the desired digging or scraping path.

Bucket Cutting Edges. The edges of the shells or spades of a grab-bucket which do the cutting into or scraping of the material. They are of hard steel, usually renewable, bolted or riveted either inside or outside of the shell, and if the work is especially severe made of manganese steel. Teeth of hard or manganese steel are also used for certain classes of work, these teeth being so located on the bucket halves as to pass between each other. Also called lips, cutting lips and reinforcing plates.

Bucket, Digging. A grab-bucket which is so proportioned as to have great digging power. This is generally accomplished by having cutting edges of the proper form presented to the ground at the proper angle, by the proper distribution of weight, and by having a large closing power or purchase. The last gives digging ability not alone through power to cut into the material, but because the pull on the closing-rope is then relatively small, and exerts little lifting tendency on the bucket as a whole, which would detract from its digging power. Digging buckets are also narrower, presenting a shorter cutting edge. The cutting edges are generally renewable, are of manganese steel for hardest work, and may be

fitted with teeth for certain kinds of digging. Also called excavating bucket.

Bucket, Four-rope. A grab-bucket which is carried by two holding-lines and two hoisting-and-closing lines. In one arrangement the holding-lines are dead-ended on an equalizer bar at the head of the bucket, and the closing lines are similarly fastened on the closing arms. The mechanism operates exactly as in the ordinary two-rope bucket, the advantage being that smaller and more flexible cables, and therefore smaller sheaves, can be used, often allowing a higher speed of operation.

In another arrangement sometimes termed a conveying grab-bucket, there is only one holding and one closing-rope, both being dead-ended at the far end of the runway from the winch, but the bucket hangs in bights of the two ropes, from a four-sheave trolley. This trolley is hauled along the jib or cable by a motor or drum independent of the hoisting drum, but controlled by the same operator. The holding rope passes around one sheave in the bucket head. The closing-and-hoisting rope passes around three sheaves in the lower head or on the hinge shaft, and two in the upper head, thus furnishing sufficient power for the closing.

In still another arrangement, used on inclined boom hoisting towers, the ropes are dead-ended in the trolley instead of the structure at the end of the runway. Thus, when the bucket has been hoisted against a stop of the trolley, continued winding hauls the trolley up the incline to the discharge point, where the bucket is dumped.

Bucket, Geared Power-Wheel. A grab-bucket having opening and closing mechanism which includes gearing. One type of bevel geared power-wheel clam-shell bucket has bevel pinions on the power-wheel shaft, meshing with bevel gear sectors on shafts to which are keyed the arms which operate the bucket shells through links attached near the back of the shells. Side bars or guiding arms attached near the front, guide the cutting edges together properly. It is a two-rope bucket, one rope being wound on a large diameter of the power-wheel for closing, and the other on a small diameter wheel for opening, which must be done by power. The power-wheel is enclosed in one of three compartments of a tight casing, the other two being occupied by the bevel gears, running in lubricant. Another type which gives a similar movement to the shells, has, wrapped around the power drum and made fast to it, closing chains which also lead partly around sheaves to the circumference of which the back part of the shell is pivoted. Partly around these same sheaves in the opposite direction are wound the holding-lines, for opening. The front edge of the bucket is guided as in the previous example.

Bucket, Grab. A container used for intermittent lifting, horizontal moving and depositing of bulk material, which automatically loads itself by opening at the bottom into bowl shaped parts arranged to dig into the material and finally shut together enclosing a certain amount of it. The grab-bucket is then lifted, swung to the desired position and there opened, depositing the load. The bucket may be supported by from one to four wire rope lines, for closing, hoisting, opening and lowering again, and is usually pendent from a crane trolley, boom point or cableway traveler.

A grab-bucket consists of a bowl formed of two, three or four parts hinged to each other or to a bottom bucket head. Another part of each portion is guided by links or slides, which are also connected to the top head of the bucket. A power-operated mechanism called the closing gear pulls the lower head toward the upper, swinging

the bowl parts together. Wire rope guide sheaves, rope fastenings, rope guards, braces, and equalizers and counterweights are important details.

Grab-buckets may be classified as follows: according to the number of segments into which the bowl is divided, into clam-shell buckets having two parts, or orange-peel buckets having three or four parts; according to the number of ropes on which they are hung as single-rope, two, three or four-rope buckets; according to the type of closing mechanism for obtaining the necessary power for digging into the material as power-wheel, power-arm, reeved-sheave, sliding cross-head, geared power-wheel, tongs, and motor-operated buckets; according to the use to which the bucket is to be put as digging, scraping or handling; and according to the material to be handled. Buckets for light material have large bowls; for heavy material like ore and limestone the bowls are small and are shaped so as to easily slide under the material.

Page 301, 809-816, 829.

Bucket, Hand-Dumping. A bucket which is turned over entirely by hand, or which has its dumping latch released by hand as distinguished from one which has its latch automatically operated by striking a movable stop or its equivalent.

Bucket, Lowering and Dumping. A turnover bucket which is dumped by lowering it until it rests on a surface or on the stock pile, thereby operating the latch, then raising it, when it automatically dumps, rights itself and re-latches. By dumping automatically so close to the pile, breakage of the contents is diminished.

Bucket, Mining. A round bucket used in shaft mining work, usually slightly tapering toward the top and bottom so as to avoid catching on projections in the shaft. It may have a top bail and be dumped by hand, or may have a bail attached by trunnions well down on the sides, and be dumped by releasing a latch at the rim of the bucket.

Bucket, Motor-Operated. A grab-bucket which is closed and opened by an electric motor. The bucket is raised and lowered by a single rope, or in the bight of the rope, or by two separate ropes dead-ended in the bucket head, or is provided with an eye for hanging on an ordinary crane hook. A motor is mounted just beneath the top head of the bucket, and is supplied with current by a cable conductor lead to it from the crane above or from any convenient point, a simple controller also being installed in a convenient position. The slack of the cable is often kept up by an automatic take-up (see Drum, Cable) mounted on the bucket itself or in some other convenient place.

The motor drives two chain sprockets in opposite directions, on the same shaft, by reduction gearing. The ends of a pitch chain are fastened to these sprockets, and an idler sprocket carried by the lower head rests in the bight of the chain. The motor revolves the upper sprockets slowly, winding up the chain and raising the lower head, thereby closing the bucket. Opening is accomplished by reversing the direction of rotation of the motor by means of the controller. A friction clutch is provided which will slip with excessive load, so that there will be no damage done if the current is left on after the bucket is fully closed, or if it closes on an obstruction.

These buckets may be opened or closed, partially or fully, at any position of the hoist.

Page 305, 808.

Bucket, Orange-Peel. A grab-bucket in which the bowl

is nearly hemispherical in shape, and is formed of three or four segments which come together in a point at the bottom. These segments are termed blades, spades or bowls, and have arms rigidly attached to them at points near the rim standing inward at right angles to the blade and pivoted to the bottom pivot head. At the base of these, toward the upper rim of the bucket, are pivots for long links or purchase arms which are attached at their upper ends to the top head. The closing gear is usually of the power-wheel type (see Bucket, Power-Wheel) and acts by pulling the bottom pivot head toward the top head, raising the ends of all the blade arms simultaneously and tilting the blades until they close together.

Rope reeved closing gear is also used, and consists of two sets of sheaves mounted on the bottom pivot head and top head, respectively. Rope is reeved around them, one end being dead-ended in the bucket; or, if desired, both ends are led out of the bucket, and one dead-ended on the overhead structure. (See Bucket, Four-rope.)

Page 307, 809, 812.

Bucket, Orange-peel, Dwarf. A small sized orange-peel bucket, used for operations where a small shaft or well is to be excavated, or where a pipe is to be sunk by excavating the material from within. It is similar in operation to the full size buckets, but, on account of its light weight preventing it from sinking into the material readily, it is often equipped with a hammer attachment when digging is to be done.

Page 307, 809, 812.

Bucket, Orange-peel, Three-sided. See Bucket, Orange-peel. These buckets are especially intended for grappling and raising objects of irregular shape. The upper corners of the blades are sometimes partly cut off, to save weight, or to allow it to be distributed in the part of the blade under greatest stress.

Bucket, Ore. A grab-bucket which is so proportioned as to be able to lift its bowl full of iron ore or like heavy material without overstressing its parts. The shells are also generally somewhat flatter on the bottom than those intended for lighter material, thus allowing them to slide under the ore more easily. If used for unloading vessels, they are often so shaped that they can scrape from the corners of the hold and clean up thoroughly, thus reducing hand shoveling to a minimum.

Also, a small steel barrel-shaped bucket with a bail, used for hoisting small amounts of excavated material from mine shafts by hand or horsepower, gasoline engine, etc. (See Bucket, Mining.)

Bucket Point. The point of one of the blades of an orange-peel grab-bucket. It is usually renewable, and, for hard digging, is of manganese steel, either bolted or riveted to the blade. (See also Bucket Cutting Edge.)

Bucket, Power-Arm. A clam-shell bucket in which the closing power is obtained by rope tackle pulling on a lever arm which is rigidly attached to one shell of the bowl, the other shell being forced to move simultaneously by means of the connecting linkage. In the two-rope bucket, which is the usual arrangement, the holding-line is fast in the bucket head. The closing-line passes in succession around a guide sheave in the head, and sheaves on the end of the power-arm and at the bucket head, and is dead-ended at the arm. More sheaves will give greater closing power, 3, 4, 5, 6 or more parts of closing-line being used. The power arm is also sometimes called the lever arm or closing arm.

Power-arm buckets tend to open excessively, and may also have an unsymmetrical action in digging or scraping, due to the inclined pull of the closing ropes during

part of their closing motion. Both of these tendencies may be corrected by a small auxiliary arm called an equalizer arm, secured at right angles to the power arm near the hinge shaft, and with its outer end connected by a link to a pivot on the bucket head. Or a bell-crank may be pivoted loosely on or near the hinge shaft, one end having the closing-line dead-ended on it, and the other being connected by a long link to a pivot at the bucket head.

Bucket, Power-Drum. The small drum on which the closing-line of a power-wheel grab-bucket is wound. (See Bucket, Power-Wheel.)

Bucket, Power-Wheel. A grab-bucket in which the closing power is exerted by chains or ropes whose upper ends are attached to the bucket head, and whose lower ends are wound on power drums of a small diameter. These drums (sometimes called cams) are attached to and turn with a larger drum, which has the closing-and-hoisting rope wound around and made fast or dead-ended on it; all three turn on a shaft which either serves also as a hinge for the two halves of the bucket (if of the clam-shell type) or is mounted on top of a lower part called the lower or pivot head, to which the bucket parts are pivoted. (This last construction keeps the power wheel up out of contact with the material to be handled.) When the closing rope is pulled, it unwinds from the power wheel, revolving it and winding up the closing lines, thereby pulling up the lower bucket head and closing the parts of the bucket together.

The closing-lines are made of crane chain, flat chain or wire rope, attached at the upper ends to the top head, or connected together and passed over an equalizer sheave or smooth equalizer saddle. They are also often fixed to the ends of a loosely pivoted bar, so that an equalizer effect is obtained, to put an equal pull in the two sides. Occasionally idler sheaves are fitted in the ends of the equalizer and the lines are passed through them and down to the hinge shaft ends, where they are made fast, thus practically doubling the closing power over that obtained with the more simple arrangement. If several sheaves are used on the top and bottom heads with the closing-rope reeved through them, the closing power may be still further multiplied. This type of reeving also allows larger power drums, which causes less wear on the wire rope generally used with this arrangement.

Another power wheel arrangement which can be made to give great closing power, is to have a closing sling of wire rope pass over a sheave supported by a swivel in the bottom of the top bucket head, and with its ends wound in opposite directions around and made fast to power drums of different diameter. These two drums are rigidly attached to the power wheel on which is wound the closing-and-hoisting rope. When this last is pulled, the drums are turned in such a direction that more rope is wound on the large drum than is unwound from the smaller, thus shortening the sling and raising the lower head, thereby closing the bucket.

Buckets of the types so far mentioned have practically the same closing power when wide open as when nearly closed, whereas maximum closing power is desired when nearly closed. If the proportions be such that the power wheel does not make more than one complete rotation, the power drums may be cam shaped, allowing faster closing at the beginning, with a slowing down and increase of power when nearly closed. The power wheel may be eccentrically located on its shaft with the same end in view. Buckets having closing lines made of flat chain

which winds in layers are subject to an undesirable loss of power at the end of closing, due to the increasing diameter; this is sometimes obviated by having each of the closing chains in two parts at the end toward the drum, attached at their outer ends to a yoke on the end of a single chain which leads to the top head. When nearly closed, the single part of the chain commences winding on the drum between the double parts, and at a smaller diameter, thus increasing the power.

In operating power-wheel buckets, two ropes are used (see Bucket, Two-rope), one fast in the bucket head, and one passing through a suitable guide and leading to the power wheel. Suitable guards protect the rope from contact with the material lifted while it is being wound on the wheel, and also keep it from jumping the rim in case the rope is accidentally slackened.

Bucket, Reeved-Sheave. A grab-bucket in which the closing power is obtained by passing the closing-rope or chain around sheaves in the top and bottom heads, and either dead-ending one end on a bucket head, or leading both out through guides in the top head, and dead-ending one on the overhead structure. (See Bucket, Four-rope.) If chain is used for closing, it is dead-ended in the bucket and the pulling end passes out through a fair-leader in the top head to prevent the chain from twisting.

In single-rope buckets of this type, guide bars are often used to make sure that the hook and latch of the closing gear engage properly. Also in reeved type clam-shell buckets where the shells are pivoted separately to the lower head, instead of on the same hinge shaft, guides are occasionally used to steady the lower head and make the shells move symmetrically.

Bucket, Scraping. A clam-shell grab-bucket which has a very wide spread between the shells when open, and a scraping action, rather than a digging action, as they approach each other in the act of closing. The cutting edges of the bucket are also extended further apart than any other part, so as to reach into the square corners of cars, holds of ships, bins, etc. Various closing arrangements are used (see Buckets, Grab), but the proportions and general appearance of the bucket are quite different from digging buckets. The shells are often called trays, on account of their open-ended form.

Page 307.

Bucket, Shovel. A name given to a form of drag line scraper bucket used for handling loose material like coal or ore in storage, which fills while being dragged up the side of the pile, and dumps its load by overturning on the pivots of a bail when a latch is released, like an ordinary top-filling turnover bucket. It is usually handled by a bridge storage crane.

Bucket, Side-Dump. A bucket which dumps at the sides of the bottom, by the opening downward of two doors which meet in an elevated ridge at the middle line of the bucket. The doors are connected by linkage and the bucket is handled by two ropes; one is attached to a sliding bail, which is connected to the doors, and the other is attached to a bail fixed to the body of the bucket. Relative motion of the two ropes opens or closes the bucket; simultaneous motion of the two raises or lowers it. Some types are opened and closed by hand operation of a lever.

Bucket, Single-Rope. A grab-bucket which is closed, raised and lowered by the same rope, some outside means being employed to open it for discharging the contents. While these buckets are less efficient in many respects than two-rope buckets, they are of great value in cases where only one winding drum is available, and

especially where the bucket must be frequently removed from the crane to allow it to do ordinary lifting work, as in foundries.

Bucket, Sliding-Crosshead. A grab-bucket (see Bucket, Clam-shell) in which the closing power is obtained by pinning the ends of the bucket arms to a vertically sliding crosshead, which moves in guides on the inside of an extension of the top bucket head. Other parts toward the back of the bucket slide in guides formed on this same extension. In the four-rope type, a sheave in the bucket head rests in a bight of the holding-rope, while the closing-rope passes from above directly down around a sheave in the crosshead, up around another in the head, down and up again, repeated if necessary, and out through the bucket head. Pulling on the closing rope raises the crosshead and closes the bucket.

Bucket, Split. A bottom-dumping bucket which consists of two separate parts connected only by hinges at the rim on two opposite sides. In lifting it is supported by chains located near the hinges; to dump, chains attached near the bottom on each of the other two sides are pulled, opening or splitting the halves apart along the bottom, and discharging the contents.

Bucket, Three-rope. A grab-bucket which has two holding ropes spaced apart by means of an equalizer at the head of the bucket, a third rope serving to close the bucket. In operation it is equivalent to the two-rope bucket.

Bucket, Tong. A clam-shell grab-bucket in which the two shells are mounted on the short ends of crossed arms like tongs; the closing-and-hoisting rope operates on the long arms of the tongs, and the holding rope is divided and attached directly to the back plates of the two buckets.

Bucket, Top-Filling. A bucket which is loaded by putting material in at the top, as distinguished from a grab-bucket which loads by scooping it up through the bottom, and a drag-scraper bucket which scoops it up sideways.

Bucket, Turnover. A bucket which is emptied by releasing a latch and allowing it automatically to overturn and discharge its contents. Owing to the relative location of the trunnions, and the center of gravity, the bucket automatically rights itself when empty, though it is top-heavy when full. Two forms of latch are in use; one called a bail latch or catch, which locks the bail at the rim of the bucket on each side, and is released by pressing levers there or at the top of the bail, and one called a back latch, back lever or tail latch, which prevents the bucket from tipping forward by a lever which is pivoted near the top of the bail and has its lower forked end resting on the rim of the bucket. The latches may be operated by hand, by hoisting the bucket against a fixed stop which raises the latch, or by lowering the bucket onto the pile and then hoisting it, the latch being operated by contact with the pile. (See Bucket, Lowering and Dumping.)

Also called tip bucket and tub. (See also Bucket, Coal.)

Page 309.

Bucket, Two-rope. A grab-bucket which is supported by two ropes, one of which closes and hoists it; the other holds and lowers it. The operation is as follows: the empty and open bucket is lowered by the holding rope, the closing rope being slack. When resting on the material, digging in and closing is caused by pulling on the closing line; continued pulling lifts the bucket, the holding line meanwhile being slack, or having merely

enough tension to keep it from jumping any sheaves. To open, pulling is stopped on the closing line and started on the holding line, or, the holding line is held and the closing line is slacked, allowing the bucket to open and discharge its contents. It may then be lowered opened, or, if desired, closed and lowered. It may also be raised open, thus allowing the repeated opening and closing sometimes necessary for hard digging. It may also be only partially opened, allowing the material to pass out through a narrow opening in the bottom, which is of value in such operations as loading wagons.

The two ropes are best operated from a two-drum winch, but where only a single winding drum is available and the purchase of a two-drum machine is not advisable, a separate holding drum may be used. (See Drum, Holding.)

Bull Gear. A gear used for slewing a derrick by power. It is fixed to the foundation, concentric with the mast step, and a vertical shaft pinion meshing with it and having its bearings on a platform at the base of the mast is turned by power to slew the derrick. Used in cases where the hoist is mounted on a platform fixed to the derrick mast at its base, and turning with it.

Bull Wheel. A device used for swinging a derrick by power. It consists of a wheel of considerable diameter, 6 ft. to 15 ft., secured to the base of a derrick in a horizontal position, and turning with it. Ropes or chains passing around its rim and attached to it are passed through guide pulleys and thence around the drum of a slewing winch. The wheel is held in a horizontal position by diagonal braces running from the rim to the mast, and slewing rods tie a point well out on the boom to the sides of the wheel by hinged connections, allowing the boom to change its inclination.

Bumped. See Dished.

Bumper Bar or Bumper. A bar arranged to prevent a crane trolley from running off the end of the bridge. Rail chocks on each rail are tied together at the top by a heavy bar across the tracks.

Bumper Block. A block, generally wood, fastened on the end of a car, truck, crane, or other wheeled vehicle, to prevent damage from striking fixed structures or other cars on the same track.

In overhead traveling cranes, bumper blocks are often fastened to the end of the crane trucks, to prevent damage from two cranes on the same track striking each other.

Bunker, Ashes. See Bin, Ashes.

Bunker, Coal. A space on a steam vessel where coal is stored for boiler room use. Longitudinal bunkers are located along the sides of the vessel between the boiler rooms and outer shell; cross bunkers extend from one side of the ship to the other.

Overhead bins used in stationary power plants for the storage of coal are often termed coal bunkers. Their capacity may vary from a day's supply to sufficient for several weeks, depending upon the other storage space available and the reliability of supply from other sources.

Bunker, Parabolic. A bunker of the suspension type, in which the transverse section of the shell corresponds to that of a parabola with its vertex downward.

Bushing, Self-lubricating. A type of bushing used with wheels, sheaves, etc., in places where oiling is difficult or likely to be neglected. It consists of a brass or bronze bushing with numerous holes drilled part or entirely through, the holes being filled with soft anti-friction metals or graphite preparations.

Busheler. A machine which feeds bulk grain or similar material from a bulk container or heap to a spout from which it may be bagged. It may work in connection with an automatic weighing or bulk measuring machine to measure definite amounts for filling each bag.

Bushing. A metal sleeve or hollow cylinder with relatively thin walls, which is forced into the bore of a solid bearing or of a part which rotates on a shaft or axle, in order to be able to make good the enlargement due to wear by replacing the bushing, and to furnish a good wearing metal for the bearing.

When forced onto a shaft or spindle, for similar purposes, the term sleeve or liner is generally used.

Bushings are also made in halves for ease of replacement, in which case lugs or lips are formed on them to prevent turning in their seats.

By-pass. A short cut, a special path which omits some part of a regular route or channel.

Cable. A general term applied to a rope or chain, and used more or less interchangeably with rope. Haulage ropes for cable-ways, and track-ropes used for overhead transportation are called cables, as are the supporting members of a suspension bridge. A rope of extremely flexible construction, made up of several smaller ropes laid together in what is termed cable lay, is also called a cable. Chains are often called chain cables.

Page 320, 818, 822.

Cable Car Haulage. A system of industrial conveying in which cars are moved along a narrow track by means of a cable. The cable may move continuously in one direction, the cars being attached and detached by operating grips; this is called the endless cable system. The car or cars may be pulled toward one terminal by one cable, and returned by another; various forms are the tail rope system, and the single and double shuttle cableway system. If operated on an incline, it is called a gravity inclined plane or an engine inclined plane system, according to whether the material is lowered by gravity or raised by power.

Cable Tramway, Monorail. An overhead monorail track conveying system in which one or more trolleys are pulled along the track by means of a traction wire cable. The circuit may be endless and the trolleys equally spaced or the traction cable may be endless and reversible, with one or two trolleys on the single monorail track. Also called a suspended cable road.

Page 271.

Cableway. See Aerial Cableway.

Cam. A mechanism composed of a rotating or sliding part which, by virtue of the shape of its curved edge, or a groove in its surface, gives oscillating motion to another part called a follower which moves in a straight line or flat circular arc.

Cam, Helical. A rotating cam which moves the follower in a direction parallel to the axis of rotation, the cam curve being traced on the surface of a cylinder. In some friction drum drives, a helical cam is used to press the freely revolving member (drum, gear, etc.) against the friction member which is keyed to the shaft, thereby causing them to turn together.

Cam Shaft. A shaft on which one or more cams are mounted, and by which they are rotated.

Cam, Tripping. A cam used on elevators, conveyors, etc., to produce some definite action when the moving part has reached a designated point, as the tipping of a bucket, the discharge of a load, the stopping or reversal of a motor, etc.

Cantilever, Adjustable, or Telescoping. A section of monorail runway carried by an underhung traveling crane on wheels or rollers in such a way that it can be slid out longitudinally when desired, and the trolley running on it thereby allowed to reach points beyond the runway which would otherwise be inaccessible. The adjustable section may be withdrawn to allow the crane to clear obstacles as it travels along the runway.

Capstan. A stationary vertical shaft concave drum machine for winding rope or chain, and used for hoisting or haulage purposes. The rope is wound around the drum a few times, and while the capstan is revolving a slight pull on the free end will keep it from slipping. Ridges along the barrel, called whelps, also help to prevent slipping. Operated by hand or power; if the former the drum is usually rotated directly by men pushing on bars set radially around the capstan head at the top of the drum. The men who walk in a circle while operating the capstan step over the ropes leading horizontally to and from the drums. Steam capstans are usually driven by a non-reversing steam engine connected by worm gearing. A pawl ring at the bottom of the drum has pawls dropping into the teeth of a ratchet ring set into the foundation, to prevent overhauling.

Capstan Head. See Winch Head.

Capstan Windlass. A combination of a capstan and a windlass used on shipboard. The capstan, often located on a deck above the windlass, is driven from the mechanism of the latter by bevel gearing.

Car, Batch. A car used in glass plants and similar places for receiving, proportioning, mixing and transporting a batch to a furnace.

Page 721, 722.

Car Dump, Automatic Push Back. An end tipping car dump in which the momentum of the loaded car is utilized to compress powerful springs, which move the empty car back off the dump after its contents have been discharged.

Car Dump, Cross-over. An automatic end-tipping car dump in which the loaded car runs onto a pivoted section of track so supported and counterweighted that it overcomes the counterweight and tips downward and forward, discharging its contents through a top hinged front end gate. The counterweight is sufficient to raise the track section with the empty car back to the proper level. It stands there until the operator allows the next loaded car to run forward toward the dump; this car depresses another short section of track, which evolves horns from in front of the wheels of the empty car, thereby releasing it and permitting it to run forward and across the dump when struck by the slowly moving loaded car. As the latter moves off the depressed section of track, springs return the track to its normal elevation and the horns to their position ready to stop the car at the dumping point. The operator controls the speed of tipping by a brake, and feeds the loaded cars forward one at a time.

Page 636.

Car Dump, Goose-neck. A simple end-tipping car dump in which a short section at the end of the track is mounted on a platform which can turn about a transverse horizontal shaft; the front ends of the rails being turned up in a curve which fits the tread of the wheels. The car runs on the platform against the steps, tipping the platform and dumping the contents out the front end through a top swinging gate. Spring journal boxes are often used to support the shaft and prevent damage due to shock. The car is returned by a cable or other convenient means.

Car Dump, Horn Dump Type. An automatic end-tipping car dump in which the loaded car moves onto a curved track so inclined that the contents of the car will slide out forward through a top hinged front end gate. To control the speed, and give the necessary time for the discharge of the contents, two horns on a horizontal shaft engage the front wheels of the car as it starts down the incline. A lever controlled band brake on this shaft enables the operator to bring the car to rest in the dumping position, where it is held by another lever which engages an extension of the horns.

When empty, the car is released, and runs on down the incline, to be replaced by another loaded car.

Car Dump, Movable. See Car Dump, for Standard Gage Cars.

Car Dump, Rotary Gravity. A sidewise inverting car dump consisting of a three-compartment cylindrical steel frame which is caused to rotate by the excess in weight of the loaded cars on one side over the empty ones on the other, the contents being discharged during the rotation. The frame is either mounted on a central shaft or surrounded by circular tracks which are supported on rollers. Each compartment contains a car and is provided with end stops and longitudinal guides to hold it in position. As a loaded car rolls in, it pushes out the empty one. The dump is locked in the proper position for the tracks to register during motion of the cars; its speed of rotation is controlled by a hand-operated brake. A pan or hopper beneath receives the material as it is dumped, and owing to the shape of the dump can be placed so close that breakage is minimized.

Page 635.

Car Dump, Rotary Power. A sidewise inverting car dump consisting of a long tubular framework, into which one or more loaded cars can be run on a track, and which is then revolved about a longitudinal axis, the contents of the cars falling out through suitable openings in the structure. Longitudinal guides are built into the dump to hold the cars on the rails, and stops are placed to prevent the cars from moving endwise during dumping. The dump has circular ring tracks built about it, and is supported on rollers or roller bearings. One or more of these rings have gear teeth formed in them and serve as a means to rotate the dump by gearing driven from a motor or engine.

Page 635, 825.

Car Dump, Steam, with Cross-over. A non-automatic end tipping car dump in which the loaded car runs onto a tipping platform, at the front end of which are stops for the wheels. The rear axle is then raised by Y-shaped supports which are forced upward by a steam cylinder, dumping the contents of the car through a swinging door in the front end into a chute between the rails. When the car is lowered, the stops move out of the way and the car runs forward onto a continuation of the track.

Car Dump, Swing-lift Transfer. An automatic end-tipping car dump used in connection with a chain haul up an incline and a superposed track for returning the cars down the incline.

The loaded car is pulled up the lower runway by cross-bars on chains which pass around sprockets at the top and bottom of the slope. As the car approaches the upper sprocket its wheels run off onto a guide sharply inclined upwardly, and carried by a tilting frame. The top hinged door at the rear is simultaneously released, and the contents commence sliding out. As the crossbar (which is not attached to, but merely pushes the car) passes onto and around the sprocket, it pushes the car completely

onto the tilting frame, and then tilts the latter upward, until finally the guides on which the wheels rest are in line with the upper (return) runway. The car then runs off the tilting frame and follows the crossbar down the slope, while the tilting frame returns to its original position, ready for the next car.

Car Dump, Tandem. A car dump which will handle two or more cars on the same track, dumping them simultaneously.

Page 280.

Car Dumper. A device for unloading an open top car by partially or completely inverting it, or by tipping it endwise or sidewise to such an angle that the contents will slide out through a swinging end or side door.

Standard gage railway cars are of various lengths, heights and capacities, and are not always provided with bottom dumping arrangements; a car dumper must therefore be able to handle all varieties of cars, and in this country a common solution of the problem has been a dumper which elevates and inverts the car sideways. (See Car Dumper for Standard Gage Cars.) In some localities, especially abroad, where cars are provided with swinging end doors, the car is tipped endways and the material allowed to slide out; swinging side doors will similarly require the car to be tipped sideways.

Two types of these tipping dumpers, tips or tipples may be distinguished; the automatic, in which the center of gravity of the car as a whole is lowered just previous to discharging, and the work done is stored up in lifting a counterweight or forcing a liquid into an accumulator, storing up sufficient energy to raise the empty car back to the track level; and the non-automatic in which the car is raised before dumping, requiring outside power for the purpose. The first, while using no power, and controlled by brakes alone, requires considerably increased elevation of structure over the latter, or else a receiving pit from which the material may afterward have to be elevated by other means.

Mine and industrial cars are usually much smaller than standard gage cars, and the dumping system, end or side, is adapted to the type of car. There are several forms of automatic end dump, known as the cross-over dump, the horn dump and swing-lift transfer dump, also some non-automatic end dumps in which the car is tipped up by power. Rotary dumps invert the car sidewise; the rotary gravity dump operates by gravity, the driving force being the weight of the coal discharged, while the rotary power dump requires power from an outside source.

Page 635, 825, 828.

Car Dumper for Standard Gage Cars. A machine for unloading open top railway cars of coal or similar bulk material by inverting them sidewise. There are two types; the turnover dumper which does not lift the car except to rotate it about an axis, and the lifting dumper which elevates the car for discharging direct into vessels or high storage bins.

The loaded car (sometimes two are left coupled together and handled as a unit) is pulled up an inclined approach by a mule or barney car and runs onto an L-shaped dumping cradle. It is clamped fast to the cradle by beams pulled down against the top of the car sides, or by wire ropes. Cradle and car are then raised to the desired dumping level (which is sometimes adjustable), and rotated through a sufficient angle to completely discharge the contents, the top of the cradle forming a chute which directs the material. They are then returned to their original position, the car is released

and the next loaded car pushes it off in the other side of the dump where it runs down a short incline and is returned alongside the dumper and back to the yard by a kick-back.

The lifting and rotating is performed largely by wire ropes handled by winding drums. Steam and electric drives are both in use, the former being the better in isolated localities, and the latter being more economical where there is a reliable source of direct current.

The dumper is often movable, traveling on rails parallel to a bin over the wall of which it can distribute the material as desired. It is usually self-propelled, and the inclined approach and discharge tracks travel with it.

Page 279, 825, 828.

Car Dumper, Cane. A tilting platform used to side or end dump the special cars used on plantations for hauling cut cane to the mills, the cane sliding into a depressed hopper from which it is conveyed to the rolls. The cars are clamped to the platform, often by hooks beneath the car body, and the dumps are operated by steam, hydraulic or electric power,—often a combination of electrically driven pumps with a hydraulic operating cylinder.

Page 279.

Car, Gathering. In glass manufacture, the name given to a car which collects from various bins the proper ingredients in proper proportions for a batch, and either mixes them in a conveyor mounted on its own body, or delivers them to a fixed mixer. Also called a batch car.

Car, Monitor. A name sometimes applied to a special car used for lowering coal (or other bulk material) down an incline, generally by means of a gravity plane drum. The cars are usually in pairs, one serving to counterbalance the other. Coal is dumped into the monitor car from a mine car at the top, and it in turn discharges to a weigh-hopper at the tippie, through a dumping bottom.

Car Haul, Cable. A method of hauling cars up an incline by means of an endless wire rope having spurs clamped to it at regular intervals for propelling the cars, and intermediate transmission clamps for assisting in driving the rope. The latter passes around a large driving sheave in the form of a gap wheel at the top of the slope, this wheel having a grooved circumference with breaks in it to receive the spurs and transmission clamps.

Car Haul, Chain. A method of hauling cars, generally up an incline, by means of an endless chain having hooks, dogs or spurs which engage with the axle of the car or some other convenient part, and push it along the track. As the car passes over the head of the slope and onto a slight downward slope, it runs ahead of the chain which passes around a sprocket and returns to the foot. The same device, run in the opposite direction, serves to lower cars down an incline. The cars should be fed to the bottom of the incline at approximately the speed of the chain to avoid shock on chain or car; to prevent any possibility of the car starting to back down before a dog has reached and engaged it, the dogs are often spaced close together; they are also made with a gravity or spring controlled tilting part which will allow a car to run past them in a forward direction, but not to return.

Page 636.

Car, Industrial. A general term used to designate the many different types of cars used for industrial purposes.

Page 587, 721-725.

Car Puller. A machine placed near railroad tracks, and used to locate or "spot" cars for loading or unloading purposes by the pull exerted on a rope attached to them.

The machine may be of the winch head or capstan type, round which the pulling rope is given a few turns, the free end being gently pulled by hand as it comes off, or it may be of the drum type, in which the rope is made fast to and wound up on the cylindrical drum. The rope is usually manila, though wire rope is sometimes used. A vertical winch head or drum has the advantage over the horizontal one that the rope may be led off in any direction.

A car puller may be driven by a belt from a line shaft, or by a separate electric motor, or steam, gasoline or air engine. The necessary speed reduction from the motive power to the drum shaft may be made by gearing of the spur, bevel, worm or chain varieties; planetary gear reductions are also used. Several drums are sometimes mounted on the same base, with or without friction or jaw clutches. A single drum puller is sometimes mounted on a small car traveling on the car rails, and provided with rail clamps for holding it in position when in use; the source of power is then a gasoline engine or an electric motor "plugged in" to conductors along the track.

In mines portable car pullers located in the rooms are used for pulling the empty cars into the rooms and the loaded ones out, the main hauling locomotive (electric or air) not entering the rooms. This is also sometimes done by power driven winches mounted on the locomotive itself, the cable being suitably led by guide sheaves.

Page 296, 787, 790, 829.

Car Pusher. Any device which can move cars along a track for the purpose of loading or unloading, by pushing them from behind. One device consists of a special narrow car running on a special narrow gage track between widely spaced railway tracks; the pusher is operated by a fixed cable between the rails passing around motor operated drums on the pusher, or by power applied to the wheels by gearing from a motor. An arm which can be thrust out on either side of the pusher over the adjoining tracks enables it to move cars along ahead of it.

Car Stop, Automatic. A mechanism for feeding loaded cars one at a time from a string, as in caging at the bottom of a mine shaft, or at a car dump. On pressing a treadle, horns projecting above the track in front of the leading car are depressed, allowing it to run forward down the inclined track. As it moves, it depresses a portion of one or both rails, replacing the horns and holding back the next following car.

For caging cars at the bottom of a shaft, two pairs of horns open alternately, one pair always being closed. The device is operated by the cage, so that a car cannot get past the front horn until the cage is in a position to receive it.

Carbureter. A part of a gasoline engine in which the fuel is vaporized and mixed with the proper quantity of air for perfect combustion. Air is drawn through it by the suction from the engine cylinders, and the suction also causes the fuel to flow in a jet into the air as it passes. The proper proportion of gasoline to air, by weight, is one to fifteen, and the aim in the carbureter design is to obtain this proportion at all loads and speeds of the engine.

Cargo. The goods, merchandise, material or whatever is conveyed by a ship.

Car Door. A door fitted in the side or upper bulkhead of a vessel for the purpose of providing a passage through which cargo may be trucked.

Cargo Handling Gear. The arrangement of derricks, hoists, and tackle used on shipboard for moving cargo to and from the hold. The vertical pole mast of the vessel is used as the derrick mast, or a special mast, called the derrick post or king post, is installed. Two or more derrick booms are fitted to each mast, each with its own hoisting drum or separate winch. (See Derrick, Ship.)

The same term is also often applied to wharf cranes and other loading or unloading machinery, when located on the wharf instead of the ship.

Cargo Hatch. A deck opening leading to the hold of a vessel.

Cargo Net. A rectangular net made of rope or chain and used as a means of handling loose or package cargo to and from the hold of a vessel. The net is spread, the packages piled on it, the hoisting tackle attached to the four corners, and the whole then lifted.

Cargo Port. An opening in the side of a vessel for loading or unloading cargo. It is closed by water-tight plating except when in use for handling cargo.

Carrier. In general, any device which supports or contains an article while it is being transported from one point to another, and which is usually transported with it. In material handling, the term is often applied to overhead runway trolleys, to cable trolleys, and to certain types of bucket conveyors which will carry material with one loading, horizontally, vertically, or on an incline with equal facility.

Carrier, Open Top. A term sometimes applied to an intermediate type of apron or pan conveyor with deep and overlapping pans designed to convey on the level or on slopes too flat for bucket elevators, and too steep for flight or ordinary steel apron conveyors.

Carrier, Pick-up. A term applied to a conveyor for flat envelopes or round cylindrical carriers, consisting of a series of cars attached to an endless driving cable and sliding on round steel guide rods. The cars each have two gripping jaws; one is stationary relative to the car, and the other is operated by a cam surface at a station in such a way as to drop to a receiving shelf a load already gripped and pick up another if placed on the sending shelf. It may be made selective if desired.

Carrier, Pneumatic Tube. The small special container for material to be conveyed in a pneumatic tube system. It is usually cylindrical in form, with a round or elliptical cross-section and is made of metal, hard fibre or leather, with a hinged or sliding door or other means of access. The ends are somewhat larger in diameter than the body, to allow the carrier to pass easily around curves in the tube, and these enlarged ends are either formed in one piece with the body, of hard fibre, or are made by adding leather, fibre, rubber or other similar materials.
Page 763.

Carrier, Suspended Tray. A continuous carrying device used for elevating, lowering, horizontal conveying, or various combinations of these, and consisting of two endless strands of chain with pivot attachment links from which are suspended by short diagonal hangers at the ends a tray or pan on which articles may be placed. Loading and discharge are best accomplished automatically on ascending or descending vertical runs respectively (see Elevator, Suspended Tray), but hand loading and unloading may be performed at any desired point.

In the horizontal runs the supporting chains slide along

guiding surfaces, or, if provided with rollers, run on guide rails.

Page 336, 761.

Carrier, Sweep-off. A basket type of conveyor for small objects, envelopes, etc., consisting of two wheeled cars running on a track and secured at intervals to an endless hauling cable. A basket hangs beneath, with guides to prevent it from swinging, and suspended in such a way from one side that it can pass close beneath a shelf on which articles are placed and receive them as they are swept off by a brush or scraper passing above the shelf. The basket has a hinged bottom, and dumps its load when automatically unlocked at the receiving station. It thus acts as a collector; it may also be made selective for sending by having several shelves at the sending station, all kept out of the way of the baskets, except when the proper one comes along, when a catch is tripped and the shelf is swung into correct sending position.

Carrier, Troughing. See Conveyor, Belt, Idlers for.

Carrier, V-bucket. See Conveyor, Gravity Discharge V-bucket.

Carrousel. A form of apron conveyor which travels entirely in a horizontal plane, making turns at the ends about a vertical axis and (usually) returning parallel to itself. Objects set upon it travel around continuously until removed, thus affording storage area on what is virtually a moving work table. The cross pieces are not parallel sided, but are tapered toward the inside of the curves, so that they can pass around them. Instead of wooden cross pieces, stands for bottles or trays, pans, etc., may be used, as best suits the material handled. A carrousel is usually driven by a chain along the center line beneath the cross pieces and they are supported by rollers running on girders at the sides.

Also called a carry-all.

Page 406.

Carry-all. A name sometimes given to a horizontal platform conveyor at about table level so arranged and driven that at each end it makes a short turn through 180 deg. and returns parallel to itself, thus furnishing a continuously moving table, from which objects may be taken as they pass, or, on which they can be left until they come around again.

Cart, Pick-up. A two-wheel cart having an axle arched upward in the middle and a long tongue secured to the axle at the arch, part of the tongue overhanging the axle toward the rear and ending in a hook. This hook is lowered by raising the long end of the tongue and an object is made fast to it by chains or ropes; it is then lifted by pulling down on the tongue. If one end of a log is lifted, the tongue is lashed fast to the log, and both can then be hauled away.

Castor Bed, Plate. An assemblage of strong swiveling castors mounted, wheels upward, on stiff posts spaced about 20 in. centers each way, with the top of the wheel 2 ft. 6 in. to 3 ft. 6 in. above the ground. Steel plates laid on these beds may be moved about with great ease by one or two men. Placed at the proper height, they allow easy feeding of punches, shears, etc.; placed in long rows they aid in transportation from one machine to another, and even serve as a storage space for partially finished work.

The castor wheels and swivel bearings are generally of the ball or roller bearing variety, and the bearings are so arranged that particles of dirt or rust cannot drop into them.

Cellar, Oil. A chambered cavity beneath wheel shaft bearings, to receive and hold oil.

Center of Gravity. That point of a body at which, if the whole mass were concentrated, the action of gravity on the body would be unchanged.

Chafe. To destroy, damage or wear away by a rubbing action, as to chafe a rope.

Chain. A flexible connector used for transmitting power or for hauling or lifting, consisting of separate oval links connected through each other in succession, or of variously shaped parts attached to each other by pins or rivets in such a way as to permit the desired degree of flexibility.

The oldest and simplest form is the oval link, made of iron or steel of a round or square section, and in links of widely varying proportions. (See Chain, Coil.) It is much used for hauling and hoisting, for fastening, and, to a small extent, for transmitting power. It has the property of being perfectly flexible in any direction, can be wound on drums, passed around guide sheaves, or piled in a bin, and where these properties are required is the only type to be used. Except when wound on a drum, it must pass around sprockets or pocket wheels for a pull to be exerted. It is practically the only form suitable for a hand chain.

Where flexibility in only one plane is required, chains are made of links connected by pins in such a way that there is a point of articulation or hinge at each pin. They are made in an enormous variety of forms, sizes and materials for various uses. Practically all are composed of links having parallel holes at the opposite ends to receive the connecting pins. In some cases the links are all identical and of the form termed the closed end link; in others two forms alternate. They are produced by being cast, forged, rolled, bent or stamped.

Attachments may be made to chains in various ways, attachment links being ordinarily inserted when the chain is made up, shaped to suit the work. Rollers are provided on many chains, either to lessen the friction and wear at points of contact with sprockets, or, where a chain run is horizontal, to support the weight of the chain and attached parts and carry it on a guide or rail.

The design of a hinged chain is largely dictated by the use to which it is to be put. If intended simply for holding or slow pulling, where the wear of the joints will be inconsiderable, simple joints will suffice, but if moving at considerable speed, as in conveying work, and especially if transmitting power, careful attention must be paid to proper lubrication, minimum friction, and easy replacement of wearing parts. Any increase of pitch in a chain passing around sprockets spoils the fit on the latter and causes poor running; therefore, wear which tends to increase the pitch and lengthen the chain must be prevented as much as possible, by liberal bearing area, hardened surfaces and lubrication.

Chain, Block. A steel chain used for power transmission, made up of center blocks and side bars, connected by shouldered pins riveted fast in the outer links and turning in the holes in the block. It cannot be provided with rollers. As ordinarily made the links are of steel punchings, or stampings, machined in the better grades. In modified types, the side bars may be drop forgings or malleable castings, with hubs which project into counterbores in the block and thus carry the load independently of the pin. The latter may then be a bolt, allowing detachment of the chain at any point without the necessity of slack.

The blocks may also be specially formed with cavities

in the middle in which rollers may be placed and held by pins passing through the block crosswise; these rollers serve to support the weight of the chain in conveyor service.

Page 774-780.

Chain, Cable. A chain consisting of flat elongated oval links made by welding round iron or steel. When accurately pitched it is used for conveyors and log hauls.

Chain, Close Link. See Chain, Coil.

Chain, Closed Link, Closed End Link. A hinge type chain composed of links each of which has its two sides and one end formed of a single piece, usually of malleable iron. They are made for short, medium or long pitch chains, and are connected to each other by rivets or detachable pins. The latter may be of ordinary, case hardened or manganese steel; they may turn in a smooth hole across the closed end of the link, or in a hardened or manganese steel bushing forced into the hole in the end of the link. The pins are kept from rotating relative to the open ends of the link and therefore wearing the holes in it oval, by a notch or flat on one side of the head engaging with a projection on the side of the link, or by a T-head pin fitting into a milled groove. The links are usually of malleable iron, but may be of cast or manganese steel.

The side bars at the open end of the link may be smooth inside, simply lapping over the closed end of the next link, or they may have shallow counterbores on the inside around the pin holes, which fit on to corresponding projections on the sides of the next link, thus relieving the pin of part of the shearing stress and, more important, keeping dirt out of the joints. If made with detachable pins, the links can be separated, but the open end of the link must be spread forcibly to allow it to slip over the projections. This is known as interlocking chain. In another type the two parts of the open end are kept from spreading by projections cast on the next link and hooked over these ends.

In one variety of this chain intended for service in gritty material, the tubular shaped end or thimble which connects the two side bars at the closed end is largely cut away so that the bushing is exposed and can receive the wear of the sprocket teeth. Bushings and pins being renewable, the chain will be very long lived. If used as a drag chain, the lower faces of the links of a chain are made flat to give large wearing surfaces.

Chain, Closed Link Roller. A chain resembling the closed link chain, but with a roller placed on the cylindrical portion of the closed end so that no portion of the link comes into contact with the sprocket. To put the roller in place, the two sides of the link must be made separate, and they are assembled with the roller in place; the two portions of the closed end telescope into one another, or may be simply butted; they are kept from separating by the pins.

This chain may also be made with interlocking joints. (See Chain, Closed Link.)

Chain, Coil. Chain composed of oval shaped links made from round stock. The most common form has the plain oval links, with adjacent links standing at right angles. A 90 deg. twist may be put in each link so that they all occupy the same position, making a twisted link coil chain. If the chains are to be used in such a way that kinking would be a serious disadvantage, short studs are inserted in each link across the middle of the space, making stud chain.

The links vary in length according to the use. Stud chain has a maximum length inside the link of about

four diameters of the bar from which it is made; standard close link and coil chain have a length of about three diameters; crane chain has a length of about two and five-eighths diameters, the shorter the better.

Chain, Coil with Wearing Block. An accurately pitched long oval link chain in which detachable bearing blocks are placed between the adjacent links in such a way that the wearing surface is largely increased, the links are kept at right angles with each other, and the strength of the chain is increased. These blocks have semi-circular grooves on opposite sides in planes at right angles, and may be inserted into a link without deforming it. With this type of chain, attachments may be formed on the blocks. Also called Dodge chain.

Chain, Combination. A chain composed of a series of center links and pairs of side connecting links or bars alternately placed. The center link is a closed rectangle, with transverse holes for the connecting pins in each end; the connecting pins are kept from turning in the outer side bars by having key lugs, fitting into notches in the side bar, or by having square shanks fitting square holes.

Chain, Combination U-Bar. A combination chain in which two connecting pins and one side bar are formed in one U-shaped piece of round section steel, with the remaining side bar slipped over the ends and cottered fast.

Chain, Detachable Link. A chain composed of links which are rectangular in outline and formed with a hook across one end which will slide edgewise on to the grooved end of the next link, and articulate on it. This sliding can take place when one link is turned up at right angles to the other; when they are in working position, or in line, they cannot be thus detached. The two ends of a strand of chain can be connected by a special coupler link having a pin. Also called plain link belting, detachable sprocket chain, and rivetless chain.

The links are usually made of malleable iron, though manganese steel is sometimes used. The chain has the disadvantages that under heavy stress the hook opens out, and gritty material can work between the rubbing surfaces and cause wear; the pitch increases from both causes and the chain then no longer fits the sprockets.

Chain, Drag. A conveying chain made up with very wide links and laid flat in the bottom of a trough where it drags along any material which is placed in the trough on top of it. The links are usually of the closed end type, of malleable iron castings, or formed from steel strip; the pins are riveted or detachable. If the cast form is used the lower faces of the links are made broad and flat to give a better wearing surface. Wings, flights or other attachments may be used to increase their effectiveness.

If the links are formed from steel bars of rectangular section bent to shape, they may be made in a plain U-form. The sides are often reinforced at the points where the pins pass through, to give greater wearing surface, and these doubling bars may be bent into a variety of forms to serve as wings or flights.

Also called refuse chain and sawdust chain, the last because it is largely used to remove sawdust and similar refuse from saw-mills. (See Conveyor, Drag Chain.)

Chain, Drop Forged Steel Bar. A chain made up of drop forged bar links with enlarged ends, the links being arranged in alternate pairs inside and out, and connected by riveted pins, shouldered to prevent cramping of the inner links. Used for heavy loads at low speeds and in places where a long pitch chain is desired; if the pitch is short the cost of the forged links is out of proportion to the metal saved.

Chain, Flat and Round Link. A chain made up of alternating welded links of two styles; one is a rectangular link made of round stock, and the other is an oval link made of flat stock bent flatwise and hooked over the adjacent ends of two of the round bar links. In use for conveying, this chain presents the broad surface of the flat link to resist wear from dragging. Sometimes called steel conveyor chain.

Chain, Hand. A chain, generally pendent, used for operating crane or other machinery by hand. It is usually of the close oval link variety, or crane chain, and should be of a convenient size for grasping.

Chain Hoist, See Hoist, Chain.

Chain, Interlocking. A chain made of closed links which have the two sides at the open end so formed with counterbores on the inside that they hook over corresponding projections on the next link, locking the links together independently of the shearing resistance of the pins. (See Chain, Closed Link.)

Chain, Load. The chain by which a load is lifted or supported. In chain hoists the load chain passes over chain sheaves or pocket wheels made to fit it and is lifted by them. In drum type hoisting mechanisms, the load chain is attached at one end to the drum, and is wound on it as the load is lifted. It is made with short links, known as close link or crane chain, to minimize bending stresses in passing around sheaves and drums.

Pitch chain, made to fit toothed sprockets, has also occasionally been used for lifting loads.

Chain, Monobar. A long pitch chain consisting of a series of bolts with clevis connections screwed on to the ends and connected to one another by pins. Attachments may be formed on the end connections, and in case of wear the end connections only need replacement.

Chain, Pitch of. The distance from a point on one link, as its center, to the next similar point. In chains which have links of one form only and similarly placed, one link only is included in the pitch; in chains consisting of alternating links of different form, or of alternating links of the same form but standing at right angles, two links are included. This corresponds to the pitch of the teeth on sprocket wheels, which includes sometimes one and sometimes two links.

Chain, Pitch or Pitched. A chain which is made with care so that the distance from one link to the same point on the next one is the same at any part of the chain. The term is applied to coil or oval link chain which has been made with unusual accuracy in this respect so that it may fit properly around sprockets and pocket wheels. It is also often used to designate any of the hinged or articulated chains which are made to be operated on sprockets, and therefore must have uniform pitch.

Chain, Punched and Riveted Steel. A narrow unbushed chain which is made up of alternate pairs of flat steel links placed inside and out, the inside links being separated by a thin washer or spacer. Rivets pass through the four bars, no rollers or bushings being used. Occasionally the two inside links are replaced by one link of the combined thickness, making practically a narrow block chain.

Also called hog scraper chain, and ice chain.

This chain is suitable for heavy loads at heavy load speeds, or for intermittent use, but the lack of wearing bushings makes it unsatisfactory for high speed.

Chain, Refuse. See Chain, Drag.

Chain, Roller. Any articulated or hinged chain which has rollers included in its construction to minimize wear

or decrease friction. (See Chain, Steel Bushed Roller; Chain, Closed Link Roller.)

Chain, Roller Carrier. A roller chain having side links curved so that the rollers are below the top of the links, and will not interfere with objects resting on a horizontal run of the chain or with slats attached to them. The roller is sufficiently large to project below the links at the bottom and runs on the guide or rail.

Chain, Silent. A term applied to a steel chain made up for use as a belt for transmitting power between two wide faced sprockets on parallel shafts. It usually consists of a series of small flat links or leaves connected by joints having hardened segmental bushings and case hardened pins, or by joints in which one part rocks or rolls on the other as the links articulate in passing around sprockets.

Another feature of these chains is the pointed ends of the links which are turned toward the sprocket and engage with the straight teeth of the latter. Owing to the sloping sides of the sprocket teeth, the chain can ride higher on them as it wears and increases in pitch, thus automatically adjusting itself to the lengthened pitch.

Chain, Steel Bar Bushed Roller. A chain having articulations like those of a steel bushed roller chain, but with very much longer links.

Chain, Steel Bushed. A chain similar to the steel bushed roller chain, but without the roller. The wear from passing around sprockets thus comes directly on the outside of the bushing.

Chain, Steel Bushed Roller. A chain composed of pairs of flat steel side-bar links placed alternately inside and outside. The inner links have riveted between them at each end, bushings or thimbles which are kept from turning by the form of their ends. A loose cylindrical roller is placed around the outside of each of these bushings between the inner side bars, and a pin passing through the bushings extends at its ends beyond the inner side bars and into the outer bars, and is attached to the latter in such a way that it cannot turn. The device used is a lug key, or a notched, flat sided or T-headed bolt fitted into a correspondingly formed side bar. Thus the pin is always forced to turn in the bushing, and the large wearing surface insures long life. Pin and bushing are replaceable.

Instead of the side bars being alternately inside and outside, they may be offset, and assembled inside at one end and outside at the other.

The rollers may be cast or malleable iron, bronze or steel, according to the material handled. They serve two purposes; to lessen the friction and wear in passing around driving and idler sprockets, and to support the weight of the chain and any attachments to it. The latter is of especial importance when these chains are used as drag conveyors of the flight or similar type. The rollers are often flanged to run on a rail, and in this form are used for pivoted bucket conveyors, etc. If the load is very heavy, as in long elevators or conveyors, the rollers for the sprocket teeth and the rollers for carrying the weight are separate, the latter being placed on the outside of the double line of conveyor chain. In this way the chambered rollers on which the moving load is supported are relieved of the dead weight of the entire conveyor in passing around the driving sprockets at the head.

In an unbushed roller chain the wear comes on the sides of the holes in the side bars, and as the bearing area is small, the holes rapidly elongate and the pitch of the chain increases.

Chain, Stud. See Chain, Coil.

Chain, Tightener. A mechanism for taking up the slack of a chain by means of an idler sprocket which can be slid or swung against the return run of the chain, forcing it out of the direct, and therefore the shortest line. Take-ups are also used for the same purpose, acting directly on the end sprockets of an endless chain drive.

Chain, Transfer. A conveyor chain made to be dragged in a horizontal channel with a load resting on it, and consisting of links connected by detachable or riveted pins and having complete flat or beveled roofs or tops on which the load rests. Two parallel strands are generally used for conveying work.

Chain, Transmission. A chain used for the transmission of power, generally between sprockets on parallel shafts. Single or multiple width chains may be used, the latter resembling a belt, and they may be of the roller construction, or the so-called silent chain type.

Chain, Weldless. A term applied to some varieties of light chain which are made up of bent steel punchings or of bent and twisted wire, without welding, riveting or bolting.

Chains, Wheelbarrow. A chain sling for lifting a wheelbarrow by a crane or hoist, consisting of three chains attached to a ring to be slipped on the crane hook, with two eyes and a hook at the lower ends for attaching to the wheelbarrow handles and hooking into the wheel respectively.

Change Gears. An arrangement of gears by which a change of angular velocity ratio is possible by exchanging gears of different numbers of teeth in the set. Much used in engine lathes for screw cutting.

Change gears have been used in the past in crane hoists, for changing the speed of hoist with varying loads. They are occasionally used in modern winches, made up somewhat like the transmission gearing in an automobile, where the axial shifting of one or more sets of gears produces the desired changes.

Charging Machine. A machine used for charging open hearth furnaces, built to travel along trucks on the ground in front of the furnaces, and having an arm which may attach itself to the end of a charging box, raise it and enter it into the furnace door, and turn the box over, dumping the contents into the furnace. The motions are then reversed. (See also Crane, Charging.)

Chassis, Motor Truck. The name applied to the complete running gear and power plant of an automobile. It may or may not include the seat or cab and wind shield.

Page 702.

Cheek Block. One of the pair of heavy weights shaped so as to fit on the cheeks of the fall block of hoisting tackle, to make it heavy enough to cause the tackle to overhaul without load. (See also Downhaul Ball.)

Chock, Rope. A name given to a rope guiding arrangement consisting of a frame containing a grooved sheave, or containing two grooved sheaves so mounted that the rope is virtually enclosed by the two rims. The chock is usually bolted to the top face of a timber, with the axes of the sheaves vertical, but it may be placed in any position desired.

Chocks. Blocks of wood or pieces of steel, properly shaped and placed to prevent wheels from rolling along a rail. Placed at the end of a track, they serve to keep the car from running off.

Chute. A trough-shaped structure set on a slope steep enough so that bulk or package material delivered to

it at one end will slide down its length to the other unless deflected or discharged by a suitable device at some intermediate point. The transverse section of the chute may be rectangular, curved or composite; its plan may be straight, curved or spiraled, and uniform, tapered, or flaring. Various materials are used and chutes may be fixed, portable, swinging, telescoping, folding, etc. According to the use to which they are put, they are called filling, loading, feeding, deflecting, distributing, bagging, lowering, etc., and according to the material handled as ash, coal, concrete, package, etc. Some special arrangements of chutes are described under Chute, Under-track; Chute, Lowering; Chute, Screening; Chute, Bagging; Chute, Hooded.

If made in sections, they overlap in the direction of flow, or are carefully butted and secured in such a way that there is no obstruction to the flow.

The term spout is also often used to designate a chute, though it is preferably applied to channels which are completely enclosed rather than to those which are open at the top.

Chute, Bagging. A chute used for delivery of material from overhead bins or loading machines into wagons, so shaped at its exit as to be easily introduced into a bag, and provided with an easily controlled gate.

Chute, Concrete. The chute forming a portion of a system of concrete distribution. Several types of chutes are used, depending on the system and the location in the system.

In the boom supported plants, the first section, receiving from the hopper on the tower, has a round swivel head or hopper about 24 in. in diameter at its receiving end, and a downward projecting swivel or deflecting plate at its lower end, and the succeeding sections are similar. In the continuous line plant, the lower end of the first section has a sleeve and insert with cross keys and chain for connecting it to the next section, and the succeeding sections, except the last, have these sleeves and inserts at both ends. The final section has a deflecting plate at its lower end to produce a downward discharge.

Concrete chutes are installed on a slope varying from 1 to 3 to 1 to 2¼. The diameter is usually 12 in., though 10 in. chutes are sometimes used. The transverse section is round-bottomed or egg-shaped. Liners of 12 to 14 gage thickness are sometimes riveted inside of the chutes to take the wear.

Chute, Extensible. A sloping chute which may be moved in the direction of its length, without changing its slope, to vary its point of delivery. The point at which the material is delivered to the chute is fixed, and the chute, mounted on rollers, is raised and lowered by endwise movement along an inclined track, under the control of a small winch. This arrangement is sometimes used for loading coal into hopper bottom or gondola cars from a tippie above the loading track. (See also Boom, Loading.)

Chute, Hooded. A chute which has a hood or vertical plate across its discharge end with an opening in the chute bottom close to the plate, arranged to discharge material vertically downward independent of the angle of the chute.

Chute, Lowering. A chute which is intended for lowering a fragile or breakable material like coal or coke from a height with a minimum of breakage, instead of dropping it. Two forms are common; the spiral lowering chute, in which the chute is curved in a spiral around a vertical central post; and the shelf lowering chute consisting of

a vertical tube, round or square in section, having a series of equally spaced internal shelves or baffles alternately placed on opposite sides.

Chute, Serpentine. A chute by which bags, bales and similar packages may be lowered in a practically vertical direction, consisting of a passage formed into a series of reversed curves all lying in a vertical plane, so that a sack inserted at the top is thrown from side to side and does not attain sufficient speed to be damaged. To admit at intermediate floors, the lower side of a door on a convex side is swung inward against the opposite side of the chute, exposing the full opening of the chute. To discharge at intermediate floors, the top of another door on a convex curve is swung inward against the opposite side, thereby acting as a deflecting plate on which a sack will slide out on to a delivery table.

Chute, Screening. A chute having a screen set in the bottom so that material passing over it will have separated from it the dust of "fines." This type of chute is often used for loading coal from overhead bins into wagons, the dust being retained in a separate hopper beneath the chute and emptied from time to time.

Chute, Spreader. A chute which is flared at its discharge end into a long slot-like opening, which will spread the material passing through it in a wide thin stream. Chutes of this form are used to spread the coal delivered from overhead bunkers to the magazines of stokers. They are subject to the disadvantage that the fine coal may pile in the middle and the lumps roll to the sides, making an uneven fire.

Chute, Spiral. A gravity conveyor in which the material slides downward in a chute which is wound in a helical form around a central vertical axis. The single spiral chute is the most usual, though there are often two and even three separate chutes around the same axis, known as double or triple flight (or blade) spiral chutes, or as multiple runways. Or a single runway may be divided into two or more by vertical partitions running throughout the length, one being close to the axis and steep in pitch, and the other toward the outer circumference, and therefore less steep.

If wound very closely about a central supporting post or core and rigidly attached to it, the spiral is known as a closed center; if wound on a larger circumference, with a clear vertical circular shaft through the center, as an open center. A combination type is also in use, having the central opening, but with a post to which the inner side of the chute is connected and braced. The open type is braced and supported by the floors through which it passes; the closed type usually depends entirely on the core or post, which carries the whole weight of chute and contents, and transmits it to the foundations beneath. Any of these three types are termed housed or enclosed when they are completely shut in by a tight casing, usually built of steel plates.

The chute proper or runway bed is made of sheet steel fan shaped sections termed wings, or flights, lapped in the direction of travel or flanged and butted, or of cast iron sections flanged and bolted. It may be flat or slightly concaved on the bottom, the theory of the concave section being that it will exercise some control over the speed of descending objects. Those which slide easily and attain high velocity will move outward due to centrifugal force to locations where the slope is smaller, and will therefore slow down. Those which tend to travel slowly will stay near the axis, on account of the curved runway bottom, thereby gaining the benefit of steeper

slope. Guard rails are erected at the outer edge, these usually consisting of a solid rail of steel plate of a height depending on the size of packages carried. In housed chutes the guard rail may be omitted and the inside of the housing used instead.

Spiral chutes most naturally receive their load at the top and discharge at the lower end of the spiral. Loading can be easily done at any intermediate point, by passing objects over the guard rail, or by raising a 90 deg. section of the runway and sliding them over the edge of the portion below. Discharge can also be obtained at any point by removing or swinging inward a portion of the guard rail and allowing objects to pass off tangentially, or by lowering a flap or diverter onto the runway bed so that they slide onto this flap and out of the spiral. This is called a switchout plate. Delivery is made onto a horizontal or sloping table, the floor, a roller conveyor section, etc., according to convenience. Automatic vertical sliding or hinged fire-proof doors are fitted at all floors where fire protection is necessary.

Also called friction spiral.

Page 390, 759-767.

Chute, Telescoping. A chute which consists of two or more parts lapping over one another in the direction of flow, and arranged so that they may be telescoped within one another either for better portability, or to secure a variation in the point of delivery. (See also Chute, Extensible.)

Chute, Tilting. A short trough shaped chute, open at both ends, placed transversely beneath the discharge opening of a scraper conveyor and pivoted at the middle of its length, so that it can tip in either direction and discharge the received material at either end.

Clamps, Track. Any device by which a truck or car may be rigidly clamped to the rail on which it runs, and all rolling motion prevented. On shipboard crane trolleys of all kinds are provided with track clamps, to prevent rolling due to the motion of the ship.

Also, in traveling cranes moving on tracks of ordinary or narrow gage, especially locomotive and wrecking cranes, means by which the car frame is clamped down to the tracks, in order to give greater stability when lifting loads at a large radius. (See Outriggers.)

Clamp, Transmission. A part clamped to the cable in a cable haul-up or car haul-up to assist the driving sheave or gap wheel in propelling the cable. Flights or spurs are clamped at the regular intervals required for the conveying or elevating work, but these are often too far apart for driving purposes, as it is necessary that at least one clamp be in contact with the driving wheel continuously. Intermediate driving or transmission clamps are therefore added. They may be plain cylindrical clamps, the same with a single axle and two rollers, or with two axles and four rollers; these rollers serve to prevent the cable from dragging on the supporting structure as it passes over the convex curve at the top of the incline.

Clearance. The distance or space between moving and fixed objects, or between two moving objects, when they are nearest together.

Also, the allowance necessary to prevent interference of parts which have relative motion.

Also, the linear distance between the piston face and the inside of the cylinder head of a reciprocating engine.

Clearance, Crane. The distances or dimensions which determine the maximum size of a crane for a given location. They are generally given as follows (for an overhead traveling crane):

A. Center to center of runway rails.

B. Center of rail to nearest point of wall.

C. Floor level to top of rail; if hook must go below floor level, give distance.

D. Top of rail to lowest point of roof truss or other overhead obstruction.

E, F, G, H. Dimensions of roof knee braces, if any.

Cleat. A wood or metal fitting having two projecting ends or horns, to which a rope is fastened by several turns around it.

Clevis. A fastening consisting of a forked end of a bar, with eyes in each of the two ends; a pin or belt, passing through the two eyes, is used to attach the clevis to an eye or link. (See also Shackle.)

Clevis Connection. A method of connecting two parts by which a flat projection having a hole or eye in one part is inserted between two similar projections from the other part, and a bolt passed through all the holes and locked to prevent it working out. Used for attaching hoists to trolleys and similar purposes, where the greater portability resulting from a hooked connection is unnecessary, and it is necessary to have a close connection to save headroom.

Clip. A short length of structural bar, generally an angle, used to strengthen points of attachment of various members of a steel structure.

Clips, Rail. Steel pieces used to hold crane rails, etc., to structural steel plates and beams.

Clips, Rail End. Steel stops placed at the ends of rails to prevent creeping.

Clutch. A device for transmitting power from one rotating shaft to another in alinement with it, which can be connected or disconnected at will. It may be of the friction type, or of the positive type.

Friction clutches are those in which motion is transmitted by virtue of the friction of surfaces pressed into contact. (See Clutch, Friction.)

Positive clutches are those in which toothed or serrated surfaces locking onto one another are used to transmit the motion. (See Clutch, Positive.)

* Occasionally clutches are used which combine the ability to gradually pick up a load afforded by the friction clutch, with the positive driving of the jaw clutch, by having the latter brought into action after the two parts have been brought to the same speed by the friction clutch.

Clutch, Drag. A friction clutch which is intended to slip when the torque is in excess of a certain amount established as desirable. Used for operating drums winding tag lines, magnet leads, etc., in hoisting equipment, where the purpose is merely to take up the slack or to maintain a slight tension in addition.

Clutch, Friction. A clutch in which rotary motion is transmitted from the driving to the driven shaft by means of friction surfaces pressed into intimate contact. Four types are in general use: contracting band, internal expanding, cone, and disc or plate.

In the contracting band type, a band is carried by one end of the shaft in such a way that it can be tightened on the surface of a cylindrical drum on the end of the other shaft with sufficient force to drive it.

In the internal expanding type, the band is inside the cylinder or drum, and expands to exert the necessary pressure.

Cone clutches may be single or multiple. In the former a single cone with external friction surface is pressed into a correspondingly arranged internal conical friction surface. The surfaces may be metal to metal, or

one may be faced with wood, leather or some other suitable material. Double opposed cones may be used giving a wedge-shaped section to the friction element. Multiple cones may be used, distributed radially on the same disc, or axially, in series along the shaft alternately connected to one shaft and to the interior of a drum keyed on the other shaft.

Disc or plate clutches have flat disc friction surfaces, sometimes single, but generally multiple. In this last type alternate discs are keyed to a hub fast on one shaft, and to the inside of a shell or casing fast to the other shaft. The sets of discs are of different metals, or one set may be faced with friction fabric; they may be run in oil or dry. They are pressed together axially when engagement is desired, and a small amount of pressure will produce a large amount of friction, on account of the many surfaces in contact. This is called the Weston clutch, and is much used in hoisting machinery, especially when combined with a screw mechanism and used as a brake. (See Brake, Screw.)

For friction clutch as applied to the friction drum of a winch, see Drum, Friction.

Friction clutches, sometimes called slip couplings, are often used as safety devices, the controlling springs or other forces being so adjusted that the friction is just sufficient to overcome the normal resistance, but will slip when abnormal resistance is offered, thus preventing breakage.

Clutch, Magnetic. A revolving magnetic field set up by the rotation of a magnet in one part of the clutch drags the other part by means of eddy currents induced in it. When brought into contact, driving is practically positive. This clutch is not in extensive use in material handling machinery, on account of complications.

Clutch, Positive. A clutch having two parts with teeth or jaws which lock into each other while transmitting power. One part of the clutch is keyed fast to its shaft; the other part is keyed to its shaft but slides freely along it, and is moved by a fork fitting into a groove in the hub of the sliding part.

The jaws may be straight sided or slightly tapered, the latter eliminating backlash, but requiring that the moving part be held in by force. The jaws may also be straight on one side, and very much tapered or spiraled on the other, in which case the clutch will disengage itself if reverse rotation occurs, and driving can be done in one direction only.

When the jaws are very numerous, the clutch is generally said to be toothed; the teeth may be parallel, tapered or spiraled, as with jaws.

Positive clutches must be engaged only when the relative motion of the two shafts is nothing or very small.

Clutch, Pulley. A pulley having one-half of a clutch incorporated in its hub, so that it can be connected to the shaft on which it is mounted, or run loose, as desired. Also called a pulley coupling.

Clutch, Slip. A friction clutch which is intentionally set so as to slip under excessive torque, thus becoming a safety device and protecting the machinery beyond it.

Coaling Station, Locomotive. A structure located at a convenient point on a railway line at which locomotives may receive their coal for fuel. It usually comprises one or more elevated bins or pockets, with conveyors or elevators for keeping them supplied with coal, with weighing and perhaps screening arrangements, and with chutes for delivering to the locomotive tenders.

Sanding equipments are also often included. Also called fueling station.

Cock. A device used for controlling the flow of fluid in a pipe, consisting of a body with an opening straight through, arranged for pipe connections at the two ends, and a transverse opening, usually tapered, into which is tightly fitted a revoluble plug having itself a transverse opening. This opening can be made to register with the body openings, leaving a clear passage for flow, or can be turned at right angles, thereby stopping all flow.

Cock, Four-way. A cock having two connecting openings through the body at right angles to each other, and also a plug with four openings which are connected in two non-communicating pairs. Any pair of adjacent outlets of the body can be connected at will.

Cock, Three-way. A cock having a through opening and a side outlet at 90 deg. in both plug and body. The plug can be turned so as to connect any two of the openings, all three, or none.

Coil. A ring, or continuous series of rings, into which a flexible body, as a rope or chain, may be formed, either loosely on the floor, or around a drum, reel, or other object.

Also a continuous line of pipe arranged in a series of circuits or turns close to one another.

Coke Fork. A modification of the ordinary grab bucket to adapt it for handling coke. This material is pulverized by the ordinary form of shells. Curved tines are substituted for plate shells, and these slide under and between the lumps with less breakage. Any of the various forms of light clam shell buckets may be so adapted, the operating gear remaining the same.

Column. A vertical structural member designed for the resisting of vertical or axial compressive load; a vertical strut.

Column Section, Rolled Steel H. A rolled steel bar having a cross section like the letter H. As it can be made of approximately equal strength against yielding in any direction, it is used for columns in steel construction.

Collar, Grease. A ring of grease which forms at the ends of a journal bearing lubricated from a grease cup. This grease collar is often allowed to remain when the bearing is in a dusty place, as it prevents grit from working into the bearing.

Concentrator. See Conveyor, Belt, Idlers for.

Compensating Pulley. See Equalizing Sheave.

Compensating Truck. See Equalizing Truck.

Concrete Distribution, Boom Plant. A method of chuting concrete in which the first section of chute is supported by a boom swung from the tower, followed by a section mounted on a counterweighted truss suspended from the end of the boom, and this, if additional length is necessary, by chute sections carried on floor supports such as horses, tripods, gin poles, etc. A plant of this sort can be made portable by mounting the tower and mixing plant on a barge, wheeled platform or railway car, the tower being temporarily guyed in position if necessary, or braced with stiff-legs.

Concrete Distribution by Chuting. A method of distributing concrete in which the latter is elevated to the desired level in a bucket which is hoisted in a temporary tower, dumped into a receiving hopper on the side of the tower, and discharged through a gate-controlled spout into a line of chutes. According to the method of supporting the chutes, there are three types: the continuous line plant, the boom plant (stationary or portable) and the tripod plant.

Concrete Distribution, Continuous Line Plant. A method of chuting concrete in which the succession of downward sloping chutes are suspended from trolleys on a wire cable by manila rope tackle, two attachments being made to each section. Discharge may take place at the end of the line, or at any intermediate point by line gates with vertical drop sections, from which flexible chutes or "elephant's trunks" lead the material down to the desired level. Special or "combination" chute sections are used at the hopper end and at the discharge end; the intermediate sections are of the continuous line type.

If the distance the concrete is to be carried is more than can be obtained with the slope from the initial tower, a second or relay tower may be used to re-elevate it and start it through another line of chuting; this may be repeated if desired.

Concrete Distribution, Tripod Plant. A method of chuting concrete in which the succession of downward sloping chutes is supported by tripods of various heights standing on the floor. The tripods may be moved about when a change in the discharge point is desired, but the system is so cumbersome as compared with the boom or continuous line systems that it is not much used at present, except as an auxiliary to a boom or continuous line plant.

Container. A general term signifying any structure or contrivance within which material may be enclosed, or on which it may be supported for preservation, transportation, chemical or other treatment, etc. The principal types used for purposes of conveying or transportation may be classed as follows: (a) rigid completely enclosed containers for solids,—box, barrel, tub, case, closed crate, carton, tube; (b) rigid partially enclosed containers for solids,—tray, tote box, open crate, shop barrel, skid or live platform, bucket, skip; (c) non-rigid containers for solid or bulk materials,—bale, bundle, sack, bag, roll, net, carton, tube; (d) containers for liquids,—barrel, drum, cask, hogshead, can, carboy, pan, bucket.

The materials from which containers are made include wood, metal, fibre, paper, burlap, canvas, muslin, glass and earthenware.

Container, Unit. A metal box holding a considerable amount of freight, and capable of being moved between a motor truck, trailer, freight car, barge or ship. Small packages or bulk freight are loaded into the containers which are then handled as units during transportation. For packages, a side door unit is used, while for bulk material, a bottom dumping type is preferred. (See also Demountable Body System; Gattie System.)

Continuous. Uninterrupted; flowing, moving or acting without break or stopping, as distinguished from intermittent; as, a continuous conveyor.

Control, Cage, Floor, etc. In crane manipulation, the operator may travel with the apparatus in a cage, handling it by cage control; he may walk on the floor following the load, using floor control; or he may operate it from a fixed point to which all controller leads are brought, which might be termed remote electric control or pulpit control.

In lever control the operator does not handle directly the controlling part of the machine, but moves a lever which is properly connected to it. (See Levers, Banked.)

Control, Foundry. A name given to the controlling system of a hoist when it has a very wide speed variation and simple means of obtaining it, thus fitting the hoist for the special requirements of foundry use where

loads like flasks and ladles of iron must be handled very slowly and carefully at some times, and rapidly at others.

Controller, Hoist. A mechanism which is designed to control automatically a mine or similar hoist, and prevent accidents due to neglect of the operator or to other causes. Assuming a two-cage hoist, one cage counterbalancing the other, the controller should perform the following functions; (a) prevent overspeeding; (b) notify the engineer when the cages are approaching the proper stopping points; (c) retard the cages in case the engineer does not do so; (d) stop them if the engineer allows them to run past the stopping point; (e) prevent the hoist being operated at the high speed used for hoisting mixed material if the signal has been given for hoisting men, for which purpose a low speed is required; (f) prevent starting in the wrong direction; (g) permit adjustment of the band brake at any time.

Controls, Pendent. Ropes or rods hanging from overhead traveling cranes or monorail trolleys, by which the various motors are operated.

Counterbalance. See Counterweight.

Counterbore. To enlarge a round hole for a portion of its length by a tool called a counterbore.

Also the portion of a hole so enlarged.

Conveyor. A more or less self-contained device for continuously transporting material in a horizontal or slightly inclined direction. If the inclination is steep, and the material is carried upward, the device is usually called an elevator; if downward, a lowerer. The operating force may be gravity or some form of mechanical power, as electrical, hydraulic, pneumatic or steam. The material to be transported may be in bulk in a more or less continuous stream, in bulk but divided temporarily for the purpose of conveying into small portions, each carried in a separate container, or in permanent individual units or packages of uniform size and weight.

Conveyors may be classed according to their general form as: gravity (dead), power (live), or retarding; fixed or portable; inclined or horizontal; drag or carrying; etc.; also according to the nature of the mechanism as screw, scraper (or flight), apron, pan, platform, slat, V-bucket, pivoted bucket, chain-haul, drag chain, cable, push-bar, sling, roller, etc.

Page 329-407.

Conveyor, Apron. See Conveyor, Steel Apron; Conveyor, Wood Apron.

Conveyor, Assembling. See Conveyor, Progressive.

Conveyor Belt. The wide thin band used as the moving carrying agent in belt conveyors. It is usually made of woven fabric with or without various impregnating materials and outer facings of rubber or similar materials. Steel belts have been used, are light and strong, require less driving power, and have smooth surfaces on which packages may easily be diverted, but they require larger pulleys and cannot be troughed.

The more usual types of conveyor belts are: oiled and stitched cotton belt, consisting of plies of cotton duck treated and stitched together; stitched rubber belting, consisting of cotton duck folded lengthwise with plies "frictioned" with rubber and stitched lengthwise, with rubber facing vulcanized on one or both sides; rubber belting consisting of plies of cotton duck vulcanized together with rubber and faced with the same material; woven fabric belt, not in plies, impregnated with rubber-like compounds; balata belting, consisting of heavy cotton duck plies impregnated with a balata compound; plain white cotton belting; and occasionally leather belting. The top or carrying surface usually receives the

thickest facing of rubber; in the "stepped ply" construction the plies gradually decrease in number from the edge to the center of the belt, and the facing rubber increases in thickness. In distinction, the ordinary full width plies are termed straight plies. The stepped construction provides extra thickness of rubber at the points where wear is greatest, renders the belt more flexible near the center, and stiffer at the edges where it tends to sag between carriers. Conveyor belts are usually spliced with metal fastenings, or else are made endless.

Most belts are used without any attachments, especially in horizontal conveying, though occasionally flat belts have a flange formed at the edges of rubber vulcanized into the belt structure to increase the carrying capacity. Flat overlapping steel plates are sometimes riveted to the belt to resist wear of very abrasive and sharp materials, and these may also be turned up at the ends, making a continuous steel trough carried on a belt structure.

For incline use, the belts may have shallow or deep cleats riveted across at intervals, or even well defined pockets or buckets for steeper slopes. (See Elevator, Belt and Bucket.) These are riveted, and for heavy duty should have reinforcing plates across the back.

Page 419, 445.

Conveyor, Belt. A carrying conveyor consisting of a wide and thin belt of fabric or rubber, passing around a head pulley at one end and a tail pulley at the other (both pulleys having horizontal shafts), supported by numerous idler pulleys between them placed under both runs, and carrying bulk or package material on the upper run. It may operate horizontally or on a moderate incline, or may change from horizontal to incline or the reverse in the course of the run.

The load may be placed on the upper run of the belt at any point, and may be discharged at any point or over the head pulley. For loading packages, cross or feeder conveyors or feeding chutes are required, and the belt is supported at the loading point by closely spaced rollers or a smooth plate beneath it. For unloading packages at intermediate points, a sweep, diverter or plow may be used. For loading bulk material, feeders or loading hoppers are used, and care is taken that they discharge onto the belt in the direction of motion of the latter. (See Feeder.) For unloading at intermediate points a plow may be used, though it causes unnecessary wear on the belt; narrow belts may also be tipped up edgewise by special inclined idlers, and the load distributed over some distance. By far the most usual method is to have a tripper. (See Conveyor, Belt, Tripper for.)

For package material, the loaded run of the belt is carried on flat faced idler pulleys or rolls, with horizontal skirt boards placed just beneath the edge of the belt; these skirt boards are also often tipped up slightly at the outside edges to prevent packages working off. For bulk material the belt is raised considerably at the edges by troughing idlers or concentrators; the return run is supported on flat idlers. Concentrator idlers must always be placed at the points of loading. A horizontal partition is often placed between the two runs to prevent material falling from the upper run from reaching the back of the lower run, where it might cause damage to the belt in passing around the pulleys.

To provide a constant belt tension, a suitable take-up is furnished, its location being at the head or tail pulley, whichever one is not driving, or else on the return side of the belt. (See Conveyor, Belt, Take-up.)

Also called band conveyor (British).

Page 369, 418, 759-773, 834-840.

Conveyor, Belt, Brush for. A brush to remove from a belt moist or sticky material which might otherwise be carried back on the return side of the belt. It may be an oscillating flat brush, or a rotating round brush, driven by the conveyor head pulley, and should be adjustable to allow for wear. The bristles should not be of wire.

Page 421, 423, 447.

Conveyor, Belt, Idlers for. The intermediate pulleys, or those between the head and tail pulleys, on which a conveyor belt is supported. The return run is always supported flat, and each idler consists of either a single roller the full width of the belt, or of several narrow pulleys close together on the same shaft.

The loaded run of belting is raised at the edges, or troughed, if a large capacity for carrying bulk material is desired. For narrow belts, two idler pulleys set at a slight angle, making a very wide V, may be used. Three idlers, the outer two being set at an angle, make a flat bottom trough with straight sides; five and seven idlers may be used with wider belts, arranged approximately on the arc of a circle and making a trough of shallow circular section; these are known as multiple pulley idlers.

Occasionally a single concave roll is used, or "dish pan" or "bell shaped" idlers are placed at the ends of the straight cylindrical roll supporting the central portion of the belt. These are defective in that points on their surface have varying speeds, and therefore cause wear on the belt which has the same speed over its whole surface.

Troughing idlers may be placed in the same vertical plane as the horizontal idlers, termed the straight line arrangement, or may be placed beside them, termed offset troughing idlers. They may also be made adjustable. The two outer rolls of a three-roll set are also sometimes inclined slightly in the direction of belt travel, with the idea of helping to keep the belt central. The assembly of troughing idlers is often known as a concentrator, and the individual pulleys or rolls, as concentrator rolls, a bell shaped idler as a bell concentrator, etc. They are also called troughing carriers and return belt carriers.

To guard against the belt working to one side, guide rollers are often installed, though it is best to consider them as safety devices only, and to find and correct the cause of the side working of the belt. These are known as troughing belt, flat belt and return belt guide rollers, the first being placed on an inclined axis, and the two last on vertical axes.

For sorting belts, continuous roller idlers with a slight flare or increase in diameter at the ends are often used, to allow the material to spread in a thin layer. Package carrying belts sometimes have similar idlers, but more often have straight idlers with perhaps a slight troughing at the edges caused by sloping skirt boards.

Idlers are carried in plain, roller or ball bearings which are supported on wood or steel framing designed for them, or are mounted on stands of various forms, which are bolted directly to a flat supporting floor. The long straight idler rolls used for return belts are sometimes made of wood, and sometimes of pipe shrunk on to cast iron ends in which short shafts are formed. The pulley type idlers are usually of cast iron or pressed steel.

Page 456, 834.

Conveyor Belt, Malleable Iron. A chain belt used for conveying or elevating, composed of malleable iron blocks on steel rods, with steel side-bars connecting the rod ends. It can be made up in any width desired, and used with ordinary sprockets. Buckets may be attached

if desired. It will operate in high temperatures that would destroy fabric belts, and in gritty materials.

Conveyor, Belt, Pulleys for. The head and tail pulleys for belt conveyors are flat, as are also the tripper pulleys. They are generally of cast iron, occasionally of wood slats, or of cast iron lagged with wood, and where delivering to crushers or other machinery which would be injured by "tramp" iron, the head pulley is often magnetic. The driving pulley, usually the head pulley, is sometimes covered with rubber for adhesion; the arc of contact is increased by the use of a snubbing pulley for heavy work, and for very heavy traction the belt sometimes passes around two driving pulleys in series, called a tandem drive, arranged so as to obtain a large arc of contact on each, sometimes requiring the use of an idler, and sometimes utilizing the head pulley for one of the two driving pulleys. An auxiliary belt is also sometimes used, pressed against the outside of the main belt around the driving pulley, by auxiliary snubbing pulleys.

Page 421, 457.

Conveyor, Belt, Take-up for. The mechanism by which constant tension is maintained in a conveyor belt. The usual location is at the tail pulley and the adjustment is horizontal or on a slight incline. If the drive is at some other place than the head pulley, the latter may be used for the take-up. If both head and tail pulleys must be kept in fixed positions, the take-up may be placed in the return run, preferably near the head pulley.

Gravity take-ups have guides on which a tightener pulley mounted in a weighted carriage may move vertically, idler pulleys being placed at the top of the guides with belt led around them to the tightener pulley below.

Screw or rack-and-pinion take-ups, adjusted by hand, may be placed in any desired position. The moving pulley is then mounted in bearings moving in guides or along rails.

Page 462.

Conveyor, Belt, Tripper for. A device for causing the load on a belt conveyor carrying bulk material to be discharged at some other point than over the head pulley. It consists of a rigid frame spanning the belt, and carrying two large pulleys on horizontal shafts, so placed that the belt makes an S-shaped turn in passing them. The belt is gradually raised from its supporting idlers as it approaches the tripper, discharges its load as it passes over the top pulley, and is delivered on to the supporting idlers around the lower side of the lower pulley, to continue on its circuit. The material drops into a hopper from which it is discharged to either side of the belt by a spout, or back on to the belt if it is desired to by-pass the tripper.

The tripper may be fixed in position; several fixed trippers may be placed along the same belt, and any one of them may be by-passed to vary the point of discharge. As each tripper consumes power, a single tripper traveling on a track is more often installed; it may be used in a fixed position which is altered when desired by hand traveling gear or by ropes led to a winch, or it may be self-propelling, with reversing gear for changing the direction of motion. This reversing gear may be operated by adjustable stops on the track and the self-propelling self-reversing tripper thus arranged to travel slowly back and forth over a predetermined length of track, distributing its load. The power is usually furnished by the belt itself; for very heavy service a propelling motor may be supplied.

The discharge spout may be one-way fixed on either

side, two-way with possibility of diverting from one side to the other, or three-way including a central downward discharge onto the belt for by-passing the tripper. An equalizing discharge is sometimes used, shifting regularly from one side to the other. For very wide belts where it would be necessary to lift the loaded belt to a considerable height to get room beneath it for the discharge spout, a reversible belt cross-conveyor is sometimes added to receive the head pulley discharge and carry it to either side; if extended considerably to the sides, this allows a wide distribution of the material. A distributing spout is sometimes used, consisting of a small vertical shaft paddle-wheel just beneath the outlet of the spout. The emerging material is widely scattered by the whirling blades.

The traveling gearing is usually driven from the head pulley, and involves a double bevel gear reversing clutch for controlling the direction of motion. On account of the slow motion desired, a worm drive is usually inserted at some point. To allow slipping in case of accident, and to absorb the shock of reversal, friction wheels are sometimes also included in the gear train.

Page 421.

Conveyor Belt, Wire Cloth. A belt conveyor belt made of steel or brass woven wire, for carrying a moist material through drying ovens where the temperature would injure fabric belts.

Conveyor, Branch. A short conveyor line, generally transverse to a trunk line conveyor, and serving to feed it, or to distribute from it. In certain types of conveyors, the branch lines connect with the main line by switches, in other types they deliver on to it at right angles, or receive from it at right angles by means of some adjustable diverting or tripping device. Also called a cross-line conveyor.

Conveyor Bridge. A structural steel bridge spanning a space between two buildings, or between the ground and an elevated point in a building, and supporting a conveyor.

Conveyor, Cable. A drag conveyor similar to the flight conveyor, but having only one cable drawn along a U or V-shaped trough, with disc-shaped cast iron flights clamped to it at accurately spaced intervals. The troughs are of wood, often steel lined. For bulk materials like coal, the flights are closely spaced. For logs they are farther apart and intermediate smaller blocks called transmission blocks are clamped to the rope, to give additional points for driving in passing around the driving sheave, which takes the form known as a gap wheel. At least two blocks must be in contact with the gap wheel at once. (See also Conveyor, Retarding.)

Page 448.

Conveyor, Carrying. A conveyor which carries bulk or package material on pans, plates, buckets or belts supported by rolling members, as opposed to one which drags or pushes it.

Conveyor, Chain. A carrying conveyor consisting of two parallel endless strands of chain, traveling at the same speed and sliding in smooth shallow grooves above the edges of which they project slightly. Objects laid across the two chains will be conveyed by them, and may be discharged automatically at the end sprockets, or by hand at intermediate points. Three or more chains may be used for long objects which tend to sag between supports. For conveying lumber transversely two widely spaced chains are often used.

Page 401, 762.

Conveyor, Cross-line. A conveyor line which is at right angles to the prevailing or main system; a branch conveyor.

Conveyor, Current. A system of conveying in which the bulk material to be moved is suspended in a fluid which is forced at a high velocity through the conveying pipe. A means of producing the suspension, or forming the mixture, must be provided at the intake end, and a means of separating the fluid from the material at the discharge end. The fluids in common use are air, water and steam; water is used for handling the denser materials. (See Conveyor, Pneumatic; Conveyor, Hydraulic; Conveyor, Steam Jet.)

Page 430.

Conveyor, Degradation. In a coal tippie, a small conveyor used to collect and convey to the "run-of-mine car" the fine coal and dust caused by the action of the screens on the friable coal. The fine coal or "slack" is usually screened out first, but the subsequent wear while the larger sizes are being separated causes further degradation which it may be desirable to remove by final screening.

Conveyor, Distributing. A continuous conveyor, usually of the belt or apron type, running lengthwise of a building or aisle, on which miscellaneous package material is placed at one end, to be removed at the proper destination by operatives. In certain cases this distribution may be made automatic by some selective system applied to the containers used.

Also a belt conveyor discharging its load by means of a self-propelling self-reversing tripper, and distributing it over any desired length of bin or storage pile.

Conveyor Diverter, Selective. A conveyor diverter which is set in such a position with reference to trays being conveyed that it may engage a pin placed at some definite location and height on the tray, these locations and heights varying for the different stations. The dispatcher sets the pin in the proper position according to the destination desired, and the tray is swept off the conveyor when it reaches the diverter having the corresponding setting.

Conveyor, Drag. A system of conveying in which the material to be moved is dragged along a trough (as distinguished from being carried) by one or more special chains, with or without flights or crossbars, by a rope or cable with flights, or by a revolving screw or equivalent helical surface. The last is used for bulk material only; the others are used for both bulk and package material. (See Conveyor, Flight; Conveyor, Drag Chain; Conveyor, Push-Bar; Conveyor, Cable.)

Page 399, 427.

Conveyor, Drag Chain. A drag conveyor made from a chain of very wide links, often with a wing at the point of articulation, forming a conveying flight, and dragged in a trough into which material to be conveyed is fed. The chain passes over sprockets at the ends of the run, the return run being elevated sufficiently to be out of the way. The conveyor may be fed at any point, and may be discharged at the end of the trough, or at any point through a hole in the bottom, controlled by suitable gates. The conveyor may be operated horizontally or on a slope up to 45 deg. The bars of the chain are usually made with broad flat surfaces to take the wear due to dragging in the trough; they are made of very hard material for the same reason. Various forms of blades known as wing, flight, spur, etc., may be used in the chain, to suit the material being handled.

Also called a sawdust chain conveyor, and a refuse chain conveyor from the fact that it was originally developed for handling sawmill refuse.

Page 427.

Conveyor Flight. One of the series of transverse plates, blades or discs attached to one or more chains or cables, and dragged in a trough to form a flight conveyor. They are made rectangular, round, beveled or irregular in their projection, may be of wood, fibre, cast iron or sheet steel, the last being made flat, curved in scoop form, or crimped or corrugated for strength and stiffness. According to the method and location of attachment, they are termed suspended, or centrally hung.

They are fastened to chains by inserting suitable attachment links at proper intervals, and to ropes by two or four bolt clamps, generally cast in one piece with the flight.

Page 453.

Conveyor, Flight. A drag conveyor generally used for bulk material, consisting of a series of scrapers or flights connected at regular intervals to one (single strand type) or two (double strand type) endless chains passing around sprockets at the ends of the run, and dragging material between the flights in a trough. The discharge is at the end of the trough or through gate-controlled openings in its bottom. It may be loaded at any point in its conveying run, and is not easily choked. The conveyor may operate horizontally or as an elevator on inclines up to 30 deg. or even 45 deg. at reduced capacity; the change from a horizontal to an inclined run may also be made by properly located idler sprockets. The drive should be placed at the delivery end, and the take-up at the other end.

In the single strand conveyor the chain is attached to the top edges of the flights at the centers. The flights may rest on the bottom of the trough, known as drag flights, or on wearing shoes running on wooden guides or steel tracks at the sides, known as suspended flights. Return wearing shoes are cast or riveted to their backs. The lower run is nearly always used for conveying, especially if the material is abrasive, since the chain stands above it, while in the upper run the chain must travel in a groove in the bottom of the trough.

The flights of the double strand type are always attached at their ends to the chains which are dragged along guiding surfaces, or have incorporated in them rollers traveling on flat rails; both arrangements keeping the flight from dragging on the trough bottom. If the chains are attached to the top of the flight, it is termed a suspended flight; if at the center of the ends, it is called a centrally hung or double flight; where roller chain is used, it is sometimes known as a roller flight. Suspended flight conveyors always convey in the lower run; centrally hung flights may convey in either the lower or the upper run, or both, as may be desired. If the upper run is not used for conveying, guides must be provided for the return, with wearing shoes on the back of the flights in case the chain is not of the roller variety. The return run is sometimes supported on idler sprockets placed at intervals.

When the trough is U or V-shaped, and disc-shaped flights are dragged along it by a chain or (more commonly) a wire cable, it is termed a cable conveyor; it is more often used for logs, pulp wood and similar objects than for loose bulk material.

Page 427.

Conveyor, Grasshopper. See Conveyor, Reciprocating Trough.

Page 429.

Conveyor, Gravity. A type of conveyor in which gravity is the operating force. The material moves on the conveyor, but the latter itself does not generally progress. The material may slide directly on the surface of the conveyor (see Chute; Chute, Spiral, Conveyor, Retarding), may move along on rollers fixed in a supporting frame (see Conveyor, Roller), or may be carried in trays or buckets (see Lowerer).

A certain head is of course required to operate these conveyors, so that their greatest field of usefulness is for lowering, or for horizontal transportation where the distance is not very great. If long horizontal travel is required for a roller conveyor and the head is limited, as between floors, repeated lifts can be made by properly spaced power operated sections and long gravity sections will provide the means of covering the horizontal distance. (See Booster.)

Page 759-767.

Conveyor, Gravity Discharge V-Bucket. A combination elevator and conveyor, or elevator-conveyor, of the bucket type, consisting of two strands of chain, generally roller, attached to the ends of V-shaped buckets with the open side pointing up on the vertical elevating run, and passing around sprockets at various turns, generally four in number, at the corners of a vertical rectangle. Bulk material is carried in the buckets on the vertical upward run, and is dragged along the horizontal runs in troughs which fit the buckets closely; material cannot be lowered by this conveyor.

Material fed into the lower trough at any point is dragged along it to the turn, where it is picked up by the buckets and carried to the upper horizontal trough along which it is again dragged until it reaches one of the several discharge openings provided in the bottom of the trough. These openings are closed by sliding gates, controlled from below if desired.

Also called chain and bucket conveyor with rigid buckets, and gravity discharge elevator-conveyor. (See also Elevator, Gravity Discharge V-Bucket.)

Page 413, 826-836.

Conveyor, Hydraulic. A form of current conveyor in which water flowing at high velocity in a channel or pipe is the agent used to move the material. A familiar example of this is the discharge pipe of a hydraulic dredge, which may extend for a long distance to the point at which the material is finally ejected. Hydraulic ash handling equipments have been used in a few stationary power plants and in many marine installations, where they are especially adaptable owing to the abundant supply of water available with no expense except that of pumping it a small distance. The hydraulic conveyor usually consists of a nozzle from which issues a stream of water at high velocity, immediately beneath the opening of a hopper into which the ashes are shoveled. The velocity is sufficient to carry the mixture to an elevated tank from which the water can run away to a spot of land which is to be filled in, or (in the case of a ship) overboard. In some cases on shipboard the discharge is directly through the side of the ship, without going above the water line. Also called an ash ejector.

The hydraulic system has also been used to convey small size coal. Coal and water are mixed in a tank from which they are drawn by a centrifugal pump and delivered to another tank; here the water is drained off

and returned to the supply tank for re-use, and the coal is lifted from the tank by a grab bucket.

Also called sluice conveyor, especially if an open channel is used.

Conveyor, Jacketed. A drag conveyor in which the trough has hollow metal walls in which can be circulated steam for heating or drying, or water for cooling the material which is being conveyed. Jackets are applied to both flight and screw conveyors.

Page 458.

Conveyor Line. A term used to designate a completely assembled conveyor made up of separate sections bolted together in line. A complete conveyor system may consist of several separate lines, as, cross or branch lines, in addition to a main or trunk line.

Conveyor, Live. A power driven conveyor; one which is not operated by gravity.

Conveyor, Monorail. A continuous conveying system consisting of an endless circuit of overhead monorail track beneath which is a corresponding endless moving chain which is connected to trolleys at regular intervals. The trolleys are also supplied with hooks, pans, racks or other means of supporting the articles to be conveyed. Sometimes the chain is not attached to the trolleys, but is supported from the track at intervals by rollers incorporated in its own construction, and moves the trolleys by pushers bolted to the chain at intervals. In any case, the trolleys carry the load and the chain pulls them along. The circuit may include any curves desired, and may travel up and down grades.

Also called an overhead track conveyor.

In another system the chain is replaced by a wire cable, which has some advantages for heavy work. This is also termed a suspended cable road, and a monorail cable tramway.

Page 400, 763, 772, 792.

Conveyor, Pan. A carrying conveyor for bulk material consisting of a series of pan shaped containers or buckets attached to endless chains passing around end sprockets, and carried on suitable horizontal guides. The pans are sometimes complete and independent, mounted on four carrier rollers traveling on rails, and connected by a rope or chain used to drag them (see Conveyor, Pan and Cable); or they may be complete, have overlapping lips and be carried and propelled by chains at their ends (see Conveyor, Steel Apron) or by a single strand beneath them. They are also made in the open end, endless or trough form, overlapping and forming a continuous trough into which material may be fed at any point, and discharged only over the head end. In the simplest form these are used as upper run conveyors only.

When used as lower run conveyors, they may be discharged at any point by having the pans pivoted to swing about the axis of the rollers at the front end of the pan. In one type an arm projecting downward from the front end of the pan strikes against a movable dumping cam, tipping the pan up behind and discharging the material forward. In another type a section of the rail is omitted; the front end of the pan passes across on account of being pivoted to the chain, but the rear end drops down, dumping to the rear. A curved guide brings it quietly up to a horizontal position again. Several discharge points may be provided by having as many sections of the rail which may be swung out.

Page 423.

Conveyor, Pan and Cable. A conveyor suited for long distance carrying, consisting of a series of small iron bound rectangular wooden pans or small cars, secured at intervals to a steel cable, supported on four rollers and traveling on rails. Beside the clamps attaching the pans to the cable, there must be intermediate ones for driving purposes so that at least two clamps will be on the driving sprocket at once.

This conveyor is usually loaded by hand, and may be unloaded by hand at any point, or automatically over the head sprocket.

Conveyor, Pivoted Bucket. A continuous conveyor consisting of overlapping buckets suspended on pivots between two endless strands of long pitch roller chain, capable of horizontal, vertical or inclined movement with the buckets carried level whether full or empty, and discharging the contents by tipping the buckets up or turning them over. It can be loaded or unloaded on either the upper or lower run, and can lower material as well as elevate it. The usual layout includes two horizontal and two vertical runs forming a vertical rectangle, though any runs may be inclined if desired. Of the four turns or corners, one is the driving corner, consisting of a pair of sprockets driven by a motor through speed reduction gearing, another is the take-up corner, where a pair of sprockets are mounted on a shaft having bearings which may be moved in straight guides to adjust the tension in the chains, and two are stationary corners. Curves may be used in the place of stationary upper corners, and are cheaper, but cause excessive wear on the moving parts.

Lap of the bucket lips is essential to prevent spilling during loading. In proceeding around the circuit, these laps must be kept in the proper relative position or the buckets will be turned up edgewise and the contents spilled at the upward turn ending a horizontal run. If, in dumping on the top run the buckets make a complete rotation (called a turnover discharge) the laps will automatically be correct. If the buckets are merely tipped up and then righted, the laps will have to be artificially reversed by a tilting device as they turn from the vertical into the lower horizontal run. In one arrangement, the bucket laps are made to swing entirely clear of each other at every turn by pivoting the buckets on extensions of the chain links beyond the pins connecting successive links, which also carry the rollers; the direction of bucket lap after discharge or at any other time is then unimportant.

The discharger or tripper may be fixed in location and capable of being lowered out of action when desired. It may be movable, being pulled in one direction along a track by a wire rope wound on a hand operated winch with pawl and ratchet; when the ratchet is lifted, the rope unwinds as a bucket pushes the discharger along the tracks in the opposite direction. Automatic dischargers can also be arranged, moving back and forth over a predetermined range.

The buckets are usually of malleable iron and made in one piece, and their size is specified by the pitch of the chain (practically the length of the bucket in the direction of the run) and the width. Hardened discharging cams are riveted to their sides, and they are connected to the chain by through rods projecting beyond the bucket sides. All wearing parts are made hard and supplied with renewable bushings where possible.

Loading is generally done on the lower run, and guards or inclined skirt boards are used to protect the chain.

Both horizontal runs are supported on cast iron chairs, and the vertical runs are kept from swaying by running the rollers between vertical guides.

Page 417, 826-836.

Conveyor, Pneumatic. A form of conveyor in which air in motion is the medium used to move material. Two distinct types are in use; one in which bulk or package material is handled in special closed containers which closely fit the interior of a pipe through which they are driven by a difference in pressure on the two sides of the container (see Conveyor, Pneumatic Tube), and the other in which bulk material is handled loosely by reason of the velocity of the current of air in which it is suspended, also called current conveying.

Most loose materials that are not very dense, even up to and including coal, can be handled by the air current system, and practice has shown that so long as certain minimum current velocities are provided, the material travels mostly along the center of the pipe and produces little wear on its walls, except at the turns. Here special hard wearing plates are fitted inside on the outside of the bend; target plates are also fitted in the separator chamber to receive the impact of the discharged material and prevent it from cutting through the walls of the tank. (See Conveyor, Suction Ash.)

Three systems of applying pneumatic current conveying are in use: the vacuum or suction system, the pressure or blast system, and a combination of the two, each of which has advantages under certain conditions. While the initial cost and the power required to operate any one of the systems are both large, the amount of labor saved is also great, the system is cleaner, almost literally every grain (of wheat or corn) can be recovered, the material can be elevated and conveyed at one operation, and the dust can be separated if desired, which is sometimes an advantage.

Page 405, 431, 763.

Conveyor, Pneumatic, Pressure System. A system of conveying bulk material by drawing it into the conveying pipe by the injector action of a high pressure jet of air discharged into the end of the pipe, and then carrying it along with the current until it reaches the outlet. It is especially applicable where it is desired to distribute material from a central location near which the machinery can be placed, to several separated discharge points. It will convey a longer distance than the vacuum system, but is dusty in operation.

The mixture of air and material sent through the pipe passes to a separator tank, where the solid matter is allowed to settle to the bottom, from which it can be drawn through a gate. The air is discharged from another opening, unless it is important to save or remove all the dust from it, in which case it passes through a filter on its way out.

The separating chamber is naturally omitted in such cases as the supplying of pulverized fuel to furnaces, and in certain methods of applying cement grout or concrete by air under pressure.

Also known as the blast system.

Page 431.

Conveyor, Pneumatic Tube. A method of conveying small objects which can be easily inserted in a special container, by placing it in a tube which fits it closely, and driving it through the tube from end to end by producing a difference of pressure on the two sides of the container. A variety of arrangements is used, but they can be broadly classed under the terms vacuum

system and pressure system, with some installations using a combination of the two. While originally devised, and still most generally used, for conveying written communications or small articles within buildings or large establishments, installations have been made where the containers are large enough to carry considerable material, such as mail matter, and including small packages.

The vacuum system requires two tubes for each pair of stations connected, or for a central and a distant point. The one used for receiving at the central station is there connected to a suction drum in which a vacuum pump maintains a low pressure; the two tubes are connected together at their distant ends, the second tube being the receiving tube for the distant station. The two tubes are thus in series, but independent; carriers can be sent in both directions simultaneously.

The pressure system uses a single tube which normally stands open, having a combined receiving and sending terminal at each end, with means of admitting compressed air behind a carrier as it is inserted. The rush of air ahead of it prevents the insertion of a carrier at the other end.

The combination system has vacuum incoming tubes to the central station each serving several sub-stations, and pressure out-going lines independent to each sub-station.

The vacuum system has the advantage of simplicity. The pressure system has the advantage of much greater power, and if a carrier sticks the pressure will build up until it is moved, or the pressure can be reversed to force it back to the sending station which the greatest possible vacuum may be unable to accomplish. Small leaks are not objectionable except as causing a loss of power, and water is not drawn into the tubes if they pass underground.

To conserve air, automatic power control devices are supplied at each terminal, which allow the air connection to remain open a sufficient time after the insertion of a carrier for the latter to reach its destination, but then shut it off. As there may be times when few or no tubes are operating, it is sometimes considered advisable to shut down the vacuum pump or pressure blower, as the case may be. The pressure in the vacuum drum or air receiver may be used to operate a rheostat on the driving motor, slowing it down when air is not required. Another system is known as the "start and timing stop system"; an electric circuit is closed by the insertion of a carrier and this is used to throw in the main circuit and start the motor, supplying pressure or vacuum, and not stopping until sufficient time has been allowed for the carrier to reach its destination. A later improvement adjusts the speed to suit the number of tubes in service, saving still more power.

The tubes are round or elliptical in section. The carriers correspond in cross section, but are somewhat smaller, made of metal, or hard fibre, and with enlarged hard fibre, leather or felt ends. The terminals are equipped with double or single doors as required by the system.

Page 405, 763.

Conveyor, Pneumatic, Vacuum System. A system of conveying or elevating bulk material by drawing it into the end of a pipe with a current of air which is produced by the suction of a vacuum pump at the far end of the system. It is especially applicable where it is desired to bring material from several scattered points to one central point, at which the machinery may be located.

It is used for grain, small coal, ashes, powdered chemicals, fibrous materials, dust, etc.

The mixture of air and material entering the suction nozzle and passing through the flexible suction and rigid connecting and discharge pipes, enters a large separating chamber in which the velocity is so small that the solid material settles to the bottom, from which it is removed. The air is drawn off at such a location and in such a manner as to carry as little dust with it as possible; it then often goes through air filters for further cleaning on its way to the suction pump which discharges it into the atmosphere. The object of the cleaning is to save wear on the pumps, to prevent the loss of material, or both.

For removing the deposited material without destroying the vacuum, several forms of air locks are used. One consists of a cylindrical rotor with pockets formed by solid end plates and six or eight radiating blades; it is so placed beneath the separator that as the grain falls into the pockets it rotates uniformly, discharging each pocketful into a chute (or weigh hopper or other receptacle) after it brings it out from under the separator opening which is exposed to a vacuum. Another device consists of a piece containing two pockets, which oscillates at regular intervals, one pocket receiving material while the other is discharging it.

Page 431.

Conveyor, Portable Belt. A section of belt conveyor with its head, tail and idler pulleys and driving mechanism mounted on a frame which is carried on a wheeled body in such a way that its inclination or the height of its discharge end may be varied, and the whole machine may be easily moved about, even being self-propelled in some cases. (See also Loader, Wagon.)

Also called a portable belt elevator.

Page 369, 440, 770, 772, 799, 837, 840.

Conveyor, Portable Wood Apron. A conveyor of the designated type which is mounted on wheels or casters so that it may be easily moved about, and provided with means for adjusting the height of one end. When the end is elevated, it may act as an elevator-conveyor or piler, or, reversed, as a lowerer; when lowered to the horizontal as a plain conveyor, often arranged as one in a series temporarily placed end to end for long run conveying purposes. It is usually composed of a base frame mounted on wheels or rollers, to which is hinged one end of the apron frame or boom. The latter is arranged to be raised by power, from the same unit which drives the apron and, in the largest sizes, propels the whole conveyor from one point to another. The apron is usually driven through the foot end, and the take-up is placed at the outer end.

Also called a portable apron elevator.

Page 352, 761-770.

Conveyor, Power. A conveying apparatus in which some form of power is used for operation, as distinguished from one in which gravity is the operating force. The latter is sometimes called a dead conveyor, as opposed to the term live conveyor sometimes used for a power operated one.

Conveyor, Progressive. A slow moving conveyor especially designed for the continuous assembling of a part which is to be produced in large quantities, with special stands, platforms or other appliances for supporting the part to which others are gradually added, and for allowing it to be turned or changed in position as desired. The conveyor is usually of the single or double strand

chain type, with the chains traveling in smooth channels, passing around sprockets at the ends, and returning beneath the working runway. Especially large stands may be made to fold automatically so as to return in a small space, or may be detached entirely and returned by gravity.

The use of this conveyor is coupled with an extreme division of labor of assembling, each operative performing but one function, occupying a regular station and accompanying the conveyor for a short distance while he is doing it. The parts to be assembled are brought to the stations by portable bins, feeder conveyors, chutes, overhead trolleys, elevators, or otherwise as necessary, and are continuously supplied. Where necessary, platforms or hoists move along at the same speed as the conveyor, carrying the men performing special operations requiring this.

Also called progressive assembling conveyor, and manufacturing conveyor.

Page 402, 772.

Conveyor, Push-bar. A continuous drag conveyor for material in large pieces or in containers, and much resembling a flight conveyor, consisting of a trough or runway bed along which the articles are dragged by crossbars, cleats or spurs, fastened at regular intervals to one or two endless strands of chain running parallel to the bed. Troughs with a U or V-shaped cross-section usually have one chain (or several acting together as one) in a groove in the bottom of the trough, or supported centrally by the disc shaped push-plates on which they are clamped, commonly called flights. (See Conveyor, Cable). Flat bottom troughs have chains in several locations; at the sides some distance above the bottom supporting cross or push-bars (see Conveyor, Push-bar, High Type); in grooves in the bottom near the sides with crossbars; cleats or spurs projecting upward; or in a single groove in the middle of the bottom with blocks or spurs projecting upward from their attachment to the single chain. The troughs or runway beds are usually faced with smooth planks, hardwood strips, steel strips, or corrugated or smooth steel plates. Flat bottom troughs for heavy service may have rollers set in the bed to decrease the power required. Troughs of this form also require side guards to prevent contact with the chain, and to prevent articles from working off sideways.

The return run may be beneath or above the conveying run, or, in certain cases, may also be used as a reverse direction conveyor. Loading at the end or intermediate points may be automatic or by hand; discharge may be at the end of the trough, or at any intermediate point by means of an opening in the trough bottom, closed by a suitable gate when not required. In this case provision must be made for the discharged articles to clear the returning crossbars; the return run is sometimes overhead on this account, but automatic loading at the end is then less simple. The conveyor can easily be made reversible, and can be driven from either end, though the load should be dragged toward the driving end if possible.

The chains are of various types, preferably with broad bottom wearing surfaces if they drag in grooved guides, or better, with rollers supporting their weight. The crossbars, cleats, spurs, etc., are fastened to appropriate attachment links inserted in the chain.

These conveyors operate easily on an incline, or may run from the horizontal to an incline with facility. When

used on steep inclines, they are usually called push-bar elevators. At the "goose-necks" or vertical curves where the change is made from the horizontal to the incline special precaution must be taken to prevent packages from digging in, especially if rollers are used to assist in loading.

Page 345, 759-773.

Conveyor, Push-bar, High Type. A push-bar conveyor driven by two endless chains connected at regular intervals by crossbars at a distance above the runway bed, depending on the size of the article to be conveyed. The end sprockets are usually beneath the run, and the crossbars operate at each end through cross slots in the bed; automatic loading and unloading at the ends are then possible if chutes or gravity roller runways are used to supply and remove the articles as fast as they are conveyed. Revolving crossbars are sometimes used to assist in proper loading by rolling out from under any piece improperly placed. Contact springs at the sides of the loading platform also straighten the parcel around, and center it on the runway.

These conveyors are reversible, and operate well on inclines. (See Elevator, Push-bar).

Conveyor, Reciprocating Flight. A flight conveyor in which the flights are hinged to a straight rigid frame extending nearly the full length of the trough, and which reciprocates from 24 in. to 28 in. endwise in it. The flights lift and slide over the material when moving in one direction, but swing down and push it along in the other. Material fed at one end is conveyed to the other by the action of successive flights.

Page 429.

Conveyor, Refuse Chain. See Conveyor, Drag Chain.

Conveyor, Retarding. An inclined conveyor which is used to lower material down a slope, usually a conveyor of the drag type. The flat flight with one or two strands of chain, moving in a flat bottom trough, and the disc flight on a heavy wire rope moving in a U or V-shaped trough are both in use; the last is also known as a cable conveyor. When the slopes are sufficient they are self-operative except at starting, requiring braking only. This may be obtained by governor controlled automatic brakes, or by a non-reversing worm geared drive from a motor, the conveyor moving only at a speed corresponding to that of the motor.

The drive and control machinery are usually at the head and the take-up at the foot. The head and foot sheaves are gap wheels, and sufficient flights or transmission blocks are attached to the cable to ensure at least two in contact with the gap wheel at all times. The gap wheels are made with compensating segments, and each gap is provided with rollers to ease the flights into the gaps.

Apron and other types of continuous elevators are occasionally called retarding conveyors when used for purposes of lowering. (See Boom, Loading.)

Page 448.

Conveyor Roller. A cylinder or truncated cone of wood or metal used for carrying packages on a roller conveyor, and supported at its ends by bearings in roller support bars. The conical form is often used on curves, but not elsewhere.

Page 454.

Conveyor, Roller. A type of package carrying conveyor which supports the load to be conveyed on rollers turning in fixed bearings, and spaced at distances apart depending on the size of the units carried. The rollers

themselves are carried in bearings supported by longitudinal members called roller support bars, which, with cross members, are united into a rigid rectangular frame constituting a section. One of these sections, or a series of them coupled end to end, and set on a series of roller conveyor supports of graduated heights with sufficient grade to cause the packages to move by themselves, is a gravity roller conveyor; when the rollers are turned by power, compelling the motion of the packages, it is called a power roller conveyor, and when push-bars are drawn by power along above the surface of the rollers, moving objects caught between them, it is known as a push-bar roller conveyor (also an elevator or a booster if up a slope).

(See also Conveyor, Roller, Portable).

Page 378, 759-773.

Conveyor Roller Bearings. See Conveyor Roller.

Conveyor, Roller Gravity. A gravity conveyor in which the containers conveyed are carried on rollers turning freely on axes fixed in supporting frames. The axes of the rollers are horizontal, but the frames are set at a small angle so that packages placed on them will travel down the slope by gravity. The angle varies with the smoothness and weight of the package carried; the proper length and spacing of the rollers depends on the dimensions of the package, and their diameters on its weight and character.

Page 378, 759-767.

Conveyor, Roller, Portable. A section of roller conveyor permanently assembled with separate supports and mounted on casters so that it can be easily moved. The height may or may not be adjustable. Also, section of runway with its outfit of separate adjustable supports, which is assembled where needed, but is usually disassembled when moved to a new location.

Page 378, 759-767.

Conveyor, Roller, Power. A roller conveyor in which the units to be conveyed are carried along horizontally or up grades by the application of power to all or a portion of the rollers on which they rest. These rollers are driven either by a light longitudinal shaft carried along the side of the supporting frame and connected to the live rollers by bevel gears, or by a light chain which runs along over the teeth of sprockets on one end of all the rollers, engaging with and driving them. Both methods will allow slight curvature in the runway, the shaft in the first method having universal joints inserted at regular intervals.

Beside being used as boosters and feeders, these power rollers inserted at intervals in a nearly horizontal runway will serve to keep the loads in motion.

Page 504, 759-767.

Conveyor, Roller, Push-Bar. A push-bar conveyor in which the runway bed is composed of freely turning rollers supported in side frames. It is usually used in an inclined position and operated as a booster. The head and tail shafts are below the level of the rollers; the push-bars, attached to the endless chains carried on the sprockets on these shafts, come up into action between rollers at the lower end of the incline, and likewise pass down at the top.

Page 345, 759-767.

Conveyor Run, Upper, Lower and Vertical. A conveyor layout consists of runs—horizontal, vertical, inclined—and turns or corners. For plain conveyors there are upper and lower runs and turns. Some conveyors have vertical or inclined runs, but where these are large,

as compared with the horizontal runs, the machines are properly called elevators. Where material is carried on a conveyor upper run only, it is termed an upper run conveyor, and vice versa.

Conveyor Screw. The screw suspended within the trough of a screw conveyor. It usually consists of a single helical formed blade around a central shaft or pipe, though double blade screws are often used and give smoother delivery. The screw may be cast in one piece or in separate flights of one rotation each, the latter being assembled and set-screwed or pinned on a central driving shaft, and often notched or grooved into each other. They are sometimes made in halves and riveted to a square shaft. Screws are also made of steel flights formed from an annular disc by a rolling process which stretches them into a helical form; these are riveted to each other and to lugs on the driving shaft or tube to make up the complete length of screw. They are also formed from straight strips of steel which are rolled into a spiral by a different process which causes the outer edge to become thinner than the inner. These are sometimes called helicoidal screws, and are fastened to the conveyor shaft by lugs.

Screws are not allowed to drag in the conveyor trough, hence long screws must be supported at regular intervals. They are usually made up in lengths corresponding to these intervals, connected endwise by pins slipped within the pipes on which the flights are fastened and pinned crosswise to them, or by squared pins fitting in squared pipe ends. A bearing is formed on the middle of this coupling pin or gudgeon, or a seat is provided for a split bushing which runs in a hanger supported from the top edges, sides or bottom of the trough. Solid bushings are also used with split bearings. The bearing and hanger form an obstruction in the trough at the very point where the screw is discontinuous, so that excessive wear comes on the end of the next flight as it enters the material; these end flights are usually made of heavier material, or a manganese steel piece is riveted to the ends of a continuous flight.

Sticky materials tend to collect near the axis of the screw around the shaft; this is eliminated by using the ribbon conveyor screw, in which a narrow helix is held in position by arms radiating from a central shaft. Sometimes two ribbons are used of the same or different pitches, and to the same or different hands, these special forms being introduced to increase mixing effects. Double ribbons or ribbon blades are also used in the same way as solid blades.

Other special forms of screw are the paddle flight, where each flight is made with two opposite blades twisted like a screw propeller, the cut flight where deep cuts are made in the periphery of a continuous flight, and the cut and folded flight where portions of the cut flight screw are bent backward in addition. Intermediate paddles are also often fastened to the shaft to give added mixing power.

The end thrust of the screw is small in light conveyors and may be taken by set screwed collars; for heavy duty solid collars or ball thrust bearings are used, or a step bearing may be included in the delivery end plate bearing.

Page 458.

Conveyor, Screw. A type of drag conveyor in which a screw with a relatively wide and thin helical blade is supported inside of and parallel to a horizontal (or inclined) trough which it fits more or less closely, and conveys bulk material along the trough by the action of

the inclined surface pushing through it. The material is carried up on the side of the trough as well as being pushed along it, and then tends to slide down the inclined surface of the screw; as gravity is therefore partly responsible for the motion, high speeds are undesirable, and every conveyor has a speed or rotation which will give maximum delivery.

The screws may be right or left hand according to the delivery desired and convenience of drive; right and left hand screws may also be used to deliver in opposite directions from a central feed point, or to bring together two materials fed at opposite ends. Very long screws are supported at intermediate points in bearings which are hung from the top or sides of the trough, or supported from its bottom.

Material is usually fed into the trough at the top of one end; it may be delivered through the opposite end, or through bottom openings at the end or at any desired intermediate points. Suitable gates of the slide or swinging types control the discharge at these intermediate points. One screw conveyor may discharge into the top of another in a lower plane and at any angle desired, and the drive be carried from one to the other by simple geared arrangements; if they are required to be in the same horizontal plane miter gear ends are used, and the material delivered at the discharge end of one conveyor is pushed across a diagonal passage to the receiving end of the other; the resistance is excessive and the arrangement is not used when the two-plane type is possible.

Screw conveyors are not highly efficient in the use of power, but they are cheap and require little space, and whenever mixing or agitation is important they are suitable. Semi-liquids and sticky substances may be easily handled, stuffing boxes being arranged at the ends of the troughs if desired. The drive may be at either end; as ordinarily installed, screw conveyors are not readily reversible. They may operate in an inclined position, or even vertically, at reduced capacities and with certain materials.

Page 424.

Conveyor, Screw, Trough for. The trough containing bulk material which is conveyed by the rotation of the screw. It should fit the screw closer than the size of the smallest particle carried, or else there should be sufficient space to clear the largest particles. Troughs are usually made U-shaped in section, though square sections are not uncommon. They are made of wood, wood lined with metal, steel with lapped or butted joints, or cast iron or steel with flanged connections. Special materials are used for corrosive substances, and perforated linings are sometimes suspended inside to allow dirt and other foreign matter to separate from certain materials being conveyed.

The trough ends may be fitted inside or outside the trough, and may or may not have the bearings included in them, separate bearing stands being used in the latter case. The trough body is supported on conveyor box saddles at proper intervals. Loose, tight or dust-proof fitting lids may be used, but if the lid is fastened down accumulation in the delivery end due to a choke in the discharge may cause a breakdown. The trough may be steam jacketed, or jacketed with cold water for cooling purposes.

Page 458.

Conveyor, Selective. A conveyor which will automatically deliver packages or other material to any station selected by the sender at the time of despatching.

Service may be given in one or both directions, or the conveyor may make a complete circuit, always travelling in one direction.

A simple form for delivering from a central station to different destinations consists of a travelling horizontal belt with parallel vertical partitions between which objects may be placed; the partitions extend to the various discharge points, where they successively end in diagonal turns that sweep off the material in the spaces on to a receiving shelf. This conveyor is best suited to narrow objects that can be placed on edge between the partitions.

Another type consists of a belt or apron conveyor carrying to boxes or trays which occupy the full width of the conveyor. Each tray has a movable finger with numbered positions, usually at the front end of the tray, which engages with a switch at the destination corresponding to the number at which the finger is set, and switches the tray to an inclined shelf to a branch conveyor having its own stations, or to an automatic elevator.

A cable operated tray or car running on wheels may also be operated selectively by having a gripping device that will disengage when switched by the selective device; it may also be arranged to engage automatically when it is picked up from a sliding or branch line and to disengage again at the proper station.

A series of trolleys gripped to an endless chain or cable at regular intervals, and supported by an overhead monorail runway can be made selective and used for carrying packages like mail bags hung to the trolley on hooks. Each hook is made to turn down and drop its load when unlocked, and this is performed by an unlocking slide attached to the trolley, and having a movable tripping finger which can be set in as many positions as there are stations for delivery, a fixed finger at each station tripping the hook as the trolley passes. Just before each trolley completes its circuit and reaches the sending station, it passes a resetting cam which places the selective finger in neutral position; the despatcher then sets the finger for the desired destination by adjusting a movable cam at the sending point. This is also called a bag carrier. One method of driving the cable consists of a short endless auxiliary cable, parallel to the main cable, and having grips which close on the latter as they swing into position traveling parallel to it, and which release as they leave it preparatory to passing around their own gapped driving sprockets.

Conveyor, Shuttle. A name sometimes applied to a horizontal reversible belt conveyor, the frame of which is supported on wheels on a track, so that it can be adjusted endways. It usually receives its material from a feeder at the middle of the length over which the material is to be distributed; by adjusting both the position and direction of rotation of the conveyor, material may be deposited at any desired point. As this conveyor will be only half the length of an ordinary conveyor running the full length of the bin, it is considerable cheaper. Small sizes may be hand adjusted; larger sizes may operate continuously and reverse automatically. They are usually electrically driven, but rope drive may also be applied to the moving shuttle.

Conveyor, Slat. A wood apron conveyor in which the wood cross pieces are relatively narrow and are separated, leaving open spaces between. This construction is as suitable for large packages, bags or boxes as a complete apron, and is lighter. The discharge may be over the end for all packages carried, or at intermediate points

by a side plow or diverter, but only for flat, smooth bottom boxes or trays.

Page 352, 759-771.

Conveyor, Sling. A carrying conveyor and elevator used in ship loading and unloading, consisting of a light horizontal truss along the top and bottom chords of which pass the upper and lower runs of a pair of endless conveying chains. These chains also have loops at each end of the truss hanging downward over sprockets at the ends of the horizontal runs; weighted foot sprockets may be hung in these loops. Between the two chains at regular intervals are placed cross bars along which an endless canvas belt is hung in long loops and secured to each bar. The truss is supported transversely above the deck of the ship, on temporary supports or hung from the ship's derricks, with the pendant loop at one end hanging into the hold, and that at the other reaching down to the wharf. The chains are driven by a motor, and articles placed in the loops of canvas as they pass the loading point in the hold will be elevated to the deck, conveyed horizontally across it beneath the truss, and lowered to the wharf where they are removed. As the loads pass the two turns they are rolled to new positions in the canvas sling, but are not discharged if properly placed in the beginning, and not too large. For loading the direction of motion is reversed. Variations in the height of the pendant loops may be obtained by having the chains pass back and forth around movable idlers in the idle run along the truss, or by inserting or removing lengths of chain with their attached canvas loops.

As ordinarily made the machine is portable, and is placed on a cradle for moving from one hatch to another, if no overhead crane is immediately at hand. Other types are permanently placed on the wharf and deliver to lines of conveyor runway for removing or bringing parcels as fast as they can be handled by the sling conveyor.

Page 403.

Conveyor, Spiral. A gravity conveyor in which the material travels downward in a helical path around a vertical axis. The runway may be plain slide or chute, in which case the slope will be steep and few turns will be needed, or it may be a roller conveyor, in which the grade will be small and many turns will be needed. (See Chute, Spiral; Spiral, Gravity Roller.)

Also a helical or screw conveyor. (See Conveyor, Screw.)

Page 424.

Conveyor, Steam Jet. A form of current conveyor in which steam at a high velocity is the agent used to move the material, most often applied to conveying ashes or similar waste material. It consists of a suction pipe having hoppers into which the material may be fed (the openings being closed when not in use) connected to a conveying pipe leading to the discharge point. One end of the suction pipe has an opening through which air can pass; at the other end, and so directed as to produce an injector action in the suction pipe away from the open end, is a steam jet. The rush of air in the open end of the pipe carries the material along with it and past the jet; from that point on the material is forced by the direct action, or blast of the jet, through the horizontal or vertical leads of the conveying pipe and around elbows to the discharge point. Here there may be a closed storage bin where the material is allowed to collect for periodical (or continuous) removal through a gate at the bottom; the air passes out through a vent pipe. Or in the case of ashes the discharge may be into a baffle box

which holds the discharge within a small space, from which it may drop into a railroad car, or it may blow directly into the open air and fall on a heap on the ground, where it is used for filling in purposes, or is removed later by other means. If the discharge line is very long, booster units containing additional steam jets are inserted at suitable intervals.

All parts of such conveying system, especially where an abrasive material like ashes is handled, are made of the hardest material obtainable, and at all points where the wear is greatest, renewable parts should be provided. Where the discharge is into a closed storage bin, or into a baffle box, hard and easily renewable impact plates or targets must be provided to receive the force of the jet, or else the plating of the structure will be speedily cut through at that point.

Various fittings are used, including steam units of 90, 60, 45 and 30 deg.; Ts, elbows, intake tees, elbows of 90, 60, 45, 22½ and 11½ deg., branch laterals, etc., and each is provided with a renewable plate at the point of ash impact.

Beside being used for ashes, steam jet conveyors are used for removing soot from beyond the bridge-wall of a boiler furnace.

Page 431.

Conveyor, Steel Apron. A carrying conveyor consisting of two parallel endless strands of chain passing around sprockets and carrying between or on them a series of flat, curved, abutting or overlapping metal plates whose width corresponds to the pitch of the side chains to which they are fastened. It forms a continuous metal supporting belt for carrying heavy bulk material on the top run. The plates, occasionally termed flights, often have ends turned up at right angles and overlapping in such a way as to maintain a trough form even while passing around the sprockets at the head and tail ends of the conveyor run. Such a conveyor can ordinarily be discharged only over the head; if the turned up ends are omitted and the chain links are attached beneath the plates, a scraper placed diagonally across the apron will discharge material at an intermediate point. (See Diverter.)

The forms and laps of the plates vary according to the nature of the material, the depth of the layer, and the length and inclination of the conveyor. The simplest is the flat plate without lap, with plain or downward flanged edges; there is also the plain lapped plate, and the lapped plate with one edge flanged downward. Overlapping plates curved to the radius of the end sprocket may have a scraper pressed against them as they pass around the head to remove sticky material. Single beaded plates have a bead formed with the convex side upward on the leading edge, overlapping the plate ahead; double beaded plates have beads of slightly different radius on both edges, the leading edge lapping over the smaller bead on the plate ahead and making a joint through which material is not likely to work. Both single and double beaded plates may be flat as described, or bent up lengthwise to nearly a right angle, each plate making a V-shaped trough; they may also be depressed between beads into shallow or deep pans, often called pan conveyors. The shallow pans are often lined with wood making a level apron for receiving heavy and abrasive materials.

Special forms of apron plates are often required, the following being examples: for lehrs, interlocking of the adjacent plates helps to keep them from warping in the intense heat; for very heavy work, chain links may be

cast integral with cast plates, and the rollers set in integral lugs beneath.

For any except the lightest loads the chains are of the roller type, travelling on suitable tracks. When placed beneath the pans, the latter are better supported to receive a heavy load, and can therefore be used as feeders under hopper; the apron cannot be supported on the return run and this construction is therefore limited to a short run between the end shafts. The pitch of the chain is the same as the plates; they are connected by riveted attachment links, and the rollers lie at the center of curvature of the bead. Attachment links are also used when the chains are placed outside the plates, with the rollers between the chain links and the roller pin extending the full width of the conveyor, thus preventing the rollers from tipping. For light and heavy work, plain rollers on flat rails and flanged rollers on T-rails are used respectively. The plate ends are bent upward in one piece in some cases, but are also often made of separate formed pieces riveted to the plates; sometimes the chain link itself forms the end plate.

These conveyors are usually supplied by a feeder through a hopper of suitable width. Fixed skirt boards are sometimes used the full length of the run to enable a deeper layer of material to be carried, or to prevent lumps from working off. Narrow conveyors are sometimes termed feeder widths; wide ones, loading boom widths. When wooden pieces are used instead of the steel plates the conveyor is termed an apron or a platform conveyor; when used in an inclined position an apron or platform elevator.

Page 423, 760-771.

Conveyor Switch. See Switch, Conveyor.

Conveyor, Trimming. A continuous conveyor, often of the V-bucket type, arranged for trimming coal in the bunkers and holds of a ship. It is arranged to be suspended by ropes from above, or by props beneath, and consists of an inclined receiving end with an open bottom self-feeding boot, secured at an adjustable angle to an upper horizontal delivery run which has several discharge points. The horizontal run is placed close up underneath the deck, extended away from the port or hatch, and reaches points to which the coal will not flow, even higher than the entry port if desired.

Conveyor Trough, Flight. The trough of a flight conveyor may be made of wood, wood with sheet steel lining, lap or butt jointed bent steel plates, steel drop forgings or cast iron. They are rectangular, flat bottom with slanting sides, U-shaped or V-shaped in section, the last two being used for single strand conveyors only. When used for conveying a gritty or abrasive material like ashes, the trough is made of hard white cast iron; renewable linings are also sometimes provided. (See also Conveyor, Jacketed.)

Page 464.

Conveyor, Vibrating or Reciprocating Trough. A horizontal trough mounted on inclined elastic wooden supports, and oscillated endways by an eccentric with spring connections to the trough. The slant of the supports is such that the trough moves upward while going forward, and drops as it returns; at a proper speed the material actually leaves the bottom of the trough temporarily and keeps in almost continuous motion. It is especially suitable for sticky materials.

Also called grasshopper trough conveyor.

Page 429.

Conveyor, Wood Apron. A carrying conveyor consisting of two parallel endless strands of chain passing around sprockets and attached to the ends or bottoms of a series of wooden cross pieces forming a smooth platform. When the chains are at the ends they support as well as move the apron, and are of the plain type sliding in smooth guides, or of the roller type running on rails; the former is often termed a wood apron drag conveyor. In the carrier type, each cross piece is supported by two or four rollers on axles fastened beneath it, and running on suitable guides or rails; the chains are then attached to the bottom of the slats or to the carrier frames, and serve merely to propel the apron and keep the parts properly spaced. Occasionally one chain only is used, and is placed at the center.

The wood crosspieces may be flat on top and form a smooth, even platform; when located at floor level it is often termed a platform conveyor; when set on an incline it may be called a platform or apron elevator; and if arranged with special regard to conveying people an escalator or a traveling ramp. When the cross pieces are narrower than the pitch, leaving spaces between them, the machine is generally termed a slat conveyor. The cross pieces may be beveled along the long sides on top, giving to the apron the effect of transverse grooves; detached lugs or full length angle bars may be attached to them to get a better grip on articles carried, especially where part of the run is up an incline; or special chocks or cradles may be bolted to each or to alternate pieces to carry objects like barrels, kegs or irregular machinery parts. Sometimes cleats are fixed to the cross pieces, parallel to the conveyor run; these allow the use of a fingered loading platform, or a comb with prongs at both ends of the run, and make loading and unloading at the ends easier and even semi-automatic.

Loading may be at the end or any intermediate point; discharge is simplest over the end, but can be produced with smooth aprons at any intermediate point by the use of diagonal diverters.

The drive is usually at the delivery end for a one way conveyor, but if reversible it may be at whichever end is most convenient.

Page 322, 761-771.

Conveyor, Wood Apron Drag. A name sometimes applied to a wood apron conveyor in which the two chains attached to the ends of the slats are not provided with rollers for supporting the load, but are dragged along smooth guiding surfaces. The chains are sometimes flat sided, provided large wearing surfaces, or are provided with wearing shoes which may be renewable.

Core. The central supporting post of a closed center type spiral chute, to which the wings forming the spiral are attached, and which carries the vertical load.

Cordage. A comprehensive term used to include all sizes and varieties of twine, rope, cable, etc., made from fibrous materials like manila, hemp or sisal.

Counter, Sack. A mechanism arranged in a chute to count packages or sacks as they pass. Several types are in use, including one having an arm which is swung by each object passing, returning to its position immediately. Another utilizes the weight of the sack passing over a tilting plate in the chute bottom to work the counter.

Counterweight. A heavy weight so placed and connected in a machine as to counterbalance a load or moving part. Locomotive cranes and rotating cranes in general have fixed counterweights placed on the opposite side of the turntable from the load. Part of the counter-

weight is made up of the operating machinery, the remainder being scrap iron, sand, or concrete, these being cheap and not requiring shipment with the remainder of the crane. Where saving space is important, cast iron weights are used. Horizontal cantilever cranes, floating cranes, and pillar cranes often have counterweights mounted on wheels, which automatically moves along the rear end of the cantilever in symmetry with the load on the main arm by rope connections.

Occasionally vertically moving counterweights moving in guides are connected by wire ropes to the moving part to be balanced, as for instance the boom of a luffing crane.

Also called ballast, which is more correctly applied to the material making up the counterweight.

Coupling. A device for securing together the ends of the units of a series of objects or parts arranged in line like hose, shafts, pipes, conveyor runway, etc.

Also the mechanism at the ends of cars by which they are connected to one another or to a locomotive, for making up trains; a car coupling.

Coupling Bolt. A bolt used in holding together the parts of a coupling—particularly applied to a shaft coupling.

Coupling, Double Cone or Muff. A shaft coupling consisting of two short sleeves fitting the shaft ends and keyed to them, split at one point and having conical surfaces on the outside. Another sleeve, having internal conical surfaces at the two ends fitting the shaft sleeves, surrounds them, and the two inner cones are drawn together strongly by bolts passing through them. The inner cones clamp the shaft on the inside, and wedge in the outer sleeve on the outside, the torque being transmitted from one shaft to the other by friction between the two conical surfaces. The through bolts are also placed so as to act as keys and prevent continued slipping if it should start.

Occasionally the relation of the sleeves is inverted, a continuous split sleeve being fitted over the shaft ends, and two external sleeves are drawn together by bolts.

Coupling, Flange. A shaft coupling consisting of two flanged sleeves or hubs each fitted and keyed to the end of its shaft. The flanges are fastened together by bolts passing through them; projecting rims or cylindrical flanges should be provided to prevent the projecting bolt heads and nuts from causing personal injury. The torque is carried by shearing stress in the flange bolts.

Coupling, Flexible. A coupling which provides a small amount of elastic yielding in the connection between two shafts, so that sudden shocks in starting are avoided, and also so that small amounts of mis-alignment will not cause damage. One type has flanges facing each other on the abutting shaft ends, and each flange has a circular row of pins on its face. An endless belt may be wrapped in and out among these pins, or adjacent ones may be attached with separate loops of belting. Loosely fitting flange bolts with rubber bushings, and laminated-telescoping flange bolts are two other devices used. A thin tube corrugated circumferentially, or its equivalent, may be bolted between the two flanges.

Coupling, Oldham's. A shaft coupling intended to connect shafts which remain parallel, but may get out of alignment. A flange is fastened on the end of each shaft, each flange having a groove running diametrically across its face. Between these two flanges is placed a disc having diametrical tongues on its two faces, these tongues being at right angles to each other, and each fitting into a groove in the shaft flange. When the shafts rotate, the

tongues slip in the grooves if the shafts are not in exact alignment.

Coupling Pin. A pin used in car couplings.

Coupling, Shaft. A device for connecting the adjacent ends of two shafts so that rotary motion may be transmitted from one to the other. Various types are: the flange coupling, the split or clamp coupling, the muff or double cone coupling; these couplings require accurate alignment of the two shafts. If the shafts are parallel but not coincident, Oldham's coupling may be used; if intersecting but not in line, a single universal coupling is used; if neither parallel nor intersecting, two universal couplings with a short piece of shaft are required. (See Universal Joint.)

Flexible couplings are used where it is desirable to have a small amount of elasticity between the two shafts, to avoid shocks at starting or stopping; such couplings are generally applied to shafts which are in alignment, though many of them will also permit a small amount of divergence.

For couplings which permit the two shafts to be easily disconnected at will, see Clutch.

Coupling, Split or Clamp. A shaft coupling consisting of two half-cylinders fitted to the shaft on their inner surfaces. They are bolted together over the joint in the two aligned shafts by transverse bolts, and one of the two halves of the coupling is provided with a key. The torque is carried from one shaft to another by torsional stress in the half-couplings.

Crab. A term rather indiscriminately applied to several types of small hand-winch, to some winches operated by power, and also occasionally (British) to crane trolleys. (See Winch and Trolley, which are preferable terms.)

Crane. A machine for moving heavy objects by raising them, moving them horizontally, and lowering them in the new location. Two mechanisms are essential: the hoist for the vertical motion; and the mechanism of translation for the horizontal motion.

Page 155.

Crane, Boat. A type of rotary pillar crane for handling heavy lifeboats, launches, etc., on shipboard, principally on warships. One curved piece, usually of box-girder construction, which replaces both pillar and boom, is pivoted at the base, and carries the lifting tackle at its upper end. For heavy loads, the slewing is done by power; for smaller loads, it is done by hand, and in this case the frame is made of a single curved piece of steel, called a davit.

Crane, Braced Jib. A jib crane built up of structural steel shapes, diagonal braces and ties, gussets, clips, etc., riveted together, as distinguished from one which is built like a curved plate girder, or is formed of a single curved piece like a ship's davit. Two general types of bracing are top or tie rod bracing, and bottom or under bracing. The simplest top braced or tie rod construction exists where the mast and jib are two straight structural shapes connected at right angles, and a diagonal tie attached at or near the outer end of the jib connects it to the top of the mast. Several such diagonal ties may support as many points of the jib.

The simplest under braced jib has a single straight diagonal strut from the bottom of the mast to a point at or near the end of the jib; to increase clearance this strut may be curved inward. To give a better support to the jib and also to give good clearance underneath the brace,

it is often run to a point about half way out on the jib, and shorter diagonal struts run from its middle point to two other points on the jib. This is called a triple under-braced jib.

Another combination form of bracing, called top and back bracing, is obtained by extending the jib back past the mast a short distance, connecting the end of this extension to the top and the bottom of the mast by a strut and tie, respectively, and supporting the main or front portion of the jib by ties from the top of the mast. This gives maximum clearance under the jib, with maximum economy of material, but requires good head-room.

Crane, Bracket or Bracket Jib. See Crane, Wall Bracket Jib.

Crane, Bridge. A crane having a bridge along which a trolley carrying a hoist and a load may travel. The bridge may or may not be capable of travel. In this sense the term is used merely to distinguish a gantry or overhead traveling crane from a swing, jib or wall crane, or derrick. Sometimes called a girder crane. (See also Gantry, Cantilever Bridge.)

Page 155, 777-800.

Crane, Bridge Storage. A term sometimes applied to a gantry crane (with or without cantilever ends) especially arranged for the unloading of material in bulk, such as ore, coal, sand, gravel, etc., from cars or vessels, and placing it in open storage piles; also for reclaiming such material from the piles and loading it on cars or vessels. (See also Gantry, Cantilever Bridge.) The material is usually handled by a grab bucket. The hoisting winch is fixed in one of the towers, and the trolley is moved and the bucket hoisted by wire ropes. Or it may be of the man-trolley type, where the operator rides in a cab traveling with the hoist, all electrically driven.

Page 791-799.

Crane, Bucket. A term often applied to any type of crane which is capable of handling a grab bucket and is equipped with one. Any crane, provided it is sufficiently powerful, can handle a single line grab bucket, though the addition of a tag line or other means of preventing rotation of the bucket may be necessary. A two-line bucket requires two hoisting drums which are partially or completely independent.

For continuous and rapid action, durable machinery of proper strength and high speed must be supplied, but any type of crane may be adapted to the work. Overhead and gantry travelling cranes, derricks and locomotive cranes are, perhaps, used most frequently. (See Trolley, Bucket.)

Page 786-800.

Crane, Cantilever. See Gantry, Cantilever; Crane, Horizontal Rotating Cantilever.

Crane, Cargo. A crane especially adapted to the transferring of cargo between a vessel's hold and a wharf or lighter. If located on a pier or wharf, it is generally termed a wharf crane; if located on the vessel, it is often a derrick, and is one of the principal parts of the cargo handling gear. (See Cargo Handling Gear; Derrick, Ship.)

Page 191, 797, 798.

Crane, Charging. An overhead travelling crane especially developed for steel works use in charging open hearth furnaces. A rigid structure hanging below the bridge has a horizontal arm which is capable of being lowered until the end is connected with the charging box, of raising it, passing it endways through the charging

door, and rotating it about a horizontal axis, dumping the load of scrap. The motions are then reversed. (See also Charging Machine.)

Page 165.

Crane, Code of Safety Standards. Page 158.

Crane, Column Jib. See Crane, Pillar Jib.

Crane, Counterweight Cargo. A type of cantilever gantry crane used for cargo handling, in which, by a special reeving of the hoisting rope, the weight of the hook, fall rope, down-haul ball, block, skip or slings, together with half the average load, are balanced by a counterweight. The load hook must then be lowered by power against the pull of the counterweight, but the size of the motor or engine and machinery to operate the hoist may be greatly reduced, as less power is required.

Crane End Truck. One of the two end frames or carriages of an overhead travelling crane structure having wheels rolling on the rails of the runway, and supporting the ends of the bridge girders. In small cranes the trucks may be of cast or forged steel; in larger sizes they are of structural steel, cast steel or combinations of the two. They are rigidly secured at right angles to the crane girders, and are braced with horizontal gusset plates to prevent the structure getting out of square. Fitted bolts and reamed holes are generally used for these fastenings, as they must be made in the field, and the utmost rigidity is necessary. To prevent any appreciable drop in case a wheel breaks during use, a portion of the end frame in the form of a lug projects downward close to the rail; in some cases the bridge girders themselves extend across the rail and only slightly above it. These provisions also allow the end frame to be easily raised by wedges in order to remove the track wheels.

For light loads there are two wheels in each truck; for heavier loads there are four, arranged in pairs with equalizing or compensating trucks; for the very heaviest loads there may be eight or sixteen wheels on two parallel rails. The form of the end frame is also strongly influenced by the type of wheel bearing: if of the M. C. B. type, in which the axle is forced into the wheel and turns with it, cast bearing boxes with an oil cellar are bolted or riveted to the truck. If of the pin and keeper type, in which the wheel turns on the axle, the pin generally passes through the two side plates of the truck which are reinforced to receive it. The wheel is between the side plates and has a bronze bushing which turns on the pin, the latter being held in place by keepers. The wheel should be placed symmetrically between the two sides of the end truck, and every effort should be made to distribute the load from the bridge equally between the two sides.

Also called end carriage, end cradle, end frame, truck beam. (See also Equalizer Saddle; Crane Girder.)

Page 155.

Crane, Fitting-out. Any crane arranged and located especially for shipyard use in placing engines, boilers, guns, masts, stacks, armor, etc., in a ship after it is in the water. It is generally located on a dock close to the water, or is a floating crane. The various types are all characterized by extremely large lifting capacity, a large clearance under the part extending over the ship, and a sufficient reach to cover the width of the ship, and sometimes more, in order to pick up material from a barge brought to the far side of the ship from the crane. (See Crane, Folding Jib Gantry; Crane, Floating Gantry; Crane, Horizontal Rotating Cantilever.)

Page 197.

Crane, Fixed. A crane whose principal structure is mounted on permanent or semi-permanent foundations. The area served is strictly limited by the dimensions of the moving parts of the crane, and neither the whole crane structure nor any considerable portion of it has any motion of translation during the operation of the machine as a crane.

Page 169.

Crane, Floating. A crane mounted on a barge or pontoon which can be towed or self-propelled from place to place, and used for lifting and moving heavy weights at docks, ship fitting berths, etc., and for heavy marine work generally, including salvage operations. These cranes are generally of large size and capacity, and are built in various styles. Some are jib cranes, with a rotating jib of fixed radius, or with a variable radius obtained by means of a trolley. Others have rotating booms of variable inclination. Gantries and shear legs are also used afloat, and for small work; stiff-leg derricks mounted on barges are common, and are termed derrick boats or floating derricks.

In rotary floating cranes of large capacity, every possible effort is made to get the maximum lifting power at the maximum possible distance from the side of the pontoon, with a minimum of tipping, and with this purpose in mind, the crane structure is generally located away from the center of the pontoon, and the operating machinery is utilized as a counterweight by being placed on the rotating part opposite to the load. Adjustable or movable counterweights may also be used, or some of the pontoon compartments may be flooded with water for the same purpose.

Page 195, 801, 802.

Crane, Foundry. A name sometimes given to a rotary underbraced jib crane, with a trolley running on the top of the jib, and operated by hand or power. It has been extensively used in foundry practice, in capacities of one to ten tons. (See also Crane, Rotary Jib.)

Crane, Gantry. See Gantry.

Crane, Gantry, with Inclined Cantilever. A crane used in handling excavated material, and consisting of a gantry base central tower on which a long truss is supported at its center in a slanting position. A rope trolley handling a grab or bottom dumping bucket operates on the bridge, the motive power being located in the central tower, and the whole structure moves on a track under the tower. The lower end of the cantilever extends over an excavation like a canal, and the upper end over the spoil bank; the excavated material is carried from the excavation to the spoil bank by the bucket.

Crane, Girder Frame Jib. A type of rotary jib crane in which the mast and jib curve into one another and are substantially all one piece, being built up in a plate girder of box section composed of plates and angles as distinguished from Lattice Frame and Braced Jib Cranes. (Also called Fairbairn Jib Crane.)

Crane, Guyed Jib. A jib crane in which the top of the mast is held in place by diagonal stays leading to anchorages in the ground at some distance from the base of the mast.

Crane, Hammerhead or Hammerhead Jib. See Crane, Horizontal Rotating Cantilever; Crane, Pintle.

Crane, Hand. A crane which is operated by human power. The usual method of applying it for hoisting is by means of a rotating crank. For travelling or swinging, the load may be directly pushed or pulled by hand,

or by hand-operated cranks with appropriate rope or chain connections.

Page 159, 777-800.

Crane, Horizontal Rotating Cantilever. A rotating crane consisting of a horizontal double cantilever structure of unequal arms, supported on an elevated roller bearing turntable, carrying the load at the end of the long arm, or at a variable radius by means of a trolley which can travel along the lower chord of the long arm, and bearing the operating machinery and counterweight on the short arm.

In very large sizes, for ship fitting out, it may be mounted at a dock or on a barge. In smaller sizes it often has a gantry base and is called a tower or shipyard crane. When the tower is very short, it is sometimes called a turntable crane.

It may also be fixed on a travelling gantry, or may be mounted on a trolley on a fixed gantry, or on a travelling gantry, or on an elevated runway. It may also be underhung to the trolley of an overhead travelling crane. Also called hammerhead crane, or hammerhead jib crane from the resemblance in appearance of the rotating element to the head of a tack hammer.

Crane, Hydraulic. A crane which is operated by hydraulic power. While smooth in action and almost unlimited in capacity, the system is so inferior to electricity in most other respects that hydraulic cranes are practically obsolete.

Crane, Inclined Cantilever Jib. A straight line type of travelling crane, developed particularly for transferring freight between the hold of a vessel and the inside of a wharf shed. The travelling structure, which is of the full or semi-portal type of gantry, or of the bridge type, travelling on the roof of the shed, carries on the end toward the water a double cantilever jib, with ends unequal in length. In its working position the jib is inclined with the short lower end projecting underneath the edge of the shed roof, and the long end extending upward and out over the hatchway of the vessel. A load is hoisted from the hold with the trolley at the outer end of the jib; when clear of the hatchway the trolley is allowed to move inward and downward along the jib.

To allow the crane to be moved along the runway to different hatches, or to allow the vessel to be moved along the wharf, the jib may be raised to a vertical position against the end of the gantry or bridge, when it will clear all parts of the vessel and wharf.

Crane, Inclined Jib. A jib crane in which the jib is inclined to the horizontal at a fixed angle. More power is naturally required to move the trolley up the slope, but other considerations often make the arrangement desirable. (See Crane, Inclined Cantilever Jib.)

Crane, Independent. A rotary jib crane supported clear of a wall so that it may make a complete swing, as distinguished from a wall crane which may swing through a half-circle only.

Crane, Inverted Post. An underhung crane consisting of a trolley travelling on an overhead bridge and having centrally fixed to it a downwardly projecting post on which a jib can swing in a horizontal plane beneath the bridge. The jib may or may not have a trolley; movement of the trolley and slewing of the jib may be by power or by hand. The hoisting is usually performed by an electric motor, carried on the jib.

(See also Crane, Underhung; Crane, Horizontal Rotating Cantilever.)

Crane, Jib. A crane consisting of a bracket frame, or of a vertical post from which extends a horizontal arm (see Jib) carrying a traveller or trolley (see Trolley) on wheels, from which the load is suspended. The load is raised or lowered by a suitable hoisting mechanism (see Hoist) suspended from, built into or acting through the trolley, and free movement along the jib is then allowed by the trolley wheels. The vertical post is usually pivoted at the top and bottom to allow swinging (see Crane, Rotary Jib), but when a bracket frame is used, it is often non-swinging and mounted on wheels to allow of motion along a track or runway. (See Crane, Travelling Jib).

Page 171, 780, 789.

Crane, Ladle. Any crane arranged especially for handling and pouring ladles of molten metal. The term is usually applied to overhead electric travelling cranes of large capacity, provided with a double set of hoisting ropes supporting a strong beam, from the ends of which long steel hooks support the ladle by trunnions at the sides. The double set of ropes prevents any turning tendency, and the use of the beam keeps the load blocks and hoisting rope away from the intense heat of the molten metal. Special precautions are taken to protect the whole equipment, mechanical and electrical, from the heat, dust and chemical fumes.

As an extra precaution in case of the failure of a hoisting motor, two motors are often used, each capable of handling the load in case of failure of the other. If these motors drive separate drums, each lifting one end of the beam, interlocking gearing prevents unequal lowering of the beam.

Another arrangement is to have two hoisting drums and two ropes, each end of a rope being wound on a drum and each drum therefore lifting half the load at each end of the lifting beam. In case of accident to and stoppage of one of the hoisting motors, the other motor and drum will continue to handle the load at half speed.

For large ladles which must be tipped by power, a second smaller crane trolley is often provided, running on the same rails as the main trolley, or on separate and non-interfering rails, and connected with the tipping arrangements by its hoisting rope.

Page 165.

Crane, Locomotive. A rotary travelling crane consisting of a pillar crane with inclinable boom mounted on a turntable carried on a wheeled car travelling on tracks of standard or special gage. It is extremely mobile, has been built to handle loads up to 500 tons—though the cranes in most common use handle about 15 tons—has a long reach, and may be adapted to a variety of uses.

The travelling car in the small cranes is a four-wheel rigid truck, one axle being driven by power. The medium sizes have an eight-wheel swiveling truck car body, one axle in each truck usually being driven by power. On the car body is mounted a large gear which is also a track for the roller bearings supporting the deck or racer, this deck being held down to the car body by a large pivot pin.

On the deck or racer is mounted the pillar, often included as a part of the frame of the hoisting machine. The heel of the boom is pivoted at the base of the pillar, and is supported at the outer end by wire rope tackle led to a drum. The load line is led from the boom point to another drum. A third drum is supplied if a two-line bucket is to be handled, and winch heads are also provided on the ends of one or more of the hoisting drum shafts. A reversible pinion driven by gearing projects down through

the deck and meshes with the large base gear, providing power for rotating or slewing. The hoisting engine, boiler, coal and water, or the electrical machinery, if the crane be electrically operated is located back of the pillar opposite the boom; all this equipment serves to counter-balance the weight of the boom and load.

Various arrangements of jaw and friction clutches are used to connect the drums and gearing to the engine or motor, depending on whether the engine is reversible or not, whether two or more motions must be carried on simultaneously, and how often a motion must be repeated in service. Friction clutches are essential to rapid action and frequent repetition.

The motions possible with a locomotive crane are: hoisting; rotary, by swinging or slewing the boom; radial, by changing the inclination of, or luffing, the boom; and travelling, by moving the crane along the rails. The operator's station is usually just back of the pillar, from which point he has a clear view of the load during lifting.

When it is permissible temporarily to fix the crane in position, its lifting capacity may be increased somewhat by anchoring the car body to the tracks. For a larger increase, outriggers or beams underneath the car body are used; these can be slid out and blocked up from the ground.

If the crane is mounted on springs for satisfactory train travel at high speed, wedges must be placed to prevent the springs functioning during lifting operations.

The unit as a whole may be mounted on an elevated track or on a travelling gantry, or the car body may be elongated vertically into a tower with or without a gantry base, sometimes termed a raised pier locomotive crane. Omitting the car body and wheels, it may be mounted in a fixed position on semi or full portal gantries, or on towers of various heights.

Page 179, 804-806.

Crane, Luffing. A crane in which the load may be moved radially, or to or from the center of the crane structure, by changing the inclination of the boom from the end of which the load is suspended, as in a locomotive crane or derrick. This motion may incidentally be accompanied by a raising or lowering of the load, but the term luffing has reference to the horizontal motion only.

In a derrick the load may be luffed inward by raising the boom, and if at the same time the load line be slacked off enough to keep the load from being lifted along with the boom point, true horizontal luffing action will result; this is generally accomplished by the skill of the operator. When this operation must be repeated continuously, as in loading cargoes, an arrangement of load and boom hoisting ropes and guide sheaves may be made which will automatically maintain the load at a constant level during the luffing of the boom. If, in addition, the boom be counter-balanced, the power required for luffing is a minimum, and is only that necessary to overcome friction.

Shear legs constitute a crane of the luffing type.

Crane, Monorail Jib. A wall travelling jib crane with a fixed radius swinging arm. (See also Crane, Walking Jib.)

Crane, Overhead Electric Traveling. An overhead traveling crane, generally of the bridge type, operated by electricity. This method of driving is becoming so universal that the time is rapidly approaching when all such cranes will be either electrical or hand-operated.

Direct current is the most commonly used and is simplest. Alternating current may be used, but on account of the difficulty of varying the speed of an A. C. motor over a wide range, it is unsatisfactory in crane service

where delicate control is necessary. The voltage is usually 220; higher voltages would be more efficient so far as transmission losses are concerned, but owing to the presence of long lines of bare conductors in buildings containing many people, voltages which would be fatal to human life are unsuitable. (See also Crane, Overhead Traveling.)

Page 161, 781-800.

Crane, Overhead Traveling. A crane consisting of a steel bridge or girder structure supported at the ends on wheels traveling on elevated runways, and having a trolley traversing the bridge, a hoist built into or hung on the trolley, and motors, gears, shafts, etc., for operating the machine, and apparatus for controlling it.

The steel bridge or girder structure is carried by wheels at the ends traveling on straight level rails or runways laid on elevated structures. It is maintained at right angles to the two runways and travels along them by hand, or by power applied to the wheels at the bridge ends. Structurally it may vary from a simple I-beam to a complicated structure of four or more box or braced girders of great strength. (See Crane Girder.) The end trucks or carriages may be built in a number of different ways, and the wheels in each truck may number from two to sixteen, depending on the crane capacity. (See Crane End Truck.)

The trolley may be hand-operated, or may have as many as six motors (see Crane, Single Motor, etc.). Wire rope, crane chain or pitch chain (see Rope, Chain) may be used for lifting the load, in combination with worm or spur gearing (see Gearing). The load is ordinarily hung on a hook (see Hook) by slings of rope or chain (see Slings). The hoisting mechanism may be built separately and hung onto a hook or other fastening on the trolley (see Hoist, Independent), or may be built into the mechanism of the trolley (see Hoist, Trolley), the most usual arrangement for medium and large sized cranes being to have a motor-driven, geared-drum hoist built into the trolley.

There is usually one trolley, with one load hoist or with a main and an auxiliary hoist, the latter being much smaller in capacity and operating at a correspondingly higher speed. Occasionally there are two hoists of equal capacity on the same trolley, or two separate trolleys of equal capacity on the same bridge, one or both of these trolleys having an auxiliary hoist. Or a main and an auxiliary trolley may be operated on the same bridge, on the same or on different and non-interfering runways. (See Crane Girder.)

Holding and lowering brakes must be supplied for controlling the vertical movement of the load, including at least two provisions against accidental dropping. Brakes are also provided to control the travel of the trolley on the bridge and of the bridge on the runway. (See Brakes, Crane.)

(See Crane, Hydraulic, Rope, Steam, Electric, for various motive powers that have been used for operating overhead travelling cranes.)

(See Crane, Roundhouse, for an example of circular runways.)

(See Crane, Skew, for an example where the bridge is not at right angles to the runways.)

Page 155, 781-800.

Crane, Pier or Raised Pier. A locomotive crane having a structural steel pier or tower between the car body at the bottom, and the turntable at the top, and serving to elevate the rotating pillar element and give it a greater length of hoist.

Crane, Pillar. A rotary crane, generally fixed, consisting of a pillar or post held in a vertical position by attachment at its base to a turntable or equivalent mechanism which is securely fastened to the foundation, and a boom of fixed radius and inclination which meets the pillar near the bottom and is supported at its outer and upper end by a tie rod from the top of the pillar. No trolley is ordinarily provided, and the load may be moved horizontally around the circumference of a circle of fixed radius only. (Also called Transfer Crane, or Railroad Crane, from its wide use for transfer purposes in freight yards.)

When mounted, with its power operating mechanism, on a substantial turntable and provided with a boom of variable inclination, this apparatus forms a crane unit of very wide use, and is applied in many ways. The pillar is generally unrecognizable as such, being included as part of the frame of the hoisting machinery. This unit mounted on a self-propelled car becomes a locomotive crane, and it also forms an essential part of many gantry and tower cranes.

Page 175, 780-789.

Crane, Pillar Jib. A pillar crane with the usual self-sustaining post or pillar, but with the boom of fixed inclination replaced by a (generally) horizontal jib with a trolley running on it. The operating mechanism may be placed on a platform turning with the post, and opposite to the jib for counterbalance purposes. This crane is used in locations where guys or stiff legs for staying the top would be objectionable, but where the whole of a circular area must be served. (Also called Column Jib Crane.)

Page 175, 780-789.

Crane, Pintle. A horizontal rotating cantilever crane on a tower, in which additional stability is given to the rotating element by rigidly connecting to it a braced pintle extending down within the tower a considerable distance, and mounted in a roller bearing at its lower end. The roller bearing at the top of the tower is of the radial type and merely guides the rotating element. (Also called Hammerhead Crane.)

Page 197.

Crane, Portable. A crane which may be easily moved from one location to another on skids, rollers or wheels and used, after such changes of location, for crane purposes. This occasional motion of the whole structure is not, however, for the purpose of moving the load.

The term is often applied specifically to a small pillar crane with built-in hoist, mounted on three wheels, and capable of being hauled around a floor by hand with its load. The base is usually made so that it straddles the load to be picked up, and the pillar is curved so that the load can be delivered on top of a machine, provided there is room for the base beneath the machine.

Page 177.

Crane, Post. (See Crane, Pillar.) Also a small semi-portable jib crane arranged so that it may be bolted or clamped at the top and bottom of its mast to a post, column or other part of a building structure.

Crane, Power. A crane operated by mechanical power as distinguished from one operated by hand.

Also, a crane which is driven by a belt or rope from an outside shaft or separate engine.

Crane, Revolving. See Crane, Rotary.

Crane, Rotating Cantilever. A crane consisting of a central tower of four vertical members, supporting at the center a long truss on which a trolley can move from one

end to the other. The central pier rotates on a circular track set on a suitable foundation; the area served is circular.

Page 197.

Crane, Rotary. A crane in which the load is carried by a part or an assemblage of parts which are arranged to rotate about a vertical axis. Derricks, pillar cranes and jib cranes are examples of fixed rotary cranes; locomotive cranes, truck cranes and wrecking cranes are examples of travelling rotary cranes.

Also, a swing crane.

Page 197.

Crane, Rotary Jib. A jib crane which has a central post provided with pivots at the top and bottom so that the whole structure can swing about a vertical axis. If the load is carried at a fixed point at the end of the jib, it is called a swing crane; if the load is carried on a trolley, it is usually known simply as a jib crane, or, sometimes, from its former wide use in foundries, as a foundry crane. Also called a mast jib crane.

Page 171.

Crane, Roundhouse. An overhead traveling crane, intended for use in locomotive roundhouses, and traveling on runways which are arranged on the arc of a large circle. In order to make the bridge keep a radial position as it moves along the curved track, the outer end must travel faster than the inner, and this may be accomplished by having larger wheels at the outside, or by altering the gearing ratio; the latter is preferable on account of the advantage of using the same wheels throughout. The individual wheel axes should be radial.

Occasionally a crane (or other wheeled structure with rigidly connected wheels) must travel equally well around a circular arc or in a straight line. This can be done by having the treads of the wheels all of the same size for running on the straight track, but arranging the outer track on the curves in such a way that the wheels roll on the tops of the flanges, thus increasing their diameters, and causing them to travel faster.

Crane, Shipyard. The term applied to various types of cranes especially arranged and located for shipyard work, such as the delivering of the structural steel parts from the ground to the point in the hull where they are to be placed. They are characterized by a moderate load lifting capacity, a large clearance under the boom or jib, a sufficiently long reach to cover the necessary width of the building slip, and fairly rapid movement.

Some of the types which are in modern use are as follows: Double cantilever gantry cranes running on an elevated runway between the building slips, one crane serving two slips; travelling gantry towers with derricks, pillar cranes or horizontal rotating cantilever jibs, runways being arranged between all the slips, or between pairs; fixed towers with the derricks, pillar cranes or horizontal rotating cantilever jibs, so arranged that their combined fields of action cover all of the building slips; overhead travelling cranes, used only when the building slip is under cover.

Page 197.

Crane, Skew. A bridge type crane in which the traveling bridge, instead of being at right angles to the runway, is set permanently at a less angle. The squaring shaft runs at right angles to the runway, connecting diagonally opposite wheels on the end trucks. The bridge is of the monorail I-beam type, with open ends. A series of cranes of this type, arranged to travel on parallel runways transversely placed over a long floor area, can have trolleys run onto them from a single line

of monorail runway by a single two-way switch for each crane, the runway being located along one side of the floor area, at right angles to the lines of bridge runway.

Crane, Soaking Pit. An overhead traveling crane used in steel works, having a trolley to which is attached, either above or below, with vertically moving parts, a rigid structure carrying tongs suitable for gripping a hot steel ingot and removing it from furnace pits in the floor to a car, or the reverse. It usually spans a standard or narrow gage railway as well as the soaking pits. Sometimes called a vertical charging machine.

Page 165.

Crane, Stripping. An overhead traveling crane specially arranged for lifting the ingot molds off the ingots in steel works. A rigid structure hangs from the trolley, with two eyes which are caught under hooks on the top of the ingot mold, and which pull it upward. At the same time a vertically moving plunger pushes down on the top of the solidified metal, keeping it from rising with the mold.

Page 165.

Crane, Tower Jib. A jib crane, generally with a self-supporting steel mast or pillar, mounted on a tower. The mast is stepped at its base in a bearing well down in the tower, and is guided by a radial roller bearing at the top of the tower. The jib is attached to the mast just above the top of the tower, is top braced to the top of the mast, and carries a trolley. If the tower is of the travelling gantry type, the crane is called a traveling tower jib crane. (See also Crane, Horizontal Rotating Cantilever.)

Page 801, 802.

Crane, Tractor. A small travelling crane, generally of the rotary pillar type, mounted on wheels and capable of self-propulsion over sufficiently firm ground.

Page 806.

Crane, Tram. A short bridge crane traveling longitudinally on overhead rails, without trolley motion.

Crane, Transfer. A crane permanently installed in freight yards, etc., and used to transfer heavy weights between cars and trucks, etc. The term is usually applied to a fixed gantry, though travelling gantries, overhead travelling cranes and pillar cranes applied to this purpose are often thus designated. Also called Railroad Crane. (See Gantry, Fixed.)

Also, an overhead crane used to transfer a trolley with its load from one line of runway to another without the use of switches. It generally consists of a traveling bridge which is so arranged that when it is properly located in line with one of the fixed runways, a trolley may be run onto it from the runway, and transferred to another runway by moving the bridge. The girder is generally underhung, so as to leave its ends open. Locks or stops must also be provided to keep the ends of the runways and of the bridge closed at all times except when they are properly in line for the passage of the trolley.

Page 169, 791-800.

Crane, Traveling Jib. A jib crane mounted on wheels or trucks and arranged for self-propulsion. If the rails are on the side wall of a building, it is generally termed a wall traveling jib crane, and the jib is usually fixed, or without swing. If it runs on rails in the floor and is guided at the top by an overhead track it is called a walking jib crane, a velocipede crane or simply a traveling jib crane.

Page 177.

Crane, Truck. A small revolving pillar crane of fixed radius mounted on a truck or small car for operation on industrial tracks or with flat tread wheels for use on smooth floors or the ground. The term is generally applied to the small hand-operated types lacking the self-propelling feature; the large power-operated truck cranes are really locomotive cranes, as they are provided with travelling gear.

Page 177.

Crane, Underhung. An overhead travelling crane in which the bridge is hung to the end trucks below the level of the runway instead of above it, as is more usual. The runways usually consist of I-beams bolted to the beams of the floor above or to the roof trusses, and are often set in considerably from the end of the bridge, leaving a cantilever overhang at each end. Underhung cranes, suitable for light work only, are often used as transfer cranes, because the ends of the bridge girder are open, allowing a trolley to run off and onto a monorail track when the crane is properly located. Also any crane in which a rotating jib or cantilever arm is hung beneath a trolley on a bridge or runway. (See Crane, Horizontal Rotating Cantilever.)

Crane, Walking Jib. A travelling jib crane which runs on a single line of rails on the floor, and is guided at the top by a parallel overhead track. The base, having two swiveling wheels, or four wheels arranged on swiveling trucks, carries the motive machinery, and is strongly bracketed to the mast in the plane of the tracks. The swinging jib is either top or under braced, and may or may not have a trolley. The top of the mast carries guide rollers which run along the sides of the guide rail. This guide rail must be heavily braced to prevent the crane from overturning when the loaded jib is swung to the side. For stability when the load is in line with the track, dependence is placed on the long wheel-base and the heavy bracing to the mast. (Also called Velocipede Crane, or Travelling Jib Crane.)

Page 177.

Crane, Wall Bracket Jib. The simplest form of rotary jib crane, consisting of a horizontal beam or jib, often of I-beam section, hinged to a fixed point on a wall at one end, and supported at the other by a diagonal tie attached to the wall by another hinge directly above that holding the jib. Usually no trolley is included so that the load is carried at the end of the jib only, and the crane is often called a swing crane. The hinge plate of the tie rod is kept as high as possible so as to cut down the stress in the tie. If a trolley is used, it is hung to the lower flange of the I-beam.

Page 171, 780, 789.

Crane, Wall Traveling, or Wall Traveling Jib. A traveling jib crane which runs on horizontal lines of rails attached to one side of a building and extends outward over a portion of the floor space like a cantilever. The usual type has a structure consisting of a pair of top or under braced bracket frames rigidly braced together transversely, and carried by three rails; one at the top arranged to resist pull outward from the wall, one at the bottom to resist horizontal inward thrust, and one at or near the bottom to carry the weight of the crane and load. A trolley runs on the horizontal part of the jib, with a built-in or independent hoist. The same variety of power equipment is supplied as with overhead electric traveling cranes—hand, electric or air hoist, and hand or electric trolley traverse and jib travel.

Occasionally the jib is hinged to the part of the structure on the rails and the trolley may or may not be omitted;

this gives somewhat greater ease of handling, especially when hand-operated, and also enables the crane to pass high obstacles on the shop floor, or a load hanging from an overhead crane trolley. (Also called Monorail Jib Crane.)

Page 167, 797.

Crane, Wall or Wall Jib. A rotary jib crane supported against a wall and swinging through a half circle only, as distinguished from an independent jib crane which is so supported as to swing through a full circle. (See Crane, Wall Travelling; Crane, Wall Bracket Jib.)

Page 170, 780, 789.

Crane, Wharf. Any crane, located on a wharf or pier, and particularly adapted to the transfer of cargo between the wharf or pier and the hold of the vessel alongside. Owing to the varying spacing of vessel hatchways, the crane must be capable of movement along the wharf, hence is mounted on a runway. Other requirements are: Sufficient horizontal reach to cover the hatchway, sufficient length of hoist to raise the load from the bottom of the hold to a point entirely clear of the vessel, and rapidity and economy of operation.

Types much used as wharf cranes are: Single or double portal gantries or travelling bridges on the wharf shed roof, carrying rotating pillar cranes; cantilever gantries with folding extensions over the hatchways; and gantries with inclined cantilever jibs.

Page 191, 786-800.

Crane, Wrecking. A crane used in railroad practice for clearing up wrecks. The type in almost universal use is a powerful travelling rotary pillar crane with a curved or angular boom of variable inclination, mounted on two trucks of four to sixteen wheels each; it is practically a very powerful locomotive crane, with special facilities for being hauled at high speed in a wrecking train. (See Crane, Locomotive.) It is generally steam-operated, even on electrified roads, as wrecks often destroy the neighboring electrical conductors. An especially heavy lifting tackle is arranged at a point about halfway out on the boom, and elaborate outriggers with jacks are provided to give the crane additional stability for side lifts at large radius.

Page 185.

Crosshead. The term applied to an engine or machine part which slides in or on straight guides and serves to compel another part to move in a path parallel to the guides. An engine crosshead also usually has a point of connection for one end of the connecting rod, and thus guides one end of the latter, as well as one end of the piston rod, in a straight line along the axis of the cylinder.

Dash Pot. A device consisting of a loosely fitting piston sliding in a cylinder filled with air, water or oil. Large resistance is offered to sudden movements of the piston, but practically none to slow movements. It is used on cranes to prevent too sudden application of a solenoid brake when it is applied by springs after the current is shut off.

Davit. The name by which are known several types of cranes used for handling small boats on board a ship, two being used for a boat. The most common, a rotary davit, is a pillar crane consisting of a single vertical post curved out at the top sufficiently to suspend the boat clear of the ship's side, and provided with block and tackle hoists for lifting. The boat is hoisted clear of the deck, and by passing one davit at a time, may be swung from its stowing position inside the davits, to its launching position outside them.

There is also a luffing type of davit, which is inboard of the boat at all times, and swings outboard by a screw acting on a worm sector, or other equivalent means.

Dead Center. A position in a mechanism in which the part acting as driver cannot operate the other parts without outside help, owing to a locking action. In particular, the position of a reciprocating engine when the crank pin is on the line of centers, so that the pressure on the piston cannot move it.

Dead-end. To make fast the end of a rope used in hoisting or hauling operations, as the closing rope on a grab bucket, or a rope on a winding drum.

Dead-man. A prop or post used to elevate a derrick guy near its anchorage in order to allow more head room beneath it. It is usually a wooden post, set firmly in the ground at an angle, with the guy passing over a notch in the top. A grooved plate may be used to prevent the guy from cutting into the end grain of the wood. Steel dead-men are also used.

Also, an anchorage for a guy, cableway, etc., consisting of a timber or piece of structural steel buried in the ground with the end of the guy line fastened around its middle.

Deceleration. Retardation; the opposite of acceleration.

Deck. One of the floors or platforms on a ship corresponding to the floors in a building.

Also, an elevated platform around a crane, loading machine, etc., or a platform around the base of a revolving crane, moving with it, and furnishing a foundation for part or all of the operating machinery.

Also, one screen of a set of shaking screens arranged one above the other. Also called a leaf. (See Screen, Shaking.)

Deck, Revolving. The revolving platform or turntable of a locomotive crane. Also called the racer.

Deflection, of rope lead onto a sheave or drum. (See Deviation.)

Degradation. The term applied to the breaking up of lump material like coal into smaller lumps or into dust, due to handling or other causes. The resistance of the material to degradation often determines the best method of handling to be used.

Demountable Body System. A system of motorized freight terminal transportation consisting of a fleet of trucks with standard demountable bodies, with electric cranes and overhead rails at loading and unloading points, by which full and empty truck bodies may be exchanged with only a short delay to the truck. The contents of the bodies are unloaded and loaded in proper due course, and the system is so handled by a dispatcher that the exchanges are promptly made. Also sometimes called the Cincinnati System, because it was first installed there on a considerable scale.

(See also Gattie System.)

Derrick. Commonly used abbreviation of derrick crane. A rotary crane consisting of a vertical mast and means of holding it in a fixed vertical position, a boom, operating ropes and hoisting winch operated by hand or power. The mast is stepped at the bottom into a fixed baseplate and carries at its top either a loose cap or spider from which guys radiate to anchorages in the ground or other fixed points, or a pivot pin having its bearing held in place by gooseneck irons on the ends of stiff-legs. The boom is hinged at or near the base of the mast to allow motion in a vertical plane, and has its outer end or point raised or lowered by ropes attached to the point, leading around a guide sheave at the top of the mast, and thence

around other guide sheaves at its base, to the hoisting winch. This line is called the topping lift or boom hoist. The load is carried by a rope called the load line leading around a sheave at the boom point, thence along the boom to guide sheaves at the mast, and to the hoisting winch. The load, boom and mast are slewed about the vertical axis by a wheel at the base of the mast (see Bull Wheel) having slewing lines leading from it to the slewing winch or by hand slewing lines attached to the boom point or to the load; complete rotation requires that the guys or stiff-legs be spread so far that they will clear the point of the boom at least a portion of its range of elevation.

Another type of derrick has a stationary mast with the boom attached to it by a goose-neck which allows full freedom of motion. Several such booms may be placed at the base of a single mast, if desired, and this arrangement is much used on shipboard for handling cargo. (See Derrick, Ship.)

The distinction between a derrick and a jib crane lies in the fact that a derrick boom can be changed in inclination, or luffed, and this is required to give one of the components of motion to the load, while in a jib crane the jib is rigidly fixed to the mast, and the load moves radially only by means of a trolley moving along the jib.

Several somewhat primitive forms of cranes are also called derricks, though they have no booms, and are capable of little or no horizontal movement of the load. They are really portable structures intended to give an elevated point of attachment for hoisting purposes. (See Derrick, Fole; Derrick, Breast; Derrick, Tripod; Derrick, Sulky; Derrick, Gin Pole.)

Page 219, 801-803.

Derrick, A-frame. An independent derrick in which the mast is replaced by two struts spread apart at the bottom and united at the top. A cross-bar furnishes the point of attachment of the boom, and another spar or stiff-leg (or sometimes two), extending to the rear, holds the top of the A-frame rigidly in position. The boom may be slewed somewhat less than 180 deg. by lines leading through guide sheaves on the side struts, or by a bull wheel.

Another type has a mast in addition carried in pivots just in front of the A-frame, so that it can swing the load through a full 180 deg.

Page 229, 801-803.

Derrick Bottom. The complete assemblage of metal parts at the base of a derrick mast, comprising the following parts or their equivalent; a foot block, secured to the bottom of the mast, having a pivot, either cylindrical or ball and socket, resting in the mast step in the base plate; a boom seat, either an integral part of the base plate, or secured separately to the mast above the base plate; straps and bolts for securing these irons in place; and one or more sheaves with their pins.

Derrick, Breast. A hoisting device consisting of a pole derrick having two poles spread apart at the bottom where they rest on a cross piece, and approaching or meeting each other at the top, where they are fastened together. Other crossbars connect the two poles, and a hand-winch is fastened to one of the lower ones, the load line passing around a sheave fastened to the top crossbar or top point. Guys hold the derrick in position, and by their adjustment provide a means for a small horizontal movement of the load. Generally portable, and used for small work.

Page 227.

Derrick Car. A truck or car on which is mounted a stiff-leg or A-frame derrick. The sills or lie legs may be bolted to a standard flat car and the stiff-legs attached to them in the usual way, or the frame of the car itself may be utilized for anchoring the stiff-legs. The mast and boom are sometimes arranged to lower to allow of hauling along a railroad right of way.

Derrick Car, Traveling. A derrick car provided with means of self-propulsion. It may be of the chain and sprocket type, or the bevel gear type, driven from the same engine that operates the hoisting winch.

Page 223.

Derrick, Counterweight. A small portable derrick consisting of a mast firmly fixed in a base and braced by short braces, having pivoted to it a boom which has a short extension on the side opposite the load. This extension may be counterweighted by the hoisting winch and by additional weight if desired. The inclination of the boom may be changed, but neither it nor the mast rotate.

Page 227.

Derrick, Floating. (See also Crane, Floating.) A derrick, usually of the stiff-leg or A-frame type, mounted on a barge or pontoon. It is generally of moderate proportions, and special provision must be made for stiffening the frame to resist the side stresses due to tipping when lifting a heavy load, and when acted on by waves. The slewing gear must also be powerful enough to swing the boom under any condition of side tipping.

The derrick may be of the mast type with two or four stiff-legs of the A-frame type with two stiff-legs, or of the A-frame type with a mast in addition, this last arrangement allowing a full 180 deg. swing. The hoisting machinery is located on the deck of the barge where convenient, and considerable clear space is left in front of the derrick, so that the barge may be loaded and be used for water transportation, as well as for purely lifting purposes.

Page 223, 801, 802.

Derrick, Full Circle. A derrick which has its mast so supported as to allow complete rotation. This is accomplished in a guyed derrick by having the guys spread far enough to clear the boom point. Stiff-legs of the "broken-back" type also allow complete rotation.

Page 801, 802.

Derrick, Full-Circle Stiff-Leg. A stiff-leg derrick arranged to swing a complete circle if desired. The two straight stiff-legs ordinarily used are replaced by "broken-back" stiff-legs, with a post or strut supporting the leg at the angle of the break. The boom can then pass under the stiff-legs and make a complete circle. Two posts or struts are sometimes used to support the stiff-leg, giving better support against side yielding.

As at least two ropes ordinarily pass up into the mast through the bottom step, and these would be fouled by a complete turn, it is customary to mount the hoist on a platform at the bottom of the mast and rotating with it, driven by a pinion meshing with a large gear fixed to the foundation, called a bull gear. The weight of the hoist may be utilized to partially counterbalance the weight of the boom and load. Also called full swing derrick.

Page 801, 802.

Derrick, Gin Pole. A pole derrick in which the single pole is stepped in a socket at the bottom to allow a small amount of inclination from the vertical in any direction by slacking the guys securing the pole top.

Page 227.

Derrick, Guyed. A derrick in which the mast is held in a vertical position by guy lines, generally of wire rope, attached to a fitting at its top, and to anchorages in the ground distant from the base of the mast. Three such anchorages are absolutely needed, though more are always provided. The relative proportions of height of mast, length of boom and length of guys have an important bearing on the possibility of swinging the boom past the guys at certain of its elevations.

Guyed derricks are always fixed, never movable or travelling.

Page 219, 801-803.

Derrick Hoisting Winch. A term sometimes applied to a two-drum winch to which has been added a boom slewing gear, fitting it especially for handling a derrick with a bull wheel. When driven by a steam engine, sometimes incorrectly called a derrick engine.

Derrick, Independent. A derrick which has its mast so supported that it is independent of outside stays or guys, a derrick having a self-sustaining mast.

Derrick, Jinniwinck. A special type of light A-frame derrick designed with a view to easy portability, for contractor's and similar work.

Page 223, 801-803.

Derrick Mast. The vertical strut, post or spar forming part of a derrick. It rests at its base or heel in the foot block forming part of the derrick bottom, and has at its top a gudgeon or pivot which is held in place by guys or stiff-legs, thereby holding the mast in a vertical position.

It is built of wood in small and medium sizes, and of steel in medium and large sizes, generally of four angles with lattice bracing.

Derrick, Pole. A boomless crane or hoisting device with a very limited horizontal motion of the load, and intended mainly for hoisting purposes. It consists of a pole resting on a cross-piece at its base, with its top held in place by guys, a sheave for the hoisting line at the top of the pole, and a hand-winch attached to the pole near the base. The horizontal motion is given by slacking on the guys. (See also Derrick, Gin Pole.)

Page 227.

Derrick, Self-Slewing. A derrick in which the boom is slewed or swung about a vertical axis by power, through the medium of slewing lines and bull wheel, as opposed to one in which hand-power is used for this purpose.

Also a full-circle derrick in which the driving unit is mounted on a platform at the base of the mast, and rotates with it, power being applied to a stationary bull gear by a vertical shaft pinion driven from the hoisting winch engine. (See Derrick, Full-Circle Stiff-Leg.)

Derrick, Ship. A derrick especially arranged for handling the cargo of a ship. It consists of two booms attached to a mast by goose-necks, with the usual operating ropes and hoisting machinery. In operation, one boom is guyed with its point over the cargo hatch, and the other with its point over the lighter or wharf at the ship's side. A hoisting rope from each boom is attached to the load, and by proper manipulation of the hoisting drums is hoisted from the hold, swung over the side, and lowered. (See Cargo Handling Gear.)

The term derrick is also applied on shipboard to a spar raised on end, with the head steadied by guys and the heel by lashings, and having block and tackle attached to its head for lifting heavy weights.

Page 231.

or A-frame type, mounted with a hoisting winch on a **Derrick, Skid.** A small portable derrick of the stiff-leg

platform resting on skids. Its capacity is very limited, except directly in front, unless temporary guys are arranged.

Page 227.

Derrick, Stiff-Leg. A derrick in which the mast is held in a vertical position by two slanting struts or spars, called stiff-legs, or back-legs, attached to the mast cap at one end, and to anchorages in the ground at the other, the structure resembling a tripod with one vertical leg (the mast) and two other equal slanting legs (the back-legs), having their bases 90 deg. apart. The boom swings about the vertical axis of the mast through an angle of somewhat less than 270 deg.

For a portable derrick, the fixed anchorages are replaced by two horizontal sills or lie-legs, attached to each other at the base of the mast and there carrying the mast step, and extending along the ground to the basis of the stiff-legs, and secured to them. The sills are then anchored by heavy weights placed on them.

A third stiff-leg, or compression member, is often placed vertically just behind the mast to relieve it of the compression load it would otherwise carry.

Four stiff-legs are often used, especially in floating derricks. (See Derricks, Floating.)

Page 219, 801-803.

Derrick, Sulky. A portable hoisting device consisting of four poles mounted on two wheels, and when erected for use, forming a rectangular pyramid secured by bolts and hinges at the apex, where means are also provided for securing block and tackle. Two of the poles are rigidly braced to each other by crossbars, the lower of which bear the hoisting drum and gearing which is operated by turning two large wheels at the ends of the shaft by hand. The other two legs are separately hinged at the top.

For transportation, the framed poles are tipped over until the wheels rest on the ground, and the two independent poles are folded down on the others.

Also called trench derrick, from its wide use over a trench for lowering pipe, etc.

Page 229.

Derrick, Tower. A stiff-leg or A-frame derrick mounted on an elevated structure in order to obtain high lift and large clearance under the boom. The structure is sometimes triangular in plan, with vertical corner posts under the mast and each of the two stiff-leg ends. Sometimes it is square, with two stiff-leg derricks mounted on diagonally opposite corners, or rectangular with two stiff-leg derricks at adjacent corners, the stiff-legs being arranged with different slopes to allow of their crossing. Occasionally three separate towers are built, one each under the mast and the two stiff-leg ends.

A stiff-leg derrick has also been mounted on an adjustable turntable on top of a tower in such a way that the mast could be brought over any one of the four corners of the tower as desired, and clamped there, the mast being swung by a bull wheel as usual. The rear ends of the sills are clamped down to the tops of the two adjacent corner posts.

Also, in building construction in locations where long guys cannot be used, a well braced wooden tower, with short iron guys to heavily loaded extended sills at the bottom, is used to support one or more derricks at the four corners. The tower is lengthened and derricks moved upward as the building progresses.

Page 221, 801, 802.

Derrick, Traveling Stiff-leg. A stiff-leg derrick which is mounted on a car or wheels. One type is carried on two widely spaced rails; one sill is parallel to and over one rail, and carried by non-swiveling track wheels at each end, and the other sill is at right angles, with its far end carried by a wheel or truck on the other rail. A horizontal diagonal tie keeps the sills at right angles and insures rigidity, and the remote ends of the sill are often weighted with boxes of earth or stone. The load is also sometimes counterbalanced by counterweighting the bull-wheel on the side opposite the boom.

(See also Derrick Car.)

Page 223, 802.

Derrick, Tripod. A hoisting device consisting of a pole supported in an inclined position by two props, having a crab on the pole near the base, and a sheave at its top. Generally portable, and used for small work.

Page 227.

Deviation. Of rope led onto a sheave or drum. The angle between the center of the rope and the central plane of the sheave or groove. A deviation which brings the rope barely into contact with the slanting side of the groove is not objectionable; more will wear the rope, or may cause it to jump the groove.

Also called deflection, and side draft.

De-water. To remove the water from by draining, as in handling material which has been washed or subjected to other wet treatment.

Diaphragm. A thin division wall, generally of metal, serving as a partition, as a structural stiffener, or for some other special purpose.

Diaphragm, or Diaphragm Plate. A transverse plate fitted inside of a box section steel girder, to stiffen the sides and prevent buckling. It is used in overhead traveling crane girders, both in the bridge girders and in the end frame. In the former it also serves to stiffen the top plate and enable it to carry the load on the rail.

Ditcher, Railroad. An excavating machine designed especially for efficient operation in cleaning out the ditches along the right-of-way. The requirements are to dig somewhat below the track level and close to the ends of the ties; to deliver the excavated material to cars on the same or adjoining tracks; and to have the power of self-propulsion (unless a locomotive can be spared to accompany the ditcher).

Page 239.

Dock. A space in which a ship rests while loading or unloading, undergoing repairs, etc. It may be simply the space between two piers projecting into the harbor, or it may be a partially or entirely closed basin with wharves along the sides.

Also used as an abbreviation of dry-dock.

(See also wharf.)

Dock Leg. See Elevator, Marine Leg.

Dog. A piece of metal used in conjunction with a larger body to act as a clamp. A part of a clamp.

Also, a steel rod with two ends pointed and bent up at right angles to hold together logs or timbers by driving one leg into each of them.

Also a single pointed steel piece with a ring or chain attached, for handling floating timbers.

Dolley. A small single-wheel truck used in transporting moderately heavy bodies for short distances. It consists of a heavy rectangular frame, generally of wood, on the underside of which are secured bearings carrying the shaft of a wide faced wheel or roller. The object to be

moved is placed with its center over the roller, or two dollies are used, one at each end of the object.

Downhaul Ball. In hoists, a heavy weight interposed between the hook and lifting block, or built into the lifting block to furnish sufficient pull to make the hoist or tackle overhaul when it is desired to lower without load.

Drag Line Excavator. An excavating machine consisting of a drag scraper or a scraper bucket operated by a crane, derrick, slack-rope cableway or other similar apparatus.

When used with a crane or derrick, the bucket is handled by two ropes; one of these, the hoisting rope, leads over a sheave at the boom point and thence to a winch drum. The pulling or drag rope from the bucket leads directly to another drum on the winch. The bucket is dragged along the ground toward the winch by the pulling rope, and fills, owing to its shape and method of attachment to the pulling bridle. (See Drag Line Scraper Bucket). When full it is raised from the ground by the hoisting rope, swung to the point desired, dumped, returned, lowered to the ground, and is ready for another trip.

The pull is generally toward the winch, and digging can be done to the maximum radius of the boom. This can be increased slightly by giving the bucket a swing before dropping it to the ground. Side cutting can also be done, the pulling rope leading from the bucket to the boom at right angles to the latter, and pulling the bucket by slewing the boom or winching in the drag rope.

Machines resembling locomotive cranes with very long booms and two drum winding engines have been developed especially for operating dragline buckets. They are mounted on wheels requiring track, on skids and rollers, or on track-laying tractors.

Drag line excavators may dig from the side of the cut, progressing sidewise along it, or from the end, retreating backward as the excavation is dug. The latter method allows deeper digging, but it is less easy to give a regular form to the excavation.

(See also Excavator, Slack-rope Cableway; Drag Line Scraper.)

Page 239, 801, 817.

Drag-line Excavator Winch. A two-drum winch used in connection with a derrick, crane, cableway or special handling rig, for handling the pulling and hoisting ropes of a drag scraper bucket. A third drum is added if a boom having a variable inclination is used. The drum carrying the drag-rope is usually geared to run more slowly and furnish a greater pull than the hoisting drum, which should be able to return the bucket quickly. These winches are usually of the friction drum band brake type, driven by gearing from a double cylinder steam engine. Owing to the large power and steady service required, hydraulically operated band friction clutches and water cooled brakes are sometimes used. Sometimes called an excavator engine.

Drag Line Scraper. A scoop-shaped implement used for moving bulk material by a scraping action. It is attached to a line led to a winch, and is dragged over the material to be moved, heaping it up in front and sliding it along partly in the scoop and partly on the surface of the material in front. It is returned by a line attached to its rear side, which also dumps it when pulled. Used for excavating, also in connection with storing and reclaiming coal in bulk in storage piles. Also called drag scraper scoop; drag scraper.

Page 817, 833.

Drag Line Scraper Bucket. A bucket used for handling bulk material; digging it by a dragging and scraping action, moving it and dumping it where desired. It is generally used in combination with a crane, derrick (see Drag Line Excavator) or cableway excavator (see Excavator, Slack-rope Cableway).

The bucket consists of an adequately braced steel shell or bowl of somewhat rectangular form, open at the front and sometimes at the top in addition. It has a cutting edge on the bottom, sometimes with teeth, and is pulled along the ground by a pulling rope attached to a fixed or hinged bail or by a chain pulling bridle attached to pulling lugs. Another rigid or hinged bail, or chain hoisting bridle, at the top, is connected to a hoisting rope.

Front dumping is generally accomplished by manipulation of the pulling and hoisting ropes, which are led to different drums on the winch. For rear dumping, a rear gate, hinged at the top, swings out when a latch is released by a trip rope or by running the traveller carrying the bucket (in cableways) against a stop which releases the latch. In another rear dumping construction, the hoisting bail is attached to the rear gate, which remains over the end of the bowl as long as tension is kept on both ropes. When the pulling rope is slackened, the bowl tilts down away from the rear gate, dumping its contents.

A back dumping bucket should have a slight flare toward the rear, and a front dumping bucket the reverse, to allow clean dumping.

Page 817, 833.

Drag Line Scraper Bucket, Front Dumping, Back Dumping. See Drag Line Scraper Bucket.

Drag Line Scraper Bucket, Side Cutting. A drag line scraper bucket which is arranged to be dragged at right angles to a derrick boom during the filling operation. By proper shortening of one of the pulling bridles, the bucket may be made to travel in a slightly diagonal direction, thus increasing the radius of digging. (See also Drag Line Excavator.) Sometimes called a shovel bucket.

Drag-rope. In drag bucket installations, the rope which pulls the bucket or scraper along over or through the material. (See Excavator; Drag Line Excavator, Slack-rope Cableway.) As this rope gets very rough treatment, it must be of the very best material and have ample margin of strength.

Drag Scraper. A horse-drawn, scoop-shaped pan made of one piece of stamped steel and used for light excavating. It has handles at the rear and a pulling bridle at the front for attaching a team of horses. The scraper is made to dig by lifting on the handles by hand; when the scraper is full they are dropped and the scraper rides on the smooth bottom to the dumping point. Here a large lift of the handles causes the cutting edge to dig in sharply and turn the scraper over.

Draw-bar. A bar by which a locomotive draws a car behind it, or a tractor its trailer; also a similar bar used between two cars or two trailers.

Drawbar Pull. The pull exerted by a self-propelled vehicle in drawing or trying to draw a load behind it. Ideally it is equal to the tractive effort, but practically is always less on account of certain resistances of the vehicle itself.

Drawing, Cold. The process of drawing metal bars of various shapes through dies while cold, in order to improve the finish, the quality of the surface metal, or

to size the bar very accurately. (Sometimes erroneously called Cold Rolling.)

Dredge. A machine for excavating material at the bottom of a body of water, raising it to the top and discharging it on the bank, or into a scow for removal to a distant point. Dredges may be classified as floating dredges which are mounted on a scow or other floating craft, or land dredges which travel on land but are used for excavating beneath the level on which they stand, and generally beneath water. Floating dredges may be classed as grapple dredges, in which the digging element is a grab bucket operated by ropes; dipper dredges in which the digging element is a bottom dumping bucket mounted on the end of a long handle or boom; ladder dredges in which the digging element is an endless chain bucket elevator extending down into the water on a frame or ladder; and suction dredges in which the excavated material mixed with water is drawn into a centrifugal pump through an intake pipe reaching down to the bottom and discharged onto the bank or into a scow.

Land dredges are classified as track, skid, or roller, track-laying or walking, according to the method of moving them, and as grapple, dipper, or drag line scraper bucket according to the method of digging the underwater material.

Land dredges are also often called excavators, even where they remove material from beneath water.

Page 241, 801.

Dredge, Dipper. A floating dredge in which the digging element consists of a dipper mounted on a handle, and operated from a boom which may be swung about a vertical axis, the whole being mounted on the front end of a scow. Except that it has a longer boom and dipper handle, and a higher A-frame, it is substantially the same as a steam shovel, and its method of operation is there described. (See Shovel, Steam.) The scow is usually not self-propelled, and deposits the soil on banks beside the body of water being dredged, or into bottom dumping hopper scows for dumping elsewhere.

The scow is moved slowly forward during dredging by the aid of lines fastened to anchors on the shore or on the bottom. It is held in place against the thrust exerted by the dipper while filling, by four spuds. (See Spuds.) By having two or more slanting spuds in addition, the dredge may be moved slowly forward without the use of any lines whatever.

Page 241, 801.

Dredge, Elevator. A dredge which removes material from the bottom of a body of water and delivers it to a discharge hopper or other desired point by a series of scraper buckets attached to a chain, and passing around a vertical frame or ladder with tumblers at each end, and driven by the upper tumbler. The material is scooped up while the buckets are passing around the bottom tumbler and is dumped as they pass over the top one. It is capable of digging to considerable depths and in fairly hard material, and is used to some extent for deepening channels, and rather generally for gold dredging. It is also widely used for procuring sand and gravel from submerged banks, to be used for building purposes. The buckets dump into a screening mechanism, and the sand, gravel and boulders are separated, the last being dumped overboard to the rear if not desired.

Also called placer dredge, ladder dredge, and chain and bucket dredge.

Page 245.

Dredge Engine. The engine—steam or internal combustion—which drives the machinery of a dredge. Steam engines are in more general use, and are usually of the double reversing type, connected by gearing to one or more shafts on which the operating drums are placed.

The term is also often applied to the engine and all operating machinery driven by it, including drums, shafts, clutches, brakes and operating gear.

Dredge, Grapple. A dredge in which the digging element is a grab bucket of the clam shell or orange peel type. (See Bucket, Grab.) The operating machinery is described under Excavator, Grab Bucket. The grapple is used extensively on both land and floating dredges.

Dredge, Gravity Swing. A grapple dredge in which the relative location of the swing circle and topping lift is such that the boom tends to swing to one side. It is allowed to swing thus after the bucket has been filled and hoisted; after dumping it is pulled back by a rope wound on a drum on the winch, or by a counterweight on a holding drum, the weight of which is sufficient to overcome the side pull of the empty bucket, but not that of the full bucket.

Dredge, Hydraulic. A machine for excavating material from river channels, harbors, etc., widening and deepening them, by drawing it into a centrifugal pump through a suction pipe having its end thrust into the material. Soft material will be removed without agitation, or with only that produced by water jets, but tougher substances must be acted upon by an agitator which usually takes the form of a rotating head with cutting blades surrounding the orifice in the suction pipe end. The suction pipe is pivoted on a horizontal axis at the bow of the scow.

The discharge of the pump is led ashore by a flexible line of piping which may extend as far as a couple of miles, or is led into bottom dumping scows, to be carried to a suitable dumping point.

In large bodies of water the dredge is swung from side to side and advanced slowly at each sweep, by the manipulation of spuds and guiding ropes. In narrow canals the suction pipe itself is swung from side to side while the dredge is moved slowly forward.

A hydraulic dredge is also often used for supplying sand and gravel from submerged banks for building purposes, and is usually called a sand sucker. The pump delivers the material to screening machinery, and the sand, gravel and boulders are separated, the last being deposited to the rear if not desired.

Page 245.

Dredge, Land. An excavating machine which is moved along on dry land, but does its excavating under the water which it spans, or along the side of which it runs. (See Dredge.) When it does dry excavating it is usually called an excavator.

Dredge, Rehandling. A floating dredge which takes the discharge from sea-going hopper dredges and pumps it ashore. This system is used where it is impossible or uneconomical for the hopper dredge to go to sea to dump, and where it is not possible to pump the material ashore at once from the dredge on account of rough water or for other reasons.

Dredge, Scraper. See Drag Line Scraper Bucket.

Dredge, Sea-going Hopper. A self-propelled hydraulic dredge which delivers the excavated material to bottom dumping hoppers within its own hull, and carries it to the dumping ground in deep water or elsewhere by its own propelling machinery. These dredges usually have

the suction pipe alongside the ship, pivoted at a point approximately amidships, and trailing to the rear.

Dredge, Suction. See Dredge, Hydraulic.

Dredge Swing Circle. See Swing Circle.

Dredge, Track Type Land. A land dredge which is supported by flanged wheels running on rails. The sections of rails may be moved forward after the dredge has passed over them, by the machine itself, or by outside means. The dredge may be hauled forward by ropes attached to deadmen set in advance of the machine, or to the ends of the rail sections on which it is supported.

Dredge, Walking Land. A land dredge or excavator which is built on a deck or platform spanning the ditch to be excavated, and which is supported on six skids in such a way that it may be propelled forward by their proper manipulation. There is one skid at each corner of the dredge platform which may be moved up or down. Other larger movable skids, called walking skids, on each side between the front and rear corner skids, are also capable of being raised or forced down, and of being moved along from front to back or the reverse. In operation, the walking skids are moved forward and forced downward until they take a considerable portion of the weight of the platform which is then pulled forward by rope tackle attached to the walking skids and handled by the winch. The walking skids are now relieved of the weight, which is transferred to the corner skids, and the dredge is moved forward, after which the cycle is repeated as many times as may be necessary.

This method of propulsion enables the machine to pass over land which is too soft for most other types of excavating machinery, and in addition saves the cost of tracks.

Drier, Sand. An arrangement used for drying sand, generally for purposes where it is required to flow freely, as in the sandboxes of locomotives. One type consists of a hopper made of a continuous coil of steam pipe, with small spaces between adjacent coils; the wet sand will not pass through the spaces, but as soon as it becomes dried, it runs out and falls to a collecting hopper, and its place is taken by fresh wet sand.

Drift. The term applied to the continued movements of crane or other machinery, due to inertia, after shutting off the power. Friction tends to bring the parts to rest, and drifting does no harm if fully under the control of the operator by brakes which can be applied if needed. Rapid action, however, generally requires the use of brakes and the elimination of the period of drifting.

Drum. The cylinder or barrel on which is wound the chain or rope used for raising a load or performing other operations with hoisting and haulage machinery. For very light work it may be made of wood, but cast iron is used almost universally, cast steel occasionally.

Two arrangements are in common use, called the tight drum, and the loose or clutch drum. The tight drum is keyed to its shaft, which turns in fixed bearings in the frames. The gear through which motion is transmitted to the drum is best shrunk and keyed to a seat in one end of the drum surface, though it may be bolted against an end, or simply keyed to the drum shaft. In the clutch drum construction, the drum turns on the shaft, being bronze bushed at its ends, and one of the clutch elements is formed in the end face of the drum or is attached to it, the other corresponding element being on the side of the drum gear. A seat in the circumference of the drum provides for a band brake to control during lowering. If a jaw clutch is used, the drum is called a clutch drum;

if a friction clutch, it is called a clutch drum, a friction clutch drum, or generally simply a friction drum.

The surface of the drum is always smooth for hemp or manila rope, and may be smooth for wire rope or chain though generally scored. (See Score, Drum.) The drum diameter is from 20 to 30 times the diameter of the wire rope used.

A single load is generally lifted on one drum, though two drums are sometimes used. (See Crane, Ladle.) For overhead cranes having a very high lift, or where, owing to the method of reeving the rope, a large amount must be wound on the drum, making it very long, the drum is often arranged parallel to the bridge, in which position the length is unlimited. This position is also sometimes required in order to have a clamshell bucket open in the desired relation to the bridge. With the drum parallel to the bridge, the bucket usually opens at right angles to the bridge, and vice versa.

Also called barrel.

Drum, Backing. On a power shovel, a special drum on the winch used for pulling the dipper back of the vertical for starting a cut close to the ear. It is used on machines intended for railroad ditching work; dipper dredges are also thus provided.

Drum, Cable. A special light drum on a crane used to keep up the slack in leads to a lifting magnet or a motor operated bucket. It usually consists of a small drum made of non-conducting material geared to the main hoisting drum in the proper ratio, and supplied with sliding contacts or slip rings to lead the current to the cable wound on it. The cable is generally extra-flexible, and should be wound in a single layer only. Occasionally the drum is wound up by a large spring, or a smaller spring is used in connection with the geared drive, to provide some elasticity in case the cable catches or runs over onto the part already wound. Also called an automatic take-up drum and retriever drum.

Drum, Chain. A drum on which the load chain is wound, for hoisting purposes. (See Score, Drum.) The drum diameter should be 25 to 30 times the diameter of the stock from which the chain is made.

Drum, Counterweight. See Drum, Holding.

Drum, Differential. A hoisting device in which two drums of different diameters keyed to the same shaft have fastened to them and wound on them in opposite directions, the two ends of a rope. The load block hangs in the loop of the rope. The load will travel up or down as the rope is wound onto or off the large drum. The same principle is utilized in the differential chain block.

Drum, Drag. A winding drum operating the drag-rope of a drag line scraper bucket.

Drum, Friction. A winding drum which is driven from its shaft by a friction clutch. The clutch is generally of the cone type, with wedge shaped blocks of wood or bronze fastened in a circle to one of the parts (usually the drum gear keyed to the shaft) and is capable of being forced axially into a corresponding groove in the other part (usually the drum), the resulting friction being sufficient to make them revolve together. When "out," the drum is free to turn unless retarded by a band brake. A ratchet and wheel are also supplied to hold the load independently of the brake; the ratchet must be thrown out of action when lowering by the brake.

The clutch is operated by pressure on a friction hand lever which turns a friction thrust-screw passing through a nut in a thrust screw yoke. The inner end of this screw bears against the outer end of a friction thrust pin fitting in an axial hole in the shaft, and the inner

end of this pin exerts a pressure against a cross-key whose outer ends rest in grooves in a loose thrust collar at the outer end of the drum hub bearing, thereby forcing it along the shaft, and bringing the conical clutch surfaces at the other end of the drum into engagement.

Another type of clutch has a band carried by the gear which may be tightened around a seat on the drum when desired by levers operated by a cam turning on the shaft. Or the band may be tightened by water or steam pressure transmitted through the hollow shaft to a cylinder mounted on a web or arms of the gear, with its piston rod connected to the ends of the band by levers keyed to crank pins passing through the gear rim. The movement of the piston is controlled by a small slide valve bolted to the machinery frame and connected to the operator's hand lever. This device is much used for winches performing heavy service, as in dredges, shovels, and drag buckets.

Where operation is continuous and lowering is rapid, special provision is made for air cooling, and sometimes water cooling is adopted. This is true in the operation of twin drum winches for coal unloading towers using grab buckets, where the empty bucket is lowered on the clutch, there being no brake except a relatively small one to keep the engine crank shaft (or motor shafting) from turning.

Band clutches produce no end thrust

Drum, Friction Geared. A winding drum which is rotated by friction gearing. (See Gearing, Friction; Winch, Friction Geared.)

Drum Gear. The large gear through which a winding drum on a hoisting or hauling machine is driven. The gear may be keyed to the same shaft as the drum, bolted to the end of it, or forced onto a seat on its circumference, remaining always fixed to it and driven by a pinion. In another construction it is keyed to the drum shaft and capable of connection with the loose drum by engaging a clutch which has one portion each on the drum and the gear. (See Drum; Drum, Friction.)

Drum, Gravity Plane. A brake controlled drum used for simultaneously lowering a loaded car and raising an empty one on a gravity plane. Two separate ropes are used, one coiled in each compartment of the two-compartment drum, with one end attached to the drum and the other to one of the cars, the winding being done in opposite directions. A band brake controls the motion of the drum overhauling under the weight of the load in the loaded car. (See Sheave, Gravity Plane.)

Drum Hoist. Any hoist which exerts the pull on the hoisting rope by winding it on a drum, as distinguished from chain hoists, screw hoists, air cylinder hoists, etc. (See Drum; Winch; Trolley.)

Drum, Holding. An auxiliary drum often used to enable a two-rope grab bucket to be operated by a single-drum winch. It consists of a two-compartment drum mounted on a special independent base, and running free except when held by a band brake. The holding rope from the bucket is wound in one compartment, and one end of a light counterweight rope is wound oppositely in the other compartment. The counterweight is located at any convenient place, such as the derrick mast or the side of the locomotive crane. While the winch is hoisting the bucket by the closing rope, the counterweight lowers, furnishing just enough pull to keep the holding rope tight. When hoisting is stopped and the brake is applied to the holding drum, lowering of the closing rope will allow the bucket to open and dump, leaving it suspended on the holding rope. The bucket is then lowered,

open, by releasing the holding drum brake. Also called counterweight drum, trip drum.

Drum Lagging. Wooden strips which may be bolted between the end flanges of a winding drum to increase its diameter and increase the speed of hoisting, with, of course, a corresponding decrease in the pull which may be exerted. They may lie on the original surface of the drum, or may be considerably above it, and be held in position by bolts through the flanges.

Drum, Lowering. A rope drum with a friction brake on one end controlling motion in either direction. Two ropes are wound in opposite directions on the drum; while a load is being lowered on one of them, the other is being wound up in readiness for the next descent. Used for lowering of sacks and similar packages, and sometimes called a sack lowering winch.

Drum, Mine Hoist. The drum on a winding machine used for hoisting purposes in a mine shaft. These drums are driven by steam engines or electric motors and are characterized by their large diameter and large capacity for rope (on account of the great shaft depths). Two cars or cages are nearly always arranged to counterbalance each other so that the material raised is the only weight to be lifted. Sometimes one drum is keyed directly to its shaft, and the other is provided with a worm adjustment by which the level of the two cages may be adjusted, and by which stretch may be taken up.

As speed of hauling is important, winding speeds are high, and acceleration and retardation at the beginning and end of the trip are important. These can be obtained by suitable handling of the motive power, but as good economy of power requires as uniform a load as possible, the winding drums are often made conical or cylindro-conical, with hoisting starting slowly on a small diameter, and accelerating rapidly as the rope winds on the grooves of increasing diameter. Furthermore, if the winding diameter at the start of hoisting is small enough, the loaded car being hoisted will be completely counterbalanced by the empty car unwinding rope from the large diameter, so that the full power of the engine can be devoted to accelerating the cars. Deceleration at the top is accomplished by gravity, aided by slight braking if necessary.

Another consideration which leads to drums of slight conicity is that of equalizing the shaft torque. As the load ascends, less and less rope has to be lifted with the car, and the drum diameter and consequently the hoisting speed can be slowly increased without increasing the load or speed of the engine.

Separate drums on the same shaft are sometimes used for winding the two ropes of a two-car counterbalanced system. In some cases one drum is used, sufficiently long so that each rope winds in its own end of the scoring; in others a shorter drum is used with only a few empty grooves between the two ropes, one winding into the score shortly after the other has unwound from it. Mine hoist drums are often provided with scoring for considerable spare rope, to allow for future increase in shaft depth.

Drum, Outboard. A winding drum mounted separately from the rest of the drums in a winch and driven either separately or by gearing from the engine driving the main winch. It is generally located to one side, though sometimes in line with one of the other drums, and is so placed for convenience in leading the lines, or because it is temporarily added to the main winch to obtain an extra drum.

Drum, Peaking. A term sometimes applied to the drum of a crane or derrick winch which handles the boom hoist or topping lift.

Drum, Storage or Cable Storage. A winding drum which has a considerable capacity for cable, for use under widely different conditions as to length of hoist or haul. Such conditions arise in building operations as the successive floors are reached. In particular, a derrick slewed by a bull wheel must have some such provision for lengthening the slewing line if used in building operations.

Drum, Tag Line. A small winding drum which keeps up the slack and maintains a slight tension in a tag line attached to the load lifted by a crane, dispensing with the services of a tag-man. It is often driven by a drag clutch on the main shaft of the hoisting winch.

Drum Shaft. The shaft on which the drum of a hoisting or hauling machine is mounted. In some types, the shaft is keyed in the drum and turns in journal bearings; in others the shaft is fixed in the frame and the drum turns on it, bronze bushings being inserted to take the wear; while in other cases the shaft, running in journal bearings, bears one part of a friction clutch which can be engaged at will with the drum. As the load on a drum shaft is considerable, its diameter must be kept as small as possible consistent with strength, to cut down frictional losses.

Dump, Wagon. An apparatus for dumping a load from the rear of a non-dumping wagon, consisting of a tilting platform to which the wagon can be clamped and tipped down backward until the contents (usually grain) slide into a hopper beneath. Sometimes the front end of the body is attached to a hoist and lifted instead; the first method, however, does not require the unhitching of the horses.

Duplex Block, Duplex Hoist. See Hoist, Screw Chain.

Eccentric. A form of crank in which the crank pin is enlarged in size so as to include the shaft, thus becoming the crank web and crank pin in one. It is nearly always used in connection with a surrounding or enclosing eccentric strap, which is attached to an eccentric rod, and produces a reciprocating motion of the remote end of the eccentric rod.

Eccentric, Adjustable. An eccentric which can have alterations made in its angular position, its throw, or both. The angular position may be crudely changed by loosening a set screw, and better by bolts and circular slots attaching it to a fixed disc or hub. The throw may be changed by moving the eccentric directly across its shaft, a slot and clamping screws being provided, or by revolving an outer eccentric portion about an inner portion also eccentric, and clamping it in the position of desired throw.

Efficiency. The ratio of output to input, or of useful work done to total work done, or of result accomplished to effort made. It cannot equal unity in any actual mechanism because of friction, and usually falls far below it.

Ejector. A modified form of injector suited for handling large quantities of a liquid against a small head. It consists of a jet of steam passing into a converging conical tube, to which the liquid also has access; the steam is condensed, but its kinetic energy is transferred to the liquid, giving it sufficient velocity to overcome resistance to flow, due to discharge or suction head, or to pipe friction. It is a useful means of handling muddy water or chemically active solutions, where the intermixing of exhaust steam is not objectionable, and especially where the heat given to the liquid is advantageous.

Ejector, Sand. A device by which sand may be placed in suspension in water, for transportation by a stream passing through a pipe. It consists of a hopper, in the bottom of which there is an open space between two nozzles, across which a jet of water passes. Sand in the hopper is kept agitated by vertical water jets directed upward, and is drawn into the discharge nozzle by the ejector action of the main jet.

Elastic. Having (as a solid) the power of returning to its original shape, after being distorted in any way, or (as a fluid) of returning to its original volume after being compressed or expanded. A body is perfectly elastic when it regains exactly its original shape after a deformation, upon the removal of the deforming force and the restoration to the original state of all other conditions.

Elevator. In general, a machine which raises or lowers material temporarily held in one or more containers traveling along a definite path which is vertical or is only incidentally inclined. They are divided into two general classes; platform elevators, also termed reciprocating or intermittent, and continuous elevators.

Elevators of the first class are distinctive and, when the term is used without qualification, a platform elevator is usually meant. The A. S. M. E. Code defines it as follows: "A hoisting and lowering mechanism equipped with a car which moves in guides in a substantially vertical direction. (Note: Dumbwaiters, endless belts, conveyors, chains, buckets, etc., used for the purpose of conveying and elevating materials and tiering or piling machines operating within one story are not included in the term Elevator.)" The construction and arrangement varies considerably according as the elevator is for passenger or freight service, and certain features are also dependent on the type of drive, whether electric, steam, hydraulic or pneumatic. (See Elevator, Electric, etc.)

Continuous elevators either have endless belts or chains to which flights, buckets or arms are attached to support the material, or utilize a current of air, water or steam as a means of carrying it along. (See Elevator, Belt; Elevator, Bucket; Elevator, Pneumatic, etc.)

Page 484, 750.

Elevator, Apron, or Inclined Apron. A moving apron (see Conveyor Apron) placed at a considerable inclination, and used principally for elevating or lowering purposes. When the inclination is less steep, and especially when the apron has horizontal as well as inclined runs, it is usually termed apron conveyor.

The conveyor apron may be made with wood or steel cross pieces; the former is common when the conveyor is used for boxes, barrels, bags and similar packages, or for definite containers, and the latter, especially when formed with deep step or bucket like depressions, for handling bulk material. (See Conveyor, Steel Apron.) Wood cross pieces must have suitable cleats, lugs, cradles or arms to hold the containers being elevated.

When mounted on a base with wheels or casters, provided with a self-contained driving motor, and with a means of raising one end of the apron unit to different elevations, it is called a portable apron elevator or conveyor.

Page 352, 759-771.

Elevator, Automatic Electric. An elevator which can be started by a system of push buttons and brought to the floor where it is desired without any operator being present in the car. The A. S. M. E. Code defines an automatic button-control elevator as an elevator the operation of which is controlled by buttons in such a manner that all landing stops are automatic. They are widely

operated on both alternating and direct currents and at 110 to 250 volts.

Page 482.

Elevator, Automatic Floor Leveling Machine. A device for automatically insuring accurate landings irrespective of load and speed, and of automatically maintaining this accurate landing during loading and unloading irrespective of the stretch of the cables.

Page 752.

Elevator, Barrel. A continuous vertical or inclined elevator having two parallel strands of chain running over sprockets at the top and bottom, with special curved arms attached to them to lift barrels from a loading platform and deliver them over the head wheels to an inclined runway. If delivery is desired at intermediate points, tilting or spring discharge arms may be used, which are curved to fit the barrel and pivoted at the outer ends of the arms fixed to the chain. As the load ascends, the projecting outer ends of the tilting arms strike against adjustable stops and are revolved down, tipping up the other ends on which the barrel rests, and rolling it off into a sloping delivery runway. The arms are then returned by springs. A barrel may also be forced off at a desired point by adjusting a cam shaped pusher which acts as a contact discharger.

Another type of barrel elevator has two complete loops of chain each running over its own top and bottom sprockets, geared together to run at the same speed and all lying in the same plane. The adjacent strands of the loops pass upward, carrying a barrel between them, supported near each end on two small concave platforms attached to the chains; the barrel is discharged by rolling off when it comes against a side contact discharge cam, and the platforms pass up over the sprockets and return downward on the outside.

Page 336, 464, 759-771.

Elevator, Belt. An elevating apparatus consisting of an endless flat or troughed belt passing around head and tail pulleys and over intermediate supporting idlers, the whole being set at an incline and driven in such a direction that material deposited on the upper run will be carried upward and be discharged over the head pulley.

The belt may be flat or troughed, the latter having greater capacity; it may have cleats or cross strips to prevent lumps from rolling down or packages from sliding, or when the inclination is steep it may have deep pockets or buckets. (See Elevator, Belt and Bucket.)

The details are similar to those described under Conveyor, Belt, except that no tripper is used since the discharge is always over the head.

Page 369, 418, 760-773, 826-840.

Elevator, Belt and Bucket, or Belt Bucket. A bucket elevator in which the buckets are fastened by their backs to an endless belt of fabric, which travels around head and foot pulleys having considerable crown.

Elevator, Bucket. A continuous elevator, consisting of a travelling endless belt, of fabric or chain, to which buckets are attached and which moves in such a direction as to raise material fed into them at the bottom, and deliver it by inverting them at the top. Pulleys or sprockets are mounted on the head and foot shafts at the top and bottom respectively, and may be directly in line vertically, or offset so that the lines of buckets between them are inclined, the ascending side being the upper one when thus inclined. The head and foot shafts are mounted in a frame and left open, or enclosed in a head casing and boot respectively which are con-

nected by a casing or trunking in the fully enclosed elevator.

The buckets may be attached to a single strand of chain at their backs, or to two strands at their backs or sides; they may also be fastened to a belt. The buckets may be widely spaced, or separated, or closely spaced, also known as continuous. The elevator may revolve at a sufficient speed to throw the contents clear of the buckets at the time of discharge by centrifugal force, or they may move more slowly, and a perfect discharge be obtained by a deflecting idler on the descending side of the elevator, or by the action of the bucket fronts in the continuous type.

The drive is usually through the head wheels, as power applied there gives a direct lift of the material being elevated. As the speed is slow, spur or worm geared speed reductions from motor or shaft speed are usual, and if the gearing is not such as to prevent backward running in case of failure of power, breakage of a driving belt, etc., a ratched device called a back stop is often installed.

Page 447, 826-839.

Elevator, Bucket, Inclined. A chain and bucket or belt and bucket continuous elevator operated in an inclined position. In addition to the types described under these heads, pan or apron conveyors are also made up with containers of an unsymmetrical shape suitable for work on steep inclines, and are used as inclined elevators, sometimes for very heavy work. (See Elevator, Apron.) They move on rollers incorporated in the side chains, but to prevent the enormous load of the chain at the time of passing over the head sprocket from coming on these roller bearings, they are often placed outside the chain, and the sprocket teeth bear on hardened bushings between the two sides of the chain.

Page 826-839.

Elevator, Bucket, Portable. A bucket elevator, generally inclined, mounted on a wheeled truck with its loading hopper, delivery spout, driving mechanism, etc., complete, so that it can be moved from point to point. Commonly used for loading purposes. (See Loader, Wagon.)

Page 433, 771, 837, 838.

Elevator, Centrifugal Discharge. A bucket elevator, of either the belt or chain type, which revolves at sufficient speed to throw the bucket contents clear of the elevator and into the discharge spout at the time of delivery, due to centrifugal force.

Page 409, 836-839.

Elevator, Chain and Bucket, or Chain Bucket. An elevator in which the buckets are fastened to one or two strands of chain.

Elevator, Chain Pump. A pump consisting of an endless chain on two sprockets, having disc attachments at intervals closely fitting the inside of a pipe into which the chain passes at the bottom under water, and up which it is drawn, lifting the water caught between the discs.

Elevator, Continuous Bucket. A bucket elevator in which the buckets are placed in a continuous line along one or two strands of chain or a belt, allowing feeding to be accomplished from a chute, and using the front of one bucket as a chute for the discharge of the next following one on passing over the head wheels.

Page 411, 826-839.

Elevator, Dewatering. A bucket elevator having its buckets made of perforated metal or woven wire, so that

water can drain away from the material raised. A draining elevator.

Elevator, Dock Leg. A two strand vertical bucket elevator which is suspended from the top by a structure erected on a wharf, and which can be lowered into the hold of a vessel for the purpose of unloading bulk cargo. The lower shaft is hung in the bights of the chains, no casing being used, and carries a boot which is open at the bottom and therefore self-feeding. In some arrangements the chain and buckets, of the gravity discharge V-type, are continued on a horizontal run at the top as a conveyor and carry the material over a storage bin where it is dumped; in other cases, the material is discharged as the buckets pass around the head sprockets, on to a horizontal conveyor for further movement. Adjustment is provided to allow for the varying levels caused by tide and condition of loading, in several ways. In one case the elevator is suspended at the end of a hinged boom which can be raised or lowered, and can be moved horizontally on the boom to accommodate vessels of varying widths and to reach both sides of the hold. The lower end of the elevator may also be swung to reach from side to side, being handled by rope tackle. Another method of providing vertical adjustment is to cause the elevator strands to pass up and down around two adjustable idler sprockets arranged to form a take-up on the descending side.

The drive is through the top sprocket.

Also called a dock leg unloader. (See Elevator, Marine Leg.)

Page 675.

Elevator, Double Belted. An elevator in which the machine is connected to an independent source of power such as shafting, by two belts, one open and one crossed, or by similar means in which the direction of motion is changed without reversal of the prime mover. (A. S. M. E. Code.)

Page 482.

Elevator, Drum Type. A type of electric elevator in which the car motion is obtained by means of the winding and unwinding of a hoisting cable on a spirally grooved drum driven by an electric motor through some form of intermediate gears, usually worm gears. The cast iron spider of the bronze worm wheel is cast integral with a flange by means of which it may be bolted to the winding drum, or, for slow speed freight service the drum may be provided with an annular or spur gear to mesh with a pinion on the worm-wheel shaft, giving an additional speed reduction. (See also Elevator Drum.) The car hoisting cables, usually two or three in number, have one end clamped to the drum and after winding several times around the drum pass over the overhead sheave and down to the car frame to which they are securely fastened. Car counterweight cables with one end fastened to the car pass up over an overhead sheave and down to the counterweight. Drum counterweight cables with one end clamped to the drum wind around the drum in the opposite direction to the car hoisting cables and run up to overhead sheaves and down to the counterweight. The drum type of drive is employed on all low speed and widely on medium speed electric elevators. The A. S. M. E. Code calls such an elevator a winding drum machine, and defines it as an elevator machine in which cables are fastened to, and wind on, a drum.

Page 478, 749-754.

Elevator, Electric. A car with counterweight, hoisting cables, sheaves, controller, drum and motor for lifting and lowering of materials or passengers. There are two

types, the drum and the traction. The former are for low and medium speed service, and the latter for medium and high speed service. Small electric elevators are suspended by wire hoisting cables from spirally grooved drums driven through a worm gear by an electric motor. This type is unsuitable where high speed is required since the drum would have to be of excessive diameter. The most satisfactory elevator for such service is the gearless traction type in which motion is produced by the tractive effort of the cables on the driving traction sheave. Traction elevators with geared motor drive using either heringbone or worm gears are also constructed.

(See Elevator, Traction; and Elevator, Drum Type.)

Page 477, 749-754.

Elevator, Electric Control of. The operating of electric elevators by a dispatcher. For example, an installation in the Brooklyn Army Supply Base uses electric control by dispatchers for operation of 90 elevators without the manual service or attendance of a single operator on any one of them. Truck operators press a button to signal the dispatcher when an elevator is desired or when goods have been deposited or removed. Ten dispatchers replacing 90 elevator operators control the entire operation of these 90 elevators. (See also Elevator, Automatic Electric.)

Page 484, 712, 757.

Elevator, Fingered. A continuous package elevator having its rigid arm or suspended tray formed of a series of parallel fingers projecting from one or both sides of a bar which is attached to the one or two chains of the elevator, and used in conjunction with similarly fingered loading and unloading platforms. A load resting on a platform is picked up by the fingered moving platform coming up from beneath it and passing between the fingers. Moving downward it will be deposited on a similarly fingered discharge platform, and if this be sharply sloping, the load will immediately slide out of the way of the next following car. The fingers may be curved to fit round objects, flat to hold boxes and trays, or combination, with a curved middle portion and straight ends.

Rigid arm elevators may utilize this mechanism on either the upward or the downward runs, but not on both in the same elevator, as the package will be thrown off in passing over the head. Fingered tray elevators, which carry the load on a level tray even while passing around the turns, may have fingered stations on both runs.

Page 331.

Elevator, Flight. A continuous elevator working on the principle of the flight conveyor, with transverse blades or flights dragged along a trough by chains. For bulk materials it is used for short distances only; for packages it is widely used and more generally known as a push-bar elevator, the solid flight being often replaced by a bar raised a suitable distance above the runway.

When a single chain or cable is used, with disc shaped flights dragged in a V- or U-shaped trough, it is known as a cable conveyor or a cable elevator.

Elevator, Freight. An elevator for carrying freight and on which no persons other than the operator and those required for loading and unloading are transported.

Page 503, 749-754.

Elevator, Gig. A small intermittent platform elevator travelling in guides in a vertical shaft, and used for handling articles uniform in size, such as boxes, cakes

of ice, etc. The box or cake in the loading runway is automatically released and slides onto the elevator platform when the latter has reached the bottom; it is then hoisted, and on reaching the desired height, slides out onto the delivery platform owing to the permanent slope of the elevator platform. Adjustable automatic stops limit the travel of the elevator, which can be made entirely automatic. It can be used for lowering by reversing the direction of the slopes.

Page 761.

Elevator, Gravity Discharge V-Bucket. An elevator consisting of two strands of chain fastened to the ends of V-buckets by rigid or swiveling attachments, but not pivoted. It passes upward over a turn or knuckle wheels into a short horizontal run along which the contents are spilled from the buckets into a trough which discharges to another conveyor or to a bin. Immediately after discharging, the conveyor passes downward around other turn wheels and to the foot wheels or boot, where the load is picked up. Also called a knuckle wheel elevator.

When the horizontal run is lengthened, so that the material is conveyed along it by scraping, it is usually called a gravity discharge V-bucket conveyor.

Page 413, 826-836.

Elevator, Hydraulic. An elevator in which the motion of the car is obtained by liquid water pressure. (A. S. M. E. Code.) The mechanism may consist of horizontal or vertical cylinders working with or without rope gearing in addition, operating by pushing or pulling and with high or low pressure. For the plunger type of hydraulic elevator, see Elevator, Plunger.

Page 489.

Elevator, Hydro-pneumatic. An elevator operated by a cylinder with a plunger or piston, and a combination of air and hydraulic power (water or oil). Since air is compressible, the load cannot be removed from a straight compressed air elevator at any other point than the top or the bottom of the travel (where the car is against stops). More than two levels can be served, however, if oil only is used in the elevator cylinder, but is forced into the cylinder by air pressure on top of it in the storage tank. When the air is released the elevator will descend, but motion can be arrested at any point in either direction, and the car locked by closing a valve in the oil line between the cylinder and tank. The action is like a hydraulic elevator without pumps, the source of compressed air supplying the power.

Elevator, Inclined. An elevator which works at some other angle than 90 deg. from the horizontal. Considering continuous elevators, as the angle becomes small the action approaches that of a conveyor and there is no distinct dividing line between elevators and conveyors.

Elevator, Inclined Chain. An arrangement for assisting wheeled vehicles carrying loads up or down ramps or inclined runways, consisting of an endless chain set slightly above the floor and travelling parallel to it, and having upward projecting lugs. These lugs engage with projections on the bottom of the vehicles, and drag them up the grade, or lower them down it. If men accompany the load, as with hand trucks, they straddle the chain and walk along with the load, but do no pulling. These are much used in handling material between ships and wharves, and are often mounted on an adjustable incline which can be raised or lowered to suit the deck level or tide conditions. If two chains are placed side by side, they may operate in opposite directions, or one

chain may be reversed if desired. Also called a dock elevator, and chain haul elevator.

Page 399.

Elevator, Marine Leg. A vertical bucket elevator used for unloading bulk material (generally grain) from vessels at a wharf, which is supported from the elevator structure in such a way that it can be adjusted vertically and horizontally at right angles to the wharf line in order to reach as much of the hold of the vessel as possible. It is similar to a dock leg elevator (see Elevator, Dock Leg) except that the chain sprockets are usually carried in a rigid frame and the leg is completely cased, instead of the lower sprockets and boot being simply hung by the exposed bucket chains. The discharge is over the head sprocket, through a spout to a storage bin, and to a horizontal conveyor or to another bucket elevator for delivery to its destination in the building.

Three types of marine legs are in use, designated according to the method by which they are supported and adjusted, and known as the boom, the crosshead and the combination types. In the crosshead type the elevator leg is pivoted to, and hung from, a crosshead which can be slid in vertical (or slightly inclined) structural steel guides in the building; the lower end is swung outward by a pusher arm operated from the side of the building and power is delivered to the head pulley by a rope drive arranged with idlers in such a way that the varying vertical positions of the crosshead and angular positions of the leg will be accommodated without interference with the drive. In the boom type, the leg is suspended from the outer end of a boom which is pivoted to a fixed point on the building at its inner end, and its angular position is altered by tackle attached to its outer end leading diagonally upwards. The leg is moved horizontally at its lower end by pulling with tackle, the head pulley is driven by a rope drive leading around sheaves at the pivots at the two ends of the boom. In the third or combination type, the leg is suspended from a boom which has its inner end pivoted on a vertically moving crosshead; one drum of a hoisting winch controls the boom and the other the crosshead. The leg is driven by rope transmission so arranged that both the varying height of the crosshead and the varying angular positions of the boom are allowed for. This type is especially suitable for working under large variations of water level.

Page 675.

Elevator, Material. A term usually applied to a type of portable platform elevator outfit used by contractors in building construction. A top or head frame is carried on trestles or bents which stand a sufficient distance above the highest floor being served to allow the platform to come up to that floor. One cage or car may be used, with or without a counterweight, or two are provided, each serving as a counterweight for the other. A hoisting winch is located on the ground near the foot of the guide frames in which the cages move, and operates the car or cars by a rope leading through a foot or bottom sheave, up to the head frame and thence over a head sheave down to the cross-beam from which the car is suspended.

Elevator, Package. A general term used to include the various material handling elevators of the vertical or inclined continuous type, with trays, shelves, or rigid arms of various forms and curvatures attached to one, two, or three endless strands of parallel moving chain.

Articles laid on the shelves or arms may be raised or lowered or both; loading and discharging may be entirely by hand, entirely automatic, or by a combination of the two means.

Page 329, 761, 770.

Elevator, Perfect Discharge. A two strand chain bucket elevator having unusually large head wheels, and with the return chains "snubbed" in under the head wheels by a pair of small snubbing, choke or deflecting sprockets, in order to invert the buckets completely over the discharge chute. This allows perfect discharge to take place without the aid of centrifugal force. Also called positive or complete discharge type.

Another arrangement giving a clean discharge is to have the bucket fastened between the chains, but with its discharge opening inclined toward the back of the chains. As the buckets pass around the head wheels, the contents are dumped into pockets formed by partitions radiating from the head shaft and attached to discs at their ends; these pockets in turn deliver the material to a chute directly beneath them, without interference from the chain or buckets.

Page 411.

Elevator, Plunger. A hydraulic elevator having a ram or plunger directly attached to the under side of the car platform. (A. S. M. E. Code.)

Elevator, Pneumatic. An elevator which is operated by air pressure on a piston moving in a cylinder, the cylinder and attachments being practically the same as in air cylinder hoists, which see. The car moves in guides, rests on stops at the bottom, and against similar stops at the top, which limit its travel.

Two arrangements of the hoist are in use; the direct type and the rope type. The direct type has the air cylinder located directly above or below the center of the shaft, with the piston rod attached to the top of the car or beneath the car, extending into the ground; the rise of the car is thus limited by the length of the cylinder. The rope type has the air cylinder located at the side of the shaft, and its piston rod acts on the car through wire rope block and tackle arranged to make the travel of the car two, four or six times the stroke of the cylinder. For lifting heavy loads, the arrangement of the ropes and sheaves may be reversed, giving the car a shorter travel than the piston in the cylinder, but multiplying its power.

The car may be guided at the sides or at the corners, and may be provided with the usual safety dogs. It is difficult to load or unload an air elevator at points between the top and the bottom, as the air is elastic, and the elevator will descend or rise during the operation. (See Elevator, Hydro-pneumatic.)

Page 491.

Elevator, Portable. See Tiering Machine.

Elevator, Portable Belt. See Loader, Wagon; Conveyor, Portable Belt.

Elevator, Push-Bar. A continuous drag-elevator, operating with practically the same mechanism as the push-bar conveyor, namely, two endless chains connected by crossbars moving parallel to an inclined (or even vertical) trough-like runway bed, and elevating articles resting on the crossbars by sliding them along up the bed. For steep inclines there must be a reasonable uniformity in the size of the containers, appropriate to the height of the push-bar above the bed; when the bed is nearly or quite vertical, top guides are used, forming with it and the side guides, a complete shaft. Loading may be done at any point; discharge is over the head, or at inter-

mediate points by openings through the bed closed by hinged doors which, when lowered, form the discharge chute on which the articles slide away from the bed. Unloading in the outward direction may also be performed by tipping a section of the bed outward, forming a contact plate which tips the parcel away from the bed onto a sloping receiving platform on which it immediately slides away.

Page 345, 759-773.

Elevator, Rigid Arm. A continuous vertical elevator consisting of two parallel strands of chain passing around head and foot sprockets fastened in pairs on two shafts, and having attached to them at regular intervals rigid horizontal arms with diagonal braces from below. These arms may or may not be cross braced to each other, and are either straight, or curved to fit special objects to be lifted. Cushion spring braces are often used, to cushion the impact of picking up a load, to decrease the maximum load on the chain and other parts, and to permit higher speed of operation.

The arms will automatically pick up a load from a fingered loading platform, and discharge over the head. If the articles elevated are uniform in size, and the upward run is enclosed in a shaft up which they will slide easily, the elevator may be made self-unloading at any floor by slanting the arms downward slightly away from the chain, loading them from the side, and opening a door on the face of the shaft-casing at the point where discharge is to take place. The article will slide out on a runway prepared to receive it. Cakes of ice will slide on smooth guides; trays and boxes will require roller supports. For lowering, the direction of rotation may be reversed.

Page 331.

Elevator, Sack. An elevator especially adapted to handling sacks of grain, flour or similar articles. Sacks may be slid easily on smooth surfaces, and do not require smooth level platforms for their transportation, but must not be torn or caught by projecting parts about the conveyor.

Page 331.

Elevator, Screw. A machine like a screw conveyor, with the axis of the screw placed in a vertical direction and enclosed in pipe, and used for elevating material supplied to it at the bottom. As continuous feed must be arranged, intermediate bearings are omitted, and the pitch should be less than with horizontal conveyors. It will operate successfully on certain materials whose particles cling, like ground cork, cotton seed, etc.

Page 424.

Elevator, Steam. An elevator in which the motion of the car is obtained by a steam engine directly applied to the elevator machinery. (A. S. M. E. Code.) The steam elevator is now obsolete except in so far as its operation is continued in a few old installations. The rope lifting the car was usually wound around a drum turned by a steam engine. However, the traction elevator principle also was applied to some extent on steam elevators.

Elevator, Traction. A type of electric elevator in which the car motion is obtained by means of adhesion between the driving sheave and the hoisting cable. There are two classes of traction elevators known as the direct or gearless traction and the geared traction machine. Either herringbone or worm-gear traction machines may be constructed. All direct traction and herringbone geared elevators are for high speed cars, and are the only elevators giving satisfaction for high speed service. Worm-

geared elevators are for medium speed car operation. The direct traction elevator operates with direct rather than a geared connection between the motor and driving sheave, the gearing being eliminated by the use of a specially designed very slow speed motor.

Page 480, 749-754.

Elevator, Tray. A continuous vertical elevator operated by one or more endless chains passing around sprockets at the top and bottom, and carrying wooden or metal trays rigidly attached to them, or suspended by pivots. (See Elevator, Tray, Suspended; Elevator, Tray, Three Chain.)

An elevator in which the trays are rigidly attached to the chains will discharge its load in passing over the head wheels, unless it is removed by some special means like a contact discharge cam while ascending. If loaded on the descending run, it will discharge at the bottom by tipping the trays downward as the chains start to pass around the foot wheels. If a fingered tray is used, it will discharge at any point in the descending run. (See Elevator, Fingered.)

Also called a package elevator.

Page 336, 759, 761.

Elevator, Tray, Suspended. A package elevator consisting of a series of equally spaced platforms or trays attached to two vertical endless strands of chain passing around sprockets at the top and bottom. The trays are suspended at each end by rigid diagonal hangers meeting at a pivot attachment on the carrying chain; the tray thus naturally hangs level and remains so in passing around the head wheels. Trays are usually symmetrically hung; occasionally they are suspended from points on opposite sides near diagonally opposite corners. Close hung trays will not interfere with a through-shaft at the head; trays hung a considerable distance below the pivot, as required for carrying large objects, will strike the head shaft, which must, therefore, be eliminated by driving the two sprockets, each overhung on its own short shaft and carrying a large spur gear, by a transverse shaft with two pinions, placed below the sprockets and their spur gears.

Solid bottom trays may be loaded or unloaded automatically or by hand, generally the latter. Fingered trays are usually arranged for automatic loading and discharge.

Suspended trays may be carried on inclined or horizontal runs with equal facility. (See Carrier, Suspended Tray.)

Also called a swinging tray elevator.

Page 336.

Elevator, Uni-strand. A continuous vertical chain elevator consisting of a single strand of chain passing around sprockets at the top and bottom. Attached to the edge of this chain, and standing out perpendicular to the plane of the sprocket wheels, are rigid arms shaped to hold special packages, or platforms for boxes or trays, fingered if desired. The platforms are attached to the lower ends of vertical links, and the pivoted point of attachment to the chain is a point at either the top or the middle of the vertical link. In the former case a roller on the lower end of the link runs in a guide parallel to the chain in such a way as to positively keep the arm vertical; in the latter, points at both top and bottom of the vertical link are thus guided.

Loads are picked up on the upward run (unless placed by hand on the downward run) and pass around the head, unloading automatically on the descending run on

fingered receiving platforms. The elevator is driven at the head by a geared motor.

Elevator, Water. A bucket elevator on single or double strands of chain, used to raise water, the foot wheel being suspended in the chain loops. The flight type is also used, consisting of transverse wooden blades or paddles attached to chains at intervals and pulled upward through a wooden casing which they closely fit, returning to the foot wheel outside the casing.

Elevator Arms. Rigid, adjustable or pivoted arms which are attached to the chains of a continuous chain-driven elevator and used for raising material in large pieces or in containers. (See Elevator, Rigid Arm.)

Elevator Automatic Return. A device which returns the car switch to the off position when the operator releases his grip on the controller handle.

Elevator Automatic Stop Switch. A device which gradually brings the car to a stop as the top or bottom landings are approached.

Elevator Boot. The lowest part of the casing of a bucket elevator, from which the material to be elevated is dug by the buckets passing around the foot wheels, or which receives spillage in case the material is fed directly to the buckets on the upward run. It contains the bearings and take-up mechanism for the wheel shaft, and has doors to give access for cleaning or in case of a choke. Usually the boot is large and roomy, the only exception being when small lots of material are being handled, and to avoid mixing, the amount of material contained in the boot must be reduced to a minimum; the bottom then closely fits the path of the bucket tips and the take-up is placed in the casing head. The boot is made of cast iron, of cast iron sides with curved steel bottom plate, or of steel plates with or without a bottom plate. Occasionally the boot is formed in a monolithic mass of concrete. Boot pulleys are often closed tightly at the ends to keep out the material. The whole boot is often made dust-proof, including the openings for the take-up mechanism, which are covered by a sliding plate.

Page 446.

Elevator Boot Tank. A water-tight tank in which an elevator boot may be set if it must extend below ground level where there is liability of the entrance of water.

Elevator Brake. A clamp or band is ordinarily arranged to automatically apply frictional resistance to a brake wheel and retard the motion of an elevator drum or sheave whenever current supply to the elevator motor is interrupted. In the most prevalent types it is actuated by means of a weight or by the pressure of a heavy helical spring, controlled by an electro-magnet. While current supply to the hoist motor continues, the electro-magnet holds the brake in the released position, compressing the helical spring or raising the weight. The removal of electrical supply by the controller disconnection destroys the magnetism and the spring clamps the brake band against the brake wheel.

Elevator Brake Wheel. The wheel about which the brake band clamps in stopping and holding an elevator. In certain traction installations the brake wheel is pressed directly on the armature shaft on the motor and therefore rotates at motor speed. It is usually the same diameter as the driving sheave.

Elevator Bucket, Continuous. One of the series of abutting or overlapping buckets of a continuous bucket elevator. They are generally triangular in section, but when hung between two strands of chain, they may extend back, having a four sided section giving greater

capacity. The fronts of the buckets often have forward projecting flanges at the sides, these helping to form a complete chute for the discharge of the following bucket when passing over the head wheels.

Page 411, 826-839.

Elevator Buffer. A device placed near the bottom of an elevator shaft in such a manner that a cage passing below its lower terminal at normal speed may be gradually brought to stop without shock to the passenger. Counterweight buffers are commonly used in the same manner under the counterweight. These devices generally operate on the oil dash pot principle, with the addition of a spring to restore the piston to normal position. Oil buffers capable of stopping the car or counterweight from 50 per cent excess speed without discomfort to passengers are now provided by some builders.

Elevator Cables. Wire cables or ropes used for the support, balancing and hoisting of elevators. These include car hoisting, car counterweight, drum counterweight and compensating cables. All are required on drum type elevators, but hoisting and compensating cables only are employed on traction machines. Car hoisting cables on a drum type machine have one end fastened to the car frame, pass up and over overhead sheaves and then to the driving drum, around which they are wound in spiral grooves with their ends clamped to the drum. This cable transmits the hoisting power from drum to car and carries part of the weight of the car on one side and the counterweight on the other. Traction type elevator hoisting cables wind once around the driving and idler sheaves and terminate on the counterweight and therefore sustain the weight of both the car and the counterweight on opposite sides. Car counterweight cables pass from the car up and over an overhead sheave and down to the counterweight. Drum counterweight cables connect the counterweight and drum passing partially around suitable overhead and idler sheaves, and winding on to the drum as the car descends. Compensating cables connect the bottom of the car with the bottom of the counterweight passing under a compensating sheave near the bottom of the hoistway so that acceleration cannot produce a slackness of hoisting cable due to sluggish action of the counterweight on ascent, or of the car on descent. They also compensate for the variation in the net load on the driving sheave of traction machines, due to the shifting of the weight of the hoisting cables from one side of the overhead sheave to the other, that occurs during elevator motion.

Page 818-822.

Elevator Car. The load carrying unit of an elevator, including platform, its supporting and guide frame, and enclosure. (A. S. M. E. Code.)

Elevator Car-gate Electric Contact. An electrical device the purpose of which is to prevent the normal operation of the car,—except by the use of a car-leveling device,—unless the car gate is in the closed position. (A. S. M. E. Code.)

Page 484, 752.

Elevator Car-leveling Device. A mechanism the purpose of which is to move the car automatically toward the landing level from either direction and to maintain the car platform at the landing level during loading or unloading. A leveling device, however, may also be used for the emergency operation of the car. (A. S. M. E. Code.)

Elevator Car Sling. The frame encircling an elevator and supporting it, consisting of the upper cross-member to which the hoisting cables and guide shoes are usually

attached; the car-posts or stiles; and the under cross-member, which supports the car sills, platform and guide shoes.

Elevator Casing. The housing or enclosure within which a bucket elevator operates. Casings are made of wood or steel, combined with cast iron or steel boots and head casings. When the two lines of buckets are cased separately, it is known as a double leg casing, and is sometimes round; otherwise it is single leg, and is always rectangular in cross section. The casing is often omitted and the head and wheels held in position by framing.

Also called trunking and legging.

Elevator Clearance. At the top of the hoistway is the vertical distance between the lowest point of the superstructure and the highest point of the car enclosure or crosshead when the car is at the limit of the over-travel at the top. Clearance at the bottom of the hoistway is the vertical distance between the floor of the pit and the lowest point on the understructure of the car sling, exclusive of the safeties, guide brackets or shoes, when the car is resting on the bumpers or buffers fully compressed. (A. S. M. E. Code.)

Elevator Code. A Code of Safety Standards for Elevators published by the American Society of Mechanical Engineers and giving standards for the construction, operation and maintenance of elevators, dumbwaiters and escalators.

Page 495.

Elevator-Conveyor. A term sometimes applied to continuous carriers which will move material horizontally, vertically or on an incline in the same container, such as pivoted bucket carriers or gravity discharge V-buckets. Also applied to an inclined bucket elevator. (See Elevator, Inclined; Conveyor, Inclined; Carrier.)

Page 413.

Elevator Hoistway. Any shaftway, hatchway, well hole or vertical opening or space, in which an elevator or dumbwaiter travels. The hoistway may or may not be enclosed. (A. S. M. E. Code.) If all four sides of the hoistway have to be left open for removal of load the counterweight must run in a separate shaft.

Elevator-Lowerer. A name sometimes applied to a package elevator of the tray type, equipped for carrying loads either up or down, and for discharging in either run.

Elevator Machine. Defined by A. S. M. E. Code as the machinery and its equipment used in raising and lowering the elevator car.

Elevator Safety Governor. A flyball governor usually located at the top of the hoistway and acting by centrifugal force to control the elevator speed when it exceeds a certain amount. Two freely revolving flyballs are raised by excessive speed and actuate a cam by means of a link. The latter short circuits a portion of the motor field resistance thereby increasing the field strength and decreasing the motor speed. A further upward motion of the governor balls brings a second cam into action and the latter trips an eccentric operated by two coil springs. The eccentric grips an endless loose cable, which passes the length of the shaftway, and connects with dogs underneath the car, the dogs being set and power shut off by the gripping and moving of the loose cable relative to the car. The dogs can be set in most elevators also by the use of a hand wheel in the car.

Page 485.

Elevator Slack Cable Switch. A switch ordinarily located at the bottom side of the opening provided for the

passage of an elevator hoisting cable from the motor room to the head frame, and actuated by a sagging of the cable in case of any slackness. Also a similar switch placed at the point of attachment of the hoisting cable to the car.

Page 486.

Elevator Take-up. In continuous elevators, the adjusting mechanism by which constant tension may be maintained in the endless belts or chains. It usually consists of a pair of bearings for the foot wheel which slide in straight vertical guides and are adjusted by screws working in a nut, or in some cases, automatically by a weight acting directly or by means of a lever. These guides may be fixed in the boot sides, or fixed pillow blocks with vertical adjustment, standing on the foundation, may be used. To make them dust proof, some sort of sliding shield is essential. (See also Elevator Boot.)

Page 462.

Engine. A machine for transforming the potential energy of a fluid under pressure, or containing available heat, into mechanical work either by rotating a shaft, or by exerting a push or pull, or both, alternately, against a resistance. Originally meaning almost any cleverly contrived machine (as engines of war) the term is becoming more and more restricted in its technical usage, with a tendency toward its reservation for prime movers of a definite type. A reciprocating engine is usually meant, if no qualifying term is used. (See Engine, Rotating; Engine, Rotating; Engine, Oscillating; Engine, Reciprocating.)

A few of the methods of classifying engines are: according to the medium used for conveying energy to them, as steam, air, gas; according to the position of the cylinders, as vertical, horizontal, inverted; according to the number of cylinders and their arrangement, as single, double, three-cylinder, etc., or as simple, compound, triple, etc.

Engine, Gas. An internal combustion engine using as a fuel a gas like natural gas, city gas, producer gas, blast furnace gas, by-product coke oven gas, etc. It may be vertical in small and medium sizes, but large ones are always horizontal. Vertical engines have one cylinder or two or more in a row; horizontal engines, if more than one cylinder, usually have two cylinders in line, or tandem, and four cylinders in a double or duplex tandem arrangement.

In addition to the usual reciprocating engine mechanism, a gas engine requires a mixing valve to control the relative amount of air and gas drawn into the cylinder, and this is often combined with the governor mechanism in such a way as to vary the quality of the mixing during change of load, generally weakening it with decrease of load.

Engine, Gasoline. An internal combustion engine using gasoline as a fuel. Two types are in general use; the automobile type, having two or four vertical single acting cylinders, two stroke or four stroke cycle, usually water cooled by means of a circulating system with pump and radiator, and with jump spark ignition; the stationary type, having a one horizontal single acting cylinder, two stroke or four stroke cycle, water cooled by means of an open water jacket surrounding the cylinder, in which the water vaporizes, with jump spark or make and break ignition.

Engine, Oscillating. A reciprocating engine in which the cylinder swings on trunnions, the piston rod being directly attached to the crank pin, eliminating the con-

necting rod. Used in some types of small air motors for hoist operation.

Engine, Reciprocating. An engine in which a piston moves back and forth in a cylinder, transforming the energy of a fluid under pressure into mechanical work.

Engine, Rotary. An engine generally using steam or air, in which the fluid under pressure is delivered to internal spaces which gradually enlarge to a maximum and then reduce to a small volume, due generally to the eccentric rotation of two of its parts. The fluid is admitted, expanded to the maximum volume and exhausted during the cycle, which may be a half or a whole revolution. All the principal parts of the engine rotate, and there is no reciprocation.

Engine, Rotating. An engine in which the various parts have the same motion relative to each other as in an ordinary reciprocating engine, but in which the crank is made fast and the frame carrying the cylinder rotates and delivers the power to the driven shaft, this being an inversion of the usual arrangement where the cylinder and frame are fixed and the crank shaft revolves. At least three cylinders are used, in order to obtain good balance, and they are usually mounted in a circular frame.

These engines are steam, air or internal combustion driven and have certain advantages in the way of smooth running, high speed and light weight.

Escalator. A moving apron type of elevator-conveyor set at an inclination corresponding to that of ordinary stairways, and used for conveying persons or freight up or down. Two types are in use, the cleat, and the step. The former is simply an inclined apron elevator with its surface covered with parallel cleats pointing along the run, and with tops sloped so as to resemble a miniature step. These cleats pass between the prongs of a comb at bottom and top, picking up and discharging the passenger or other load almost automatically.

The step type acts like a moving platform on the horizontal sections at the top and bottom, but breaks into steps as it approaches the slope in a vertical curve. Each step is carried by two rollers at each end, those on the rear side running on rails inside the front ones. On the incline the inside rails are set far enough back of the outer ones to hold the step level. The steps are all connected to chains passing around sprockets at the top and bottom, and the drive is usually at the head.

Escalators may be made reversible; if two are placed side by side, one running up and one down, it is called a duplex arrangement; if the two always run in the same direction, it is termed a double file escalator.

Escalator, Freight. An escalator, usually of the cleat type, especially adapted for the elevating or lowering of material in wheeled containers or trucks accompanied by operatives, by the provision of suitable hooks or lugs on the moving apron to engage the axles or special projections on the bottom of the vehicles. (See also Elevator, Apron.)

Excavator. A machine used on land for digging various materials, lifting them and depositing them in a new location. The materials handled vary from soft loose substances like sand through a wide range approaching soft rock; hard rock must be blasted or otherwise broken up. The corresponding machine for digging under water is usually called a dredge; some machines can be and are used in either work.

The machines all include a combined digging and containing element corresponding to the combination of a

hand pick and shovel, an operating mechanism for handling the digging element and dumping its load where desired, and a skid, car or truck on which it is mounted and by means of which it is moved from place to place. Some types of so-called excavating machinery are fixed in place, but these are really machines for rehandling material brought to them.

Excavators may be classed according to the nature of the digging element, as power shovels, drag buckets, grab buckets and chain bucket or ladder excavators; and according to the power used, as steam, gasoline, electric, etc.

Some types dig below the level on which the machine stands, some above, and some can do both. Some bring the excavated material to a fixed point for dumping; some must be followed by cars to contain the spoil, some have a long enough reach to deposit the material a considerable distance from the excavation, while others return it to the excavation behind the machine after it has moved along. Some, like trenching and ditching machines, are designed to produce an excavation of a particular form, but the majority can be adapted to miscellaneous forms of excavation.

Page 235.

Excavator, Drag-line. See Drag-line Excavator.

Excavator, Grab Bucket. An excavating machine in which the digging element is a grab bucket. (See Bucket, Grab.)

Various types of cranes are used to handle the bucket, the most common probably being a locomotive crane.

Another common type consists of a platform on wheels or skids, with an A-frame derrick at one end, the winding machinery in the middle and the boiler at the other end. The boom is often worked at a fixed inclination, or there may be a variable topping lift. In the arrangement known as automatic swinging the hoisting rope from the two-rope bucket is led from the boom point sheave to a guide on one leg of the A-frame and thence to the hoisting drum. The bucket lowering line is led through a guide sheave on the other leg. During hoisting the pull is in one direction, tending to swing the boom so that the bucket arrives over the dumping point at the time it is at the proper height for dumping; when the hoisting line is released and the load dumped the tension in the lowering line causes the boom to swing back to the digging position. Reversal of the lines causes the swinging to be reversed. If spoil must be dumped on either side a bull wheel swing is used, and a separate slewing engine or slewing attachment is required.

Grab bucket excavators are the only type which can dig to great depths or within small enclosures like caissons, coffer dams, etc.

Excavator, Skid. An excavating machine mounted on a platform which is supported on skids; rollers underneath these skids rest on a temporary timber trackway laid on the ground. To move the machine a bridle is attached to the rear of the platform, to this a block and tackle, and this is in turn connected to a long piece of wire rope which is made fast at the far end to a deadman or other suitable anchorage. The tackle is operated by a winch on the excavator.

Various types of digging and operating mechanisms are mounted on skids, such as grab buckets, dippers, chain buckets, etc.

Excavator, Slack-rope Cableway. An arrangement for excavating and handling bulk material, comprising a drag-line scraper bucket attached to a trolley or carrier, which runs on a track rope spanning the area to be

excavated, a tower for elevating one end of the track rope, a block-and-tackle rig arranged to tighten or slacken the track rope according as the rope in the tackle (called the slack rope) is wound in or out on the drum of a winch, and a pulling or drag rope leading from the bucket to another drum of the winch. With the bucket at the outer end of the track rope, the track rope is slackened, allowing it to sag and let the bucket drag in the material, where it fills as it is pulled along. When full, the track rope is tightened, raising the bucket clear; continued winding of the pulling rope will run the carrier to the dumping point, where it can be dumped by pulling on a trip rope, which releases a latch and allows the bucket to dump either front or back, or by running the trolley carrying the bucket against a fixed stop on the track rope, which will cause a similar action. Releasing the pulling line will allow the trolley and bucket to run down to the other end, for another trip. If conditions will not allow sufficient slope, a tail or back-haul rope can be used to return the bucket to the starting point, but this requires an additional winch drum. When sufficient depth of cut has been made at one point, either the tower or the anchorage at the remote end, or both, are moved. Occasionally the rope passes over a sheave on the tower and is fastened to an anchorage or deadman at the rear, the same as at the outer end; this relieves the tower of the horizontal pull.

This apparatus can also be used to excavate at a high level and deliver to a low level, by a reversal of operations.

Excavator, Tower. See Excavator, Slack-rope Cableway. The term is sometimes applied to a slack-rope cableway excavator when the necessary height for operating the track rope is obtained by a tower, rather than by the natural conformation of the land. The tower is often movable.

Excavator, Trench. An excavating machine designed especially for digging vertical wall trenches for laying lines of piping, sewers, etc. The usual arrangement involves a chain bucket or ladder digging arrangement mounted at the rear of a truck on wheels or a track-laying truck, a belt conveyor for conveying the dirt from the bucket dumping point at the top of the ladder to the spoil bank at the side, and a boiler and engine for driving the machinery and moving the whole excavator slowly along the trench. The ladder usually slopes downward to the rear, the buckets scrape the dirt off the end of the cut on the way up, and dump as they pass over the top sprocket, which also does the driving. Side cutters are attached directly to the chains. The width of the trench may be altered by changing the buckets for others of a different length and the machine cuts the full width and depth (which can be varied) at one cut. The ladder may be swung up horizontally when the excavator is to be moved to a new location; it begins the trench by digging as it is swung down. The belt conveyor can be arranged to deliver the spoil to either side and to any height within the capacity of the machine.

Another type has a digging element which is as wide as the narrowest trench to be dug, and digs wider trenches by oscillating the digger transversely by means of an adjustable worm gear drive.

Still another type has a large wheel with digging buckets on its periphery. The wheel is rotated while its supporting car is moved forward.

Trench excavators are driven by steam or internal

combustion engines, and occasionally by electric motors. If they are mounted on track-laying or tractor wheels, they are moved along the trench by their own power; if on skids and rollers they are moved by a cable attached to an anchorage in advance, this cable being wound on a drum on the excavator as it progresses.

Page 239.

Excavator Engine. Term applied to a two-drum steam-driven winch especially arranged for operating two-rope grab buckets, or drag line excavators. (See Winch, Drag-line Excavator.)

Exhauster, Centrifugal. A centrifugal fan used for withdrawing air or any other gas from a space and delivering it outside the space or to a distant point.

Expansion Joint. A joint or connection which permits expansion due to heat or other causes. In piping expansion joints are of the sliding or telescoping type, of the flexible bend type, or of the corrugated cylinder or diaphragm type. Expansion in rails is allowed for by leaving open spaces between the rail ends, though less attention is paid to this than formerly, and the rails are even welded together continuously for long sections. Buildings, bridges, concrete structures, pavements, long crane runways, etc., are provided with means of taking care of expansion, in good practice.

Eye. A hole through a pin, bolt, etc., or a metal piece or rope looped so as to form an opening through which something can pass, as a hook or rope.

Eye Bar. A long bar having an eye in each end, like the tension members of some bridge structures.

Factor of Safety. A quantity which, if multiplied by the working stress in a part under load, will give a quantity equivalent to the ultimate strength of the material of the part. This is the nominal or so-called apparent factor of safety, and to say that a factor of safety is four does not mean that the part can be subjected to four times the working load before rupture. The real factor of safety involves allowances for the following: The kind of loading as steady or dead, variable or reversing; the elastic limit of the material; the method of applying the load—gradually, suddenly, or with shock; and for ignorance as to the internal condition of the material—its defects, etc. In any material having an elastic limit, the actual factor of safety will be less than the nominal in proportion to the ratio of the elastic limit to the ultimate strength.

Suddenly applied loads produce double the stress that a gradually applied load produces, and loads applied with shock, as by dropping, may produce enormous stresses, dependent on the load and the distance dropped and the amount of elasticity of the part loaded. The greater this elasticity the less the resulting maximum stress from a suddenly applied load, and the amount of energy which a structure or part can thus absorb from a suddenly applied load is termed its resilience. Therefore, extreme rigidity in a structure is not always desirable, as the latter may receive serious damage from a shock which would only cause a temporary deflection in a resilient structure.

Shocks in material handling machinery are caused by unevenness or openness of rail joints, flat wheels, dropping of a load upon a platform, slipping of chain links (which may be especially violent), sudden picking up of a load by a part moving at considerable speed, etc. Where such shocks are unavoidable, parts must be made much stronger than the conditions of static loading would indicate, or else cushions of rubber, steel springs, or an elastic, springy construction should be used.

The nominal factor of safety in ordinary crane structures is five or six.

Fairleads. Fittings used to guide rope or chain so that it is delivered "fairly" or in the plane of the receiving sheave or drum. They may be drums, guide sheaves, or rollers, or merely smooth eyes or guides over which the rope or chain can slide easily.

Fair-leader. A guide or guard for leading rope or chain properly onto a sheave or drum, usually consisting of a smooth rounded opening in a metal plate. Where much wear is expected it is renewable. Another type often used with grab buckets consists of a guide sheave, with two rollers located on opposite sides of the rope close to the point of contact with the sheave. A third roller is placed across the plane of the sheave, thus completely enclosing the rope in four rolling surfaces so that it cannot chafe. Two sheaves and two rollers, with their axes at right angles, are also used. Also called a four-way rope guard.

Fall. By common usage, the entire length of rope in a tackle, though a strict adherence to the term limits its application to the end to which power is applied. The end secured to the block is called the standing part, the opposite end, the hauling part.

Fan, Centrifugal. A centrifugal compressor designed for delivery of large quantities of air at a slight pressure above the atmosphere, this pressure usually being expressed in inches of water. The impeller or wheel is mounted on a shaft, and driven directly or by belt from an engine or motor, or by a belt from a line shaft. Air is drawn in at or near the shaft, is whirled by blades on the wheel, and moves radially outward on account of the centrifugal force developed by the whirling motion. It flows into the casing, which is often spiral or scroll shaped and leads the air to the fan outlet by a passage of gradually increasing sectional area.

Centrifugal fans are used largely for producing draft for combustion, for ventilation, and for conveying light fine material which can be easily picked up by a current of air, such as grain, shavings, ashes and cement. They are also much used as exhausters, or where air is to be removed from a space at a pressure slightly below the atmosphere, and delivered to the atmosphere.

Feeder. A machine designed to deliver a more or less uniform supply of bulk material to a conveyor, crusher or other machine, receiving its supply from a hopper or similar bulk container. It replaces the attendant who would otherwise be required to manipulate a gate, and will produce a more even flow than is possible with hand regulation. Some types will measure with considerable accuracy the amount of material passing.

Feeders may be continuous or intermittent according to whether a steady uniform supply or an intermittent supply of equal quantities at regular intervals is delivered; the nature of the machine fed often determines this requirement. Some feeders can be operated either way. Feeders may also be classed as rotary, reciprocating or conveyor according to the character of motion of the principal moving part. Rotary feeders include the roll, rotary paddle, cam, rotating plate, and rotary grizzly; reciprocating feeders include the reciprocating plate, reciprocating bar, shaking, plunger, swinging plate, automatic gate and zigzag feeders; and the conveyor type feeders comprise apron, belt, chain and screw arrangements. Feeders which completely empty themselves are termed self-cleaning; there is no chance for these to freeze up in cold weather. Feeders located directly

under the hopper and carrying the hooper load on a moving part will prevent bridging. Some feeders tend to compress the material and should not be used with materials which pack. A few feeders, especially those supplying a crusher, will perform a rough screening operation. (See Screen.)

Most feeders are fixed in position, but where a moving conveyor must be fed from a number of different points, a traveling feeder that can be moved (or can propel itself) from one position to another is often used.

Feeders are most satisfactorily driven by gears, but where very slow speed with considerable variation is required, a pawl and ratchet driven by a crank and eccentric are convenient. A feeder should be driven from the machine it feeds, so that in case the latter stops, the feeder will also stop and not choke it up. A clutch is also provided so that the feeder can be stopped to allow the succeeding machinery to be emptied when desired, for repairs or cleaning.

Feeder, Apron. A feeder in which a short section of apron conveyor is placed with its receiving end beneath a hopper opening from which it receives material, and which discharges it at the other end into a crusher or elevator, or onto a conveyor. It may slope upward if the head-room limitations require it. Shallow steel pans are used for coal, and heavy overlapping steel plates for ore.

Feeder, Automatic Gate. A hopper or spout discharge gate of the quadrant gate or sliding gate type which is used as a feeder, and is periodically opened and shut by a revolving eccentric of adjustable eccentricity, or by equivalent means. The width of the opening is also adjustable.

The feeder can be operated by the buckets of a conveyor in such a way that it opens and closes at the proper times to fill each bucket passing beneath it.

Feeder, Automatic Screw. A feeder consisting of a section of screw conveyor in a trough immediately below a hopper discharge, and rotated uniformly (subject to adjustment) by power. A gate in the hopper bottom can also be used to control the flow to the screw trough. The discharge is fairly continuous with a single flight, but much more so with a double flight screw. The feeder discharge may be in the end or the bottom of the trough.

Feeder, Belt. A conveyor in which a short section of belt conveyor has its receiving end placed beneath a hopper discharge opening, and its discharge end over the conveyor or crusher which it is to feed. The supply from the hopper is controlled by an adjustable gate. The head pulley is often of the magnetic type to remove stray or "tramp" iron if the feeder supplies a crusher.

Feeder, Cam. A feeder in which a cylinder with pockets having curved walls resembling cam surfaces is placed in a chute of rectangular section, completely obstructing it except for the material carried past in the pockets, when the cylinder rotates on its shaft. If the material flows readily, the pockets will fill so uniformly that the feeder can be used to measure it. (See also Feeder, Rotating Paddle.)

Feeder, Chain. A feeder in which the lower run of a short horizontal drag refuse chain conveyor is used to drag the material discharged from a hopper opening along a horizontal trough, and feed it into a crusher or conveyor. It is driven at an adjustable speed from the discharge end sprockets, and the feed end may be fixed or loose; the latter arrangement allows it to be lifted onto a pile and to dig down into it.

Feeder, Cutting. A device which feeds a bulk material like moist sand from a hopper discharge opening onto a conveyor, consisting of a series of parallel flat bars pivoted vertically on fixed pins at one end, and at the other pivoted on a bar which can be oscillated horizontally. The oscillations of the bars continually cut or slice off the sand which crowds down through the rather large hopper opening.

Feeder, Plunger. A reciprocating feeder located below the discharge of a hopper, and having a horizontal square section plunger operated by a crank shaft or eccentric, arranged to push the material flowing down from the hopper outward along a horizontal plate until it falls off the edge. When the plunger is withdrawn, more material descends in front of it. The length of stroke and number of strokes per minute can be varied to suit the discharge required.

A single plunger gives a regular intermittent feed. If more uniform feeding is required, two plungers actuated by opposed eccentric or cranks may be used (called a double plunger feeder), or three may be used placed at 120 deg.

Also called a push plate feeder.

Feeder, Reciprocating Bar or Reciprocating Grizzly. A reciprocating plate feeder in which the end of the plate is made up of uniformly spaced bars, through which the fine portion of the material will drop; the large pieces carry over the ends. When used to feed a crusher the fine material may by-pass the crusher thus lightening the load on it. When feeding a belt conveyor, it allows the lumps to be deposited on top of the previously laid fine material, thus saving wear on the belt and allowing a somewhat steeper slope; on a picking table this arrangement aids the picking operation. Also called fingered reciprocating feeder.

Feeder, Reciprocating Plate. A feeder consisting of a specially formed hopper bottom beneath which a horizontal plate supported on wheels or rollers or by hinged supporting rods can be moved back and forth. The front end projects over the conveyor or crusher that is being fed; the rear end is sufficiently long to remain always under the hopper. As the plate moves forward, the material on it also moves, partially restrained by an adjustable gate, and fresh material falls in behind it from the hopper. When the plate returns the material on it cannot move back, therefore the plate slides from underneath the part toward the front, and it falls off. In addition to the gate adjustment, the length of stroke and number of strokes can be varied; also, if it is desired to by-pass a crusher, the eccentric rods may be connected to the plate at a point farther back, so that the front end of the plate extends beyond the crusher receiving hopper, to a by-pass opening arranged for it.

A reciprocating plate feeder is sometimes made narrow enough to allow it to be set between the ties of a railway track, receiving the discharge from dump cars and feeding it to an inclined elevator beside the right-of-way. The plate is oscillated by an eccentric driven from the elevator.

Feeder, Roll. An automatic feeder consisting of a large roll on a horizontal shaft, placed under and slightly to one side of a hopper discharge opening in such a position that material will not flow when the roll is at rest, but when it is rotated slowly in one direction, material will be carried over the highest point and discharged to the conveyor or crusher beyond. The rotation is intermittent, by a pawl and ratchet through a variable throw

- eccentric, or is continuous with variable speed. An adjustable gate in the hopper controls the discharge by varying the thickness of the layer passing over the wheel. Cleats are sometimes added to the face of the roll to give a better grip on the material.
- Feeder, Rotary Disc or Rotary Grizzly.** See Screen, Rotating Disc.
- Feeder, Rotary Paddle.** A feeder consisting of a paddle wheel with four rectangular equally spaced radial blades of a length equal to the width of the chute in which it is placed, and with its shaft carried in bearings in the chute sides. The bottom of the chute is slightly depressed under the rotor, which fits it closely. The direction of rotation is such that the quadrant shaped pockets fill and carry over the shaft, discharging into the lower extension of the chute. The feeder may be rotated continuously at a variable slow speed, or intermittently one quarter of a turn at a time; to prevent bridging and to ensure complete filling of the pockets, an agitator is sometimes placed above it. Where the material is very fine, all parts may be made practically dust tight. Instead of four pockets, a cylinder with a single pocket is sometimes used. Either arrangement will feed so uniformly when handling material which flows easily that it can be used to measure the quantity fed. (See also Feeder, Cam.)
- Feeder, Rotating Plate.** A feeder consisting of a slightly inclined disc placed with one side of its top face under a hopper opening, and rotating so as to carry the material continuously out under an adjustable gate to a point where it can be scraped off the disc by diagonal fixed skirt boards. In addition to the variation in the thickness of the layer made possible by the gate, the speed of rotation can be varied.
- Feeder, Shaking.** A feeder in which a slightly inclined plate or pan is suspended beneath a hopper opening in such a position that, when at rest, material cannot flow from the hopper over the end of the pan, but when shaken horizontally by rotation of eccentrics, the material will move uniformly down the pan and over its edge. The rate of feed depends on the number of oscillations, their stroke, and the inclination of the pan; the two last are the ones varied in most installations. Owing to its inclination, this feeder is self-cleaning, and is therefore advantageous in freezing weather.
- Feeder, Swing-hammer Regulating Gate for.** A gate for holding back the flow of unsized material from a hopper to a feeder, consisting of a row of heavy pendulums or hammers, which are easily deflected by large lumps contained in the material and allow them to pass without damage to the gate. This form is sometimes substituted for the more common solid sliding gate controlled by a lever or rack and pinion.
- Feeder, Swinging Plate.** A feeder similar to the plunger feeder, but having instead of the sliding plungers, one or more plates hinged at the top to the feeder frame, and swung back and forth by eccentrics connected to their lower edges. The material descends from the hopper in front of them; as they alternately swing forward they push it forward, and on their return the space made vacant is filled by the descent of fresh material.
- Feeder, Traveling.** A feeder which is mounted on wheels running on rails, and can be drawn or self-propelled to any desired point for operation. (See Hopper, Traveling; Hopper, Belt Feeding.)
- Feeder, Traveling Grizzly Bar or Traveling Bar.** See Screen, Traveling Bar.
- Feeder, Zigzag.** A feeder intended for materials like clay, consisting of a set of heavy steel bars placed at the bottom of a hopper and supporting the weight of the contents. They are given a zigzag motion by connection to an external rocking member, which exerts a shearing action on the clay and allows it to fall through. Stones and frozen lumps are not thus sheared, but remain on top of the bars where they cause no harm to the succeeding machinery, and are removed by hand when the feeder is emptied at convenient intervals.
- Felloe.** The circular rim of a wooden wheel, into which the outer ends of the spokes are inserted.
- Ferrule.** A short cylindrical tube fitted on the end of another tube or cylinder of steel, wood, etc., to reinforce it or to prevent undue wear. Ferrules are often combined with caps or discs covering the ends of the part in question, and occasionally have an axially or radially projecting flange. A good example of the latter is in the type of roller used in roller conveyors for handling brick.
- Fines.** The name given to the finer material in screening operations, especially to the smallest of the material which passes through a given mesh or perforation mixed with other sizes up to the maximum allowed by the openings of the screen.
- Fish-bellied.** The term applied to a beam when the depth is decreased toward the ends in order to approximate a beam of uniform strength. The top of the beam is usually straight and horizontal, the lower outline curves upward toward the ends, the shape being approximately that of a parabola with the axis vertical.
- Fittings, Pipe.** The term applied to the various connections, outlets and other attachments for pipe, excluding valves.
- Flange.** The turned edge of a rolled structural shape. Also a circular plate with thickened hub around a hole in the center, used for coupling pipes or shafts. Also the flat rim around an opening in a casting, for attaching another part or a cover, as a cylinder flange.
- Fleet.** A term applied to the passing of a rope through a machine or around a sheave, as opposed to fastening or dead-ending it. A rope fleets through a grab bucket when the latter is suspended in the bight of the rope; it is dead-ended in it when it is made fast to some part of the bucket.
- Flexible Coupling.** See Coupling, Joint, Shafting, etc.
- Flight.** The part of a flight conveyor which comes in contact with the material or package conveyed, moving it by reason of its connection with the conveyor chains or cable. Also, the helical portion of a screw as used in a screw conveyor, comprising one complete turn. Also, a succession of steps on which persons may ascend or descend, as a flight of stairs.
- Float.** A floating platform or shallow scow-shaped boat with a deck, used as a landing platform. Also, such a craft used around shipping for miscellaneous work purposes, such as painting. (See also Float, Car.)
- Float, Car.** A large full-bodied or scow-shaped boat with a level deck on which rails are laid for carrying railway cars, and which is used as a means of ferrying them from one railway water terminal to another. Generally without means of self-propulsion; if this is provided, it is called a ferry.
- Flow Diagram.** A diagrammatic representation of the paths taken by a material and its various subdivisions as it passes through a plant in which continuous operations are performed on it. Flow diagrams are often made out

for crushing, screening and washing plants, cement plants, brick plants, etc.

Also called flow sheet.

Foot Block. The metal fitting secured to the foot of a derrick mast. (See Derrick Bottom.)

Footway or Footwalk. A platform or passageway arranged to allow the passage of people walking. In overhead crane structures footways are placed where needed on the bridge to provide accessibility to the machinery. Footways are also often arranged along conveyor runways which would otherwise be inaccessible, as on bridges over yards or streets, or in tunnels.

In some types of overhead cranes having load ropes both inside and outside the bridge girders, footways on the bridge are impossible, and access to the bridge for care and repairs is had by running it to a permanent platform built at one end of the runway.

Fork. A device operating like a clam-shell grab bucket, but with curved tines or fingers substituted for the usual shells, and used for handling material which would be damaged by the closing action of solid cutting edges (see Coke Fork), or which is more easily penetrated by the separate tines, as manure, etc. Usually of the power wheel type, but also often built like tongs.

Foundation, Crane. The base support of masonry, concrete, timber, piling, etc., on which is built the permanent structure of a fixed crane, or the runway or track of a traveling crane.

Derricks and other guyed cranes must have foundations simply to carry the greatest vertical load likely to come on them. Pillar and other non-guyed cranes must have foundations not only sufficient to carry the total load, but also widely enough distributed to prevent overturning, and on firm enough soil so that there will not be settling under one edge when lifting a large load at a considerable radius.

Traveling cranes within building structures, or outside and adjacent to them, often have no foundations independent of those of the building itself, which are made larger to accommodate the increased load.

Friction. The rubbing of the surface of one body against another; the resistance to relative motion by sliding or rolling of two bodies in contact with each other.

The laws of sliding friction cannot be stated with definiteness because of the extreme variations under differing conditions. Under the one extreme condition of absolute dryness, it is usually stated that frictional resistance is proportional to the normal load or total pressure, is independent of the extent of the surfaces but dependent on their nature, and decreases as the relative velocity increases. An example is a brake shoe, where the decelerating force is independent of the area in contact, and is least when the speed is highest.

Under the other extreme condition, called perfect lubrication, when the actual metallic surfaces are supposed to be separated by a film of oil at all times, it appears that the frictional resistance is independent of the load, varies with the area of the surfaces in contact, is independent of their nature, and increases with the relative velocity. It is also markedly dependent on the character of the lubricant.

Therefore, when no lubricant is used, the nature of the rubbing surfaces is important; when perfect lubrication is obtained (produced by "flooding"), the nature of the lubricant is most important, and for intermediate conditions, covering the great majority of practical cases, both are important.

Friction, Coefficient of. The ratio of the frictional resistance between two bodies or the force which must be applied in order to make one of them slide on the other, to the force with which they are pressed against each other. This varies from as much as 0.5 when leather and wood or metal are pressed against each other with no lubricant, to as little as 0.001 for polished metals supplied with oil in such a way as to form a film which separates the surfaces.

Friction Gear. Any gear which runs loose on its shaft, but which may be made to turn with it by a friction clutch connecting the two when properly engaged. One part of the clutch is carried by the gear, and the other by a hub keyed to the shaft. (See also Clutch, Friction; Drum, Friction.)

Frog, Monorail. A cast or forged piece connecting two monorail runways to a third in such a way that the trolley may be run from either of the two onto the third, or reverse. A steering device must be used on approaching the frog on the single runway to force the trolley to run as desired. (See also Switch, Monorail.)

Gage. A standard of measure; an instrument for measuring height, pressure, form, dimensions, etc., as pressure gage, water level gage, wire gage, plug and ring gage, thread gage, track gage.

Gage, Track. The distance between the inside of the rail heads of a railroad. The standard gage is 4 ft. 8½ in. Narrow gages vary from 2 ft. 6 in. to 3 ft. 6 in., 3 ft. 0 in. being common. Broad gages are used for special machines, traveling cranes, transfer tables, etc.

Gantry. (Common abbreviation of Gantry Crane.) A crane whose principal structure consists of a horizontal bridge or girder carried at a considerable height above the ground on runways supported by A-frames at the ends, and spanning railroad tracks, storage yards, etc. The A-frames may rest directly on the ground, giving a fixed gantry, or may be supported by wheels on rails and be capable of self-propulsion, giving a traveling gantry. Means are provided for propelling the two ends at the same speed. (See Bridge Drive.)

The gantry may have a trolley running on the bridge, carrying a hoist; this is the most common form and is what is generally meant by gantry crane. The gantry may instead carry on its bridge, either fixed in position or on a travelling carriage, a stiff-leg derrick, a rotating pillar or jib crane or a hammer-head crane, etc., giving rise to many different forms.

Both legs are commonly the same length, designated as full portal gantry. Occasionally one leg is eliminated by running that end of the bridge on a runway along the side or on the roof of a building, giving a semi-portal gantry. The legs are also sometimes unequal in length, to suit the slope of the ground or other demands, or a gantry with short legs may travel on moderately elevated runways.

(Also called Gantry Crane, Bridge Crane, Bridge Gantry, Frame Crane.) Page 167, 793, 797, 798.

Gantry, Bridge. See Gantry, Cantilever Bridge.

Gantry, Cantilever. A gantry in which the bridge is continued into an overhanging portion beyond the A-frame support on one end (single cantilever) or on both ends (double cantilever). The cantilever ends may be short as compared with the span of the bridge, or may be very long, in which case it is sometimes called a shipyard gantry, from its usefulness in ship construction. The cantilever ends are often unequal in length. The end frames must be open if the loads picked up on the cantilever end are to be run inside; to secure the neces-

sary stiffness, the two sides of the A-frame end are then run up and tied together at the top, high enough to clear the trolley. In many cases the range of trolley travel is entirely outside the supports, which are then relatively close together and are braced to each other, giving a tower with a gantry base.

In some shipyards where side launching is practised, the gantry cranes run on three lines of supports ordinarily, one line being between the ship and the water. This is removed during the launching period, and the span is thus temporarily converted into a cantilever.

Page 169, 797-798.

Gantry, Cantilever Bridge. (See also Gantry, Cantilever.) A term sometimes applied to a cantilever gantry crane, especially one in which the bridge span and cantilevers are very long, and are of trussed construction like ordinary bridges. They are used where very large areas must be served, but where the customary load is comparatively light, as in coal and ore handling and storage. (Also called Ore Bridge. See also Crane, Bridge Storage.) Page 169, 797-798.

Gantry, Fixed. A gantry which is fixed in location. When supplied with a trolley on the bridge and a hoist, it is often called a transfer crane, and is much used for transferring loads between cars and trucks in freight yards. (Also called Transfer Gantry, Railroad Crane.) Page 169.

Gantry, Floating. A double cantilever gantry crane of large capacity and high lift, installed on a barge or pontoon. The gantry bridge is supported on four or more braced legs along the sides of the pontoon, and the cantilever extensions at the two opposite ends allow a load to be raised from a dock or ship, moved inward, and deposited on the deck of the barge. The operation is reversed to lower a heavy weight into a ship.

The free deck of this type of floating crane is a great advantage for storage purposes, but owing to the limitation of the trolley to straight line motion only, the crane must be warped along the side of the vessel or dock to properly locate the load, and this is often a disadvantage. (See also Crane, Floating.)

Gantry, Folding Jib. A travelling cantilever gantry with one (or both) of its cantilevers hinged close to the inner end so that it may be raised into a vertical position and leave the space alongside the crane absolutely clear. This enables the crane to be run past an existing structure, which would otherwise block it, or, if used alongside a dock as a cargo or fitting-out crane, allows the ship to be warped into position without the interference that would exist between the fixed cantilever arm and the stacks or rigging of the vessel.

Gantry, Full or Full Portal. An ordinary travelling gantry with two legs of equal length, so called to distinguish it from a semi-portal gantry. (See Gantry.) Page 169.

Gantry, Half. See Gantry, Semi-portal.

Gantry, Rotary Jib. A gantry crane carrying a jib which may be rotated about a vertical axis. The jib, which is fixed in inclination, and is generally horizontal, may or not carry a trolley. In some cases the turntable on which the jib is mounted is itself on a carriage traveling on rails along the gantry bridge.

Page 197.

Gantry, Rotary Tower. A tower gantry in which the load-carrying element may be rotated about the vertical. (See Gantry, Tower.)

Page 197.

Gantry, Semi-portal. If one of the two runways of a travelling gantry is elevated close to the bridge, so that the usual A-frame support on that end is missing, it is called a semi-portal, single leg, one leg, or half gantry. This construction is generally advantageous when a building wall or other existing structure can be utilized at one end to support the elevated runway.

Various forms of handling gear are used on semi-portal gantries, the most usual being the ordinary rotary pillar crane with geared drum winch, either fixed in position on the bridge, or on a wheeled trolley, the latter being the more common.

Page 190, 191.

Gantry, Shipyard. See Crane, Shipyard. Cantilever gantries in shipyards generally travel on elevated runways; tower gantries on widely spaced rails on the ground.

Page 197.

Gantry, Tower. A crane which is mounted on a tower-like structure with a gantry base, the tower being used in order to obtain a high lift, and the gantry base in order to allow a track to pass beneath it to bring material to it.

(See Crane, Tower; Crane, Shipyard.)

Page 201.

Gantry, Traveling. A gantry which is capable of self-pulsion along rails. To allow for inequalities of the track, a three-point support of the bridge is sometimes used, and a pivot connection between the bridge and one of the supporting towers prevents distortion in case one end of the bridge gets ahead of the other. (See also Gantry.)

Page 167.

Gantry, Rotary Bridge. A gantry crane in which one leg is fixed in position or pivoted so as to rotate about a vertical axis, while the other leg travels on a rail at the circumference of a circle of which the length of the bridge is the radius. A trolley on the bridge enables any part of the circle to be reached. Used for storage work.

Page 169.

Gantry Base. A base formed like a gantry, or with a cross structure supported by legs or frames at the ends. This term is used in connection with elevated or tower traveling cranes, etc., in which the structure usually spans tracks on which cars are used to transport the material to the crane.

Gantry Crane. See Gantry.

Gasket. A ring or sheet of packing material by which a flanged or faced joint is made water, steam, air or oil tight. The materials used are rubber, canvas, asbestos, paper, sheet lead, copper, etc.

Gate. A device used for controlling or stopping the flow of material in a pipe, spout, chute, trough or other channel, consisting of a body or frame set in or attached to the channel walls, a gate which enters or cuts into the material edgewise or slides edgewise across an opening through which the material passes, and suitable mechanism for operating the gate. The latter may be flat and slide in straight guides generally at right angles to the direction of flow (see Gate, Sliding) or it may be curved or cylindrical in form and swing about a fixed axis which is also at right angles to the direction of flow. (See Gate, Quadrant.)

Both forms are used for handling fluids in pipes, though the sliding gate, or so-called gate valve, is much more common than the quadrant form in these places.

(See also Valve.) Both forms are also much used for handling in bulk finely divided solids, which will flow readily.

They are placed in the side wall of a bin near the bottom, or in the bottom of the bin, known respectively as side discharge and bottom discharge.

The terms gate and valve are used somewhat indiscriminately, but the former is best restricted to cases where the part which cuts off the flow moves edgewise into the stream, or where it swings on hinges like a door. (See also Valve, Cock.)

Gate, Ash Bin or Ash. A gate discharging downward from the bottom of a hopper. It is usually of the duplex quick opening quadrant type, with a clear opening of at least 24 in. by 24 in. to prevent arching and to discharge the largest clinkers.

With side discharge ash hoppers, sliding or simplex quadrant gates are used; all material which will not flow out is drawn with a hoe.

Gate, Automatic Feed. See Feeder, Automatic Gate.

Gate, Clam-shell. A duplex quadrant gate. (See Gate, Quadrant.)

Gate, Concrete. A gate used for controlling the flow of concrete from hoppers, spouts, etc. Both the sliding and quadrant forms are used, with the especial requirement that they should be grout-tight.

Gate, Conveyor Trough. A gate for controlling the discharge from the bottom of a trough in which a screw or a drag conveyor operates. The most common form is a plain flat sliding gate, moving transversely or longitudinally with respect to the trough, in guides formed in a casting bolted to the bottom of the trough, and operated by a hand lever or some form of gearing. If it is important to have the cylindrical form of the bottom of a screw conveyor trough maintained throughout, the gate may be curved to fit it, and slide longitudinally. Another method of obtaining the same result is to have a pair of swinging gates or curved leaves pivoted on opposite sides of the trough (to the curve of which they are fitted) and meeting on the center line underneath. When these are swung down, they uncover a large opening in the bottom of the trough and allow the material moving along it to drop through. This form of gate has the additional advantage of an opening extending so far up on the trough sides that no material can be carried over the opening on account of the tendency of the conveyor to crowd the material up against one side.

Gate, Flap. A swinging gate located between two bottom openings in a two-way hopper, to allow the discharge to be directed through either at pleasure. Flap gates are similarly used at Y-branches in spouts, and at discharge openings in the bottom of chutes.

Gate, Quadrant; Gate, Cylindrical. A gate used for controlling the flow of loose material in a chute or spout, or the discharge from a hopper or bin, and consisting of a hollow partial cylindrical portion which cuts into the material edgewise along the diameter and forms the gate proper (also called leaf or spade). This is supported by circular sectors cast with it at each end and mounted on pivot or on a through shaft which is generally located at the center of cylinder curvature.

For flow in inclined chutes, the quadrant gate may be so placed that, when closed, it will hold back the material in contact with the inside or with the outside of the cylindrical portion. It may also be arranged to cut downward into the stream of material, called an overcut gate, or may come up from beneath the stream, called an undercut gate.

In vertical spouts or chutes the convex sides of the cylindrical leaves may be turned upward or downward, but the terms overcut and undercut are not applicable. One leaf may be used, termed a simple, single or simplex gate; two leaves may be placed symmetrically and connected by gearing so that they will close simultaneously from opposite directions and meet at the center of the spout, termed a duplex gate. This form possesses the property of giving a central discharge, whatever the amount of opening.

The quadrant or cylindrical form of gate is also used as a side discharge ash hopper gate, the leaf swinging upward to open, leaving a clear opening for the flow, assisted if necessary by a hoe in the hands of the attendant.

Quadrant gates may be operated by hand through levers, hand chain wheels or worm gearing; steam or air may also be used in a pressure cylinder connected to a lever on the leaf.

Also called arc gate, swinging valve (side or bottom according to location on bin), cut-off gate, pivoted gate and radial gate.

Gate, Rack and Pinion. A sliding gate which is operated by turning a handwheel on a shaft with one or two pinions which engage with a corresponding number of racks attached to the gate or to an extension of the gate.

Gate, Simplex. See Gate, Quadrant.

Gate, Sliding. A form of gate in which a flat plate (sometimes braced or ribbed for stiffness) slides edgewise in guides to control the flow of fluids in a channel, by reducing or cutting off the area for flow. Such gates may be easily made water tight, and are much used for handling water flowing in channels for hydraulic power purposes. They are also used for controlling loose bulk material flowing from bins, hoppers or storage pockets, or from the troughs of screw, flight and drag conveyors.

The guides may be fastened separately to the wall or bottom, or may be formed on part of a solid self-contained frame. The edge of the door may be plain and fit into a plain groove in the guide; returns may be made on both door and frame, and hooked into each other; or by returning the guide through an additional 90 deg. it may be adapted to fitting on the inside of a rectangular spout or chute. A short chute, called a lip chute, is often formed on the outside of the guide frame.

The gate may be operated by direct hand pull, by a lever operating through a long rod from a distance if desired, by a hand chain or wire rope wheel, or by single or double rack and pinion gearing. If located in the side wall of a bin, a pawl is often attached to the gate and notches are cut in one of the guides; engaging one in the other will hold the gate open at any desired point.

Vertical gates generally open upward. Horizontal gates, as in trough bottoms, may open longitudinally or transversely; the latter has the advantage that if there are a series of such discharge openings, graduated partial opening of several gates will allow simultaneous discharge in all, which cannot be done with the longitudinal opening.

An exception to the usual flat gate is found in the curved form used in the bottom of conveyor troughs (see Gate, Conveyor Trough). Occasionally the gate is formed like a disc, and instead of sliding in straight guides, is pivoted about a point outside the channel (usually a pipe or spout) in such a way that it moves edgewise to cut off the flow.

Gate, Swinging. A form of gate in which one leaf, or two leaves placed symmetrically, swinging on hinges like a door or the gates of a canal lock, are used to close a channel or opening through which fluids or loose solid material may flow. As it is often difficult or impossible to open or close them while flow is taking place, they are not much used as control gates for material handling. (See Gate, Conveyor Trough; Gate, Flap.)

Gate Valve. A form of valve fitted in a pipe for conveying fluids, in which the opening is closed by the edge-wise sliding of a part called the gate, moving in guides cast in the valve body. The gate proper is opened or closed by a stem passing out of the valve through a stuffing-box; the stem may be smooth, and operated by direct push or pull exerted by a lever, or it may be threaded through a nut, and operated by a hand wheel.

Gathering Box. Gathering Basket. A box or basket placed on a low truck and moved about until loaded with a desired assortment of small articles, a complete order, etc., when it may be disposed of as a unit. If built in a suitable form a number may be nested when empty.

Gattie System. A system that has been proposed as a substitute for the numerous scattered and badly congested freight stations in London, comprising a combination of a large central terminal clearing house for incoming and outgoing freight, with a demountable body system for holding the freight, these bodies being transferred from motor truck to clearing house, clearing house to railway car, or car to car, as required.

The body proposed is of a size suitable for occupying the full capacity of one of the small British freight cars, and capable of being lifted bodily by eyes set permanently in the top. Doods in the sides, ends or top are provided. A fleet of trucks, each capable of carrying one of these bodies, operates in conjunction with the clearing house, bringing to it bodies loaded for a single destination, or containing miscellaneous freight without any attempt at sorting. They also deliver freight from the clearing house to its ultimate destination. Pieces too large in any dimension to go into a body are handled separately or in bundles, but are to be suitably arranged for lifting by a crane.

The Clearing House proposed for London is an extensive rectangular building of seven freight-handling floors, with an eighth for offices, shops, etc. The rail level is one floor below the road level; here twenty-two parallel tracks receive all the railway freight traffic by electric haulage. Parallel to these tracks, and at intervals among them, are four trenches or gaps, running the full length of the building, and furnishing four openings through which bodies may be lowered to or raised from the lowest floor or crypt, as the inventor calls it, by numerous overhead traveling cranes. Transversely across the space above the rail level is a series of twelve equally spaced roadways on to which motor trucks may be driven from the street, to have bodies mounted or removed by the cranes overhanging them, each crane spanning half the roadway and extending an equal distance beyond its edge over the tracks beneath. Above this roadway level in succession are a lower small package sorting floor, a lower main package sorting floor and a floor for workshops and offices. The complete areas of the two main sorting floors are overhung by traveling cranes, which can, through suitably placed wells, lift loaded or empty bodies from a railway car on the track level or from a motor truck on one of the roadways, or lower them; or, by a transfer, move them to or from the crypt.

On the crypt floor and each of the sorting floors there is an automatic conveying system consisting of an endless line of uniformly moving cars called truckers, that in the crypt being capable of handling fully loaded bodies, and those on the small package and main sorting floors being capable of handling 50 lb. and 1,500 lb. loads respectively. The truckers are four-wheel platform cars, electrically driven at a uniform speed, with their platforms on the same level as the floor. These truckers form on the sorting floors a continuous rectangular main runway around the outside of the whole floor, traveling at six miles per hour, with six transverse rectangular divisional runways within it, traveling at three miles per hour, having their short ends adjacent and parallel to portions of the main runway for a short distance, thus furnishing transfer points at which loads can be transferred from one to the other. The transfer system in the crypt floor consists of two oppositely moving lines of truckers in each of the previously mentioned trenches, each line returning in a loop under the lines of rails at each end of the clearing house. These crypt truckers are much heavier than those on the sorting floors, but are operated in the same manner, and serve to move loaded bodies longitudinally; for transverse movement the crypt floor is completely overhung by a series of traveling cranes.

The area of a sorting floor, minus the space occupied by wells, conveying systems and elevators, is divided into transverse sections by the divisional conveyor runways; each division is again divided transversely into bays by alleys, along which are placed slowly moving uni-directional hand-controlled live roller conveyors, which can receive from a divisional belt at one end and deliver to one at the other. By an elaborate magnetic roller transfer system, controlled by a selective destination mechanism, parcels placed on a standard tray on any alley and rolled to its junction with the divisional runway, can be automatically loaded on to the latter and carried to any other bay on the same divisional runway and there discharged, or, if the destination is more remote, can be carried to a transfer point, where it is shifted to the main runway, by it carried to the proper divisional runway and transferred to it to be carried by this divisional runway until it reaches the proper bay, and there discharged. There is thus no moving about of men with trucks, all operators occupying definite stations. Large pieces of freight are handled on the main sorting floors, by the crane if desired. Small pieces are moved by hand. Automatic freight elevators carry material among the different sorting floors, according to the dispatcher's setting of the selective mechanism.

Loaded bodies with miscellaneous freight collected from the city and outgoing, are hoisted directly from motor trucks to an empty bay or one that is not busy on one of the sorting floors, and there opened, and the contents distributed as described. As this is going on all over the building, freight is being collected at every point as well as being distributed from every point, so that there is soon enough to fill the empty body; it is sealed, marked and lowered to place in a truck, freight car, or to the crypt, to be held for a few hours until a train is available.

Loaded bodies may be transferred directly from the cars of one line to those of another, making use of the crypt only in case of delay. Incoming bodies with mixed goods for London are sorted in the same manner as outgoing freight, the bays being designated according to districts or delivery routes. Empty bodies may be held

in the crypt to provide for need at a later period in the day. Merchants shipping in full body lots would have facilities for handling them, and motor trucks would merely exchange bodies, removing a full one and delivering an empty, or vice versa.

Other freight stations in the country would be equipped similarly to London, on a scale commensurate with their needs. Small local freight stations might be provided with merely a siding, and the body, remaining on the car, would be unloaded and loaded like an ordinary box car. Or, a simple transfer crane would be provided for lifting the body on to a fixed platform, allowing the car to be removed. (See Demountable Body System.)

Gauntree; obsolete spelling of gantry.

Gear. A comprehensive term including all the equipment involved in performing a certain operation, as Hoisting Gear, Coaling Gear, Cargo Handling Gear.

Gearing. A mechanism used for transmitting motion from one rotating part, such as a shaft, to another similar part, by means of the rolling of a surface of cylindrical, conical or other more complicated form, attached to the first shaft, upon another surface mounted on the second shaft. The rolling surfaces may be actual, as in friction gearing, or imaginary, or replaced by intermeshing teeth and spaces formed on bodies attached to each of the shafts, and shaped so as to produce a motion equivalent to that given by the rolling surfaces; the latter is termed toothed gearing. The teeth of gearing are said to mesh with each other.

Friction gearing includes rolling cylinders or cones pressed against each other, and belting. Toothed gearing includes spur, bevel, spiral or helical and worm gearing, as well as gearing in which toothed wheels are connected by chains, known as chain gearing.

If the two gears of a pair differ greatly in size, they are sometimes termed reduction gears, and one is called the pinion and the other the gear or sometimes the wheel. Gears in which the teeth are cut inside a rim are termed internal gears, or annulars. Shrouding is the term applied to the connecting plate or ring between the ends of the teeth of the gear at one or both ends of the gear teeth, and is termed full or half shrouding, depending on whether this ring extends to the top of the teeth or only half way.

The curves of gear teeth must be formed so that they will move smoothly upon each other and give a constant velocity ratio between the two wheels during the time they are in contact; technically speaking, they must be conjugate curves. Several systems of curves are possible, but only two are widely used, and one of these, the cycloidal system, is gradually becoming obsolete except for large cast gears. The common system is the involute, in which the tooth curves are involutes formed from a circle somewhat within the pitch circle of the gears, and termed the base circle. The involute form of tooth has the advantages that it is easy to cut, has no reversal of curvature, and the center distance of the shafts can be altered slightly without destroying the proper action of the teeth, thus requiring less accuracy in setting than other forms of gears.

By selecting a proper method of determination of the base circle, sets of involute gears can be made which will be interchangeable among themselves, so long as they are of the same circular pitch. Such interchangeable gears are widely used. Cycloidal interchangeable sets may also be made. There are slight differences in

the standards of different manufacturers, and it is not wise to mix their gears.

The teeth may be cast to form with the rest of the gear, or they may be cut from the solid material of the blank. A less used process is that of rolling teeth into a hot blank. Teeth may be cut from the solid by milling, planing, shaping or hobbing. The process may be one which depends on the form of a curved outline cutter for its accuracy, termed the formed cutter method, or it may be one where the tooth outline is generated by a machine using as a cutting tool an edge of simple form, such as a straight line, and manipulating it so as to produce the theoretically correct tooth form, within the limits of accuracy of the machine. The latter is termed the generating method.

Various materials are used, the most common naturally being cast iron, forged iron, cast steel and brass.

Small gears or pinion have a weaker tooth form than large gears and receive the greater wear, so it is often desirable to make them of better material. Cast teeth should not be mated with cut teeth. The so-called silent or noiseless gears have their teeth cut in compressed paper, fibre, rawhide, muslin, bakelite, etc., and are generally mated with a metal gear, preferably not a cast iron gear. The non-metallic material is generally held between metal end flanges, which prevent the edges from beating down.

Wood teeth, forming what are termed mortise gears, were formerly widely used, and still are in demand in certain places. Hardwood blocks are set into slots or mortises in the rim of the wheel and are held there by keys or pins; they are then shaped to a tooth form by suitable machinery; each mortise gear generally mates with a metal pinion, and very high peripheral speeds are possible, coupled with quiet running.

Gears are generally circular, but occasionally elliptical gears are used to give a non-uniform velocity ratio; lobed wheels, or wheels with wavy pitch lines, are sometimes substituted for circular pitch lines where an irregularity is desired. (See Equalizing Drive.)

It is becoming almost universal to enclose gears which are transmitting considerable power at high speed, in a dust-proof and oil-retaining housing, so that they will operate with less friction and wear, require less attention, and have longer life.

Gearing, Bevel. A form of gearing used for connecting shafts whose center lines intersect, consisting of truncated cones in contact along a common element and with their apexes located at the point or intersection of the shaft center lines. The most common case is where the shafts are at right angles; if the two gears are equal, they are called miter gears. If the shafts are not at right angles they are often called angle gears, and if unequal, angle reduction gears.

Bevel gears do not run so quietly or efficiently as spur gears on account of the great difficulty of shaping their teeth and installing them so that the teeth will bear the full length of the face. Provision must also be made to care for the thrust on each of the gears of the pair.

Two shafts whose center lines intersect at right angles may also be connected by means of a spur pinion meshing with a crown gear, which is a flat-faced gear, or disc, with teeth formed on one side.

Gearing, Chain. A system of gearing for connecting parallel shafts by means of wheels fixed to them and having an endless chain belt passed around them. The wheels are sometimes smooth-rimmed, and are termed traction wheels; they allow slipping, which is sometimes

desired, to prevent breakage due to excessive loading. Oftener the wheels have the rims formed with projections, which engage the chain links and prevent them from slipping, thus maintaining a constant speed ratio or a positive drive between the two shafts. If ordinary close oval link pitch chain is used, the wheel rim has cavities in which the links seat themselves, and is called a pocket wheel; with longer link oval chain, the wheel may have teeth projecting outward through the centers of the links which lie flat, and is termed a sprocket or toothed sprocket; practically all chains made up with hinged joints require sprockets.

This form of gearing is largely used in conveying machinery in the form of endless belts passing around wheels on head and foot shafts, one of which acts as the driver, and moving material resting directly on the chains or on platforms or in buckets attached to the chain.

Gearing, Duplex. A name sometimes applied to arrangements in which two speeds of the driven shaft are possible by shifting a lever and throwing different gear trains into action. Also called two-speed gearing, gear shift, etc.

Gearing, Equalizing. Gearing which has some irregularity of motion intentionally introduced in order to counteract an irregularity arising from some other source. (See Equalizing Drive.)

Gearing, Friction. Gearing in which motion is transmitted from one rotating part to another by means of the friction generated by pressing one against the other. For this service it is natural to choose materials which have a high coefficient of rubbing friction. These include paper, fibre, rubber, leather, wood, etc. One of the two parts, preferably the driven one, is made of cast iron, as it will not be so easily grooved if stalled by excessive load while the driving part continues to rotate against it.

Friction gears are made in the form of cylinders, sometimes called spur frictions, because they function the same as spur-toothed gears. They are also made as bevel gears, either miter or reduction. The fibre, paper or other material is made in the form of a filler which can be bolted between end flanges of metal, and is renewable when worn.

Considerable pressure between the wheels is necessary, and in transmitting large powers this causes excessive bearing losses. On account of this pressure, friction gears should not be overhung on their bearings. Cylindrical friction wheels may have circumferential ridges and grooves wedging into each other, and giving the effect of large friction without the excessive bearing pressure required with smooth surfaces. These grooved friction wheels, always made of metal, rub considerably and show wear at the points of contact.

Friction gearing lends itself to easy disengagement if the shaft of one of the members is mounted in an eccentric bearing box, which can be rotated within the bearing by a lever, thus moving one friction wheel away from the other. By an extension of this principle, a further rotation of the lever can be made to press the rotating part against a brake shoe on the opposite side, for controlling its rotation.

Gearing, Helical. A type of toothed gearing used for connecting two shafts which do not intersect, and which have teeth that are helical in form, or twisted, relative to the elements of the pitch surface. They may be of the bevel form, but are ordinarily cylindrical. The shafts may be parallel, at right angles, or at any inter-

mediate center angle; in the first case, the action is much like that of ordinary spur gears, except that it is smoother. The ratios of the shaft speeds may be equal or unequal; the special case of the shafts at right angles and with a very large speed ratio, is generally termed worm gearing. (See Gearing, Worm.)

Herringbone gearing is often used with parallel shafts in place of plain helical gearing, to eliminate the end thrust. It consists of two sets of helical teeth sloping in opposite directions, and either meeting or closely approaching each other along the median line of the gear. Sometimes they are separated by a groove, for convenience in cutting, and if staggered in addition, make what is often called a Wuest gear. The two portions may be cut separately and assembled in contact, or separated, as desired. If the teeth meet in a point, casting is the only practical method of production, otherwise they may be easily cut. Herringbone gears run smoothly and are strong. They also tend to wear in such a way that the action eventually becomes nearly pure rolling, with a minimum of loss by friction of the rubbing tooth surfaces.

Where the shafts are other than parallel, the velocity ratios are inversely as the numbers of teeth on the two gears, but are not inversely as the diameters of the gears.

Helical gears (except the herringbone form) develop thrust along the shaft, and provision must be made for it. They are not of high efficiency as a rule, and should be avoided where the same mechanical effect can be obtained by simpler forms of gears, unless their compactness is important.

Gearing, Spiral. A term rather commonly applied to helical gearing.

Gearing, Spur. The common form of gearing, used for connecting parallel shafts, and having teeth formed on the circumference of short cylinders rolling in contact with each other. It is the simplest form, can be made high in efficiency, and is widely used in hoisting machinery.

The minimum limit on the size of pinions is about 15 teeth for the cycloidal system and 25 teeth for the involute or common system. There is no maximum limit, the gear of infinite radius being a rack, in which teeth are cut on a straight bar. Teeth may also be cut on the inside of a rim or ring; this is called an internal or annular gear.

Spur gears usually have a hub and are mounted on a shaft; occasionally the teeth are cut on a large ring which is secured to the outside of a cylinder like a car dump or revolving screen, to rotate it by power, and the gear is called a ring gear. It is often split for ease of attachment.

Cylindrical friction gears are occasionally incorrectly termed spur frictions.

Gearing, Train of. A combination of gears on several shafts, all meshing and having a definite relation between the speed of the driving and that of the driven gear, is usually termed a train.

Reduction gearing is a train arranged to reduce the speed of the driving shaft to a lower value at the driven shaft. A single reduction means a pinion or small gear on the driving shaft meshing with a larger one on the driven shaft. A double reduction means that in addition to the above, there is another pinion fast to the same shaft as the gear, and driving a gear on the final driven shaft; the auxiliary shaft having the gear of the first pair and the pinion of the second pair is termed the intermediate shaft. Second and third intermediate shafts

may be added, giving triple and quadruple reduction gearing. Such trains are much used in hoisting machinery.

Reduction gear trains, mounted in a housing or on a base so as to be self-contained, are often termed speed-changers or speed-reducers, and are on the market in standard forms, ready for coupling between a motor and the machine it is to drive, with any desired speed reduction (or increase).

When the speed ratio is to be varied, change speed gearing is used, generally enclosed in a housing and shifted by means of one or two levers. This device is similar to the transmission of an automobile, from which it has been adapted to stationary power uses. Also called variable speed gearing, change gear box, transmission gearing, etc.

Reversing gearing is a train arranged so that with a driving shaft always rotating in one direction, the driven shaft may be rotated in either direction at will. This can be accomplished with a swinging or sliding frame or equivalent device by which either one or two idlers may be inserted in the train at will, but if this involves unmeshing and remeshing of gears while they are moving, it is dangerous. In place of this, the driver may continuously turn two adjacent shafts in opposite directions, and a friction or jaw clutch may be used to connect the driven shaft with either as desired; this mechanism is conveniently worked out with bevel gears.

An epicyclic or planetary train of gears is one in which the centers of some of the gears have a motion of revolution about a fixed center, while they are rotating on their own axes in addition. The motion of the driven shaft is thus the resultant of motions from two drivers, and large velocity ratios are possible with the use of only a few gears. These planetary trains are, therefore, much used in hoisting mechanisms, especially in chain hoists, to accomplish the transformation of a small pull on the hand chain over a great many feet to the lifting of a large load through a small height. (See Hoist, Planetary; Hoist, Differential.)

Differential gearing is the term applied to a device inserted in the axle of a vehicle, to enable it to pass around curves without slipping on one or the other of the wheels, as would be the case if they were fast on an axle extending solid from one wheel to the other. It is a form of epicyclic gearing consisting of a bevel gear attached to the inner end of each half axle, teeth facing inward, and a series of three or four small bevel pinions, equally spaced and carried on a frame, placed between and meshing with the bevels. If the vehicle is power, this frame carrying the bevel pinions also carries the bevels, worm or sprocket wheel which receives power from the motor, and thus applies it to both axles at once. One of the axles may rotate faster than the other, however, as in making turns, by reason of the bevel pinions rolling between the gears. (See Gearing, Traveling.)

Gearing, Traveling. In traveling cranes, the train of gearing by which power is applied to produce the traveling motion. For overhead and gantry crane traveling gearing, see Bridge Drive.

In locomotive cranes having a four-wheel truck a bevel gear train is carried from the winch engine to both axles, or to a central transverse shaft which is then connected to the axles by chain drive. In swiveling truck locomotive cranes, power is supplied to the inner axle of each truck either by bevel gear trains with double universal joints in a longitudinal shaft or by spur gearing through transverse shafts. In the latter case swiveling motion

of the trucks is permitted by crowning the teeth of the centrally located axle gear, to a circular arc whose center is the pivot pin of the truck. In either case power is brought to the gear under the car by means of a vertical shaft passing down through the center of the turntable.

A locomotive crane having eight wheels may have the traveling gear disengaged to enable it to be coupled into a train, and driven at train speed. Four-wheel cranes are not usually thus arranged.

In very large locomotive cranes which must travel on curves of short radius, the axles are not continuous from side to side, but are connected through a set of differential gearing, and the power for traveling is applied through a longitudinal drive shaft as in an automobile.

Gearing, Worm. A variety of helical gearing in which the non-intersecting shafts are at right angles and the angular velocity ratio is very large, resulting in one of the wheels having very few teeth, usually from one to four, and resembling a screw with as many threads, and the other wheel having a considerable number of teeth cut at a slight angle. The velocity ratio, or speed reduction, is equal to the ratio of the number of teeth on the wheel to the threads on the worm. The lead of the worm is the linear distance through which it turns the circumference of the wheel when the worm makes one complete rotation; its pitch is the distance from one worm tooth to the next, and is equal to the lead only when the worm is single-threaded. As the wear is heaviest on the worm, it is usually made of steel and the wheel of cast iron or bronze. Both are mounted in a case or housing containing a supply of lubricant, and provided with bearings for the shafts so that the worm and wheel will be held in the proper relative location, and with a thrust bearing to receive the end thrust of the worm.

Worm gearing is properly used whenever a large speed reduction is necessary, is compact and smooth running, and can be made non-reversing, meaning that the worm cannot be rotated by applying a driving force to the wheel. This irreversibility is secured at the expense of efficiency, however, which will in such cases always be less than 50 per cent. Even with the highest efficiency obtainable by the use of large angles for the worm thread, the efficiency is less than with spur gear arrangements.

Worm gearing is always cut, and the most satisfactory product is obtained by the hobbing process. It is claimed that the Hindley worm, made in the hourglass form, and fitting the circumference of the worm wheel, gives a better distribution of load, and therefore less wear, but it is difficult to adjust, and if out of adjustment will give excessive friction.

Gears, Interlocked. In hoisting machinery, when two drums driven by separate motors are used to lift the same load by load lines attached to it at different points, the gearing must be interconnected in such a way as to prevent unequal raising or lowering, and consequent tipping; this is called interlocking gearing. (See Crane, Ladle.)

Girder, Box. A structural steel beam made up of plates and shapes, arranged so that a transverse section of the beam is a hollow rectangle. This disposition of the material gives greater lateral strength for a given vertical strength and a given weight of material than is afforded by a plate girder, but is more expensive to construct and is liable to corrosion on the inside where it cannot be properly painted.

Girder, Braced. A structural steel beam made up of plates and shapes, with continuous members running for

the whole span along the top and bottom, these being connected at the ends, and at frequent intervals between, by diagonal or vertical struts or bars, or by both diagonals and verticals. The continuous members are made up of channels, angles or strips of plate, single, in duplicate, or in combination with each other: the upper member is called the top chord or (in beams supported at the ends) compression flange, the lower is called the lower chord or tension flange. The upper chord is horizontal, the lower horizontal or fishbelled, the latter being more costly but lighter. A number of systems of bracing are used, the most usual for cranes being the Warren, Linville and Lattice.

Braced construction is lighter than the plate or box girder type, but the labor cost to manufacture is higher. Weight saved in a crane bridge may, however, allow a saving in the runway girders.

Braced girders are used in all bridge structures of large span and for supporting heavy loads, and for small spans and lighter loads where weight is important and the headroom is not restricted.

Girder, Duplex. A double-braced girder consisting of two simple braced girders placed side by side but separated a small distance, and latticed together. This construction gives greater transverse strength and stiffness than would be given by a plain braced girder of equal vertical strength.

It is much used in girders of bridge cranes.

Girder, Plate. A structural steel beam made up of plates and angles, arranged so that a transverse section of the beam is like the letter I. This gives a beam of great vertical strength and one which is easily constructed and painted, but which is liable to be deficient in lateral strength unless reinforced by a horizontal auxiliary girder, or braced to another duplicate girder. (See Girder, Box.)

Used for runways and bridges of overhead travelling cranes and in steel construction work generally.

Girt. The distance piece or separator which holds the two side frames of a crane trolley in their proper position. It supports the operating machinery and also carries the upper block of the hoisting tackle and the equalizing sheave. The heavy load may cause deflection of a single girt with the resulting binding of bearings, so an extra girt is often supplied, called the load girt, which is attached at the ends to the side frames at points directly over the rails in such a way that its deflection cannot cause springing of the side frames. This girt carries the upper block; the usual girt, called the machinery girt, supports the machinery—motors, brakes, etc. The load girt carries from one-half (in four-part reeving) to seven-eighths (in sixteen-part reeving, in large cranes) of the total load, the remainder being divided between the equalizing sheave and the drum. Occasionally two machinery girts and one load girt are used. Sometimes called lifting beam.

Goliath. A popular name given to a type of large travelling gantry crane used for shipyard fitting out.

Gooseneck. An iron fitting sometimes used for attaching the inner end of a derrick boom to the mast. A bar or pin is hinged to a piece rigidly attached to the end of the boom and this pin fits into a vertical socket in a part attached rigidly to the mast, thus permitting both change of inclination and slewing of the boom.

Also, a piece of pipe shaped like the letter S, or one with a return bend on the end.

Governor. A mechanism for controlling the action of a machine as regards some quality of its output. Most

governors aim to maintain approximately constant speed of the machine, but some aim to maintain a constant fluid pressure, as pump governors; a constant voltage or constant current, as some types of electrical equipment; or a constant level of water in a tank, etc.

In governors used on prime movers, such as engines and turbines, constant speed is the principal requirement, and since change of centrifugal force due to change of speed is utilized as the operating force of the governor, constant speed is practically never obtained.

In machines which cannot normally run away because the resistance increases with the speed at a more rapid rate than the power developed, like centrifugal pumps, blowers and screw propellers, some safety device is necessary to prevent running away due to a sudden accidental decrease of the resistance, like the breaking of a discharge line or of a shaft, and these are often called governors. They generally stop the machine completely. The governors on steam driven air compressors are sometimes designed to maintain a constant pressure. Another type slows the compressor down to the lowest speed practicable during the time the unloader is preventing the compression of air, but brings it at once to full running speed when compression again commences, and holds this speed constant. In this case there are two running speeds, and the air pressure in the system is allowed to vary between definite limits.

Elevators and lowering devices in which lowering is automatic, that is, accomplished without the application of power in the lowering direction—often have brakes or equivalent devices operated by the speed of the moving part, which limit it, or even stop the motion entirely if it exceeds a certain predetermined safe value.

Governor, Pump. A mechanism added to a pump, and designed to maintain a constant discharge pressure, or a constant level in a suction or a discharge tank, or to prevent the pump running away and wrecking itself if the discharge resistance is accidentally removed, as by the bursting of a discharge line.

Grab. See Bucket, Grab (British).

Grab Hoist. A hoisting winch arranged for handling a grab bucket. (See Bucket, Grab.)

Grader. A type of excavating machine which is used to remove and redistribute the material on the surface of a road for the purpose of leveling it, or preparing a subgrade for road improvement.

Grader, Elevating. A grader which levels the surface of the ground by scraping it, and throws the loosened material onto the lower end of a conveyor by which it is delivered above and to the side of the machine, where it is deposited, or discharged into wagons for removal.

Grapple. A device operating like a clamshell grab bucket, but having three or more prongs on each side instead of shells made of plate, and used for handling long objects either singly or in bulk, like logs, ties, pulpwood, etc., and for handling irregular objects like stumps, snags and large stones. For long objects the sides are usually open, to allow the ends of the pieces to project, but for stone, etc., they may be closed by short prongs.

Page 313.

Grapple, Wood. A grapple especially adapted for the handling of pulp-wood, ties, props, cord-wood, legs, etc. (See Grapple.)

Gravity Roller Spiral. See Spiral, Gravity Roller.

Gravity Runway. See Conveyor, Roller; Chute.

Grease-cup. A receptacle designed to hold solid or very viscous lubricants, which are squeezed through an opening leading to the part to be lubricated.

Grizzly. See Screen, Grizzly.

Grizzly, Arrow-head. A bar or grizzly screen in which the cross section of the screen bar has an enlarged head with a point upward, somewhat like an arrow head.

Grizzly, Rotary. See Screen, Rotating Disc.

Guard, Rope or Guard, Chain. A curved stationary piece of metal fitted partially around the circumference of a rope or chain sheave, to prevent the rope or chain from jumping the sheave flanges, or working out if it is slackened.

Also, a fair-leader, or smooth opening through which the rope or chain is led, and which guides it properly into the groove of the sheave. See also Fairleader.

Gudgeon. (British) An overhung or cantilever pin or shaft, like the crank pin of a side crank engine.

In particular, the term often applied to the pivot pin at the top of a derrick mast.

Gusset Plate. A bracket of steel plate for stiffening the connection between two structural steel members meeting each other at an angle. In overhead travelling cranes, strong gusset plates are used to stiffen the connection between the bridge girders and the end truck.

Guy. A rope or other similar appliance used to steady something. A rope or chain used to steady a boom, mast, etc., and keep it from falling over or from swinging sideways. (See Guy, Derrick.)

Guy, Derrick. A guy used to hold in position (generally vertical) the top of the mast of a derrick. At least three guys must be used to enable it to resist forces acting in any direction, and five or more are generally used. For temporary or light use they may be of manila rope, but on account of the change of length of such material with atmospheric conditions, as well as stretch, steel wire rope is much preferred.

When rigid struts are used, they are called Stiff-legs. (See also Anchorage; Dead Men.)

Guy Cap. A circular metal part to which the guys supporting a derrick mast are attached. It fits on the gudgeon or mast top pivot as a bearing, and has openings around its periphery through which the ends of the guys may be passed, bent around on themselves and secured by clips. (See Mast Top.) Also called Guy Spider.

Gypsy Head. See Winch Head.

Gypsy Windlass. A term sometimes applied to a combination of a wildcat and a gypsy head on the same shaft, generally when hand-operated.

Hack. A name applied to a kind of pallet used for holding a pile of brick during the process of manufacture, consisting of a solid or slat top with two cross cleats beneath.

Handbarrow. A rectangular flat bottom box, with the long sides extended at each end to make handles by which it may be lifted or carried.

Hand-line. A small manila or hemp rope of convenient size to be coiled and, one end being held, thrown to a distant point, generally as a means of hauling a larger rope, chain, etc., across an open space. Also, a small line used for lowering or hoisting articles by hand.

Hanger. A part or piece by which another part is suspended or held in place from above, like a shaft hanger, monorail track hanger, etc.

Hatch. An opening, generally rectangular, in a ship's deck for passage of cargo, equipment or persons. Also the cover to fit such an opening, more often called a hatch cover. Also a rectangular opening in a floor or roof of a building.

Where exposed to the weather, hatches are generally provided with coamings or low walls around the open-

ing, so that water running along the deck cannot leak to the space below.

Hatch, Coaling. A opening provided in a deck for the purpose of loading coal.

Haulage, Cable or Rope. See Cable Car Haulage.

Haulage, Superposed Track Self-Dumping Car. A hauling and dumping system for elevating material on slopes and used for coal and similar bulk material, in which the car is hauled up the slope on a track dumped at the top and transferred to another track superposed on the first, on which it descends. A chain conveyor with crossbars pushes the loaded cars up and retards the empties down, the car weights thus being balanced against each other.

For a method of dumping the car at the top, see Swing Lift Transfer.

The device is also made in a portable form and can be used for handling dirt, gravel, crushed stone, etc.

Hawser. A large rope, either manila or wire, used on shipboard for towing, mooring, etc.

Head. The top or end of a thing, especially when distinguished in some way from the rest of it, as the head of a mast, or of a bolt.

Header. A pipe into which a number of other pipes terminate at right angles, as a boiler header, or a pipe header.

Also, a part of a framed structure around an opening, which is fitted transversely to the direction of most of the members, and against which they butt and to which they are attached.

Headroom. The distance underneath a structure or obstruction, or between it and the ground. Clearance measured in a vertical direction.

Heel. The inclination to one side of a floating vessel. Also, the lower or inner end of a spar, boom or strut. (See Boom Heel.)

Helix. A curve traced by a point which moves around a fixed line at a constant distance from it, and at the same time progresses along the line, like the thread on a bolt.

Hinge Plates. The two principal parts of a hinged connection as used for attaching a swinging wall bracket crane to the wall. They are connected with a hinge pin, which may be continuous for the upper and lower hinges of a pair.

Hitch. Any one of a variety of methods of attaching a rope to an object, to another rope or to another portion of itself, in such a manner that it can be easily detached.

Hitching, Car. A term applied to a coupling used for mine and similar cars. It may consist of a link with clevis at each end, or a chain of several links.

Hoist. A mechanism or machine whose function it is to elevate or raise heavy objects, generally by means of tackle or gear hanging from above, and often including such tackle or gear. The load usually hangs free; when a guided platform carries it the term elevator is used (see elevator), but this rule has exceptions (see Hoist, Mine). The mechanism is usually arranged to give a reduction of speed and increase of force between the source of power and the point of lifting, but this may be reversed, as in air cylinder hoists. Most true hoists are self-contained or complete in themselves, as chain hoists, pneumatic hoists, block-and-tackle, and some electric hoists; other so-called hoists are simply winding machines requiring combination with other machines and fittings before hoisting can be accomplished. The term is frequently incorrectly used to designate a winch or any geared machine which can exert a pull by winding rope on a

drum. This is correct only in case it is mounted in an elevated position relative to the load, or with the load pendent from it. When it is located on the ground and used for hoisting purposes by leading the rope to an elevated sheave, it is better called a hoisting winch.

The different kinds of hoists are distinguished by terms designating (a) the power used, as for example, hand, electric, air; (b) the kind of gearing used, as chain, differential, screw, planetary; (c) the combination with other apparatus, as trolley, twin, built-in, independent. The hoists of most overhead travelling cranes and of many gantry and jib cranes are built into the trolley.

Page 203, 773-804, 829.

Hoist, Air. A hoist operated by an air engine. The engine is usually of the two-cylinder type, with cranks at 90 deg., though rotating or oscillating cylinder and other types are in use. The engine crank shaft is geared to a drum on which the hoisting rope is wound, and all are mounted in a frame which may be hung on or built into a monorail or other trolley. Air is led to the hoist through hose, and is exhausted from the engine into the room where the hoist is used through a muffler if noise is objectionable.

The name is also applied to air winches, which may be located on the ground or some other convenient place, and have the hoisting line led to the point at which hoisting is to be done.

Also, a direct-acting hoist utilizing a piston moving in a cylinder under the action of compressed air, the load hook being attached directly to the end of the piston rod, or to a wire rope block-and-tackle operated by the piston rod. (See Hoist, Air Cylinder).

Page 207.

Hoist, Air Cylinder. A hoist in which a direct pull is obtained by a long stroke cylinder and piston operated by compressed air. In the simplest form, the cylinder is supported in a vertical position with the piston rod projecting through a stuffing box in the lower end, and the admission of air to the space beneath the piston forces it upward and raises the load; release of the air allows the load to descend. This is called a single-acting cylinder hoist, while simple it does not admit of delicate control. Another type maintains full pressure on the lower or stuffing box side of the piston, and a variable pressure on the upper side, air being discharged from the upper side to hoist, and admitted to it from the pressure line to lower. The length of lift is limited by the length of the cylinder.

The cylinder is usually of steel, ground and polished on the inside, with heads screwed on, or bolted to flanges which are screwed on the ends of the cylinder. The piston is usually made tight by leather packing rings, and the arrangement of the head is such that it can be easily removed for inspection and repairs. The cylinder may be mounted rigidly, or supported in trunnions on a crane trolley.

For lifts greater in height than the length of a well proportioned cylinder, or where the headroom available will not allow a vertical cylinder above the crane, the cylinder may be fixed in a horizontal or any other convenient position, and operate the hoisting hook by wire rope passing over guide sheaves. One or two sheaves carried in a head attached to the end of the piston rod and moving in guides, acting in conjunction with one or two fixed sheaves and rope properly arranged, will allow a cylinder of a certain stroke to hoist a load through two, three or four times the stroke. The arrangement may also be reversed to allow a long stroke cylinder to

lift a very heavy load through a short distance, acting in this case like an ordinary block-and-tackle.

Horizontal cylinders will not always return after making a hoist, and are therefore often arranged with variable pressures on both sides of the piston. Or, with a constant high pressure on the stuffing box side and a variable pressure on the other side of the piston, an enlarged piston rod will give enough excess force, when full pressure is on both sides, to move the piston toward the stuffing box end.

For convenience and safety in operation, several auxiliaries are often included, as follows: An air admission valve which will allow control of the speed of hoisting or lowering; air cushions to prevent jar at the ends of travel; adjustable stops for use when hoisting and lowering between fixed limits; top safety check for preventing the piston from flying violently to the top position should the load become accidentally detached; and an automatic arrangement to prevent slow creeping downward due to leakage of air.

Page 207.

Hoist, Built-in. A hoisting mechanism which is built into a crane trolley or other portion of a crane structure in such a way that it cannot be easily removed, taken elsewhere and used as a hoist, as distinguished from an independent hoist. (See Hoist, Trolley, for example.)

Hoist, Chain. A hoisting mechanism consisting of chain sheaves, gearing, casing, supporting and load hooks, and hand and load chains, so arranged that a load may be lifted on the load chain by pulling on the hand chain. The hoist is supported at the top of the casing, with the chains pendent. It may be provided with a supporting hook or shackle, in which case it is portable or independent; or it may be structurally a part of a trolley or traversing mechanism, in which case it is termed "built in."

Chain hoists are used for small or moderate loads, for short lifts and for intermittent service.

(For special types, see Hoist, Differential Chain; Hoist, Screw Chain; Hoist, Epicyclic Geared.)

Also called chain block or chain block hoist.

Page 203, 774-780.

Hoist, Differential Chain. A hoisting mechanism consisting of a hook and frame supporting on a shaft two rigidly connected chain sheaves of slightly different diameters, an endless chain passing in succession around one of these upper sheaves, a single lower sheave, the other upper sheave and a free hanging loop. The lower sheave is mounted in a block and has below it a hook on which is hung the load to be lifted. This lower or load block is thus hung in one loop of the chain supported by the two upper sheaves; this is called the load chain. The other loop is free and is used as the hand chain. Owing to the difference in diameters of the two upper sheaves, the load will move up or down in accordance with the movements of the load chain passing onto the larger sheave, as it winds more chain in one direction than the smaller sheave unwinds in the opposite direction.

Hoists of this type will sustain the load in any position without a brake, but are low in efficiency. Since the same chain serves as a load chain and a hand chain it becomes inconveniently large for hand pulling in the larger capacity hoists.

Page 204, 774-780.

Hoist, Drill Column. A term sometimes applied to a small portable hand or air winch arranged to bolt to

drill-columns in mines, and used there for miscellaneous hoisting or haulage work in connection with moving mining machines or removing mined coal.

Hoist, Drum. See Drum Hoist.

Hoist, Dual. See Hoist, Twin.

Hoist, Dumping, Motor Truck. An apparatus which lifts the front end of a dump body. (See Body, Motor Truck.) Hand operated hoists, used for light loads, have a hand crank connected by a train of gears to an arm attached to the dumping body. Mechanical hoists are driven from the engine, generally by a separate shaft projecting from the transmission case, with a clutch which is engaged by a hand lever located near the driver's seat, raising the body by wire rope or chain wound on a drum, or by pitch chain passing around sprockets. A hydraulic hoist consists of a cylinder and piston or ram, connected between the body and chassis by steel cables or levers. Oil delivered from an oil pump driven by the engine fills the cylinder and forces the piston out, thereby lifting the front end of the body. The amount of flow is controlled by the engine speed.

Page 702.

Hoist, Duplex. See Hoist, Screw Chain.

Hoist, Electric. Any hoist driven by an electric motor. (See Mine Hoist, Electric; Crane, Electric Overhead Traveling.) The term is also applied in a more limited way to a small or medium capacity self-contained electrically operated drum hoist hung on or built into a monorail trolley. Spur, worm and planetary gearing are employed.

Page 211, 773-804.

Hoist, Epicyclic. See Hoist, Planetary.

Hoist, First Motion. A term applied to a hoisting winch in which the engine or motor drives the shaft on which the drum is mounted, directly, without the interposition of any gearing. As the drum rotates at the engine speed the hoisting speed is high, but the engine must be capable of exerting the necessary torque.

Hoist, Flat Rope. A hoisting winch in which a short drum or reel winds the hoisting rope in successive layers. This system has the advantage that a short and light reel replaces the more usual long and heavy drum. Since the winding diameter steadily increases during hoisting, the speed and the power required also increase, and the motor or engine must be sufficiently powerful to exert the necessary maximum torque when the rope is wound to its greatest diameter.

Hoist, Geared. A hoist in which some form of toothed gearing is used between the point of application of power or hand pull and the point of application of the load, as distinguished from one in which the load is lifted directly by winding a rope or chain around a drum or sheave on a shaft to which power is applied, or from a block-and-tackle hoist. (See Gearing.)

The most common geared hoist has a plain gear train, consisting of a series of parallel shafts carrying spur pinions and gears, and transmitting motion through them in succession. (See Hoist, Trolley.) Other types are those employing chain gearing (see Hoist, Differential Chain), screw gearing (see Hoist, Screw), and planetary or epicyclic gearing (see Hoist, Planetary Geared).

Hoist, Hand. A hoist which is operated by hand power. They may be classified as hand chain hoists, which are operated by pulling on a hand chain, or as crank operated hoists.

Page 295, 774-780.

Hoist, Hydraulic. A hoist consisting of a cylinder in which a piston or plunger is moved by means of a liquid such as oil or water pumped in under pressure. The piston rod may lift the load directly, by means of a rope led around guide sheaves or by means of levers; reversed block and tackle is often used to gain an increase in the speed and length of lift at the expense of the magnitude of the load lifted. In some cases the piston or plunger is fixed and the cylinder moves under the influence of hydraulic pressure in a liquid introduced through a passage in the former. In some cases jib cranes are mounted on the cylinders, hoisting being accomplished by raising cylinder and crane bodily.

Hoist, Independent. A hoisting unit which may be moved from place to place and be hung on a support wherever desired for lifting operations, as distinguished from one which is built into a crane trolley, crane pillar, etc., and which must be used in connection with it. Block-and-tackle and chain hoists are typical examples. The hoisting unit may be hung on an eye by a hook, or bolted in place by a clevis and pin connection. Also called portable hoist.

Page 774-800.

Hoist, Loading Boom. A hoist arranged to operate the loading boom in a coal tippie. It is driven by a line shaft from the other tippie machinery or by a separate motor, and includes a reversing drive with bevel gears and double cone clutches driving the drum through a non-reversing worm wheel. Owing to this last feature, no brake is needed to hold the boom at any desired position.

Hoist, Mine. A winding machine or winch located at or near the head of a mine shaft, and used for raising the mined material and transporting men and construction material. Steam and electric driven hoists are the most common, and there is usually one geared reduction between the source of power and the winding drum. Two cages, cars or skips are generally installed, one acting as a counterbalance for the other. Various arrangements of conical and cylindro-conical drums are adapted, either to aid the counterbalancing, or to automatically provide for gradual acceleration and retardation. (See Drum, Mine Hoist.) The hoist is generally handled by an operator located at the machine; information as to the location of the cages in the shaft is given by depth indicators. Overspeed and overhoisting protective devices are also an essential part of the equipment to prevent accident due to negligence of the operator or derangement of various mechanisms. (See Controller, Hoist; Stop, Limit.)

Hoist, Monorail. A term often applied to a crane consisting of a hoist carried by a trolley traveling on an overhead monorail track (see Trolley, Monorail; Monorail Track), as distinguished from one which runs on two rails like an ordinary two girder overhead traveling crane. It may vary in form from a simple hand chain hoist on a trolley, with or without gearing for traveling, to a full motor operated hoist and trolley with floor or cage control. The cage controlled (or "man-trolley") type is preferably distinguished as a telfer. (See Telfer.) Also called tramway or trammal hoist; transporter, and man-trolley.

Also, a hoist mounted on a monorail trolley.

Page 774-804.

Hoist, Planetary Geared. A hoist in which a train of planetary or epicyclic spur gearing is used to obtain a large velocity ratio between the points of application of

power or hand pull, and of the load. Such hoists are made for both hand and power drive, the latter usually being by an electric motor. The gearing is arranged in various manners; two examples will be given. In one, a hand chain passing over a chain sheave rotates a pinion. Equally spaced around the circumference of this pinion, meshing with it and carried in a frame which can rotate independently of the shaft mentioned, are two or three intermediate gears each having fast to its side and concentric with it a smaller gear which meshes with an annular gear fast to the casing. The frame carrying these intermediate gears is rigidly connected to a sleeve surrounding the shaft of the hand chain sheave, and fast on this sleeve is the load sheave, over which the load chain is passed. Rotation of the hand chain shaft pinion forces the intermediate gears to turn, and on account of these meshing with the annular gear they are forced to roll around inside of it, carrying with them the frame and the load sheave. A large angular velocity ratio of the hand to load shafts can be obtained with very few shafts and gears; consequently the efficiency is high, and a load brake must be included to prevent involuntary lowering. (See Brake, Load.) This is sometimes called a triplex hoist.

In another hoist, also hand operated, the turning of the hand chain wheel rotates a pair of small eccentrics through a spur gear and two pinions. These rotate in circular openings in a frame on which is mounted an annular gear, giving it a gyratory motion, or a motion of circular translation. The annular gear is always in mesh with a spur gear to the shaft of which the load sheave is fastened, and each gyration of the annular gear causes the gear to rotate by an amount equal to the difference in the numbers of teeth in the annular and gear.

For an example of planetary gearing applied to a power operated hoist, see Hoist, Electric.

Page 203.

Hoist, Portable. A hoist which may be moved from place to place and be hung on a support for lifting operations, as distinguished from one which is built into a crane or other structure. (See Hoist, Independent.)

Hoist, Power. A hoist operated by power, as distinguished from one which is manually operated. Air steam, electricity, hydraulic power, internal combustion engine and horse power are used.

Also, a hoist which is provided with a pulley for driving from a line shaft or independent engine or motor.

Hoist, Reciprocating. An air or other power hoist, arranged to reciprocate vertically for a short distance regularly, and used for washing articles in baths, pickle, etc. The liquid is thus agitated, and the material forming the load thoroughly washed.

In reciprocating air hoists the motion of the piston rod itself is made to operate the valves at the top and bottom of the stroke to give the desired motion. The mechanism is similar to that used in a steam hammer.

Page 209.

Hoist, Screw Chain. A chain hoist in which the two load sheaves are fast on the same shaft as a worm wheel, which is in turn rotated by a worm wheel on another shaft at right angles to the first, and carrying a chain sheave around which a hand chain is passed. The two ends of the load chain are dead-ended at the hook and passed up over the load sheaves; the loop hangs down behind.

The thread angle of the worm gearing is generally made such that it is self-sustaining, though efficiency is thereby sacrificed.

Also called duplex hoist, from the duplication of load chains and sheaves.

Page 204, 774-780.

Hoist, Skip. See Skip Hoist.

Hoist, Slope. A term applied to a winch or power-driven winding machine which pulls cars up a slope by rope haulage. Descending cars are usually balanced against those ascending, and the engine has to overcome only friction and the useful weight hauled.

Hoist, Steam. See Winch; Winch Engine; Hoist, Mine.

Hoist, Telescoping. A hoist used in locations where material must be raised from a basement to or above the sidewalk level, and which must be drawn below the sidewalk when not in use. In one type the upper portion of a mast telescopes within or beside the fixed lower portion, being raised to operating position by hand crank through screw, chain or other gearing. The load is hoisted by a chain hoist or a power winch.

Another type consists of a vertical cylinder below grade with a plunger fitted into it and extending upward. One end of the load hoisting rope is deadened at the top of the fixed cylinder, the other has a hook for attaching the load, and the rope is passed over guide sheaves fixed in a crosshead at the top of the moving plunger so that the load moves upward twice as fast as the piston, and can be hoisted from the level of the bottom of the cylinder nearly to the level of the top of the plunger when in its highest position. It is operated by air, steam or water pressure as most convenient, automatic valves being arranged to retard and stop the plunger at the limits of the stroke.

This type of hoist is largely used for hoisting ashes from basement boiler rooms, and is often called an ash hoist.

Page 410.

Hoist, Trolley. A hoist which is built into the trolley of an overhead crane, as distinguished from an independent hoist, or one which is hooked onto a trolley or other point of support.

The most usual type is a four-wheel trolley built up of two side frames and one or more cross girts or separators, all of cast iron, cast steel, or structural steel shapes and plates, rigidly fastened together. The four wheels are on the ends of two axles, and have bearings at each end in the two side frames. The driving motors, brake mechanisms, and various other shafts supporting the winding drum, gears and brake drums have their bearings in the side frames or resting on the cross girts.

The hoisting gearing, in motor operated hoists, usually consists of a double reduction train, a pinion on the motor shaft driving a gear on an intermediate shaft, which in turn has a pinion driving a gear on the drum shaft. Occasionally a third reduction is obtained by a second intermediate shaft. Two separate brakes are provided, one being usually on the motor or the intermediate shaft. One is an electrical solenoid brake, arranged so that it is always applied by powerful springs or weights, unless current is passing through the circuit of the hoisting motor (see Brake, Solenoid); the other is mechanical, and operates only during the lowering of the load (see Brake, Screw). (For a different system of electrical braking, see Brake, Dynamic.)

The load is suspended by a wire rope block-and-tackle, the top block being suspended from the cross girt (see Girt, Load) and the lower or load block being located at the load hook. One end of the load rope is fast to the cross girt; the other is wound on the drum. When the drum is double scored for central lifting (see Drum)

there is a double system of ropes, and the rope is reeved so that a loop resting over an equalizing sheave supported from the cross girt replaces the two free ends. (See Ropes, Arrangement of Hoisting.)

A limit stop is provided to prevent overhoisting. (See Stop, Limit.)

Hoists are also built directly into monorail trolleys, but it is more usual to have an independent hoist hooked onto or bolted to a complete trolley. (See Trolley, Monorail.)

Page 774-804.

Hoist, Twin. An arrangement of two hoists on one trolley which can be simultaneously operated to lift long objects. The arrangement can be applied to bridge crane trolleys, or to monorail trolleys having two trucks connected by swivels to a single frame. (Also called Dual Hoist.)

Hoist, Wire Rope. A drum hoist using wire rope for the hoisting line, as distinguished from one using chain or manila rope. (See Drum.)

Hoisting. Three systems of electric hoisting, out of a great many that have been proposed, are in widespread use. The simplest and frequently the cheapest and most efficient is the induction motor hoist. The drums are ordinarily driven through a system of gears by the induction wound rotor motor, speed being controlled by insertion of a variable resistance in the rotor circuit. Another system uses a direct current geared or direct connected series motor whose speed is controlled by variation of impressed voltage in both polarity and magnitude by varying the field of the supply circuit generator. A third system, usually the most expensive, is similar to the latter but has a flywheel connected to the motor generator set which supplies power to the hoist motor. The flywheel accumulates energy during light periods and generates electrical energy with this stored energy during heavy loads, thereby lessening the peak loads on the central station supply system. This system is especially efficient in reducing the peaks which many power plants would be unable to carry.

Direct current affords more delicate speed control than alternating current, but the latter has given complete satisfaction when used with slip ring motors in a large number of installations. The induction motor operation requires somewhat more skill than the direct current machine due to use of resistance in the rotor circuit, but any speed requirements can be met.

Main feed wire connections must be protected by fuses or a circuit breaker and controlled by a switch in accordance with the requirements of the National Board of Fire Underwriters, and should be conveniently located near the hoist and in plain sight. A connection diagram is commonly attached to the inside of hoist controller covers. Fuses and circuit breakers should open the line at about double full load current as given on the hoist motor rating, except under special conditions.

For any type of crane where the hoisting speed is as high as 300 ft. per min., direct current is most satisfactory both as to operation and life of apparatus. With load speeds of 150 ft. to 300 ft. per min. an alternating current three-phase motor using a solenoid load brake can be used.

Hoisting Engine. The engine,—steam, air, gas, gasoline, kerosene, oil—used to run a hoist or hoisting winch.

Hoisting Line. In derricks, the line which does the hoisting of the load, as distinguished from the boom hoist, or topping lift, or slewing lines.

Hoisting Motor. A motor operating a hoist or hoisting winch. Some small high-speed engines driven by compressed air are often termed motors, as are multiple cylinder gasoline engines, and both are used to drive hoists. Electric motors are, however, far more common, and the term hoisting motor usually signifies one of these. They may be classified as high-speed and low-speed; alternating current (or A. C.) or direct current (D. C.); series, shunt, compound, interpole, etc., according to the connections of the field and armature circuits; and as induction, repulsion, synchronous, in the case of alternating current motors.

Hold-hook. A name sometimes applied to a hook attached to the bottom of a crane trolley, to which a load can be transferred from the lifting hook when desired. It is a regular part of the equipment for some types of single-rope grab buckets, for holding the bucket while it is being opened by slackening the closing line. (See Bucket, Single-rope.)

Hook. A curved piece of metal so shaped as to retain a rope, chain or similar fastening placed on it. Hooks are generally forged, though the larger sizes are sometimes of cast steel, and a few are laminated, or made up from thin steel sheets riveted together. The parts of a hook are: the shank, or standing part, rigidly connected or swiveled to the lower block of the tackle, or having an eye; the body or curved portion, ending in the point, which is turned sharply outward so as to retain lashings passed around it and back of the shank, to prevent slings from slipping off. The clear distance between the point and the inside of the shank is called the opening.

Hooks should be made of material which will yield by bending and not breaking, so that overloading can be detected before the load is dropped. Double hooks, having prongs on each side of the shank, have less awkward stresses imposed on them, and give more room for slings.

Page 312.

Hook, Double. A hook in which two prongs or points, extending in opposite directions, are formed on the same shank. Three or four prongs are occasionally used, to give plenty of room for slings. These hooks are only used for lifting heavy loads, and usually on large cranes.

Hook, Grab. A hoisting accessory consisting of a circle or endless piece of chain having two hooks attached to it on rings. The two hooks are caught under projections on the object to be lifted, and the chain is looped over a crane hook, when it assumes a triangular form, thus lifting the object by two points.

Also, a ring having two long links on it with hooks flexibly attached to their outer ends. The ring is hung over the crane hook and the hooks caught on the object.

Also, a hook fastened on the end of a piece of chain and formed with a narrow opening to slip flatwise over one link of the chain, between the ends of two standing links.

Page 313.

Hook, Safety. A hook having a piece hinged to swing down and lock over the point and prevent the slings from slipping off. This piece may also be locked in the open position.

Hook, Safety Detaching. A hook used for attaching a car or cage to a cable in such locations as mine hoists, where overhoisting may pull the cage through the head structure, destroying both, and perhaps injuring men. In one device the cable passes through a small opening in a strong beam across the shaft at the stopping point; if

the hook is hoisted against it, triggers are pushed in, releasing the top part of the hook with the cable, and at the same time thrusting auxiliary hooks over the beam in such a way as to prevent the car from falling to the bottom of the shaft.

Hook, Safety Hand Grip. A crane hook which has a handle formed on the back so that it can be safely held and shifted by hand, without danger of injury from slipping slings, etc.

Hook, Slip. A hook attached to the end of a piece of chain, and formed to pass through a ring or over the chain.

Hook, Split Girder. A hook specially designed for lifting steel girders having stiffeners. It consists of two hooks with split points, having an iron ring passing through their eyes. The split points set over the stiffeners on opposite sides of the girder.

Hook, Swiveling. A hook arranged with a shank which can turn in a bearing, the load being carried on a plain collar formed on the shank, or by ball or roller bearings interposed between the collar and the yoke.

Hook, Trip. A type of hook used where it is necessary to drop the load suddenly, as in breaking castings, etc. The lower part of the hook is hinged to the standing part or shank and is held by a trigger or catch which can be released by pulling a cord, allowing the hook to tip forward.

Hooks, Ladle. The pair of special elongated hooks which hang from a ladle lifting beam, and support the pouring ladle by its trunnions.

Hooks, Sister. Two hooks, with points turned toward each other, on the same shackle or ring. They virtually form an eye, though the sling does not have to be reeved through them.

Hopper. A temporary container for bulk material shaped like a funnel, but with four flat tapering sides arranged like an inverted truncated pyramid, with the large end up and generally open, and the small end down and generally closed by a gate or valve.

Hoppers serve for solids in bulk the same purpose that funnels do for liquids,—that of receiving intermittently a large flow or a flow of large cross sectional area, and delivering it through an outlet in a much smaller stream, continuously if desired, and in any case controlled by a gate or valve.

Hoppers are built of steel plates, wood and concrete, the latter being more common where the structure is beneath or close to the ground level. (See Hopper, Track.) The sides are usually sloped sufficiently to allow complete discharge of the contained material.

Hopper, Belt Loading. A hopper interposed between storage bins or chutes and a belt conveyor, for the purpose of delivering the material to the belt evenly and in the direction of travel. This reduces wear and tear, especially when gritty material is handled, and loads the belt more uniformly. It usually travels on rails paralleling the belt, and has extra troughing or concentrating rolls to assist in placing the load along the middle of the belt. The hopper may be moved by hand and fastened by track clamps under the desired outlet, or may be electrically self-propelled when large and massive, as in ore handling plants.

Also called a traveling hopper.

Hopper, Double Flow. A hopper having two discharge openings, each controlled by a suitable gate, so that the contents may be drawn from either one separately or both simultaneously.

Hopper, Floor. A portable hopper, elevated on supports which enable it to stand on a level floor, and with a gate controlled spout at one side near the bottom. Such a hopper is widely used in connection with concrete chute distributing systems, to receive continuously from the end of a discharge chute and deliver intermittently to wheel-barrow or to act as a charging hopper at a re-elevating tower in a continuous line plant.

Hopper, Mast. A form of circular or funnel-shaped hopper having a single eccentrically placed discharge opening, and also a cylindrical partition passing vertically through its center to one side of the discharge opening. This form of hopper may be fitted over the mast of a guyed derrick and be used to receive concrete dumped from a bucket; the discharge spout of the hopper leads to a chute used for distributing and placing the concrete.

Hopper, Receiving. In systems of distributing concrete by chutes, a hopper fastened against an outside face of the tower (see Tower, Concrete) and receiving the concrete from the concrete elevator bucket when the latter has been hoisted to its dumping point inside of the tower. Some have vertical backs and are placed close against the tower; others have a vertical front with an extended gate so that they may discharge into carts. If the concrete bucket dumps inside the tower, the hopper must extend partly inside to receive its contents, otherwise the hopper is entirely outside.

Hopper, Reclaiming. A hopper generally set level with the ground into which bulk material as coal or sand is scraped or dumped on reclaiming from a storage pile. In coal storage plants it is often identical or in the same pit with the receiving track hopper.

Hopper, Side Discharge. A hopper in which the discharge opening is in the side, the bottom sloping so as to cause the contents to slide in that direction.

When used as an ash pit beneath a boiler, the ash car runs on a track beside the hopper, and all ashes not flowing directly into the car when the sliding gate is raised, are easily dragged into it by a hoe.

Hopper, Track. A large hopper permanently installed beneath a line of railway track, and used to receive the contents of a hopper bottom dump car. It usually consists of a masonry pit, having two deep girders spanning it and carrying the rails, and with a steel hopper fitted around these girders, and extending beyond them at the sides. An automatic feeder is usually placed beneath the hopper, receiving the material from it and delivering it to a system of conveyors.

The slope of the hopper sides is such as to make it completely self-emptying. If sufficient length is required to dump a whole car at once, a double hopper is used, being merely a duplication of the arrangement already described.

Also called a dump hopper.

Track hoppers may also be arranged to feed skip hoists; the automatic skip feeder then takes the form of a measuring chute or spout which fills when turned up to be out of the way, and dumps its load into the skip bucket when turned down.

Hopper, Two-way, Two-way Switch. A hopper having two discharge openings, with a flap or swinging gate for turning the flow out of either discharge at pleasure. It is used for controlling the distribution of bulk material being conveyed by chutes, like concrete.

Hopper, Traveling. A hopper mounted on wheels running on a track along which it may be moved. This is done generally with the object of loading a horizontal

conveyor at different fixed locations determined by spouts or bin discharges, or at variable locations determined by the temporary position of a digging or handling machine like a locomotive crane equipped with a grab bucket. (See also Hopper, Belt Loading.)

Hopper-bottom. Having the lower part shaped like a hopper, said of cars, bins, storage pockets, bunkers, etc. Where several discharge points are allowable in a storage bin or pocket, two, four or some multiple number of hoppers may be formed in the bottom, increasing the bin capacity by eliminating the long sloping sides that would be necessary with a single hopper opening.

Hopper Grizzly. A bar grating or screen across a hopper opening which is set level with a floor for receiving the sand dumped from foundry flasks, etc.

Horsepower. A commonly used unit of mechanical power, representing the rate of expenditure of energy required to do 33,000 foot-pounds of mechanical work per minute.

I-beam. A rolled steel bar having a cross-section shaped like the letter I. The size is designated by the height of the I; for each height there is a standard width of flange, and also several different thicknesses. The weight is specified in pounds per running foot.

Idler. A sheave or pulley which runs free, without transmitting power, and merely serves to guide or support rope or chain. Movable idlers are also used as tighteners for rope and belt drives, and are especially valuable in giving a large arc of contact where it would otherwise be small, due to the short distance between centers.

Impact. The act of striking against something; a sudden blow, involving usually transfer of momentum from one body to the other, or transformation of mechanical energy into heat.

Incline Dummy. A car with a permanent heavy load, used as a counterbalance on an incline cable car haul when only one working car is used.

Indicator. An instrument used for determining the power developed by a reciprocating engine. Also, any mechanism which shows or indicates the position, condition, quantity or quality of something, as a depth, speed, pressure or polarity indicator.

(See also Hoist, Independent.)

Indicator, Depth. A device attached to a mine hoist by which the operator can observe the vertical location of the car in the shaft.

Indicator, Trip. A device attached to a mine or other hoist by which a graphical record is made of the daily operation. It shows the number of trips, their time, the time and duration of delays, stops, etc.

Indicator Wheel and Stand. A device for operating and indicating the position of turnheads or distributing spouts at the head of grain elevators. One type consists of a lever mounted on a vertical shaft which also serves as the turnhead step bearing; this lever has a latch engaging notches on a fixed wheel mounted on a stand. Another type consists of a wire rope wheel having leads which operate the turnhead; a fixed latch engages notches in the moving wheel to hold it in the desired position.

Inertia. That property of matter by which it tends to remain at rest if originally at rest, or to continue to move at uniform velocity in a straight line if originally in motion. It requires more power to start material to moving than to continue its motion after it is started, and greater stresses are developed in machines at the

time of sudden starting and stopping than occur when they are operating uniformly. As examples, the bridge of an overhead traveling crane is subject to heavy side stresses due to inertia when traveling on the runway if suddenly started or stopped, and the boom of a locomotive crane receives similar excessive stresses when slewing is started or stopped suddenly.

Inertia, Moment of. The moment of inertia of an area with respect to a given axis is the limit of the summation of the products of the elementary areas into which the area may be considered as divided by the square of the distance of the elementary areas from the axis.

There are several moments of area of a section, according to the location of the axis, and these appear in calculations of the strength of beams, trusses, cantilevers, shafts, etc., including practically all machine and structure parts.

Injector. A device by which the kinetic energy of a jet of steam flowing into a conical tube can be transferred to water supplied to the same conical tube, giving it such a high velocity that it can pass into a boiler or overcome other resistance to flow. When properly designed an injector will also lift water a considerable distance on the suction side.

Considered simply as a means of moving a liquid, it is inefficient, but if the heat added to the water is of value, as in feeding a boiler, it is an efficient device.

Jack. A compact self-contained portable mechanism for lifting or otherwise moving very heavy loads through small distances by the application of hand power. In addition to producing bodily motion, jacks are used for forcing tightly fitted parts apart or together. The larger the load lifted, the smaller the speed of lifting, and in general, the heavier the jack.

According to the type of mechanism they are termed screw jacks, lever jacks, air jacks and hydraulic jacks.

Jack, Air. A lifting jack in which air under pressure is used to force up the piston or plunger and lift the load.

Jack, Ball Bearing. A jack, generally of the screw type, in which one or two sets of ball thrust bearings are placed so as to carry the load and eliminate any metal to metal rubbing contact except along the thread of the screw.

Jack, Claw Type. A jack which has a foot or claw attached to the moving ram, but extending down near the jack base, so that it may be hooked under a part where there is insufficient space for the full height of the jack to be inserted. Otherwise a special low-jack must be used.

Claw jacks are made in the hydraulic and the rack and lever types.

Jack, Hydraulic. A form of jack in which the load to be lifted rests on a plunger fitting in a cylinder, and a hand pump delivers a liquid from a reservoir in the head into the space beneath the plunger, thus forcing it and the load, upward. They are made in various types, and capacities up to several hundred tons.

The common form has a base on which is formed a hollow vertical cylinder. Into this cylinder fits a hollow plunger which is enlarged at its upper end to form the head for carrying the load, and also for the reservoir to hold the supply of liquid. Suitable packing on the lower end of the plunger prevents leakage between plunger and cylinder. A hand lever reciprocates a short shaft in the head, and a lever inside the latter operates by means of a vertical rod, a piston pump in the lower end of the plunger, drawing liquid from the head and

forcing it through the bottom of the plunger into the space beneath, thus forcing the plunger to rise. The operating lever has a lug on one side which limits its motion in one direction; when turned over in the socket this limitation is removed and the pump piston may be forced downward farther, touching a valve stem and opening it so as to allow the liquid to flow back into the head, thus lowering the jack.

The load lifted depends on the ratio of the plunger area to that of the pump piston. The liquid used is water, oil, alcohol or some special mixture; it should be non-corrosive and non-freezing.

Jack, Hydraulic, Double Pump. A hydraulic jack having two pumps of different sizes. The larger pump is used for running the plunger out rapidly, and for light loads; the smaller pump is used for heavy lifting.

Jack, Hydraulic, Independent Pump. A jack having cylinder and ram made as short as possible, and operated by an independent pump connected by flexible metallic tubing. It can be inserted in narrow spaces, as, for forcing pulleys or propellers from their shafts, etc.

Jack, Hydraulic, Low Type. A hydraulic jack in which the pump and reservoir are at one side, thus making the total height much less and enabling it to be used in cramped spaces.

Jack, Rack and Lever. A jack consisting of an iron base with a post, on which is pivoted a horizontal lever having pawls on each side of the fulcrum. The ram slides vertically within the post and has a rack cut on the side toward the pawls which engage with the teeth when the lever is oscillated. A shifting part having cam surfaces will operate the pawls to lift the ram or to lower it as the lever is oscillated, according to its position. In some cases the shifting part cannot be set to lower, but will drop its load; this is used for railroad track work and other places where dropping does no harm, and speed of action is important.

In another type of lever jack, the lever is separate, and is fitted into a socket; it may occupy two positions in the socket, according to whether lowering or raising is desired. In one case this depends on the distance the lever is pushed into the socket, and in another, on which side of the lever is turned up.

Jack, Screw. A jack in which a screw receives a torque from an outside source of power, generally hand, and transforms a portion of that torque into thrust or translation which is applied to the object to be moved. The screw revolves through a nut fixed in the jack base, or, in some cases, the screw rises without turning while the nut is rotated by hand power. The range is limited by the length of the screw.

The base is generally enlarged toward the bottom, giving rise to the name of bell-base jack, or bottle jack.

Jack, Screw, Differential. A screw jack having two screws of different pitches to the same hand, and usually placed one inside of the other. By a proper selection of the two pitches, great lifting power may be secured by ordinary hand operation, but at the expense of speed of lifting.

Jack, Screw, with Lever and Ratchet. A screw jack in which the screw is rotated by means of the up and down motion of a hand lever actuating the screw through a ratchet operating on a ratchet wheel fast to the screw. Occasionally a pair of bevel gears or a worm and wheel are used in connection with the ratchet mechanism and the vertically oscillating lever.

Jack, Screw, Plain. A screw jack in which the screw is rotated by a bar, thrust through one of the holes across the head. A cap or bearing plate rests loosely on this head to support the load which does not revolve during lifting.

Jack, Screw, Telescopic. A screw jack having two screws, one within the other, thus affording a greater lifting range than the ordinary single screw jack.

Jack Shaft. An intermediate shaft, connected by transmission chain or rope or by belting to a source of power as an engine or motor pulley, or a line shaft, and delivering power to one or more machines by similar means. The object of a jack shaft is usually to secure a large speed ratio between the driving and driven shafts without a disproportionate ratio between pulleys, but other objects such as the necessity of getting past an obstacle, or, in the case of an auto truck, the avoiding of a huge differential on the rear axle, often make the jack shaft a desirable feature.

Jack, Traversing. A jack which is mounted on a flat base along which it can be slid by rotating a horizontal screw placed in the base and operating through a nut in the bottom of the jack. It can lift a load, move it sideways and deposit it again in a new position, thus extending its field of usefulness.

Jack, Universal. A jack which has a ball and socket bearing plate at the top, and perhaps at the base, to allow flat contact.

Jack-knifing. In a derrick, the term applied to the involuntary and undesirable raising of the boom sometimes occurring when a heavy load is being lifted. It is due principally to having the load line led from the boom point to a sheave well up on the mast instead of near its foot. The load line pull is thus tending to raise the boom, and if the block and tackle purchase is such that the load would descend with this raising of the boom, it may occur involuntarily at certain angles of the latter.

Jet, Water. A spray nozzle inserted in a line of pipe conveying a dusty material like ashes, to wet them and thus prevent a dusty discharge.

Jib. A horizontal arm forming one of the principal parts of one class of cranes. The load is suspended by ropes or chains from a trolley or traveller, which can move on wheels in or out along the jib. The jib may swing horizontally, or, with the structure on which it is fixed, may be moved along a track or runway, but the jib does not change its inclination with the horizontal while handling the load. In some special cases the jib is operated in an inclined position, as in inclined-cantilever-jib wharf cranes, but this is a fixed working position, and the trolley moves along the jib while carrying the load, the same as if the jib were horizontal.

Jib, Retracting. A jib which telescopes lengthwise. It is sometimes used on cantilever gantry cranes for cargo handling work, with a trolley which can carry loads from the cargo hatch to the pier. The possibility of retracting allows the crane to be moved along the pier without interference from the rigging of the vessel. Also called extensible jib.

Jinniwick. See Derrick, Jinniwick.

Joint, Flexible. A pipe joint so constructed that it can turn or swing without leaking; generally constructed on the ball and socket principle.

Also, any joint between two parts which allows a certain amount of relative freedom of motion.

Joint, Universal. See Universal Joint.

Journal. A portion of a transversely loaded rotating shaft which is enclosed by a bearing, and is sometimes slightly enlarged or reduced at the point where the bearing is located. In a general way the diameter of the journal is determined by the load the shaft is supporting transversely or transmitting in torsion, and its length by the requirement that the bearing area per square inch of projected area shall not be above a certain limit. This bearing area per square inch varies for different classes of work, and it is dependent on the tendency to heat under various conditions.

Key, Cross. A key which passes through an elongated slot in a shaft, and extends out beyond its surface on each side. It is generally used in connection with a thrust pin located in an axial hole in the center of the shaft, this pin pushing against the key and moving it along the slot in the shaft when desired. Used in this way it is also called a push key or thrust key, and is used as part of the operating gear or friction drums on winches.

Key, Lug. A small projection formed on the body of a bolt directly beneath the head, which enters a corresponding hole in the part through which the bolt is passed and prevents the bolt from rotating. Instead of being formed in one piece, the lug is sometimes simply a small pin set into a drilled hole in the bolt body or head.

King Pin. The pivot or central stud or bolt connecting the moving with the fixed part in a turntable or swivelling truck. It is usually formed so that the rotating part cannot be lifted off by an overturning or upward force.

King Post. The nautical term for the post or mast of a derrick as installed on shipboard for cargo handling. (See Derrick, Ship.)

Also, the principal strut in a simple form of truss known as king post truss. Derrick booms are occasionally trussed with four king posts placed at right angles around the boom at its middle point. (See Boom, Trussed.)

Lagging. A covering laid on the outside of engine cylinders, boilers, etc., to prevent the loss of heat by radiation. It is usually made of substances which do not conduct heat, like magnesia and asbestos, and is fitted in blocks or molded while in a plastic condition. Canvas, sheet metal or wood are often added to make a serviceable finished surface.

Also, pieces of wood secured to the cylindrical surface of a pulley or winding drum to increase its diameter or to furnish a wood in place of a metal surface.

Lang's-Lay. See Wire Rope, Lay of.

Larry. A small car running on a track, hand or power propelled, which receives bulk material from one or more storage bins and delivers it to the places where it is to be used, making regular trips from one to the other. The load is discharged by bottom or side dumping, or, if the car body is of the hopper form, by opening one or more gates in the hopper bottom and discharging through a spout.

Page 832.

Larry, Weighing. A larry which has its load carrying body or hopper mounted on scale irons, so that it weighs the load it carries. The weighing may be automatically performed and recorded, it may require the insertion of a card and pulling of a lever to print the weight, or it may require the balancing of a beam or the reading of a dial. Where several materials have to be gathered into

the same load, as in blast furnace work, as many different scale beams may be provided, permanently set for each of the materials. Each lever is connected up with the scales by means of a hand lever controlled by the operator.

In boiler room larries, the scale beam or dial is usually suspended close to the floor, so that the boiler room attendant can weigh all coal discharged into the stoker magazines without climbing a ladder.

Page 832-835.

Latch. A device for temporarily holding two parts in a definite relation, but which can be easily released. It usually consists of a piece pivoted at one end to the first part and with a hook at the other end which can engage a notch, groove or corresponding depression in the other part. Sometimes the hook end is missing and the straight latch simply rotates into a hook provided on the second part. Sometimes called a dog.

Lattice. Criss-cross bracing of flat bars or structural shapes, riveted to two parallel structural steel members to rigidly connect them and make them act as one to resist external loading. (See Girder, Lattice.)

Lay. The term applied to the placing of the strands of a rope in their proper relative position. (See also Wire Rope, Lay of.)

Lead, of a Rope. The course it follows from end to end. A clear lead signifies that the rope extends in a straight line, without any interference necessitating guide sheaves.

Leaf. One screen of a set of shaking screens arranged one above the other, and operated by the same mechanism. Also called a deck. (See Screen, Shaking.)

Lehr. An oven in which objects can be slowly cooled by the process of gradually removing them from a location of high temperature to a low one. In the glass lehr, this range of temperature may be from 1400 deg. at one end to room temperature at the other. Formerly articles were placed on iron trays or pans which rested on one of two sets of rods; by proper raising and horizontal moving of the rods at intervals, the pans could be gradually worked along the lehr. In modern installations an apron conveyor is more common. Special arrangements are necessary to keep the high temperature from warping the plates and injuring the chains.

Lever. One of the elementary mechanisms, consisting of a straight part acted upon by two forces in the same plane each of which tends to rotate it about a fixed point called a fulcrum. If the lever is a straight bar, three kinds of levers are often designated according to the relative positions of the fulcrum, and points of application of the resistance or load to be lifted, and the force applied. Many levers are bent, however, (see Bell-crank), and the classification is inapplicable to these, and is inadvisable in any case.

Levers are widely used; separately, as in crow-bars; or in machines, as brake levers, scale beams, controlling levers for steam winches, etc.

Levers, Banked. The term applied to an assembly of the various hand operating and brake levers of a locomotive crane, winch, mine hoist, etc., when arranged in a row and each connected by links and rockers to the proper part of the machine. Each lever is usually retained in a desired position by a latch engaging a notched quadrant. Foot levers for brakes, etc., may also be located in a bank.

Lever, Friction Hand. A hand lever used for operating a friction clutch, this type of clutch often being called simply a "friction," especially in winches.

Lie-leg. See Sill.

Lift. The extent of rise or distance through which anything is raised, as, a crane having a large lift.

The weight of a load lifted by a crane, as, a ten ton lift.

The cycle of operations of a crane, as, the crane makes twenty lifts per hour.

An elevator or dumbwaiter (British).

Lighter. A floating craft of full body, with or without means of self-propulsion, designed and used for the transfer of cargo between a vessel and the shore or wharf, or between vessels. A crane or other cargo handling gear is often included. (See also Barge.)

Lighter, Fueling. See Lighter, Self-Unloading Coal.

Lighter, Self-Unloading Coal. A lighter equipped with hopper bottom holds or bins from which coal can be fed to a longitudinal conveyor leading to one end of the lighter. Here the conveyor runs up an incline, or else delivers to another conveyor which elevates the coal sufficiently for it to be discharged to the ship's bunkers through gravity chutes from a telescoping spout that can be swung either side. Also called fueling lighter.

Limit Stop. See Stop, Limit.

Limit Switch, Track Type. A mechanism operated by a car, skip or elevator running on rails or guides, which disconnects the operating motor from the line (thereby usually automatically applying the brakes) when the proper stopping point has been reached. It is usually in the form of a stop or contact placed near the rails and operated by a projecting part of the car.

Limit Switch, Traveling Cam. A device for controlling the operation of an electrically driven power hoist, causing the stopping, dumping or some other operation to occur at a predetermined point, and consisting of a screw rotated by the hoisting drum shaft, which moves a cam longitudinally, in proportion to the car travel. This cam, which is adjustable, operates the switch. For an application, see Skip Hoist, Automatic.

Line. In hoisting, hauling, fastening, etc., a commonly used general term for a rope, chain or cord, especially when used for some particular purpose, as a tag-line, hand line, etc. The terms rope and line are used interchangeably, but since the word line has so many diverse meanings, rope is preferable when appropriate, as hoisting rope, trip rope, etc.

Liner. A piece of metal, usually a narrow strip, used for filling a space between two steel plates or between a plate and a structural shape.

Lining, Brake. An asbestos fabric woven in various widths and thicknesses, with or without interwoven metal wires, and used as a lining for one of the rubbing surfaces in some forms of clutches and brakes, where the service is intermittent and pressures moderate.

Link. A part of a machine which receives motion from one part and transmits it to another—a single element in the mechanism.

Also, one of the separate pieces of which a chain is composed.

Live Load. A load which is not static or dead; a load which varies in amount or moves in location. (See Factor of Safety.)

Load. A force applied from without or externally, measured in pounds, or tons. Also, in cranes and hoists, the useful weight lifted.

Load, Dead. Static or non-moving load; load which does not vary. The dead load of a structure is usually the weight of the structure itself, though other dead load may be added, as for example goods stored on the various floors of a warehouse or on a wharf. (See Load, Live.)

Load, Live. A dynamic or moving load, a load which is varying rapidly, or which is applied suddenly or with velocity. The stresses from such live loads may amount to many times those arising from dead loads of equal amount, and much larger factors of safety are necessary. Loads moving on wheels or rollers like crane trolleys or bucket conveyors are considered live loads, as are quick running machines in buildings above the ground floor.

Load, Pay. Useful or net load; gross weight minus weight of car, container, etc.

Load Rope or Load Chain. In a hoist or crane, the rope or chain on which the load is lifted. Also, in hoisting tackle, the part of rope or chain which leads directly to the load.

Loader, Box Car. A machine which places bulk material in box cars, either at the ends or uniformly distributed over the length. Such material is shipped in box cars either because it must be protected from dirt or the weather, or because open-top bottom-dump cars are not available.

The car loaders in common use involve pneumatic, belt, bucket, flight or screw conveyors, or are of the centrifugal or throwing type, or of the car tipping type. Page 273, 769, 837-840.

Loader, Box Car, Belt, Bucket or Flight Conveyor Type. A box car loader which consists of a short section of conveyor so arranged that it can be placed inside of a box car, and deliver material from the side door entrance to the ends of the car. One type has the conveyor section mounted on a frame carried by an arm pivoted at a fixed point beside the track. The car is brought alongside, the conveyor section is swung in, with its discharge end (which can be raised as the car is loaded) at one end of the car, and its receiving end opposite the center door and near the floor. Another short conveyor section or chute suspended from an elevated pocket or from the discharge end of an elevating conveyor delivers the material to the inside conveyor which carries it to the end of the car. When one end is filled, the conveyor is swung to the other end of the car.

Another type, referred to as portable, has the conveyor mounted on wheels, allowing it to be pushed into the car by the operator. The feeding chute or conveyor is also placed by hand, usually being swiveled or otherwise suspended from an overhead hopper or pocket.

The above conveyors extend well to the end of the car and deposit the material with little velocity, starting delivery near the floor and gradually raising the discharge as the pile grows, thus minimizing breakage. Other shorter types, which are more easily manipulated in and out of the car doors, are fitted with short belt conveyor sections, and rely on a high velocity of the belt to throw the material beyond the end of the conveyor, filling the car to its end.

The central part of the car can be filled from the feeding spout after the internal conveyor has been withdrawn, provided the strength of the car will allow this additional weight.

Page 277, 769, 837-840.

Loader, Box Car; Centrifugal or Throwing Type. A box car loader which is set on the car floor opposite the middle door of the car, and consists of a rotating cage with radial blades, driven by a motor. The material to be handled, as coal, is fed into the center of the rotating cage by a belt, screw or other conveyor from an outside supply, and is thrown from it by the centrifugal force due to rapid rotation. A cast iron cylinder with a side opening surrounds the rotor; this opening can be turned to either side and thus govern the direction of throwing, allowing both ends of the car to be filled at one setting. Two rotaries may also be combined in one machine in such a way as to load both ends of the car simultaneously.

The hopper into which the coal is loaded may be on the same side as the driving motor car or opposite to it; these arrangements are known as rear feed and front feed, respectively.

Page 277.

Loader, Box Car, Tipping or Tilting Type. A box car loader in which the car to be loaded is fastened between stops on a tilting platform which allows it to be tipped up to an angle of about 60 deg. Also called a rocking box car loader.

Loader, Box Car, Trough and Pusher Type. A device for loading box cars with bulk material, slightly curved in a vertical plane and so supported on an arm that it can be swung easily into a box car and placed parallel to its center line. It reciprocates horizontally past the supply, and when at its full stroke toward one end of the car, a pusher is moved the length of the trough by a chain, forcing the material out ahead of it and dropping it onto the pile on the floor. The trough is then moved to the other end, receiving its load as it passes the chute, and the operation is repeated.

Loader, Drag Line Scraper. A scoop-shaped implement for loading bulk material into wagons or open top cars by dragging it over or through the material by wire ropes operated from a power driven two-drum winch. The vehicle must be located below the level from which loading takes place, or else an incline must be arranged. The device is extensively used in mines for loading coal from the working face into cars in the main haulways. The scoop, which is sometimes in the form of a pan loaded partly by hand, and sometimes a double V-shaped steel structure without top or bottom, is back-hauled by a rope attached to its rear end and wound on one of the drums. It is then dragged parallel to the working face by passing the drag rope leading to the other drum around properly placed guide sheaves, gathering its load as it goes, and finally is pulled the length of the room and dumped into the car in the haulway, the scraper and load riding over the smooth floor of the room.

Loader, Elevator Type, for Coaling Vessels. A bucket elevator used for raising coal from a barge and dumping it into the bunkers of the ship alongside which the barge is placed. It consists of the bucket elevator, chain operated, passing around sprockets at the top and bottom of a frame which is lashed in a vertical position to the side of the ship. Another frame can be slid vertically on the elevator frame, and carries a hopper, spout and three sprockets around which the chain and buckets pass on their upward journey in such a way as to dump the coal into the hopper, discharging it through the spout into the coaling port in the vessel's side. The sliding part enables adjustments to be made for ports of varying elevation above the water and for varying depths of coal in the barge. The lower end of the

elevator rests in the coal and feeds downward; when it reaches the bottom it may be fed by hand shoveling, or it may be raised, the barge warped along under it, and it may then be fed downward in a new place.

Another type consists of an ordinary bucket elevator enclosed in a casing, and driven by a motor mounted beneath the head sprocket. The boot is open at the bottom and is self-feeding by being lowered into the material. The discharge is into a flexible spout which is also telescopic, to allow for raising or lowering of the unloader on account of changing levels. The unloader is operated while suspended by tackle from an eye in the top of the casing.

Page 828, 831.

Loader, Portable. A machine for raising bulk or package material from the floor or ground to the level of a vehicle which is to transport it, and which is made portable by being mounted on wheels. Such a machine is usually driven by power—electric motor or gasoline engine. If the material to be loaded is in bulk, as coal, gravel, sand, etc., the loader may be self-feeding or may require feeding by hand. The most common type involves a bucket or flight conveyor, and the height of delivery can be changed by changing the slope of the conveyor, within proper limits. Such a portable load may also be used as a feeder to a line of conveyor. (See Loader, Wagon.)

Page 768, 771, 773, 837-840.

Loader, Shovel Type. A loading machine in which a scoop or shovel is mechanically operated, sliding under the material on the floor, raising it to the dumping level and there dumping it by inverting it backward, or by tipping downward in front. The first type acts like a man lifting and throwing a shovelful over his shoulder; the second like a man turning with the loaded shovel, but emptying it by tipping it downward, instead of "throwing" the contents as is usually done by hand.

Loader, Truck, Portable. A portable inclined elevator generally of the apron type, of suitable dimensions and adjustability to load motor trucks from the ground. The apron often has a curve projecting for a short distance beyond the top end of the incline so as to reach further over into the truck. For successive tiers, the end of the loader may be raised, usually by hand.

Page 761, 768, 770.

Loader for Ships, Cantilever. A structure used for loading ships with bulk material at points where there is no harbor in which the vessel may tie up at a wharf. An elevated structure has a cantilever extending a long distance over deep water, and the vessel is held by anchors underneath the end; belt or other types of conveyors bring the material from storage ashore and dump it into the ship rapidly. Speed is essential on account of the possible danger to the ship if the stay is long.

Page 828, 831.

Loader, Wagon. A machine used for raising material, generally bulk material such as coal, coke, sand, gravel, crushed stone, etc., from a heap on the ground or floor to the level of a wagon and dumping it there. The most usual form is an inclined bucket or belt conveyor mounted on a frame supported on wheels, and delivering to an elevated chute which is usually swiveling. The conveyor drive is a steam or gasoline engine, or an electric motor. The machine may be travelling or capable of self-propulsion from place to place, and is often made self-feeding, moving slowly into the pile as it removes it. Or the conveyor may be mounted on a

sliding frame which is fed forward a certain distance with each setting of the wheels.

Other methods of feeding involve what might be termed "gatherers" which bring material from the sides toward the lower end of the conveyor. One type has a horizontal transverse shaft at the bottom of the conveyor with inclined blades, rotating in such a direction that the material is pulled toward the conveyor buckets. Another type has a thin horizontal disc close to the ground on each side of the conveyor, mounted on a vertical shaft, and rotating in the proper direction to carry the material toward the buckets. A third type has arms which reach out and scoop the material in the desired direction. In lieu of some method of self-feeding, a hopper is arranged at the bottom and material is shoveled into it by hand; this is the usual method when a belt conveyor is used.

The conveyor is usually hinged so that it may be lowered to a convenient height for passing under a shed roof, or for travelling on a highway. Four-wheel and three-wheel types are both in use; in either case arrangements may be made by which two of the four wheels, or the odd wheel in the three-wheel arrangement can be turned at right angles, allowing the loader to swing slowly from side to side each time that it is advanced into the pile. Or the upper part of the frame may thus swing on the truck or chassis. Some wagon loaders are mounted on trucks of the track laying variety. Some are hauled from place to place by horses or trailer, and are hand steered into the pile by a tongue.

Combined with the loading mechanism there is often a screening arrangement, especially for coal, which separates the dust from the coal and delivers it by a separate spout. Arrangements at the end of the delivery spout are often made for bagging the coal (see Chute, Bagging), and in conjunction with this a weighing device which measures the amount put into each bag is often included.

Fixed or non-portable wagon loaders are often arranged in connection with a track hopper, elevating the material from this hopper to a delivery spout under which wagons may be driven for loading. If the conveyor delivers into a fixed hopper or elevated container from which the material is drawn by a gate as desired, the arrangement is usually called a pocket.

Page 768, 770, 771, 773, 837-840.

Lock-Nut. A threaded nut so formed that it can be locked in position on a bolt.

Also, a second nut, generally thin, which is screwed on a thread above another nut to keep it from working loose. Also called jam-nut.

Locomotive, Compressed Air. A locomotive in which the power is supplied by compressed air, under high pressure, stored in tanks which are carried on the engine frame.

Page 627, 720.

Locomotive, Electric. A term given to locomotives driven by electric motors. The current may be obtained from an overhead trolley, a third rail or from storage batteries carried on the locomotive.

Page 627, 714, 718, 830.

Locomotive, Fireless. A locomotive in which the boiler and firebox are replaced by a storage tank which is charged with steam and hot water from a stationary boiler. The machinery is similar to that of a steam locomotive.

Page 626, 720.

Locomotive, Gasoline. A locomotive in which the power is supplied from an internal combustion engine.

Page 627, 724.

Locomotive, Geared. A type of steam locomotive in which the power is transmitted from the cylinders to the driving wheels through gearing.

Page 626.

Locomotive, Rack. A type of locomotive used on heavy grades. The locomotive is driven by a gear which engages with a rack usually located in the center of the track. They may be either electric or steam types.

Page 627.

Locomotive, Steam. A locomotive consisting of a boiler and engine mounted on a frame supported on wheels which are turned by the engine.

Page 623, 720, 721.

Locomotive, Storage Battery. See Locomotive, Electric.

Page 627.

Log Stack. An inclined conveyor or elevator, generally a flight or cable conveyor, used for piling short logs or pulp wood into a large stack. In one form the incline is arranged as a cantilever from a machine travelling on tracks parallel to the stack, this machine receiving the material from a conveyor parallel to its tracks. The discharge is always over the end of the trough. In another type the runway, after being elevated sufficiently by an incline, is carried along a horizontal elevated structure, with discharges by doors in the bottom of the trough wherever desired. These discharges can be operated by cables or shafts from the ground. For reclaiming purposes, a conveyor may be installed in a tunnel beneath the pile and parallel to it.

Page 273.

Lowerer. Any device or machine by which material is lowered under full control, that is, not vertically dropped or slid down an incline. The term is more particularly applied to apron or push-bar elevators running in a reverse direction, and to the various types of fingered and suspended tray elevators when used especially for lowering.

Retarding conveyors of the type used for lowering coal down steep slopes from mine openings are also sometimes called lowerers. (See Conveyor, Retarding; Drum, Lowering.)

Lowerer, Push-Bar. The mechanism used on a push-bar elevator operating in a reverse direction, and used to lower objects placed on the bed and against the push-bar.

Luff. To move a load toward or away from the axis of a rotating crane; especially where it is suspended from the end of a boom, to move it thus by changing the inclination of the boom.

Magnets, Lifting. An electro-magnetic device called a lifting magnet is extensively used for lifting large quantities of iron or steel. By the passing of direct current through a coil of wire which contains a soft iron core the latter becomes a strong magnet. This electro-magnet is suspended from a crane and moved to pick up and hold magnetic material during transportation by the crane, after which the direct current source of power is cut off and the material no longer clings to the iron core.

Circular lifting magnets have the greatest magnetism and are ordinarily used for handling pig iron, scrap and other small irregular materials. Bipolar lifting magnets with horizontal cores enclosed by a magnetizing winding are used for transporting rails, beams and heavy structures of considerable length. Rectangular magnets may be required for flexible plates which tend to pull away

from the core by their deflection, or else two or more circular lifting magnets suspended from the same frame may be used to overcome this difficulty. Both circular and rectangular magnets may be constructed with concentric poles with the winding arranged concentrically between the poles. Rail lifting magnets are constructed with mobile finger pole faces in order to increase the area of contact and thus increase the rail carrying capacity.

The rating and lifting capacity of the magnet depends on the contact area of the core and on the material which it has to handle, particularly the quality, temperature, shape and bulk of the load and the manner in which the material is to be lifted and stacked. Capacities range up to 65 in. diameter circular magnets capable of transporting 50,000 lb. if operated under favorable conditions. A well designed magnet will lift a solid piece of steel with machined surface, of not less diameter than the magnet itself, weighing about 15 times the weight of 350 lb. to 800 lb. magnets, eight to twelve times the weight of 800 lb. to 2,000 lb. magnets of two and three feet in diameter, and five to six times the weight of 2,000 lb. to 7,500 lb. magnets of three to five feet in diameter. Sand-cast pig iron, heavy scrap, stampings, fine wire scrap, drop forging and similar materials with irregular surfaces cannot be lifted in nearly as large quantities. In such cases magnets may not lift a quarter of their own weight. The capacity for handling heavy steel scrap is about 10 per cent greater than with pig iron. Magnets with large contact surfaces will lift more than one layer of material, and up to six layers of iron plates may be lifted depending on the weight and thickness of plate.

Lifting magnets are operated on circuits from 110 to 550 volts, but 220 is the usual voltage.

Controlling devices automatically shunt a discharge resistance across the magnet terminals when the circuit is about to be opened to prevent the flow of large inductive currents that would otherwise occur. Residual magnetism remaining in the cores of lifting magnets will prevent small loads from being released on opening the circuit. Small reverse currents may be applied to neutralize this magnetic force and release the load instantaneously.

Alternating current lifting magnets either single, two or three-phase, may be used in case direct current supply is unavailable. They are less powerful for the same weight than the best designed direct current magnets.

Shields used to catch material dropping from magnets during transportation and thus prevent its falling on workmen, are procurable, but they decrease the carrying capacity of the magnet by reducing both the magnetic availability and the speed of operation.

Three control units are ordinarily required, namely: a master switch with lift, drop and off positions; a double-pole magnetic contactor for handling the main magnetic current supply and breaking the highly inductive arc occurring on opening and closing the circuit; and a resistor for limiting the reverse current upon release of load. The location of control apparatus may be suited to convenience of operation.

Lifting magnet circuits are often connected to a special generator without fuses, circuit breakers or other circuit opening protective devices in the line, thus preventing the dropping of a load due to the opening of the circuit caused by an excess of current or a short circuit on some other machine.

Page 315, 807.

Manhole. An opening in a tank, bin, boiler, etc., of sufficient size to allow the passage of a man's body, the usual minimum dimensions being 11 in. by 15 in.

Manila. A vegetable fibre obtained from the leaves of a variety of wild banana plant growing in the Philippine Islands. It is light and strong and does not readily decay. Used for making ropes for hoisting and power transmission.

Man-trolley, Stocking. A trolley operating on a storage bridge handling ore or coal, often called a stocking bridge. These trolleys, particularly when intended for ore, are supplied with powerful grab buckets, handling as much as fifteen tons at a time.

Marine Leg. See Elevator, Marine Leg.

Mast and Gaff Unloader. A modified derrick used for unloading coal and other bulk materials from the hold of a vessel by a grab bucket, and delivering it to an elevated point such as the receiving hopper of a conveyor, coal crusher, storage pocket, etc. The mast is braced by guys at its top and by stiff-legs at the heel of the gaff. The gaff is a boom having its heel pivoted about halfway up the mast instead of near its base as in the ordinary derrick; its outer end or point is supported by a variable or fixed topping lift to the top of the mast.

A two-rope grab bucket is suspended from the gaff by its two operating ropes, which pass over sheaves at the gaff point, thence separately to guide sheaves at the ends of a cross-tree rigidly attached to the mast at the gaff heel, and finally to the drums of the hoisting winch.

In operation the bucket is hoisted by the closing rope, and the side pull due to its guide sheave being at the end of the cross-tree is sufficient to swing the gaff and loaded bucket over the receiving hopper, if the holding rope is slackened slightly. The bucket is dumped by holding the holding rope while the closing rope is slackened; the side pull is thereby reversed in direction on account of the guide sheave for the holding rope being at the other end of the cross-tree, and the gaff and empty bucket immediately swing back over the vessel. The bucket is lowered open by letting both ropes run out, under the control of the brake.

Page 828-831.

Mast, Tie-rod. See Mast, Trussed.

Mast Step. The seat in the base plate in which the mast of a derrick is placed. It is sometimes a cylindrical step bearing, requiring accurate plumbing of the mast; again, it is a ball and socket joint, allowing considerable inclination. For ease in hand slewing, ball bearings are sometimes installed. (See Derrick Bottom.)

Mast Top. The complete assemblage of metal parts at the top of a derrick mast, comprising the following parts or their equivalent; the mast top proper, including the gudgeon or pivot, which allows the mast to rotate; (for guyed derricks) the guy cap, which is fitted to the pivot, does not rotate, and is provided with eyes for the guy ends, or (for stiff-leg derricks) goose neck irons fastened to the upper ends of the stiff-legs and having holes fitted to the pivot; straps and bolts for securing these irons in place; one or more sheaves with their pins; and perhaps a rooster mounted on a rooster bracket for giving the topping lift a direct lead to the drum on the hoisting winch.

Mesh. A term used to designate the spacing of the wires in a woven wire screen. In fine screens the term usually means the number of wires or spaces per inch, as 120 mesh; in the coarse screens the distance from center to center of adjacent wires in inches, as one-half inch mesh. The term space really means the clear distance between adjacent wires, but is sometimes used interchangeably with mesh.

Mitre Gears. Bevel gears which are equal in size and have their shafts at right angles. The included angle of their pitch surface is 90 degrees.

Monitor. A raised portion of the roof structure of a building, generally astride the ridge, extending part or all of its length, and having the shape of a miniature building. Its side walls are usually glazed for light or provided with openings for ventilation, or both; it has no floor.

In many installations of coal-handling apparatus, conveyors are run lengthwise of the building through the monitor, and can dump anywhere in its length into storage bins beneath. The conveyor line is supported by the main roof timbers which extend across its base, and a footway alongside of it gives access for care and repairs.

Also, a kind of car used in lowering coal down inclines. (See Car, Monitor.)

Monorail, Adjustable Loop. A system by which a telfer or cage-controlled monorail hoist can serve the whole of a rectangular area by means of a movable bridge on to which the telfer can run.

Page 786.

Motor, Electric. See Electrical Definitions.

Motor, Gasoline. See Engine, Gasoline.

Neutral Axis. In a beam or other structural member subject to bending, if an imaginary transverse section be made at a given point, a line lying in this plane and passing through the center of gravity of the area of the section, and perpendicular to the plane in which the bending is taking place, is called the neutral axis. The material on one side of this axis is compressed by the bending, on the other side it is extended.

Niggerhead. See Winch Head.

Offset. The distance between two adjacent parallel portions of pipe, track, or other continuous line; the amount the line is set over in going from one to the other.

One of the measurements taken to locate a point or object by means of its distances from two base lines at right angles; a co-ordinate.

Overburden. The material resting on top of a bed of coal, ore, stone, or similar material, the excavation of which is contemplated. Removal of the overburden is called stripping.

Overcut. The term applied to a gate or valve for controlling the flow of loose material in a chute when it stops the flow by cutting down into the material from above. This is the usual construction, with vertical sliding gates, and with many quadrant or cylindrical gates.

Overload Detector. A device hung on a crane hook and having another hook to which the load is hung. A scale arrangement inside is arranged to give a continuous audible sound whenever an overload is lifted with the hook.

With electric operation, ammeters will indicate the degree of loading with fair accuracy. With steam locomotive cranes, the operator can usually tell from the steam pressure and throttle opening, as well as by the feel and sound, when he is approaching the danger point.

Overload Release, Mechanical. A safety device that will disengage a drive from its load when the latter exceeds a certain predetermined amount. In one type a central hub and spider on one end of a shaft carry levers which project outward into notches inside a rim carried on the end of another abutting shaft; springs hold these levers in the notches, but they are released when excessive load deflects the springs and causes the levers to slip out of place. The mechanism is reset by manually

revolving a collar, which engages pins on the inner ends of the levers and replaces them in their original position. (See also Breaking Pin.)

Pallet. A flat platform, plate or sheet of iron, wood or wood covered with iron, used to pile material on, for purposes of handling or transportation, or for such operations as drying, curing, etc. Those of wood standing on high cleats can be easily picked up, trucked and deposited with their loads by trucks or barrows with proper lifting fingers or hooks passing under the pallet. Also called a hack.

Also, a flat carrier, usually of wood and with the smooth side down, for use in conveying materials such as sacks of cement which will not move if placed on roller conveyors. In a simple system several sacks or similar articles may be piled on each pallet, and after a sufficient number of these loads have run to their destination, the pallets are piled on the roller conveyor and pushed back by hand. Boxes are similarly used for materials which will not stack on pallets.

Picking Band. See Picking Table.

Picking Table. The term applied to a steel apron conveyor on which a material like coal is spread out and moved slowly past pickers who remove the refuse. The upper surface of an endless apron is usually used for this purpose, with the receiving point at one end and the discharge at the other; circular tables are sometimes used, with the pickers stationed inside and out, and a diagonal sweep or diverter discharging the coal just before the revolving table reaches the receiving point. For small material an endless belt may be used.

Coal is easier to pick if the fine material is removed, or if the pieces are uniform in size, so screening usually precedes picking; sometimes a picking table is divided down the middle and carries two sizes separated by a partition, and a third space may be formed between these two to carry away the refuse. Refuse may also be dropped down chutes to a drag chain, or flight conveyor, or car, by which it is removed to a dumping point.

The endless apron form is also called a picking band.

Pier. A platform or structure resting on the bottom, projecting above the water, and extending out into a stream, harbor or other body of water, and generally, though not necessarily, used for mooring, loading and unloading vessels. (See also Wharf.) Cranes installed on piers and arranged for cargo handling service are usually called wharf or cargo handling cranes and not pier cranes.

Also, one of the supports of the spans of a bridge or other similar structure.

Also, a short tower for elevating a crane structure above the ground level. (See Pier Base.)

Pier Base. A short structural steel tower used to give moderate elevation to a crane. A locomotive crane may have a pier base, adapting it for storage yard or cargo handling work.

Pier Shed. A roofed structure or building placed on a pier, generally to prevent damage to stored material by the elements. It may cover part of the pier, leaving open passages along the sides for the movements of cranes or special cargo handling machinery, or it may cover all the pier, in which case the cargo handling machinery must be located on the roof or carried by the vessel.

Pillar. A post of wood, steel or masonry used to support the floor of a building or other portion of a structure. In pillar cranes, the central column or post by which

the boom or jib is supported. (See Crane, Pillar; Crane, Pillar Jib.) The pillar is constructed in various ways, two types being a tapering cast iron column of circular section flared at the bottom where it rests on a turntable, or a structural steel column bracketed to a heavy base plate. The particular type of pillar crane called a locomotive crane generally has its pillar, which is very short, included as part of the two side frames of the hoisting winch and mounted with them on the revolving platform.

Pinion. The smaller of a pair of gears in mesh with each other. A gear with a small number of teeth. (See Gearing.)

Pintle. A cantilever pin or pivot, like the pivots at the top and bottom of the mast of a jib crane.

Pintle Crane. See Crane, Pintle.

Pipe Supports, Jacking. A pair of light weight screw jacks supporting the weight of a vertical pipe above an elbow or other fitting, to enable repairs to be easily made on a part below. Used in steam jet ash conveyor systems, when renewing the wearing plates immediately above an elbow steam unit.

Pit, Tower. A pit sometimes dug at the base of the tower in a concrete chuting plant, to allow the bucket to go below the ground level for filling. This avoids the necessity of elevating the mixing plant.

Platform. Level space on an elevated structure, on which a person may stand and move about. Platforms around crane structures are generally called footways.

Platform, Live. A wood or metal platform elevated a short distance above the ground and resting on small wheels or casters so that it can be moved about easily. For long trips it is picked up by a lift truck, the same as a skid platform. Also called live skid.

Page 540.

Platform, Revolving. The upper or rotating part of a turntable as used on a rotary crane. In locomotive cranes, called the deck or racer.

Platform, Safety. A platform provided with all details required to make it as safe as possible. These involve toe board, solid floors through which small articles cannot drop, railings, with two or more bars, guarded ladders or stairs for entrance, etc.

Platform, Skid. A wood or metal platform elevated a short distance above the floor and resting on longitudinal members or skids. Raw or finished material, or partially finished work is piled on it, and it is picked up bodily and moved to any desired new location by means of a lifting truck of some sort. Boxes of any desired depth may be built on the platform, with removable sides or ends; stakes may be provided around the outside to keep objects from rolling off; pins or posts to hold objects with holes in them may be inserted; cradles and all variety of special arrangements may also be used when advantageous. Also called skid.

Page 537, 746.

Plow, Unloading. A plow which can be pulled along a train of flat cars or swing side door cars by a wire rope wound on a drum, forcing off the load of dirt, rock, etc., on one or both sides of the track. In one system of operation, a special unloading car carrying the winding machinery and coupled to a dumping locomotive is attached to the train. When just about to enter the track where dumping is to take place, the end of the cable is made fast to a chain temporarily stretched above the cars; as the train moves forward the cable unwinds and eventually lies along the top of the load from front

to back of the train. After it is attached to a plow which has been brought up to the rear of the train on a special car, the winch is started and the plow is pulled the whole length of the train.

The cars have no ends, and the floor spaces between, over the couplings, are bridged by steel plates, so that the train forms one long continuous trough.

Plows are made to discharge to the left or to the right, or on both sides, a special pilot being provided in the last case to keep the plow central.

Plumb. The state of being vertical.

Also, a weight suspended on the end of a cord, by which an object is tested as to its vertical condition, or by which a point on one object is set directly over a definite point below. Also called plumb bob, or plumb bob and line.

Plunger. A machine part, prismatic in form, which has a reciprocating motion parallel to its axis, and which is used to move material by reason of the space occupied by itself. Pump plungers force liquid out of a cylinder as they are forced into it. The plunger in a plunger type feeder pushes the material, as coal, ahead of it on the forward stroke; on the return fresh material drops in the space vacated.

Ply. One of the layers of sheet material which goes to make up an article of laminated structure, as fabric belts, veneered wood, etc.

Pneumatic. Connected with or pertaining to the use of air at a high or low pressure, as pneumatic tools, pneumatic tube.

Pocket, Retail Coal. An elevated storage bin for holding various sizes of coal, and arranged for delivering to trucks and wagons for retail sale. (See Pocket, Storage.)

Pocket, Storage. An overhead bin for containing bulk material, which is delivered to it direct from cars on a track elevated above the pocket, or from boats or cars at a lower level by means of elevating and conveying machinery of various types. The separate compartments are usually formed with sloping or hopper bottoms and are provided with discharge chutes and gates, so that they will completely discharge their contents. They are made of wood, rectangular in plan and subdivided by wooden partitions, the whole being strengthened by steel rods. Round wooden or silo-type pockets are often used, usually without subdivisions, each silo holding one size of material. Steel tank coal pockets are also used, subdivisions being made if needed by wooden cribbing with steel reinforcement. All pockets are at an elevation above the level on which stand the cars, wagons, etc., receiving the material, and this usually involves a high foundation or supporting framework for the pocket or a depressed receiving track level. The driveways on which the receiving wagons or trucks stand are laid out either transversely or longitudinally beneath the pockets, or outside on one or both sides of the structure, corresponding to pockets sloping toward one or toward both sides.

Portable. Capable of being easily carried or moved about. Of a machine, not dependent for proper operation on the surroundings, setting or foundation in a particular locality, preferably limited to cases where the machine may be moved to a new locality with little or no dismantling, but where it is not self-propelled.

Portable Cranes. One type of portable cranes is that used with storage battery locomotives. (See Locomotive, Storage Battery.) Another type of portable crane uses a motor having a cable leading to a service station or re-

ceptacle connected to a power distribution system commonly operating at 200 to 250 volts. Such an apparatus is best adapted to use on units handling freight weighing up to one thousand pounds, requiring a considerable vertical lift, and working in conjunction with industrial or hand trucks. Direct current provides better control and simpler wiring than alternating current, but both are used satisfactorily.

Power, Hydraulic. A system of power transmission in which water (or oil) under pressure is used as the transmission medium. It consists of one or more pumps capable of generating the required pressure, accumulators for storing the water under pressure, distributing pipes, valves, and the presses, cranes, or other machinery to be operated.

Hydraulic machinery is rapid in action, smooth and silent in working, and not excessive in cost or upkeep. It is, however, bulky and complicated, and in cold climates, liable to freeze in cold weather.

Hydraulic presses and other apparatus for exerting very heavy forces are still in favor, but for hoists and cranes, the system is practically obsolete.

Power-wheel. See Bucket Power-wheel.

Pulley. A wheel turning with or on a shaft supported in a bearing, and having its circumference shaped so as to carry some sort of band for transmitting its motion to another similar wheel. A pulley usually has a flat or nearly flat (crowning) surface for a flat belt; when the rim is grooved for a rope or chain, it is usually and preferably called a sheave.

Flat and crowned pulleys, with belts, are widely used as a means of transmitting power short and moderate distances. Cranes were formerly driven by them. (See Crane, Power.)

Also, a block for rope (see Block); also called pulley block.

Pulley, Guide. An auxiliary pulley which is located in such a way as to deliver a belt in the plane of another pulley, either the driving or the driven pulley of the mechanism. For ropes and chains, see Sheave, Guide.

Pulley, Slat. A pulley used with belt conveyors handling clay, dirt or other material which might pack between the belt and an ordinary full-face pulley. It is composed of two end discs or spiders connected by parallel slats, like a squirrel cage.

Pulley, Snub. A pair of chain sprockets placed close under the head sprockets on the return side of a double strand bucket elevator, to cause a perfect discharge of the material by completely inverting the buckets. They are placed outside the line of buckets and deflect the chains inward so that they remain in contact with the sprockets for considerably more than 180 deg. Also called choke wheels or deflecting wheels. (See Elevator, Perfect Discharge.)

Pulleys, Tight and Loose. Pulleys which revolve about the same axis, one being rigidly attached or keyed to, and the other loosely revolving on, the shaft.

Pump, Dredge. A centrifugal pump used in a hydraulic dredge for drawing the mixture of water and solid material in through the suction pipe and discharging it on land or into a scow. (See Dredge, Hydraulic.) These pumps are designed specifically for the hard service they must undergo, and will handle boulders as large as can pass the agitator blades at the suction head. Dredge pumps are usually driven by vertical engines, often compound, and designed for economical operation.

Pump, Jet. A pumping device in which the high velocity of a small stream of fluid is made to give a slow

velocity to a large amount of the same or another fluid, by a process of entrainment and of transformation of the kinetic energy of the small mass at high velocity to the kinetic energy of a large mass at low velocity. Because of the absence of moving parts, fluids containing solids can be handled and the apparatus is simple and cheap, but the efficiency is usually low.

The arrangements in most common use are: a water jet pumping water, known as a water-jet pump; a steam jet pumping water, known as an injector or ejector, depending on whether the delivery pressure is high or low; and a steam jet pumping air, known as a steam blower.

Water-jet pumps are used for drainage and excavation work, where dirty, gritty water would injure piston pumps. Ejectors are used for the same purpose, the steam being delivered from a stationary boiler, and while inefficient as compared with a piston pump, are simple, cheap and easily installed. Injectors are used for pumping feed water into boilers, and as the heat of the steam is here saved by going into the feed water, the efficiency is high. Steam blowers are used to produce draft for boiler fires, and are usually applied at the base of the stack, where they act to accelerate the exhaust gases and produce a suction.

Pump, Relay. In long pipe lines, a pump placed at an intermediate point to assist in moving the liquid by again raising its pressure after that originally supplied has been reduced by the friction of flow. In the discharge from hydraulic dredges, relay pumps increase greatly the possible length of discharge and remove part of the load from the pump, permitting greater output. The pumps are operated by steam or electricity.

Purchase. Mechanical advantage; increase of force at the expense of space moved through, as the purchase of a lever or block and tackle. Geared drum winches are also known as single or double purchase according to whether there are one or two gear reductions between the point of power application and the drum shaft.

Push-bar. One of the transverse bars fixed at the ends to the two moving chains of a push-bar conveyor or elevator, which moves articles placed on the bed between them by direct pressure. These are ordinarily wood, or round or square iron bars; they may also be strips bearing flat against the articles. Wings or flights attached to a single chain and used to drag objects along a runway bed are also sometimes termed push-bars.

Radial. In the direction of a radius of a circle, either outward or inward, as distinguished from axial, tangential, or circumferential.

Rail, Ground. A line of rails which is located on the ground, as distinguished from one supported on an elevated structure, building, etc.

Railway, Automatic. A railway with a single car used for moving bulk material on a down grade from the receiving to the discharging point, employing a movable counterweight which is raised by the loaded car while the latter is being brought to rest at the dumping point, and which gives out its stored energy in starting the empty car back up the grade with sufficient velocity to return to the starting (loading) position. The operator starts the car on its downward trip; as it approaches the dumping point (which may be varied) it runs against an adjustable dumping block fast to a cable connected to the counterweight; it raises the counterweight and just before it comes to rest at the dumping point strikes a dumping board which releases a toggle connection and allows the top hinged side doors to swing outward

at the bottom and dump the load. The dumping is assisted by the gable bottom of the car. The front and back of the car are sloped in such a way that the reaction due to the discharge of the load helps to start the car back up the grade. The counterweight continues the acceleration and the car receives sufficient velocity to go up to the starting point. One man only is needed to operate the railway and no power is required.

Page 585, 831.

Ramp. An artificial inclined path, road or track along which persons, animals and wheeled vehicles may pass primarily for the purpose of ascending or descending or changing their elevation. Foot ramps take the place of stairways; railway tracks set on a steep grade for the purpose of hauling loaded cars of bulk material to be dumped, are sometimes called ramps; moving ramps, formed of platform conveyors, are made to carry loads, men with loaded hand trucks, and even wheeled vehicles like motor trucks; chain haulage ramps have haulage chains laid in them, to assist heavily loaded trucks either up or down.

Ramp, Moving. A wood apron conveyor set at a moderate inclination and used for conveying persons, motor trucks, "wheelers" or wheeled trucks, etc., up or down the grade. When the slope is so steep that special arrangements must be provided to prevent vehicles from running down the apron, it is usually termed an apron elevator.

Ratchet. A detent or pivoted piece arranged to fit into the teeth of a ratchet-wheel in such a way as to allow its rotation in one direction, but not in the other. Also called Pawl, Dog, Click. (See Ratchet and Wheel.)

Ratchet, Friction. A ratchet which locks a ratchet wheel against rotation in one direction by friction rather than by placing a projection in its path. It is generally a small rounded piece eccentrically pivoted, or a ball or roller in contact with an eccentric or spiral surface, so arranged that the wheel pushes it aside when rotating in one direction, but brings it into a powerful wedging action when it starts to rotate in the other direction.

Ratchet Wheel. The toothed wheel forming one element of a ratchet and wheel mechanism. (See Ratchet and Wheel.)

Ratchet and Wheel. A mechanism combining a ratchet and ratchet wheel, much used in hoisting machinery for preventing the involuntary lowering of the load when the lifting effort is interrupted. In hand hoists, the ratchets are generally gravity operated, and are turned out of acting position when lowering. In power hoists the noisy click is generally objectionable, and a friction ring or clamp is usually connected to the ratchet in such a way as to keep it entirely out of action during lifting, but instantly returning it into contact with the wheel when reverse turning starts. Friction ratchets are not generally considered sufficiently reliable to use directly for hoisting purposes. An exception to this is in the case of a worm ratchet. The ratchet wheel is simply a worm wheel, having in mesh with it a worm which will not turn in one direction owing to the wedging of a conical surface on the worm shaft in its seat, but which will turn with ease in the other direction. The reversal of thrust of the worm is used to bring one or the other of these two resistances into play, the small resistance corresponding to lifting, and the wedging action to lowering.

Reciprocate. To move back and forth, to alternate in direction of motion, like the piston of an engine.

Reeve. To pass or thread a rope through pulleys, blocks, guides, etc.

Retarder, Car. A device for controlling the movement of a railway or industrial car down a grade, generally during the operation of loading with bulk material. One device used with railway cars being loaded at coal tipples is to have a two-compartment brake controlled drum, located at the head of the grade under the tippel, with ropes wound in opposite directions in the two compartments. One rope is attached to the car by a hook, and the other is attached to a counterweight. The car is allowed to move down the grade by slightly releasing the brake, which is always kept set by a spring or weight. When the car has moved its length down the grade under the loading beam and is filled, the retarding rope is unhooked, and the counterweight winds it up on the drum, making it ready for attaching to another car.

A device of this sort gives much better control of the motion of the car than can be obtained with the regular brakes of the railway car itself, and generally saves labor.

Retriever. A special light drum used to take up slack in magnet lead wires in crane operation. (See Drum, Cable.)

Roll or Roller. A cylinder rotating about its axis, with or without bearings at its ends. The distinction between these two terms is very indefinite, but the term roll is more commonly applied to cases where the end bearings are in fixed frames and some pressure is exerted, as in a rolling mill, feed rolls, etc. Roller is used (a) where the bearings are movable, as in lawn rollers, (b) where there are no bearings, as the rollers placed under a heavy weight to assist in moving it, and (c) where the cylinders are placed in fixed bearings and objects moved over them; the function is merely to change sliding into rolling friction in the two last cases.

Narrow rollers are called wheels; the distinction is indefinite, but might be said to relate to the proportion when the face is equal to the radius, wider faces requiring the term roller. (See also Conveyor Roller.)

Roller Axle. See Conveyor Roller.

Roller, Live. The moving rollers in a roller bearing, which have a motion of translation of the axis as well as a rotation on that axis. Distinguished from rollers which are supported on fixed bearings to allow parts to move over them.

Also a roller which is rotated by power, as for example one of the rollers of a power roller conveyor.

Roller Spiral, Gravity. See Spiral, Gravity Roller.

Rolling, Cold. The process of passing metal bars or sheets between rolls exerting a heavy pressure on them, while cold, in order to size them accurately, to harden the material, or to improve the surface finish.

Rooster. A sheave carried in a swiveling bracket on the gudgeon or pivot pin at the top of a derrick mast, and used for giving the boom hoist line a straight lead to the drum on the hoisting winch. The boom hoist line is led up the center of the mast, out at its top, and over the rooster sheave, thus leaving the two sheaves in the mast step free for the hoisting and the closing lines required in two-line bucket operation. Or if only one hoisting line is required, the use of a rooster allows the single line at the bottom to be placed centrally, and the mast can then be rotated a complete circle or more without fouling any line.

Rooster Bracket. See Rooster.

Rooster Sheave. See Rooster.

Rope. A flexible connector used for pulling, made of fibrous vegetable materials or of metal wires. If the former, the fibres are twisted into yarns, the yarn into strands, and the strands are then laid into a rope. If the latter, wires are laid into strands and the strands into a rope. (See Rope, Cordage; Wire Rope; Wire Rope, Lay of.)

Page 320, 818-822.

Rope, Armored Wire. Wire rope which has had its strands wrapped or served with a winding of metal wire or ribbon before being laid into the final rope. This armor takes all the wear for a long period of time, and materially lengthens the life of the rope.

Page 320, 818-822.

Ropes, Arrangement of Hoisting. In cranes up to three tons capacity the load may be lifted on a single fall of rope. For loads from five to seven tons, two parts are employed, one part winding on the drum. Above this size the load is lifted on four parts of rope, two parts being wound in left and right hand grooves on the drum, and the other two passing around an equalizing sheave. In very large cranes the load may be supported on 16 (or more) parts, two winding on the drum, two passing around the equalizer sheave, and 12 pendant from the upper block. In some cases the ropes ordinarily passing around the equalizer are led to another drum and wound on it.

The above represents common practice in overhead cranes, but there are many variations even in them, and when derricks, steam shovels, grab buckets, etc., are considered the arrangements in use are exceedingly numerous.

Where sheaves and drums must be kept small, as in overhead crane trolleys, a maximum diameter of rope of $\frac{7}{8}$ -inch to 1 inch is adopted, and large loads are lifted by increasing the number of ropes; in cases where there is no limit to the size of sheaves and drums, as in mine hoists, one or a few large ropes are used. For small hoists small ropes are used, but it is not desirable to use many parts on account of the great wear of the rope passing around numerous sheaves.

Rope, Closing-and-hoisting. In two-rope grab buckets, the rope which passes through the bucket head, and which, when pulled, operates the closing mechanism. (See Bucket, Two-rope). Also called bucket hoisting rope or closing rope.

Rope, Cordage. Rope which is made from fibrous materials like manila, hemp or sisal. The fibres are of varying lengths; they are spun into yarns, the yarns into strands, and the strands are laid into ropes, the lay of the strands and the rope always being opposite. It is made up in three or four strands, with or without a center or heart, and is soft, medium or hard lay. The heart, when used, is a small rope having a diameter about one-third that of the strand.

Rope, Hemp. A rope made from fibres of the hemp plant. While strong and flexible, it decays rapidly when exposed to the weather, and is therefore often tarred.

Rope, Holding. In grab buckets operated by two ropes, the one which is attached to the bucket head and by which it is lowered. (See Bucket, Two-rope). Also called bucket lowering rope.

Rope, Manila. A rope made from fibres obtained from a species of wild plantain belonging to the banana family, and native to the Philippine Islands. The fibres are from 6 ft to 10 ft. long and very strong in tension, though weak transversely.

Rope, Shell. The term applied to the holding rope in some types of two-rope grab buckets where the top bucket head is extended downward forming a housing or shell for supporting guides on which the two spades or bowls slide.

Rope, Sisal. A rope made from the fibres of a plant grown in Yucatan, Mexico and Florida. It is in general inferior to manila in strength, appearance and wearing qualities. It is used for tying or binding purposes, and seldom for running around sheaves.

Rope, Wire. See Wire Rope.

Rope, Trip. A small rope which, when pulled (generally by hand) operates a latch or dog to release a moving part of an apparatus, such as a grab or turnover bucket.

Rotary Blower. See Blower, Rotary.

Rotate. To revolve or move round a center or axis, to have a continuous circular motion.

(See also Axis.)

Runway. The path or track over which anything regularly runs; a passageway or aisle which can be used for wheeled vehicles whether on rails or not. Also, the term applied to an assemblage of conveyor sections, and particularly to the parts on which the material transported actually rests, as distinct from the supporting structure, driving mechanism, etc.

Runway, Crane. A runway or track built to support a travelling crane, including its supporting girders. In overhead travelling cranes and gantries with partially elevated runways, it includes the line of horizontal girders and rails, with supporting columns and bracing. In gantry cranes, the runway is generally near the ground level, when it may consist simply of rails laid on a suitable foundation. In semi-portal gantry cranes, one runway is often on the edge of a roof.

In monorail installations the term refers to the overhead supporting rail, and may also refer to the clearance or passageway allowed underneath for the passage of the car and load.

Runways are sometimes designated as I-beam runway, channel runway, timber runway, etc., according to the kind of structural member forming the rail or rail support.

Runway, Gravity. See Conveyor, Gravity

Safety Hoist, Limit. See Stop, Limit.

Sand Sucker. See Dredge, Hydraulic.

Scale, Aerial Wire Rope Tramway. A weighing device, sometimes installed at one of the terminal stations of a double rope system. A short section of steel track is independently supported by scale beams and can be made to indicate or record the weight of a carrier and bucket passing slowly over it.

Scale Box. A term sometimes applied to a skip.

Scales, Suspension. A portable scale, arranged to hang on the lower hook of a crane or hoist, to weigh loads when they are picked up.

Score, Drum. The helical groove cut on the circumference of a winding drum to assist the rope or chain properly to distribute itself over the length of the drum. The score varies from a shallow groove whose profile is the arc of a circle of the rope diameter, with ropes just touching each other, to a groove with semi-circular bottom and slightly divergent sides, deep enough to entirely contain the rope, and spaced wide enough apart to allow for the thickness of the walls between. The length of the score should be enough to leave two turns of rope still wound when the load hook is at its lowest point.

For chain, the drum is scored with a plain groove so that alternate links may be flat and standing, with the standing links clear of the bottom of the groove, or the score may be a circular arc, to take the chain as it comes. Or, the score may be cast, with pockets to fit each link.

The simplest scoring is a single helix from end to end of the drum; this is seldom used in cases where the rope leads directly to the bottom block or load, except in the smaller cranes, as it causes an unsymmetrical loading of the crane structure. Two symmetrically disposed scores are usually provided, the two ropes winding toward the center as the load is hoisted.

Scow. A flat-bottomed boat, generally with flat sloping ends and without deck, used for transporting heavy bulk material such as dirt, gravel, sand, stone, garbage, etc.; garbage scows have hopper bottoms, by which the load may be dumped into the water.

Scraper, Buck. A horse-drawn scraper consisting of a vertical board 12 in. to 18 in. high and 4 ft. to 6 ft. long, with handles attached at the back. It is used mostly in filling trenches, being dragged toward the trench by horses on the other side, and pulled back and placed for a new load by one or more men operating the handles. (Also called trench filler.)

(See also Scraper, Fresno.)

Scraper Bucket, Drag Line. See Drag Line Scraper Bucket.

Scraper, Drag. See Drag Scraper.

Scraper, Drag Line. See Drag Line Scraper.

Scraper, Fresno. A horse-drawn drag-scoop scraper having a wide and rather short bowl. It is filled by dragging through loose dirt, with the cutting edge slightly depressed, and is dumped by turning over on adjustable runners which allow a complete dump or gradual spreading as may be desired. It is returned on the runners. On account of its short bowl it fills easily, and will follow up a steep bank without dumping. (Also called buck scraper.)

Scraper, Tongue. A drag scraper in which the horses pull the scoop by a forked tongue pivoted to it at its two sides, instead of by chains attached to a bail as in the ordinary drag scraper.

Scraper, Wheel. A horse-drawn scraper bucket consisting of a steel pan or scoop mounted on wheels and equipped with levers by which the cutting edge can be lowered to the ground for filling the bucket, and then raised clear while the load is being wheeled to the dumping point. To dump, the back end of the pan is raised until the cutting edge digs into the ground, when the continued pull of the team will dump the load. It is returned in the dumped position. An automatic front gate is sometimes added to prevent the spilling of material during long or rough hauls.

Screen. To separate a bulk material according to the size of the particles contained in it by passing it over one or more screens composed of perforated plate, woven wire, parallel bars or parallel rotating discs; also, to separate from the bulk all material above or below a certain size, or between certain sizes.

The term screen is also applied to the actual screening surface, to this surface with the frame on which it is mounted, and to the whole machine with its operating and auxiliary mechanism.

The simplest arrangement mechanically involves passing the whole mass over the finest screen first and thence over coarser and coarser screens, but this subjects the fine and delicate screens to heaviest wear, and it is therefore better practice to pass the mass over the coarsest

screen first, followed by the finer ones in succession. Screen installations may be classified according to their method of causing the material to pass over the screening surface as gravity, shaking, revolving, traveling bar and rotating disc; according to the service performed as sizing, rejecting, rescreening, washing, draining, drying and feeding; according to the conditions during screening as wet or dry, and according to the nature of the screening surface as woven cloth, perforated plate, bar or grizzly, or rotating disc.

Screen, Bar. A screen consisting of a series of bars placed parallel to the direction of flow of the material, and set into and held in place by notched bearers. The bars are of round, square, rectangular or special sections, a desirable form being one which will not allow pieces to pass part way through and wedge. Special arrangements of bars will sometimes serve to separate materials of different character without regard to size; an example being flat bars set inclined transversely for separating flat pieces of slate from coal if the latter breaks into pieces that are not flat. Also called a grizzly or a grizzly screen.

Screen, Chute. A screen inserted in the bottom of a chute, for the purpose of separating the dust or fines from the material passing over it. Used in wagon loading chutes at coal pockets.

Also called shoot screen.

Screen, Draining; Screen, Drying. A screen generally of the revolving type, which is arranged to drain or dry the material passing through it rather than to screen it. To accelerate the action, a blast of air, heated if desired, is often passed through and around the screen.

Screen, Gravity; Screen, Gravity Inclined. A screen which is set permanently at an angle that will cause the material undergoing screening to slide freely over it due to the force of gravity. This angle varies with the type of screen and the nature of material from 25 deg. to 45 deg. Bar screens, slotted wire screens, flanged lip screens and oblong perforated plate screens (flat or corrugated) are used. Knockers are sometimes provided to help keep the perforations clear; a light up-and-down vibration of the screen also assists in this.

A form of gravity screen intended for fine screening has a woven wire surface which is kept in vibration by hammers. (See Screen, Vibrating Wire.)

Screen, Grizzly. A term applied to a bar screen, either of the fixed inclined or the shaking type (see Screen, Gravity; Screen, Shaking), or of the rotary disc type (see Screen, Rotating Disc), or of the traveling bar type (see Screen, Traveling Bar).

Screen, Lip. See Screen, Perforated Plate.

Screen, Perforated Plate. These are made with round, square, needle slot and oblong or oval perforations in brass, iron, steel or manganese steel plates. Round and square holes are generally staggered; oblong holes may be end staggered or side staggered (also termed hit-and-miss-endways or hit-and-miss-sideways); oblong and needle slot perforations may be longitudinal (or straight), transverse (or cross), or diagonal. The plates may be curved to fit conical or cylindrical screen frames, and arranged in panels, or they may be used perfectly flat with either transverse or diagonal corrugations called ruffles. These corrugations serve to stir up the material passing over the screen and prevent it from moving *en masse*. The same thing is accomplished by lip screens which are perforated plate screens formed into transverse steps about 12 inches long with a drop of 1 in. to 2 in.; each step has a series of parallel longitudinal slot

perforations widening toward the lower end, and curved down over the step. In addition to agitating the material, these screens are self-clearing in that the effect of the lower end of the slot is eliminated, and lumps which pass only partly through the slots slide out onto the next step.

The thickness of plate screens increases with the size of the perforations, and shape and spacing of the perforations vary with the sizes to be produced, the type of fracture and other properties of the material.

Screen, Primary. The first or initial screen, in plants where the same material is subject to successive screenings for the purpose of more thorough elimination of foreign matter, or more thorough mixing of added ingredients.

Screen, Rejection. A screen which separates out for rejection from the succeeding processes all material above a certain size as determined by the size of the openings. This material is either discarded, or is subject to a special crushing preliminary to use.

Screen, Revolving. A screening device in which the woven wire fabric, perforated sheet metal or other screen material is arranged around the exterior of a cylindrical, conical, hexagonal prismatic or hexagonal pyramidal frame, supported so that it can rotate with its axis horizontal or slightly inclined. The material to be screened is delivered to the interior at one end and, as it works toward the other, is separated into two or more portions graded according to size.

These screens are made up in several ways. For the heaviest service perforated plates, sometimes of manganese steel, bent to the proper cylindrical or conical form, are bolted to a frame which has at its ends heavy tread rings or tires running on small chilled wheels supported in bearings and called trunnion wheels; additional intermediate tires are used if the length warrants it. This is termed the trunnion, tire, treadway or friction ring type. The screen is rotated by power applied to the wheels or rolls on which it is supported, turning the latter by friction or by a pinion meshing with a large ring gear cut on one of the tires. It may also be rotated by a bevel gear or a large ring sprocket on one of the tires, or on the end ring at the receiving or discharge end. If the discharge end frame is solid, the screen surface must stop short of the end frame, leaving a gap through which the oversize material may discharge. The other types have a clear discharge opening, and all have clear receiving ends. If the screen is conical, the shaft is horizontal; if cylindrical, the shaft is inclined and a thrust bearing must be provided. This may be arranged in the bevel gear drive type by a steel button thrust in the end of the shaft in the main bearing at the discharge end; in the open end type rollers must be provided bearing against a surface on the end face of the end ring, and these rollers are conveniently two in number and placed on a transverse shaft across the center of the end, the discharge passing beneath it.

For lighter service the spider or shaft construction is used, consisting of perforated plates or woven wire material attached to a frame made up of longitudinals fastened to a series of frames or spiders mounted on a through shaft carried in bearings at each end. Main reliance is placed on the shaft to stiffen the screen, and it is sometimes trussed for added stiffness. One or more intermediate spiders sometimes have a flange projecting outward between the two adjacent screen sections attached to it, resting on rollers, to assist in carrying the weight; this makes a combination type. The screen is rotated by

power applied to the shaft by a pulley, gear or sprocket drive.

Hexagonal screens are usually made up in the spider form and the perforated metal or woven wire screen is side to side of the material passing through them as disside to side of the material passing through it, as distinguished from the rolling in the cylindrical or conical screens. The throwing action can be obtained in the latter, however, by fitting a number of longitudinal inwardly projecting baffles.

Conical screens are sometimes supported on an overhung shaft attached to a heavy spider secured in the small end of the cone. The material is fed into the large end of the cone by a chute extending the full length to the small end, and the revolving screen returns the over-size to the large end where it is discharged. Cylindrical screens are also sometimes overhung; in this case the material which will not pass through must be removed by hand or some special mechanical means. A cylindrical or conical screen may have one size of mesh or perforations throughout its length; all oversize material is discharged at the end, and all material smaller than the size of the openings passes through them. A concentric cylindrical dust jacket is sometimes added externally for part of the length from the receiving end; it is of fine mesh, and allows the dust to pass through, but retains the desired material and delivers it at the end of the jacket. This principle may be extended by the use of multiple jackets placed concentric with the inner one, successively shorter at the discharge ends and of finer mesh or perforations, counting from the inner screen outward. The innermost jacket separates all oversize and delivers it at its discharge end; the next jacket retains all above the size of its mesh and delivers it to its discharge, distinct from the discharge of the jacket, and each succeeding jacket acts in the same manner. Hexagonal screens are similarly jacketed.

Another method of securing separation into several sizes is to have a single covering of several sections or compartments on the same cylindrical or conical frame, with the mesh or perforations increasing in size from section to section as the material progresses through the screen.

Revolving screens may be entirely open, or completely enclosed in housings to retain the dust; this settles to the bottom and is removed at intervals by hand, or continuously by a small conveyor.

A dead plate or unperforated section is sometimes left close to the receiving end, to insure the breaking up of the material received upon it, or to allow a better washing by water supplied at this point.

A renewable "wearing skirt" is also sometimes applied just within the receiving end, to receive the impact of the material from the feeding chute.

Revolving screens are sometimes made up with screening surfaces composed of longitudinal bars held parallel by the spiders or trunnion rings, like an elongated squirrel cage. These will stand very severe wear. An inner screen of this sort is sometimes inserted within a perforated metal revolving screen to take out the oversize and save the perforated surface from the excessive wear due to the presence of large and heavy pieces.

Screen, Rotating Disc. A screening device consisting of a series of notched cast iron discs loosely mounted on a number of parallel square shafts, all driven at the same speed and in the same direction by outside gearing.

The top edges of the discs are all in the same plane, which is inclined downward in the direction of travel about

7 deg. The coal or other material is fed in at the upper end, resting on the edges of the discs, and is passed along by their rotation, the fine material dropping between them. Also called a rotary grizzly. Another type consists of a single shaft with a series of equal sized discs spaced apart by separators. Material like coal is fed onto the advancing side near the top, the fines dropping through and the lumps carrying over into the discharge. This is a convenient method of reducing the load on a crusher by separating the fines from the lumps before delivering the latter into the crusher. Also called a rotary grizzly feeder.

Screen, Shaking or Shaker. A screening surface held in a frame in a slightly inclined position and reciprocated or shaken horizontally by some means, to agitate the material passing over it and to assist in its movement. The screen is supported at its four corners and at intermediate points, if its length requires, by rod and pin suspension from above or by rollers from a track below. Another type is the flexible or spring board support, consisting of a number of thin hickory or ash boards fastened securely to the screen and to the supporting building structure from either above or below.

The oscillation is usually caused by a rotating shaft having eccentrics connected to the screen frame by wooden eccentric rods. Somewhat better action can be secured by cam operation, giving a slow advancing motion and a quick return, and with this arrangement the screen need not be inclined. The same effect is secured by a quick vertical drop at the end of the forward motion. In another arrangement the ends of the screen are supported by eccentric straps carried by eccentrics on parallel shafts rotating in synchronism; the screen thus has a small motion of circular translation which assists in moving the material.

A series of shaking screens arranged end-to-end may be used to produce several sizes, but to economize horizontal space they are often arranged above one another in several decks, each discharging its own oversize at the lower end. The separate decks are sometimes called leaves.

Shaking screens produce considerable vibration in the building, and this may be minimized by arranging the screens in pairs driven by the same shaft, with eccentrics 180 deg. apart so that the two screens of the pair are always traveling in opposite directions, or "throw" against each other. Single screens may be balanced by reciprocating counterweights. The reciprocations vary from 100 min. to 150 per min. and the throw is greater for larger sizes of material than for small.

Shaking screens may be made self-feeding by providing a blank sheet at the top, set at a small angle like 6 or 7 deg., on which the material is dumped and on which it spreads and feeds to the screen with moderate regularity. Veil sheets are also often fitted to screens over which it occasionally may be necessary to carry the material without screening; these consist of unperforated plates which can be laid on the screen surface.

A two-deck shaking screen, may have the decks carried at the top and bottom ends of four rockers which are themselves oscillated by opposed eccentrics; much of the vibration may be removed by thus producing opposite throws of the two screens. Also called a duplex rocker shaking screen.

The screening surface of shaking screens may be of the bar or grizzly type, woven wire cloth, or perforated

metal; a special form of the latter known as a lip screen is widely used.

Screen, Sizing. A screen which separates a material into a number of different grades according to the size of the particles, usually designated by stating the openings through which each size will and will not go.

Screen, Suspended. A horizontal rotary cylindrical screen which is suspended at two or more points by belts passing around it and also around pulleys on a shaft above, which is also the driving shaft. Longitudinal baffles are attached to the outside; mixed sand and "tailings" are discharged onto the outside on top; the coarse tailings are carried over the side and away; water and fine tailings, which it is desired to save, pass through the screen surface and are caught by an internal sloping pan.

Screen, Traveling Bar. A screen consisting of a series of parallel steel bars attached at each end to chains and made up into an endless belt passing over a pair of sprockets at each end, with the runs horizontal. Material is received on the upper run; the fines drop between the bars and are deflected to one side, while the lumps are retained and pass over the head sprockets. The device serves as a feeder to a crusher, also relieving it from unnecessary work by removing the fine material. A second belt of more closely spaced bars may travel within the first, on smaller sprockets on the same shafts, allowing separation into three grades according to size.

Also called traveling grizzly bar feeder.

Screen Veil. A steel plate which can be laid over a screening surface when it is desired to pass material to a point beyond the screen without performing any separation by it.

Screen, Vibrating Wire. A form of gravity screen in which the woven wire screen surface is stretched taut and kept in vibration by a series of small hammer blows produced by cams. Material is fed continuously at the upper side of such a sloping screen and is screened as it passes down over the surface, the vibration preventing clogging and assisting in the movement. Its special field is for fine screening, and it is sometimes called a separator.

Screen, Washing. A screen in which water is supplied to wash the material (such as sand or gravel) while it is being screened, to remove loam, slime or other undesirable constituents. Where division into a number of sizes is performed, the same water usually washes the material in each screen in succession, starting from the coarsest and ending with the finest; it then passes into a settling tank in which one or more of the various sizes of sand may be separated.

Revolving and flat screens are both used for washing purposes, but special arrangements must be made to secure all possible washing effect from the water before it passes away through the screen.

Screenings. The term applied to material separated out by screening operations, usually the fines or undersize material, and considered as the refuse or by-product of that particular operation. Thus at coal pockets, the fine material which drops through the screens in the bottom of the loading chutes is termed screenings.

Screening Plant, Portable. A screening outfit which is mounted on wheels or otherwise arranged so that it may be easily moved from place to place. It usually consists of a combination of an elevated revolving screen with suitable bucket elevator for raising the material from a pit in the ground and dumping it into the screen, a series of bins for receiving the sized material, and a

source of power such as a steam or internal combustion engine, all mounted on a substantial body resting on wheels.

Screw, Cap. A bar or bolt having a solid head at one end and a thread in the other, the head being smaller than a standard bolt head, and slightly rounded on top.

Sealing Machine. A device for sealing corrugated or solid fibre shipping containers. The machine is commonly used in a line of gravity conveyor extending from the packing to the shipping department. The action of the machine in applying the adhesive and flaps is practically automatic. The sealing is done by flexible rolls which apply uniform pressure regardless of surface irregularities. A wide range of package sizes may be handled by one machine.

Page 764.

Separator, Magnetic. An electro-magnetic device for separating iron or steel pieces from a stream of bulk material so as to prevent damage to crushers or rolls to which it may be passing. In one type the magnetic material is deflected from a falling stream so that it passes inside of a partition, the remainder falling straight down and staying on the outer side. Another type consists of a magnetic head pulley for a belt conveyor, in which the iron and steel is held against the belt while it passes around the pulley and after it has delivered the other material. The separation of the belt from the surface of the pulley as it starts on its return removes the iron so far from the influence of the magnet that it falls free. In a third type the magnetic material is pulled to one side or to the bottom of the channel in which it is flowing, where it is retained and accumulates until it is removed from time to time by hand. (See Spout, Magnetic.)

Direct current must always be used for these magnetic devices, and arrangements should be included by which a warning is given when the current is cut off from the magnet.

Separator, Steam. A device for removing the moisture from steam, usually before it goes into an engine. It consists of a chamber in which the steam is given one or more sharp turns, throwing the moisture out by centrifugal force; the water runs to the bottom and is blown out from time to time or is removed by a trap.

Separator, Water. A chamber or pocket in a compressed air line, arranged to remove water from the air passing through it. The principle of centrifugal force is usually utilized. (See also Air Receiver.)

Set-screw. A machine screw which prevents relative motion of two parts in contact by being screwed through one, and having its point forced or "set" into the other. It is used generally to secure hubs of small pulleys, etc., to their shafts. The heads are generally square, but may be slotted.

Shackle. A stirrup or piece bent into U-shape, with eyes in the two ends, used to attach a link or eye through which it passes, to another similar part by means of a bolt or pin passing through the two eyes.

Shackle, Guy. A shackle used for attaching a guy line to a derrick. A thimble or a sheave may be placed on the pin or bolt to bend the wire rope around preparatory to clamping it to the standing part of the guy.

Shackle, Screw. A shackle in which the pin is screwed into one side, to prevent it from falling out.

Shaft. A long cylindrical machine member rotating in bearings, and subject mainly to torsion. It may have cranks, gears, cams, pulleys or sheaves fastened to,

and transmits power between them by torsional stress in the shaft. When the torsion is only incidental, and bending is the principal stress, the member is called an axle, which see.

In mining, a vertical or inclined excavation made in opening the ground for mining purposes. All of the material excavated is hoisted through the shaft, and all tools and equipment required for the work are lowered through it. It also contains the pipes connected with the pumping system, and the lines of power transmission.

Shaft, Cross. In bridge cranes, the bridge driving or squaring shaft.

Shaft, Foot. The term applied to the shaft carrying the lower of the two principal wheels, or sheaves, round which passes the endless chains or ropes of various types of inclined belt or apron conveyors, continuous bucket elevators, etc. Also called the tail shaft.

Shaft, Head. In elevators, elevator conveyors, mine hoists, etc., the shaft carrying the sheaves, sprockets or drums around or onto which pass the ropes or chains carrying the load. Where the rope or chain is endless, as in bucket elevators, the lower shaft is called the foot shaft in distinction.

Shaft, Squaring. The shafting connecting the wheels on the two tracks of a travelling crane, used to drive the crane, and to force the two ends to travel at the same speed and keep the bridge "square" with the runway. At one time cranes were pulled along by a rope, and this shaft had no function except that of squaring. At present it is utilized as the drive shaft, and is geared directly to the bridge travel motor.

In gantry cranes the squaring shaft is carried across the bridge, and extensions down the end frames connect to the wheels by bevel gearing.

Occasionally the crane gets out of square in spite of these arrangements; it can be squared by running it against the stops at one end of the runway, and exerting sufficient pressure to slip the wheels on one side a slight amount.

Shafting, Flexible. A shaft which is constructed in such a manner that it can be bent to a considerable extent and still transmit power smoothly.

All types consist of a flexible central core which rotates and transmits the power, and an outer cover or casing which serves as a long bearing for the core, and which enables it to be held in the hand or moved about without causing damage. In one type the core is composed of from two to five layers of closely coiled steel wire, the direction of winding of successive coils being opposite. The outer casing is a tube made of flat or square steel coils closely wound, and covered with an outer layer of leather. Another type has a central core made of a chain of short links which are hooked into each other in such a way as to be sufficiently flexible.

A certain degree of flexibility can be given to lines of shafting by the insertion of universal joints at intervals.

Shears, or Shear Legs. A type of crane much used in ship-yards for fitting out, in which a long boom made of two converging members is pivoted at the bottom on a foundation, and carries the hoisting tackle at the top. It has a small horizontal range by means of the in-and-out swing of the long-legged boom, and the vertical range is limited only by the height of the shear legs. It is never allowed to swing very far forward, and never backward. It is ordinarily swung out by slacking on guys attached to the top and extending to anchorages a considerable distance to the rear. Occasionally a third or back leg is

provided, pivoted to the main legs part way up or at the top, and extending downward to the rear; the lower end is mounted on wheels and is rolled along the ground under the control of tackle or a screw, thus swinging the top outward, or luffing it.

Page 801, 802.

Sheave. A wheel or disc of wood or metal, having one or more circumferential grooves shaped to receive a rope or chain, and free to rotate on a shaft. Wood sheaves, as used in small blocks, are generally made of lignum vite with bronze bushings. Metal sheaves are plain discs; hub, web and rim construction; or hub, spokes and rim; in accordance with the size.

A sheave is usually free on its shaft, and without gearing, serving merely to change the direction of the rope passing around it. The term is, however, sometimes incorrectly applied to narrow drums used for winding purposes and to the driving or driven pulleys of a rope drive. (See also Sheave, Chain; Sheave, Gravity Plane.)

Sheave, Bicycle Spoke. A grooved sheave for wire or manila rope which is made up of a hub, grooved rim, and radiating wire spokes connecting them, like the wheel of a bicycle.

Sheave, Chain. See Wheel, Chain.

Sheave, Elevator. A special concave surfaced drum of large diameter fastened on the end of the drum shaft of a winch, and used for operating material handling elevators, as in building construction. A rope has its two ends connected to two elevators, or to one elevator and a counterweight, and is passed around the drum for one or two turns. The drum may be disconnected from the winch shaft by a jaw or friction clutch, and a foot-operated band brake enables it to be retarded or held at any point desired.

Sheave, Fixed. A sheave whose axis is fixed in location; also a guide sheave.

Sheave, Gravity Plane. A brake-controlled sheave located at the top of an incline, by means of which control is maintained over a downward moving loaded car which is only partially counter-balanced by the upward moving empty car connected to it by a rope passing over the sheave. A single turn of the rope around a sheave would not give sufficient traction to prevent slipping, so two multi-grooved sheaves mounted on parallel axes and provided with brake bands are anchored to a foundation, and the rope is passed around them in succession in figure eight turns. The rope ends are fastened to the cars.

A motor drive is sometimes added to the sheave, to assist in starting, and to raise a loaded car in case it should be necessary.

Sheave, Grooved. See Sheave, Rope.

Sheave, Guide. A sheave located in such a way that it guides a rope in a desired direction, generally onto a drum, or into the plane of another sheave.

Sheave, Load. In a chain hoist, the sheave from which the chain or rope carrying the load is pendent.

Sheave, Pendent. In rope tackle, the lower or fall block.

Sheave, Rope. A sheave having a circumferential groove shaped to fit rope. If for wire rope for power transmission, the groove is shaped so that the rope does not touch the sides; if for hoisting, the groove should fit the rope closely to enable it to hold its shape under heavy load. Idler sheaves for manila rope usually have grooves which approximately fit the rope, but do not wedge it.

Wide faced freely turning sheaves with numerous

grooves are usually called idler pulleys; when keyed to their shafts and used for actual power transmission they are called rope drive pulleys.

Sheave, Water. A sheave which is designed for use in a fall or bottom block which passes under water, as in the hoisting of dredge dippers, grab buckets, etc. Grease lubrication is usually arranged to prevent grit entering the bearing, and the sheave is thoroughly housed to prevent fouling from roots or other objects.

Shell. The name given to the frame or central portion of one type of clamshell grab bucket, which includes the top head, attachments for corners of the spades, and guides for an internal vertically sliding crosshead which, with the sheaves in the head, forms the operating mechanism of the bucket. The shell is usually made of steel plate; the rope attached to it is called the shell rope, instead of the holding or lowering rope as is more general.

Ship, Self-unloading. See Unloader, Self-unloading Ship.

Shovel, Crowding Motion. The thrusting motion of the dipper handle of a power shovel, by which it is forced downward or forward into the digging. Two types are in use: the shipper shaft crowd, in which the dipper handle is moved lengthwise (see Shovel, Steam, Crowding Engine); and the horizontal crowd, in which the upper end of the shovel handle is moved horizontally forward. The dipper hoisting motion is operated simultaneously with either of these.

Also called thrust or thrusting motion.

Shovel, Gasoline. A power shovel which is driven by a gasoline engine. Instead of having a number of separate engines, as is usual with steam shovels, there is usually one governor controlled internal combustion engine running at approximately uniform speed, having numerous friction clutches by which the various parts of the machine can be brought into operation as desired. Gasoline is often cheaper and is always more easily transported than coal, and a gasoline shovel is independent of water supply, except for the small amount required for cooling purposes, and this need not be of a quality which would be suitable for boiler feed. Gradual starting and smoothness of operation are, however, more difficult of attainment, and repairs are apt to be higher.

Shovel, Horizontal Crowding. A power shovel in which the upper end of the dipper handle may be moved forward horizontally at the same time the dipper is pulled forward by the hoisting rope. It is useful for producing smooth, level cuts, and for tearing up surfaces of roads without disturbing the foundation structure.

Some machines give a very long horizontal "crowd" by having a special arrangement with a scoop traveling along the lower side of the boom, which is lowered to a horizontal position during filling, and raised and swung for dumping.

Shovel, Power. A power driven excavator, in which the digging element is usually a scoop or dipper mounted on a handle and operated by a combination of a geared attachment to a boom, with wire ropes or chains attached to the dipper and also operated from the boom. This apparatus, with its operating machinery, boiler, etc., is mounted on a car with flat or flanged wheels, or on a track-laying truck, and is usually self-propelled. Steam power is in most general use, but internal combustion engines are also used, and occasionally electricity. (See Shovel, Steam; Shovel, Gasoline.)

Several forms of digging element other than the dipper and handle are in use. In some of these a shovel-shaped

scoop is thrust forward into the material and is raised, swung and dumped in much the same manner as a hand shovel. This motion is obtained by operating the scoop by a series of linkages and bell cranks mounted on a revolving turntable, or by having the scoop move along the lower side of a nearly horizontal boom, filling as it moves outward, after which the boom is raised and swung to the dumping point. (See Loading Machine, Coal.)

Page 235.

Shovel, Power. A power-operated machine used for "cleaning up" the ore, coal and similar bulk material left in the hold of a vessel (or a storage space) after the unloading machines have taken all that they can reach. It consists of a gasoline engine driven truck on the front of which is mounted a shovel scoop arranged so that it can be elevated and dumped in front of the machine. In operation it is forced under the ore until it is filled, and is then raised; the machine is backed and run to a point under the hatch that can be easily reached by the unloader grab bucket; there the operator dumps the load by pulling a latch. The machine is lowered to the hold and raised afterward by suitable hoisting lines from the regular unloading mechanism.

Shovel, Power. A device for assisting in the hand unloading of bulk material from box cars, consisting of a large scoop, with handles at the back for guiding, connected by a rope led over suitably arranged pulleys to an automatic winch. The operator carries the scoop to either end of the car, the rope unwinding freely from the drum. Upon plunging the scoop into the material, the rope is momentarily slackened and a counterweight on the drum mechanism automatically reverses the drum and throws in a jaw clutch. This winds up the rope and draws the scoop with its load to the car door, at which point a trip on the mechanism disengages the clutch, and the operation may be repeated.

Shovel, Railroad. A steam shovel of the straight line type consisting of a railway car mounted on two swivel trucks and carrying at one end a dipper mounted on a boom which can swing through approximately a half circle. The boom heel is pivoted in a swing circle, and a topping lift from the boom point is attached to the top of an A-frame. (See Shovel, Steam.) The A-frame may be swung back and forth in some cases, thus raising or lowering the boom; this is usually necessary in shovels which must travel along a railroad right-of-way without partial dismantling.

The remainder of the car is devoted to the operating machinery, boilers, fuel, etc. Powerful outriggers, (also called spreaders or jack arms) on each side of the car at the dipper end rest on screw jacks supported by blocking and keep the shovel from tipping when the dipper is cutting directly at the side.

These shovels are the most powerful made, and when the dippers are provided with proper teeth will cut through almost any material except solid rock.

Page 235.

Shovel, Revolving. A power shovel which is mounted on a turn-table and is capable of being swung in a complete circle. All the operating machinery, whether steam or internal combustion engine, is mounted on the revolving deck, and placed so as to counterbalance the weight of the boom and the shovel thrust. The turn-table is mounted on a base which may be supported on track wheels, traction wheels, or track-laying trucks. One type, used in railroad work, is mounted on flanged wheels,

stands on rails laid on a flat car and is capable of self-propulsion along the car. A variable topping lift is often used, necessitating an additional winding drum. (See Shovel, Power; Shovel, Steam.)

Page 237.

Shovel, Ship. A term applied to a type of power shovel used in unloading grain from the holds of vessels, where it is used to move the grain toward the point where the buckets on the marine leg can reach it. It thus serves as a power-operated hand-controlled feeder device for the marine leg. The operating rope is sometimes led down the leg into the hold and thus always operates toward the leg.

Shovel, Shipper Shaft Boom or Shipper Shaft Crowd. A power shovel in which the crowding motion is given to the dipper by a shipper shaft mechanism. (See Shovel, Crowding Engine.) The engine is usually mounted on the upper surface of the boom near the center of its length.

Shovel, Steam. A power shovel operated by steam engines. The type in most common use consists of a digging element in the form of a scoop or dipper mounted on the end of a dipper handle. This handle is pivoted to swing in a vertical plane about a horizontal axis or shaft called the shipper shaft near the center of a supporting boom. The handle can also be run in or out lengthwise by engine-driven gearing mounted on the boom, and meshing with a rack on the dipper handle; this action is termed crowding. The boom is double for a portion of its length and the dipper handle swings between the two sides.

Steam shovels may be divided into two classes—the straight line shovel, and the revolving shovel—depending on the way the boom is swung in a horizontal direction. In the straight line type (also called the standard and railroad shovel) the heel or inner end of the boom is mounted on a swing circle allowing motion about a vertical axis; the point or outer end is attached by a topping lift to a head casting pivoted at the top of an A-frame. The boom may then swing approximately 180 deg., or until the boom touches the A-frame legs on each side. In the revolving shovel, the boom, A-frame and all operating gear are mounted on a revolving platform which may make complete rotation if desired.

The dipper has a hinged dipper door at the bottom and a bail at the top to which is attached chain or wire rope tackle led around sheaves at the boom point and thence to the hoisting drum on the winch. The dipper door is held shut by a latch which can be released by a trip rope pulled by the engineer.

All the machinery, with boiler, is mounted on a wheeled platform or car, which may or may not be self-propelled.

All sizes are mounted on flanged wheels for railways, or on track-laying trucks; the smaller sizes are also often mounted on flat traction wheels. One type is mounted on a railway flat car, but on longitudinal rails of which it can travel from one end of the car to the other.

In operation the dipper is forced downward and outward against the material by the crowding engine, and is pulled outward and through the material by the hoisting rope attached to the bail. The dipper and boom are then swung to the dumping position and the latch pulled, dumping the contents. Two operators are generally required, one called the cranesman, to manipulate the dipper, and the other called the engineer, to run the engine and operate the winding drum.

The specifications of capacity usually include the following: maximum dumping radius, clear dumping height,

level floor radius, maximum height of cut, and depth of cut below floor (track) level.

Page 235.

Shovel, Traction. A steam shovel which is mounted on flat tread wheels or track-laying trucks and can propel itself over the ground. It is made in both the straight line and the revolving types.

Shovel Boom. The boom of a power shovel, on which the dipper is mounted. It is commonly used at a fixed inclination, is mounted on a swing circle at its heel (see Swing Circle), and has its point or head supported by a boom suspension pivoted to the head of the mast or A-frame. If the inclination is to be varied, a horizontal pivot must be supplied at the heel, and a variable topping lift; this is sometimes obtained by swinging the A-frame out of the vertical.

The boom is usually made double for part of its length, and the dipper handle swings between the two portions. The crowding engine and shipper shaft mechanism are mounted on the boom at about mid-length.

Booms are made of wood, of wood with steel reinforcements and wearing plates, of wood completely enclosed and armored with steel, and of steel alone, the last usually being of braced construction. Wood offers greater flexibility and resilience than steel alone.

Shovel Dipper. The digging element of a steam shovel or dipper dredge. It consists of a bottom dumping bucket having a hinged dipper door, mounted rigidly (sometimes adjustably) on the end of a long arm called the dipper handle, which can be moved lengthwise by engines and gears mounted on a boom. This engine, called the crowding engine, furnishes the power for holding the dipper against the material to be excavated. The dipper is pulled through the material and afterward lifted by a one, two or three-part dipper hoist rope, led from the dipper bail around a sheave at the boom end, and thence to the hoisting drum of the winding machinery. The door is hinged to the back of the dipper and is held shut by a latch which can be released by a trip rope operated by the engineer.

The dipper is of steel, and the front part, which receives the hardest treatment, is often of manganese or high carbon steel.

Shuttle Car. See Skip Car.

Sill. In a stiff-leg derrick, the heavy timber lying on the ground, and connected to the mast step at one end and the bottom end of a stiff-leg at the other. Also called lie-leg.

Silo Bin. See Bin, Cylindrical.

Skip. A shallow, flat-bottomed, straight-sided wooden box reinforced with iron fittings, with top and one end open, supported by three chains leading to a common ring for hanging on a derrick hook. The chain supporting the open end is provided with a trip hook for dumping. Used for dirt, rock, etc., and filled by hand shoveling, when a grab bucket is not available. Also made of steel throughout. Sometimes called derrick skip or stone skip.

The term is also sometimes applied to a similarly used flat rectangular wooden platform with rope slings from each corner connected to a ring at the point of attachment of the hoisting rope. (See also, Skip Car; Skip Bucket; Skip Hoist; Scale Box.)

Page 313.

Skip, Bottom Dump. A type of skip bucket used in hoisting material from mines, which discharges its load by opening a door on the side near the bottom. This door or gate, which also forms a discharge trough when open, is pivoted at the lowest point of the sloping

bottom, and is connected by links to a pair of rollers running in a guiding groove or cam attached to the skip guides. Curvature of this groove at any desired point causes the door to open; reversal of the direction of the movement of the skip closes it, and it is so locked in this position that it cannot open except under the action of the curved groove.

Skip, Cableway. A skip arranged to be carried on a cableway. It is attached to the traveller by three chains, two on the sides with a spreader between them, and one on the back; it is dumped by hitching another chain at the back and lifting.

Skip, Dumping. A large dumping bucket, with a wide flaring front, making it a combination of an ordinary bucket and a skip in form. Supported by a bail and emptied by dumping.

Skip Bucket. A bucket arranged to run in the vertical tower or shaft of a skip hoist. It is usually of rectangular section, open at the top, and is pivoted at or near the bottom in a vertical rectangular frame which slides in vertical guides in the tower; this frame has the hoisting rope attached to its head. A second rope is led to a counterweight, or two cars are used, each serving to counterbalance the other. An additional set of bucket guides enclose projecting rollers on each side near the top and keep the bucket upright, except when it is to be dumped.

In operation the bucket is filled in a loading pit at the bottom of the tower (or shaft) and is hoisted. At the dumping point the bucket guides curve outward into a horizontal position, thus carrying the top of the bucket outward; as the bottom is pivoted in the frame it therefore continues upward, dumping the contents of the bucket.

Page 826-833.

Page 817.

Skip Car. A four-wheel car arranged to run on the track of an inclined skip hoist. It is open at the front end; often the top is also partly or entirely open. The wheels are mounted on two through axles beneath the car, or, in some cases, on two spiders riveted to the sides of the car. The rear wheels have an extra wide tread, sometimes of two diameters, the outer treads being used only at the top of the hoist for dumping purposes. A bail is attached to the sides or bottom of the car, partly or entirely surrounding it, and to it is attached the hoisting rope which leads to the winch drum. A second rope is led to a counterweight; sometimes two cars are used, each serving to counterbalance the other. Occasionally a skip car runs on a vertical track, the hoisting line being led off at such an angle as will keep the wheels against the rails.

In operation the skip car rests in the loading pit while it is being filled from a hopper through spouts with control gates, etc. It is then hoisted up the incline, until, near the top, the rails curve sharply inward, assuming a horizontal direction. The outer treads of the rear wheels however continue upward on special dumping rails which are provided at this point, thus elevating the rear and dumping the contents of the car. The winch is then stopped and reversed, lowering the bucket to the loading pit.

Page 621, 826-833.

Skip Hoist. An arrangement for the intermittent hoisting of material in bulk, consisting of a tower with guides, or an inclined runway with tracks, on which the load carrying skip bucket or skip car, often called a skip, runs. Wire hoisting rope leads from the skip overhead sheaves and

leading sheaves to a single drum hoisting winch (usually electrical) which is operated through a control panel; a push button for starting and stopping is located where convenient. A hopper with loading spout and gate at the bottom is arranged for loading the skip when it is in the pit, and it is emptied at the top by dumping.

The various operations may be manually controlled, partly automatic, or fully automatic. (See Skip Hoist, Automatic.) For methods of dumping, see Skip Car, Skip Bucket.

Skips are also used in mine shafts for hoisting material to the surface, the arrangements being similar to those described, except that the capacity is usually very large.

Page 585, 826-833.

Skip Hoist, Automatic. An electrically driven skip hoist which operates continuously, starting up when the load in the skip has become equal to a predetermined amount shutting off on the way up the valve by means of which it is filled, dumping at the top, waiting a sufficient interval for all the contents to pass out, and returning to the loading pit at the bottom, where it automatically opens the loading valve and is ready to repeat the cycle.

The automatic loading and starting are often omitted, and the operator opens and closes the filling valve, and starts the machinery by pressing a button. The bucket then is hoisted, dumped and returned ready for another load. When the hoist is of the double balanced skip variety, this method of control is customary, the dumped bucket remaining at the top until the operator fills the one in the pit and starts the mechanism by pressing a button.

The hoisting winch is slowed down and stopped at each end of its travel by a traveling cam limit switch or its equivalent. The pause during dumping to give the contents time to slide out is obtained by a timing relay.

Page 585, 826-833.

Skip Hoist Guides. The guides in a skip hoist tower on which the bucket frame travels in a vertical direction. They may be mounted on a framing entirely surrounding the space occupied by the bucket, the guides themselves being on the middle of opposite sides, called box guides, or they may be mounted against the face of the framing, guiding the bucket at two corners, called open guides. If a counterweight is used, guides are provided for it in a separate runway.

Skip Hoist Pit. The well or depression in which a skip car rests at its lowest point of travel, while being filled.

Skip Hoist Valve. A gate for controlling the flow of material into a skip car or bucket when it is in the loading pit. (See also Valve.)

Skip Hoist Winch. A single drum geared winding machine, steam or (usually) electrically driven, and arranged for doing hoisting work in a skip hoist. (See Skip Hoist, Automatic.)

Skirt Boards. Flat guiding pieces, usually of wood, placed along the sides of various types of continuous conveyors and elevators, to assist in retaining the material carried or to center it on the moving member during loading operations. These may be vertical (set on edge), inclined or horizontal; they may be placed at certain places only, as at loading hoppers, or may extend the length of a run; they may be plain or fitted with rollers at intervals, or may even consist of moving belts or aprons set on edge and moved at the same speed as the conveyor.

Slack. Small sized bituminous coal, such as will pass through a screen having openings from five-eighths to three-quarter inch in size.

Slack-rope. The rope which is used to tighten the track rope in a slack-rope cableway excavator. One end is led to a winch drum, and the other after being reeved through a block on the end of the track rope and another on the tower, is dead-ended on one of them. (See Excavator, Slack-rope Cableway.)

Slewing. (Also spelled Sluing). The act of rotating a crane about its vertical axis, often called swinging. Performed by hand in small cranes, but it is a power operation in larger ones. There are two common methods: by means of a grooved wheel fast to the bottom of the mast, which is pulled around by ropes wrapped around its circumference (see Bull Wheel); and by a large ring gear fast to the foundation or base, with teeth on its circumference meshing with a small pinion projecting down from the revolving platform above, and driven by power in either direction desired.

Slewing Engine. An engine, generally steam, used to operate a slewing winch for swinging a derrick or other crane. (See Winch, Derrick Slewing.)

Page 803, 828.

Slewing Rack and Pinion. Term applied to the ring gear and pinion used for slewing cranes. (See Bull Gear; Crane, Locomotive.)

Sling, Closing. A piece of wire rope forming part of the closing mechanism of one type of grab bucket. (See Bucket, Power-wheel.)

Slings. Short pieces of rope or chains with eyes or rings in the ends, which are passed around or under heavy weights, to be lifted by a crane or hoist. They are often especially rigged for certain work as box slings, barrel slings, etc. Ordinary manila rope, wire rope or chain are much used, and also special flat rope slings of manila or wire are made, with the necessary rings or thimbles in the ends. Chain slings are liable to damage finished surfaces unless special protectors are used, and they become so hardened by repeated service that they are liable to snap without warning unless frequently annealed. Slipping of the links also causes heavy stresses in the crane.

The very best material should be used for all lifting slings, and the allowable loads should be marked on them, or should be posted where they may easily be seen by those in charge of hoisting operations.

Slip Ring, Electrical. A band or ring of metal placed on a rotating part and preserving electrical connection with a fixed point by means of a brush or rolling contact.

The ring of the turntable of a locomotive crane, when it rests without fastening on a machined seat on the base casting so that it may slip if sudden forces due to extra rapid acceleration or retardation of the crane occur. A pinion projecting down from the revolving platform above meshes with teeth cut on the circumference (inside or outside) of this ring, and the rollers of the roller bearing turntable rest on its upper surface.

Socket, Wire Rope. A piece of metal with a tapering hole, to which the end of a wire rope is fastened by passing the latter into the hole, opening out the strands and perhaps doubling them back on themselves in the conical hole, and then filling it completely with a metal of low melting point. The socket may have an eye on the free end, and is then called a closed socket; it may have two straight sides drilled to receive a cross pin like a shackle and is called an open socket, or it may have other special connections.

Span. The distance reached across by a bridge, a girder, a beam, a rope, etc. The span of a crane bridge is the distance between centers of the rails at each end.

Speed, Hoisting. The distance travelled in feet per minute by a load while it is being hoisted. It is often expressed as slow, medium, and fast or rapid, but the divisions are indefinite. Roughly they are: slow speed for quarry, derrick and excavation work 50 ft. to 100 ft. per min.; medium speed for wharf, building materials, etc., 150 ft. to 300 ft. per min.; rapid for cargo and mine hoisting, 400 ft. to 800 ft. per min.

Spiral. A curve (generally a plane curve) which winds around a point and at the same time continually recedes from it, like a watch spring.

The term is often used where helical would be preferable, as spiral staircase, spiral conveyor. (See Helix.)

Spiral, Friction. See Chute, Spiral.

Spiral, Gravity Roller. A gravity conveyor in which packages move downward on a roller runway arranged in a helical form around a central vertical axis. On account of the small slope required for conveying on rollers, a number of turns of the spiral are necessary for conveying gently from floor to floor, and the length of runway thus provided gives large storage capacity. Single or multiple runways may be used, as in spiral chutes.

The runway is usually supported on horizontal braces carried between pairs of posts inside and outside of the runway, or by a central post and posts outside the runway.

The rollers are single straight cylinders, multiple short cylinders on the same axis, or on curves, conical rollers with the large end turned out. Concave rollers are used for special objects like kegs. The outer ends may or may not be raised or "banked," depending on whether it is considered objectionable to have the packages crowd against the outer guard rail. The bearings may be of the plain, ball or roller types.

On account of the large diameter and small slope, fireproofing of the openings through the floors is difficult unless the spiral is completely housed in. One method of avoiding this is to have short steep spiral chutes where the conveyor passes through the floors, which can be easily made fireproof, but these chutes may be inconvenient when carrying certain delicate or fragile materials.

Gravity roller spirals are most naturally loaded at the top, and discharged at the bottom, in connection with lines of gravity roller conveyor at both places, but intermediate loading and discharge may also be accomplished with the aid of hinged switches or diverters.

Page 387, 760-767.

Spiral Chute. See Chute, Spiral.

Spoil. The term applied to the material removed in making an excavation either on land by excavating machinery, or under water by dredging.

Spoil Bank. A long pile or heap of excavated material, usually placed parallel to the longest dimension of the ditch or other excavation being made.

Spool. A name sometimes applied to a drum, especially when the surface is concave and it is used as a winch head. On winches used for miscellaneous hoisting work, a split spool is sometimes furnished to be attached to the main winding drum when desired, to operate a counterweighted material hoisting elevator by an endless rope which makes several turns around the spool.

Spotter, Tilting. A means of feeding cars forward one at a time down an incline, consisting of a short section of track set on an incline, curved upward at the ends and pivoted at the middle so that it can rock slightly. As a car runs onto it past the middle, it tilts forward,

and the raised rail ends at the rear prevent the next car from following; as the car passes off the front, the platform tilts down to the rear allowing the next car to run on.

Spout. A pipe or trough used to discharge liquids or crushed or pulverized solids which will flow from a tank, bin or similar enclosure, generally under the control of a valve or gate. Spouts are placed at various angles from nearly horizontal to vertical, and are fixed, portable, rigid, flexible, swinging, telescoping, folding, etc., according to condition of use. They are usually made of steel, cast iron or wood, and occasionally of reinforced concrete.

(See also Chute.)

Spout, Bifurcated. A spout having a divided discharge with a shifting or switching device which can be made to cause equal discharges in two branches, or any desired inequality. Used in loading grain into cars from terminal elevators, as an aid in trimming the grain in the car.

Spout, Chain. A flexible spout in which the various sections are held by a continuous chain attached to each.

Spout, Dock. A long spout receiving the discharge of grain or similar bulk material from an elevated hopper or conveyor in a building on a wharf and delivering it into the hold of a vessel alongside. The upper end is provided with a turnhead which permits it to swivel about a vertical axis; it can also swing about a horizontal axis. The lower portion of the spout telescopes outside of the upper, permitting it to be withdrawn from the vessel's hold by block and tackle. The weight of the entire spout is carried by a tackle hanging from a swinging boom.

Spout, Distributing. A spout so arranged that it may discharge into any one of a number of receptacles provided for it. This may be accomplished by a flap or swinging gate within the spout itself, deflecting the contents into branch spouts, or by moving the lower or discharge end of a single spout to the point desired. The latter requires provision at the spout head for swiveling or swinging or both (see Turnhead) and also possibly telescoping of the spout itself. (See Spout, Telescope Trolley.)

A distributing spout sometimes used in grain handling consists of two inclined sections with a swivel joint between. The top section is connected to the hopper bottom by a turnhead, and is supported near the swivel joint by a hanger which travels on a circular overhead track. The discharge end of the lower section is mounted on casters and has an extension projecting into the hole in the floor to prevent spillage.

Spout, Flexible. A spout which is constructed of a number of cylindrical or slightly tapering pipe sections, fitted into each other, loosely attached by chains, and hanging from the top sections, so that the lower end may be moved about and the emerging material deposited where desired. This construction is used with the chuting of concrete and in grain, gravel and sand handling and loading operations. Also called flexible chute, and elephant's trunk chute or spout. Occasionally the sections telescope within one another for vertical adjustability, and for convenience in handling.

Spout, Flexible, Holder for. An adjustable rod used for holding in a definite position the discharge end of a flexible spout. Used in loading grain cars to save workmen from getting into the car.

Spout, Magnetic. A spout which contains an electromagnet so placed that it will attract and hold all pieces

of iron which may accidentally get into a stream of material passing over it, and prevent them from passing into a crusher or other machine which would be injured by their entry. The magnet is usually located in the bottom of the spout, and provision is sometimes made for the automatic opening of a door just beyond the magnet to discharge any accumulated iron onto the floor, and not into the crusher, in case the electric current fails or is accidentally turned off.

Spout, Measuring. A vertical or nearly vertical spout which is provided with gates at both top and bottom and is used as a means of measuring coal or other material delivered through it from a bin or hopper above. An interlocking device prevents the opening of the two valves at the same time, and a counter attached to the lower gate records the number of spoutfuls which have been discharged; this multiplied by the calibrated contents of the spout will give the volume delivered. Used for measuring the coal delivered to boiler stoker hoppers.

Spout, Portable. A spout which may be easily moved about. In grain elevators, such spouts are often mounted on a caster supported frame arranged for adjustable inclination, with a discharge end formed to fit into a hole in the floor and prevent spillage.

Spout, Telescope Trolley. A type of spout used to deliver material like grain from an overhead hopper into any one of several openings in a floor below. The spout is in two parts which telescope within one another; the lower end is carried on a trolley or frame supported on casters which supports it as it is moved over the floor from one opening to another and the upper end is provided with a turnhead to allow this swiveling and swinging motion. (See also Spout, Distributing.)

Spout, Telescoping. See Spout, Flexible; Spout, Telescope Trolley.

Spreader. A rigid bar or strut placed crosswise between two lengths of rope or chain, to make them assume a parallel position relative to each other, usually for the purpose of preventing certain stresses arising from the diagonal direction of pull. In turnover buckets, the spreader inserted in the chain bridle or bail allows easier dumping.

Also, a beam used to support the ends of slings placed around under large bundles of such material as sugar cane, pipes, etc., and sometimes termed a lifting beam.

Spring, Coil or Helical. A spring made by winding the spring rod or wire around a cylinder in a helix. If the spring is to be used in tension, the coils are generally "close;" if in compression, they should be open to just such an extent that when closed by the load, the maximum working stress will be equalled.

Spring, Shock. A spring device to cushion the jars that would otherwise be transmitted to a crane structure, where it is used for holding stock being worked under a hammer or at some similar machine. It is composed of one or more springs carried in a frame, and subject to compression, inserted between the hook and the load block, or, in the case of an independent hoist, between the crane and the upper hook of the hoist. (Also called shock absorber.)

Spring, Spiral. A spring made by winding the spring wire or strip in a spiral, or continuously about itself in one plane, like a clock spring.

Spring Check. The device used in some types of friction drums by which a limitation is placed on the amount of separation of the two parts of the friction clutch. When the external force engaging the clutch is removed,

the two parts might stick together except for the action of a spring pressing them apart. The spring check prevents this action from pushing them so far apart that they cause friction on collars, ends of bearings, etc.

Sprocket Wheel. See Wheel, Sprocket.

Spud. A device used for anchoring a dredge or other floating craft to the bottom or bank of a body of water. The usual form consists of a vertical timber sliding in guides attached outside the scow side, or in a well formed within the hull. Two are always placed near the front, and two at the sides at the stern or one in the middle of the stern. The spuds are raised by tackle, the ropes of which are led to winch heads on the hoisting engine, or to rack and pinion gearing operated by hand or by power. When lowered and forced into the mud bottom, they hold the scow sufficiently firmly to resist the thrust of a dipper.

Another type known as a bank spud is used on dredges in excavating narrow channels, such as drainage canals, etc. It extends out diagonally downward from a gallows frame, with a pad on its lower end resting on the bank. Another short arm from a point near the deck also connects to the spud near its lower end, thus bracing it securely. With this type of spud the scow can be built narrow for narrow ditches, and still be free from danger of capsizing during operation.

Spud, Telescopic. A bank spud used on dredges in which one part sliding within another may be extended at will to any desired length, thus adjusting for different heights of bank.

Stability. Having a tendency to return to its original position of equilibrium after being disturbed therefrom. A stable body or structure resists strongly a tendency to displace it from its position of equilibrium, or, if it is displaced, tends strongly to return to its former position. The question of stability is exceedingly important in all self-supporting cranes in which the load may be carried outside the outline of the base supports, as pillar, locomotive, horizontal rotating, cantilever jib, all tower cranes, etc. Wind pressure also tends to overturn such structures, and must be taken into account.

The various methods of gaining stability are: anchoring to a heavy masonry foundation—possible for fixed cranes only; using fixed or moving counterweights, placed opposite the load to be lifted, which is the most common method; using outriggers (which see); or temporary guys, which virtually increase the size of the base and convert the traveling crane temporarily into a fixed crane.

Staggered. Arranged in diagonal rows. Said of rivets, perforations, etc., when those in one row are one-half the pitch ahead of or behind those in the next adjacent row, instead of being abreast.

Steady-carriage. A device for maintaining the alignment of a grab bucket when twisting would foul the ropes or cause the bucket to strike the sides of a pit, car or other object. This is especially likely to happen when hoisting from deep pits, or when a bucket is being moved on a monorail track. A three-rope bucket serves the same purpose—two holding ropes spaced apart by an equalizer, and a single closing-and-hoisting rope.

Stiff-leg. One of the struts or props used to hold erect the mast of a stiff-leg derrick. It is attached to the top of the mast at one end, and to a ground anchorage, or the end of a lie-leg, at the other, by gooseneck iron and stiff-leg iron respectively.

Stiff-leg, Broken Back. A stiff-leg with an upward pointing crook or angle in it, arranged to completely clear a derrick boom and allow a full circle swing. An

additional short strut from the break or angle to the ground is generally used to stiffen the crooked stiff-leg, and occasionally two of these additional short struts are used for each stiff-leg, firmly holding it in position against side deflection.

Stiff-leg Iron. A metal fastening or strap for securing the lower end of a derrick stiff-leg to a sill or to an isolated anchorage.

Stop, Automatic Emergency. A mechanism arranged to stop automatically a moving part when it has travelled past the proper or safe point, or when it is travelling too fast. In particular, means of preventing excessive hoisting or lowering in cranes and hoists. (See Stop, Limit.)
Page 711, 757.

Stop, Limit. A device to prevent overhoisting in a crane or hoist. In electric cranes it is generally arranged to make the hoisting circuit inoperative at a certain point; one system relies on the closing of an auxiliary circuit, and another on its opening, for this purpose. The electrical arrangements can be so made that the lowering circuit will operate as usual when the controller is shifted to the lowering position; and over-hoisting is very simply remedied. On the other hand, working on the theory that habitual use of the limit stop and reliance on its action will cause it to wear and eventually fail to operate at a time the operator is inattentive, some designers arrange matters so that it is some considerable trouble for him to start the load down after he has thrown the limit stop, thus forcing him habitually to stop the hook before reaching the limit.

In skip hoists over-travel must be prevented at either top or bottom, and the skip brought quietly to rest; this is performed automatically in modern electrically operated installations. (See Skip Hoist, Automatic; Limit Switch, Travelling Cam.)

In mine hoists the work performed by the limit stop is usually combined with other functions in a mechanism called a safety stop or hoist controller. (See Controller, Hoist.)

Page 711, 757.

Stoker Magazine. The hopper immediately above an automatic stoker, to which coal is supplied, and from which the stoker mechanism regularly draws it for delivery into the furnace.

Storage, Ground. The term sometimes applied to storage systems where an entire supply of bulk material is carried at ground level. It is also used to designate a combination system in which a portion only of the material is held in elevated bins for immediate use or distribution, the larger part resting directly on the ground.
Page 643, 661.

Storage Bridge. See Crane, Bridge Storage.

Storage for Coal, Cable Drag Scraper System. A ground storage plant for coal in which the coal is stocked out and reclaimed by a drag scraper operating reversibly between a central distributing and receiving point and any one of a series of steel posts, called back posts, set at intervals surrounding the storage area. Coal is received by a track hopper, elevated and discharged by a spout to an initial pile from which the scraper can distribute it. For reclaiming, the scraper is reversed, dragging the coal back to the reclaiming hopper (in the same pit as the receiving hopper) from which it is elevated and discharged into a railway or other car, or onto a conveyor for carrying into a boiler house bunker. The drag cable is operated by a two drum winch.

Page 660, 817, 832.

Storage for Coal, Circular System. A system of outdoor ground storage for coal, in which two widely spaced parallel straight railroad tracks discharge their coal into a track hopper located between the tracks, and at the center of the pile. A locomotive crane travels around this hopper on a circular track digging the coal from it by means of a grab bucket, and depositing it anywhere within the circumference of a circle having a radius equal to twice the length of the crane boom. In reclaiming, the coal is dug from any point by the bucket, and loaded directly into cars.

The capacity of the pile is a maximum when the crane tracks are also covered, but as this prevents the crane from promptly getting at any desired portion of the pile in case of fire, it is not always utilized.

In the system as described, the crane can place itself so that it can reach to any remote part of the pile, and by merely swinging, dump the grab bucket into the cars or reclaiming hopper. Indefinite extensions can be made by extending the circular track by inserting straight or larger radius curved sections, but the crane will then have to handle some of the coal twice, or else travel along the track some distance with each bucket load before dumping it.

Page 746.

Storage for Coal; Dodge, or Conical Pile System. A system of ground storage of which the unit includes two conical piles each spanned by a two-legged truss peaked at the center for storing, and a horizontal swinging scraping conveyor between them for reclaiming from either pile and delivering to a conveyor.

One leg of the two spanning each pile contains a storing scraper conveyor which elevates the coal along the leg until it drops to the pile over the end of a steel ribbon which forms the bottom of the trough and which is gradually pulled up the truss as the pile grows, unwinding from a drum at the bottom. The angle of the leg is the angle of repose of coal, about 27 degrees.

The reclaiming conveyor is a horizontal bridge, pivoted at its delivering end, and swinging radially in either direction on a number of rails under the control of cables led from the pivot, out to the end of the bridge and thence at right angles to anchorages at either extreme of its swing. The chains of a reversible roller flight conveyor pass completely around the bridge in a horizontal plane, the flights being on end relative to the ground, and scrape the coal toward and past the pivot up an incline from the end of which it is dumped into railway cars.

Page 745.

Storage for Coal; Stuart or Conveyor System. A ground storage system for coal in which it is delivered to the end of a belt conveyor running longitudinally in a trench through the storage area. A high traveling tripper discharges the coal from the belt onto a short reversible inclined belt conveyor at right angles, which can be placed on either side, to elevate and discharge the coal to storage. This discharging outfit is called a stacker.

To recover, a reclaimer traveling on the same track is used. It consists of a short section of belt or apron conveyor terminating in a sort of plow, pivoted on a truck so that it can swing, and mounted so that it can be thrust forward under the coal in the pile, the coal being thus fed to the reclaimer conveyor. This carries it back to the main conveyor belt which conveys it to its destination.

Page 653.

Storage System for Coal. A method of accumulating and handling large quantities of coal, and involving (a) receiving or unloading apparatus for receiving the coal from dump cars or boat unloaders, (b) conveying apparatus (including cranes) by which it is taken to (c) crusher or screens or both, or direct to (d) storage piles on the ground or elevated bins. There is also a means of (e) reclaiming the coal from the storage pile and delivering it to (f) the conveying system which delivers it to storage bins above furnaces where it is to be burned or to cars into which it is reloaded. Most plants also have a means of passing direct from (c) to (f), omitting the storage.

The same systems may be used for anthracite or bituminous coal, but owing to the freedom from spontaneous combustion of the former, it may be piled to much greater heights, allowing radically different plants to be used for anthracite.

Systems are sometimes distinguished according to the shape of the storage piles as, (a) circular conical piles with the point of supply at the apex of the cone, or moving up one leg of a two-legged truss spanning the pile; (b) piles rectangular in plan and included under the area covered by the bridge of a large traveling gantry or overhead traveling crane called a storage bridge; (c) annular piles outside of a circular track on which a locomotive crane may move, usually combined with a circular or two circular segmental piles within the circular track; (d) long heaps, between tracks spaced so that locomotive cranes can reach the complete area from one side to the other; (e) combinations of circular and longitudinal heaps.

As to methods of delivery to and reclaiming from storage, there may be one or a combination of the following devices: (a) scraper conveyor, usually of the flight type, (b) belt conveyor, with traveling tripper and short cross belt conveyor combined as a stacker, (c) drag bucket, (d) overhead bridge and grab bucket, (e) dump car on automatic railway, or cable railway, (f) locomotive crane and grab bucket, (g) portable conveyors.

Page 643, 661.

Strain. Deformation of a body due to the application of a load and the resulting stress. A stress produces a strain. Expressed in inches per inch of length.

Strength, Tensile. The force, usually measured in pounds per square inch of cross section, which must be applied to cause the failure of a piece of material subjected to a pull. Also known as ultimate tensile strength.

Stress. A force acting within the substance of a body, or internal resistance, tending to prevent deformation due to the application of a load. Measured in pounds or tons per square inch of section. (See also Strain.)

Stripping. A method of mining materials near the surface of the ground by first removing the overlying soil or strata by mechanical means, and then removing the valuable mineral in the open cut. The term is applied to the removal of the overburden, and also to the whole operation, as "mining by stripping."

Very large amounts of material must be handled at a very low cost to make this method profitable. One successful system involves the use of large steam shovels; by proper laying out of the work it is possible to obtain the mineral with but one handling of all but a small portion of the overburden.

Strut. A brace or support for the reception of direct thrust or pressure; a piece designed to resist pressure in the direction of its length.

Also called (under certain conditions) prop, column, brace.

Stud or Stud Bolt. See Bolt.

Stuffing Box. A form of construction used at places where round moving rods or shafts emerge from an enclosed space, to prevent a difference of pressure on the two sides from causing a flow of fluid, or leakage, through the opening. It usually consists of a cylindrical chamber surrounding the shaft, into which a fibrous material or soft metal construction may be placed, pressed down by another tubular portion called a gland, and held firmly in place by a screwed or bolted part called a follower; the gland and the follower are often made in one piece.

Stuffing boxes for reciprocating rods are different in proportion and construction from those for rotating shafts, and the nature of the fluid under pressure, as water, steam, air, oil, etc., also influences the design.

Swing. To move to and fro, as a body suspended from an axis; to oscillate in a plane about a fixed point or line.

Swing Circle. The term applied to the combination of the pivot bearing and the slewing or bull wheel for the inner end or heel of the boom in a dipper dredge or power shovel of the dipper type. A common arrangement consists of a pivot casting bolted to the deck, with a socket casting rigidly attached to the heel of the boom at the proper angle. Above the socket, and forming part of the same structure, are arms radiating to a rim in a horizontal plane; around this rim are placed ropes which lead to winch heads, swinging engines, or other apparatus for winding by power, and thus swinging the boom as desired. The corresponding mechanism in a derrick is called a bull wheel.

Swing Crane. See Crane, Swing.

Swing-lift Transfer. See Car Dump, Swing-Lift Transfer.

Switch, Crossover. A switch inserted at the intersection of two lines of overhead monorail track, by which either line of track can be made continuous at will, for trolleys to cross over. In one, known as a rotary crossover, a short section of runway at the junction is supported from a small turntable immediately above it and may be rotated by pendant chains, bringing it into alignment with either track as may be desired.

Switch, Limit. A term applied to a switch used for overhead monorail track, in which a horizontally sliding frame carries two (or three) short sections of the runway track fastened to its lower surface, and determines by its lateral position which of two (or three) paths shall be followed by a trolley. It is termed single or double according to whether a trolley approaching on the single track can follow one of two or one of three possible paths. The switch is operated by pendant chains, and is locked in place when in alignment. This type of switch, like the turntable and turntable switch, is used when there is not space enough for the ordinary tongue switch.

Switch, Roller Conveyor. An arrangement in a gravity roller conveyor by which material may be brought from several points and delivered to one conveyor line, or delivered by one conveyor line to several destinations. It generally consists of a section of runway that can be swung or slid so as to occupy either of two positions, connecting either of two runways to a third. If a choice is offered of three or more positions with a corresponding number of lines, it is called a three-way, or four-way switch, or simply a multiple switch.

Switch, Two-way Hopper. See Hopper, Two-way Switch.

Swivel. A fastening between two pieces which is so made as to allow one of them to rotate relative to the other about the longitudinal axis common to both of them. Swivels are inserted in chains, and hooks and blocks are arranged to swivel in their fastenings.

To swivel, to rotate. Said of hooks and metal fittings of hoisting machinery in general, but not of large objects, like cranes, turntables, etc.

Tackle. A combination of ropes and blocks used for multiplying power. (See Block and Tackle.)

Table, Gathering. A conveyor used in book binderies for holding a complete set of sheets consecutively arranged for assembly into a book. The operators remain at rest and gather the sheets in order as they pass. It usually consists of a series of platforms traveling on guides in a horizontal plane in a circular, rectangular or other continuous path and connected by an endless chain at their centers in such a manner that they may pass from a straight to a circular path, and even turn a corner of moderate radius.

Tag Line. A line leading from a near corner of a grab bucket to the cab of a locomotive crane operating it, and held under tension by a counterbalance weight, to keep the bucket from rotating and fouling its supporting and operating lines.

Also, a line attached to any load being lifted by a crane, to keep it from rotating, or to slew the crane by hand, in case no power slewing gear is provided.

Take-up. A mechanism for taking up the slack or for keeping a constant tension in a rope, chain, belt or similar member. Take-ups for stays, guy lines, etc., usually consist of a threaded rod arranged so that by turning a nut with a wrench, the points of rope attachment at the ends of the mechanism may be brought closer together.

For endless belt and bucket or chain and bucket conveyors or elevators, the take-up usually consists of a pulley or sprocket shaft mounted in bearings sliding in straight guides and controlled in position by a threaded rod, or by the pull of a heavy weight. Occasionally the moving shaft is swung about a pivot instead of sliding in straight guides.

In cable car haulage systems and overhead cableways similar take-ups are necessary whenever the endless rope system is used. The weighted tension take-up is most usual, consisting of an idler sheave supported on a small four wheel car which is always forced in one direction on a track by the pull of a heavy weight. Sometimes a weighted sheave hangs free in a vertical loop of the rope. Also called a tension take-up or tension carriage.

Tank, Settling. A device used for separating sand into various degrees of fineness by utilizing the variations in time required for the different grades to settle out of a stream of water. A single tank or box may be used to reject all particles below a certain size, or a series of tanks may effect the separation into a series of graded sizes. The boxes or tanks are automatically self-emptying, or are emptied by hand shoveling, by small grab buckets, or similar implements.

Telltale. A device which gives audible or visible indication of the beginning, progress or completion of an operation on some piece of machinery; an automatically operated signal.

Telpher. A crane consisting of an electrically operated hoist suspended from one or more trolleys running on an overhead monorail track, and having a seat or cage

for the accompanying operator. Though it is not made in such large capacities as overhead traveling cranes of the bridge type, since its function is more particularly conveying than hoisting, its field of action on one level can be made practically unlimited, by providing suitable overhead monorail runway. Elevators can also be arranged to move the telpher with its load from floor to floor if this is thought to be desirable.

Telphers are also called trolleys, monorail hoists, tramway or tramrail hoists, and transporters.

Page 213, 773-804.

Thermostat. An instrument which is operated by change of temperature, and which is often used to control the source of heat (or cold) so as to maintain as nearly as possible a constant temperature. As an example, a thermostat on the water cooling system of a motor truck serves to maintain a more nearly constant temperature than would otherwise occur.

Thimble. A metal eye, round at one end and pointed at the other, made of a piece of steel of concave cross-section bent to the form described. A manila or wire rope is wrapped around the thimble, lying in the groove, and the free end is spliced, clipped or clamped to the standing part, making an eye for permanent fastening purposes.

Throw. The distance from the center of a shaft to the center of a crank pin or of an eccentric; half the total travel of a piece moved back and forth by a crank or eccentric. Also called eccentricity and crank radius.

Thrust Screw. A screw by which a thrust bearing is adjusted. Also, a screw by the rotation of which a thrust is exerted when desired, as in operating the clutches of friction drums on winches.

Tie or Tie Rod. A structural member designed to resist tension in the direction of its length. Top braced jib cranes are braced by tie rods. The boom of a pillar crane is also connected to the top of the pillar by a tie rod.

Tiering Machine. A machine by which heavy packages are raised vertically to an elevation on a moving platform and then rolled or slid off on to the top of a pile or on to an elevated rack. Also called Portable Elevator.

Page 726, 745, 770.

Tightener. For derrick guys and similar locations. A turnbuckle or other device for shortening a rope or chain by taking up slack, without altering the end fastenings.

Also, a moveable idler pulley or sheave arranged to adjust the tension in a wrapping connector like rope, chain or belt passing around sheaves or pulleys.

Tipple. A structure designed to transfer material from one system of transportation to another, largely by force of gravity available on account of differences in elevation of various parts of the structure.

Also, a car dumping device. (See Car Dumper.)

In a narrower sense, the term means a building erected close to the mouth of a mine, into which mined material (as coal) is delivered by cars, conveyors, chutes, etc., where it is screened, separated from refuse or otherwise prepared for use, and from which it is delivered, generally by gravity, to railway cars or other conveyances for transportation to more or less distant points. It may vary from a simple trestle with a car dump and tracks below on which receiving cars may stand, to an elaborate structure with many levels and conveying and elevating devices, screens, picking tables, etc., and a complicated

system of tracks or a yard in which the receiving cars are handled.

Page 635.

Tongs. A mechanism for gripping objects for the purpose of holding, hauling or hoisting, consisting of two S-shaped curved parts having points or pads at one end for pressing into or against an object, and eyes or other attachments at the other for applying the pull by a rope or chain. The two parts are pivoted together at a point between the ends, the location of the point varying with the leverage desired, which in turn depends on the use to which the tongs are to be put. Sharp points are used when damage done by them does not matter; flat pads are required when no indentation is allowable. The points are also specially formed for lifting certain objects, such as structural steel, rails, etc.

Topping Lift. A line or tackle used for raising and lowering a derrick boom. It is attached to the boom point, passes around a sheave at the mast top, and thence down the mast and around guide sheaves, to the proper drum of the hoisting winch, or directly from the mast top to the drum if a rooster is used.

Also called Boom Fall.

Topping Lift, Variable. The term applied to a derrick in which the inclination of the boom can be altered, particularly in the case of A-frame derricks used in excavating and dredging work, where booms of fixed inclination are the rule. (See Excavator, Grab Bucket.)

Torque. Turning moment, or tendency to turn, of motors, engines, shafting, etc. It is expressed in pound feet, and is the force which would be exerted at a point one foot from the axis of rotation if an arm were to be fastened to the shaft.

Tote Box. A temporary container used in manufacturing establishments for holding finished or unfinished parts while in storage or transit from place to place. Usually made of metal, often flaring so that they will stow within one another when empty, and provided with handles for lifting by one or two men, or by a crane.

Page 540.

Tower, Coal. A term often applied to any one of the numerous types of coal unloading installations involving a tower-like structure into which coal is hoisted by a grab bucket or a bucket elevator, and from which it moves to its destination by chutes, spouts, conveyors or cars or combinations of these. Often the tower is on wheels and can be moved along the wharf where it is located to suit the hatchways of the vessel being unloaded. (See Unloader, Coal.)

Page 828-831.

Tower, Concrete. A high tower used as part of a system of concrete distribution by means of chutes during construction operations. It is built of steel or wood, not ordinarily over 250 ft. high, and is guyed by wire ropes. The concrete bucket hoist or elevator passes up through it, the receiving hopper is attached to one face, and also the boom for supporting the first section of chuting, or the line cable, depending on the system used.

The receiving hopper must be raised at intervals as the height of the structure grows, and to do this quickly, a construction known as a quick shift is sometimes used. The receiving hopper and boom are mounted on a frame sliding on the face of the tower, and can be unclamped and raised to a new level by proper hoisting devices. In another system several receiving hoppers are installed, and the cans or stops which cause the

ascending bucket to dump can be set to cause dumping at any point desired.

Tower, Horizontal Boom. An elevated structure having a horizontal jib (commonly called a boom) projecting outward over water, and equipped with machinery for unloading coal and other bulk material from floating vessels. A tower of steel or wood rises a considerable distance above the water and is provided with a receiving hopper projecting from the side toward the water. Above this is the horizontal jib equipped with a two-sheave trolley. The ropes from a two-rope grab bucket are led over these sheaves and then diagonally to the top of the tower, where they pass around guide sheaves and down to the drums of a winch. Another single drum hauling winch, sometimes called a "trolley engine," moves the trolley outward on the jib by a rope passing around a sheave at end of the jib and back to the trolley; the latter is held in position by a brake on this winch drum, and when the brake is released will move inward under the influence of the inclined pull on the bucket ropes leading to the peak of the tower.

The tower can be arranged to propel itself on a track along the wharf to accommodate the hatch location of the vessel. Several such towers often operate simultaneously on the same vessel. A separate engine or a geared connection from the hoisting engines serves to move the tower.

Also called two-man or Boston tower.

Page 828-831.

Tower, Inclined Boom. An elevated structure with machinery equipment located on a wharf and used for unloading coal and other bulk material from vessels. A jib (commonly called a boom) projecting from the upper part of the tower and sloping downward over the water is equipped with a two-sheave trolley. The two grab-bucket operating ropes are attached to the trolley, pass down into the bucket which they support in bights (see Bucket, Four-Rope), pass upward around the trolley sheaves and then to the winding drums on the winch (sometimes called the coal hoist). After the bucket is filled in the hold of the vessel, it is hoisted until it comes into contact with a stop on the trolley; further winding pulls the trolley and bucket up the inclined jib together until the latter is over the hopper in the tower side, when the bucket is dumped in the usual manner. In lowering, release of the friction drums on the winch allows the trolley to run down the jib to the desired point, this last being controlled by a rope attached to the trolley and wound on a special drum, or by a movable stop on the trolley runway. When the trolley stops, the bucket continues to descend vertically to the filling point.

Two separate hoisting drums are commonly used for handling the bucket, and they are often arranged in line, or as a twin-drum winch. They are steam or electrically driven. An additional engine or motor or geared connection from the main hoist is used to move the tower along a track parallel to the wharf. (See Tower Propelling Engine.) The jib is occasionally curved or convex upward instead of straight, so that the bucket moves nearly horizontally during the last part of its travel.

Page 831.

Track, Industrial. A general term covering rails and accessories for either portable or permanent railways.

Page 629, 721-725.

Track Cable. In cableways, the cable on which the trolley or traveler runs. (See Wire Tramway Strand; Wire Track Cable.)

Tractive Effort, Tractive Force. The force with which the wheels of a self-propelled vehicle tend to move it forward due to the turning effort or torque exerted on the wheels by the engine or motor. The maximum tractive effort which may be exerted corresponds to the maximum torque which may be exerted by the engine or motor, unless this is sufficient to overcome the adhesion of the wheels and allow slipping, in which case the maximum tractive effort corresponds to the torque which would just start slipping.

Tractor. A term applied to a self-propelled trackless wheeled vehicle which is powered and designed with a view to drawing one or more other vehicles bearing useful loads. When the tractor also carries a load itself, it is termed a tractor-truck. Tractors are supported on three or four wheels, or on a track-laying truck with or without a pair of wheels in addition. Tractive effort may be exerted by two wheels, by four wheels, or by the track-laying element. The power plant may be driven by a gasoline, oil or steam engine, or by a storage battery and electric motor.

Page 530, 531, 544, 702-705, 728-745.

Tractor, Gasoline Engine. A power driven self-propelled industrial truck propelled by a gasoline engine (see Truck, Industrial, Gasoline Engine) but without facilities for carrying a load on its own wheels, being used merely for pulling one or more load carrying trailers coupled to it.

Page 531, 704.

Tractor, Storage Battery. A power driven industrial truck operated by a storage battery and electric motor, but without facilities for carrying a load on its own wheels, being used merely for pulling one or more load carrying trucks coupled to it.

Trailer. See Truck, Trailer.

Train. To bring into proper alinement. Ball and socket bearings are sometimes termed self-training; packages loaded onto a conveyor are sometimes trained or brought into a position parallel with the conveyor run by light contact spring.

Transfer, Cane. A fixed gantry crane especially rigged for transferring large bundles of sugar cane from one vehicle to another, generally from a wagon, ox cart or small car to a large car, or from a car to a feeder for crushing rolls.

Transfer Car. A self-propelled car used for regularly transferring bulk material from one point to another in an industrial plant, as for example from an unloading machine to bins, pockets or ground storage. Transfer cars are made with hopper bottoms, gable bottoms dumping on both sides, or sloping bottoms dumping on one side. They are usually electrically operated and run singly, though trains of transfer cars are sometimes used. A power operated transfer car may also draw a trailer. (See also Transfer Table.)

Page 620, 721, 722, 831.

Transfer Car, Bucket. A car used for carrying self-emptying buckets and tubs to and from cranes and hoisting machines. Pockets are arranged into which the tubs fit so as to obviate danger of moving during transit. They may be placed on the car already loaded, or may be filled while they are on the car. The car may be self-propelled, may be a trailer, or may be operated by a wire rope from a stationary winding drum.

Page 310.

Transfer Table. A large platform or table mounted on wheels running on a number of parallel rails, often in a pit or depression, and having tracks on its upper surfaces

running in a different direction, generally at right angles. The level of the top of the table is such that cars can be run onto it from a fixed track, and the motion of the table will then transfer the cars to such a position that they can be run off onto tracks parallel to the first. They replace a large amount of trackage, switches, etc., that would otherwise be necessary. Transfer tables are usually self-propelled by power, electric or steam, or are drawn by cables. Small sizes are operated by hand.

Where the cars transferred are small, two or three transverse tracks are often laid on the table, allowing as many cars to be carried at once.

The name transfer car is also often applied to the same mechanism, but more generally where the distances the cars are conveyed are greater, and where the transferring track has two rails only.

Also called a traverser.

Transporter. A term sometimes applied to a monorail hoist, to a telfer, to a traveling cantilever gantry crane equipped with a trolley to which a cage is attached, and to a type of rope operated crane trolley handled from winding drums located at a fixed point and used, like the preceding, for hoisting and conveying purposes.

Travel. To move a given distance along a definite path. The bridge of a crane is said to travel, and the trolley is said to traverse the bridge.

To move in a longitudinal direction.

Traveller. A wheeled car or carriage capable of movement to and fro along a rope, elevated beam or bridge; a trolley.

Traverse. To move across, to move in a definite path in a transverse direction. The bridge of a crane is said to travel on its runway and the trolley to traverse the bridge. Also to rack.

Trim. To distribute or level a bulk material as it is being discharged into a space, as a car, or the hold or bunker of a ship. Also, to move bulk material by hand or power appliances to a location where it can be reached by grab buckets or other unloading devices, as to trim the coal between the hatches in unloading a vessel. Also, to distribute a load in a vessel so that the latter has no side tip, and little or no longitudinal inclination.

Triplex Block, Triplex Hoist. See Hoist, Epicyclic Geared Chain.

Trolley. In hoisting machinery, a wheeled carriage or truck which can move along an overhead runway provided for it, and which is used as part of a crane in connection with a hoist, either built into it (see Hoist, Trolley; Hoist, Built-in) or hung onto it (see Hoist, Independent). It may be moved along the runway by direct pushing, by gravity, by hand or power operated gearing working through the wheels, or by power or hand pull on ropes or chains directly attached to it. Some of the various forms of trolleys are as follows: monorail, or two rail; single or double I-beam; plain or geared; top running or bottom running; deck bridge or through bridge; single or tandem.

The principal parts of a trolley for a two-girder bridge are: side frames, machinery and load girts, wheels, axles, bearings, motors, shafts, gears, brakes, drum, hoisting rope, equalizer sheave, top block, bottom block, and load hook.

Also called carriage carrier (especially for monorail types), crab (British).

Page 287, 773-785.

Trolley, Adjustable. A monorail crane trolley arranged for running on the lower flanges of an I-beam and which can be adjusted to suit several different widths of flanges. This is usually accomplished by making the frame in halves, and varying the thickness of the distance piece between them.

Also, the term applied to a monorail crane trolley in which the two halves of the frame are hinged together in such a way that they may be easily swung out to clear the runway flanges, so that the trolley may be removed from the I-beam without running it off the open end.

Trolley, Bottom-running. A monorail crane trolley which is supported on wheels running on the bottom flanges of I-beam track or runway. (See also Trolley, Monorail.)

Also, in a two-girder bridge crane, a trolley running on the inside lower flanges of the girders. Also called a through-bridge, submerged, or internal trolley.

Trolley, Deck-bridge. A crane trolley for a two-girder bridge, which runs on rails laid on the top of the girders; a top-running trolley, as distinguished from a through-bridge or bottom-running trolley. It is the most used type of bridge trolley, the other form only being substituted to meet special requirements.

Trolley, Flat-rail. A top-running monorail crane trolley which runs on a flat top rail of rectangular section. (Also called a bar trolley.)

Trolley, Geared. A crane trolley which is racked, or has its track wheels rotated by a train of gearing driven either by hand or by power. (See Trolley, Plain.) The simplest type of hand gearing consists of a pendant chain on a chain sheave, which, by means of a pinion on its shaft, drives a gear keyed to a wheel axle; a second gear reduction is used where the load is great. In electrically operated cranes, a motor replaces the hand chain and sheave.

(For trolley hoist gearing, see Hoist, Trolley.)

Page 774-782.

Trolley, Grab-bucket. See Trolley, Bucket.

Trolley, Hammerhead. A rotating horizontal cantilever crane structure mounted on a truck or trolley for traveling an elevated runway. (See Crane, Horizontal Rotating Cantilever.)

Trolley, Hose. A small trolley made to run on a wire rope or an I-beam to hold up a loop of hose. Travelling air apparatus, like an air hoist mounted on a crane trolley, is supplied with air through a hose, and in order to keep this hose off the floor, and yet allow the hoist to move back and forth as desired, the hose is suspended in a series of loops each attached to a hose trolley. The trolleys run on a tight wire, or on a flange of the crane girder and are made swiveling or non-swiveling.

Trolley, Monorail. A trolley or truck running on a single rail, and used for supporting a hoisting unit. The track wheels may run on top of a rectangular or I-beam section rail, on the lower flanges of an I-beam, or on special shaped rail of various cross sections. At least two wheels are used for a top-running, and four for a bottom-running trolley. If sharp curves must be traversed, two four-wheel trolleys or monorail trucks are connected by a swivel to a bar on which the hoisting unit is hung. Where very heavy loads must be carried, as many as sixteen wheels, arranged as four four-wheel trolleys, may be used. These are arranged in pairs, each pair supporting its own equalizing bar, which in turn sup-

ports a main bar. The individual trucks may be hinged to the bars, and the large bar hinged to the smaller ones, giving the utmost flexibility.

The hoisting unit is usually independent, and is either hung onto an eye, or attached by bolts to the trolley.

The parts of a plain monorail trolley are side frames, wheels, axles, distance piece, separator or yoke, hook or eye, and often a chain sheave and hand chain. A geared trolley has, in addition, one or more gear shafts and gears.

In some cases there are small vertical rollers mounted in pockets in the side frames, and bearing against the edges of the lower flange of the I-beam, to center the trolley and keep it from swinging.

Also called carrier.

While the majority of monorail trolleys are hand traversed, especially for light loads, a power driven trolley is used when the distances travelled are great, and for heavy loads. This is usually accomplished by a small motor geared to the trolley wheels, and entirely independent of the hoisting motor. Such a trolley may be floor controlled, but is also often fitted with a trailer cab carrying the operator.

Also called a telpher, and a man-trolley, and, when equipped with a grab bucket, a grab bucket man trolley.

Page 213, 774-800.

Trolley, Plain. A crane trolley which is moved along its runway by means of a pendant hand chain rotating a chain sheave which is directly connected to the axle of one of the wheels, without the interposition of any gearing. Used for small capacities only, and usually with an independent hoist.

Also, a trolley which is without pendant chain for travelling it, and is moved solely by push or pull of the hand; a push trolley.

Page 774-782.

Trolley, Swiveling. A crane trolley which is mounted with its hoisting gear and motor on a turntable in such a way that it can be rotated, moving the load with it. Such trolleys are installed in forge cranes, and in bridge storage cranes carrying two-rope grab buckets used to unload bulk material like ore and coal from the hold of a vessel. Also called turntable trolley.

Trolley, Tandem. Two four-wheel monorail crane trolleys placed near each other and connected by swivels to an equalizing bar which carries the load. This is similar in action to an eight-wheel swiveling truck car on a two-rail truck, and has the twofold advantage of distributing the load over a considerable length of track, and passing around curves easily.

Trolley, Through-bridge. A trolley which runs between the girders of a bridge crane, carried on rails mounted on the inside lower flanges of the girders. This allows diagonal bracing between the tops of the two girders, but loads them eccentrically. (Compare Deck-bridge Trolley.) (Also called internal trolley.)

Trolley, Top-running. A monorail crane trolley which is supported by wheels running on the top of a bar or I-beam rail. (See also Trolley, Monorail.)

Also, in a two-girder bridge crane, a trolley which runs on rails laid on the top of the girders. (Also called a deck-bridge trolley; on-top trolley.)

Trolley, Wire Cable. A trolley having wheels grooved to run on a track cable. If more than two wheels are used in the same trolley, some form of equalizing device must be used to allow the wheels to conform to the curvature of sag of the wire rope.

Trolley Bucket. A trolley for an overhead travelling crane especially arranged for handling a two-rope grab bucket. Usually separate drums driven by independent motors are provided, arranged so that they may be operated in unison. Another arrangement is to have separate drums which can be connected to each other or to the motor by friction clutches. The direction in which it is desired to have the bucket open—parallel to the bridge, or at right angles—may also dictate the particular arrangement of the drums.

(For method of operating a two-rope bucket, see Bucket, Two-rope.)

Page 786-800.

Truck. A wheeled vehicle capable of running on reasonably smooth surfaces without tracks, and able to carry freight. Trucks may be classed according to the service performed as industrial, or motor, the latter terms being commonly applied to power trucks running on highways; according to the method of moving them as hand, trailer or power. A power truck may be driven by a gasoline or other internal combustion engine; by an electric motor supplied with current from a storage battery carried by the truck, a flexible cable and plug-in connections located along the route or from an overhead feed wire and trolley with flexible connections to the truck; or by a steam engine and boiler. Trucks may also be classed as fixed platform trucks, made in many forms, or as lift platform trucks, able to pick up and deposit their own loads or able to elevate packages to be stacked or tiered on high racks or piles. According to the number of wheels they may be termed two wheel, three wheel, four wheel and six wheel; according to the method of steering as tongue, wheel (like an automobile), or horizontal or vertical lever.

Page 519, 726-748.

Truck, Baggage. A hand operated truck developed to meet the needs of baggage and express companies in handling material to and from railway cars. It consists of a platform supported on four wheels, with an additional swiveling one often added in front to allow easy turning. The sides may be closed by stakes or racks, and the ends are enclosed vertically or may slope outward.

Page 520.

Truck, Balanced. A hand or trailer truck which is supported on two fairly large wheels rotating on fixed axes underneath each side near the center, and by one or two caster wheels at each end, making four or six wheels in all. The center wheels are larger or are set lower than the end wheels and carry most of the load balanced on them. The truck may be pushed by hand or towed as a trailer.

Also called a six-wheel truck, or a tilting truck.

Page 537.

Truck, Box. A low truck for moving large and heavy boxes, machines, bales, etc., as a single unit. It consists of a rectangular frame of wood or metal supported on four or six wheels, and having ends so shaped as to allow the heavy pieces to be loaded easily on the truck. If six wheels are used, the center ones are often somewhat larger or placed lower, so that the whole truck will swing easily; all the wheels are often arranged to swivel like casters.

Page 519, 537.

Truck, Caster. A hand or trailer truck which is supported by three or four swivelling wheels of the caster type. Two or more of the casters may be connected by an iron bar so as to force them to swing simultaneously.

If moved by hand, it is generally pushed; if by power, it is towed from the front end, as a trailer.

Page 535.

Truck, Drop Frame. A truck having the platform lowered between the wheels to a level where it will just clear the ground. It is stepped up at each end over the wheels, and if, as is usual, driven by storage battery and its steering knuckles interconnected by steering rods in motor, the battery is placed beneath this elevated portion at one end, and the motor at the other. A hinged driver's platform and controller is provided at each end.

Page 537.

Truck, Electric Motor or Electric. A motor truck in which a storage battery and electric motor provide the motive power. The batteries are usually mounted beneath the frame of the chassis in one or more trays which can be easily removed for repairs, charging or replacement with a charged set. The motor is series wound, of the multipolar type with forged or laminated poles, is hung from a spring mounted frame and either drives the rear axle differential directly, or drives a jack shaft in front of it, from which one or two chains are used to drive the rear axle.

(See also Truck, Industrial Storage Battery).

Page 549.

Truck, Elevating Platform. A self-loading truck which has a lower forward extension that can be run under skid platforms prepared for it, and lift them from the ground, with or without load. Truck and load may then be moved to the desired destination, and there lowered, the truck withdrawing from under the skid platform and going on to other work. They may be hand or power operated. Hand lift trucks are usually operated entirely by the action of the handle; power lift trucks usually have separate motors for the lifting and the propelling movements. Instead of a complete platform, two bars only are often provided to lift the load.

Also called Lift Truck.

Page 521, 526, 728-748.

Truck, Fifth Wheel. A hand trailer truck having its front axle swivelling on a vertical king pin at its center, mating circular tracks fixed to the top of the axle and the bottom of the body serving to carry the load and still allow turning of the axle for the purpose of steering. If pulled and steered by a tongue fixed in the axle, it is called a tongue truck.

Page 535, 729-748.

Truck, Four-Wheel Drive. A truck which has power supplied to all four of its wheels, making them all productive of tractive effort. Wheels which drive and steer at the same time must have special universal joints or equivalent arrangements in the shafts to permit the two motions to take place.

Page 531.

Truck, Four-Wheel Steer. A trailer truck which has its steering knuckles interconnected by steering rods in such a way that the pairs at opposite ends move symmetrically in response to a side movement of the coupling at the front end produced by the tractor passing around a curve. The trailer will track perfectly, and can be hauled from either end, though it cannot be manoeuvred easily by hand.

Truck, Gasoline Motor. A motor truck in which a gasoline engine provides the motive power. The usual type of gasoline motor truck has a power plant consisting of a four cylinder vertical four stroke cycle engine with electric ignition provided by a magneto or a battery, or both. A few engines are air cooled, but the

great majority are water cooled, the water being circulated through jackets around the cylinders of the engine, and cooled by being passed through a radiator mounted at the extreme front of the truck; the circulation may be produced by a centrifugal pump or may be natural due to the expansion of the liquid on being heated. Gasoline is stored in a tank and is fed by various means to a carburetor placed on the engine, which vaporises and mixes it with a proper amount of air. The engine exhaust is led beneath the car or to the rear through an exhaust pipe in which is a muffler.

Truck, Hand. A freight carrying truck which is propelled and steered by the operator walking along with it and pushing it from behind or pulling from ahead.
Page 519, 748.

Truck, Industrial. A general term applied to trackless wheeled vehicles of various descriptions used for conveying material within the buildings of an industrial establishment, from one building to another, or, for limited distances, around the grounds of such a plant. For short distances and small capacities they are usually hand operated; for longer distances and larger capacities they are operated by electrical or gasoline motors.

(See Truck, Motor.)

Page 519, 726-748.

Truck, Lift. See Truck, Elevating Platform.

Truck, Lift, Hand. A lift truck in which the load is raised and the truck and load are pulled by hand power (except when used as a trailer).
Page 521, 747-748.

Truck, Motor. A general term applied to self-propelled trackless wheeled vehicles of various description used for conveying material considerable distances over streets. They are operated by gasoline, electric and steam motors, the relative importance being in the order given. A motor truck consists primarily of a chassis and a body. With the chassis are included the power plant, transmission, drive, wheels, axles, springs, frame, and the brake, steering and power controls. Bodies are made in many types.

Page 549, 702.

Truck, Platform. A truck, consisting of a horizontal platform usually supported on four wheels. It may be operated by hand, may have its own motive power, may be pulled by another truck having motive power, thereby acting as a trailer, or may be pulled by a cable. The platform may be single, or have several decks; one or more sides may be closed by stakes or solid walls, or special racks to suit material may be provided.
Page 521, 525, 527.

Truck, Radial. A two-wheel truck which is free to turn about a pivot on the center line of the car under which it is placed, radius bars being used to connect it with this center.

Truck, Rigid. A truck which has its wheel axle bearings rigidly fixed so that they cannot rotate about a vertical axis. Such a truck offers considerable resistance to movement along curved track.

Truck, Stevedore. A hand operated truck consisting of a platform supported on two wheels placed one on each side near the front, and steered and controlled by a man grasping two handles placed one at each side at the rear. A ledge at the front end keeps the load from slipping off, and aids in lifting the load by being slipped under the edge of the latter when it is tipped slightly away from the truck. Many variations of this truck are

made to suit the shape of the packages to be handled or special conditions of operation.

Page 521, 748.

Truck, Swiveling. A wheel truck which is pivoted under a car in such a way that it may rotate about a vertical axis, or swivel, as the car moves along a curved track. Locomotive cranes are usually mounted on two such trucks.

Truck, Tiering. A power lift truck which has the high uprights and long lift for the platform possessed by a tiering machine. It is usually motor driven by a storage battery; the propelling and lifting may be performed by the same motor, but separate ones are usually furnished.
Page 526, 726, 745.

Truck, Trailer. A wheeled truck, without power, which is furnished with couplings and steering arrangements that enable it to be coupled to and hauled behind a tractor or another trailer. Trailers which can be drawn from either end are termed reversible. Trailers may be classed according to the method of steering them as four wheel steer, caster, balanced, and fifth wheel steer. (See Truck, Four Wheel Steer, etc.)

Plan platforms or bodies of any desired type may be mounted on trailer trucks, or special racks or supports for carrying large or awkward shaped objects.

Page 535, 577, 729-748.

Truck-tractor. A truck which is able to draw a trailer with a load in addition to carrying a load on its own platform.

Page 574.

Trunnions. A pair of cylindrical projections on opposite sides of an object, and supported in bearings in such a way that the object can rotate about the axis of the trunnions, as ladle trunnions.

Load hooks are sometimes suspended on trunnions, supported in bearings in the frame of the load block, to prevent the load block being tilted, due to improper arrangement of slings on the hook.

Trunnion Screen. See Screen, Revolving.

Tube. A term often applied indiscriminately to round buckets, bottom dump buckets and turnover buckets, especially when of the type described under Bucket, Coal.

Turnbuckle. A device for connecting two parts of a bar, rod or rope together with an adjustable tension. It consists of a sleeve with internal right hand and left hand threads at the two ends screwing onto correspondingly threaded bar ends or shank of eyes. Or it may have a swivel at one end, and a right hand thread at the other. The sleeve is turned by a wrench or by a bar through a hole in the center.

Turnhead. A swiveling connection between a spout and the bottom of the hopper or bin whose contents are discharged through it, and which carries part or all of the weight of the spout. It is usually arranged to allow the spout to rotate freely about a vertical axis through the center of the opening, and also often provides for a moderate amount of motion or flexibility about a horizontal axis between two portions of the turnhead itself.

Turntable. A circular platform mounted on a pivot at its center and with wheels or rollers around its periphery running on a circular rail underneath, the whole being capable of revolution in a horizontal plane. A transfer table in which the motion is rotary.

Rotating cranes of the pillar or self-supporting variety are constructed with turntables which generally carry a superstructure with the pillar, boom and hoisting machinery.

Locomotive turntables are constructed with a complete circular table with several tracks, or may be simply a long girder with one line of track, supported by wheels at the end.

The turntable of a locomotive crane consists of a base ring (which generally has teeth cut externally or internally and is used for slewing by power) on which rest the wheels or rollers. These may turn on pins directly carried by the rotating frame, or they may be carried by a separate cage, interposed between the circular track on the base and a similar circular track on the rotating frame. At least four rollers are used, two at the front, and two at the rear opposite the boom; sometimes four are placed in front under the boom, and there is often a complete circle of rollers, this always being the case when a separate cage is used.

Turntable, Air Jack. An air jack mounted centrally under a turntable in such a way that when the turntable is elevated by the air pressure in the jack, it is free to turn, the plunger floating on air. Especially applicable to the right angle junction of two tracks, where it may not be desirable to cut the rails to install an ordinary turntable. The rectangle within the rails is mounted on the jack, and lifts the truck wheels by rising beneath the flanges.

Turntable, Ball-bearing. A turntable which rotates on hardened steel balls running in machined races or grooves, one race in the foundation plate and one in the bottom of the table. These tables rotate easily, and support the load at widely distributed points. Ball bearings are not often used on turntables carrying heavy loads.

Turntable Transfer Car. A turntable mounted on a transfer table or car, in order that an industrial car may not only be transferred from track to track without going through switching operations, but may be turned around as well. The turntable is seldom applied to other than small cars.

Page 609, 721-724.

U-bolt. A piece of round iron bent into the form of the letter U, with the two ends threaded and provided with nuts, and generally used to clamp a cross-piece or similar part to a round rod, pipe, or its equivalent.

Undercut. A term applied to a gate or valve for controlling the flow of loose bulk material from a hopper or bin, when it operates to cut off the flow by coming up through the material from below. With this arrangement there is somewhat less tendency for lumps to prevent complete closing of the valve. It is more often applied to quadrant than to sliding gates.

Universal Joint or Universal Coupling. A form of coupling used to connect, for the purpose of power transmission, two shafts which intersect, but are not in line with one another. The most common form is known as Hooke's joint; it will theoretically allow a lack of alignment of as much as 90 deg., but on account of cramping and interference, the maximum practical angle is about 45 deg. The angular velocity ratio will be variable; that is, if one shaft rotates at a constant speed, the other one will have a periodically varying speed. If two of these joints be used with a short piece of shaft between them, and the coupling parts are properly arranged on the two ends with respect to each other, a constant angular velocity ratio may be obtained. The two shafts need not have their center lines intersecting in this case.

As constructed, universal joints generally take the form of forked ends, pinned or keyed on each of the shafts, pointing toward each other, and pinned to points on the

surface of a sphere, 90 deg. apart, or to the ends of a cross.

Universal joints are used to drive the swiveling trucks of locomotive cranes from a central longitudinal horizontal shaft, and allow them to take the angular position required by curves over which they operate.

Unloader. Any device or machine which will mechanically remove a cargo or load from a floating vessel, car, truck, wagon or other vehicle of transportation. The vehicle may carry its own unloader, as a truck crane, or a self-unloading ship, or it may be brought to a fixed (or adjustable) unloader. The unloader may be designed for handling bulk material or packages. In the former case it may consist of a top-filled or self-filling grab bucket, of an elevator conveyor, of a pneumatic conveyor, or (for liquids) of a pump. If for packages, it may be a cargo crane, or a special conveyor elevator.

Unloader, Automatic Ore. A machine designed for the rapid unloading of iron ore from the holds of vessels of the type developed on the Great Lakes, with numerous narrow hatchways extending nearly the full width of the ship, but narrow in a fore and aft direction. The unloader consists of a large grab bucket mounted eccentrically on the lower end of a vertical leg, and which can be rotated about a vertical axis. This leg is hinged at its top, and at a point about a third of the way down, to two oscillating beams which are connected at their inner or shore ends to horizontal axes between vertical columns carried on one end of a trolley. The leg, two beams and columns form a parallel motion and the hoisting bucket can thus be directed to any part of the hold.

The trolley is mounted on wheels on a bridge extending at right angles to the wharf; another trolley carrying a bottom dumping weighing-hopper runs on rails beneath the bridge, parallel to the top trolley. The loaded grab bucket is brought in short by moving the trolley backward; the ore is dumped into the weighing-hopper from which it is discharged into a railway car on any one of a number of tracks beneath by moving the lower trolley, or is carried to the inshore end of the bridge and dumped into a temporary storage bin in which it can be reached by the grab bucket of a storage bridge whose cantilever overhangs it. The entire unloading machine travels on rails parallel to the wharf and may be moved from hatch to hatch of the vessel as desired.

The top oscillating beam is extended backward and has a weight which counterbalances the overhanging portions; this weight consists in part of the bucket operating machinery. The operator's station is inside the vertical leg just above the bucket, in which position he has an unobstructed view of the latter, and can maneuver it so as to take up all the ore in the vessel's hold.

Also called stiff-leg unloader.

Page 283.

Unloader, Bridge Type. A traveling gantry crane having a cantilever extension over the hatchway of a vessel at a wharf, and used for unloading its contents, generally by a grab bucket suitable for handling bulk material. The bridge stands at right angles to the edge of the wharf, travels along it on rails, and has a horizontally telescoping (see Unloader, Ram Type) or vertically swinging arm extending over the water, which can be moved out of the way while a vessel is docking or leaving. The trolley carries a grab bucket which picks up the material and moves it back, to be dumped directly into a railroad car under the front end of the bridge, or into a hopper over the tracks from which it is later dumped

into cars. Or it is carried further to the rear and dumped into a storage area, to be later reclaimed by the grab bucket for loading into cars. The total length of the rear extension may be so great that it is supported in two or more spans, the various supports running on parallel rails and all traveling at the same speed.

To increase the speed of operation the unloader is often made short, merely spanning the railway tracks and a temporary storage bin, the latter receiving the excess material in case sufficient cars are not at hand to hold it all. A bridge storage crane later takes it from this bin and places it in the storage area at any desired location, independent of the location of the unloader. The ends of the two bridges overlap, but being on different levels do not interfere.

Page 282.

Unloader, Car. Any machine or mechanical means for unloading railway cars. It may be designed for unloading open top or box cars, and for handling package or bulk material. Devices which are applicable to the unloading of bulk material from box cars are the power shovel, suction conveyor, and portable belt, flight, or bucket conveyor. Those for unloading open top cars, other than hopper bottom dumping cars, are car dumpers; bucket elevators, flight conveyors and grab buckets handled by locomotive, bridge or monorail cranes.

The term is usually applied in a more limited way to arrangements of bucket elevators or flight conveyors for unloading bulk material from gondola cars. One device consists of a bucket elevator hung from an adjustable boom by which it may be lowered into the material in the car. The buckets elevate the material and dump it into a hopper which discharges through a spout into an elevated bin, directly to wagons, onto a horizontal conveyor for transportation to a more distant point, or to a heap on the ground. The car must be moved along a track of its own. The buckets are filled by hand shoveling.

Another device consists of a comparatively narrow inclined flight conveyor hinged at its upper end on a carriage which can be moved along on an elevated track over the railway track on which the cars to be unloaded are placed. The lower end is lowered onto the material, and is to a certain extent self-filling through the action of small sections of screw conveyor on each end of the lower sprocket shaft drawing the material toward the flights. The feeders and lower sprocket are all placed within a sort of scoop and the carriage on the overhead track is slowly pushed forward during the operation of unloading, pushing the scoop into the material. The conveyor discharges to a chute at its head end. To use this device the car must be free of tie rods or other obstructions.

Instead of the narrow flight conveyor with screw conveyor feed, an inclined bucket conveyor having buckets extending the full width of the car has also been used, mounted and handled in the same way.

Hopper bottom dump cars are most economically unloaded on trestles or over track hoppers, but such cars must occasionally be unloaded without these facilities. One car unloader for this service has a belt or apron feeder projecting under the car receiving the flow from partially opened hopper bottoms, and delivering it to the lower end of another conveyor which in turn delivers it to trucks or to a temporary bin or pocket.

Page 377.

Unloader, Marine Leg or Dock Leg. See Elevator, Marine Leg.

Unloader, One-Man. An apparatus intended for unloading cars or vessels, and arranged so that only one operator is required. The term is particularly applied to a method of handling ore or coal in bulk in the hold of a vessel by a grab bucket pendant from a trolley with a cab. The operator in the cab controls all motion of the bucket and trolley and of the tower or bridge on which they are mounted.

Page 283.

Unloader, Ore. See Unloader, Bridge Type; Unloader, Automatic; Unloader, Cableway Type.

Unloader, Ram Type. A bridge type unloader in which the bridge contains a long truss or girder telescoping within the bridge and having a trolley traveling on it. When moved back the ram clears the wharf edge allowing free movement of shipping; it also gives a long extension to the rear for dumping into storage. (See Unloader, Bridge Type.)

Also called telescopic unloader.

Unloader, Self-unloading Ship. This type of vessel carries its own bulk unloading equipment, generally of the conveyor type. One installation includes holds built with hopper bottoms discharging through suitable gates onto two belt or pan conveyors running the length of the vessel under the holds, and discharging to an elevating conveyor at one end, generally the bow. This conveyor raises the material above the deck where it is in turn received by another conveyor mounted on a swinging boom of variable elevation, which can deliver the material in any direction beyond the side of the vessel, and at any height within its range.

Many ships carrying package freight also have their own handling machinery, generally called cargo handling gear, and consisting of derricks and winches mounted on the docks.

Unloader, Ship, Sling Type. See Conveyor, Sling.

Unloader, Ship, Suspended Tray Type. A suspended tray carrier arranged for loading and unloading ships, consisting of a light horizontal steel truss supported above the deck, having a pair of endless conveying chains along the top and bottom chords, and hanging in pendant loops at each end, one pair of loops within the hatchway, and the other pair outside the vessel and extending down to the wharf. At regular intervals there are suspended from the chains, platforms shaped to fit the cargo being handled, as barrels, etc. Loads placed on the platforms in the hold are elevated to the truss, carried along it by the top runs of chain, and lowered outside the vessel to the wharf. The direction of rotation is reversed for loading, the power drive being by means of a motor mounted on the truss. (See also Conveyor, Sling.)

Unloader, Stiff-leg. See Unloader, Automatic Ore.

Unloader, Two-Man. Two men are often required for the safe operation of a grab bucket unloader for coal or ore. One man attends to the raising, lowering, opening and closing of the bucket, and the other to moving the supporting trolley in or out on the bridge or jib, and to traversing the bridge or tower, if this be movable.

Page 283.

Valve. A device for stopping or controlling the flow of fluid in a pipe, consisting of a body inserted in the pipe, having a hole through it for the fluid to flow unless closed by a movable part called a valve, valve disc or plug. (See also Valve, Gate; Cock.)

There are various types of valves in use, but by far the most important is the poppet type in which the valve or valve disc is mounted on the end of a valve stem,

and closes the circular valve opening by approaching it at right angles. The valve may be beveled around its periphery and fit into a similarly beveled seat around the edge of the opening, or it may be flat and fit against a raised flat surface on the seat; in this last case a ring of soft metal is often inserted in the face of the valve to assist in making it tight.

Valves are made for connecting two (or sometimes more) pipes at various angles to each other; they are made in many styles and materials, and for many different pressures.

Valve, Butterfly. A valve in which a straight cylindrical pipe or opening through the valve body is opened or closed by rotation of an internal disc mounted on a central transverse shaft or spindle. When the disc is turned across the pipe, flow is stopped; when it is parallel to the pipe, free flow is permitted. Such valves are cheap and effective, but they are hard to keep tight against the pressure of gases and liquids, and are not much used for handling loose bulk material on account of the partial obstruction of the pipe by the transverse shaft and the edge presented by the valve disc.

Valve, Rotary. A valve which has a seat with a number of holes through it and a valve disc with corresponding holes, pivoted centrally on it and rotated as desired by a stem or some other connection leading outside. The valve is wide open or shut, depending on whether the holes in the valve and seat do or do not register.

Valves of this type are used for controlling the flow of grain through the bottom of bins and hoppers.

Valve, Throttle. A valve used for the hand control of the flow of steam or air (or occasionally other fluids) to the cylinder of an engine to adjust its speed as desired. Globe or angle valves of the poppet type, rotary valves and cocks are in common use for this service, though many other special forms are in existence. "Double beat," piston or balanced valves, having two discs or plugs connected by a stem, and fitting against or sliding past openings at two places, are more easily operated than the single types.

Valve, Reversing. A hand-operated valve which can reverse the direction of flow of steam into and out of the cylinder of a steam engine, thus causing the engine to revolve in either direction. The engine valve is made without lap and the eccentric without angular advance, enabling the engine to run equally well (though somewhat inefficiently) in either direction. A reversing valve merely interchanges the exhaust and steam supply connections. It is used on small engines where the convenience and simplicity outweigh the poor economy.

Washer. An annular piece of metal, fibre, rubber or other material placed on a bolt underneath the nut, to form a seat for the latter.

Wharf. A platform of timber, steel or masonry, built along the shore of a navigable body of water and used primarily for loading and unloading vessels. The term quay (British) is also used in this sense, while the term pier is more often applied if the structure projects into the harbor at right angles to the shore.

(See also Dock.)

Wharf Crane. See Crane, Wharf.

Wharf Shed. A roofed structure or building on a wharf.

(See Pier Shed.)

Wheel. In general, a circular frame or disc revolving on its axis. If loose on its shaft and used merely to guide a rope or chain which passes around a groove in its

rim, it is usually and preferably called a sheave. (See Sheave.) More specifically, a wheel is a circular member rolling in contact with a guiding surface and supporting a load by means of an axle passing through its center. (See Roller.)

A simple wheel is composed of a hub fitting a shaft, on or with it rotates, and of spokes radiating from the hub and attached to the inner side of a circular rim which rests on a track. These may be cast in one, or all or any part made separately and bolted together. The spokes may be straight or curved, or may be replaced by a solid web or plate. The rim may be plain, flanged or grooved, or may be provided with a separate tire or shoe of metal or of rubber or other elastic material.

Wheel, Chain. A wheel having its circumference shaped to fit a chain, and used for the transmission of power, or to guide the chain. When the circumference has outwardly projecting teeth shaped to fit a pitch chain, it is usually called a sprocket or sprocket wheel. When the wheel has a groove or pockets, or both, in its circumference, shaped to fit the oval links of a coil chain, it is also called a pocket sheave or wheel, or a chain sheave. Guide sheaves for oval link chain often have smooth concave rims.

Wheel, Flanged. A wheel having one or more annular projections from the rim, generally outward. A single flange is usually at one side of the rim or tread, though center flanges are used in some types of chain wheels. Double flanges are usually at the two sides of the rim.

Wheel, Gap or Gapped. A rope or chain sheave or a sprocket wheel which has openings or gaps in the rim to receive attachments placed on the rope or chain at regular intervals. These attachments are for the purpose of driving, of conveying, or both.

In cable conveyors transmission blocks may be placed at intervals between the conveying flights in case the latter are too far apart to ensure at least two being in contact with the rim simultaneously. Flexible teeth are often provided on one or both sides of the gap, to decrease the friction and wear as the blocks are forced off and on the wheel. To allow for stretch of the rope without the necessity of re-spacing all the blocks, the rim segments are sometimes made adjustable, and can be moved outward to increase the effective pitch of the wheel.

Toothed sprockets having gaps are not dependent on the attachments for driving, therefore are often made with three gaps only. The rim segments may also be adjustable, and flexible teeth may be used at one or both sides of the gap.

Wheel, Hand. A wheel operated by hand power. The wheel diameter depends upon the turning moment which must be exerted, and the size of the rim varies in proportion to the size of the wheel, though it must never be larger than can be conveniently gripped by the hand. Occasionally the rim is roughened, corrugated, or even formed with radiating spokes as handles.

Wheel, Hand Chain. A chain sheave around which is reeved an endless chain, to be pulled by hand for operating hoisting or other machinery.

Wheel, Knuckle. A wheel placed at the point at the top of an incline where a rope or chain used for hauling purposes changes to the horizontal direction. Also, the sprocket wheels at the top of the upward run of a knuckle wheel elevator, where a vertical changes into a horizontal or inclined run. On cable haulage systems, rollers or grooved sheaves are used, called knuckle rollers or knuckle sheaves respectively.

Wheel, Pulley. See Sheave.

Wheel, Pocket. See Wheel, Chain.

Wheel, Ratchet. See Ratchet Wheel.

Wheel, Stepped Tread. A wheel having treads of two (or more) diameters. Such wheels are used on the rear axles of skip cars, and assist in dumping them.

(See Skip Car.)

Wheel, Self-Lubricating. A wheel which contains an oil chamber or reservoir within itself, and means of feeding it slowly to the bearing surface. This feed may be through small holes leading to the bearing, through a porous felt washer inserted in an annular opening in the bore, by an oil fin which lifts the oil from the bottom of the cavity and drips it onto the opening, or by a ring or chain oiler which accomplishes the same purpose.

Wheels or rollers of this type are much used as supports for pivoted bucket, pan, platform and other conveyors carrying heavy loads.

Wheel, Sprocket. A wheel having outwardly projecting teeth shaped to fit the links of a pitch chain. (See Gearing, Chain.) For a long oval link chain, teeth projecting outward through links lying flat on the periphery of the wheel are usual; side flanges may be added to each tooth if desired, flaring at the outer ends to assist in seating the link. For most of the single width chains having pin connected or hinged joints, the sprockets are similar with teeth shaped to fit the blocks, link ends or rollers as the case may be. Broad multiple width chains used for power transmission, or in some cases for conveying, have sprockets with teeth extending across the full width, and engaging with inward projections from the chain links; they may or may not have flanges at the sides.

Some sprockets have adjustable and renewable teeth; this construction justifies the use of larger sprockets which would otherwise be too expensive to replace when worn. Also to adjust the sprocket pitch to suit the increased pitch of a worn chain, the rim is sometimes made in separate segments which can be moved radially outward. Where the chain has attachments which must pass around the sprockets, gaps are often left in the rim to receive them. (See Wheel, Gap.)

Sprockets are set screwed or keyed to the shaft; where necessary for purposes of assembling they are split in half and bolted together at rim and hub.

Wheel, Traction. In general, a wheel which drives by virtue of the friction between surfaces in contact, as distinguished from one which drives by teeth, notches or other positive means. The driving wheels of locomotives and trucks, pulleys in belt drives and so-called friction gearing are examples of traction wheels. In material handling equipment the term is often applied to smooth (sometimes grooved) pulleys used occasionally in place of sprockets on head shafts of single strand chain and bucket elevators, and on certain types of single strand conveyors. Beside wearing better, they have the advantage that a "choke" will only cause slipping and not a break down.

Wheel, Traction Idler. A term applied to a plain wheel without teeth on the rim, around which the chain of a chain elevator or conveyor passes, but which is not the driving wheel, as distinguished from a traction driving wheel. Traction idlers are sometimes used in place of sprockets for supporting the return runs of chains, as well as for foot shafts of elevators and conveyors. They may be plain, single flanged or double flanged.

Wheel and Axle. A little used hoisting mechanism consisting of a grooved sheave fast on an axle turning in bearings. One end of a rope attached to the load

to be lifted is secured to the axle, and an endless hand rope is fitted in the groove of the sheave. Pulling on the hand rope causes the load rope to wind on the axle and lift the load. The ratio of load lifted to hand pull depends on the diameter ratio of sheave to axle.

Wheel-base. The distance between centers of two car wheels travelling on the same rail, or in the same fore and aft line if no rail is used. If more than two wheels are on each side, the distance between the centers of the outside wheels is generally meant. If the wheel bearings are fixed, this is the rigid wheel-base. If two swiveling trucks are used, each truck has its own rigid wheel-base and the total wheel-base is called a total or overall wheel-base.

A long wheel-base distributes a load over considerable track, but, if rigid, makes difficult the negotiation of curves.

In travelling cranes of the bridge type, it is endeavored to have the rigid wheel-base at least one-fifth of the span, to keep the bridge from getting out of square. Where this proportion cannot be reached, special precautions must be taken to insure squareness.

Wheel Train. A series of two or more axles geared together by toothed wheels or belts.

(See Gearing.)

Wheel Tread. The exterior cylindrical portion of the rim of a wheel which bears on a rail. It may be flat, conical, double conical or spherical. Its width should be appreciably greater than that of the rail on which it rests, to allow for inaccuracies in the alignment of the latter.

Whelp. One of the longitudinal ridges or projections sometimes formed on the barrel or drum of a capstan or on a gypsy head, to prevent slipping of rope on the drum.

Whim. A primitive hoisting device used for raising ore or coal from mines of moderate depths. It consists of a large drum set on a vertical shaft on which the hoisting rope is wound, and which is rotated by a horse walking in a circle, and attached to the end of a crossbar attached rigidly to the shaft. The horse is driven in the opposite direction for the lowering operation.

Whip. A block and rope rigged and used for lifting light weights, generally designated as single whip or double whip, the former giving no increase of lifting power, but simply a change of direction.

Whipping. The turns of twine wrapped around a rope close to its end, to keep it from untwisting or unlaying.

Whipping, of Shafting. Vibration or whirling of shafting when rotating at high speed, due to the axes of gravity and rotation not being coincident.

Winch. A stationary, horizontal shaft, geared drum machine, hand or power-driven, which can exert a pull on a rope or chain while winding it on a drum, and can be used for hoisting or hauling purposes, according to the arrangement of rope leading from the drum.

As usually constructed, a winch has a foundation or baseplate on which stand two side frames, stiffened transversely by distance pieces. Between these side frames, and with their bearings contained in them, are the shafts of the various drums, transmission gears, brakes, etc. The baseplate is mounted on a fixed foundation, on skids or on a car, as desired; it is often extended to provide a seat for a boiler or electric motor.

Some winches are worm or friction geared, but the majority use spur gears, and are designated as single or double geared according to the number of geared speed reductions. (See also Winch, Direct Acting.) They

are known as hand, steam, electric, gasoline, belted, etc., according to the power used; as single drum, double drum, etc., according to the number of hoisting drums.

The simplest type has a reversible source of power connected directly to the drum by gearing; for lowering, the first shaft is turned by hand or power in a lowering direction, and a screw brake allows the load to lower only at the corresponding speed. Or, the load may be allowed to overhaul the gearing and motor, control being maintained by a band or other brake operated by a foot pedal. Two or more such units may be included in a two, three or four drum winch, and independent operation be secured for each. The more usual arrangement is to have the source of power connected by gearing to a friction clutch keyed to the drum shaft; the drum is loose on the shaft, but by engaging the friction clutch is made to turn with it and hoist the load. To lower, the clutch is released and the load overhauls the drum alone, a band brake acting on a seat on the drum circumference being used to control the speed. Several such drum units are connected to a single source of power to form a two or three-drum winch. This type is, however, subject to the limitation that pull can be exerted by winding the drum in one direction only, and there must always be sufficient pull in the reverse direction to overhaul. The drums cannot be reversed by power, unless reversing clutches are added to the mechanism, or a reversing engine is used.

Often incorrectly called a hoist or crab.

Page 295, 787, 791, 803, 829.

Winch, Air. A winch which is driven by an air engine. It may be of exactly the same pattern as a steam winch, though special conditions would have to exist to make such an arrangement advisable, such as an already established compressed air system, necessity of freedom from fire and hot steam pipes, etc. The more commonly used air winches are small and portable, are used for miscellaneous intermittent hauling and hoisting purposes and are often of multiple cylinder construction.

(See Hoist, Air.)

Winch, Belted. A winch fitted with a pulley on the first motion shaft and intended to be driven by a belt from a line shaft or independent engine. This arrangement allows the source of power to be used for other purposes at times when the winch is not in use.

Winch, Derrick. A winch especially arranged with a view to operating a derrick. The simplest type has one friction drum for the load line, and the boom is lifted or slewed by hand. More commonly two drums are supplied, one each for the load line and the topping lift; for more rapid operation, or to handle greater loads, power slewing gear is usually added in the shape of one long or two small separated drums with a reversible drive from the main engine, or driven by a separate engine. (See Winch, Derrick Slewing.) An additional friction drum is required if a two-line grab bucket is to be handled by the derrick, unless a drum specially arranged for this service is used. (See Drum, Counterweight.) Four or more friction drums are not often used on derrick winches, except for special work, such as bridge erection.

Winch heads are placed on the extended ends of one or more drum shafts, and these are occasionally loose on the shaft with jaw clutches by which they may be connected to it, and with ratchets and wheels for holding the load when the clutch is out.

The boom is occasionally raised and lowered by a worm gear drive, which will not overhaul and allow the boom to drop; if the engine is non-reversing, a reversing

double-jaw clutch must be provided. If the boom is raised and lowered often, double friction clutches should be supplied.

Page 803, 829.

Winch, Derrick, Slewing or Swinging. A winding machine used for slewing a derrick by power. One type consists of an independent reversible engine driving a winding drum around which are coiled in opposite directions the ends of the rope which passes around the bull wheel; the ends of the rope are, of course, fastened to the winding drum. The slewing winch may be attached to or built into the main hoisting winch, in which case it is usually operated from the main hoisting engine by a reversible friction drive. When thus built in, two drums are often used instead of one to give the leads to the bull wheel a location which will prevent interference with the main and boom hoist lines. Or one drum may be used at the side, located like a winch head, and guide sheaves used to prevent interference of the ropes.

When driven by a reversible engine, no brake is required, as the placing of the reversible throttle or reversible valve gear in neutral position locks the engine and prevents the swinging of the derrick by the wind or other causes. Motor and friction driven winches require a brake.

A slewing winch of considerable power is required for derrick barges on account of side tipping of the barge due to lifting a load at the side.

Also called slewer, boom slewer or swinger, slewing engine, slewing attachment, pony swinging drum, etc.

Page 803, 829.

Winch, Direct Acting. A steam driven winch in which the drum is mounted directly on the engine crank shaft, instead of on a parallel shaft which is geared to it.

Winch, Electric. A winch which is driven by one or more electric motors. (See Winch.) One motor may be used to drive two or more drums by means of gearing, or separate motors may be installed to drive each of the drums. One type of installation has four separate drums—operated by controllers—without clutches, there being solenoid brakes on the motors, and foot-operated band brakes on the drums.

An electric winch is sometimes called an electric hoist. (See Hoist, Electric.)

Page 299, 787, 791, 803, 829.

Winch, Friction Geared. A winch in which one or more of the steps in speed reduction from the engine or motor to the drum shaft is made by smooth-faced friction wheels pressed together with sufficient force to prevent slipping. A common arrangement for a single reduction winch is to have a large friction wheel made fast to the drum, both running loose on a shaft with eccentric journals at the ends; a hand lever attached to this shaft can rotate it through 180 deg. and move drum and gear toward either side. In mid-position the drum runs free; when forced to one side the friction gear is brought into contact with the friction pinion on the driving shaft and the drum is rotated in a winding direction; when moved to the opposite side the friction gear is brought into contact with a fixed brake shoe which retards or stops its rotation. A weight is often arranged to hold it in this position with sufficient force to prevent the drum from rotating, unless relieved by the operator.

Double reduction geared winches sometimes have friction gears between the drive and first motion shaft, but the drum gear and pinion are then usually spur geared on account of the large turning moment.

Winch, Gasoline or Kerosene. A winch driven by an internal combustion engine using the fuel specified. These engines will not start under a load, so a disengaging clutch is always supplied. Gear changing arrangements may also be provided to allow light loads to be lifted at high speeds, and vice versa. A governor is usually provided to prevent the engine from running away in case of unexpected release of the load.

Page 299.

Winch, Hand. A small, hand-operated, horizontal-shaft, geared-drum machine which can exert a pull on a rope or chain while winding it on the drum, and can be used for hoisting or hauling purposes. There are two types, depending on the form of the frame. One has its drum and gears mounted on a plain rectangular frame in such a way that it cannot be attached directly to a wall or floor without interference—a special frame or setting must be arranged for it. The other type has deep frames which practically enclose the gearing, is self-contained, and capable of standing on and being bolted directly to a flat, vertical or horizontal surface.

A single-purchase hand-winch is one in which a pinion on the hand-operated crank shaft drives a large gear on the drum shaft; a double-purchase signifies that there is an intermediate shaft with its pinion and gear. The intermediate shaft is generally extended so that the cranks may be placed on it for high speed lifting of a light load. The crank shaft is also sometimes provided with two pinions of different sizes engaging with gears of different sizes on the intermediate shaft (sometimes known as duplex gearing), thus still further extending the range of gear reduction.

Two or more drums with their gears may be mounted in the same frame, for operation from the same crank shaft, giving a two-drum hand-winch.

Ratchets and wheels are provided on the crank or intermediate shaft to prevent overhauling in case the men stop turning the cranks. Brakes are also provided to control lowering, as lowering by allowing the crank to turn in the opposite direction under manual control is dangerous and unnecessary. These brakes were formerly simply band brakes on a portion of the drum circumference, but Weston and other types of improved brakes are now available, and the screw brake provides a safe automatic lowering device.

Page 295.

Winch, Hoisting. A winch arranged to be used for hoisting purposes, generally in combination with a suitable structure and proper fittings, which with it constitute a crane. The most common form is the derrick, with the hoisting winch located on the ground and the ropes led to the proper points on the derrick by means of guide sheaves. (See Winch, Derrick.) The hoisting winch may be on a platform at the base of the mast and turn with it, or may be mounted on the mast itself, this arrangement being common in the case of jib cranes.

Hoisting winches are operated by hand, by steam or air engines, or by electric motors. (See Winch, Hand, Steam, Air, Electric.)

Page 787, 791, 803, 829.

Winch, Portable. A small winch which is built in its supporting frames in such a way that it can be easily unfastened and moved to a new location for operation, being sometimes mounted on skids or wheels for ease in transportation. A winch which does not depend on special foundations and framing to support it.

Page 787, 791.

Winch, Power. A winch driven by some form of engine or motor, or from a line shaft, as distinguished from a hand-operated winch.

Also a term sometimes applied to a winch fitted with a pulley, and driven by a belt from a line shaft or independent engine.

Winch, Reversing. A winch driven by an engine or motor which may be reversed in direction of rotation. The direction of rotation of the engine itself may be reversed by suitable valve gear or by a reversing valve, thus reversing all the shafts of the winch; one or more shafts may be reversed independently by using reversing gearing, either of the friction type, or of the bevel gear type combined with jaw or friction clutches.

(See Gearing, Reversing.)

Winch, Single Pole or Double Pole. A hand winch which has a frame arranged to attach to a single pole or to two poles of a derrick, jib crane, gin pole or similar crane structure.

Winch, Steam. A winch which is driven by a steam engine. (See Winch; Winch Engine.)

Page 299, 803, 829.

Winch, Twin-Drum. A winch having two winding drums on the same shaft, or in line axially. A common arrangement is to have an engine or motor with a pinion on its shaft, driving a large gear which is keyed to the drum shaft near its center and between the drums. The drums are loose on the shaft, but either or both may be connected to the gear by friction clutches, of which one-half is mounted on the gear and the other on the end of the drum. (See also Drum, Friction.) These winches are much used in handling two-rope grab buckets in dredging or excavating operations, and in coal and other bulk unloading equipment.

In this coal unloading service fast work is essential to economy, the hoisting speeds being as great as 1200 ft. per min., and the lowering speed of the empty bucket is correspondingly rapid. This causes the generation of much heat at the engaging clutch surfaces, which also act as braking surfaces. Special arrangements of internal vanes in the drums cause a rapid circulation of air inward through the ends of the drums and outward through openings in the base of the clutch cone; fins cast on the clutch also assist in radiating heat, and occasionally water circulation is used. A small brake is generally provided on the crank disc of one of the two steam engines to hold the crank shaft (and with it the large gear and the attached clutch parts) at rest during lowering. In the case of an electric motor, a similar brake is placed close to the motor, unless dynamic braking is used.

Some twin-drum winches are direct-acting; that is, have the engine or motor connected directly to the drum without intervening gearing, thus giving extremely high winding speeds.

Page 803, 829.

Winch Engine. The engine, generally steam, used to operate a hoisting or hauling winch.

There are usually two horizontal cylinder engines, with their cranks at 90 deg., mounted on the same frame as the various drums; a seat for an ordinary vertical boiler is nearly always included in the baseplate, though it is not always provided with the winch and engine. Non-reversing engines are often used, in which case some sort of friction or toothed reversing gear may be required for one or more of the drums or shafts operated by the engine. If the engines are reversing, link motions of the Stephenson or Gooch type are used, or for small engines

like those driving slewing winches a reversing valve is used, by which the steam supply and exhaust connection are interchanged.

In some small winches intended for use with compressed air, the two cylinders are placed at right angles, and their connecting rods are operated from the same crank pin. Oscillating cylinders are also sometimes used for small engines.

Winch Head. A drum having the winding surface shaped in a concave curve, and used for hoisting by making a few turns of rope around it and pulling slightly on the free end. By varying this pull the slipping on the drum may be made large or small, or the load may even be lowered, independently of the speed of the drum. Where it is important to have no slipping, whelps or ridges are formed on the winding surface.

These drums are usually fitted overhung on one or both ends of the shaft of a winch drum. They may be keyed fast to the shaft, in which case they are known as solid or fixed winch heads, or they may be loose on it and be connected at will by a jaw clutch, in which case they are known as clutch or independent winch heads; a ratchet and wheel is then added to hold the drum when it is disconnected by the clutch.

Winch heads have many names, some of the more common ones being Gypsy Head, Nigger Head and Friction Drum.

Windlass. A stationary horizontal shaft geared machine, generally power driven, with one or more chain sheaves or wildcats for exerting a pull on a chain, for either hoisting or hauling purposes. A steam engine or electric motor is the usual driving power, acting through one or more reductions of worm gearing to drive the main sheaves. These last may be disconnected from the hoisting gear when desired and allowed to overhaul, being controlled by band brakes on their circumference. One or more winch heads or gypsy heads are also often formed on the overhung extensions of the main shaft, for use in exerting a pull on ropes. Windlasses are much used on shipboard for hoisting anchors.

Also, a small machine which exerts a pull in a rope or chain by winding it on a drum which is directly mounted on a shaft turned by hand-operated cranks; a winch minus the gear reduction. Example, well windlass. Page 787, 791, 829.

Wire Rope. A rope made up of wires laid into strands and these strands formed into a rope. Either hemp or wire cores or centers may be laid in each of the strands, and in the complete rope.

Round ropes are practically universally used, except in some hoisting work where the flat form is advantageous. The individual strands are usually round; they may be flattened on the exterior. Some ropes do not have strands, the wires being placed in successive layers on a steel core—sometimes called smooth-coil rope.

Wire ropes are designated by their diameter in inches, measured on the circumscribing circle, and by the number of strands and wires per strand, as 1 in. 6 x 19.

Page 320, 818-822.

Wire Rope, Cable Lay. See Wire Rope, Tiller or Hand.

Wire Rope, Coarse Laid. A wire rope composed of six strands laid around hemp core, each strand having seven wires called a 6 x 7 rope. It is relatively stiff and is used for haulage or transmission, where large sheaves can be installed, or, when galvanized, for standing rope and guys. Also called standing rope.

Wire Rope, Flat. A wire rope made for hoisting purposes, and consisting of a number of alternating right and left hand lay four-strand ropes placed side by side and sewed with soft iron wire so as to form a broad flat band.

Wire Rope, Flattened Strand. A wire rope composed of strands flattened on the outside so as to present a smoother surface and more wearing area.

Wire Rope, Galvanized Rope. Rope in which the individual wires have been galvanized before being made into a rope.

Page 818-822.

Wire Rope, Haulage. Rope used for haulage purposes. It is composed of large wires in order to resist abrasion and therefore is only moderately flexible. (See Wire Rope; Wire Rope Strand.)

Page 818-822.

Wire Rope, Hoisting. A flexible rope used for hoisting purposes, as in cranes, mine hoists, elevators, etc., where it must carry heavy loads and pass frequently on and off a winding drum and around guide sheaves.

Page 818-822.

Wire Rope, Lay of. The direction in which the strands are laid in the rope, either right hand or left hand. In regular lay the strands are left hand lay and the rope right hand lay; regular left hand rope has the lay of both strands and rope reversed from the above.

In Langs' lay the wires in the strands and the strands in the rope are made up with the lay in the same direction.

Wire Rope, Marline Clad. Wire rope having its strands served or wrapped helically with hemp or fibre marline so that the metal is completely covered and protected from wear and the action of water, corrosive gases and liquids, etc.; it is also easier to handle and can be coiled down like cordage rope. For some purposes both the strands and the rope are served with marline.

Page 818-822.

Wire Rope, Non-Spinning. A wire rope in which the strands are laid so that it will not rotate when a load is hung from the free end of a single line.

Page 818-822.

Wire Rope, Standing. See Wire Rope, Coarse Laid.

Wire Rope, Smooth Coil. See Wire Tramway Strand.

Wire Rope, Steel Clad. Wire rope having each strand wrapped helically with a flat strip of steel. Also called armored rope.

Page 818-822.

Wire Rope, Tiller, or Hand. A rope made of six strands laid around a hemp core, each strand being a complete rope with six strands of seven wires each laid around a hemp core. The lay of the strands, rope strands and complete rope alternate in direction. This construction is also termed cable lay. (See Wire Rope, Marline Clad.)

Page 818-822.

Wire Rope, Traction. A wire rope used in aerial tramways for hauling the bucket along the track rope. The carriages are gripped to it automatically or by hand, or are fastened to it permanently, according to the system. (See Aerial Wire Rope Tramway, Double Rope System.)

Wire Rope, Transmission. Wire rope made into an endless loop and used for the transmission of power between a driving and one or more driven pulleys, intermediate portions being supported by idlers if the distance requires. (See Wire Rope, Haulage.)

Wire Rope Core. The center of a wire rope strand or of a complete rope, composed of a yarn or strand of hemp or steel.

Wire Rope Strand. One of the component parts of a rope, consisting of a group of wires of uniform or varying size. The strand may be round or flattened.

Wire Track Cable. A round cable used for aerial rope tramways and cableways, consisting of a strand of seven or nineteen round wires surrounded by from one to five layers of abutting square or trapezoidal section wires,

and with a smooth outer covering of special interlocking section wires, the various layers being alternately right and left lay.

Wire Tramway Strand. A wire rope composed of a single strand made up of 7, 19, 37, 61 or 91 wires arranged in one, two, three, four or five layers around a central wire of the same size. Successive layers may be laid to the same or to alternating hands. Used as a track or trolley cable for aerial tramways. Also called round track cable and smooth coil cable.

Electrical Definitions

Electricity: Direct Current: Alternating Current: Magnetism: Current; Ampere: Ampere-hour: Resistance; Ohm: Electromotive Force; Volt: Power; Watt: Killowatt-hour: Phase: Series: Parallel: Power Factor: Cycle: Frequency: Efficiency: Rating: Batteries: Generators: Transformers: Magnetos: Motors: Controllers: Rheostat: Switches, Circuit-breakers and Fuses: Electric Braking: Electrical Equipment.

Electricity is primarily used in material handling as a means of driving machinery. For this purpose there are required motors or electro-magnets, and these units must be connected by some form of transmission system to an electric generator or storage battery which constitutes a source of electrical energy supply. Eighty-five to ninety per cent of all new material handling installations are electrically operated. It should be considered as an established fact that electricity is the proper motive power to use in every case where anything beyond manual capacity is required for driving cranes, hoists, elevators, conveyors, capstans, and other machinery intended for handling materials in bulk, unless no central station supply is available and the construction of a plant presents unusual difficulties. The characteristics of the machines driven vary widely with the cycle of work to be performed and the class of industry served and this makes each installation a separate problem in itself. Availability of a particular type of electric central station as a source of supply may further limit the choice of equipment. The service characteristics for a given machine are, however, generally of a sufficiently definite nature to determine the class of motor, electro-magnet or battery suitable for the work.

Various kinds of electrical signalling and controlling apparatus are also used in material handling and are frequently necessary to adapt motors to the starting, driving and stopping of machinery.

The economies to be derived from electrification of existing material handling machinery have been widely overlooked, and this a primary reason why no more than approximately five per cent of the potential demand for material handling machinery has been met. The most evident consequences of electrification are increased production, space economy, reduced fire risk, flexibility in arrangement of machines, reliability and uniformity of product, and reduced depreciation. For hoisting machinery electric drive is preferable to the compressed air, hydraulic and steam drives in most of the above respects, with ease of control in addition.

The conversion of the older types of drive, for example steam to electric hoists, may in some instances be accomplished by removing engine connecting rods, and coupling or gearing motors to crank discs. This substitution of electric drive is likely to cause different

stresses which may exceed the maximum ones in the older types of drive, so that it is generally advisable to use entirely new machinery.

Electrical Terms

Electricity. A conception of electricity sufficient for present purposes is obtained by a consideration of what it does and how it manifests its presence. Electricity heats a wire or other metal conductor through which it flows, under certain conditions producing incandescence; gives a sensation of shock to persons or animals through whom it passes, as well as burning the skin; makes sparks and arcs when its passage through a continuous circuit is interrupted by opening of the circuit; deflects a magnetic needle placed near a conductor energized by it; magnetizes a steel or iron mass if the latter is made to form the core of a coil of wire through which the current passes; and causes rotation of electric motors; etc.

A further conception of electricity is gained by noting the methods of its production. It can be obtained at the expense of the chemical energy of a battery or of the mechanical energy of rotation applied to a generator, and it is readily reconverted into chemical or mechanical energy as in the storage battery and motor. Furthermore the generator works because of the well known physical law that a magnet and a coil of wire may be so moved relatively to each other as to set up an electromotive force, thus producing an electric current flow in the wire, and the electromagnet can be made by passing electricity through a solenoid, so that magnetism and electricity are mutually interconvertible.

Direct and Alternating Current. An electric current practically constant in magnitude and direction of flow is called a *direct current*. The term continuous current is used in the same sense in England but in America continuous is intended to mean steady and non-pulsating. Direct current motors have better speed control than alternating current motors and permit more ready employment of dynamic braking for the lowering operations of crane work.

An *alternating current* is an electric current which varies continuously with time from a constant maximum value in one direction along the circuit to the same value in the opposite direction, then returning to zero and back again to the first direction, alternately repeating this

cycle in equal intervals of time. Such a current alternates in polarity and direction of flow and therefore will not charge a battery. The alternating current system is generally used where power is to be transmitted over considerable distances or in large amounts because of the simplicity and ease with which it can be transmitted economically.

Alternating and direct current are readily interconvertible by the use of suitable apparatus.

Magnetism. It has been known for centuries that ferrous metals could possess the characteristic of attracting iron or steel. A *magnet* is said to have unit strength when it exerts a repulsion of one dyne upon an exactly like and equal magnet at a distance of one centimeter. Those parts of a magnet which possess the power of attracting iron are usually the ends of the mass, whether bent or straight, and are called the poles of the magnet. Any space in which a magnetic pole will be acted upon by a force tending to set it in motion, such as the space surrounding a magnet or conductor of electricity, is called a *magnetic field*. A magnet may be made by passing direct current electricity through a coil of wire wrapped around an iron core, the electric current producing a magnetic flux in the iron, and forming what is known as an electromagnet. This coil is called a *solenoid*. When sides and ends of the solenoid are enclosed in iron, thus furnishing for the magnetic flux an iron return path of less opposition than the air path, the unit is known as an *iron clad solenoid*.

Current: Ampere. The flow of electricity from place to place, for example along a conductor, is called *current*. The unit of electric current or flow is the *ampere*. It is practically represented by the direct current which deposits silver at the rate of 0.001118 grams per second from a silver nitrate solution of standard specifications, and is technically defined as the direct current which, flowing in a wire of one centimeter length and at right angles with a uniform magnetic field of unit intensity, will cause the wire to be deflected with a force of one tenth of a dyne. The symbol is I or i.

The amount of current flowing in a conductor is important in determining the size of conductor to use, particularly as the heating is proportional to the square of the current. One *ampere of alternating current* is that flow of electricity which produces the same heating effect in a resistance circuit as a direct current of one ampere. The electrical measuring instrument which indicates the number of amperes of electric current flowing through a conductor is called an *ammeter*. The instrument is placed in series in the circuit to be metered or is shunted across a resistance placed in the circuit. The latter is called a *shunt ammeter*, the former a *line ammeter*.

It is a fundamental law stated by Kirchoff that the electric current leaving a conductor must equal the amount of current entering for all direct current circuits. Therefore the ammeter may be inserted in the direct current circuit at any point and the same ampere reading will result.

Ampere-hour. The *ampere-hour* is the unit of quantity of electricity, and is technically defined as one ampere flowing for one hour, or as the product of the current in amperes by the time in hours. This term is used particularly in charging batteries. (See also Battery Capacity, Ampere-hour. The coulomb which is one thirty-six hundredths of the ampere-hour is also used as a unit of quantity.

Resistance: Ohm. Resistance is the term used to express the opposition to the flow of direct current electricity. Any substance which will carry electricity is called a conductor, though this carrying ability may vary with the material. The resistance of a uniform conductor is proportional to the length and inversely proportional to the cross-section. A rise of temperature causes an increase of resistance with nearly all metals. The resistance of an electrical circuit is decreased by adding other resistance in parallel, or increased by adding resistance in series. A decrease of resistance in a circuit causes an increased flow of current, if other conditions remain unchanged. Resistance is invariably dissipative and causes a loss of energy which goes into heat and thus the flow of electricity tends to raise the temperature of any conductor through which it passes. (See Rheostat.)

The unit of electrical resistance is the *ohm*. It is practically represented by the resistance offered to an unvarying electric current by a column of mercury, having a mass of 14.4521 grams, at the temperature of melting ice, of a constant cross-sectional area, and of the length of 106.3 centimeters. The symbol is R or r.

Resistance is commonly measured by dividing the voltage across the circuit by the amperes of current flow. This necessitates the recording of simultaneous voltmeter and ammeter readings on the unit to be measured. **Electromotive Force: Volt.** Electromotive force is the electrical pressure tending to produce current flow. It may be produced in two ways, namely, (1) by bringing two dissimilar bodies in contact as in the case of batteries, (2) by varying the magnetic flux linking a circuit, as for instance moving the coil of a generator armature past the magnetic poles.

The electromotive force of a generator depends on the amount of magnetic induction from the generator poles which links the rotor coils, the number of turns of armature coil and the speed of rotation. (See also Battery Electromotive Force.)

The unit of electromotive force is the *volt*. It is the electromotive force which steadily applied to a conductor of one ohm resistance will produce a current of one ampere. The symbol is E or e and V or v.

The electrical measuring instrument which indicates the number of volts of electromotive force across the terminals of a machine or conductor is called a voltmeter. The instrument is connected in parallel with the unit across which the voltage is to be measured.

When a generator is running at rated speed and no load, that is without any current passing through the armature windings, the voltmeter reading across the generator terminals is the generator electromotive force. If a load is connected to the generator there will be a drop of voltage due to the armature resistance, and the voltmeter reading will be lower. The latter voltage is commonly called the *potential difference* between the generator terminals. A similar phenomenon occurs in batteries. The voltmeter reading between any two points on a circuit may also be termed a potential difference.

Power: Watt. The *power* of an electric circuit is the rate at which work is being done by the current. The unit of electrical power is the *watt*. The symbol is P. For direct current circuits this is equal to the product of volts and amperes, which gives rise to the definition of a watt as a volt-ampere. For alternating current circuits the power in watts is equal to the volt-amperes multiplied by the cosine of the angle by which the current leads or lags the voltage. The latter quantity is

DEFINITION SECTION

known as the *power factor* of the alternating current circuit. A watt is 44.26 foot pounds per minute, one horsepower dividend by 746. A *kilowatt*, one thousand watts, is used as the unit of power where large amounts are involved. The *wattmeter*, and *kilowattmeter*, are the measuring instruments used to determine the rate at which work is being done at any given instant.

Kilowatt-hour. The kilowatt-hour is the electrical unit of work, being the amount of energy delivered by a source of electricity which gives out power at the rate of 1,000 watts continuously for one hour. Electrical measuring instruments called the *kilowatt-hour meter* and *watt-hour meter* are used to determine the amount of electrical energy received from the supply circuit during a certain interval of time. This is the meter commonly used to determine the amount of electricity used by a customer, for billing purposes.

Phase. Phase means the distance in angular measure, from the instant when an alternating current wave passes a certain datum point (say zero current) to the instant when the alternating electromotive-force wave passes the same datum point (zero voltage).

Inductance in the circuit causes the current to lag behind the voltage. If there is capacity in the circuit the current will lead in phase. If the voltage and current waves are rising and falling exactly in step, their zero values occurring at the same instant, they are said to be in phase.

The term phase is also applied to measure the angular distance between two voltage waves of the same frequency on different machines. The voltage waves of two separate circuits are said to be in phase, for example, if their wave impulses rise and fall exactly in step.

The term *single phase* is applied to circuits in which the alternator is arranged to give a single voltage wave to a two-wire circuit.

Two-phase, or *quarter-phase*, is used to designate the combination of two circuits energized by alternating electromotive forces which differ in phase by 90 deg.

Three-phase means the combination of three circuits energized by alternating electromotive-forces which differ in phase by 120 deg. Three wires are required for transmission by three-phase. *Polyphase* is a general term applied to systems of more than a single phase.

Any of the above systems may be used in alternating current machinery, but for material handling equipment where alternating currents are selected, the single phase or three-phase circuits are preferred.

Series. Series or series connection is used to designate a method of connecting two or more electric machines or conductors to a supply or distribution circuit so that the same electric current flows through each one in turn, that is, first through one and then through the next.

Parallel. Parallel or parallel connection is used to designate a method of joining two or more electric machines or conductors by which all units are connected across the same two terminals so as to divide the electric current between them as it flows through the circuit. *Multiple* is a synonymous term. The current divides inversely as the resistance encountered.

Inductance: Impedance: Capacity: Reactance: A solenoid or other coil of wire offers more opposition to the flow of alternating current electricity than to direct current electricity. Furthermore the voltage wave measured across such a coil is out of phase with and leads the current wave. This is known as the inductance effect. In certain alternating current circuits, such as those using a condenser,

the current wave leads the voltage, this being known as the capacity effects. Inductance and capacity have diametrically opposite effects on a circuit and tend to neutralize each other. The total opposition to alternating current flow in a circuit, including the resistance, inductance and capacity combined in proper vector relationship to each other, is known as the *impedance*. Inductance and capacity combined without resistance is known as *reactance*.

Power Factor. The ratio of the power input to the product of effective voltage and current of an alternating current circuit is defined as the power factor of the circuit. This ratio cannot be in excess of unity and usually is less. Power factors may be lagging or leading depending on whether the inductance or capacity respectively is the predominating influence.

Cycle. When an alternating current has gone completely through one series of positive and negative values, and has returned to its original condition, it has passed through a cycle.

Frequency. Frequency is the number of cycles per second in the alternating current circuit. Twenty-five and 60-cycle frequencies are the most common. A frequency of 25 cycles is often used for power generation, and 60 cycles for power generation and lighting service.

Power Capacity. The power which a device can safely carry is called its power capacity.

Efficiency is the ratio of the power delivered by a machine or unit to the power received by it. Efficiency varies with the temperature, speed, load, voltage, current, power-factor, wave shape, and frequency of the machine, as well as with general conditions such as lubrication and commutation details. For alternators and transformers the ratio of the kilowatt output to the kilowatt input at rated kilovolt-ampere and power factor is defined as the efficiency.

(See also Efficiency of Battery.)

The principal losses in an electrical machine are core losses including eddy-current losses, $I^2 R$ losses in the armature and field windings, brush friction, brush contact, friction bearings, windage, di-electric losses, short-circuit losses during commutation, rheostat losses, and in transformers the extra copper loss of the windings due to stray fluxes caused by load currents.

Rating. The power output and other conditions for operation of an electrical machine are specified by the manufacturer on the rating plates.

Continuous, short time and nominal ratings are the most common ones used. The *continuous* rating of a machine gives the power, current and voltage at which the unit is intended to operate without stopping. The machine operating at this continuous output should meet the approved limitations of temperature, mechanical strength, commutation, di-electric strength, frequency, speed, voltage, efficiency, power factor, regulation, wave shape and insulation resistance. The *short-time* service rating of a machine specifies the power, current and voltage at which the unit may be safely operated for the limited period of time given in the rating. The term *nominal* rating is used mostly in alternating current railway machines where excessive loads for brief periods of time make the use of continuous ratings inconvenient. For example, a substation machine may be given a nominal rating of kilovolt-ampere output at a stated power factor input, which after producing a constant temperature in the machine, can be increased 50 per cent for two hours without producing excessive temperatures. Also ma-

chines marked with a nominal rating should be able to carry a load of twice their rated output for a one-minute period without injury. The principal limitations of electrical machines relate to the thermal characteristics and mechanical stresses. Temperature is the most common controlling element in fixing the rating.

Rotating machines with a continuous rating should be able to carry a 50 per cent overload current momentarily at rated load excitation, and should be able to develop, without stalling, a running torque of 175 per cent of the running torque corresponding to rated load.

Electric locomotives are rated in terms of the weight on the drivers, nominal one-hour tractive effort, continuous tractive effort and corresponding speeds.

Automobile propulsion motors and generators should be given a continuous rating, equal to the output available at the shaft at the rated speed. Higher temperature rises than those standard for stationary machines are permissible on these propulsion dynamos, thereby reducing weight and bulk.

(See also Rating, Storage Battery; and Motor.)

Polarity. The terminal of the generator, battery or other electrical unit which is at the higher potential is said to be the terminal with positive polarity, and the other is called the terminal with negative polarity.

Current Capacity. The term current capacity is used in connection with various kinds of electrical apparatus to define the amount of current which the conductors can safely carry. Excessive current may be prevented in a circuit by placing suitable resistance in series with the circuit, but this may increase the heating loss beyond economical limits. Resistance placed in parallel with the load of a storage battery or generator increases the total current flow from the machine, so that the allowable addition of rheostats in parallel with any load is limited by the current carrying capacity of the machine.

Electrical Apparatus. Any machine or device pertaining to the generation, storage, transmission, control, utilization or measurement of electricity, including any contrivance used to regulate the operation of such a device, is commonly classed as electrical apparatus or equipment. Batteries, generators, magnetos, motors, lifting magnets and electric brakes are in a group having to do with the generation, storage or utilization of electricity. Transmission apparatus includes transformers, insulators, and conductors. There is a group containing a considerable number of electrical controlling machines and devices, such as rheostats, switches, push-buttons, circuit breakers, fuses, controllers, compensators, overload releases, and underload releases. Certain miscellaneous devices may also be classed together such as ignition coils, spark plugs, solenoids, signal outfits, lamps and measuring instruments.

Batteries and Battery Details

Battery. A group of cells electrically connected and assembled in one case in order to obtain greater voltage and power than can be supplied by one cell is called a battery.

The cells may be assembled either in series to give higher voltage (equal to the sum of the cell voltage), or in parallel to give higher current than one cell supplies, due to smaller internal resistance), or in a combination of series and parallel arrangements. In locomotive service, 48 or more cells are usually used in series.

The conductors connecting the terminals of a battery cell to another cell or to the external circuit are called *connectors*. The *container*, sometimes called the *case* or

tray, into which the cells are assembled to form a battery, is built of hardwood thoroughly coated with acid-proof paint for lead-acid batteries and of steel for nickel-iron batteries.

Storage batteries are used to drive locomotives, trucks, industrial tractors, or smaller carrying devices, and portable cranes; in electric starting and lighting systems of various types on gasoline and kerosene vehicles; in signal systems; and as a reserve in case of the breakdown of a prime mover or in case of excessive loads in the power plant.

The voltage of a battery may be varied by cutting in or out of the series circuit one or more of the *end cells* of the battery.

Page 719, 736, 742.

Lead-acid Battery. There are three types of lead-acid cell: (1) a storage cell with lead plates, an electrolyte of dilute sulphuric acid, and a jar of glass or hard rubber. By the electrochemical action of charging, a layer of lead peroxide coats itself on one plate, forming the conductor of the higher potential. (2) A storage cell with lead-antimony alloy plate into which pasty active material of lead peroxide is pressed, the electrolyte being dilute sulphuric acid, and the jar of glass or hard rubber. (3) A storage cell with positive plates consisting of a series of hard-rubber slotted tubes containing active material, an electrolyte of dilute sulphuric acid, and jar of glass or hard rubber.

The positive plate of all these types is essentially lead peroxide and the negative plate is either of lead or else contains an active material of spongy metallic lead.

A lead-acid cell when charged will have an electromotive force of about two volts. The voltage of a charged battery with cells in series is therefore equal to the number of cells in series multiplied by two. When the lead-acid cell discharges the chemical reaction, produces the current. As discharge continues, the electrolyte becomes weaker, the lead sulphate increases in quantity and bulk, filling the pores of the plates, thereby retarding the free circulation of the acid. Since the acid cannot maintain its normal action the cell becomes less active and the voltage drops. Discharge should be stopped and recharging commenced before the cell voltage has dropped lower than 1.70 volts. The electrolyte used in the lead type of battery is always sulphuric acid of special purity diluted with pure distilled water. The various battery manufacturers specify the exact conditions and constituents of electrolyte for best service of their particular cells and their instructions should always be carefully followed.

The lead-acid battery is less expensive in first cost than the nickel-iron type and is lighter in weight.

Page 736.

Nickel-iron Battery. The nickel-iron, or alkaline, type of storage battery cell consists of a steel jar containing steel plates, active material of nickel and iron oxides, and an electrolyte solution of sodium or potassium hydroxide in water. It has been widely known as the Edison cell. During discharge the negative iron plate becomes oxidized and the positive nickel oxide plate is reduced to a lower oxide; the electrolyte is not changed chemically. The true chemical change is complex and varies with conditions. The specific gravity of the electrolyte of the nickel-iron cell is unchanged by charge and discharge. The voltage of this type when charged is 1.7 to 1.95 volts per cell. As a means of providing efficient supports for the active material, plates and separators must be strongly constructed.

DEFINITION SECTION

The positive plates consist of perforated steel tubes, nickel plated, filled with alternate layers of nickel hydroxide and pure metallic nickel in thin flakes, and the negative plate consists of a cold rolled steel grid, nickel plated, holding a number of rectangular pockets filled with powdered iron oxide. The nickel is added to give the necessary conductivity to the active material. Narrow separating strips of hard rubber are inserted between the positive and negative plates to insulate them from each other after assembly, and side insulators and hard rubber bottom lining are used to prevent contact of the plates with the steel container. The jar is of nickel plated cold rolled steel, the walls being corrugated to give the greatest amount of strength with minimum weight. A nickel plated sheet cover is provided, containing two pockets for the terminal posts and an opening for filling the cell with electrolyte or occasional addition of distilled water. Stuffing boxes with hard and soft rubber washers and bushings are used about the terminal posts. The filling opening is provided with special vents to prevent absorption by the caustic alkali or carbonic acid from the air, at the same time allowing the egress of gases evolved during charging.

Nickel-iron batteries are made largely of steel and are therefore particularly strong and durable. They have in many cases been exposed to fire without serious damage, and have withstood short-circuit during accidents. The frequent hydrometer readings and attention necessary in other batteries are not required, so that maintenance charges are under two per cent of the original cost. The requirements of operation are charging, keeping outside of cells clean and adding distilled water. Their ability to do service at several times normal discharge, the fact that many of these batteries have served six and seven years, and the absence of noxious and corrosive fumes are especially desirable features for many kinds of service.

Page 719, 742.

Cell. The fundamental unit of any type of battery is the cell, which is a device for producing electric voltage by the chemical action resulting when two electrical conductors of different material are placed in an acidic liquid or paste. The two conductors of such an apparatus are found to be at different potentials and the cell will therefore act as a generator of electricity and furnish current to a circuit connected across its terminals.

The conductor of the higher potential is called the *positive* and that of the lower potential the *negative* terminal. The positive is therefore the conductor from which current flows into the external circuit when the battery is discharging, while the negative receives current from the external circuit during discharge. The acidic substance, whether liquid or paste, is called the *electrolyte*.

When a cell, either separately or in conjunction with other cells, has both terminals joined to a conductor, the current flows both in the cell and outside circuit and the terminal voltage of the cell will drop, due to the opposition of the internal resistance of the battery to this current flow. On most types of battery the negative plate is observed to waste away, its consumption furnishing the energy required to drive the current through the cell and the external circuit. The voltage of a cell is dependent on the material of which the plates are made and the kind and condition of the electrolyte. Size of parts affects the capacity and life of the cell but not the voltage.

A cell may be of the *Primary* or *Secondary* class. Pri-

mary cells are of small capacity and not suitable for power purposes, but are used for ringing bells, gas engine ignition systems and similar low capacity work. They include all cells which can be recuperated only by the installation of a new negative plate to replace that consumed, and by the substitution of fresh electrolyte. Dry cells and many wet cells are of this class. Secondary cells, commonly called storage cells and accumulators, are recuperated by charging with direct current electricity from an outside source, sent through the cell in the direction opposite to that in which it delivers current. Secondary cells are used whenever batteries are to supply electricity to motors. There are two principal types, the lead-acid and the nickel-iron.

Cell Requirements. A good cell should possess all or most of the following characteristics:

1. High and constant electromotive force.
2. Small internal resistance, thereby facilitating high discharge currents and low internal heating.
3. Constant current output, therefore freedom from polarization or local action, and small liability to rapid exhaustion.
4. Perfect inactivity when the circuit is open.
5. Durability, freedom from need of constant attention, and a serviceable jar.
6. No emission of corrosive fumes, and no overflow of electrolyte.

A cell also has to meet the special requirements of the use to which it is put. For example, a cell for vehicle service should have strength, durability, lightness and suitable capacity which means low internal resistance because of high current demand on acceleration of speed and ascending of grades. It should also have the flattest possible voltage characteristic, that is the least obtainable voltage variation under average conditions of discharge. A cell for locomotive work requires power, ruggedness, high efficiency and longevity. For some kinds of service a cell needs ability to furnish current and withstand depreciation at low temperatures, and to recuperate after partial discharge. Low operating cost is ordinarily quite as important as low initial cost.

Secondary Cells. In secondary cells the positive and negative conductors are generally known as *positive* and *negative plates*. Both plates consist of a series of *grids*, one or both containing active material which gives added capacity to the cell. In addition to plates, active material and electrolyte, such a cell consists of *separators*, *terminals* and *container*. There are two straps (positive and negative) each supporting its series of vertical plates, thereby forming two *groups* known as positive and negative. The groups are arranged with spaces between the plates so that the two series may be interleaved in assembling, plates of opposite polarity being kept out of contact by *separators* of non-conducting material, usually hard rubber or wood. Straps are provided with *terminal lugs* for attaching the plates and with *posts* to which the cell connections are made. One positive and one negative group of a cell with separators assembled is called an *element*. After assembling groups and separators the whole is placed in a sheet steel, rubber or hardwood cell container or jar with the electrolyte.

Container. The container or jar which holds the electrolyte may consist of the following acid resisting materials:

- (1) Hard rubber, glass or wood for lead-acid cells. Glass jars are customary for stationary lead-acid bat-

teries, except for the larger types which are assembled in lead lined wooden tanks. Cells for vehicle service have rubber containers. A wood container coated with acid resisting paint is used in many of the smaller sized cells.

(2) Nickel plated cold rolled sheet steel containers with corrugated sides for nickel-iron cells.

Cover Details. The *cover* of the battery jar is usually of the same material as the jar and is sealed to it with a gas-tight joint. It is provided with a *filling vent* or aperture for each cell through which the electrolyte or water is introduced, and which is closed by a hinged threaded, or bayonet type *filling plug* containing a *gas vent*.

Group. A group is a set of cell plates, either positive or negative, assembled to a hard lead or lead-antimony casting called a *strap*. The assembling is usually accomplished by burning, the terminal post and strap being usually cast in one piece. Cell capacity is increased by using more than one plate per terminal because of the increased area of active material exposed to the electrolyte. Straps consisting of a central round terminal are called *pillar-post* straps, those in the form of an inverted L are called *plate straps*. The term *cross-bars* is used synonymously with strap. The portions of the straps of a cell extending through the cell cover and used as terminals are called *posts* or *poles*.

Battery Terminals. Fittings known as battery terminals are attached to the positive plate of one end cell and to the negative plate of the other end cell of a battery to provide electrical connection to the remaining units of the electric circuit. These fittings are numerous in type and manufacture and vary with the size and kind of battery. There are, for example, the cable and bolt terminals; the tray terminals which are commonly of the wing nut or box types; and the taper terminals, made in rights and lefts with different tapers for positive and negative to prevent intercharging.

Separators. Glass rods, or rubber or treated wood strips called separators are inserted between the positive and negative plates of a battery to keep them from coming in contact. Separators in lead-acid type portable batteries may be smooth or corrugated wood, suitably treated; or thin sheets of slotted or perforated hard rubber; or threaded rubber in which cotton threads run transversely to the surface of the separator. Perforated hard rubber separators, if used, are generally accompanied by wood separators. Separators in lead-acid type stationary batteries may be glass or wood rods; wood plates reinforced with dowels; or corrugated wood plates. Separators in Edison cells consist of hard-rubber rods, and strip and plain sheets referred to as pin and side insulators respectively. By using separators the adjacent positive and negative plates may be maintained at a minimum desirable distance apart, thereby reducing the internal cell resistance and the weight and space required for the battery. Untreated wood contains injurious acid which attacks the plates and also has a high resistance which prohibits its use as separators. Proper treatment removes these difficulties.

Sealing. Usually a bituminous pitch or other sealing compound is used to seal the covers to the jars of portable type batteries. Also a threaded ring, known as a sealing nut, is screwed on the terminal post of some lead cells to clamp the cover in place and prevent leakage of electrolyte. (See also Nickel-iron Battery.)

Open Circuit Voltage. The open circuit voltage, called electromotive force, of a cell, battery or generator is measured by a potentiometer or high resistance voltmeter when there is no connection with the load, so that

no current is being delivered. In a battery it depends entirely upon the chemical composition of the cells (particularly the material of the plates), condition of electrolyte, state of charge and temperature, and is in no way dependent on size or number of plates per cell. The electromotive force of a cell drops considerably during discharge and recuperates during charge. (See also Charge; Lead-acid Battery; Nickel-iron Battery.) The potential difference between the terminal posts of a cell during discharge will always be less than the electromotive force by the amount of the resistance drop of voltage in the cell due to current flow.

Internal Resistance. The ohmic resistance within a battery cell is defined as the internal resistance of the cell. It should be small if the battery efficiency and capacity are to be high. Heating of the battery with its consequent energy loss is directly proportional to this resistance and the effective voltage at the battery terminals is reduced by it. For all classes of service demanding high current flow to any extent, the internal resistance should be especially low.

Discharge. Discharge is the conversion of the chemical energy of a battery or cell into electrical energy by the flow of electric current from the battery through an external circuit. The proportion of discharge of lead-acid batteries is best determined by use of a hydrometer syringe which indicates the specific gravity of the electrolyte. For nickel-iron cells the voltage and previous condition of charge are the principal indications of the state of discharge. (See also Charge.)

Charge. Charging is the passing of direct current through a battery, in the direction opposite to that of discharge, in order to restore to the battery the active materials or energy used during discharge. It is essential to watch two things in charging a battery or cell, namely the rate in amperes and the time that charging continues.

When charging a lead-acid battery the acid absorbed by the plates during discharge is driven from the plates by the charging current and restored to the electrolyte. This is the whole object of charging in this type of cell. There is no loss of acid during either charge or discharge. A fully charged cell of the lead-acid type should give two volts and a hydrometer reading of 1.270 to 1.300 (1.200 to 1.230 in tropical climates). A battery having a specific gravity of 1.150 or less, by a hydrometer reading, is considered to be discharged. A specific gravity of 1.160 would indicate about three-quarters discharged condition. A discharged battery has converted so much of its chemical energy into electrical energy that it needs recharging in order to prevent harm to the cell from the excessive giving up of its chemical energy. The electromotive force should not fall below 1.70 volts per cell, but the presence of a higher electromotive force is not a safe measure of condition of charge. (See also Charging Rate.)

When charging nickel-iron batteries there is no change of specific gravity of the electrolyte. The voltage characteristics vary principally with the temperature, condition of electrolyte, time since last charges, and rate of charge or discharge. The normal discharge voltage at rated current is 1.2 volts per cell. The final voltage with the current on should be about 1.8 volts per cell but may be from 1.7 to 1.95. The normal temperature of this type of battery is 90 to 100 deg. F. when charged. Open-circuit voltage gives no indication of state of charge.

DEFINITION SECTION

Charging Equipment, Battery. The devices used in charging storage batteries used on trucks, tractors and locomotives.

Page 717.

Water Still. A device for generating steam and then condensing it into pure water. Stills are commonly used to obtain the water used in storage batteries.

Page 738.

Charging Rate. The proper value of the direct current in amperes to use in recuperating a battery is known as the charging rate. It varies for different sized cells, and for a given cell the amperes used when charging begins, commonly known as the *normal charging rate*, will exceed the value when charging is partially completed.

The lower current value specified is the *finishing rate*. Too high a current rate in charging will overheat a battery, thereby shortening its life. The limiting temperature is usually given as 110 deg. F., and even this is too much for steady maintenance. Continued high temperature distorts and buckles the plates, chars and weakens the wood separators and softens and distorts the case and cover. Once a week a battery of the lead-acid type should receive a prolonged charge at less than the finishing rate until all cells are fully charged. This is known as the *equalizing charge*. It is continued until all cells are gassing evenly and freely or according to the manufacturer's specifications.

Trickle Charge. A charge used on lead batteries when in wet storage to prevent deterioration from disuse is called the trickle charge. It is usually about 1 per cent of the finishing rate.

Freshening Charge. A normal or partial charge given to a battery which has been standing idle, to insure that it is fully charged, is known as a freshening charge. Also the periodic charge of batteries in storage to prevent deterioration from disuse is designated in this manner.

Overcharge. Excessive charging of a battery cell is termed overcharge. It washes out the positive active material and also acts on the positive grids, giving them a scaly appearance.

Starvation. Consistent undercharging of a battery, the discharges being continually greater than the charges, is called starvation. Poor service and shortened life of battery result.

Sulphated. A sulphated battery is one in which an abnormal formation of hardened lead sulphate has been permitted to accumulate, due to starvation or excessive discharge.

Wet Storage. The storage of batteries containing their electrolyte is common practice with vehicle batteries in many locations, particularly where winter climate prevents their use. A trickle charge is applied occasionally to prevent deterioration from disuse and also to prevent freezing, by keeping up the specific gravity of the electrolyte, and thereby lowering its freezing point.

Battery Capacity, Ampere-hour. The number of ampere-hours which can be delivered by a battery at any rate of current flow under normal temperature conditions is the ampere-hour capacity. It diminishes with increased rates of current discharge except on nickel-iron batteries, and it is always less than the ampere-hour input in charging for the same current flow. Higher capacities are recorded when the charge is given at high temperatures, but 110 deg. C. should never be exceeded. The capacity is also affected by the size of plates, purity of electrolyte, age and condition of the battery. New

batteries frequently show increased capacities with successive charges for a limited time. Nickel-iron cells may show as much as 30 per cent above normal rating, improvement increasing for as much as twenty charges and discharges. When a battery is nearly worn out its capacity may be far below rating. In nickel-iron batteries, however, the electrolyte may and should be renewed before the capacity falls to its rated value. If overloads are too frequently imposed on a lead-acid battery, the resulting overheating will cause "buckling," which is distortion of the battery cell plates such as warping and bending. No harm is done to an Edison battery by discharging it at several times normal current or even by complete short circuit.

Efficiency of Battery. The ratio of useful output to total input is efficiency. This may be expressed as ampere-hour, the watt-hour, or the voltage efficiency, but is usually considered to be watt-hour output divided by watt-hour input.

Rating, Storage Battery. The power output and other conditions for operation of a battery as specified by the manufacturer on the rating plate is the battery rating. It is limited by the internal resistance, temperature, mechanical stresses and current output.

It is standard practice with nickel-iron cells to fix the rating in terms of the amperes they will give continuously for five hours. Capacity in ampere-hours is therefore five times the current rate. The normal current rates of charge and of discharge are the same, but the time of normal charge is seven hours.

See also Battery Capacity, Ampere-hour.

Gassing. The bubbling of the electrolyte caused by the rising of gas set free toward the end of charge is known as gassing. Nickel-iron cells give off more gas than lead cells, and more when reversed than when discharging. Excessive gassing or impurities in the solution sometimes cause frothing or bubbling of the electrolyte out through the vent cap. Flooding or overflow of the electrolyte through the filling tube of a battery cell is usually caused by an excessive quantity of electrolyte.

Separator. Non-conducting material, usually hard rubber or wood used to hold the plates of a cell in place are called separators.

The term is also used to designate the part of an Edison gas vent which permits the escape of gas but retains the spray.

Sediment. Sediment is active material of a battery cell which has gradually fallen from the grids and accumulated in the space below the plates. Clearance space is specially provided for this accumulation. When the separators are charged and the battery is overhauled the sediment is usually washed out. Sediment scoops may be used on certain types of batteries for the removal of this material.

Burning. The process of welding lead alloys, called burning, is accomplished by melting the parts to be joined with an electric arc, or with an illuminating or hydrogen gas blow-pipe, and then filling gaps by melting and running in lead antimony alloy from a strip known as a burning strip. In electric arc burning a pointed carbon rod, called an arc burner, is used to conduct the current and melt together the parts to be joined. This is also called *lead burning*.

Local Action. Parasitic currents within the cell itself due to differences of potential between different parts are called local action. A battery should be constructed to have a minimum local action. The surface of the

negative plate will however ordinarily contain small particles of impurities which act on the acidic electrolyte in the same manner as the positive plate. Since these impurities are electrically connected with the electrolyte and the negative plate there are minute local batteries formed about this pole even if the cell is on open circuit, and the active material continually wastes away. Amalgamation of the surface of zinc plates will prevent contact of the surface impurities with the electrolyte and will reduce local action.

Short Circuit. As applied to batteries there are two kinds of short circuit: First, the electrical connection of positive and negative plates within a battery cell. This may be due to the breaking down of a separator permitting the plates to touch, to the accumulation of sediment or the connection of the plates by foreign material admitted through the vent. Second, the direct electrical connection of the positive and negative terminals outside of a battery cell, resulting in the electromotive-force of the battery expending itself on warming up the battery because of the negligible resistance of the external circuit.

Vehicle Battery. A storage battery which furnishes the motive power of vehicles such as electric automobiles, cars, trucks and tractors is called a vehicle battery. In the larger sizes such batteries are known as truck, tractor or locomotive batteries, depending on their use.

The installation of the battery on any vehicle is a matter of prime importance. Accessibility is desirable and, for lead-acid batteries, a great necessity in order that battery inspection will not be neglected. A firm, strong mounting on the frame of automobiles underneath the front seat has become almost standard, although the running board is sometimes used, especially on trucks. The latter position is accessible but subject to more severe vibration and exposure which necessitates enclosure in a strong metal box. On storage battery locomotives the battery is large and therefore requires special frame design for its protection and support. For tractors, a specially installed flexible mounting is preferred, and rubber cushions or springs are desirable.

Battery leads should be sufficiently long so that there is no pull on any cell parts. If extra length is not provided car motion may damage battery terminals.

A vehicle type battery furnishing the motive power for a commercial truck is usually made up of 12 lead-acid cells, or 21 nickel-iron cells, and has a total capacity of about 225 ampere-hours.

This unit is called a *truck battery*.

Page 719, 736, 742.

Generators, Motors and Electrical Details

Generator. An electrical machine for converting mechanical energy into electrical energy is called a generator. The term is sometimes used in a broader sense to include batteries because they generate electricity, but the limited meaning is the more widely accepted. A generator is constructed in two essential parts, namely, the *stator*, or stationary part, and the *rotor*, or revolving part, also called the *armature*. In most direct current generators and in some types of alternating current generators, the stator consists of a frame with two or more magnetic poles, and the carefully balanced rotor consists of coils wound on a laminated iron core having special slots to hold the windings. The motion is produced by a steam or gas engine, motor, turbine or other prime mover, so that there results the physical phenomenon of a coil moving past a magnet in such a way that

the coil periodically cuts the magnetic field between the poles. This produces an alternating current electromotive force in the armature coil. If this coil is connected by *slip rings* and *brushes* to the ends of a conductive circuit, alternating current will flow in the circuit. If the coil is connected to the brushes on the ends of a circuit by a suitable converting device, called a *commutator*, direct current will flow in the circuit. The commutator reverses the connection between the coil and external circuit at the proper moments to keep the polarity the same at the generator terminals.

The electromotive force at any instant depends upon the speed of rotation, the strength of the magnetic field and the number of the loops of each armature coil. To obtain a steady current a large number of coils is placed around the rotor core.

Direct current generators are sometimes so designed that the magnetic poles are attached to the rotor, giving a rotating field, and the armature winding is then placed on the stator. There is also one type of alternating current generator, called an induction generator, which has a revolving electrical field in place of fixed magnetic poles.

Direct current generators are classified according to the method of field excitation. *Series generators* have their field windings in series with the armature coil and will consequently have heavy field currents and give increased voltage with increase of loads. *Shunt generators* have their field windings in parallel with the armature coil, and are subjected to full line voltage. They have a high field resistance consisting of many turns of wire in order to magnetize the poles and the field current must be low to prevent abnormal heating losses in the magnetizing coils. The voltage can be varied through narrow limits by adjustment of the field current with an external rheostat in series with the field.

A combination of the series and shunt generator, known as the *compound generator*, is obtained by the use of both series and shunt fields on one machine. If both series and shunt field currents flow so as to produce the same kind of polarity in each magnetic pole the coils are said to be *cumulatively wound*, and if these currents neutralize each other the generator is said to be *differently wound*. A generator with a cumulative winding will give increased voltages with increase of load. Differential windings may be designed to give rising, falling or a combination of increasing and later of decreasing voltage with increase of load. A compound generator is designated as *long shunt* or *short shunt* according as the shunt field is connected across both armature winding and series field winding or just across the armature winding respectively. A generator may receive its excitation also from another machine or from a storage battery, in which case it is called a *separately excited generator*.

A direct current generator can be operated as a motor to convert electrical power into mechanical power, but there are minor differences of design which make it commercially undesirable to operate a machine interchangeably as generator and motor, as a common practice. In dynamic braking, which see, the electric motor is made to run at times as a generator in order to control machine speeds.

Generators are so manipulated in some types of material handling machinery as to regulate motor speeds, using the so-called Ward Leonard system (see Speed Control of Motors). The generator as a source of electricity is an important unit of a central station and is

DEFINITION SECTION

operated ordinarily at a distance from and independent of the material handling installation except for inter-connection by the transmission system. For this reason the generator is only occasionally a part of the equipment to be chosen in making an installation. Its presence in a power house, however, will often determine the voltage and class of motors, whether alternating or direct current, for a whole neighborhood.

Page 706, 756.

Transformer. A transformer is a stationary alternating current machine for changing electric energy of one voltage to electric energy of another voltage, through the medium of magnetic energy, without mechanical motion. The transformer consists of two separate and distinct coils of wire wound on an iron core. If alternating current is supplied to one coil, an alternating current will result by *electro-magnetic induction* in the other coil. The voltages of the two coils vary in the same ratio as the number of turns of the coils, thus making it possible to design a machine which will either raise or lower an alternating current voltage by any specified amount. A transformer may also be designed with suitable *taps* in either the high or low voltage windings for the purpose of obtaining a variety of voltage ratios of transformation from one machine, but this sometimes adds considerably to the cost of the machine.

The coil of the transformer which has the lesser number of turns is called the low-voltage winding because it has a lesser potential across its terminals than the other coil. Similarly the coil with the larger number of turns and the higher voltage is known as the high-voltage winding. The high voltage may not exceed the low voltage by any appreciable amount but is more commonly several or many times the low voltage.

A transformer sometimes has part of its turns common to both high voltage and low voltage windings, and is then called an auto-transformer. There is only one winding for both high voltage and low voltage. A terminal is tapped off from the coil at such a point that the potential between this terminal and one of the high voltage terminals will give the low voltage desired. This type of transformer is often used where the ratio of transformation is small because it gives a considerable saving in copper. Certain applications of the auto-transformer are common in speed controlling apparatus of alternating current machines.

That winding of a transformer which receives the energy flow from the supply circuit may be called the primary. The other winding which receives its energy flow from the primary by induction may be called the secondary. The terms primary and secondary are frequently ambiguously interchanged in usage and might better be replaced in many instances by the terms high voltage and low voltage. The primary and secondary windings of a transformer exert a considerable mechanical stress on each other so that a reinforcing and clamping structure must be carefully designed and constructed. Insulation against voltage breakdown between coils and suitable oil circulation around the windings to receive heat radiation are also vital. Cooling may be provided by the use of radiators, corrugations on the containing tanks and cold water cooling coils.

Both indoor and outdoor transformers are made, and portable machines may be mounted on specially constructed trucks.

Transformer efficiencies range from 97 to 99 per cent when operated under the full load conditions specified on the rating plate. Almost no attention is required

other than occasional thermometer readings when overload seems imminent, or water supply regulation where cooling coils are used.

The design of each transformer is a specific problem in itself depending on capacity, voltage ratio, space facilities, permissible heating, type of machine desired, frequency and line operating phase. Therefore the transformer must usually be specially designed to meet the service desired.

Page 706, 756.

Magneto. A magneto is a special form of alternating current generator which is used in such low power work as internal combustion engine ignition and ringing bells for vehicle warnings, for signals and for telephones. There are both low tension and high tension magnetos, the former developing from 15 to 100 volts, the latter 15,000 to 20,000 volts. Ordinarily the low tension magneto consists of a permanent magnet with a revolving armature coil which generates an alternating current. When used for ignition purposes the armature coil is in series with the primary electric circuit of a transformer coil.

The magneto or some other unit must contain a circuit interrupting device or timer to break the primary circuit at desired intervals. When this interruption of the primary circuit takes place the secondary coil of the transformer will have a high electromotive-force induced in it by the rapid drop of magnetic flux in the primary. The high voltage of the secondary is conducted to the spark plug and thereby ignites the mixture. On the high tension magneto there is a permanent magnet field and the armature carries two coils, one of the primary or low tension, and the other the secondary or high tension. The armature is therefore a rapidly rotating transformer and the secondary receives impulses of high electromotive force by transformer action from the primary and also by its own generator action.

High tension magnetos have a circuit interrupter, a safety spark-gap and a distributor if more than one spark plug is in use. Low tension magnetos are sometimes used in conjunction with magnetic coil spark plugs which are actuated by the low tension current of the magneto to produce a spark. Another special type of low tension magneto is that used on Ford cars, consisting of 16 rotating magnets revolving past 16 fixed series connected coils. This magneto produces low tension alternating current that must be changed into high tension for use at the spark plugs by a form of transformer coil.

The magneto for bell ringing circuits is a low tension alternating current dynamo ordinarily propelled manually, the voltage generated producing a current in the signal line and ringing a bell connected at the other end and at intermediate stations as desired. It is particularly adapted to signal work with many material handling equipments where batteries would be exposed to damage or would be a source of inconvenience due to necessity of frequent inspections and renewals.

Booster. A separately excited low-voltage generator inserted in series in a circuit to regulate its voltage. If the generator is driven by an electric motor the set is called a motor-booster. This unit is frequently used to produce normal voltage where heavy loads or long transmission lines cause excessive drops of potential.

Motors

Motor. A machine which converts electrical energy into mechanical energy is called a motor. The two essential

MATERIAL HANDLING CYCLOPEDIA

parts are the stator or stationary part of the machine, and the rotor or revolving armature. A direct current motor, like a direct current generator, is usually constructed with field poles on the stator and a series of coils on the armature. The motion of rotation is due to the well-known law of nature that a magnetic pole will repel or attract an electric conductor such as a rotor coil, in which a current is flowing. A commutator and brushes are required on direct current motors as on direct current generators, but the object in this case is to carry current to the rotor instead of away from it. All alternating current motors except induction motors must be equipped with slip rings to convey the line current to the armature.

Motors should always be started by some form of controller or starting box which will prevent the impression of full line voltage and consequent excessive armature currents.

Motors may be classified according to current used, type, speed, or mechanical features.

The following types may be distinguished:

<i>Direct Current</i>	<i>Alternating Current</i>
Series	Single phase or polyphase
Shunt	Synchronous
Compound	Induction
Cumulative	Rotor wound
Differential	Squirrel-cage
Long shunt	Repulsion-induction
Short shunt	Synchronous-induction
	Commutator
	Series, shunt or compound.

These types are further described in the following pages.

With regard to speed, motors may be classified as:

(1) *Constant Speed.* This class covers motors where the speed variation, if any, is slight. Synchronous motors, induction motors with small slip, and ordinary direct-current shunt motors are constant speed.

(2) *Variable Speed.* Motors of this class change their speed with variations of load, an increase of load ordinarily causing a drop in speed. Series-compound and series-shunt motors are of this group. Decreasing the field excitation of a direct current motor will cause an increase of speed.

(3) *Multi-speed, Two-speed, Three-speed, etc.* Motors of this class give constant speed for any one connection, but may be readily reconnected to give one or more other speeds. This speed control may be obtained by the use of two or more armature windings, or of induction motors in which the number of poles is changed by external reconections.

(4) *Adjustable Speed.* These motors may be adjusted to a variety of speeds, but when once fixed at one of these the speed remains constant, regardless of load changes. Shunt motors may be designed to give adjustable speeds.

Rotating machines, both motors and generators, have a variety of mechanical features which are designated by the following terms, and will be described in detail later.

Open	Mechanically-protected
Semi-enclosed	Moisture-proof
Enclosed (totally)	Splash-proof and water-
Self-ventilated enclosed	proof
Externally-ventilated en-	Acid-proof
closed	Submergible
Water-cooled	Explosion-proof

No ordinary insulation can withstand strong acid or alkaline fumes. Motors may be designed for horizontal or for vertical shaft operation or for wall or ceiling suspension.

The motors for electric elevator service must be specially built to withstand impact stresses and to give suitable operation under the conditions imposed. For crane, hoist and similar service the motor is started from rest under load, and must give powerful starting torque. Mill motors also have special features and are more sturdily constructed than ordinary types.

Motors are rated according to the kind of service for which they are to be used, there being three common classes as follows:— continuous service, periodic service and varying load service. The heavy loads of the latter two classes of service are covered by the short time rating. (See Rating.) Heavy loads affect principally the heating and must be maintained for such short intervals that the machine has time to cool off between the peaks. The important factors considered in rating motors are heating, commutation, mechanical strength, speed regulation, efficiency, frequency, voltage and current.

The selection of a motor for a particular service may require a study of its rating features and of its torque, current, efficiency, speed regulation, voltage regulation, power factor, and phase characteristics. Starting, running and maximum values of current and torque may be important. The above factors are given on the characteristic curves of the machine. Characteristic curves of speed, torque and efficiency especially furnish a valuable means of predicting the suitability of a motor for any particular class of operation. (See Motor, Series; Motor, Shunt; etc.)

It is not true that a motor having a long-hour rating is less liable to break down from overheating than a motor having a much lower time rating. For example, a moderate or low speed motor having a short time rating is more suitable for the lifting mechanism of a crane than a higher speed, longer time rating motor. Direct current series motors are liable to have excessive speeds at small loads, a difficulty which must be avoided in choosing motors. This high speed characteristic of the series motor may be of special advantage, however, for certain classes of low load hoisting mechanisms. High speed motors may best be employed where the no-load output is but little less than full-load, as in the case of travelling and traversing motions of a crane. However, there are many instances where it is preferable to use low speed motors because they have more starting torque, quickly acquire full speed, permit of rapid braking, and can be used without an excessive amount of gearing with rope drums of large diameter and thus make less noise, and because they are more durable.

(For methods of regulating the speed of motors see Speed Control.)

The horse power of the motor required to raise the work of hoisting and also of accelerating. The horse power for hoisting at full speed is:—

$$HP = \frac{W V}{33000 e} \quad \text{where}$$

W = weight of load on hook in pounds.

V = speed of hook in feet per minute.

e = factor to allow for friction losses in the crane,

DEFINITION SECTION

ranging from 0.25 for slow speeds of 10 feet per minute to 0.70 for high speed cranes using efficient gears.

To this must be added the horse power for accelerating which is best obtained by using the armature weight, W , and radius of gyration, r , of the armature as furnished by the manufacturers, to give the following:—

$$HP = \frac{W r^2 N^2}{1,613,000 t}$$

N = revolutions per minute of motor,
 t = seconds used to accelerate.

Excessive temperature in a motor may be due to excessive current through its armature or field winding, or to insufficient ventilation and cooling, or to both. In hoisting motors overheating shows that an improper selection of motor has been made for the work to be done. Motors for such intermittent service should not be selected on the basis of horse power but by the root-mean-square method. When dynamic braking is used instead of mechanical braking, the heating requirements make it generally advisable to use a motor 33 1/3 per cent greater in heating capacity. With high lowering speeds in excess of 150 or 200 per cent of full load hoisting speed, interpoles or special motors are required to avoid overheating and poor commutation. (See Interpole.) Special slow speed motors of the interpole type may be used with success when geared to drive fast machinery. With suitable care in motor design, the lowering speed with dynamic braking may be as great as with mechanical lowering brakes, but it may be somewhat more expensive.

Page 706, 717, 756-758.

Motor, Series. A direct current motor provided with a single field winding that is designed to be in series with the armature coil, and therefore to carry the whole of the current supplied to the machine, is called a series motor. The field winding consists of a few turns of heavy wire on each pole, and the windings of all poles are connected in series. The excitation is proportional to the current in the armature and the decrease of field excitation which accompanies a decrease of load causes an increase of speed. If the load becomes very small the excitation will be so far reduced as to cause excessive speed, and therefore the series motor must always be rigidly connected to its load to avoid dangerous speeds.

This is the usual type of motor whenever direct current electricity is used for service necessitating frequent starting, such as hoist, crane and locomotive propulsion. Its particular adaptability results from the high torque which the service motor provides at low speeds and starting, and from its high efficiency throughout a wide range of speeds. Simplicity and ease of connecting for dynamic braking are also in its favor. It is possible to insert a rheostat in series with the circuit and thus increase the motor speed, and where the work is to be performed only intermittently, as in hoisting, the heating loss in this resistance will ordinarily be permissible from an economic standpoint. However, during starting, some form of rheostat must be used to limit the flow of current until the machine is brought up to speed.

The torque of a series motor increases with the square of the current at low loads, then grades down to a nearly proportional change of torque with current at high overloads when the field cores become saturated with magnetism. Speed varies inversely with the load, so

that heavy loads may be handled at low speed and light loads at high speed.

Interpoles are widely used with series motors to improve commutation and to give a wider range of speed control without undue sparking. (See Interpole.)

When two series motors are used to propel a machine such as an industrial truck they may be advantageously connected in series for starting. The total resistances of the rheostat and of both motors in series act to prevent the excess flow of current until the motors are partly up to speed. The rheostat is gradually cut out as the motors accelerate. Then the rheostat is again thrown in and the motors are connected in parallel. Each motor receives full line voltage after the rheostat resistance is completely removed, or the two motors may be jointly regulated in speed by this resistance.

Page 712, 756.

Motor, Shunt. A direct current motor provided only with a field winding connected directly across the armature terminals is called a shunt motor. This winding is in parallel or shunt with the armature coils so that only a small portion of the current supplied to the motor is used for excitation. The shunt consists of a large number of turns of fine wire on each pole, and usually all of the pole windings are connected in series to form one shunt circuit. Field excitation is proportional to the line voltage, decreases with increase of resistance in the shunt circuit, and is independent of the armature current. Since by increasing the resistance in the field winding a slight decrease of excitation results, motor speed will be somewhat increased, but the shunt motor has fairly constant speed for all loads. A field rheostat is the usual method of speed regulation of the shunt motor but it has the disadvantages of causing sparking at high speeds and of giving only a small range of speed adjustment. A second method of speed control uses a motor with field poles specially constructed to be moved on a radial axis away from the armature by a mechanical system of gears. The air gap between armature and field pole is thus increased and an increase of armature speed results. This is an admirable method of speed control but complicated and expensive. A third system, the *commutating pole* or *interpole* arrangement is very successful. Small poles with series field excitation are placed between the regular poles to neutralize the excessive magnetic disturbances which take place when the field is very weak, and as a result a wider range of speed control is secured with sparkless commutation by the shunt field rheostat adjustment. (See also Interpole.)

The torque of a shunt motor increases about proportionally with the armature current at all loads. It is maximum at starting and decreases as the speed increases. A large current is required to produce a given starting torque. Both the compound and series motors are more adaptable to material handling service than the shunt motor, primarily because of the latter's fixed speed characteristic at all loads, and its small speed adjustability with a given load.

Page 712, 756.

Motor, Compound. The compound motor has both a series and a shunt winding on each pole. It is a combination of a series and shunt motor and may be designed to give the good starting ability of the series motor and at the same time avoid the excessive no load speeds of the latter. A *cumulative* compound motor has its shunt and series field windings so connected as to aid each other in producing magnetism and therefore has the advant-

ages of both series and shunt motors. A *differential* motor has its shunt and series field windings opposed to each other in polarity, and therefore has poor starting qualities, which make its application very limited. Long shunt and short shunt connections may be used on motors the same as on generators. Either will give satisfactory operation when cumulatively wound. The speed may be controlled as in shunt or series motors.

Where compound motors are employed for hoisting it is considered the best practice to have the shunt field continuously excited, even though the heating loss due to this continuous excitation is appreciable.

Page 712, 756.

Commutator. A commutator must be used on all direct current generators for converting the alternating current in the armature coils into direct current which flows in the outside circuit. The reverse process of converting the direct current supply into alternating current in the armature applies for the direct current motor. A commutator consists of a number of copper segments mounted radially and fastened to the armature, of which the commutator is a part. Connections are made from the ends of each armature coil to two of these segments spaced at such a distance apart that two conducting *brushes* may be so placed on the machine frame as to convey the electric flow between this coil and the outside circuit. There must be two segments for each armature coil and as soon as one pair of segments is about to leave the brushes the next pair slides into contact so that a uni-directional electromotive force is continually being supplied to the brushes when running as a generator and a direct current force is successively impressed on each passing coil if running as a motor.

Brush. The brushes are the part of an electric generator or motor which connect the stationary line leads with the rotating commutator or slip rings, in order to conduct the line current from or to the rotor as the case may be. They are made principally of carbon or graphite or a combination of these two materials in the present day types.

The electro-graphitic brush, made by baking amorphous carbon at high temperature until the material is converted into graphite, has reached a high stage of development. It may be made in varying degrees of non-abrasiveness, hardness and conductivity, and at the same time secure a high contact drop of voltage between brush and commutator and a low coefficient of friction. Abrasive brushes wear grooves in the commutator and are usually unsatisfactory. When comparatively non-abrasive brushes are used, it is ordinarily desirable to undercut the commutator by filing the mica insulation between the bars from 1/32 in. to 1/4 in. below the brush contact surface, thereby gaining the good polishing action of the hard brush against the commutator. Commutators not undercut will permit friction and rubbing of the brushes against the mica and a poorer polishing action results. Selection of a proper degree of hardness improves the polish and quietness of operation and prevents wear and filling of the undercut crevices with conductive material. Brushes not properly designed with high contact resistance between brush and commutator will spark excessively.

Graphite-carbon brushes with a large percentage of graphite and the electro-graphitic type seem to meet direct current and synchronous motor practice requirements with increasing popularity. Such brushes usually contain sufficient graphite for lubrication so that

special lubrication treatment is seldom required. For induction motors of the slip ring type *metal-graphite* brushes still are favored by many because in this type of machine high contact resistance is unnecessary and in fact may have the detrimental effect of causing high slip. (See Motor, Induction.) However, a better practice is to use the electro-graphitic or graphite-carbon brushes on collector ring service in sufficient number and of sufficient size to reduce the current density in the brushes below that used for other types of motor. Seventy-five to 80 amperes per square inch for collector ring service induction motors, and 100 to 110 amperes per square inch on other motors is good practice.

Copper and wire gauze brushes can not be considered as satisfactory as electro-graphitic and graphite-carbon brushes except in a very limited number of special machines.

Interpole. Small series wound poles may be placed between the main poles of a motor or generator to aid commutation and secure better speed regulation. The use of interpoles on direct current machines is becoming almost universal, and is common on alternating current synchronous motors. There may be as many interpoles as there are main poles on the motor, or there may be one interpole for each pair of main poles. In the latter case the small series wound poles appear between the alternate main poles. Interpoles are also known as *commutating* and *compensating poles*, and motors so equipped are sometimes referred to as *interpole* motors. Where motors are to operate over a large range of speeds with field control, or are to be subjected to heavy overloads, the commutating pole will be necessary.

The action of an interpole is to set up in each coil, at the instant it becomes short circuited by a brush, an electromotive force in opposition to its current so that the coil will not cause a spark at the point of short circuit. A similar but less satisfactory action was formerly obtained by shifting the brushes *forward* from the neutral position in the direction of armature rotation. This is not satisfactory except for a given load, because a change of load requires a new brush adjustment to produce the necessary change of commutating flux. As the interpole field is excited by a series winding it has a field strength proportional to the motor load and automatically provides the proper change of commutating flux with change of load.

When the interpole motor brushes are shifted from the neutral position the speed characteristics of the motor are altered. A forward shifting of the brushes increases the flux cut by the armature conductors at the instant of short circuit of a given coil by a brush, and thus reduces the speed. Therefore a forward shifting of the brushes tends to give the motor a drooping speed characteristic with increase of load. Conversely a backward shifting of the brushes tends to give a motor a rising speed characteristic with increase of load.

The effect of the interpole on the motor at very heavy loads may be such that armature reaction reduces the main field strength so as to produce overspeeding until the motor runs itself to destruction. By the removal of interpole shims to increase the airgap this may be corrected.

Interpoles have made for higher efficiency and smaller quantity of materials for the same output as well as for improved commutation and speed regulation.

On a series motor without interpoles, commutation will be poor for speeds exceeding 200 per cent of full load

speed, whereas with interpoles practically any desired speed may be attained without serious sparking.

Suitably designed shunt motors with interpoles may give sparkless commutation at speeds varying 600 per cent from slowest to fastest.

Motors, Direct Current, Care of. Direct current motors must be especially cared for due to the tendency of materials to collect on the commutator segments. The interior may be cleaned by blowing out or wiping the commutator with a slightly oiled rag. Too much oil will damage the insulation between segments. A rough commutator may be smoothed by holding sandpaper against the revolving commutator with a wooden block. Emery is conductive and must never be used. A commutator of polished dark brown is ideal and a slow rotation of brushes will produce a sharp squeak under this condition. Brushes which makes proper contact with the commutator will be glazed over the entire surface. (See also Commutator; Brush.)

Motor, Induction. The induction motor is an alternating current motor having an alternating current field, with rotating magnetism, wound on the stator and a group of short circuited metal bars or a closed winding on the rotor. It is essentially a transformer in which the core and secondary winding are free to move, and the force which the windings exert on each other is allowed to produce mechanical rotation. The stationary winding which receives energy by direct connection from the supply circuit is called the *primary*. The rotor winding receives its energy by induction from the primary and is called the *secondary*. The alternating current field on the stator is wound like the armature of a direct current machine and therefore has a rotating magnetism instead of fixed magnetic poles. This rotating magnetism induces currents in the short circuited rotor windings, and the stator magnetism exerts forces on these induced currents and causes the rotor to revolve.

An induction motor has a certain *synchronous speed* which is the theoretical speed corresponding to the speed of the rotating field, and that at which the machine would have to run as a generator to produce the line frequency. It is equal to $\frac{120 f}{p}$ revolutions per minute,

where f is the supply current frequency in cycles per second and p is the number of poles on the machine. In order that the motor may develop a torque it is necessary for the rotating field to cut the conductors on the rotor. When an induction motor rotor is run at this synchronous speed, no magnetic flux from the stator cuts the rotor conductors, and therefore no torque is exerted. This happens approximately at no load. When a load is applied to the motor, the speed falls below synchronism and current is induced in the rotor conductors, producing sufficient torque to carry the load. The amount by which a rotor has fallen below synchronous speed at any time is known as the *slip* of the machine at the given instant. It is the difference between the speed of the rotating field of the motor and the rotative speed of the armature. Slip is proportional to the rotor resistance, and at a given load varies inversely as the square of the applied voltage. Slip is ordinarily expressed as a percentage or ratio, equal to the synchronous speed minus the actual speed divided by synchronous speed.

Two different methods commonly used in constructing the rotor have such a marked effect on the performance that induction motors are classed in accordance with

them, and are termed the *squirrel cage* rotor and the *wound* rotor. The squirrel cage rotor has the winding replaced by heavy copper or aluminum bars short circuited on each other, without external armature connections. The wound rotor has a regular distributed winding which varies somewhat in construction depending on whether the motor is to be operated single-phase, two-phase or three-phase. In any case the wound rotor is connected by slip rings to an external variable resistance which is used in starting and sometimes for speed control. This type is often called the *phase wound* or *slip ring* induction motor. Two-phase and three-phase machines are often called *polyphase*.

The induction motor is essentially a constant speed machine especially when phase wound. Its no-load speed is limited and does not become excessive and its torque-speed characteristic curve is flat. When polyphase supply is used the starting and running torque are high for both squirrel cage and wound rotor types, the latter however giving much the higher starting torque for a given current input. Ability to carry heavy overload, high efficiency and extreme simplicity of construction also help to make the induction motor popular.

Operation above normal frequency produces increased power and efficiency and a reduction of torque, while operation above normal voltage produces reduced power and efficiency and an increase of torque at normal loads.

With alternating currents as a source of power, the polyphase induction motor having a wound rotor with collector rings is most suitable for hoist, crane or elevator service. The characteristic curves furnish the best means of determining the performance possibilities of the motor.

The speed torque characteristics of wound rotor polyphase induction motors show the curves corresponding to different positions for the controller. The synchronous speed line is horizontal and indicates the theoretical speed of the motor when running without any load. At no-load the speed is nearly synchronous speed regardless of the notch position of the controller, but the speed decreases much faster with increase of load on the first notches, and on the last notch speed decreases are small with increase of load. The motor can not start under full load with the controller set at the first notch. The maximum starting torque will usually occur with the controller about three-quarters displaced from the first toward the last notch.

The addition of resistance in the rotor circuit of an induction motor will increase the slip and therefore decrease the speed of rotation because: (a) less current can flow in the rotor windings and therefore at the same slip fewer lines of armature flux are cut by the rotating field magnetism, resulting in less driving force on the armature; (b) to restore this driving force and thereby furnish sufficient torque to carry the load, more lines of armature flux must be cut by the rotating field magnetism, or the relative speeds of the flux and the field must increase; and (c) since the speed of the latter is fixed by the line frequency, the armature flux must slow down, or a decrease of speed will result. Therefore the greater the rotor resistance, the greater the decrease of its speed below synchronism. The current per phase at full load voltage will appear on characteristic curves for given values of torque, it being independent of the controller notch position. The current drawn from the supply at maximum starting torque is about three times that at full load torque.

The maximum torque is about two and one-half times full load torque, this being a desirable characteristic of all induction motors which protects them from injury due to excessive loads. On the other hand, the series motor which is generally used with direct current supply systems for cranes and hoists has a torque curve which rises indefinitely with increase of current, so that the series motor will be injured by excessive loads unless protected by fuses and circuit breakers. A comparison of induction with series direct current motors for hoisting work will show the alternating current system to be less adaptable to dynamic braking and rapid acceleration.

The desirability of varying speeds for induction motors caused much study and investigation and many methods have resulted, among which the following are most satisfactory: 1. Rheostat control. 2. Multi-speed windings. 3. Concatenated control. 4. Kraemer system. 5. Scherbius system. 6. Heyland system. (See Speed Control.)

Power factor regulation has caused much trouble in this type of machine because central station operation is hampered by the low power factor inherent with induction motors. However this is no detriment from the alternating current customer's standpoint and is being less stressed than in the early days when power stations were small. As a central station problem, low power factor machines can now be counteracted without great difficulty.

Poly-phase and single-phase induction motors are both extensively used and each is made in both the squirrel cage and the slip ring types. The poly-phase motors are simple in construction and reliable in operation, can be ruggedly built for use in most trying conditions and in exposed locations, have the ability to start under load, and will carry heavy overloads. Single-phase induction motors are much less satisfactory in that they have a zero no-load torque and must be brought partly up to speed by some special device. They are frequently started by poly-phase supply connection and then switched on to single-phase mains. This difficulty has led to the introduction of several modifications of the single-phase motor. (See also Motor, Repulsion.)

Single-phase induction motors differ from the poly-phase in that they have but one stator winding. Their speed-torque characteristic curve starts with zero torque at no load and reaches a moderately high maximum torque value. If a poly-phase induction motor is once in operation, it will continue to run and carry a moderate load when all but one of the stator windings are disconnected from the supply circuit. In such a case the machine is operating as a single-phase induction motor. When single-phase supply must be used some modified form of induction motor such as a repulsion induction motor will ordinarily be most suitable.

Page 712, 755, 756.

Motor, Repulsion. The repulsion motor is a single-phase alternating current motor in which the stator has an alternating current field, with rotating magnetism, and the rotor is like the armature of a direct current machine with the commutator included. Such a machine has the advantages of a moderately large starting torque and of easy convertibility into an induction motor by the use of a short-circuiting ring automatically to connect the ends of all armature conductors thereby forming a squirrel cage rotor as soon as the machine has been started sufficiently to develop torque as an induction motor. Repulsion motors are heavier, less effi-

cient and more expensive than direct current motors of the same output, and they present greater commutation difficulties. Owing to the zero starting torque of the single-phase induction motor there is a large use of induction motors which start as repulsion motors, on single-phase supply mains. They are called *repulsion-induction motors*.

Page 712, 755, 756.

Motor, Synchronous. A synchronous motor is an alternating current motor in which the stator consists of fixed magnetic poles like those of a direct current machine and the armature windings are connected to slip rings instead of commutator segments. The synchronous motor operates at a fixed speed, is difficult to start and lacks flexibility in operation so that its use in material handling equipment is rare. It is occasionally employed to drive the generator of a motor-generator set where the Ward Leonard system of speed control is used. (See Speed Control of Motors.)

Page 712, 755, 756.

Motor-Generator Set. A motor-generator set consists of a direct current generator and a motor which drives it. The motor may be alternating or direct current depending on the nature of the supply circuit from which it receives its energy. When the supply is alternating current the set furnishes a means of converting alternating into direct current. When the supply is direct current the set may be used to change the voltage by varying the field strength of the generator.

Page 706, 756.

Rotary Converter. The rotary converter is a synchronous alternating current motor and a direct current generator combined in a machine with one stator and one rotor. The rotor contains one armature winding connected to both alternating current slip rings and a direct current commutator, and the stator has a single set of magnetic poles which acts as the field for both the motor and generator. This machine is generally used to convert alternating into direct current, but may also act as a direct current motor and alternating current generator, or, if driven by a prime mover, it may act as a direct and alternating current generator. Rotary converters are also called synchronous converters.

Page 706, 756.

Speed Control of Motors. The term *speed control* is used to designate the variation which may be obtained in the speed of an electric motor as indicated by the maximum and minimum desirable operating speeds or by the speed versus torque curve of the machine, and also to specify the means by which this speed change may be obtained.

The speed of series motors may be varied over a wide range. Shunt motors permit of small speed change only. Compound motors may be designed to give considerable variation of speed. Alternating current motors are all essentially constant speed machines, but induction motors can be designed to give some speed variation.

Four methods of regulating the speed of direct current motors are employed, namely: (1) Vary the resistance in series with the armature. (2) Vary the line voltage which supplies the motor. (3) Vary the strength of the magnetic field. (4) Vary the number of turns in series on the armature.

The first of these, known as series rheostatic control, is usual for motors of small and medium size in which case the running speed depends on the load as well as on the resistance in series with the armature. A direct

DEFINITION SECTION

current motor geared directly to a hoist may be effectively controlled by an armature series rheostat. This resistance can be cut in or out of the circuit either by a manually operated drum controller or by magnetic contractors. This method of speed regulation dissipates energy in direct proportion to the voltage drop in the series resistance. If the speed is to be decreased 50 per cent, the voltage must be cut down 50 per cent and half of the energy supply is wasted. In spite of these losses, the armature rheostat method is generally used for direct current crane and hoist motors because the load current is small during a considerable portion of the time and therefore the power lost is intermittent and not excessive in total. Dynamic braking may be used with this control system.

Voltage control may be accomplished in several ways, but when applied to hoisting motors the *Ward Leonard* system is the usual method of changing speed by voltage regulation. This is ordinarily the most suitable control where the service is such that the starting and stopping periods represent a large portion of the running time and where the motors to be controlled are of considerable size. It is unrivalled where sensitive control over a wide range of speeds is desired. For Ward Leonard control a motor generator set is required in addition to the driving motor. The motor of the set takes energy from the supply mains and rotates the direct connected generator at an approximately constant speed. The generator supplies the driving motor with electricity, and variation of the field excitation of the generator regulates the voltage on the hoist motor thereby controlling the hoisting speed. The latter will vary in about the same ratio as the generator voltage.

When the central station conditions are such that operating circuit disturbances will be created by the application of the peak loads of the hoist, this system can be conveniently altered by the use of a flywheel directly connected to the shaft of the motor-generator set, thereby equalizing the demand on the power circuit. This system is applicable where the supply is either direct or alternating current. With the former a shunt or compound motor with constant speed characteristic may be employed to drive the generator. If alternating current is used, this motor may be of the synchronous or induction motor types.

It is frequently desirable to use a wound rotor, slip ring induction motor to drive the flywheel and generator, to secure the additional advantage of automatic speed variation through the use of a secondary rheostatic control in the rotor of the induction motor and prevent the frequent application of peak loads of short duration on the power line. When the flywheel is used the system is known as the *Ilgner* modification of Ward Leonard control. It has been widely applied in mine hoists and rolling mills where the driving motor must frequently start and accelerate under heavy loads. When the driving motor starts it draws a heavy current from the generator, causing a drop of speed of the motor-generator set and a withdrawal of stored energy from the flywheel. Energy to supply peak demands, therefore, comes from the flywheel sufficiently to prevent sudden load surges on the central station, and when the peak load period has passed the line motor accelerates to normal speed and stores more energy in the flywheel. A Ward Leonard installation, with or without the *Ilgner* application of the flywheel, is an expensive method of control because of the added cost of the motor-generator set. This may be partly offset by the

saving in energy due to the absence of series resistance.

Field control is usually employed when it is desirable to obtain speeds higher than normal, but sometimes the field strength is increased to reduce the speed below normal. This method cannot be used to obtain a wide range of speed control but with interpoles on the motor, moderate speed regulation can be secured.

To secure speed control by varying the number of series armature turns, two series motors are required. The armatures of both machines are connected in series with a rheostat at starting, so that considerably less than half of the line voltage will be impressed across each machine and speed acceleration may be regulated by the rheostat until the motors are running in series directly across the line. The rheostat is then reconnected while the motors are connected in parallel, but is cut out in steps again regulating the speed until each motor receives full supply voltage. (See Motor, Series.) This method is used to a limited extent for cranes and hoists and extensively in electric railway service. Twice the torque of a single motor is obtained during starting for a given current, and there is much greater economy than if each motor had a separate and larger starting resistance which would be required if the two armatures did not act as starting rheostats for each other.

There are many methods of changing the speed of an induction motor. The speed of rotation of the stator magnetism of an induction motor is determined by the frequency of the alternating current supply and by the arrangement of the stator windings. The latter fixes the number of rotating magnetic field poles on the stator,

$$120 \times \text{frequency}$$

so that $R. P. M. = \frac{\text{number of poles}}{\text{frequency}}$. Synchronous

no-load speed can only be altered by a change in one of these quantities, but the rotor speed under load can be modified by causing the motor to have additional slip. Any method of changing speed accomplishes a variation of some one of the three factors, frequency, field poles or slip.

The following seven ways of controlling the speed of an induction motor are especially noteworthy:

1. Varying the resistance of the rotor circuits.
2. Varying the voltage of the electrical supply.
3. Changing the number of poles.
4. Concatenation or cascade connection of two motors.
5. Altering the frequency of the electrical supply.
6. Kraemer method.
7. Scherbius method.

The first method is the one generally adopted. The second is rather unsatisfactory. The third and fourth are limited to about four or possibly six speeds, and the fifth requires a separate generator for each motor, for which reason it is rarely used. The last two methods are efficient and satisfactory.

Starting of Motors. The armature winding of a direct current generator is built of copper wire of sufficiently large cross-section to give the armature a low resistance. If full supply voltage were impressed across the terminals of a direct current motor with the armature stationary, a destructive current would immediately flow in the armature winding. This is ordinarily avoided by the temporary connection of a *starting resistance, or rheostat*, in series with the armature so that only a portion of the line voltage really is impressed across the rotor terminals. As the motor begins to speed up, the armature, rotating in the magnetic field produced by the stator poles, sets up by generator action an electromotive force which

opposes in polarity the voltage impressed by the supply. This generated voltage is often called the *counter electromotive force* of the motor. Deducting this from the potential difference across the rotor terminals, the remaining voltage is that which forces current through the resistance of the armature, and for this reason is called the *resistance drop*, meaning the drop of potential due to flow of current through the rotor resistance. The counter E.M.F. increases quickly as the motor speeds up and soon becomes only a few volts below the potential difference across the motor brushes, so that the rheostat resistance may be partially thrown out in order to permit a greater voltage across the brushes, and a further building up of speed and counter E.M.F. This process is repeated until the rheostat is entirely removed from the circuit, at which time the motor accelerates to normal speed.

It is evident that there are two sources of electromotive force in a motor that is running, namely, the impressed voltage at the brushes and the voltage set up by the windings as they move past the magnetic poles. These two electromotive forces are opposite in direction and the current that flows is proportional to their difference. If the speed should suddenly drop considerably this difference would become large and the current would increase to destructive proportions and the same conditions would obtain as if the motor were to start from rest under full line voltage.

This is exactly what would happen if the line voltage temporarily fell off, due to transmission or power house trouble, but suddenly was restored to normal. In order to prevent such disturbances from damaging the motor a *no-voltage release* is attached to the starting rheostat in such a manner that the circuit will be automatically broken in case of voltage failure. The no-voltage release is an electromagnetic device having its winding preferably in series with the field of the motor, so that a drop in field current reduces the strength of the electromagnet and releases the rheostat handle, which is held to the zero resistance position only by the magnetism of this solenoid. Some such mechanism is an essential part of all direct current starting systems.

When starting shunt motors the no-voltage release is a small coil of low current carrying capacity placed in the shunt field circuit. With series motors the coil must be designed to carry the large armature and series field current. No series motor should ever be started until it has been rigidly attached to its load, because the small current drawn from the supply at no-load makes the resistance drop very small, and the speed accelerates in an attempt to build up the counter electromotive force equal to the supply voltage until the motor races to destruction.

The connections for compound motor starting resistance and no-voltage release are similar in principle to those of the shunt motor.

The torque of a shunt motor varies as the armature current, but in the series motor torque varies as the square of the current. Therefore, the series motor will have a much higher starting torque than the shunt motor for a given current. Another special feature of series motor starting for a pair of machines is described above under "Motor, Series." (See also Speed Control of Motors.) The power lost in starting direct-current motors is proportional to the voltage drop through the rheostat.

The secondary of an induction motor would be sub-

jected to an excessive induced electromotive force if full line voltage were impressed across the stator terminals at starting unless additional resistance were placed in the rotor circuit. This may be readily accomplished with slip ring motors, and temporary resistance devices are occasionally inserted on squirrel cage machines in such a way that they automatically disconnect by centrifugal action at high speeds. The usual method of starting squirrel cage motors is by the connection of an auto-transformer in the primary circuit, so that the motor may be started and brought up to full speed at reduced voltage. (See also Speed Control of Motors, by varying the voltage of electrical supply.) The primary voltage is sometimes reduced by the low efficiency method of using resistance in place of the auto-transformer.

Any of the above methods of starting motors may be adapted to manual or to automatic acceleration to normal speed. Manual acceleration leaves the rate of acceleration entirely to the judgment of the operator. It is inexpensive, simple of construction, adaptable to changing conditions of load and needs little adjustment. Large manual starters are hard to operate and are too dependent on the judgment of the operator.

Several automatic systems may be used, namely, the counter electromotive force, the series relay, the series lockout contactor, the current limit with shunt relay, and the time limit by means of a dash-pot or pilot motor.

The *counter electromotive force* method is a direct-current motor system using several solenoids connected across the brushes so as to actuate *contactors* which will short circuit the armature resistance gradually as the motor speeds up and generates counter electromotive force. This is a simple method and gives smooth acceleration under varying loads, but may vary slightly with changes in temperature and supply voltage.

Several *series relays* may be used to accelerate either direct or alternating current motors. Each *relay* is an electromagnet with a series winding connected in the supply line and receiving armature current. If the supply current becomes too large the relay operates a metallic contact to the open position which leaves resistance in the circuit. When the supply current falls sufficiently the relay releases its metallic armature. This closes the circuit of a magnetic contactor, which short circuits a section of the starting resistance. The rate of short circuiting of the resistance is proportional to the motor current and independent of temperature. However, for wide changes in load, adjustments are required.

The shunt relay method of accelerating a motor is applicable on direct current machines, and depends on current magnitude for its operation. Each relay is connected across the terminals of the starting resistance, and its windings, therefore, receive a current in proportion to the current through the rheostat. The relays operate magnetic contactors which control the starting resistance as in the series relay, but the connections are somewhat simpler than for the latter.

Series-lockout contactor acceleration can be used only on direct current motors, and depends also on current magnitude for its operation. It consists of a magnetic contactor with a series coil, and does not require a relay. The time of closing of the magnetic contactor depends on the saturation of the iron in a portion of the magnetic circuit, and it can be adjusted by the operator.

Time-limit acceleration may be obtained by several devices which accelerate the motor in a given time regardless of load. Dash-pot, pilot motor or time clock

DEFINITION SECTION

control can be used to actuate the rheostat. It has the advantages of simplicity and low cost.

Classification of Rotating Machinery. The American Institute of Electrical Engineers, and other technical societies, have adopted standardization rules defining the types of machinery according to the degree of enclosure and protection from surrounding obstacles to satisfactory operation. This classification applies for both generators and motors, but for material-handling machinery it is of importance, more particularly with regard to motors because of their wider use and more general subjection to varied conditions of operation.

An "open" motor or generator is not restricted as to ventilation except as necessitated by good mechanical construction.

A "semi-enclosed" motor or generator has its ventilating openings in the frame protected with wire screen, expanded metal, or other perforated covers having apertures not exceeding $\frac{1}{2}$ sq. in. in area.

An "enclosed" motor or generator is so completely enclosed by integral or auxiliary covers as to prevent any appreciable circulation of air between the windings and the outside of the machine.

A "self-ventilated enclosed" motor or generator circulates its own ventilation by means of a fan, blower, or centrifugal device integral with the machine.

An "externally or separately ventilated enclosed" motor or generator is furnished air for ventilation by some external machine.

A "water-cooled" motor or generator is mainly dependent on water circulation as a prevention of overheating.

A "mechanically protected" motor or generator has its electrical parts covered to provide electrical and mechanical safety to operators without materially hampering ventilation.

A "moisture-proof" motor or generator has been specially treated with moisture resisting material so that the machine can operate in damp places.

A "splash-proof, water-proof or drip-proof" motor or generator is so protected as to exclude falling water, stray splashes, or falling dirt. Such a machine may be "open" or "semi-enclosed," providing it effectually excludes falling materials.

An "acid-proof" motor or generator has been treated with acid resisting materials which will make operation possible in acidic atmospheres. No ordinary insulation can withstand strong acid or alkaline fumes.

A "submersible" motor or generator can be operated a certain length of time (four hours by A.I.E.E. rules) while completely submerged in fresh or salt water, as may be specified.

An "explosion-proof" motor or generator has a frame and enclosing cover which will withstand any gas explosion within and prevent the flame spreading to any outside inflammable gas.

Motor Drive. The propulsion of any type of vehicle, hoist, elevator, conveyor or any rotating machine by electricity is termed motor drive. Many advantages are obtained by the use of electric motors for driving machinery, such as decreased power consumption, increased production, more centralized power supply, simplified and more economical transmission and distribution, more flexibility in locating machinery at the point of greatest convenience, particularly when removals are desired, decreased friction losses, greater cleanliness, improved plant appearance, greater reliability, wider flexibility in choice and operation of machines as to capacity and

control characteristics, greater ease of starting and stopping, and larger adaptability of remote and automatic control. (See also Motors.)

Certain advantages to be derived from electric drive depend on the characteristics of the motor selected and on the class and conditions of service under which the machine operates. For some classes of material handling work, special types of motor are so frequently required that they have become the accepted type for such drive and are given distinctive names. Of these, the elevator motor and mill type motor may be particularly mentioned, as they have features widely differentiating them from other standard motors.

Motor, Elevator. The term elevator motor is applied to the alternating or direct current motor used to propel an elevator. These motors must be specially built to withstand the stresses due to frequent starting and stopping, and also to give excellent commutation and heavy starting torque with a minimum starting current. The motor must also provide smooth elevator operation, without jerks, and give good economy. Standard industrial motors cannot be used for such service, but must receive modification, depending on the kind of elevator to be operated. Elevator motors are classed according to service as follows:

1. Motors for low-speed service, that is, for elevators running at speeds up to 200 ft. per min.

2. Motors for medium-speed elevators which run at 200 ft. to 400 ft. per min. with worm gear, or motors for high speed elevators which run at 400 ft. to 700 ft. per min. with helical gear connection to the elevator cable drum.

3. Motors for high speed gearless elevators which run at 400 ft. to 700 ft. per min. Also called direct traction.

Direct current motors are generally more suitable than alternating current for all classes of elevator work and are always used for high speed machines.

However, alternating current motors are widely employed for low speed elevators running at 200 ft. per min. or less, and induction motors of the two-speed type are in use for machines running at speeds up to 400 ft. per min. This two-speed type has two sets of windings on both rotor and stator. One set of poles and its corresponding rotor winding gives one-third speed instead of full speed. Of the two rotor windings, one responds only for low speed stator connection and the other only for high speed stator connection. In starting, one stator winding is connected to the circuit. After the elevator gets partly up to speed the connections are automatically changed to the other stator winding with resistance in the rotor circuit. The automatic cutting out of the rotor resistance brings the elevator up to maximum speed. During deceleration this motor provides electrical braking action by operating as a generator until the speed drops to synchronism, after which electrically operated mechanical brakes are applied.

Either squirrel cage or slip ring induction motors of the single-speed type can be designed to give satisfactory elevator drive by using the proper amount of secondary resistance. The squirrel cage motor must operate at all times with the same large secondary resistance, on account of starting requirements, so that at full load it may have a slip of 25 per cent. On account of this inherent variable speed, the squirrel cage motor is suitable only for low-speed elevator service, and it will require a higher gear ratio between the motor and elevator drum to maintain the same car speed as would result with a

slip-ring motor of equal horsepower and the same number of poles. The slip of the wound rotor machine may be as low as three per cent at full load with the controller short circuiting the secondary resistance. The squirrel cage motor gives a higher torque for a given current input due to design characteristics, while the wound rotor machine balances this feature by furnishing a given horse power output with less torque because of the lower gear ratio. Consequently, with proper design, neither the slip ring nor squirrel cage motor has any advantage over the other in the matter of current required to start at a given load, although this fact has not been fully recognized. Speed regulation is commonly the controlling factor which determines the class of induction motor to be used for low-speed service.

When direct current supply is available the compound motor is usually selected except for direct traction elevators, in which case shunt motors are common. The compound motor gives good speed regulation, and it may be run as a shunt motor by short circuiting the series field after the motor reaches full speed, thereby gaining the good operating characteristics of shunt machines while running at constant speed. Low speed can be obtained by strengthening the field of the motor and by connecting a shunt resistance around the armature. The elevator may be slowed down by the use of the generator action of the motor, called dynamic braking, and this is an important advantage of direct over alternating current as a source of elevator motive power.

Compound motors for medium-speed worm gear machines and for high-speed helical gear machines are started in series with a rheostat the resistance of which is cut out in steps. This is followed by a removal of the series field so that when normal speed is approached there will be only the shunt field in use and the excessive changes of speed ordinarily resulting from variations of load in the compound motor will not occur as the elevator comes near normal speed. After removal of the series field the shunt field is weakened in several steps until the maximum desired speed is attained. The reverse process of stopping the elevator is commenced by strengthening the shunt field, which produces a momentary generator action and decrease of speed. This is followed by the insertion of resistance in series with the armature, thereby decreasing armature voltage, which further reduces the speed. By disconnecting the armature from the line and short circuiting over a resistance, dynamic braking is procured, and this should bring the machine to a very slow speed. Application of mechanical brakes will then stop the elevator, but the mechanical brake is depended on principally for holding, and will wear out rapidly if the dynamic braking is not arranged to bring the elevator nearly to a stop.

Efficient acceleration and deceleration are of great importance in an elevator motor on account of the considerable number of stops. In starting, the motor should be able to overcome friction, to lift its unbalanced load, to accelerate a weight totaling about eight times the unbalanced load, and to accelerate the revolving masses. In total, this may amount to an accelerating torque of about twice full-load torque on high-speed motors. Therefore, with high-speed motors, efficiency during acceleration is even more important than rated load efficiency, and is primarily influenced by the method of changing speed by field control. For instance, a motor without field control could produce the proper acceleration, but would require a large amount of armature

series resistance and a large number of accelerating switches for cutting out this resistance, and its current demand on the circuit would be high. However, if the machine is accelerated uniformly up to half normal speed by elimination of armature resistance and from half to full speed by field control, a decided gain in efficiency result. A motor with speed variation through field control in the ratio of two-to-one seems in practice to give the best operating economy on high-speed elevator motors. This type of motor is subjected to very rapid changes in current during acceleration and deceleration, so that specially effective laminated interpoles are required to prevent sparking. A motor in this class of elevator service will have a small commutator diameter and a rotor speed of 400 to 800 r.p.m.

For low-speed elevator service, economy during acceleration and deceleration is of lesser importance and first cost of installation usually is such that a motor without field control is selected. A compound winding will be used during starting, the acceleration being procured by cutting out the series armature resistance step by step. Dynamic braking is employed as with the type previously described.

Gearless traction motors are of the shunt type with large commutator diameter. Rotor speeds of 60 to 68 r.p.m. prevail for elevators operating on the so-called 1-to-1 ratio of cable to car speed, and field control ratios of 1.15 or 1.20-to-1 are usual. The higher ratios used with other elevator motors cannot be used because the field strength would become so low that quick acceleration would be impossible. The large armature does not produce high inertia effects on the traction elevator because the rotor speed is low. Such an armature would be a distinct disadvantage on the high-speed rotors of the other types of elevators. The large diameter of the traction motor is an advantage in that small overall length of machine can be secured by building motors with short armatures and more field poles. The latter are commonly eight in number and often no interpoles are required because of the low rotor speed. When gearless traction elevators are used on the 2-to-1 ratio of cable to car speed, the rotors will run at 95 to 125 r.p.m. and field control ratios will be about 1.3-to-1. Commutating poles are usually necessary in this case, but otherwise the motor construction is the same as with the 1-to-1 gearless type.

Page 712, 751, 755, 757.

Motor, Mill Type. Mill type is the name commonly applied to a class of sturdily constructed motors built to withstand particularly arduous service in steel mill operation. They are manufactured with both open and enclosed frames and in a variety of sizes ranging from 3 to 275 horsepower. They are also used in many other classes of drive having similar service requirements, including such work as electric shovels, dipper dredges, draw bridges, heavy duty hoists of the smaller sizes, factory cranes, unloaders, ore bridges and coal bridges.

These motors will carry instantaneously applied overloads of 100 per cent without noticeable sparking and carry even greater overloads without serious sparking. Their special heat resisting insulation will not seriously deteriorate when the machine is operated for considerable periods at 150 deg. C. The armature, shaft and frame are unusually heavy.

Interpoles may be and usually are used to gain improved commutation.

Page 712, 755, 756.

DEFINITION SECTION

Motor, Grain Elevator. Motors in grain elevator service are ordinarily three-phase squirrel-cage, of 50 to 100 horse power for the elevator legs and of 15 to 50 horse power for conveyor belts and car haulage. The seasonal character of the load may lead to the choice of motors of such ratings that operation at 20 per cent above normal load will be permissible in cold weather, as the warm weather load is light.

Page 712, 755, 756.

Motors, Installation Requirements of. The regulations of the National Board of Fire Underwriters for electric wiring and apparatus should be followed in motor installations. These are known as the "National Electrical Code."

Motor, Industrial Truck. The motor used in electric industrial trucks is an enclosed, series wound, high starting torque machine. It must have low current consumption and very large overload capacity and be otherwise designed to give the best possible results with the lowest possible drag on the batteries.

Page 714.

Motor, Crane. If a series direct current motor rotates at too high a speed with a heavy load, it will speed up excessively at light loads, necessitating added resistance and a waste of power. Crane motors are therefore given special ratings to keep heat losses low. Heating is based on a 75-deg. rise in 30 minutes, and speeds are limited to 450 or 500 r.p.m.

(See also Electrical Equipment of Cranes.)

Page 712, 755, 756.

Motor, Mine Hoist. Induction motors are most widely used for mine hoists. They must have adequate torque both for starting and running, good performance characteristics, rugged construction and a low slip-ring voltage which prevent flash-over at the rings in case the motor is suddenly reversed at full speed. High speed induction motors have the best performance characteristics and the lowest first cost and are therefore ordinarily used with herringbone gears, the reduction ratios going as high as 15-to-1.

Large direct current motors are also used for mine hoists. They can be designed to give good efficiency at low speeds and may therefore be directly connected to the hoist drums, thereby eliminating gears. The use of commutating poles and Ward Leonard control overcomes all difficulty encountered in handling heavy peak loads so that larger units can be installed than in induction motor equipments. This system is recommended by some engineers for all high-speed shaft hoists, and for those in which operating efficiency is needed, particularly coal hoists.

A third system of mine hoisting used where it is desirable to avoid heavy peak loads and wide voltage fluctuation consists of a Ward Leonard power set, a flywheel and a regulating device to permit the wheel to supply all energy required by the hoist above the average value over the complete cycle.

With the Ward Leonard systems electric breaking is available and the mechanical brakes are relieved of most all use except that of holding, and the power developed by the descending load is partially returned to the power system.

(See also Electric Power for Material Handling in Mines.)

Page 712, 755, 756.

Controller. An electrical switching device by means of which a motor may be started, stopped, reversed and

adjusted to suitable speeds is called a controller. It harmonizes the characteristics of the motor with those of the machine to be driven. The earliest type was the so-called starting box for direct current motors which, by a stepped decrease of the external resistance inserted in the line or armature circuit, permitted gradual increase of voltage during starting. In this manner it is easy to prevent the excessive mechanical stresses and the burning out of fuses and rotor windings which would result from the currents drawn from the line by a motor accelerating to full speed under full line voltage. This controller is still the most common type and is variously known as *starter*, *starting box*, *starting rheostat* and *compensator*. The reactive controller for alternating current motors usually is known also as a *compensator* and it constitutes a second class of controller. It is really an auto-transformer which impresses a reduced voltage on the motor during starting. When full speed is approached the compensator is disconnected and the motor is placed directly across the line.

All direct current starters should have as an essential part of their construction a so-called *under-voltage release* or *no-voltage release* which automatically throws the contact to the disconnected position when for any reason the line voltage fails. If this no-voltage release were not in the circuit a sudden restoration of line power would impress full voltage across the terminals of the stationary motor armature.

Many starters also are provided with an *overload release* which is a circuit-breaker device to open the line circuit in case excessive load comes on the motor. It is an additional safety device which is sometimes required by specifications.

Controllers for speed adjustment on direct current shunt or compound motors ordinarily have two separate resistances, one in the armature and one in the field circuit, each controlled by separate levers. The field resistance gives a finer adjustment of speed control, but for only a small range, and does not require a large current carrying capacity as would the armature rheostat. Speed adjustment is less universal on alternating current motors, and consists principally of adjustable resistances placed in the rotor circuit, that is in the secondary of induction motors by connection to slip rings. This resistance is also used during starting.

Controllers for reversing direct current and single phase alternating current motors are so connected as to reverse the direction of current flow in one winding of the motor, either in the armature or the field. Reversal of polyphase alternating current machines is accomplished by the reversal of one phase of the motor.

For hoisting or crane service of relatively light duty a face-plate or *dial controller* with a single contact arm controlling the four functions of starting, stopping, speed regulation and reversing is in common use. For the largest sizes of motor, *drum type* controllers are usual and the four functions are combined in the one machine.

Controllers are frequently designed to perform a fifth function, namely, to make suitable connections for dynamic breaking.

Automatic and semi-automatic controllers are in wide use and have many advantages over the manual types, especially where very large motors are used.

The designation controller appears in connection with the various devices used in operating motors and in many cases the term is added to the name of the machine being operated. For example, when it is used to start, stop and

MATERIAL HANDLING CYCLOPEDIA

regulate the speed of elevators it is called an *elevator controller*.

A handle or lever is commonly provided on a controller, and a latch carried by it drops into notches corresponding to the successive steps in voltage variation.

In some cases special equipment is provided instead of the handle. For example, in elevators the controller is often operated by a hand-rope which passes up through the car and around a sheave, or else by electro-magnets which in turn are actuated by a master switch in the car.

Manually operated controllers should be inspected weekly to see that contact plates and fingers are free from bugs or abrasion, that roughness is removed with a file or sandpaper, and that contact plates are very slightly lubricated with vaseline. Special instruction given by the manufacturer must in any case be followed.

All controllers on cranes whether for hoists, bridge or trolley should be interchangeable when of like capacity or type. No controller for hoisting should be permissible unless provision is made on the controller for lowering the load when the limit switch is open, by simply reversing the controller. Push-button or other switches for closing the main line contact should not be tolerated, as they may lead to trouble and serious accidents if operated when the controller is left in the hoisting position when the limit switch is open. The use of the plugging switch is not desirable but the demand for its use has been brought about because of the use of motor brakes of insufficient torque to stop the upward travel of the hoist when the limit switch opens. The use of half torque brakes is partly to blame for this.

In mine hoist installations a variable resistance called a mine hoist controller is placed in series with the rotor circuit of an induction motor to control the speed and to provide resistance to injurious heating currents that would otherwise flow during starting. This resistance must be large to allow for creeping speeds and is therefore much greater than is required for occasional starting duty, and it must be provided with a suitable number of steps for speed adjustment and regulation.

Motors exceeding 100 to 150 horsepower are difficult to handle by drum controllers due to the high currents and frequent switching. A type of magnetically operated switch called a *contactor* is then used for both primary and secondary, and it is manipulated by a small operator's controller which need be only large enough to handle the small current required to work the contactor.

Page 711, 756.

Compensator. A compensator is an auto-transformer with a switching lever by means of which it may be operated as a starting device for an alternating current induction motor.

Page 711, 756.

Rheostat. Any device containing a resistance which may be varied to control current or voltage of an electric circuit is called a *rheostat*. The term resistance has been commonly used but *resistor* or rheostat are the present standard terms. The resistance of any conductor or resistor depends on the cross-section, length and kind of material of which it is made and varies also with the temperature. A rheostat not effectively cooled will have its capacity to absorb electric energy decreased because of its inability to get rid of heat energy. When a rheostat is used to regulate the current entering a battery while charging, it is commonly known as a charging rheostat. The term rheostat is frequently used in connection with

controllers and motor starting boxes. (See Controller.) When so employed the terminals are marked "line," "armature" and "field" to indicate the proper connection to the line and motor.

For installation of rheostats the "National Electrical Code" Regulations of the National Board of Fire Underwriters for Electric Wiring and Apparatus should be followed.

Page 711, 756.

Reactor. A reactor is a coil, winding or other conductor possessing such high inductance that it will set up a reactance in an alternating current circuit and limit the current flow for a brief interval of time during short circuit, lightning disturbance or a similar condition. One reactor is placed in series in each phase or in two phases of a three-phase circuit.

Switches, Circuit-breakers and Fuses. A *switch* is a device for making, breaking or changing the flow of current in an electric circuit. A *circuit-breaker* is an electromagnetic mechanism placed in a circuit for automatically interrupting the flow of current under infrequent abnormal overload conditions.

A *fuse* is a metallic wire designed to melt and dissipate at a stated current, and in this way protect the remainder of the circuit against abnormal currents.

A *relay* is an electro-magnetic device by means of which contacts in one circuit are operated by changes in operating conditions in the same or other circuits.

The rating of a switch or of a circuit-breaker includes the normal current which it is designed to carry, the normal voltage on which it is intended to operate, the normal frequency of the current when alternating, and the interrupting capacity of the device.

A *master-switch* is a device which serves to govern the operation of contactors and auxiliary devices of an electric controller. (See Controller.)

A *control switch* is for controlling electrically operated switches and circuit breakers.

An *auxiliary switch* is one actuated by some main device for signalling and interlocking.

The "National Electrical Code" should be followed regarding switches, circuit breakers and fuses.

A *speed limit device* consists of a small weight counterbalanced by a spring adjusted in such a manner that it can be set within a very narrow margin at any speed desired above rated speed or above synchronous speed and when this limit is reached the weight will move out sufficiently to trip a small arm which either closes or opens the circuit of a circuit breaker as may be desired to prevent a motor running above a certain desired speed.

Page 711, 756.

Current relays are used in a regenerative braking circuit to limit the current of retardation to a reasonable and safe value well within the commutation limits of the motor. The closing of the electric braking circuit when regenerative braking is employed is called *closure*. If this is done when the armature speed is several times more than normal an excessive braking current would flow through the dynamo unless limited by these current delays. For those installations where the holding brake is automatically operated a control may be used which insures the maintenance of the brake in the released position until the load has come substantially to rest.

A scheme of automatic control is sometimes used in regenerative braking for reversing the hoist motors when opening grab buckets and starting to lower, thereby causing the dynamo to operate as a motor until a predeter-

DEFINITION SECTION

mined speed is reached, when it automatically and without interruption of circuit becomes a generator.

Page 711, 756.

Electric Elevator Brake. A magnetic or other electric device added to the friction brake of electric elevators to assure safe, positive and quiet action of the brake, is commonly called an electric elevator brake. The type of design depends on whether direct or alternating current is used as the motive power of the elevator, but in any case the operation should be such that the brakes are set by a holding spring when no current is flowing through the elevator motor. One type of control used on elevators operating with alternating current is by the attachment of an electric elevator brake magnet to the friction brake. When the motor is started a portion of the current passes through the shunt magnet coils, energizes them and pulls down the brake armature, thereby compressing the springs and releasing the brake. Another alternating current brake with motor control, eliminating the alternating current solenoids, uses a high torque squirrel-cage induction motor to rotate a toothed sector linked to the arms of the brake shoes and thereby releases them when power is applied. The control motor then stalls and maintains the brake in the released position until power is cut off. There is also a direct current solenoid system similar to the alternating current magnetic brake mentioned above.

Page 712, 750, 757.

Cranes, Electrical Equipment of. An electric crane ordinarily consists of three general parts, namely the bridge, trolley and hoist. Each of these is driven by a separate motor. The bridge motor drives the crane along the track, the trolley motor drives the trolley on the bridge, and the hoist motor does the lifting. The latter is the largest motor on the crane. Auxiliary hoists if provided are generally mounted on the main trolley and arranged for high speed lifting of lighter loads. Electric wiring on cranes should receive special attention as to protection. Exposed surface switches are unsatisfactory. Overload and no-voltage protection ought to be secured by magnetic contactors mounted under the operator's seat or otherwise. The operating resistance is often set in a ventilated frame in front of the cab, and should be convenient for repair in case of accident. A protected type of snap switch is essential for disconnection during inspection.

Page 706, 756.

Shipyards Cranes, Electric Equipment of. Both direct and alternating current are successfully used in shipyard cranes. Dynamic braking is usually employed on direct current hoists, but reversible control is employed for other crane motions and for all alternating current crane motors. All revolving types of cranes have magnetic control with automatic current-limit acceleration for revolving or slewing as this motion is predominantly acceleration. The travel motion of revolving cranes is equipped with a control giving one or more creeping points, so that the crane may be brought to low speed and stopped without excessive shock when removal of power sets the brakes. Creeping speed points give dynamic braking when the motor or motors are overhauled by the crane, thereby providing a means for holding the speed to a safe value when traveling with a high wind. A solenoid load brake is necessary unless the operator travels with the hoisting machinery, and an automatic mechanical load brake is used. A multiple magnet brake, which is an electro-magnet braking device

giving two or more degrees of braking strength depending on the number of solenoids, is used to gradually stop the cranes with bridge motion before the controller is turned to the "off" position. In starting a multiple magnet braked crane, the control permits first energizing of one solenoid and then the next, gradually reducing the braking effect as the motor becomes energized.

Page 706, 756.

Mines, Electric Power for Material Handling in. The chief uses of electricity for material handling in mines are for driving hoists and the propulsion of trucks. Electric hoists were early and widely developed in mining before their extensive use in other industries, and a number of systems of motor drive and control are satisfactory. No specific rule can be laid down as to the choice of electric system, the matter depending on the power available, the peculiar characteristics of the hoist installation and the other requirements of electricity in the plant or neighborhood. (For types of motor drive and control see Motor.) The extent and variety of applications may be judged from the following installations of one electric company in 1916 which was a year of extensive development. Of 79 equipments of mine hoists rated at 100 horsepower or more aggregating 30,000 horsepower, 80 per cent of the rated capacity consisted of induction motor installations, the remainder utilizing Ilgner direct current equipments of flywheel motor generator sets and the Ward Leonard system of control. Of 240 installations by this company rated at or in excess of 250 horsepower and aggregating 121,000 horsepower, all but 35 are driven by geared induction motors. The largest induction motor installation of this group is rated at 1,800 horsepower and develops about 2,700 horsepower during starting. Two South African direct current installations are rated at 4,000 horsepower.

Alternating current wound rotor induction machines are generally used in coal mines and the smaller metal mines of America for hoisting. In this work the standard drum controller is ordinarily used for sizes from 25 to 150 horsepower and the magnetic switch controller for intermediate sizes of 150 to 500 horsepower. Motors larger than 500 horsepower have liquid rheostat control in the secondary and magnetic switches in the primary for reversing. The power system in many locations cannot stand the peak loads imposed by the induction type of motor. In such cases the Ilgner system is widely used. The hoist motor is a separately-excited direct-current motor with constant field excitation and permanently connected to a separately-excited variable-speed direct-current generator, the latter being driven by a wound rotor induction motor. By the insertion of resistance in the secondary of the wound-rotor motor the motor-generator set is made to slow down without drawing an excessive load from the power system. The Ward Leonard system of controlling the hoist motor speed by varying the field strength of the direct current generator of a motor-generator set is also extensively employed in mining. It has fine speed adjustment, higher efficiency, safety and greater speed of operation in its favor; and is therefore particularly adaptable to coal hoists. (For further discussion of Ilgner and Ward Leonard systems see Speed Control.)

In Europe the induction motor is but seldom used for high-power hoists, owing to its relatively poor action as a regenerative brake. However the alternating-current commutator motor in units up to many hundred horsepower is in great favor. One make, the Deri

motor, works as a repulsion motor having its stator connected directly across the mains, while the wound rotor is electrically isolated and provided with two mutually interconnected sets of brushes, one of which is movable with respect to the other. All adjustments of speed are made by moving the second set of brushes, and a reliable regenerative braking is thus obtained. For three-phase supply larger units are built as double motors having two independent armatures and two Scott connected stators for balancing the load. Ordinary three-phase commutator motors with an armature-transformer are also rapidly coming into use for heavy hoisting. European practice, like American, indicates that the choice of system depends on the local conditions of the particular installation and that general rules cannot be laid down for the determination of the capacity and type of machinery to use.

(See also Motor, Mine Hoist.) Page 706, 756.

Winches, Electric. Electrically operated winches may be of the portable fixed or ship types. Winches of about 2,500 lb. capacity with a rope speed of 225 ft. per min. would have a 15 to 25 horsepower alternating current or direct current motor with solenoid brake or friction clutch and foot brake. The control may consist of drum type controllers mounted on the machine or of the magnetic control where the panel is mounted on the machine and the portable master controller is carried by the operator. Page 787, 791, 803, 829.

Hoisting Signal Systems, Electric. Electric hoisting signal systems are constructed in three types to replace the bell wire and gong or pneumatic signals formerly used in mine hoist and similar work. The low-voltage direct current type consists preferably of iron clad and waterproof annunciators or bells, transmission line, batteries, and push-button or other signal switches. A second type of signal system using bell-ringing magnetos is very satisfactory but more costly. Magnetos are placed across the terminals of the signal line so that by twirling the armature of one magneto an electromotive force is generated thereby ringing bells placed across the line, at all signaling and hoisting stations. A third type of signal system, which is in wide use, involves stopping down the low voltage alternating or direct current lighting circuit to about 30 or 40 volts by a transformer or resistance, and connecting switches and gongs across the line. Annunciators consisting of magnetic devices with numbered metal disks which rise or fall by switch closure on the line, and electric lamps may also be used in place of gongs on signal systems.

Page 706, 752, 756, 827.

Cable. An electric transmission conductor consisting of stranded wires, or a combination of stranded wires or conductors insulated from each other is called a cable. One of the wires or any group of wires of a cable which is used as a conductor is called a strand. The term stranded conductor may also be used when the conductor consists of more than one wire.

Page 706, 818.

Wire. A slender rod or filament of drawn metal, called a wire, may be bare or covered with insulation. In the latter case it is commonly called insulated wire. Sizes of bare wire are frequently specified according to the Brown and Sharpe (B. & S.) gage which assigns

numbers 0 to 40, inclusive to denote the different diameters which vary in a geometric progression. Standard wires number 00, 000 and 0000 are an addition to this series and all larger sizes are specified by their area in circular mills, square inches or square centimeters.

Page 706.

Feed and Trolley Wire. Any wire used to convey electricity to the moving trolley of an electric vehicle is called a trolley wire. Hard drawn grooved wire 0000 gage is most commonly employed except in the smaller installations because of greater mechanical strength, and decreased depreciation as compared with the smaller sizes of 00 and 000 which would frequently have sufficient current carrying capacity. Round and figure 8 cross-section wire are infrequently used because grooved wire combines ease of handling, due to its symmetry of section, with a lessening of wire distortion by clamping ears. Trolley wires may be supported from roof, wall, timber or pipe, and are strung about six inches outside of the gage line on the opposite side from all passages encountered where sudden entrance to the runway from side or above might be unsafe. In mining work trolleys have been placed at 6 in. above the locomotive frame but 3 ft. to 7 ft. is the usual range. Mono-rail track where used must be permanently and effectually grounded. Main feed wires must be protected by fuses or a circuit-breaker and controlled by a switch in accordance with the requirements of the National Board of Fire Underwriters. This switch should be conveniently located near the machine to be operated. Page 717.

Collector, Electric Current. A device for receiving electric current on a car, crane, motor or other electrical machine having a motion of either translation or rotation relative to the supply source of electricity. It consists of a brush or wheel which presses against and makes sliding or rolling contact with a bare energized wire or rail, thus serving to conduct electricity to the moving machine from the stationary source of electricity.

Page 706.

Two-wire Transmission. This is a system of direct current transmission of electricity, now in common use, by which current flows out of the generators over one wire to the motors or other load and returns over the other wire to the generator. The outgoing and return wires ordinarily run side by side throughout the transmission and distribution system, thereby suggesting the name two-wire transmission.

Three-wire Transmission. This is a system of direct current transmission of electricity in which three wires run approximately side by side as transmission wires, one wire being at a potential intermediate between the other two. A load connected to the latter wire, called middle wire, and to either one of the other wires will have impressed on it about half of the voltage which would be obtained between the two outside wires. As commonly used in this country the potential change from the middle wire to each of the others is 110 volts, the outside wires, therefore having 220 volts potential difference. This system permits the use of two voltages when both are desirable for varying load requirements and further makes possible a saving of weight in transmission wire if the loads are equally balanced between the two 110-volt circuits.

HOISTING MACHINERY

Cranes, Hoists, Derricks, Telfers, Cableways,
Tramways, Excavating Machines, Loading
and Unloading Machines, Winches,
Trackage, Accessories

A Treatise on the Construction and Operation of Hoisting
Apparatus as Used in Modern Industry for Handling
the Products of Forest, Field and Mine; for Loading
and Unloading Materials for Transportation; for
Handling Materials in Construction Work;
and for Handling Raw Materials and
Moving the Finished Products in
Manufacturing Plants

By

CHARLES N. WINTER

Managing Editor, Carbuilder's Cyclopaedia, Locomotive Cyclopaedia; Associate Editor,
Railway Age; Associate, American Society of Mechanical Engineers

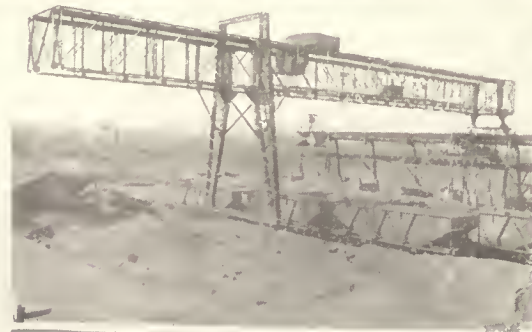

Cranes

THE ADVANTAGES OF CRANES as labor-saving devices have become well recognized and the benefits derived from their use have led to their wide application in the shops and yards of industrial plants, in railroad and marine work and in other operations where heavy material must be handled. Ranging in character from the simplest type of jib crane to the numerous designs of overhead traveling cranes, locomotive cranes and the various modifications and combinations of such types, and being used in all of the basic industries, as well as in shipbuilding and cargo handling, in railroad work and in warehouses, it can be said that modern industry is dependent on cranes for economical operation.

It is not only essential in the design of cranes to consider the strength of the structure and the efficiency of its operation, but also the safety of the operator and those working in the vicinity. Therefore, in crane construction, only those materials should be used which fulfill the specifications of the American Society for Testing Materials, or of the Association of American Steel Manufacturers, and the design of parts should conform to accepted engineering methods. The Code of Safety Standards for Cranes, as prepared by a sub-committee of the American Society of Mechanical Engineers and appearing in another part of this book, should be fully complied with.

Desirable features of crane construction are: Maximum strength with minimum weight; durability and accessibility of the wearing parts; protection of wearing parts from dirt; efficient lubrication; adequate power with mobile starting and acceleration; and simplicity of operation.

As in the selection of other equipment, the service required determines the type of crane to be installed. It is obvious that a traveling crane should not be installed where the work to be done consists of handling material in an area that lies within the radius of a jib or a boom of a reasonable length. Such work can be done most economically by a jib crane or by a derrick.

Overhead Traveling Crane

The overhead traveling crane has become by far the most generally used in industrial plants because of its adaptability to manufacturing processes. It is used indoors or outdoors in foundries, steel mills, machine shops, power and coaling stations, in warehouses or storage yards, or in any industrial work where the lifting and moving of heavy materials is required. Being installed on an elevated runway, it permits the use of the entire area of floor space within its range for storage or for manufacturing purposes, and, having both transverse and longitudinal motion, it will reach any part of a rectangular room or yard in which it is possible to provide the track.

Cranes of this type are constructed and equipped in a great many ways for a wide variety of uses, ranging from the single girder of short span equipped with a simple

chain or air hoist, and handling comparatively light weights, to the four or six-girder ladle cranes and ingot stripping cranes and the general purpose cranes with box or lattice type girders equipped with crane trolleys and hoists capable of raising 300 to 400 tons or more.

The Bridge

The crane bridge or girder must be so proportioned that a factor of safety of not less than five is assured. These girders may be formed of one or more I-beams for cranes of short span and light loads; of box section formed of steel plates and angle irons or channels; or of I-beams, channels, or angles with the lattice type of structure for medium or wide span and for heavy loads.

It is desirable that all girder members extend the full width of the span but in cranes of extremely wide span where this is not possible, the splices must be so placed

and so reinforced that the maximum strength is obtained. It is essential that crane bridge girders be of such construction as will resist not only the load stress, but also the transverse strain, due to sudden starting and stopping, and, in outdoor installations, the wind pressure as well. The crane bridge should be provided with a foot-walk and hand-rail to insure safe and convenient access to the

bridge for inspection and maintenance purposes.

Many cranes of the lighter capacities are controlled from the floor but those of heavy capacities are provided with an operator's cab, usually suspended from the bridge, in which the various operating devices and controllers are installed. The cab sometimes is attached to and travels with the crane trolley, thus keeping the operator near to the work. The cabs usually are enclosed on cranes engaged in outdoor service.

End Truck or Carriage

The crane bridge rests on end trucks or carriages mounted on flanged wheels which travel on a runway or track secured to the building in which the crane is installed or on an independent structure in outdoor installations.

The truck frames usually are built up of structural steel with cast steel bearing brackets and cast steel or chilled cast iron truck wheels. They are attached to the crane bridge by gussets and angle irons. Cast steel frames are used on many cranes and, when so designed as to provide adequate strength, are desirable because of the elimination of many of the bolted or riveted parts necessary in structural work.

The type of construction of these end trucks varies with the size and capacity of the crane. On single I-beam cranes and other overhead traveling cranes of light capacity, the end trucks each consist of two small wheels mounted in suitable bearings of the pin and keeper type and spaced by a simple plate or channel or by cast steel or sometimes, in cranes not subjected to severe service, cast iron side frames. These trucks are operated by means

Overhead Traveling (Hand Power, Power Operated); Gantry (Traveling, Stationary). Jib; Pillar; Pillar-Jib; Walking Jib.
Locomotive (Steam, Gasoline, Electric); Wrecking; Pile-Driver.
Wharf: Portal; Semi-Portal; Roof.
Shipbuilding: Hammerhead; Portal; Tower.

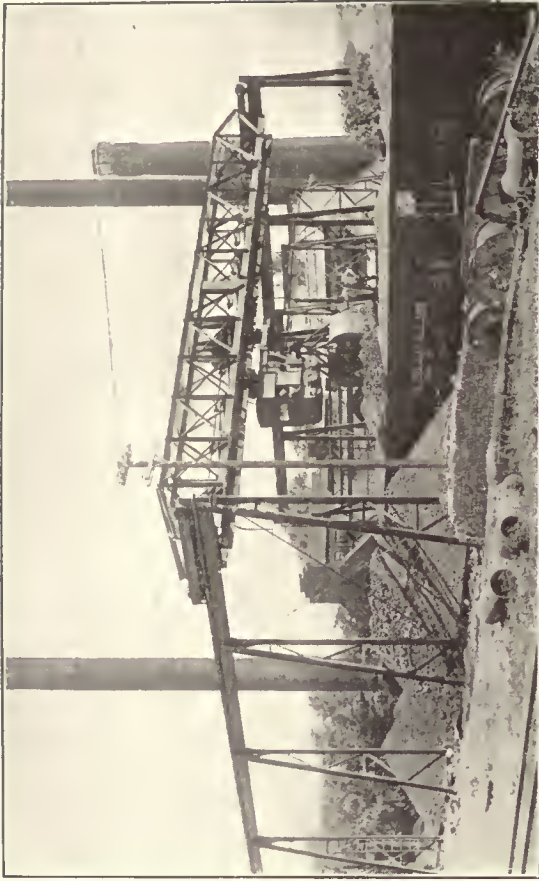

Overhead Traveling Crane Equipped with Automatic Grab Bucket for Handling Fuel at a Power House



Overhead Traveling Crane Equipped with Cab-Operated Monorail Hoist



Overhead Traveling Crane Installed Over Railroad Tracks for Loading and Transfer Service, Indoors and Outdoors

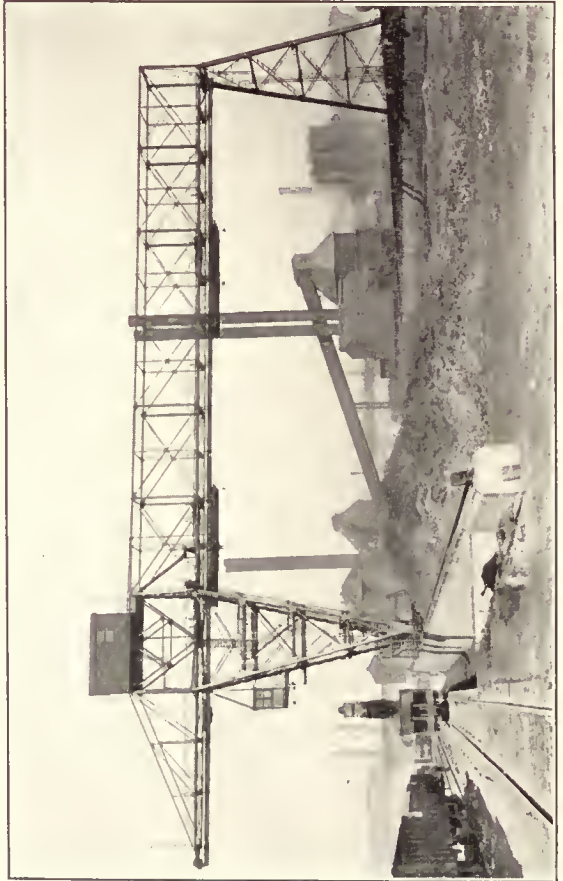

Traveling Bridge Crane Installed Over Storage Space for Unloading and Rehandling Loose Material

of gears operated by a hand chain, or by an electric motor mounted on the crane girder.

On cranes of the heavier capacities, the truck side frames are of more substantial construction and range from the two-wheel rigid side frame type to the compensating or equalized trucks each having four or more wheels mounted in bearings of the pin and keeper type or the M. C. B. (Master Car Builders) type. These trucks are propelled by means of gears operated by an electric motor mounted on the crane girder.

Bridge Drive

The crane bridge is propelled by a series of gears secured on the end trucks and on a shaft, known as the squaring shaft, which extends across the bridge. It usually is operated by a chain on hand-power cranes and by an electric motor mounted on the bridge on power-operated cranes.

The squaring shaft is supported in bearings at the trucks and at intermediate points on the bridge. It carries a pinion at each end which meshes with a gear connected to one of the truck wheels. This applies power to both trucks simultaneously and thus propels the bridge along the runway without any tendency to slew and bind between the rails.

Another type of bridge drive used on some cranes of light capacity is operated by means of friction cones. The gears are located on one end of the bridge and the drive shaft is rotated in either direction by means of two friction cones which are brought into contact with a friction disk on the drive shaft. Bringing the cone on either side of the disk in contact permits a movement in either direction without reversing the motor. This effects a considerable saving in electric power as it is not necessary to stop and reverse the motor in order to reverse the travel of the bridge.

Stops of a height not less than one-half the diameter of the truck wheel are provided at suitable points on the runway to prevent the crane running too far and running off the rails or damaging the building at the end of the runway.

The speed with which the bridge is to travel must be determined by the service for which it is designed. It should vary from about 25 ft. to 40 ft. per minute when used to handle molds in foundries or for other work requiring careful handling without jolting. For other service where the material is not fragile and speed is essential to economical operation the bridge travel may range upward to a speed of approximately 400 ft. or more, per minute.

On practically all modern cranes of the heavier capacities the bridge motor is located at the center of the span and thus distributes the torsion equally on the squaring shaft. This is preferable to having the motor at one end as is done in some cases. The gearing should be enclosed in a dirt and oil-proof case. This is an important factor in crane maintenance, particularly in foundries or similar industries where there is considerable dust or in paper mills or any other industry where oil drippings might damage the material being handled.

The Trolley

The crane trolley must be of a type and capacity suitable to the service required. Trolleys designed for use on overhead traveling cranes having a single I-beam girder may be a simple traveler having two, or four, or more, wheels which travel on the top or on the bottom flanges of the beam. They may be pulled by hand, or may be

geared and operated by means of a rope or chain, or by an electric motor controlled by the operator from the floor. Pneumatic and steam-hydraulic methods also are being used successfully in foundries or other indoor operations to operate such crane trolleys.

On cranes having two or more girders in the bridge structure, the trolley is mounted on side trucks similar to those used to carry the crane bridge. These trolley trucks, as they may be termed, generally travel on top of the girders. They are operated by an electric motor mounted on the trolley itself, sometimes being controlled from the floor, or, in traveling cranes of the larger capacities, from an operator's cab. For special service requirements many cranes are equipped with trolleys having more than one hoisting drum or with two trolleys having independent control, thus providing hoists at widely separated points on the bridge so that both hoists may be used to handle long objects or may be used as individual hoists for other purposes.

The various types of trolleys used on overhead traveling cranes are described in this book in the chapter on crane trolleys.

Hoisting Mechanism

On hand-power overhead traveling cranes, the hoisting apparatus usually is a chain hoist rigidly connected to the trolley or suspended from it on a hook. Sometimes pneumatic or electric hoists are used on cranes on which the bridge is operated by hand-power. These hoists are described in the chapter on hoists.

The hoisting mechanism used on cranes of heavy capacity is installed on the trolley carriage and has one or more hoisting drums and trains of gears and is operated by one or more motors mounted on the trolley. The chapter on crane trolleys describes such hoisting mechanism in detail.

Brakes

Power operated overhead traveling cranes are equipped with a mechanically operated bridge brake, or foot brake, to control the travel and with both a mechanical and an electrical load brake on the hoisting mechanism.

The bridge brake may be of the band type acting on a drum on the squaring shaft; of a clamp or clam-shell type acting on a drum on the motor armature shaft extension; or of the friction disk type acting directly on the bridge motor pinion.

The mechanical load brake may be of the multiple disk type; of a combined disk and flexible band type, both operating in an oil bath; or of a coil type acting on a continuous shaft. When the crane trolley is operated by a direct current motor, a dynamic brake may be used.

An electrical brake of the solenoid type is usually also provided. This brake is not intended to control the load, though it should have sufficient power to do so in an emergency, but it insures positive stoppage and control of the hoisting motor when the current is cut off, either intentionally or through accident and thus will hold the load suspended.

The various types of bridge and load brakes are described in the chapter on crane details and trolleys.

Electrical Equipment

Electric overhead traveling cranes may be operated either by direct current or by alternating current motors of slow speed types designed especially for crane service. The modern crane usually has three motors—one installed on one of the bridge girders and used to propel the bridge along the runway, and two motors mounted on the trolley carriage—one to propel the trolley itself across the bridge

and the other to operate the hoisting drum. Some crane trolleys have an auxiliary hoisting drum operated by the same motor as the main hoist but usually additional motors are used when the crane is equipped for automatic bucket operation or in other work which requires more than one independent hoisting drum.

The electric current required to operate the crane motors is taken, by sliding contact, from a line installed on the crane runway. Wires installed on the bridge conduct the current direct to the bridge motor and to the trolley motors by a sliding contact with the line on the bridge. The electric wiring, both on the runway and on the bridge, must be effectually insulated and should be installed in accordance with the Underwriters' National Electrical Code.

The switches preferably are automatically controlled by means of a magnetic controller but may be manually operated. The controllers and the switchboard should be located in the cab or the building within easy reach of the crane operator.

Accessories

The various hooks, magnets, buckets, blocks, sheaves and hoisting rope and other accessories used with overhead cranes are described elsewhere in this book.

Code of Safety Standards for Cranes

Prepared by the American Society of Mechanical Engineers Sub-Committee on the Protection of Industrial Workers.

The word "SHALL" where used is to be understood as mandatory and "SHOULD" as advisory.

The following Standards apply to cranes which are regularly used in and form part of a permanent industrial plant. In addition to Electric Traveling Cranes, these regulations are to cover Jib Cranes, Monorail Cranes, Hand Power Cranes, and other hoisting apparatus of a similar nature, in so far as the various sections apply.

The provisions of all Safety Standards issued by the Society shall apply in cases not specifically covered herein.

Caution: Employees shall not remove or make ineffective any safeguards except for the purpose of making repairs, and safeguards so removed shall be replaced when repairs are completed.

Electric Traveling Cranes

General Construction

1. Proper provisions for strength shall be made for all parts subject to impact and rough usage. Journals and shafts shall be of sufficient size to bring the pressure within safe limits.
2. All apparatus shall hereafter be designed throughout with not less than the following structural factors of safety, under static full rated load stresses, based on the ultimate strength of the material used:
 - (a) All gears, and complete hoisting mechanism, factor of not less than eight (8).
 - (b) All other parts, factor of not less than five (5).
3. Calculations for wind pressure on outside cranes shall be based on not less than thirty pounds per square foot of exposed surface.
4. Cranes should be of what is known as "All Steel Construction"; no cast iron should be used except for such parts as drums, bearings, brackets, etc. Cast iron shall not be used for trolley and truck housings subject to tensile or compressive stress. No combustible material should be used.
5. All bolts should be of the through type, and be equipped with approved lock nuts or lock washers.
6. Where access to the crane is necessary, steps or stairs with hand rails should be used.
7. Platforms should be provided for changing and repairing truck wheels on end trucks and have stairways leading to them.
8. A platform or footwalk to give access to the crane shall be provided, which is accessible from one or more fixed ladders or stairways, and shall be not less than twenty (20) inches in width.
9. A footwalk shall be placed along the entire length of the bridge on the motor side except when the construction of the

crane prevents or when such a platform would not ordinarily be used for the repair or maintenance of the crane. This walk should be at least six feet six inches (6' 6") below the bottom of the overhead trusses.

10. Footwalks should be placed across the ends of the trolleys at right angles to the bridge walks. When so placed they shall be not less than twelve (12) inches in width.
11. Footwalks shall be of substantial construction and rigidly braced.
12. No openings shall be permitted between the bridge footwalks and the crane girder. When wire mesh is used to cover such openings the mesh opening must not be greater than one-half (½) inch.
13. Each footwalk shall have a standard metal railing and toe-guard at all exposed edges wherever practicable.
14. Not less than twelve (12) inches actual clearance should be allowed between highest point of a crane and the overhead trusses, and not less than two (2) inches between any part of the crane and building, column, or other stationary structure. Where there are more than two crane runways in parallel there should be a clearance of not less than twenty-four (24) inches between the extremities of the cranes.
15. Means of escape shall be provided for operators of hot-metal cranes.
16. The operator's cage shall be located at a place from which signals can be clearly distinguished and be securely fastened in place and be well braced, to minimize vibration. It shall be large enough to allow ample room for the control equipment and the operator. The operator shall not be required to step over an open space of more than eighteen (18) inches when entering or leaving the crane. A pail filled with sand or an approved fire extinguisher shall be carried in the crane cage for use in case of fire.
17. A foot or hand-operated gong, or other effective warning signal, shall be placed in a location convenient to the operator and be securely fastened.
18. Ladle and other cranes subjected to heat from below should have a steel-plate shield not less than one-eighth (⅛) inch thick and placed not less than six (6) inches below the bottom of the floor of the cage.
19. The cages of cranes hereafter erected shall be of fire-resisting construction.
20. All gears on cranes hereafter erected shall be provided with standard guards. This provision should apply to all existing cranes where practical.
21. No overhung gears shall be used unless provided with an effective means of keeping them in place, and keys shall be secured in an approved manner to prevent the gears from working loose.
22. Unprotected keys shall not be left projecting from ends of shafts.
23. The construction of the crane shall be such that all parts may be safely lubricated when the crane is not in operation.
24. The installation of the switchboard, wiring, and all electrical equipment must fully comply with the safety regulations of the United States Bureau of Standards and the fire-prevention regulations of the National Board of Fire Underwriters.
25. There shall be a main-line switch or its equivalent so arranged as to cut off all power from the crane, and so constructed that it may be locked in its open position. Convenient and lockable means should be provided on the floor for cutting the power from any part of the crane structure.
26. Open-type controllers shall have an asbestos-lined steel guard over the movable contact parts, both to protect the operator's eyes and to prevent articles from falling on contact parts.
27. A hoist-limiting device should be provided for each hoist.
28. Suitable brakes shall be provided for the hoist and bridge travel. Each hoist shall be equipped with effective brakes which shall be capable of sustaining at least two (2) times the full rated load.
29. The drums on cranes hereafter erected shall have a flange at each end to prevent the ropes from getting off the drum, and be so designed that there will be not less than two full wraps of hoisting cable in the grooves when the hook is at its lowest position.
30. The hook block shall be of a type so arranged that it will lift vertically without twisting. The hook should be provided with a handle and should be painted white.
31. Bottom sheaves shall be protected by close-fitting guards, to prevent the rope from becoming misplaced.
32. Crane bumpers shall be provided, and shall be at least one-half of the diameter of the truck wheel in height. Both truck-wheel and trolley bumpers should be fastened to the girder and not to the rails. Bumpers shall be built up of plates and angles, or be made of cast steel.
33. Truck fenders shall be installed which extend below the top of the rail and project in front of all bridge and trolley track wheels, and shall be attached to the trolley or the bridge and frame. They shall be of a shape and form that will tend to push and raise a man's band, arm, or leg off the rail and away from wheel.
34. Heavy safety lugs or brackets shall be placed on trolley frames and bridge end carriages, to limit drop to one inch or less if a wheel or axle should break.
35. A capacity plate showing the maximum capacity of each hoist in pounds shall be placed on each crane girder in such a manner as to be clearly legible from the floor.
36. A metal tool box or receptacle shall be permanently secured in the cage or on the runway for the storing of oil cans, tools, etc.
37. The trolley should be completely floored.
38. Cranes in outside service shall have the following additional provisions:
 - (a) Floors of footwalks shall be so constructed as to provide proper drainage.

- (b) The cage shall be enclosed and of fire-resisting construction; there shall be windows on three sides of the cage, and windows in the front and the side opposite the door shall be the full width of the cage.
- (c) The floor of the cage on outdoor cranes should be extended to an entrance landing which shall be equipped with a handrail and toeboard of standard construction.
- (d) Where there are no members over the crane suitable for attaching blocks for repair work, a structural-steel out-rigger should be arranged on the crane of sufficient strength to lift the heaviest part of the trolley.

39. All gantry cranes should be equipped with automatic warning signals.

40. The truck wheels of gantry cranes shall be provided with guards or fenders.

Operation of Cranes

Rules for Operators

101. Cranes shall be operated only by regular crane operators, authorized substitutes who have had at least two weeks' experience and training under the supervision of a competent operator, crane repairmen, or inspector; no one else should enter a crane cage.



HOIST—Make small horizontal circles with the hand, holding the forearm in a vertical position and forefinger extended.



RACK—Jerk hand in direction of racking, with arm extended, hand just above hip, fingers closed, thumb extended horizontal.



STOP—Hold position rigid, with arm extended and hand level with the hip.



LOWER—Wave forearm downward with arm extended, hand below the hip and palm downward



TRAVEL—With forearm vertical and hand open with palm in direction of travel, wave forearm in direction of travel



EMERGENCY STOP—Move hand quickly to right and left with arm extended, hand level with the hip

Illustrated Code of Manual Signals for Crane Operation

102. Hands shall be kept free when going up and down ladders. Articles which are too large to go into pockets or belts should be lifted to or lowered from crane by hand line (except where stairways are provided).

103. Cages shall be kept free of clothing and other personal belongings. Tools, extra fuses, oil cans, waste, and other articles necessary in the crane cage shall be stored in a tool box, and not left loose on or about crane.

104. The operator shall familiarize himself fully with all crane rules and with the crane mechanism and its proper care. If adjustments and repairs are necessary, he shall report the facts at once to the proper authority.

105. The operator should not eat, smoke, or read while on duty nor operate the crane when he is physically unfit.

106. The operator or some one specially designated shall lubricate all working parts of the crane.

107. Cranes shall be examined daily for loose parts or defects.

108. Cranes shall be kept clean.

109. Operators shall avoid, as far as possible, carrying loads over workmen; this must be absolutely avoided when carrying molten metal or when using a magnet.

110. Whenever the operator finds the main or emergency switch open, he shall not close it, even when starting on regular duty, until he has made sure that no one is on or about the crane, and he shall not oil or repair the crane unless the main switch is locked open.

111. Before closing the main switch, the operator shall make sure that all controllers are in "OFF" position.

112. If the power goes off, the operator shall immediately throw all controllers to "OFF" position until the power is again available.

113. When leaving the cage, the operator shall throw all controllers to "OFF" position and open the main switch.

114. The operator should not reverse a motor until it has come to a full stop, except to avoid accidents.

115. The operator shall pay special attention to the block, when long hitches are made, to avoid tripping the limit switch or running the block upon the drum.

116. The operator shall recognize signals only from the one man who is supervising the lift. Operating signals should follow an approved standard; they should be manual, never verbal. Whistle signals may be used where one crane only is in operation.

117. Before starting to hoist, the operator shall place the trolley directly over the load to avoid swinging it when being hoisted. This precaution is especially important when handling molten metal.

118. The operator shall not make side pulls with the crane except when especially instructed by the proper authority.

119. When handling maximum loads, particularly ladles of molten metal, the operator shall test the hoist brakes after the load has been lifted a few inches; if the brakes do not hold, the load should be lowered at once and the brakes adjusted or repaired.

120. Bumping into runway stops or other cranes shall be avoided. When the operator is ordered to engage with or push other cranes, he shall do so with special care for the safety of persons and cranes.

121. When lowering a load, the operator shall proceed carefully and make sure that he has the load under safe control.

122. If the crane is located out of doors, the operator shall

also lock the crane in a secure position to prevent it from being blown off or along the track by a severe wind.

123. No person shall be permitted to operate a crane who cannot speak and read the English language, or who is under eighteen (18) years of age.

124. No person shall be permitted to operate a crane whose hearing or eyesight is defective, or who is suffering from heart disease or other ailments that might suddenly incapacitate him. A physical examination is required at least once each year.

Rules for Floormen

201. Floormen shall give all signals to the operator. Signals preferably manual should conform to the illustrated code given in Fig. 1.

202. Floormen shall be responsible for the condition and selection of all hoisting accessories and for all hitches and slings.

203. Before the operator moves a crane upon which an empty chain sling is hanging, the floorman should hook both ends of the sling to the block.

204. Floormen where necessary should walk ahead of a moving load and warn people to keep clear of it. They shall see

that the load is carried high enough to clear all obstructions. Permanent high obstructions should be distinctively painted or otherwise marked.

205. Floormen shall notify the foreman in advance when an unusually heavy load is to be handled.

206. Floormen shall not ride or allow others to ride on the hook or load.

Rules for Repairmen

301. Repairmen should have a crane that is to be repaired run to a location where the repair work will least interfere with other cranes and with operations on the floor.

302. Before starting repairs, repairmen shall see that all controllers are thrown to "OFF" position; that main or emergency switches are opened; one of these shall be locked.

303. Repairmen shall immediately place warning signs or "OUT OF ORDER" signs on a crane to be repaired and also on the floor beneath. If other cranes are operated on the same runway, they should also place rail stops at a safe distance or make other safe provision.

304. When repairing runways, repairmen shall place rail stops and warning signs or signals so as to protect both ends of the section to be repaired.

305. Repairmen shall take care to prevent loose parts from falling or being thrown upon the floor beneath.

306. Repairs shall not be considered complete until all guards and safety devices have been put in place and the block and tackle and other loose material have been removed.

Hand-Power Cranes

Hand-power traveling cranes are particularly applicable to light or infrequent service in foundries, machine shops, engine rooms and other places where speed of operation is not required.

The bridge of such a crane generally is constructed either of a single or a double standard I-beam girder, or a special Bethlehem beam. A single-web or a box-girder bridge is used for some cranes of this type when designed for special heavy service. The bridge is mounted on two-wheel end trucks propelled by means of gears attached to one wheel or to an axle extension on each end truck and to the squaring shaft. The power is applied by means of an endless chain running over a sheave usually keyed to the squaring shaft or in some cases, to a separate sheave shaft, and is operated by hand from the floor.

Single Girder Cranes

On single girder cranes, the trolley either has only two wheels and travels on top of the beam or has two or

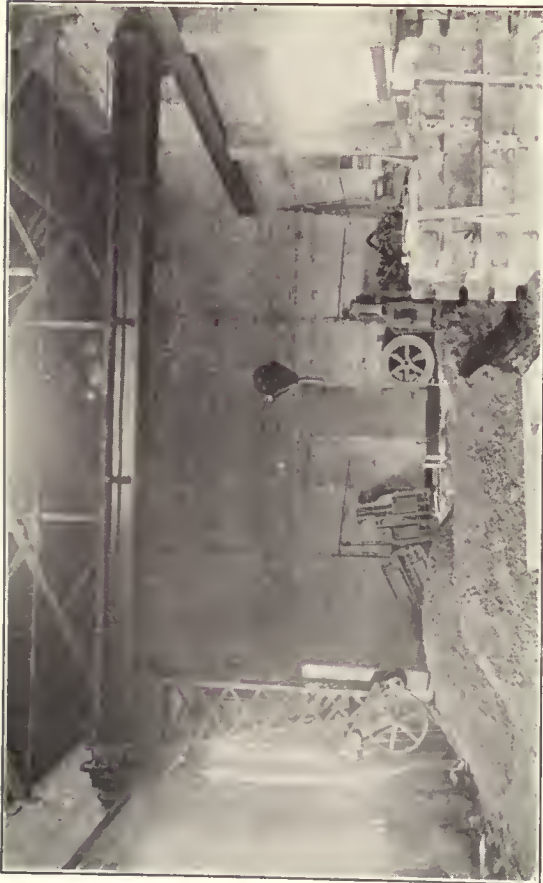

Floor-Operated Hand-Power Overhead Traveling Crane with Pendant Frame for Hoisting and Trolley Racking Mechanism

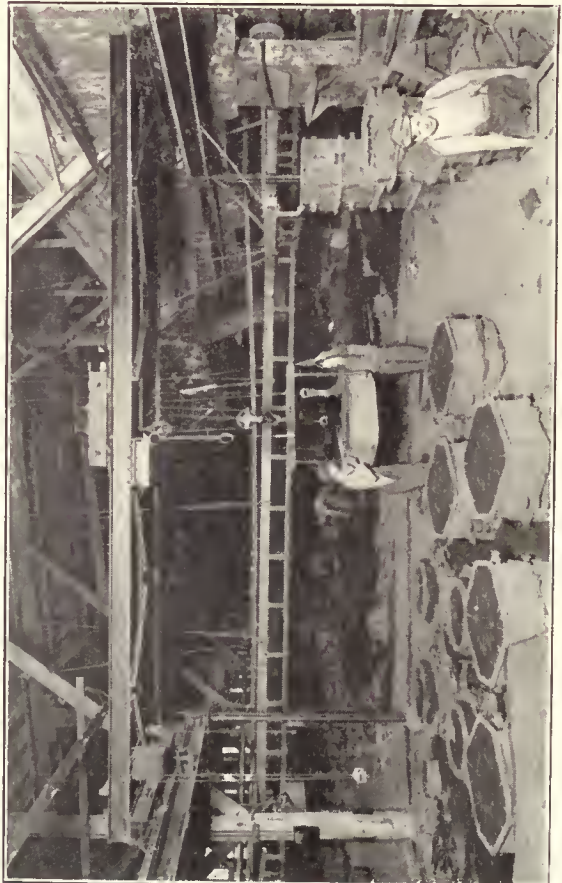

Floor-Operated Electric Overhead Traveling Crane Equipped with Foundry Control for Handling Molds

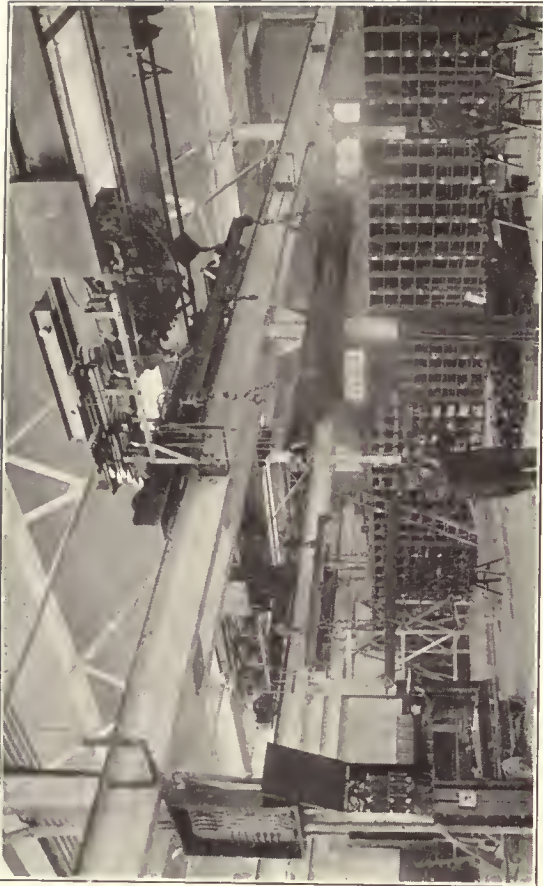

Floor-Operated Electric Overhead Traveling Crane Equipped with Spreader Bar for Handling Long Material



Floor-Controlled Electric Overhead Traveling Crane Equipped with Fall-Block and Grab Hooks for Handling Steel Rolls

more wheels on each side of the beam and travels along the lower flange of it. Usually the trolley is equipped with gearing and is propelled across the bridge by means of hand chains, but on some cranes of very light capacity the trolley is a simple traveler and is moved by pulling or pushing on the load.

The hoisting apparatus on hand-power cranes of the lightest capacities usually consists of a chain block or hoist which may be permanently attached to the trolley or may be suspended from it by a hook. Air hoists are sometimes used but the difficulty of protecting a flexible air line makes this objectionable for a traveling crane. The bridge may be wired and an electric hoist used on these cranes, the hoist being either suspended from the trolley, or permanently attached to it.

The span and capacity of single girder cranes is limited and they seldom are installed where a span of more than 30 ft., or a capacity of more than 10 tons is required. A crane of this type, equipped with a hand chain bridge drive and a chain hoist, may be utilized in foundries for handling flasks, in machine shops for handling heavy parts, or in any other light intermittent service in industrial plants or in power plants.

When the headroom is limited, a crane of the under-slung type may be used. On a crane of this design, the bridge is suspended from four-wheel trucks which travel on the lower flanges of an I-beam runway. The squaring shaft may extend through the truck side frames and form the axle for one wheel on each truck. It usually is propelled by a hand chain drive, and equipped with a chain driven geared trolley hoist and can be used in any light service.

Two-Girder Cranes

On hand-power cranes of two-girder bridge construction, the trolley is a carriage or truck of the four-wheel type traveling directly on top of the beams or on T-rails laid on the beams. Such trolleys are equipped with a hoisting drum connected with a series of gears and are operated from the floor, by means of an endless chain. Other trolleys of this type are provided only with means of traversing the bridge and are equipped with an ordinary chain block suspended from it by means of a hook; or with an electric hoist controlled from the floor; or with an air hoist.

When hand-power cranes of this type are to be used where the headroom is limited the bridge is either under-slung on the end trucks or the operating gear is attached to the bridge at one end and the crane is operated by chains or by hand cranks located in a suspended cage or cab. In such designs the hoisting rope passes over guide sheaves on a plain trolley which is racked across the bridge by means of chain gearing operated by hand power installed at a convenient point.

Other cranes of this type have a side platform, extending the full length of the bridge, from which the crane is operated by means of hand cranks.

Another method of operation is to install the hoisting mechanism on a pendant structural frame within reach on the floor and to operate it by hand cranks.

Two-girder hand-power traveling cranes range in capacities up to 30 or 40 tons and to about 60 ft. span, but when a considerable amount of work is to be done and electric current is available, it is advisable to install a crane with complete electrical operation for service heavier than about 10 tons. The greater speed of operation thus obtained will result in more efficient service.

The approximate relative proportions of two-girder hand-

power overhead traveling cranes as determined by good engineering practice are given in the following table:

HAND-POWER CRANES				
Capacity, Tons	Span Ft. In.	Max. wheel load (lb.)	Weight of rail (lb.)	Girder
5.....	30 0	8,000	25	Beth beam
5.....	60 0	10,600	25	Single web girder
10.....	30 0	13,500	30	Beth beam
10.....	60 0	16,000	30	Single web girder
15.....	30 0	19,600	40	Beth beam
15.....	60 0	23,000	40	Single web girder
20.....	30 0	24,600	50	Beth beam
20.....	60 0	28,500	55	Single web girder
25.....	30 0	31,300	55	Beth beam
25.....	60 0	33,800	60	Single web girder
30.....	30 0	37,500	60	Beth beam
30.....	60 0	40,000	60	Single web girder

Power-Operated Overhead Cranes

The use of electrically operated overhead traveling cranes has become quite general and where electric current is available other power rarely is used. Such cranes are made in capacities ranging upward to more than 400 tons and when a considerable amount of work is to be done they are preferable to hand-power cranes. They are made in two types, the floor-controlled type in which the motors are controlled from the ground by means of pendant control cords; and the cab-controlled type having the various switches and controllers installed in the operator's cab.

Floor-Controlled Type

When the distance which the load must be moved is not great, a floor-controlled crane may be used to advantage. The operator, being on the ground near the work, can move the load as desired without recourse to signals and, where constant service is not required, the crane can be operated by anyone engaged in the work in progress, thus eliminating the expense of having a special crane operator. For some classes of work requiring very careful handling, such as moving and placing molds in a foundry, a floor-controlled crane—having the foundry-control feature—is preferable to a cab-controlled crane.

This type of crane may be of the single girder type with the bridge motor installed at one end of the bridge or in the center and controlled from the floor. The trolley usually is of the four-wheel type having roller bearings and running on the lower flanges of the I-beam girder. It may be propelled across the bridge by hand or be operated by electric power. An electric hoist may be connected to the trolley and operated from the floor by means of the pendant controller cords.

Another modification of the floor-controlled type of crane has a controller platform suspended near the center of the bridge, with pendant controller cords, the operator walking underneath alongside of the work. Such a crane can be utilized for handling steel parts, or iron castings; for handling shop equipment; or in any other similar service.

Cab-Controlled Type

Electric overhead traveling cranes of medium and heavy capacities generally are equipped with an operator's cab suspended from the bridge, usually at one end, though sometimes located near the center. The various switches and controllers are installed in the cab within easy reach of the operator. Three-motor cranes are most commonly used but for special requirements as many as eight motors are installed.

A cab-controlled electric overhead crane designed for light work is useful in the core room of a foundry. A crane for this purpose may be made with a girder consisting of a single I-beam having a short span and a capacity of about 2 tons. The bridge motor may be carried at the

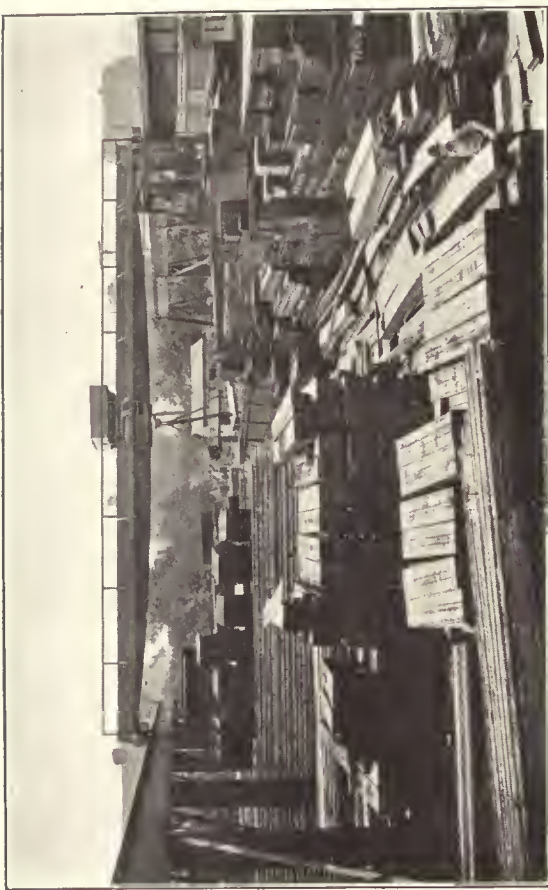

Cab-Operated Electric Overhead Traveling Crane Equipped with Fall-Block and Slings for Handling Long Materials in a Structural Steel Storage Yard



Cab-Operated Electric Overhead Traveling Crane Handling Block Stone with Chain and Grab Hooks



Cab-Operated Electric Overhead Traveling Crane in Foundry Yard Handling Heavy Casting with Electric Lifting Magnet



Electric Overhead Traveling Crane Having Truss-rod Type of Bridge and Controlled from Traversing Cab, Handling Stone Slab with Chain Sling

center of the girder and the trolley and hoisting motors on the lower flanges of the beam. The cab may be suspended from the bridge girder and supported by a channel which may extend across the crane span and also serve to brace the truck frame.

A crane constructed in this manner is especially adapted for use in a room having a low ceiling. When equipped with a foundry controller it is specially suited to work requiring careful handling to avoid the breakage that would be caused by jerky starting or stopping. A crane of this type may be used for light work in a warehouse or in a manufacturing plant making small or fragile wares.

A heavier capacity crane of this type equipped with foundry control is used in many foundries for handling large molds. This type of crane operates at very slow speeds and with the foundry control feature permits the handling of fragile molds without excessive breakage.

Overhead traveling cranes of the three-motor type are used for many other purposes in both indoor and outdoor work. A 2-ton capacity crane of this type installed in the warehouse of a paper mill will handle the bales of rags or old paper used in paper manufacturing and also the rolls of finished paper in storage. For this service all of the gears should be enclosed in dust and oil-proof gear cases, thus protecting the machine itself and preventing oil drippage from damaging the material being handled.

A crane of this type equipped with an automatic grab-bucket may be used for handling loose materials such as fertilizer, or for handling hot cement from the kiln into storage for cooling. In one cement mill installation an 80-ft. span, 10-ton capacity crane operating on a 250-volt direct current and equipped with a 3-yd. capacity bucket, handles seven tons of cement in two minutes.

A special adaptation of the overhead electric traveling crane to indoor service is used for roundhouse work in railroad service. In this design the crane travels on a runway, the outer track of which has a greater radius than the inner track. The truck wheels are set radially and as the pinion at the outer truck has more teeth and the gear less teeth than those at the inner truck, the circumferences of the truck wheels have a speed proportionate to the track radii. Where overhead conditions will permit and the size of the roundhouse or the volume of work to be done will warrant, such a crane will be found useful in railroad work. It not only will reduce the manual labor required, but will facilitate repair work, thus increasing the service secured from a locomotive.

Outdoor Service

For outdoor service, the overhead crane is mounted on a special elevated structure. Usually the operator's cab is enclosed to protect the operator from the weather and the crane trolley is housed to prevent deterioration of the trolley machinery. Such cranes are equipped with a hook or sling, or an automatic grab bucket, or a magnet, and are used in structural steel yards, in lumber and other storage yards, and for handling coal, coke, crushed stone or similar material. When equipped with a magnet it will handle steel rails, plates or bars, or scrap metals in foundry or railroad yards. Equipped with a hook and sling, it may be used for transferring large containers or heavy, bulky freight or in other similar service. This type of crane permits the rapid handling of heavy and bulky packages and, where the volume of work to be done is in sufficient quantities, is an economical installation.

In mill work, in lumber yards, or any other service where large numbers of long pieces are handled, a crane having two trolleys on the bridge can be used advantage-

ously. The two trolleys may have individual control and may be traversed over the bridge to any position suited to the length of the material being handled. Other cranes designed for similar work sometimes are equipped with trolleys provided with two hoisting drums and two hooks which may be arranged to operate parallel to or at right angles to the bridge girders.

It sometimes is desirable to handle extremely long material with a crane having only one hoisting drum and only one hook. For such service, a spreader bar is used. This bar, having slings at the ends and being suspended at the center from the hoist hook, not only permits the raising of long pieces, but, by using a block with a swivel hook, also permits the turning of the load when necessary. Cranes thus equipped are useful in structural steel yards or can be adapted for use in lumber yards for handling long timbers or poles.

Another method of handling long metal pieces in the yard of a steel mill is to equip each crane with two magnets installed on a spreader bar. These cranes will handle rails in large volume, the magnets on each crane having a capacity of about 20 tons. A yard equipped with cranes of this kind can handle thousands of tons in a day.

The overhead traveling crane is often used to handle fuel at a power house. Such a crane may have a span of 100 ft. or more and will handle coal direct from the car to a traveling scale hopper, where it can be weighed and then dumped from the hopper, through a hatchway in the roof of the power house directly into the coal bunkers; or the coal may be transferred from the cars to storage and later from storage to the weighing hopper and the bunkers.

An overhead crane designed especially for light work is an efficient equipment in a structural steel yard. A crane for this service may be equipped with the usual bridge drive operated by a motor installed on one of the girders but, instead of a crane trolley as generally used on cranes of this type, may be equipped with two cab-operated monorail hoists. These hoists traverse the bridge on rails installed on each side of the bridge girders. They may be operated independently of each other, and, if desired, the monorail track can be latched to an outside spur track on either side of the crane trestle and one or both of the hoists may be run off the bridge and used on a shop line, as well as in the yard. This arrangement provides a mobile equipment and eliminates much of the idle time of a crane serving only a limited area.

A combination of an overhead traveling crane and a revolving jib crane is used in British practice. This crane has a traveling bridge propelled in the usual manner by a squaring shaft, but, instead of the trolley generally used on an overhead crane, a revolving jib of the lattice type of construction is suspended from the bridge. This jib is pivoted on the bridge and is revolved by means of a pinion on a shaft secured to the jib structure and meshing with a large circular rack on the underside of the bridge. The advantage of this type of construction is that the jib may be revolved so that the load can be picked up or deposited beyond the limits of the bridge runway; the jib may be projected into an adjacent building, or under a low roof or ceiling where the runway cannot be extended. This type of crane is electrically operated and is controlled from an operator's cab suspended from the revolving jib.

Foundry and Steel Mill Service

The handling of molten and solid metals in steel plants and iron foundries and in other metal industries, enters into the problem of material handling to an extent that

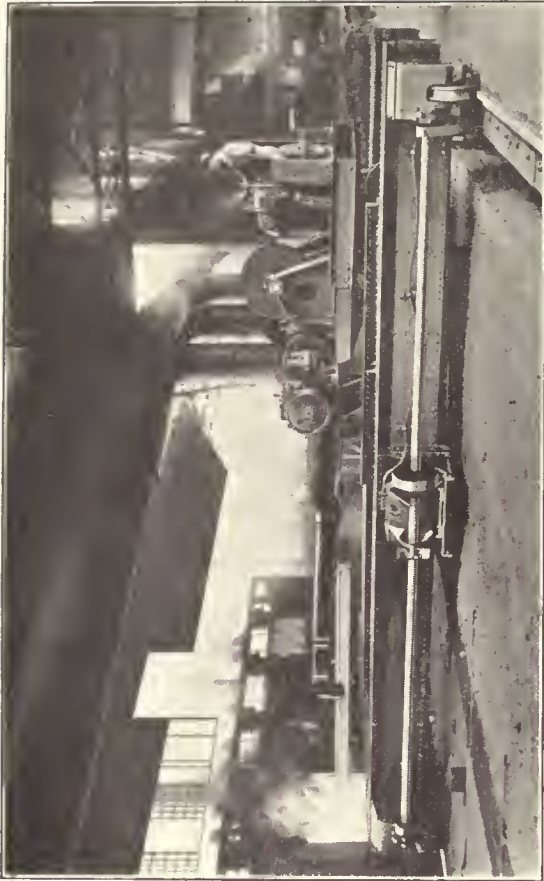

Floor Type Electric Charging and Drawing Machine for Handling Billets, Blooms or Slabs

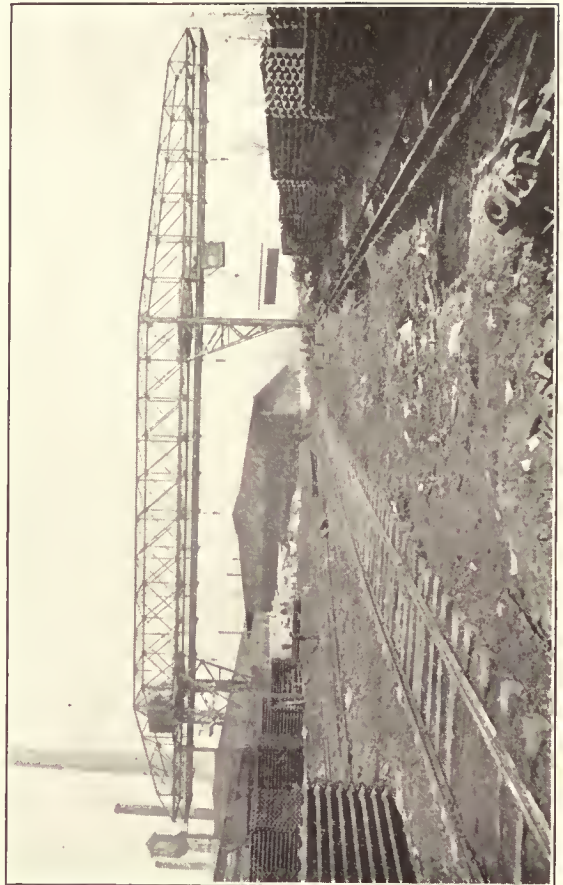

Double Cantilever Electric Traveling Bridge Crane Equipped to Handle Long Materials in Storage Yard

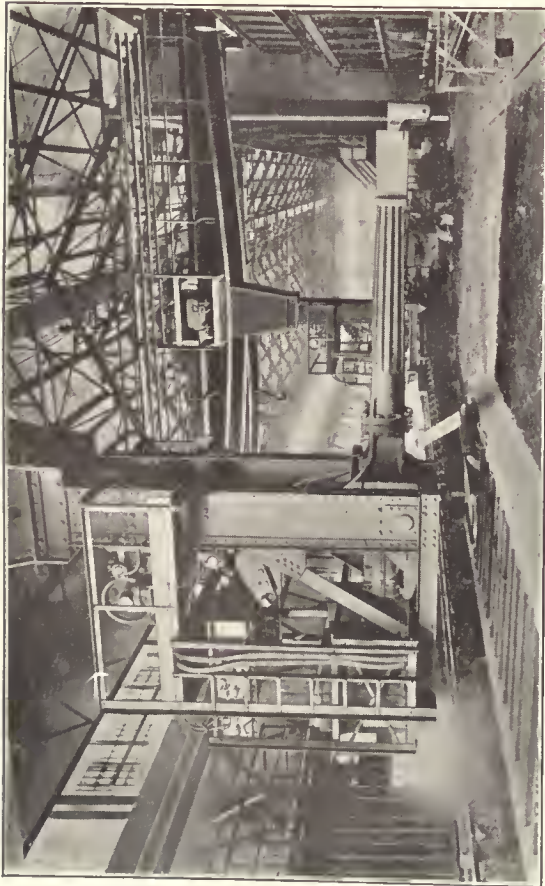

Six-Motor Revolving Slab and Ingot Charging Machine Designed for Elbow Motion and Sidewise Grip

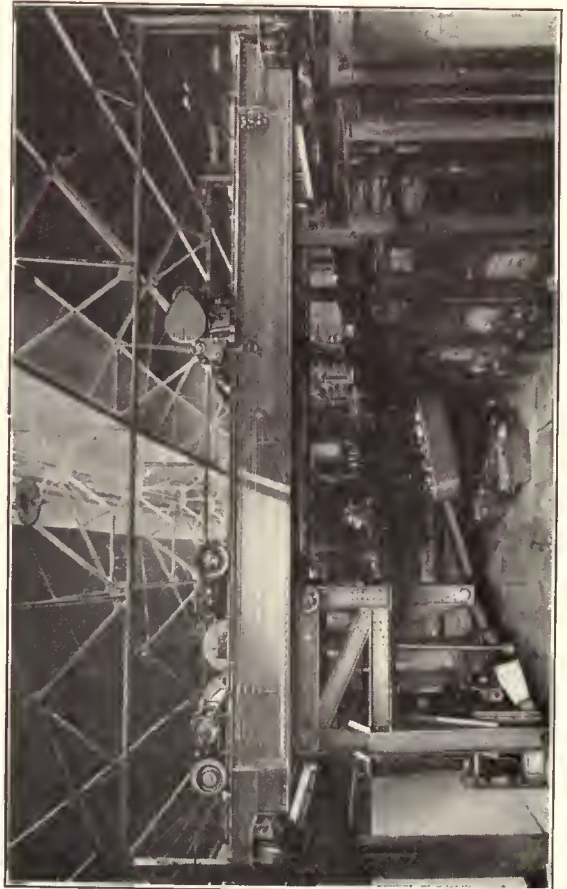

Electrically Operated 2½-Ton Capacity Melting Furnace Charging Machine Installed on a 5-Ton Capacity Overhead Traveling Crane

warrants attention to this phase of the subject. The manufacture of metal products reaches millions of tons each year and the methods employed to handle this vast amount of material require the use of the overhead traveling crane more than of any other type of hoisting or conveying machine.

Ladle Crane

The electric overhead traveling crane is adapted to handling ladles of molten metals in iron and steel production. A typical crane of this type for service in a large foundry or mill consists of a 4-girder, 8-motor ladle crane of 175 tons capacity. It has a span of 58 ft. 9 in. and is equipped with two trolleys. The auxiliary trolley has a capacity of 40 tons, and it has an auxiliary hoist of 15 tons capacity, thus providing two hoisting hooks in addition to the double-ladle hook on the main trolley. This ladle crane has a lift of 30 ft. and is equipped with a low hanging cab enclosed so that the operator has full view of the work but is protected from possible injury during operation. A crane of this type will safely handle ladles containing 25 tons or more of molten metal and will expedite the pouring of large quantities of metal into molds.

Ingot Charging Cranes

After casting an ingot in steel production, a charging and extracting crane is used to place the ingot in a soaking pit or furnace. Ingot charging cranes are of the overhead type and are equipped with tongs operating vertically. The tongs are operated by an electric motor and they grip and hold the ingot while it is being lowered into the soaking pit chamber, or being extracted from it. The charging apparatus, with the operator's cab, may be of the tower type built of structural steel and mounted on the crane trolley with only the tongs extending below the bridge; or the tongs' operating mechanism and the operator's cab may be suspended from the trolley and travel underneath the bridge, the hoisting mechanism being installed on the trolley as in other types of overhead cranes. Cranes of this type may also be equipped with an auxiliary trolley having a hoist which may be used to handle the furnace doors or they may be used for other work adjacent to the furnaces.

Ingot Stripping Cranes

Overhead cranes equipped with special apparatus are also used for stripping ingots from their molds. As in other cranes of the overhead type, the bridge and the trolley travel and the hoisting operation is accomplished by means of electric motors, but the stripping operation is effected either by means of screw and pinion gearing or by hydraulic pressure supplied by an electrically operated pump. For this service, the crane is installed on a runway in a convenient location and the ingots, while still in their molds, are brought within range on special trucks. The stripping apparatus, which projects below the crane bridge, consists of tongs or links so designed as to grip and hold the mold while an arm, or plunger, pushes the ingot downward, thus stripping the mold from the ingot. This stripping apparatus is made either with a single stripper or with a double stripping mechanism which may be operated to strip two ingots from their molds simultaneously.

This type of crane may be constructed with the stripper mounted on the crane trolley, only the tongs and the plunger housing extending below the bridge, or the entire stripping apparatus may be suspended from the trolley

and travel underneath the bridge. The stripping operation is performed in a similar manner with either type of stripper.

Slab Charging Cranes

A revolving apparatus installed on an overhead crane has been adapted to steel mill work for charging slabs, billets, blooms, or ingots into the furnace when reheating them for the forging or rolling operation. This machine has the charging mechanism suspended from a trolley, which traverses the crane bridge in such a manner that it may be revolved as the work requires. The charging arm of this machine is hinged to and projects from the base of this revolving structure which also carries the motors necessary to operate the charging mechanism and the operator's cab as well. The hinge pin permits a practically vertical movement of the end of the charging arm, which also has side grips, having a sidewise motion, at the outer end. This enables the machine to pick up a slab or other similar pieces of metal within the radius of the charging arm and the span of the bridge. In general practice, the metal to be handled is brought within range on trucks or cars and is picked up by the charging arm. The apparatus then is revolved so that the arm is pointing toward the furnace and the trolley is traversed over the bridge, thrusting the arm into the furnace and depositing the metal in the fire. The side grips then are released, the trolley travel reversed, and the charging arm withdrawn from the furnace. This machine can also be utilized to withdraw the metal from the fire by reversing the operation.

A charging crane of this type installed in one mill has a span of 54 ft 8 in and a capacity of 5 tons. Six motors are employed to operate the crane; one to propel the bridge; one to traverse the trolley; and the others to operate the charging mechanism.

A floor type of charging and drawing machine operating in a similar manner is used in the same service. On this machine the revolving charging mechanism is mounted on top of the crane bridge which travels on a track laid on the floor. The same type of hinged charging arm with side grips is employed to handle the metal. A slab, bar, or other similar piece is picked up while the charging arm is at right angles to the crane bridge, the apparatus then revolved so that the arm is parallel with the bridge girders and the entire charging mechanism then traversed over the bridge, thrusting the arm into the furnace and depositing the metal in the fire. The metal can be withdrawn from the furnace by reversing the charging operation. An advantage of the floor type is that an overhead traveling crane can be installed above it and be used for other purposes.

On another type of overhead crane adapted to charging or withdrawing slabs or similar pieces, the revolving charger operates in a similar manner, but instead of the hinged charging arm, has guides, in which the arm is raised or lowered in a vertical line, on the inside of the lower portion of the pendant structure. The outer end of the charging arm is fitted with end grips instead of side grips but otherwise operates in a similar manner.

Other Mill Service

Many other adaptations of the traveling crane to the metal industries have been made. These cranes are designed with either the overhead bridge or are of the floor type. They are used extensively in open-hearth plants for placing the melting stock into the furnace. In such service,



Overhead Traveling Crane Equipped with Automatic Grab Bucket for Handling Loose Materials



Traveling Wall Jib Crane Installed in a Foundry for Handling Molds



Overhead Traveling Crane Equipped with Automatic Grab Bucket for Handling Coal at a Power House

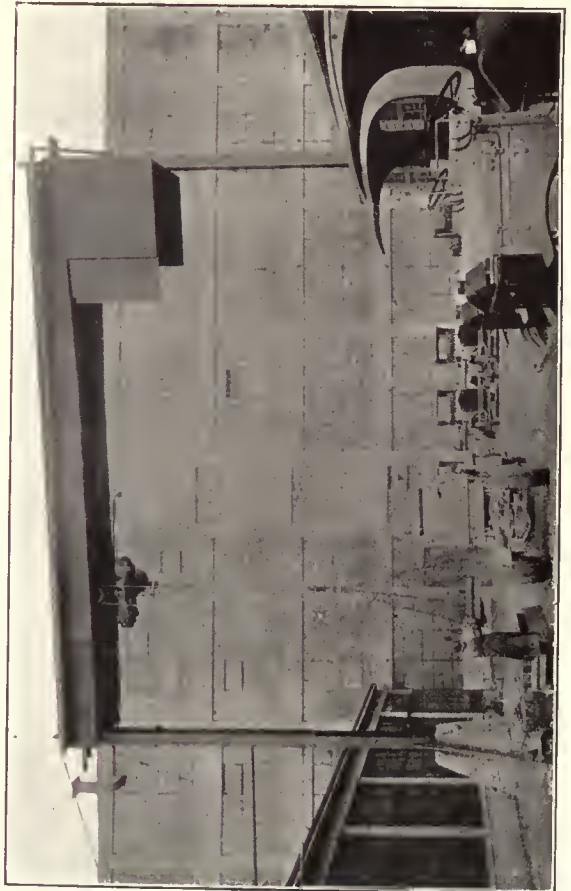

Stationary Gantry Crane Equipped with Floor-Controlled Electric Hoist

the metal is placed in a rectangular container having the end designed to engage the end of a revolving charging arm which extends toward the furnace. By means of the traversing mechanism, the charging arm is thrust into the furnace and the metal is deposited by revolving the charging arm and overturning the container. A crane of this type has a charging capacity of from 2½ to 5 tons and usually is also provided with an auxiliary trolley.

Other similar cranes are designed to manipulate hot metals in the forging shop and to handle copper and other materials during the manufacturing processes. However, as these cranes are modifications or combinations of the machines already described and are of a highly specialized nature, they do not enter into the discussion of material handling in the commonly accepted meaning of the term and will not be treated in this book.

Traveling Bracket or Wall Jib Cranes

Traveling bracket or wall jib cranes may be used as auxiliaries to overhead traveling bridge cranes, or may be installed as separate shop equipment. These cranes are used largely in foundries or machine shops or in erection shops and, within the limits of the jib and the range of travel, serve for many of the same purposes as a crane of the bridge type. They may be installed under an overhead crane to handle the lighter work; or may be installed in a group or series along the wall of a shop and used to handle work too heavy for manual labor.

The general form of construction consists of a single or double girder jib supported by a wall frame or vertical truck which is provided with a top and a bottom set of wheels—usually four wheels—traveling in a runway secured to a side wall or to a row of columns supporting the shop building. The jib may be top braced or bottom braced as in the construction of an ordinary jib crane but it is fixed rigidly to the wall frame and has no circular motion. A crane trolley is mounted on the jib.

The crane travel mechanism may be hand operated and a chain hoist, an air hoist or an electric hoist used for lifting purposes, but usually the entire apparatus is operated by electric power—generally three-motor operation—controlled from a cab secured to the crane structure.

These cranes are made with jibs ranging in length upward to 30 ft. and having capacities up to about 10 tons.

Other types of jib cranes are described elsewhere in this book.

Gantry Cranes

The gantry crane is an adaptation of the overhead type of crane to outdoor service where there is no permanent elevated structure on which to install a crane. The crane bridge is fixed on trestles having legs which generally are mounted on trucks similar to those used on overhead traveling cranes. The crane is then known as a traveling gantry. Sometimes the trestles are fixed on a solid foundation and the crane is then called a fixed or stationary gantry, being also frequently referred to as a bridge crane or a transfer crane. To meet special operating conditions, they are sometimes constructed with one gantry leg—the other end of the bridge being supported by other means; with a single or double cantilever bridge; or with a movable cantilever at one end.

These cranes are made with a span upward to 200 ft. or more and are used in storage yards and at docks for handling ore, coal, coke, cement, or manufactured materials; in railroad storage and transfer yards, for general purposes and for transferring heavy freight; and at wharves

for handling cargo. They also are used extensively in shipyards for erecting purposes and for ship fitting work.

Traveling Gantry Cranes

Traveling gantry cranes vary from a light portable structure mounted on small wheels and operated by hand, to numerous designs of electrically operated structures equipped with crane trolleys and carried on trucks of substantial construction.

Construction

The construction of the bridge girders and the trolleys should conform to the standards for overhead traveling cranes. The trestles are carried on trucks resting on tracks laid on the ground or on platforms. They should be of a substantial type of construction, adequately braced and fixed to the bridge in such a manner as to insure a structure of ample strength to withstand the twisting strains and the stresses of operation under the maximum load.

The trucks, which generally are similar in construction to those used on the overhead type of crane, should be mounted on axles of ample sizes and in suitable bearings to sustain the combined weight of the gantry structure and the load to be carried. For cranes of the lighter capacities—up to about 30 tons—the truck axles and bearings may be of the pin and keeper type, but for cranes of heavier capacity the M. C. B. type is preferable.

The Drive

The small portable types of gantries are generally pushed or pulled by hand but some form of power must be employed to propel the larger gantry structures.

The most common type of drive is similar to that used on overhead cranes. A squaring shaft, driven by a motor installed on the bridge, is provided with bevel gears at each end which mesh with similar gears on two vertical drive shafts—one on each side of the gantry trestle. Bevel gears on the lower ends of the vertical drive shafts mesh with gears attached to the truck wheels.

A type of drive used on many of the largest gantry cranes consists of motors geared direct to the truck axles. On cranes of very heavy capacity this method of driving is preferable to the squaring shaft method, as the torsion on a short shaft is negligible.

Another type of drive often employed on heavy gantry cranes consists of cables, secured at the ends of the gantry track and wound on motor driven drums carried on the gantry trucks. The crane structure is pulled along the tracks by winding the cables.

To insure uniform travel of the gantry structure each end is provided with independent clutches and controllers. This permits the operator to control the movement of both ends of the structure and, if necessary, one end may be locked and held stationary while the other end is moved slightly to bring it into alinement. This is possible because of clearance between the rails and the wheel flanges.

Electricity is commonly used on power operated gantry cranes to operate the bridge drive, the trolley and the hoisting drums. The current is conducted to the crane motors from wires installed on poles or on other structures near the gantry tracks. Current collectors, secured to an arm projecting from the bridge, insure a contact with the circuit as the structure travels along the track. A sliding shoe or other type of collector is used.

Hand-Operated Type

A hand-operated portable gantry crane is useful when only occasional light service is required. A crane of this



Electric Traveling Gantry Crane with Folding Jib, Handling Asphalt with Turnover Bucket



Electrically Operated Double Cantilever Traveling Gantry Crane Designed to Handle Material from Vessel or to Railroad Cars



Single-Leg Traveling Gantry Crane Equipped with Cab-Controlled Electric Hoist for Handling Structural Steel at Storage Yard



Electric Traveling Ore Bridge Equipped with 5-Ton Grab Bucket to Unload and to Rehandle Ore at a Blast Furnace

type usually is constructed of light structural steel and consists of a single I-beam girder carried on two lightly constructed "A" shaped trestles, resting on two-wheel trucks of the pin-and-keeper type. The gantry is usually mounted on rails and is propelled by pushing it along the track by hand. A hand operated or power operated chain hoist is generally used for hoisting purposes. Cranes of this type may be used in any light service. They are used in trench work for laying sewer pipe or water pipe. For such service a light, portable track is sufficiently substantial. They may be mounted on wheels having a flat tread to run on a floor and used for erecting machinery in fitting out shops or power plants. They range in capacity upward to about 10 tons and have a span of about 25 ft. or 30 ft.

Power-Operated Type

Power-operated traveling gantry cranes are used in outdoor service in many industries. They may be equipped with a hook or a sling and be used for general lifting purposes; with a magnet for handling metals at steel mills or other manufacturing plants, or in railroad service; or may be equipped with a bucket and used to handle coal, ore, or other loose materials. The operation of these cranes is controlled from a cab secured to the bridge or to one of the trestles. They are made with a span ranging upward to about 200 ft. and to 75 tons in capacity.

Two-Leg Type

The two-leg type of gantry is the most commonly used. The crane bridge is mounted on two trestles of equal length and is carried on trucks. This type of structure is generally installed in the storage yards of industrial plants for handling raw materials or manufactured products; at power plants for handling fuel and ashes; in railroad terminals for handling fuel or freight; on wharves for handling cargo; or in various other operations where an overhead traveling crane is not adaptable.

Single-Leg Type

A single-leg gantry frequently is used when it is desirable to install a gantry crane adjacent to a building where the inside leg would interfere with the free movement of materials in the space below or where it would not be practicable to lay rails. This type of crane has the usual trestle support at one end of the bridge and at the other end is supported on a rail or runway installed on a building as in the case of the overhead traveling crane. The advantage of this type of construction is that in cases where the crane travels along the side of a building as on a wharf or at a warehouse having one or more doors giving access to the space immediately underneath the crane there will be no interference due to the trestle obstructing the doors through which it may be desired to move material. Another advantage of this type of construction is that it can be made to span several railroad tracks or a storage yard adjacent to a building without encroaching unnecessarily on the available space.

Cantilever Type

The cantilever type of construction is used to increase the range over which a gantry crane may be operated without increasing the girder span or laying track where it may not be desirable. Such cranes are constructed with a single cantilever or with a cantilever at each end of the bridge. These cantilevers usually are integral with the main bridge span but sometimes are built as a separate structure and hinged to the main bridge at the trestle. This construction allows the cantilever to be raised so that it will clear a

vessel at a wharf, or any other obstruction, while the crane travels along the track.

The cantilever sometimes is constructed so that it may be traversed across the bridge. This permits it to be extended through a doorway into a warehouse or outward over a car or vessel.

The advantage of the cantilever type of crane is that material may be handled from a storage yard to a railroad car or to a vessel without any obstruction of the passages or roadways underneath leaving them free for such traffic as may be required. A crane of this type adds greatly to the storage capacity of a yard and, due to its wide range of action, reduces the time required and the expense of moving materials. Cantilever cranes are made with a total span upward to 250 ft. and in capacities ranging upward to about 50 tons.

Bridge Storage Cranes

The bridge storage crane is a type of gantry crane—usually of the traveling type—constructed in a manner similar to that of an ordinary gantry. The crane bridge generally is constructed in the lattice truss type usually employed in building fixed bridges over a river or a railroad.

They generally are equipped with an automatic bucket—sometimes with a tram-car—and are used to unload ore, coal, sand, gravel and other loose bulk materials from cars or vessels and deposit them in storage bins or piles; in industrial plants for handling various manufactured materials in and out of storage; or are used to rehandle such materials as ore from storage to the furnace. They are especially adapted for use at ore docks in connection with various types of unloading machines.

The bridge storage crane is built primarily to provide a structure that will span a wide area—ranging upward to 300 ft. or more—and permit the use of a bucket or other material handling device. Therefore, a strength of structure is required only sufficient to sustain a light load—usually 5 to 10 tons. The bridge generally projects beyond the supports in a cantilever form. It is carried at one end on sheer-legs similar to a gantry trestle while the other end is supported by a tower. The tower may be in two parts, consisting of an upper "A" form of structure, supported on a four-leg portal carriage designed to span one or more railroad tracks; or may be an inverted tower carried on two trucks similar to those used under the sheer-leg end.

The bridge drive may be of the shaft driven type or of the axle driven type. The operation of the bucket, the crane trolley and the bridge drive is controlled either from an enclosed platform at one end of the structure or may be provided with a traveling cab so that the operator will have a close view of the work being done.

Other forms of bridge cranes are combined with special unloading machines and are described elsewhere.

Stationary Gantry Cranes

The gantry crane sometimes is constructed without means of propulsion and then is known as a stationary or fixed gantry—frequently called a bridge crane or a transfer crane. This type is particularly adapted to railroad service. When installed in a railroad freight yard and spanning one or more tracks, it is used for loading or unloading heavy or bulky freight and for transferring it from a car to a truck or from one car to another for reshipment.

This type of crane also is adaptable to other service where only a transverse travel is required and may be equipped with a hook or a sling for general lifting and

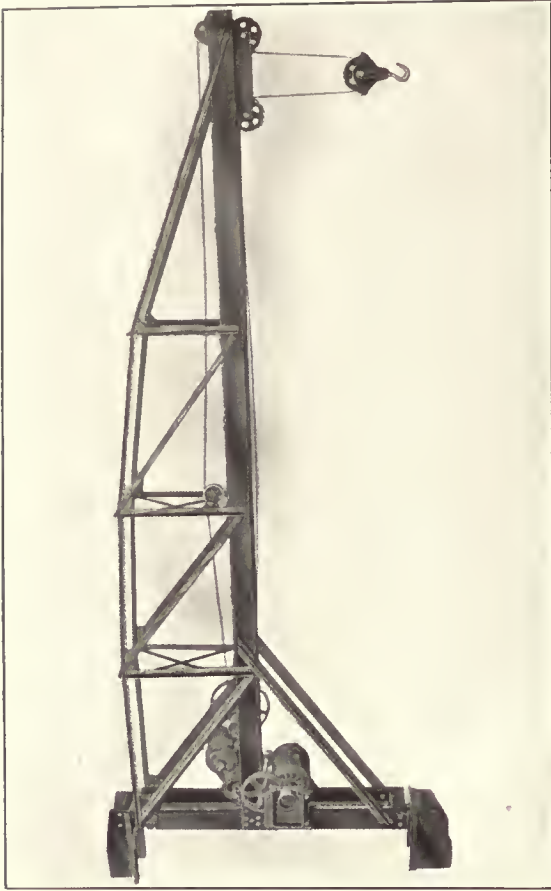

Electric Wall Jib Crane with Trussed Boom

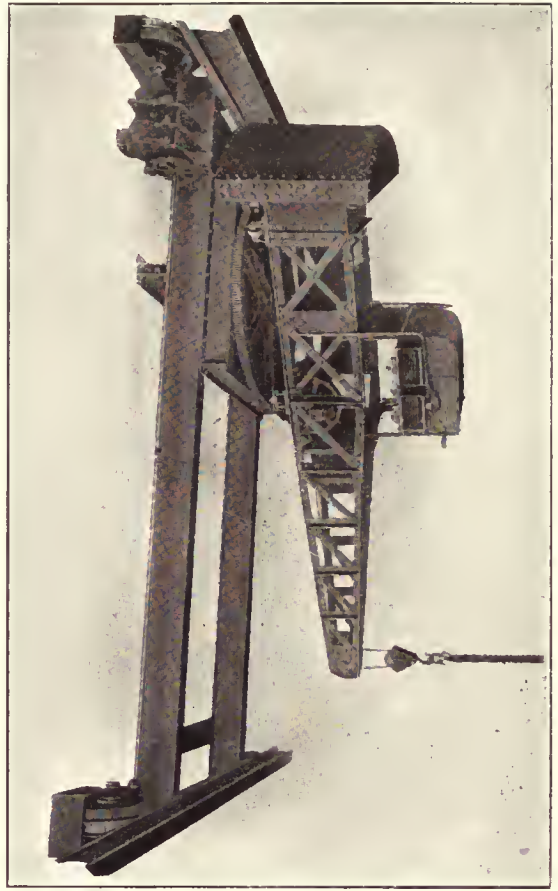

Combination Overhead Traveling Crane and Rotating Jib Crane



Triple-Braced Jib Crane Equipped for Hand Operation

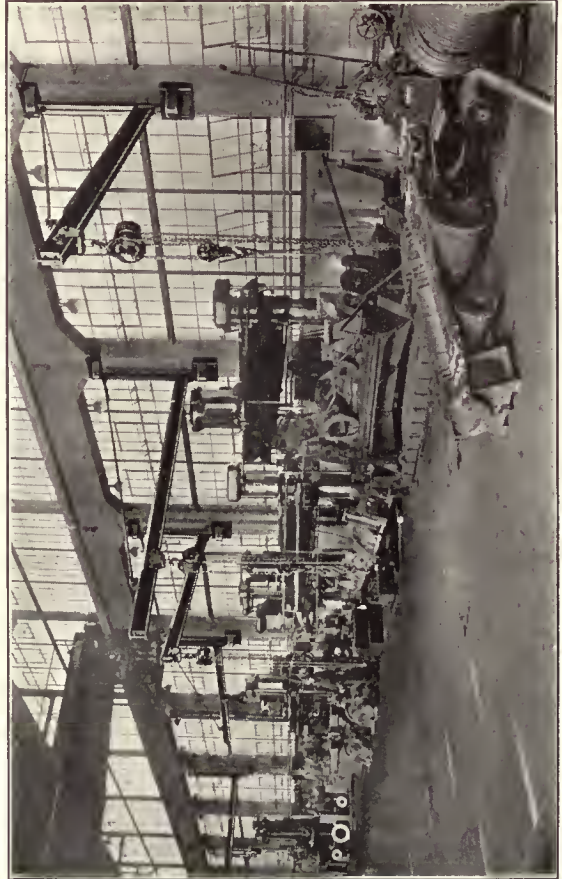

Group of Wall or Bracket Jib Cranes Installed Over Machine Tools for Handling Heavy Parts

transferring; with a magnet and used to handle manufactured or scrap metals; or with an automatic bucket to handle ore, coal, coke, crushed stone, sand and gravel, or other similar materials.

Stationary gantry cranes may be made in practically any capacity and any span desired. The smaller sizes, ranging in capacity up to about 25 tons, generally are equipped with a chain trolley and hoist operated by hand power; or with an electric hoist, controlled from the ground or from a platform on one of the gantry trestles.

A hand-power stationary gantry crane is especially adapted to service in small railroad yards or in industrial works where the volume of heavy objects to be handled is not great and would not warrant the expense of electric equipment. The simplicity of operation and the low cost of maintenance make a crane of this type an economical machine for such service.

An electrically operated stationary gantry crane should be installed when constant service is required or where the weight of the objects to be handled is beyond the capacity of a hand operated machine. A crane of this type installed over one or more railroad tracks and equipped with a hoisting hook or with a sling is especially useful in loading or unloading heavy freight. It may also be equipped for bucket operation and used to handle coal or similar materials when only a transverse movement is required. Generally, cranes of this type are equipped with a trolley having hoisting drums as used on traveling gantries. The operation of the crane is controlled from an enclosed platform on the crane structure.

Wharf Gantries

Many modifications of the gantry structure are used on wharves for handling cargo and in shipyards for construction work. These cranes embody many features of both the jib crane and the locomotive crane. They are described in this book in the chapter on wharf and shipyard cranes.

Jib Cranes

Jib cranes—sometimes called foundry cranes—are made in various designs depending on the service for which they are used. The form of construction generally followed consists of a jib or boom supported in a horizontal position by a short mast or column which is pivoted to permit rotary motion. The jib is sometimes provided with means for a vertical movement as well as the rotary motion. It is also equipped with some form of trolley or traveler from which the hoisting mechanism is suspended. A chain block or hoist; an air hoist; an electric hoist; or, sometimes, a steam-hydraulic hoist is used. This type of crane is known as a wall or post bracket crane; or as a column crane, depending on the means employed to support the jib.

Bracket Jib Crane

The bracket crane is the simplest form of jib crane and consists of a plain jib—usually a straight bar or a small I-beam—fixed to the base of a short mast pivoted in top and bottom brackets secured to a wall or to a post. A tie-rod or truss-rod extending from the top of the mast to the outer end of the jib supports the weight of the crane and the load. In some cases the hoisting apparatus is fixed at the end of the jib but usually a chain hoist, an air hoist, or an electric hoist is suspended from a small trolley which travels on the top of the jib.

A crane of this type rarely has a jib more than 12 ft. or 15 ft. in length or a capacity greater than 2500 lb. to

10,000 lb. Bracket cranes are useful in foundries, machine shops, and in similar places where it is necessary to handle heavy flasks, or heavy castings which could not easily be handled by manual labor. A series of bracket jib cranes arranged along a wall in a foundry or a machine shop so that the effective radii of the jibs will overlap slightly, makes it possible to transfer material from one end of the shop to the other entirely by the use of jib cranes. This arrangement permits the cranes to be used individually or in conjunction with one another and provides a means for transferring material where the amount of such work is not sufficient to warrant the installation of an overhead traveling crane, or when the arrangement of the shop equipment will not permit the use of a portable crane.

A modification of the bracket jib crane provided with wheels and mounted in a side-wall runway is described in the chapter on traveling cranes. The following table gives some approximate proportions of bracket jib cranes:

Capacity, Tons	BRACKET JIB CRANE		Effective Radius	
	Length of Jib		Ft.	In.
	Ft.	In.	Ft.	In.
1	11	6	10	0
1	20	0	18	6
2	11	7	10	0
2	20	0	18	6
3	11	9	10	0
3	20	0	18	6
4	11	11	10	0
4	20	5	18	6
5	12	0	10	0
5	20	6	18	6

Column Jib Cranes

The column jib crane consists of a horizontal jib carrying a trolley and a hoist, and supported by a rotating mast or column pivoted in top and bottom pivot blocks or bearings. This type of crane is made in two types of structure: the bottom braced jib, and the top braced jib. The top braced type frequently is also braced from the back of the column and is then called the top and back braced type. The column and the jib are preferably constructed of I-beams or of channels and plates—the box type of structure being preferable for cranes of very heavy capacity—and should be adequately braced to sustain the combined weight of the structure, the hoisting mechanism, and the load to be lifted. A crane of this type may be equipped with a simple traveler or trolley carrying a chain hoist or an air hoist and be rotated by hand by pushing or pulling on the load; or it may be provided with a hand operated or power operated winch secured to the column near the base and used to handle the load while the crane is rotated by hand, or in some cases by slewing gear operated by steam or electric power.

Bottom-Braced Type

The bottom-braced type of column jib crane has the jib secured at or very near to the top of the column and is supported by braces on the underside of the jib.

A very commonly used type of brace consists of single compression members extending from the base of the column to the underside of the jib near to the outer end. This method of bracing makes a very rigid and safe structure but the location of the braces restricts the range of action of the crane hoist and it is desirable only when the available headroom will not permit the use of other methods of bracing. It is used only when the work to be done may be handled within a comparatively small area underneath the outer portion of the jib.

Another method of bottom bracing is known as the triple brace. It consists of a compression member extending from the base of the column to the underside of the

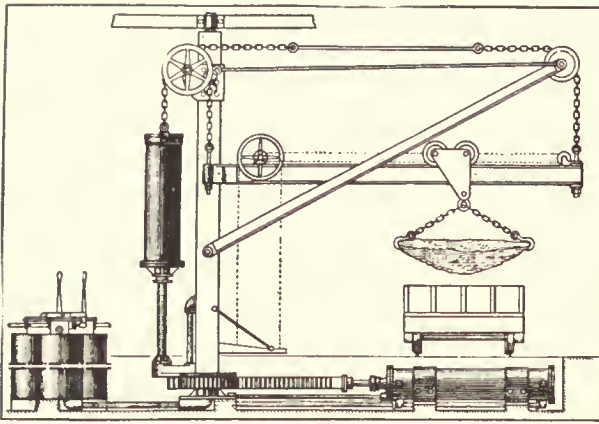

Steam-Hydraulic Jib Crane with Power Swinging and Trolley Racking Mechanism

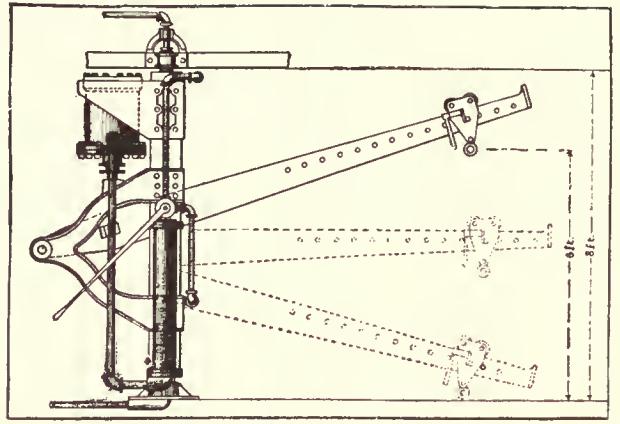

Steam-Hydraulic Crane with Pivoted Jib to Provide High Lift with Only Short Piston Movement

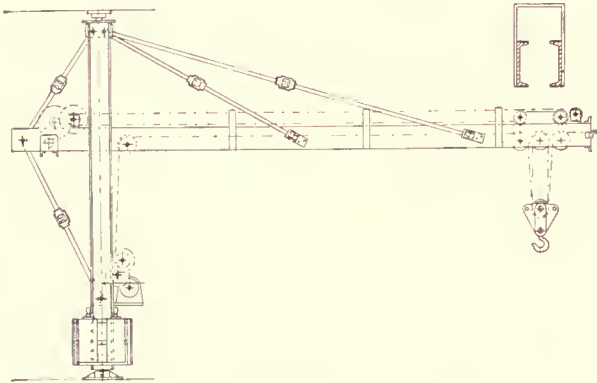

Top and Back-Braced 2-Motor Electric Jib Crane for Indoor Service

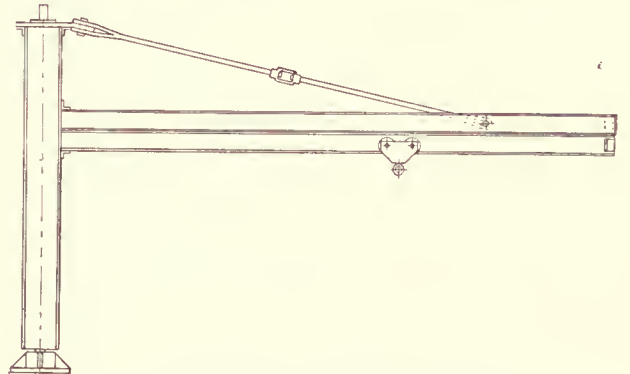

Hand Operated Top-Braced Jib Crane

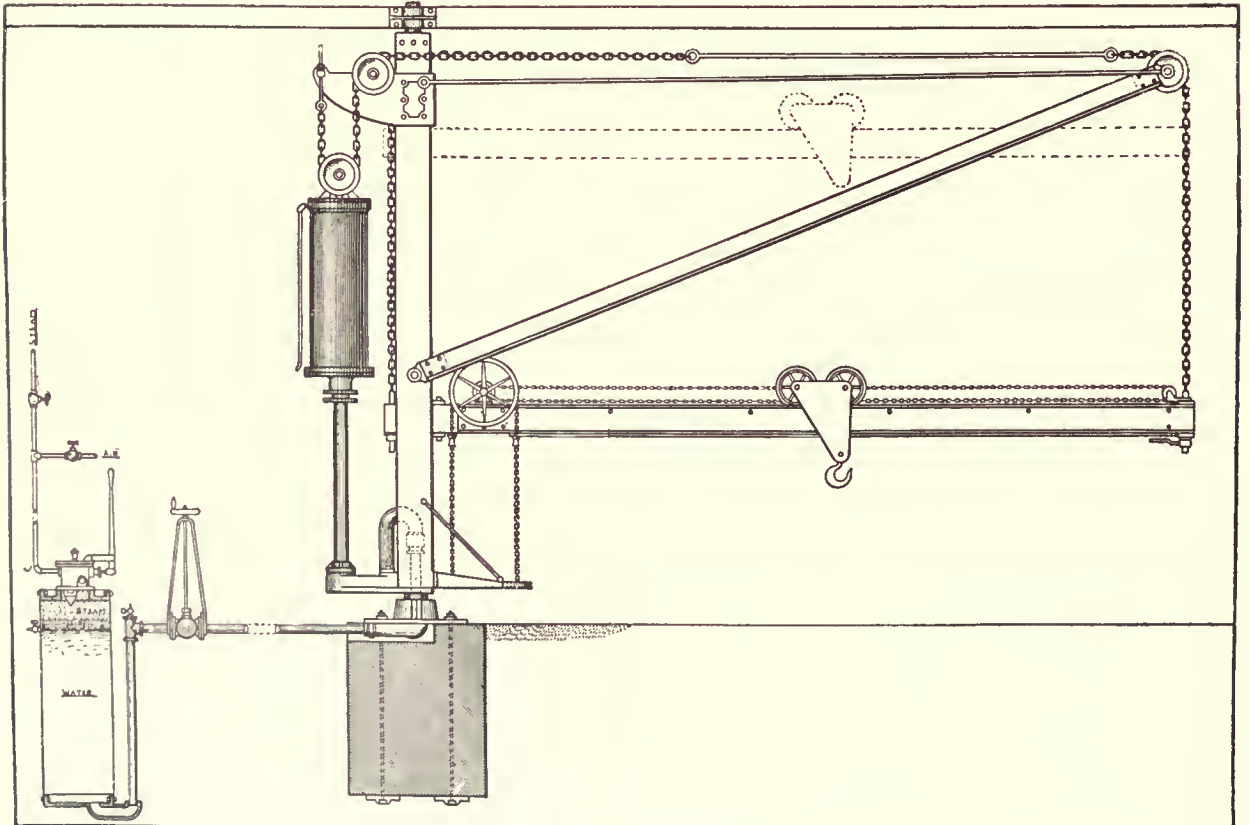

Steam-Hydraulic Crane with Jib Adjusting-Nut to Permit Incline of Jib in Direction of Load Travel

jib at or near to the center of it and reinforced by two additional braces, one extending from the main brace to the upper part of the column and the other brace extending from the main brace to the outer portion of the jib. This gives ample strength and considerably more useful area around the crane column than can be obtained with the two-member bottom-braced type.

A method of bottom bracing which gives access to practically all of the space underneath the jib consists of a wide plate construction which is practically a one-piece jib and column. This structure is of the box type and is reinforced at the junction of the column and the jib by broadening out the side plates and using a corner brace enclosed within the plates. This gives rigidity without making use of the separate compression members which often interfere with handling a load close to the column.

Jib cranes of the bottom-braced type are used largely in indoor service: chiefly in foundries for handling molds, etc.; or in machine shops for handling heavy pieces to and from the finishing machines. They are made with jibs ranging upward to 30 ft. in length and having a capacity upward to about 20 tons. The proportions of some commonly used jib cranes of the bottom-braced type are given in the following table:

COLUMN JIB CRANE—BOTTOM-BRACED TYPE

Capacity, Tons	Length of Jib		Effective Radius		Height of Jib		Height of Mast	
	Ft.	In.	Ft.	In.	Ft.	In.	Ft.	In.
2	17	7	2	9	13	0	14	0
2	32	7	2	9	18	0	19	0
3	17	9	3	0	13	3	14	3
3	32	9	3	0	18	3	19	3
4	18	0	3	2	13	6	14	6
4	33	0	3	2	18	6	19	6
5	18	3	3	4	13	9	14	9
5	33	3	3	4	18	9	19	9
6	18	6	3	6	14	0	15	0
6	33	6	3	6	19	0	20	0

Top-Braced Type

The top-braced type of column jib crane has the jib secured to the column at a point some distance below the top and supported by one or more tie-rods secured to the top of the column and to the jib. This method of bracing leaves the space underneath the jib clear for its entire length and permits a load to be handled with equal facility at the end of the jib or close to the column.

A jib crane of the top-braced type may be installed indoors when there is sufficient headroom and may be used in the same service as a bracket crane or a bottom-braced jib crane. It may also be used—when provided with proper means of support—in outdoor service at industrial plants for handling or loading heavy materials, or in small outlying railroad yards for occasional service in transferring heavy objects such as might be handled by an overhead crane or a gantry crane at the larger yards.

This type of crane is made with jibs upward to about 25 ft. or 30 ft. in length and having a capacity upward to about 10 tons. Proportions of some cranes of this type are given in the following table:

COLUMN JIB CRANE—TOP-BRACED TYPE

Capacity, Tons	Length of Jib		Effective Radius		Height of Jib		Height of Mast	
	Ft.	In.	Ft.	In.	Ft.	In.	Ft.	In.
1	11	2½	10	0	8	7	13	6
1	13	7½	18	6	8	7	13	6
2	11	3½	10	0	9	8½	14	6
2	19	8½	18	6	9	8½	16	6
3	11	5½	10	0	10	9	15	6
3	19	8½	18	6	10	9	17	9

Top and Back-Braced Type

The top and back-braced type of jib crane is similar in construction to the top-braced type except that the jib extends some distance back of the column or mast and

serves as a strut for truss-rods extending from the top of the column to its base.

This type of machine is especially adapted to outdoor service but the smaller sizes may be utilized indoors where there is sufficient headroom. When designed for outdoor service it is a combination of a jib crane and a derrick. The column or mast is supported by guys or by stiff-legs in a manner similar to that employed in derrick construction. When possible the guys or stiff-legs should be installed so that the jib may swing in a complete circle.

Many jib cranes of this type are equipped only with an ordinary trolley and hoist as in the other smaller types of bottom-braced and top-braced jib cranes. They are made with jibs upward to about 50 ft. in length and in capacities ranging upward to 25 tons for general service and are used for handling lumber, logs and similar materials. The following table gives some proportions of the smaller sizes of commonly used jib cranes of this type:

COLUMN JIB CRANE—TOP AND BACK-BRACED TYPE

Capacity, Tons	Length of Jib		Effective Radius		Height of Jib		Height of Mast	
	Ft.	In.	Ft.	In.	Ft.	In.	Ft.	In.
3	17	9	15	0	13	3	17	3
3	32	9	30	0	18	3	24	3
4	18	0	15	0	13	6	17	4
4	33	0	30	0	18	6	24	4
5	18	3	15	0	13	9	17	5
5	33	3	30	0	18	9	24	5
6	18	6	15	0	14	0	17	6
6	33	6	30	0	19	0	24	6

Cranes of this type are, however, made with extremely long jibs for light work such as handling sugar cane, sometimes having a jib or boom with an effective radius up to 100 ft. with a capacity of about 6 tons at that radius. A jib of this great length equipped with a trolley traversing its entire length and having full circle operation gives such a crane a very wide range and makes it a very efficient machine in the class of light work to which it is adapted.

Cranes of this type are extensively used in storage yards, particularly at sugar mills for handling sugar cane with a sling or with an automatic grapple. They may be rotated by hand but generally are equipped with a bull-wheel or with self-slewing gear as used on a derrick.

Steam-Hydraulic Balanced Jib Crane

The steam-hydraulic balanced jib crane—so called because the weight of the jib is balanced by the moving lifting-cylinder of a steam-hydraulic hoisting apparatus—is used chiefly in foundries where its delicate control feature makes it especially desirable for setting large cores, or for handling molds or ladles of molten metal. The crane structure consists of a column or mast supporting an inclined brace and a movable jib. The jib carries a trolley or traveler which is racked across the jib by means of a hand chain. The hoisting hook is rigidly fixed to the trolley and the load is raised or lowered by moving the jib itself instead of moving the hook as on other types of jib cranes. The jib is suspended by four chains, two at each end, the chains from the outer end of the jib passing over sheaves on the end of the inclined braces, and the chains from the inner end passing over sheaves on the mast. All four of these chains are also used to suspend the lifting-cylinder of the hoisting apparatus. They are connected with the upper end of the cylinder, either being attached directly to it or passing around sheaves secured to the top of it. The chains are arranged so that the cylinder always tends to hang plumb regardless of the position of the load on the jib.

The steam or air supply line is piped to a closed cylinder or pressure tank placed in any convenient location in the

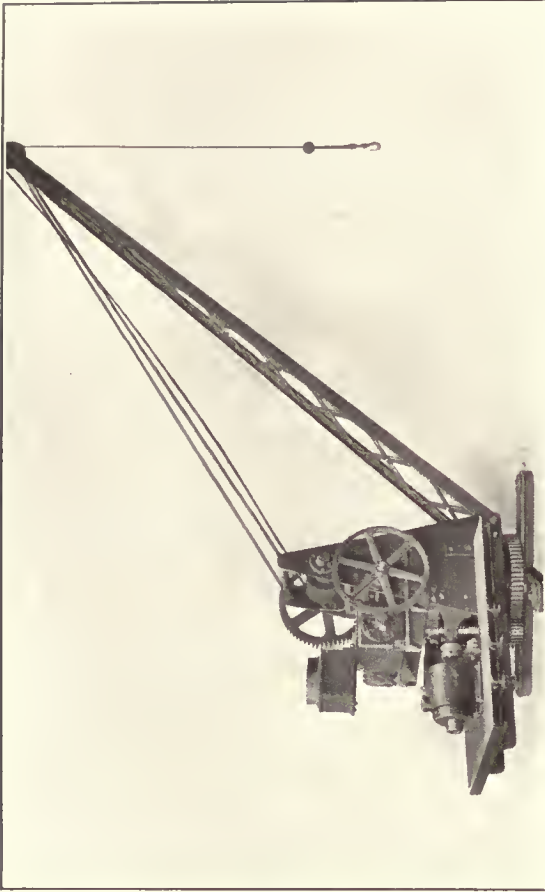

Movable Pillar Crane with Rotating Platform

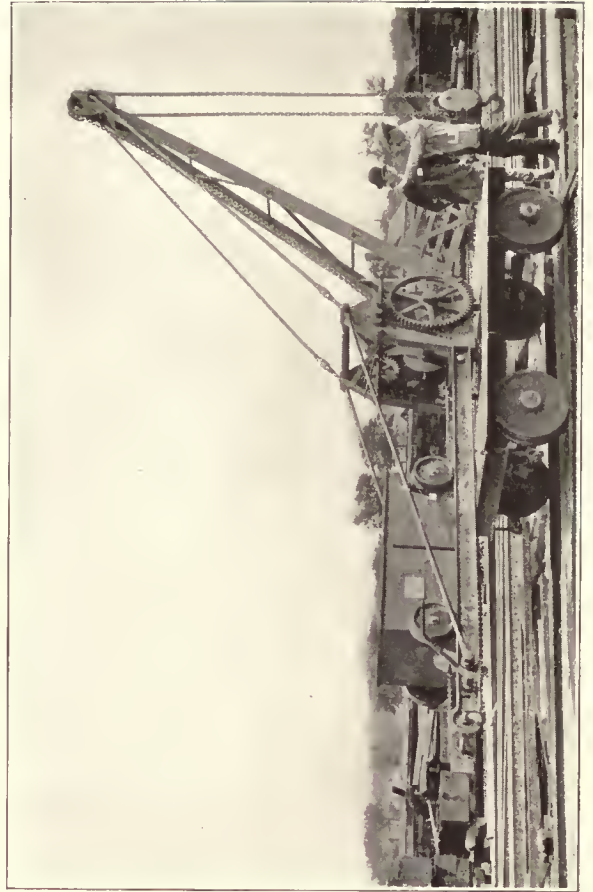

Portable Pillar Crane with Counterweight Attachment

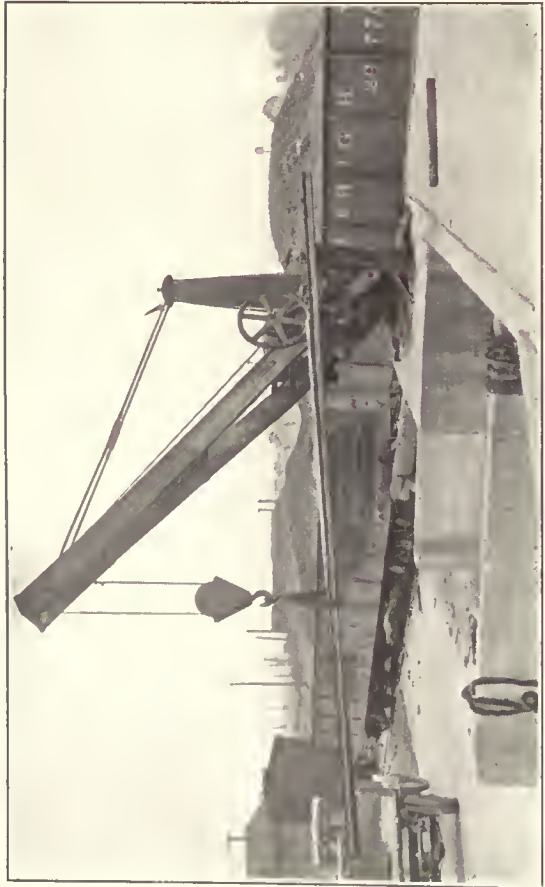

Pillar Crane Installed on Platform for Loading and Unloading Cars



Top and Back-Braced Jib Crane. Electric Operation

ground near the crane, or upon the crane itself. From the bottom of this cylinder a pipe passes through the bed plate of the crane and connects with a U-shaped stuffing-box in the bottom of the mast. A control valve is placed in this pipe, near the ground cylinder within easy reach of the operator. The piston-rod of the lifting-cylinder is hollow and its lower end is fastened to a projection of the bottom gudgeon of the mast pivot, the passage-way being continued through the gudgeon projection and connecting with the stuffing-box in the mast. From the stuffing-box the passage-way leads out through the pipe in the bed plate and connects with the ground cylinder. The ground cylinder is filled with water to within 12 or 18 inches of the top, the space above the water being occupied by air. In this type of hoist the piston is fixed in an upright position and the lifting cylinder moves up and down upon it.

To operate the crane, steam is admitted to the top of the ground cylinder through a slide valve and is spread with a circular motion over the air by means of a baffle plate. The air, being heavier than the steam, keeps its place next to the water and acts as a cushion to take up any vibrations of the load giving a very delicate control and also preventing the steam from coming in contact with the water and condensing. The water takes the same pressure as the steam, and, passing to the lifting cylinder, its force is exerted in the space between the lower side of the fixed piston and the lower head of the moving cylinder, thus pressing the cylinder down on the piston-rod and lifting the jib and its load. The speed at which the crane operates depends on the size of the opening in the connection between the two cylinders and this is regulated by the control valve so that the speed may be varied or the load may be held suspended at any point. To lower the load, the steam valve is moved to the exhaust position, which relieves the pressure on the water and allows it to flow back into the ground cylinder by gravity. This permits the lifting cylinder to move upward on the piston-rod, thus lowering the jib.

Compressed air may be used instead of steam and when this is done oil may be used instead of water if desired. Both air and steam may be piped to the ground cylinder so that if from any cause the supply from one source should fail, the closing of one valve and the opening of another will permit a change in power. The same water is used indefinitely, as none is consumed in the operation of the crane. Anti-freezing mixtures such as glycerine, wood alcohol, or chloride of calcium may be added to the water to prevent it from freezing in the cylinders in cold weather.

Cranes of this type are made in capacities ranging upward to about 20 tons and have jibs upward to about 30 ft. in length.

Pillar Cranes

The pillar crane is a rotating type of crane largely used on railroad freight platforms and in railroad and industrial yards for loading and unloading materials and for general lifting purposes within a limited area. It may also be installed indoors and used for many of the same purposes as the jib crane but rarely is used in such service. It consists of a self-supported rotating pillar or mast which supports an inclined jib or boom secured at the base of the pillar.

In the usual type of construction the pillar is circular in form. It is either a steel casting or is of steel plate of large diameter at the bottom and tapering toward the top.

It is pivoted on a bearing resting on a cast iron base set in concrete or bolted to a pier. The pillar is held in an upright position by a tension rod secured to the base and extending up through the pillar to a mast top casting. The boom may be straight, or may be curved at the upper end, which gives a somewhat wider clearance for a load which it may be desired to raise to a high position. These booms may be made of a single I-beam member; of I-beams or channels with the lattice type of construction or they may be built in the box type of structure employed in the construction of crane bridges.

The most commonly used pillar cranes have the boom fixed in a rigid position, by means of tie-rods extending from the outer end of the boom to the mast top casting, and having the hoisting tackle reeved at the outer end. This makes a fixed radius of action which, with the circular movement of the end of the boom as the mast is rotated, gives a considerable range for useful work. It is, however, desirable sometimes to change the inclination of the boom so that the radius of action may be varied. This is accomplished by hinging the foot of the boom to the base of the mast and using a topping-lift, as in derrick construction, instead of using the rigid tie-rods generally employed in a machine of this type.

Most pillar cranes are hand operated, being equipped with a hoisting winch, a one-drum winch being used with a fixed boom and a two-drum winch with a variable radius boom—one drum for hoisting the load and one for operating the topping lift. Usually the winch is installed on the boom near the base of the mast. They are also frequently equipped with air hoists, or with electric power mounted on a platform which rotates with the mast. Pillar cranes of this type are also generally equipped with self-slewing gear.

This type of crane ranges in capacity up to about 30 tons with a radius of action up to about 30 ft. The following table gives the proportions of some commonly used sizes of pillar cranes.

Capacity, Tons	PILLAR CRANES				Height of Pillar Ft. In.
	Maximum		Minimum		
	Radius Ft.	Lift Ft. In.	Radius Ft. In.	Lift Ft. In.	
1.....	15	12 8	9 0	15 5	9 8
1.....	30	25 0	18 0	32 10	9 8
2.....	15	12 5	9 0	15 2	9 8
2.....	30	25 0	18 0	32 7	9 6
5.....	15	11 9	9 0	15 6	9 6
5.....	30	25 0	18 0	32 8	9 6
10.....	15	11 0	9 0	13 2	9 6
10.....	30	25 0	18 0	31 7	9 6
15.....	15	10 6	9 0	12 11	9 6
15.....	30	25 0	18 0	31 6	14 7
20.....	15	10 0	9 0	12 3	9 6
20.....	30	25 0	18 0	30 3	14 7
25.....	15	9 9	9 0	11 9	14 7
25.....	30	25 0	18 0	30 10	14 7
30.....	15	9 6	9 0	11 6	14 7
30.....	30	25 0	18 0	30 7	20 3

Pillar-Jib Cranes

The pillar-jib crane is a combination of the horizontal jib and the self-supported rotating pillar or mast. As on column jib cranes the jib may be bottom-braced or top and hack-braced. To give additional stability a counterweight is often placed on the extended rear end of the jib. This type of crane may be adapted to any service in which the two parent types are used and, having the traveler or trolley on the jib, combines the advantages of the jib crane with the self-supporting feature of the pillar crane. This feature permits its installation in any desired location without

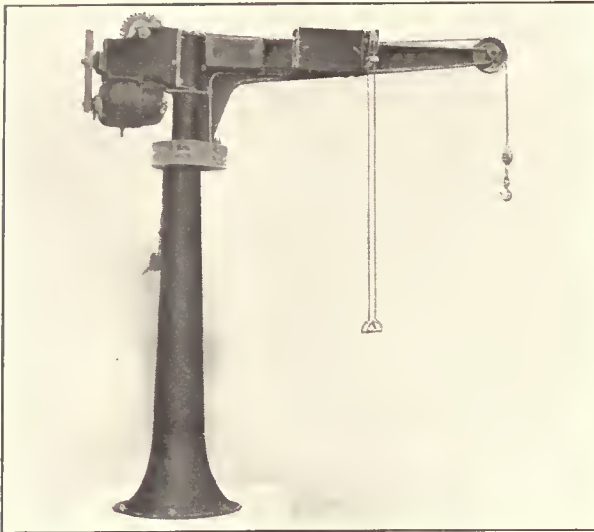

Electric Pillar Jib Crane

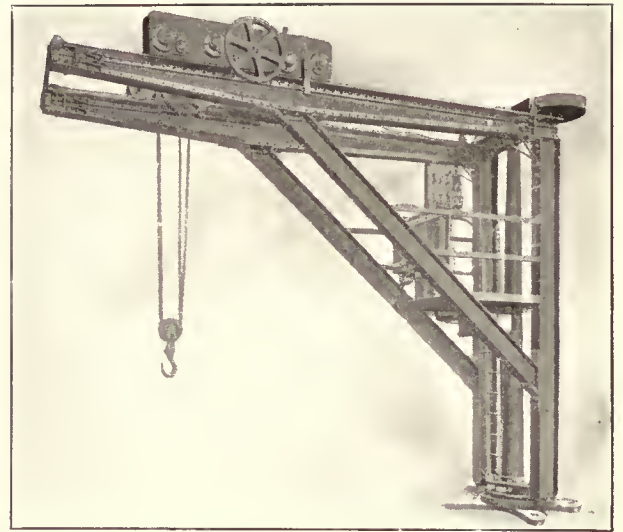

Bottom-Braced Electric Jib Crane with Self-Slewing Gear



Skeleton-Platform Jib Crane

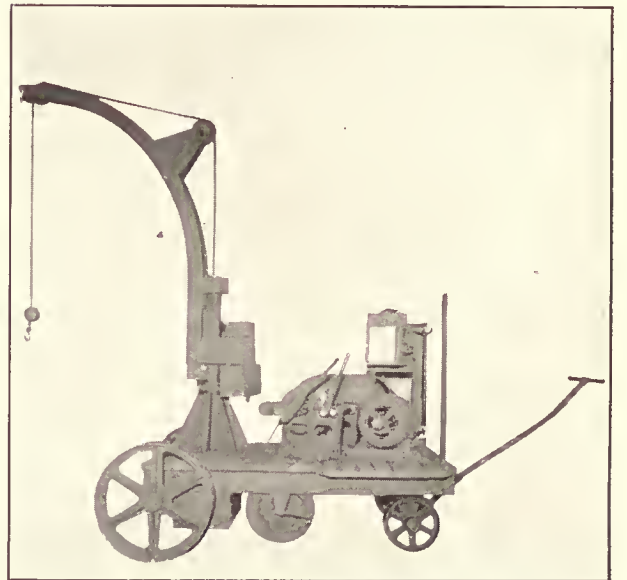

Portable Electric Stacking Crane

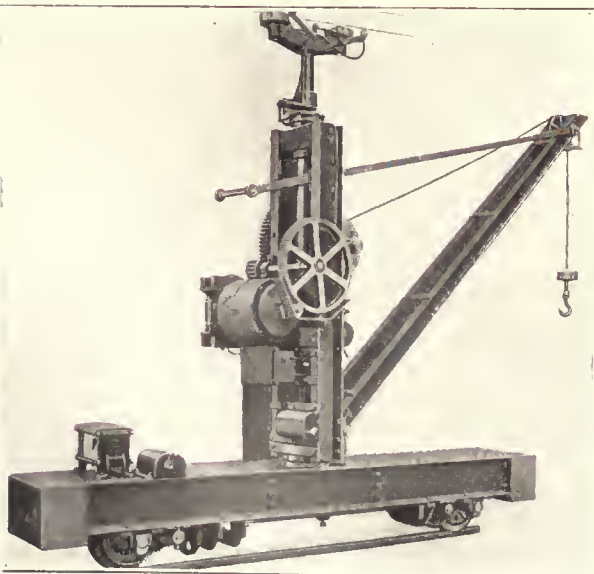

Electric Walking Boom-Jib Crane

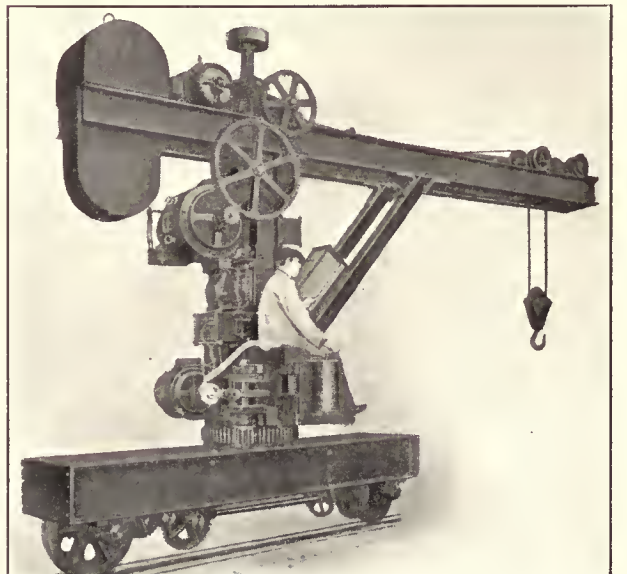

Electric Walking Jib Crane

recourse to guys or other methods of supporting the top of the crane.

Pillar-jib cranes are made in the same capacities as the two other types and may be operated by hand, air, steam or electric power.

Portable Jib and Pillar Cranes

The smaller sizes of the various types of jib and pillar cranes are sometimes installed on a platform mounted on wheels so that they may be moved from place to place. They may be equipped either with flanged wheels and travel on rails or with wheels having a flat tread and travel on any solid flat surface.

This permits their use in various parts of a yard or a shop where the volume of work required in any particular location is not great but where lifting is necessary at widely separated points. The faculty with which a crane of this type may be moved will soon offset the additional cost of the mounting.

They are used in terminals or warehouses for handling freight; in machine shops, foundries, or power plants, for handling heavy pieces; or in the yards of industrial plants for any light service. They may also be mounted on a flat car on a steam or electric railroad and used in railroad service.

Counterweight

On the most common types of portable cranes, the boom or jib is fixed at a constant radius and its weight and the weight of the load is counterbalanced by a weight installed on an extended platform at the base of the mast or on the rear extension of the jib—when the horizontal jib is used. This counterweight is sometimes mounted on small wheels traveling on a runway so that it may be moved toward or away from the mast to counterbalance either a light load or a heavy load at the end of the boom. At any given radius of the boom or jib the capacity of a crane of this type is determined by the relative location of the counterweight on the runway.

On many of these portable types of cranes the entire crane structure revolves on a turntable resting on the platform. The platform may be mounted on flanged wheels and travel on rails or may have wheels with a plain tread and travel on any solid flat surface. They are equipped with hand, air, or electric power for hoisting and range in capacity upward to about 5 tons. This insures a perfect counterbalancing of the load and prevents the crane from toppling over.

Work-Car Crane

The type of pillar crane or the jib-pillar crane generally used on freight platforms or in other fixed locations is also frequently mounted on a standard gage railroad flat car and used in wrecking service or other work along the line as may be required. The height of the pillar and the length of the boom or the jib is limited by the railroad line clearances.

Skeleton-Platform

A special type of portable crane adapted to handling small but heavy pieces is provided with a rigid curved one-piece boom and mast mounted on a low skeleton platform carried on small wheels. The boom curves directly over the platform so that the weight of the load will not topple the crane. The hoist hook—usually attached to a sheave block carried by a chain—is suspended from the end of the curved boom. The hoisting chain runs over a series of sheaves on the boom and thence to the hoisting apparatus

—generally a geared type of winch—near the foot of the mast. One pair of wheels is pivoted and provided with a handle by which the crane may be drawn about and turned as desired to handle the load.

These cranes are especially adapted for use in machine shops as the low skeleton-platforms will easily pass under the standards of a lathe and many other types of machines used in finishing materials. This makes it possible to bring a heavy casting close up to a machine and hold it suspended on the jib hoist until it has been adjusted to the machine ready for operation.

Skeleton-platform jib hoists are made in capacities upward to 3 tons or more and range in height upward to about 10 ft. or 12 ft.

Approximate sizes and capacities of some cranes of this type are given in the following table:

SKELETON PLATFORM JIB HOIST

Capacity Tons	Maximum Height of Lift		Crane Jib Overall Height	
	Ft.	In.	Ft.	In.
1½	5	4	6	6
2	6	3	7	6
2½	7	3	8	4
3	8	4	9	5
3	8	2	9	6½
3	10	0	11	4
3	11	6	12	10

Stacking Jib Crane

Another special type of portable crane is designed for use in warehouses for handling and stacking bales, bags, or other material of uniform size. This type of crane is provided with a high curved jib or boom pivoted on a short rigid mast fixed to a base secured to the platform of a hand propelled truck. The power unit—usually electric power—is carried on the truck and supplied with current from a plug-in connection provided at various points on the building service line. The booms range in height upward to about 20 ft. and in capacity up to about 1 ton. In order to permit the extremely high jib of some of the larger sizes of such cranes to pass through doorways or under low-hanging trusses or other obstructions the boom is hinged to the mast so that it may be lowered to a horizontal position while moving the crane to a desired location.

Walking Jib Crane

The walking jib crane is a self-propelled type of portable or traveling jib crane. It consists of a structural steel jib supported by a short mast or column and equipped with a crane trolley and hoisting mechanism. It is mounted on a two-wheel truck or carriage which also carries the operating mechanism. The truck travels on a monorail and is supported at the top by one or two small wheels secured to the top of the crane structure and resting against an upper rail or runway secured to the shop building. It is electrically operated, the motors being mounted on the crane structure and supplied with electric current through wheels held in contact with an overhead power circuit. The crane jib is rotated by means of a slewing gear at the foot of the mast. The operation of the crane is controlled from a platform on the side of the crane structure or from an operator's seat mounted on the carriage. This type of crane is made in capacities ranging up to 7 tons or 10 tons and is used largely in machine shops or erecting shops for handling heavy parts and may also be adapted to other general indoor service.

A pillar or a jib crane mounted in this manner will serve

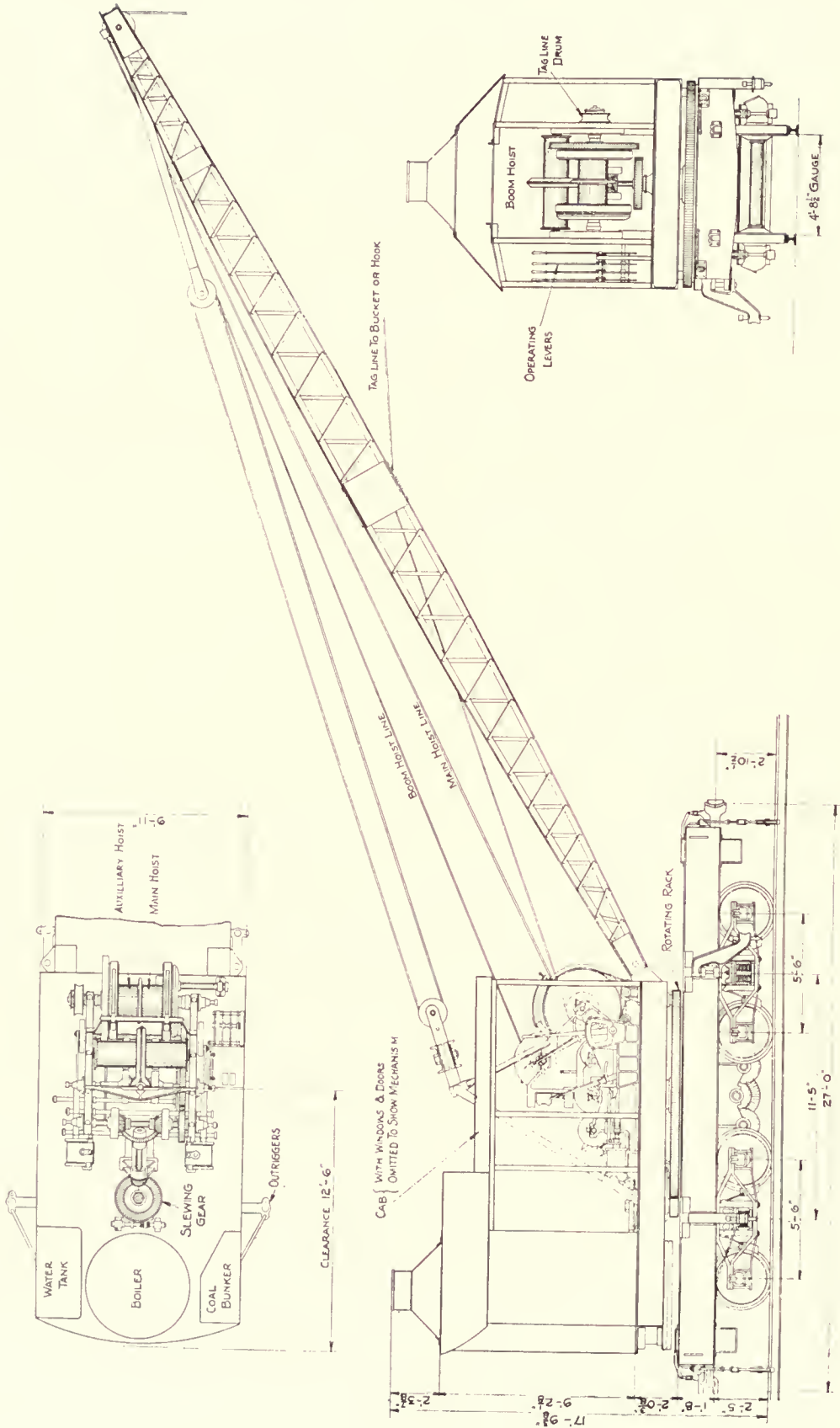

General Drawing Steam-Operated Locomotive Crane

for many of the same purposes as a small locomotive crane but of course not being self-propelled is not so mobile in manufacturing plants requiring a portable crane.

Another simpler form of walking jib crane for lighter work has an inclined boom instead of the horizontal jib. The boom is provided with hoisting tackle reeved through sheaves at the outer end of the boom and wound on a

drum on the mast. It is operated by an electric motor installed on the mast. This crane is carried on a two-wheel truck traveling on a monorail and is supplied with power by an overhead contact with a power circuit. It is used in the same class of service as the larger horizontal type of walking jib crane but generally is made in smaller sizes for lighter work.

Locomotive Cranes

Locomotive cranes—so called because self-propelled—have been developed to a high state of efficiency and are extensively used in outdoor operations requiring the use of a hoisting machine. Originally they were designed only to travel on railroad track and were used only in railroad work. They generally were provided with a single hoisting line equipped with a fall-block and were used chiefly for raising heavy loads as in wrecking work or in other railroad operations where heavy lifting was necessary. They now are used much more extensively in railroad work and also have been adapted to general use at industrial plants; on wharves and at terminals for handling freight; in construction operations; in excavation work; and for many other purposes.

They range in capacity upward to 160 tons and may be equipped with a plain fall-block for general lifting with a hook, with slings, tongs or similar accessories; with the various types of grab buckets or drag-line buckets for handling loose materials and for excavation work; or with an electric magnet for handling metals. Many locomotive cranes are so designed that power-shovel or pile-driver attachments may be installed and the crane used in such service.

Usually locomotive cranes not only have sufficient propelling power to move the machine itself but, when traveling on rails, may also be used for hauling and switching purposes.

Construction

Modern locomotive cranes are a type of rotary crane consisting of a hinged boom similar to that of a derrick; a mast or other type of structure similar to that of a pillar crane, to provide a firm base for the boom and a connection for the topping lift; and a power plant installed on a turntable operated by a rotating mechanism—also installed on the turntable. These parts are carried on a flat rectangular frame or car body mounted on wheels and propelled by a travel mechanism operated by the power plant installed on the turntable. The frame and the turntable usually are ballasted by means of counterweights of concrete or iron thereby adding to the stability of the crane structure when it is rotated under load. The details of construction must be varied to suit the particular class of service for which the crane is designed. The general details of the crane structure, however, are practically similar for each of the various classes.

The Trucks

The trucks or wheels on which locomotive cranes are mounted vary with the type of machine and the service required of it. The most common type of crane is mounted on trucks similar to those used under railroad cars and travels on railroad track. A four-wheel truck generally is used for cranes of light capacities, up to about 15 tons, and double trucks—two four-wheel trucks—for cranes of heavier capacity. Other types of cranes may be mounted on wheels having a plain tread to travel on a smooth surface; may have tractor wheels—crosswise projections on the wheel face—and travel on rough or soft ground; or

may be partly or entirely mounted on creeper trucks—a wide, flat, sectional wheel face—and travel over rough or yielding ground.

Car Frame

The superstructure of a locomotive crane is carried on a rectangular frame or car body. The essential features of frame construction are: adequate strength to sustain the loads and stresses imposed upon it; suitable arrangement of parts to allow convenient installation and operation of the rotating structure; and sufficient weight to and disposition of the parts to assist in giving stability to the crane when in operation.

Cranes traveling on railroad track, particularly those of the higher capacities, are mounted on a structure very similar in construction to the underframe of a railroad car. It consists of a structural steel frame to which is secured the turntable base, the large gear of the turntable rotating mechanism, and parts of the travel or propelling mechanism.

As the connection between the car frame and the trucks of an eight-wheel crane is made by means of a center pin only, some method must be provided to steady the structure when the crane is in use. This is done by placing wedges between the truck bolsters and the side sills of the car frame, thus stabilizing the crane and at the same time transmitting a great portion of the load to the axles and the wheels.

Cranes mounted on wheels for trackless travel may have a frame built up of structural parts similar to those used on cranes built for rail travel; may have a cast steel frame; or may have a wooden frame resting on cast or rolled metal sills. Cranes of the trackless type are provided with some form of steering gear, usually similar to that used on motor trucks.

Travel Mechanism

The crane travel mechanism is carried on the underside of the car frame and is connected with the power plant installed on the turntable, by a series of gears, or by a combination of gears and chain drive. It may be either of the rigid shaft type or may have a driving shaft of the flexible type.

On four-wheel cranes traveling on rails the travel mechanism commonly used consists of a bevel pinion at the lower end of a vertical shaft, extending down through the car frame, and meshing with a gear on a horizontal drive shaft suspended from the frame. Bevel pinions on each end of the shaft mesh with gears on the truck axles. Both axles are driven and may be rotated simultaneously in either direction.

On eight-wheel cranes designed for ordinary service, only the inside axle on each truck is driven, but on cranes of very heavy capacity or when maximum tractive effort is desired, the travel mechanism may be designed so that all four axles may be driven. The travel mechanism may be of the long horizontal shaft type or may consist of a train of gears mounted on short horizontal shafts and mesh-

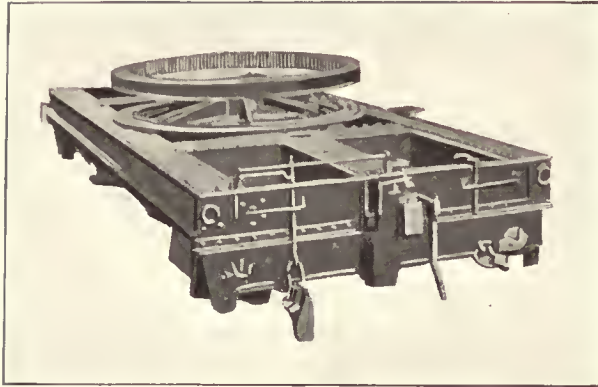

Top of Eight-Wheel Car Frame Showing Slip-Ring (Poised) and Rail Clamps

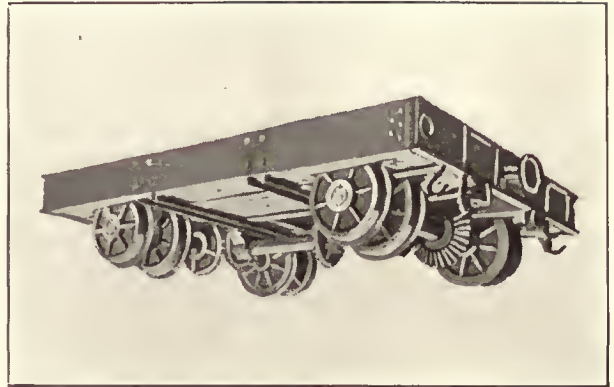

Four-Wheel Car Frame Showing Straight Shaft Travel Mechanism and Stability Wheels

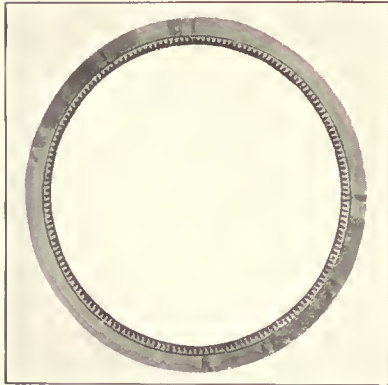

Rotating Rack. Slip-Ring Type. Internal Gear Teeth

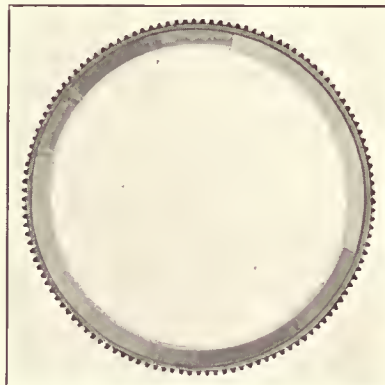

Rotating Rack. Slip-Ring Type. External Gear Teeth

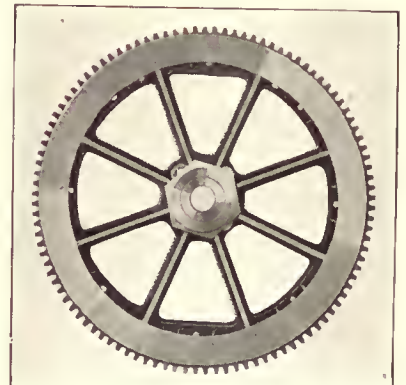

Rotating Rack. Fixed Type. External Gear Teeth

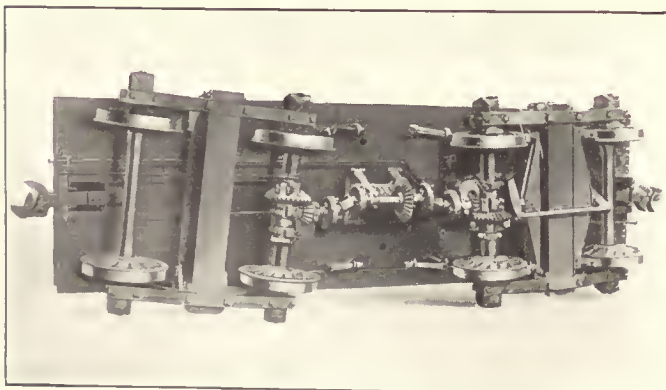

Underside of Eight-Wheel Car Frame Showing Flexible Shaft Type of Travel Mechanism

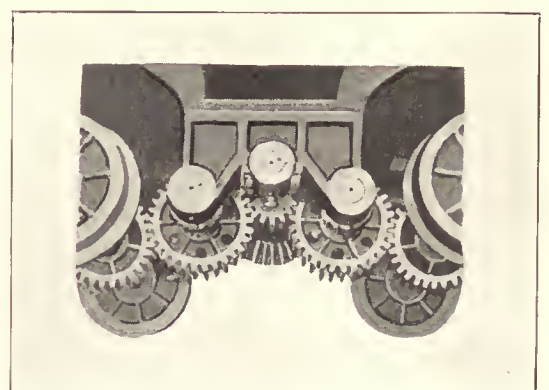

Center Portion of Eight-Wheel Car Frame Showing Gear Train Type of Travel Mechanism

ing directly with the gears on the truck axles. Either type may be rotated in either direction so that the crane travel may be reversed.

In the long shaft driven type the construction is similar to that used on four-wheel cranes except that the horizontal shaft usually is in several parts connected with universal couplings. This type of shaft construction permits the travel mechanism to function properly regardless of the swiveling of the trucks when the crane travels on curved or uneven tracks.

In the gear train type of travel mechanism—used on many eight-wheel cranes—a bevel pinion on the vertical shaft drives a gear train mounted on short horizontal shafts supported in a cast steel frame secured to the car frame. This type of travel mechanism requires that the trucks shall be spaced so that each end of the gear train will mesh with the gears on the truck axles. The teeth on the axle gears are shaped so that they will permit the movement necessary when the trucks swivel on curved or uneven tracks. Provision is made to throw the axle gears out of mesh when the crane is being hauled by other power, thus eliminating the danger of stripping the gear teeth.

The travel mechanism generally used on locomotive cranes not intended for traveling on rails and having plain wheels or tractor wheels consists of chain belts engaging driving sprockets secured to the crane truck wheels—usually the front wheels, which carry the greater portion of the load when the crane is in use.

On cranes having the creeper type of trucks the drive consists of some form of endless rack or belt to the outside of which the sections of the sectional tread are secured. This belt is driven by sprockets installed within the sectional tread and acting directly on the belt; or by a chain acting on the truck axle.

The Turntable

The turntable or rotating base of the crane superstructure carries the entire rotating portion of the crane, which includes the rotating mechanism, the hoisting mechanism and the power plant—either steam, gasoline or electricity. It is carried on four or more conical-shaped steel rollers which either are secured to the turntable and travel on a circular path on the upper surface of the large rotating gear; or the upper face of the rotating gear is recessed and the rollers set in it, the under surface of the turntable resting on the rollers. It should be so constructed as to insure adequate strength to sustain the combined weight of the machine and the load and to have a large factor of safety to guard against excessive stresses due to overloading. It may be built of structural steel and cast steel or cast iron parts; may be of structural steel with concrete filling; or may be a single steel casting.

Each of these methods of construction has some advantages and disadvantages: The use of structural steel parts supplemented and reinforced by cast parts and by concrete allows more freedom in the design of each of the various parts to suit its particular function and, in case of failure of any part it usually may be repaired with little difficulty and at a small cost. A multiplicity of small parts, however, requires the use of a large number of bolts and rivets which may become loosened, causing a disalignment of parts and possibly injury to the rotating mechanism or to the hoisting mechanism.

A single large casting greatly reduces the number of parts to be provided for and permits the elimination of a great number of bolts and rivets which would cause trouble should they become loosened. In case of failure of any

part of the base, however, the added difficulties of making repairs would be considerable.

Rotating Mechanism

The rotating mechanism of a locomotive crane is mounted on side frames resting on the turntable. It consists of a series of gears operating a vertical shaft to which is attached the rotating pinion meshing with a large rotating gear—either a fixed circular rack or a toothed slip-ring, sometimes as much as 9 ft. in diameter—secured to the car frame or simply resting on a machined bed.

Rack Rotating Gear

The circular rack type of rotating gear is used extensively on locomotive cranes. The common form of construction is a cast-steel gear of large diameter, secured to the bed of the car frame.

One form of gear has a machined path for the turntable rollers on its surface. The teeth may be on either the outside or inside of its circumference.

Another type of rack rotating gear has a recess in its upper surface in which the rollers are secured instead of being attached to the turntable. A roller path is provided on the under surface of the turntable and the parts are held in alignment by means of an interlocking jib-ring.

These gears mesh with the rotating pinion secured to a vertical shaft extending upward through the turntable base and having a bevel gear on its upper end meshing with similar gears on a horizontal drive shaft. The rotating movements are controlled by means of various types of clutches and slipping devices designed to absorb the shocks due to sudden starting or stopping of the crane.

Slip-Ring Rotating Gear

A slip-ring type of rotating gear is used on many locomotive cranes to absorb the shocks incident to sudden starting or stopping of the rotating structure. This ring may be made of rolled steel or may be a steel casting, resting on a machined seat on the bed casting secured to the car frame. It has gear teeth—either on the outside or the inside of the ring—which mesh with a pinion on the crane rotating mechanism. It is held concentric with the center pin on the bed casting of the rotating mechanism but is free to turn in either direction. The upper surface of the ring serves as a path for the turntable rollers on which the crane superstructure rotates, the entire weight of the rotating crane being imposed on the ring. The friction thus set up between the under surface of the slip-ring and the bed casting is sufficient to insure efficient action of the rotating gear, but when the force due to sudden rotation or stopping of the crane becomes excessive the ring slips on its seat and this slight movement prevents injury to the crane structure.

Boom Slewing Engine

A small boom slewing engine is sometimes installed on the turntable and used as an auxiliary to the crane rotating mechanism when the crane is used to handle very heavy loads with a long boom. This materially lessens the strains imposed on the structure when slewing the boom.

The Boom

The booms of locomotive cranes are made in various lengths ranging upward to 70 ft. or 80 ft. for general service and to 160 ft. or more for special service. Various types of construction are used depending on the capacity required and the radius of action desired. They may con-

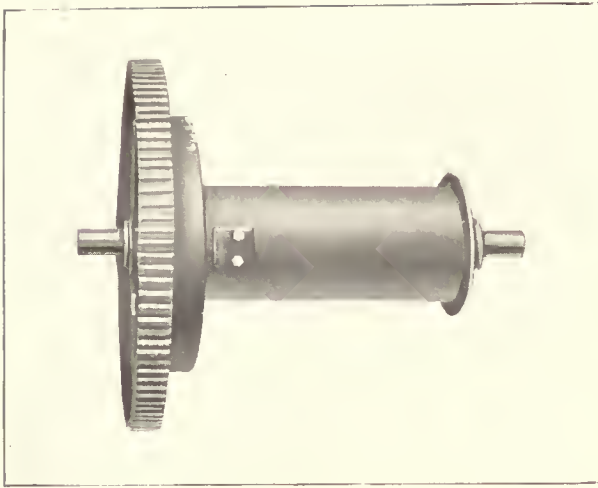

Single Hoisting Drum

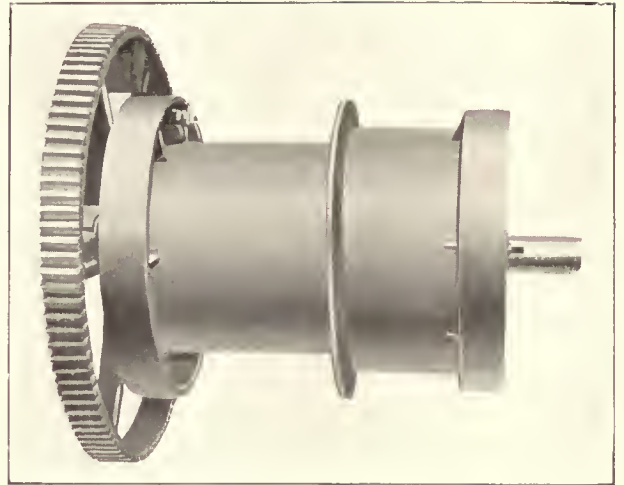

Double Hoisting Drum

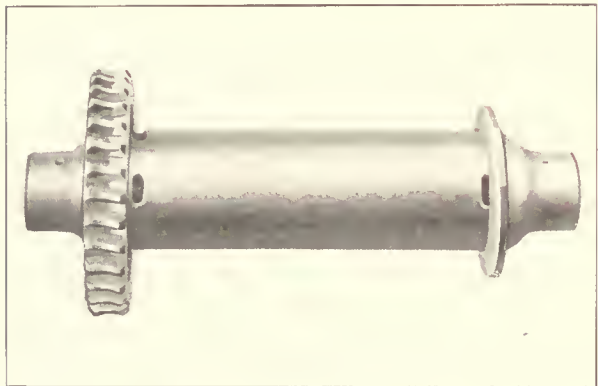

Boom Hoisting Drum

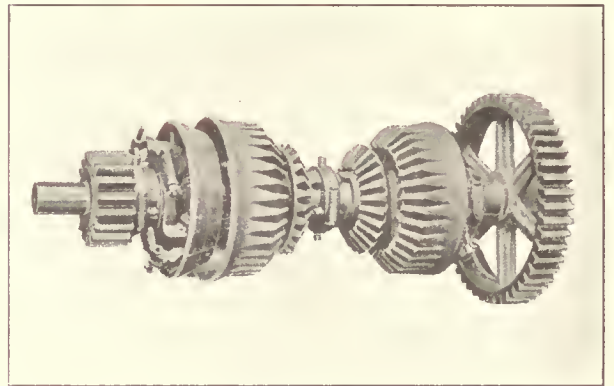

Intermediate Shaft, Gear and Clutch

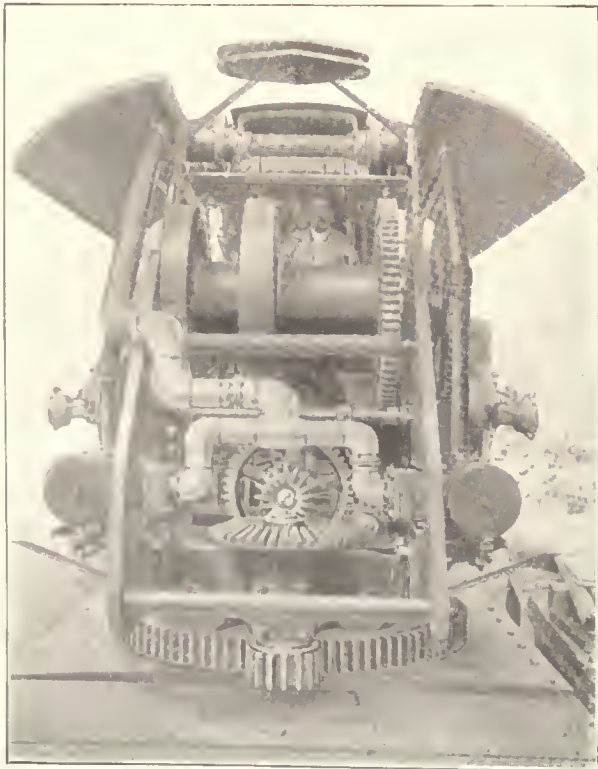

Turntable of Locomotive Crane Showing Rotating Mechanism and Hoisting Drums

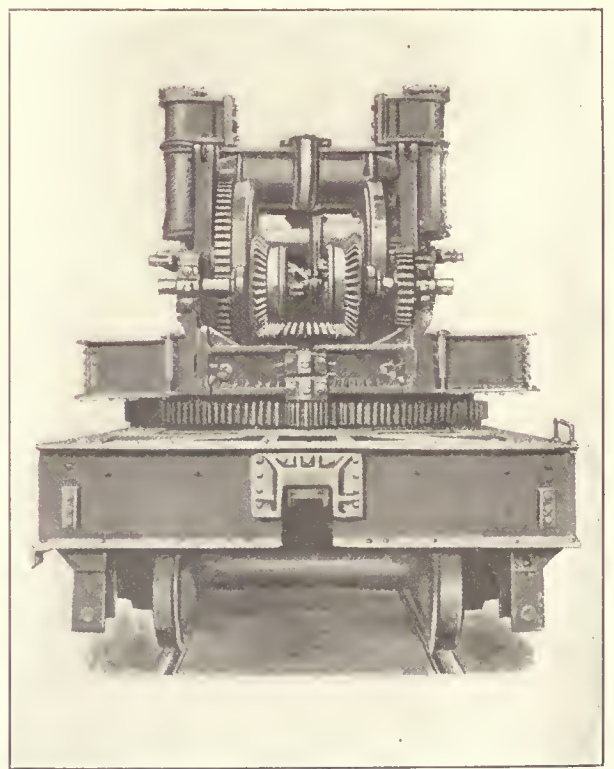

Turntable of Locomotive Crane Showing Hoisting Drums, Rotating Mechanism and Clutch

sist of a single piece, or may be made in a telescopic or cantilever form so that they may be lengthened or shortened as desired.

Booms designed for light service within a small area may be constructed of wood reinforced with iron fittings and sometimes with boom truss-rods; may be single I-beams of adequate section; or may be built up of light I-beams or channels reinforced with plate or lattice cross members. This latter type of boom, when constructed of heavy material, may also be used on cranes of heavy capacities operating over a greater area. The most common and most efficient type of boom for heavy service and long radius is of rectangular cross section and is constructed of four corner angles with a lattice type of reinforcement, sometimes being supplemented by plates at the boom end and at the bottom. Many booms of this type are provided with a removable center section which may be inserted or removed as the radius of action required for the work may permit.

Booms are made in various shapes to conform to the method of construction or to provide certain clearances and convenience in special service. The smaller sizes of booms, especially those constructed of wood or I-beams, are generally straight. Those of the lattice type of construction generally have the corner angles formed to a curve so that the cross section at the center is much larger than at the ends, giving a truss type of construction which offers the greatest resistance to collapse under load. Most booms are built on a straight axis but, to provide the clearances desired in some special operations they frequently have either a curved upper end or a goose-neck, to permit the crane to operate close up to a high structure but at the same time to allow a comparatively wide radius of action without lowering the boom. Other booms have a curved section at the bottom so that a crane may operate close to a car, or a pile of material, or a low structure, but at the same time lower the boom to secure a wide radius of action. The boom end is equipped with one or more sheaves suitable for the lines required to operate the hoisting accessories such as hooks, grapples, slings, buckets, or magnets.

Hoisting Mechanism

The hoisting mechanism of the locomotive crane consists of the load hoist—a form of hoisting winch having one or more drums—and the boom hoist. The drums on these hoists generally are made of cast iron and are mounted on shafts resting in side frames which usually are integral with the side frames of the rotating mechanism. In some cases these drums are supplemented by winch-heads or small drums secured to extensions on the various shafts of the rotating or hoisting mechanisms.

Load Hoist

The load hoist mechanism, on cranes intended only for general hoisting purposes, consists of a train of gears operating a single drum on which the hoisting line is wound as the load is raised or lowered. A crane thus equipped can be used with a fall-block having a hook or shackle, for handling material with slings or tongs; with some forms of buckets requiring only one line; or they may be used for handling scrap or other metals with an electric lifting magnet.

A double drum—and frequently also an auxiliary drum on an independent shaft—is installed on cranes used for automatic bucket operations or for other service requiring two or more lines. The double drum is mounted on a

single shaft and is controlled by clutches which permit both drums to be operated simultaneously, or independent of each other.

Boom Hoist

The common type of boom hoist consists of two small drums secured to a shaft operated by a worm driven gear. The topping-lift lines are wound on these drums and permit the hoisting or lowering of the boom simultaneously with the operation of the load hoisting drums. The boom hoist is controlled by the movement of the worm, but some type of brake—usually an automatic brake of the band type—is also installed as a safety precaution.

Clutches

The traveling, rotating, and hoisting mechanisms of locomotive cranes are controlled by various types of clutches acting on the various parts attached to the drive shafts or to the drum shafts. They may be of the metal cone surface friction type; the wedge shaped or the flat surface friction type, having friction surfaces of metal or of wood—sometimes having inserts of cork set in the contact face; may be of metal, lined with fabric or leather, or may have metal surfaces—sometimes having inserts, composed of material having a high coefficient of friction, set in the contact face; or they may be of the spring type. These clutches are operated either by cams or toggles controlled by clutch levers within easy reach of the crane operator. In addition, most cranes are provided with means for throwing the driving gears out of mesh so that the operation of the entire mechanism may be suspended.

Brakes

Friction brakes are provided, on practically all locomotive cranes, for the control of the boom hoist, the rotating mechanism, and the travel mechanism. These are generally of the band type—though the expansion type is sometimes used—and are controlled by means of foot or hand levers easily accessible by the crane operator.

In addition to the brakes provided to control the travel mechanism various other types of brakes are provided to control the travel of locomotive cranes, particularly those mounted on trucks traveling on rails. Those cranes used in railroad service which sometimes are coupled to railroad cars and hauled in a train are provided with standard couplers and air brakes and the trucks are fitted with brake rigging conforming to M. C. B. standards. Other cranes traveling on rails but never used in a train may be equipped with a brake controlled by the crane operator which may apply brake shoes to the face of the truck wheels or may apply some other form of friction brake to the truck axles or to the truck drive shaft. Cranes of the trackless type are provided with brakes similar to those used on motor trucks.

Outriggers and Rail Clamps

Outriggers of various forms are used on many locomotive cranes, to supplement the ballast or counterweights and the wedges used between the truck bolsters and the car frame. These devices are particularly necessary on cranes of heavy capacity, in order to impart greater stability to the crane structure when the boom is operating on either side or when handling very heavy loads with a long radius of boom. The use of such devices increases the lifting capacity of cranes from 10 per cent to 50 per cent, depending on the length of the boom and the distance from the crane center to the bearing point of the outriggers.

The outriggers may consist of some form of bracket

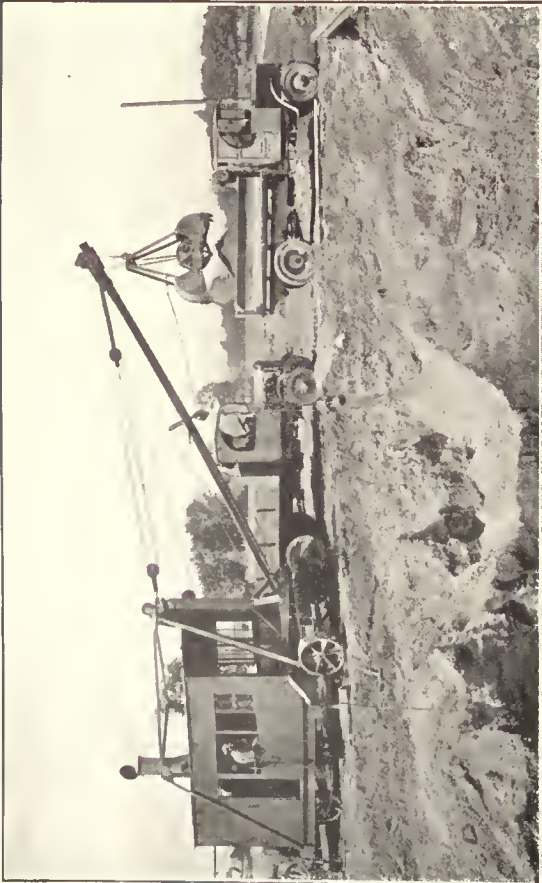

Combined Locomotive Crane and Derrick Equipped with Tractor Wheels Handling Gravel with Two-line Power-wheel Grab Bucket. Steam Operation



Locomotive Crane Equipped with Crawler Traction Handling Loose Materials from Railroad Car. Gasoline Motor Operation

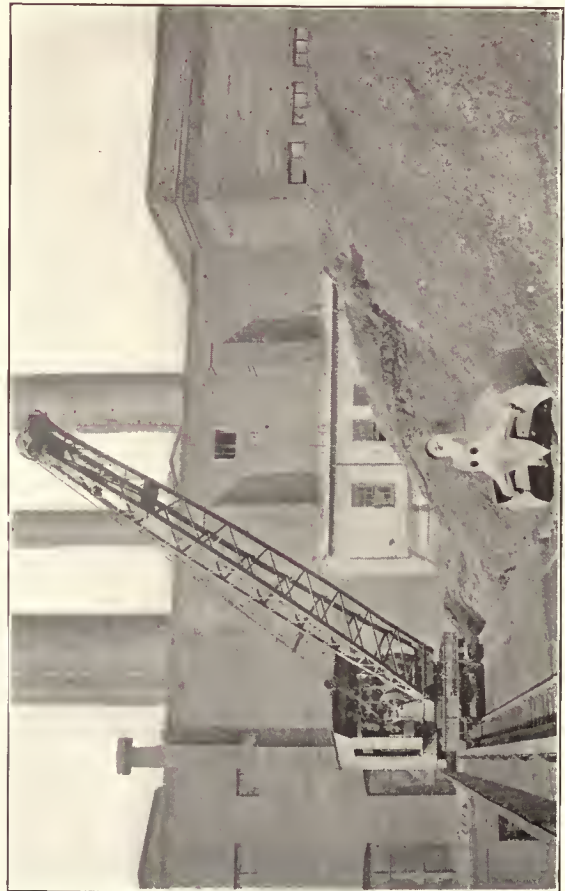

Locomotive Crane Handling Fuel at Power House with Two-rope Grab Bucket. Electric Third-rail Operation

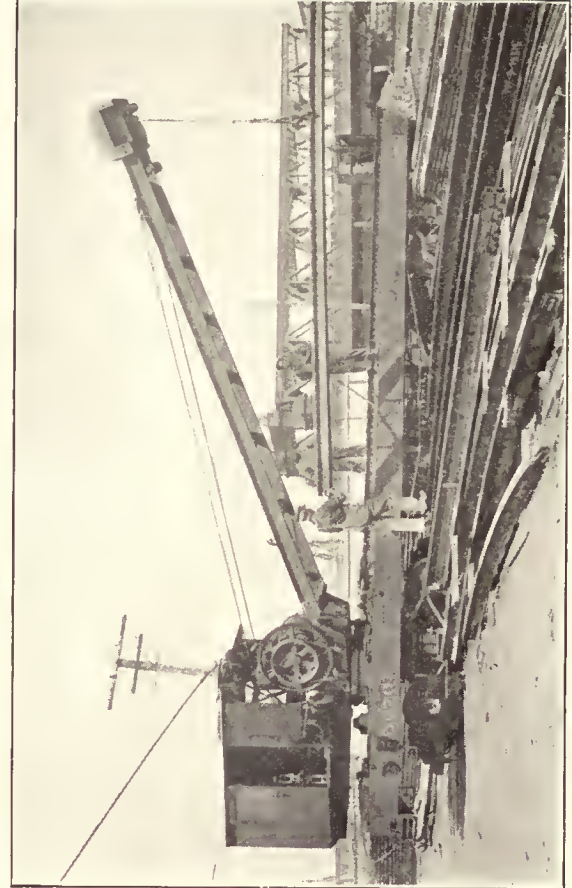

Locomotive Crane Mounted on Railroad Car Handling Rails with Hoisting Hook and Clamp. Electric Overhead Trolley Operation

secured to the side of the car frame by hinges or held in sockets; or they may be formed of I-beams telescoping under the car. When in use they are swung outward and supported on blocking or by screw jacks resting on the blocking.

In another form of outrigger, known as the stability-wheel type, the crane truck axles are extended and wheels are secured to the ends. These wheels run on an additional rail laid on either side or both sides of the track supporting the crane trucks.

Rail clamps—generally four in number—are used instead of outriggers on cranes of light capacity and sometimes are also used on those of heavy capacity having outriggers. They are secured to some part of the underframe and clamp over the rail head, thus holding the crane down on the rails.

Power

The power plant is installed on the crane turntable on the end opposite to the boom and thus serves also as a counterbalance to the load. The type of power used varies with the service required and the location in which the crane is to be operated. It may consist of a steam boiler and engine; a gasoline engine; or electric power.

Steam Cranes

Steam power is most commonly used and usually consists of a twin-cylinder engine installed on the turntable and supplied with steam by an upright boiler also carried on the turntable. Coal is generally used as fuel but oil has also been used successfully. Both fuel and water are carried on the crane structure.

Steam operated locomotive cranes range in capacities upward to 160 tons and are equipped with booms up to about 170 ft. in length. They may be equipped with a fall-block and hoisting hook and used with a sling, with grab-hooks, tongs, or grapples; may be equipped for bucket operation; or may be provided with an electric generator equipment—operated by steam from the crane power plant—and used to handle an electric lifting magnet.

Cranes thus equipped are independent of any outside source of power. They may be used wherever tracks can be provided or where the land is sufficiently stable to permit the trackless types of steam cranes to travel.

They may also be provided with a plug-in connection to an electric power line and used for magnet operation within the limits of the conductor cable.

Gasoline Cranes

Gasoline engines have, in recent years, come into use on locomotive cranes. They generally are of the four-cylinder type and of a horsepower adequate to the capacity of the crane. The engine and the gasoline storage tank are carried on the turntable. This type of crane may be mounted on rails or may be of the trackless type. It is used largely at industrial plants or at power houses or similar operation. It may be equipped with a hook for using a sling or any of the various types of grab-hooks or tongs; may be equipped for bucket operation; or supplied with electric current and used for magnet operation. Like steam cranes, gasoline operated cranes are independent of an outside source of power and may be used in similar service. They range in capacity upward to about 15 tons.

Electric Cranes

Electric locomotive cranes generally are used in the yards of industrial plants or railroads; on electric railway lines; or other places where an electric power circuit is accessible. The electric motors are mounted on the crane

turntable and are supplied with current through a contact with a third rail or an overhead trolley wire; or through a plug-in connection on an adjacent power line. Electrically operated locomotive cranes are made in capacities ranging upward to 100 tons and, within the limitations imposed by the source of power, may be used in the same service as either the steam crane or the gasoline crane. They are particularly adapted to magnet operation.

In some cases electric cranes of light capacity obtain power from storage batteries carried on the crane. They then have a wider range of action and may be used in any location to which they may travel.

Approximate capacities of locomotive cranes with booms of various lengths and used at various radii are given in the following table. These capacities may be increased from 10 per cent to 40 per cent by using rail-clamps or outriggers:

LOCOMOTIVE CRANES						
Weight of Crane, Coal, Water,	Maximum Wheel Load	Length of Boom	Capacity at Various Radii Without Outriggers			
			15 ft. Lb.	25 ft. Lb.	35 ft. Lb.	
Lb.	Lb.	Ft. In.				
184,000	45,000	40 0	45,600	23,400	14,600	
to	to	to	to	to	to	
186,000	52,000	60 0	44,800	19,700	11,600	
125,000	31,300	31 5	33,500	17,800	11,700	
to	to	to	to	to	to	
126,000	37,300	48 3½	31,500	16,600	10,500	
110,000	28,000	31 5	22,600	11,800	7,500	
to	to	to	to	to	to	
111,000	33,500	48 3½	21,500	10,600	6,400	
96,600	56,000	31 5	25,200	13,300	8,600	
to	to	to	to	to	to	
97,000	67,000	48 3½	23,900	12,000	7,300	
89,000	52,000	31 5	19,800	10,200	6,500	
to	to	to	to	to	to	
90,000	63,000	48 3½	18,600	9,100	5,400	

Wrecking Cranes

Wrecking cranes are a form of locomotive crane, very substantial in construction and ranging upward to about 160 tons capacity. They are similar in design to general service locomotive cranes but as they are intended for very heavy severe service, the various parts are more strongly built. They are used chiefly in railroad wrecking service but also are adaptable to handling heavy loads such as concrete blocks, stones, or girders, and are used extensively in bridge construction and other heavy service on railroad lines.

As they are frequently hauled in railroad trains, they are mounted on car frames similar in construction to those used for standard gage railroad cars, and are carried on trucks similar to those used under railroad cars but having provision made for connection to the crane traveling mechanism. They generally are also provided with standard automatic couplers and air-brakes.

Generally they are self-propelled and are provided with traveling mechanism installed on the underside of the car-frame and operated from the crane turntable. The turntable is rotated by a mechanism similar to that used on general service locomotive cranes, except that in cranes of very heavy capacities, the rotating gear is very much more substantial in construction and differs somewhat in details of design.

The booms usually are a combination of the web-girder and lattice-truss type of construction and seldom are more than 35 ft. to 40 ft. in length. These booms generally are curved near the top but they sometimes are made straight and much longer or are provided with an extension so that, for special work, they may range in length upward to 90 ft. or more. The shorter booms are generally used in railroad wrecking service, for which these cranes are primarily designed. They are equipped with a main hoist block and an auxiliary hoist and for a vertical lift, have



Eight-wheel Steam Locomotive Crane Handling Scrap Metal with Electric Lifting Magnet

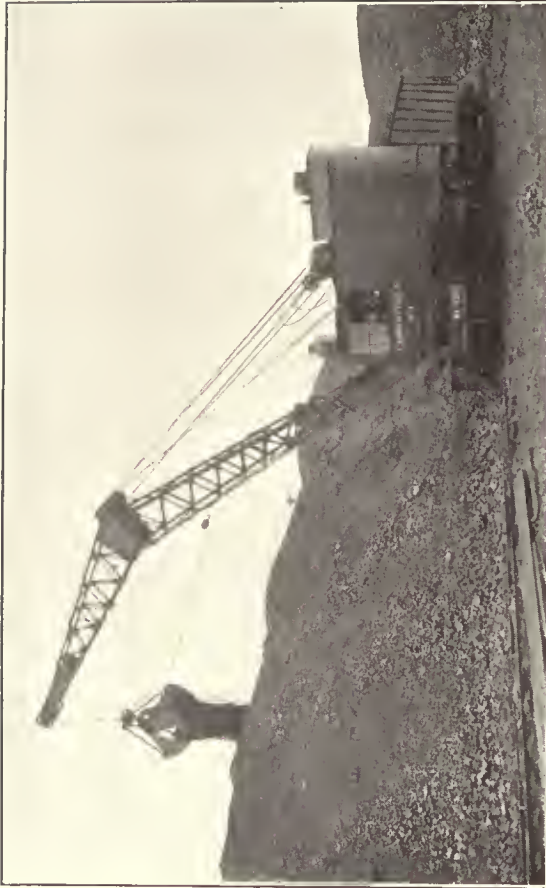

Eight-wheel Steam-operated Locomotive Crane with Bent Boom Handling Coke with a Two-line Power Wheel Type of Grab Bucket



Eight-wheel Steam Locomotive Crane Handling Dragline Bucket in Excavation Work. Side Outriggers in Place



Locomotive Dragline Cable Excavator. Mounted on a Single Truck of the Creeper-Traction Type and Equipped to Operate an Automatic Grab Bucket



Four-wheel Steam Locomotive Crane Handling Logs with Grab Hook and Chain Slings



Steam Locomotive Crane Handling Heavy Freight from Car to Lighter for Export. Equipped with Shackle, Chains and Rope Slings



Steam Locomotive Crane Handling Bottom-dump Bucket in Concrete Construction Work



Steam Locomotive Crane Handling Paving Blocks in Dump Wagon with Fall Block, Hoisting Hook, and Chain Grab Hooks



Steam Locomotive Wrecking Crane with Auxiliary Car. Boom Extended to Maximum Radius.



Double End Electric Wrecking Crane, Equipped for Third-rail Operation.



Steam Locomotive Pile Driver with Leader Frame in Partly Raised Position.

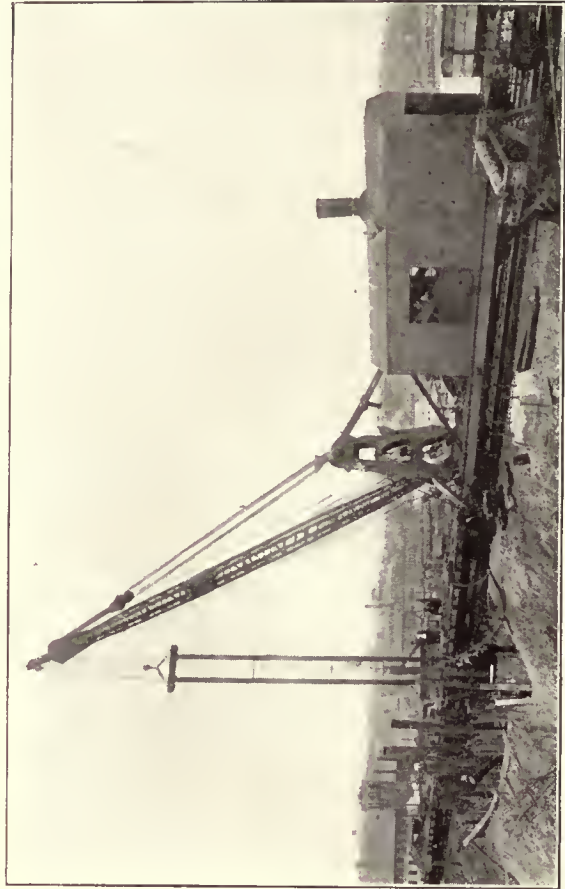

Locomotive Crane with Pile Driver Leader Suspended from the Boom, Driving Piles to Prevent Embankment Slides.

an effective radius ranging from about 15 ft. to 40 ft. The hoist line may, however, be payed out beyond the end of the boom and used to drag an object within lifting range.

The various parts of the structure are so arranged as to give maximum stability to the machine, but, in addition, these cranes are provided with outriggers which may be used on either side and on some cranes with others at the ends and with rail clamps as well.

Many of the various lifting devices used with other types of hoisting machines may be used on wrecking cranes but generally these cranes are provided with special types of hooks, slings, and other accessories adapted for wrecking service.

They generally are steam operated, the power being obtained from a steam boiler and engine carried on the rotating structure. In some cases, particularly when a crane is to be used in tunnels or subways, they are equipped for electric operation, taking their power from a third rail; through a flexible conductor cable and a plug-in connection; through an overhead trolley; or sometimes, from storage batteries carried on the crane.

Some wrecking cranes which are used only in connection with a wrecking train or a work train are not self-propelled. Very often this type of crane is not provided with a steam boiler, the crane engine being operated by steam obtained from the train locomotive or from some other outside source.

The following table gives the approximate capacities of a heavy capacity wrecking crane with the boom tackle at various radii, with and without the outriggers in use. These proportions are typical of general capacities of wrecking cranes.

LIFTING CAPACITIES, 150-TON TRAVELING WRECKING CRANE

Without Outriggers	
Main Hoist	Auxiliary Hoist (Single part of rope)
24 tons at 17-ft. radius 11 tons at 27-ft. radius.	17 tons at 23-ft. radius 8½ tons at 35-ft. radius
Either End or Center Outriggers Set	
Main Hoist	Auxiliary Hoist (2 parts of rope)
85 tons at 17-ft. radius 40 tons at 27-ft. radius	41 tons at 27-ft. radius 28 tons at 35-ft. radius
All Outriggers Set	
Main Hoist	Auxiliary Hoist (2 parts of rope)
150 tons at 17½-ft. radius 60 tons at 27½-ft. radius	45 tons at 35-ft. radius

Pile-Driver Cranes

The pile-driver embodies many features of locomotive crane construction, in some cases being simply a locomotive crane with a pile-driver attachment. Cranes of this type are used chiefly in railroad work and are mounted on double-truck cars equipped with automatic couplers and with air-brakes so that they may be hauled in a railroad train. They are designed chiefly for driving piles along a railroad line but may also be used in other locations by providing track on which to travel.

The power plant, the machinery, and the operator are located in a house or cab built on one end of the car frame, while the pile-driving apparatus is mounted on a turntable at the opposite end. The pile-driving apparatus consists of a pile-driver leader—which guides the pile and the driving hammer—supported by a swiveling frame mounted on a turntable installed on the car.

The swiveling frame is built of structural steel and cast parts in a truss form of construction. It rests in a hori-

zontal position on the turntable center casting, which is held in position by a short pintle. On some machines this frame rests on rollers so that it may be extended or withdrawn and is rotated by means of rotating gear similar to that used on locomotive cranes turning on rollers resting in or upon a runway on the upper surface of the turntable ring. It may be rotated so that piles may be driven on either side of the car, at the turntable end, or at any intermediate location. The turntable may be of a conical-roller type or of a ball-bearing type.

The pile-driver leaders are also built up of structural steel parts and consist of two side members which form a pile and hammer guide. They are secured to a frame which is hinged, at or near the bottom, to the swiveling frame. When not in use the leader frame is lowered so that it rests in a horizontal position on the top of the swiveling frame.

In one design the leader frame is raised by means of a leader raising frame. This device is hinged to the leader frame just above the top of the swiveling frame. It is carried on rollers secured to its lower end and traveling on a roller path on the upper members of the swiveling frame. It is controlled by means of a worm gear and is so arranged that the leaders may be used in a vertical position or piles may be driven with the leaders in an inclined position as may be desired.

In another design the leader frame is pivoted—at an intermediate point on the lower portion of it—to the swiveling frame. It is raised or lowered by means of lines secured to its lower end and running over sheaves at the bottom of the swiveling frame and thence to a drum on the crane mechanism.

The hammer hoisting line runs on sheaves installed at the upper end of the leader frame and is operated by means of a drum on the hoisting winch in the machinery house.

These machines are designed to drive piles with either a steam operated hammer or a drop-hammer. The steam hammer is a compact unit resting in the leader frame and it is operated by steam from the power plant on the car. The drop-hammer consists of a round or rectangular weight attached to the hoisting line by means of which it is raised in the leader guides and dropped on the pile either by reversing the winch drum or by releasing the hammer.

These cranes will drive piles 40 ft. or more in length and have a radius of action up to about 30 ft. from the center of the crane turntable.

Combination Crane Pile-Drivers

The ordinary locomotive crane is sometimes provided with a pile-driver attachment which may be attached to the crane boom itself, or the boom may be removed and the pile-driver attachment installed in its place. A crane thus equipped may be used for general purposes and also for pile-driving. When the amount of such work to be done would not warrant the expense of maintaining a special machine, the pile-driver attachment is a very desirable feature.

One type of pile-driver attachment consists of a lightly constructed hanging leader frame suspended from the outer end of the crane boom and held in a rigid position by a strut near the bottom. The attachment may be easily and quickly installed and, the entire apparatus being carried by the crane turntable, it can be rotated in a complete circle so that piles may be driven at any point within the effective radius of the crane boom.

Another type of attachment consists of a horizontal truss and a leader frame constructed and operated in the same



Battery of Semi-Portal Cranes, Boom-Jib Type, Installed on Wharf for Handling Cargo

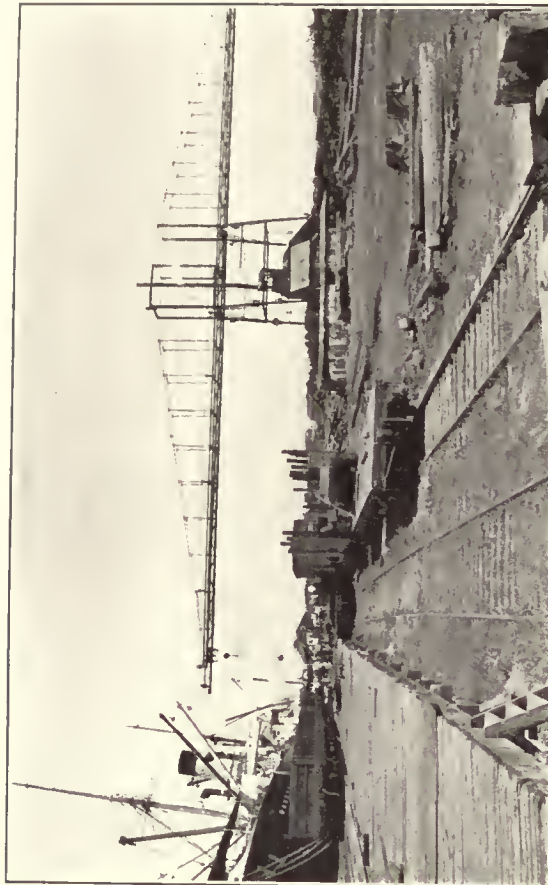

Double Cantilever Traveling Gantry Crane Installed to Serve Storage Yard, Railroad Tracks and Vessels at Wharf

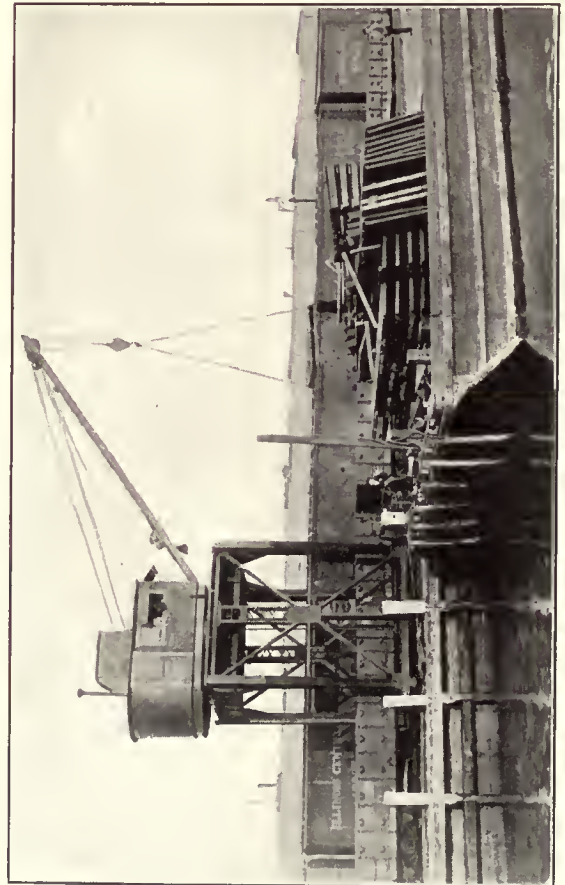

Portal Gantry Wharf Crane, Boom-Jib Type, Handling Material with Sling



Semi-Portal Wharf Gantry Cranes for Loading or Unloading Cars or Vessels

way as that used on an ordinary pile-driver. With this type of attachment, the crane boom must be removed and the truss structure secured directly to the rotating crane base. This machine also permits full-circle operation.

Wharf Cranes

Wharf or cargo cranes are used on wharves for loading or unloading cargo vessels, sometimes being designed so that they will also handle the cargo on the wharf or inside of the pier shed without the aid of auxiliary machines. Many wharf cranes are also adaptable to shipbuilding purposes. Frequently an ordinary locomotive crane or a cantilever gantry crane is used for this service but generally a special crane which combines some features of each of those types, and of overhead traveling cranes, is built. The type of construction varies with the location in which the crane is to be installed and the service required.

These cranes may travel on tracks laid on the wharf, or on an elevated runway secured to the side or on the roof of the pier shed, or inside of the shed. In some cases they are of the stationary type. They may be of the portal or the semi-portal type of construction with some form of boom or jib crane—generally having a topping-lift and variable radius, but sometimes having a fixed radius boom—mounted on it; may be of the cantilever gantry bridge type of construction and equipped with a crane trolley; or may consist of some form of rotating crane mounted on a raised pier, on a tower, or sometimes on a barge or pontoon. They are operated by either steam or electric power.

Portal Crane—Cantilever-Trolley Type

The cantilever portal wharf crane consists of a cantilever bridge mounted on a traveling portal-gantry structure and having one or more crane trolleys traversing its entire length. The gantry structure is mounted on trucks traveling on rails laid on the wharf and it generally spans one or more standard gage railroad tracks, also laid on the wharf. Usually the bridge is fixed rigidly to the gantry structure but it may be mounted on a turntable and arranged to rotate. One of the cantilever ends of the bridge projects to the edge of the wharf while the other end projects over other railroad tracks, on or alongside of the wharf; over a storage yard; or may extend over the water at both sides of the wharf.

The crane trolley may be equipped with any form of hoisting accessory used on other cranes of the bridge type of construction and may be used for handling cargo either in package form or in loose bulk. This type of crane is also frequently installed on a runway between ships ways and is used in shipbuilding service for erection work or for fitting out purposes. Such cranes are made with a total span of 200 ft. or more and they usually have a lifting capacity of about 10 tons to 15 tons at the ends of the cantilevers and a greater capacity with the hoist at intermediate points.

Portal Crane—Boom-Jib Type

The boom-jib portal crane is another form of wharf crane and consists of a traveling portal-gantry structure—sometimes also having a single or a double cantilever—with some form of boom-jib or locomotive crane traversing the bridge. The gantry spans standard gage railroad tracks and sometimes also a roadway and travels on rails laid on the wharf. To give it greater stability, the

locomotive crane generally is made to travel on broad gage tracks laid on the bridge and it usually is provided with an "A" frame topping-lift connection instead of the short mast or pillar used on ordinary locomotive cranes. This crane rotates on a turntable and may be used in the same manner as any other locomotive crane. It may be equipped for general hoisting purposes or for bucket operation and may be used for general cargo handling or for shipbuilding purposes.

A similar crane of more limited scope consists of the rotating portion of a locomotive crane revolving on a turntable fixed on a traveling gantry bridge or portal tower. This crane operates in the same manner as the traversing crane and, within its radius of action, may be used for the same purposes.

A revolving boom-jib crane is sometimes installed on a fixed or stationary portal tower in a location where the boom will serve for cargo handling or for other purposes. The turntable rotating mechanism may be operated from the ground by means of a slewing shaft while the hoisting apparatus is operated by a power plant installed on the crane turntable; or the entire apparatus may be operated by the power plant on the turntable.

Boom-jib cranes have booms ranging in length upward to 100 ft. or more and have a lifting capacity upward to about 150 tons.

Semi-Portal Crane—Boom-Jib Type

The semi-portal wharf crane is especially designed for installation on a pier having a long narrow space or apron alongside of the pier shed. It consists of a single leg gantry structure having some form of rotating hoisting machine mounted on the bridge. A machine of this type is installed on a wharf with the single gantry leg resting on a rail laid on the wharf while the opposite end of the bridge is mounted on a single rail runway secured to the side of the pier shed or mounted on the roof. On a very long wharf a series of such cranes is usually installed. The hoisting machine is mounted on a turntable fixed at the outer end of the gantry bridge and has a boom of sufficient length to handle material direct from the hold of a vessel to the door of the pier shed or to load it directly into a railroad car or on a truck standing on the wharf. Cranes of this type are used in the same manner as the full portal types but have a more limited radius of action. They commonly have a capacity upward to about 4 tons to 5 tons at a radius of about 25 ft. to 30 ft.

Semi-Portal Crane—Inclined Boom Type

Another type of semi-wharf crane is constructed in the same manner as the boom-jib type except that the rotating crane is replaced by an inclined boom equipped with a trolley hoist. The boom is supported at the outer end of the gantry structure so that it may travel a limited distance inboard or outboard and may be raised, by a topping-lift, to a vertical position to permit the crane to travel along the wharf without interference with a vessel or other obstruction. The crane may traverse the wharf so that the boom may be lowered into a position over the hatch of a vessel and the cargo handled directly from the hold to a car on the wharf or, by extending the inboard end of the inclined boom inside of the pier shed, the cargo may be carried into the shed for storage or may be loaded on trucks for distribution.

A modification of this type of wharf crane is adapted for use on a pier having a very narrow space outside of the

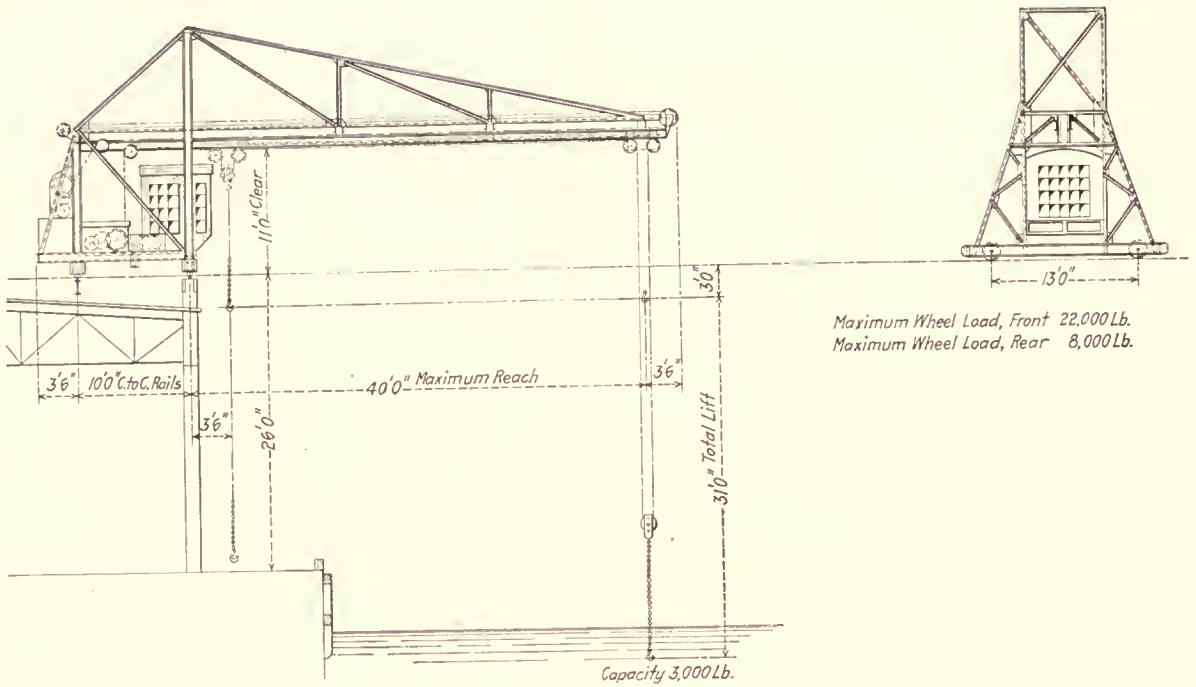

Traveling Wharf Roof Crane with Fixed Boom Equipped with Hoisting Trolley, Installed on Pier Having Narrow Apron

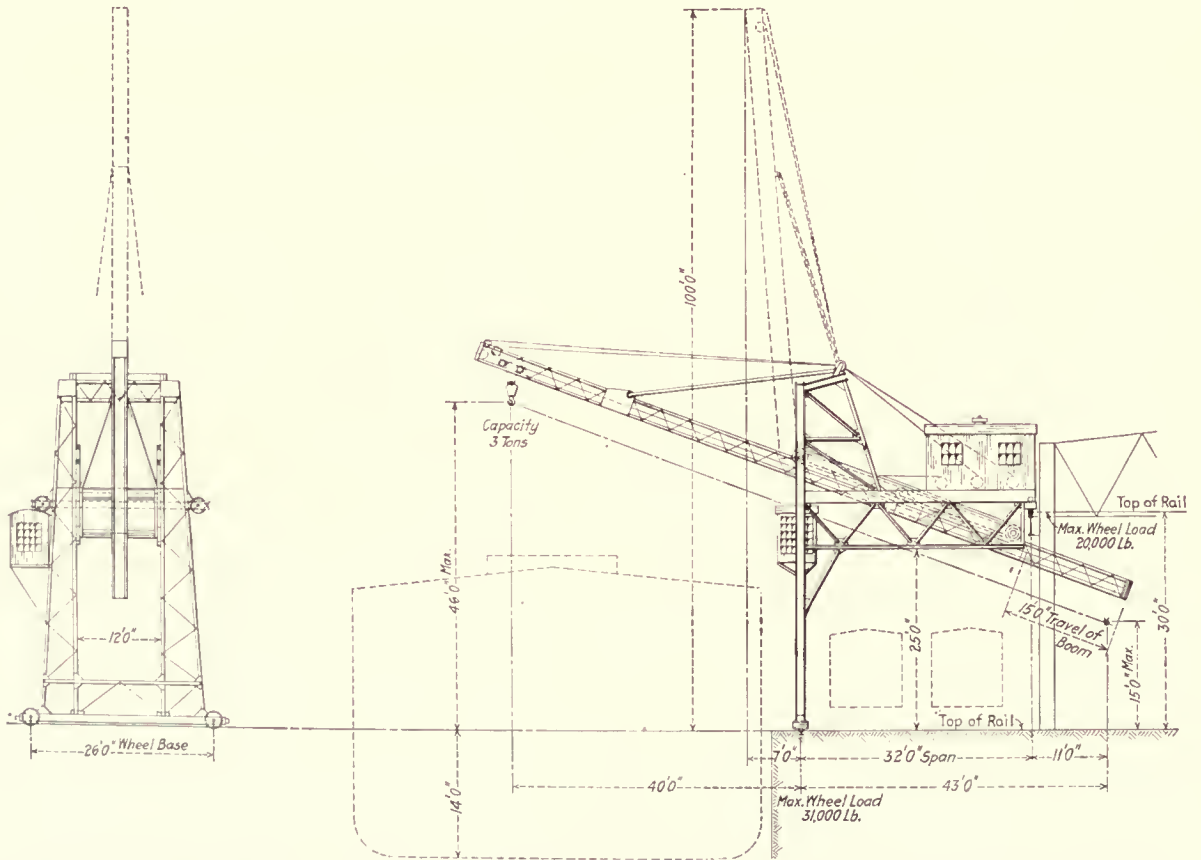

Semi-Portial Wharf Crane with Inclined Boom Equipped with Hoisting Trolley for Delivery Inside of Pier Shed

List of Parts.

- 1 Pier
- 2 Pier Shed
- 3 Vessel
- 4 Water Level
- 5 Railroad Track
- 6 Gantry Bridge
- 7 Gantry Legs
- 8 Gantry Trucks
- 9 Gantry Machinery House
- 10 Folding Jib
- JIB TELPHER:
 - 11 Monorail
 - 12 Trolley
 - 13 Hoist Hooks
 - 14 Cab
 - 15 Fixed Cantilever
- CANTILEVER TELPHER:
 - 16 Monorail
 - 17 Trolley
 - 18 Hoist Hooks
 - 19 Cab

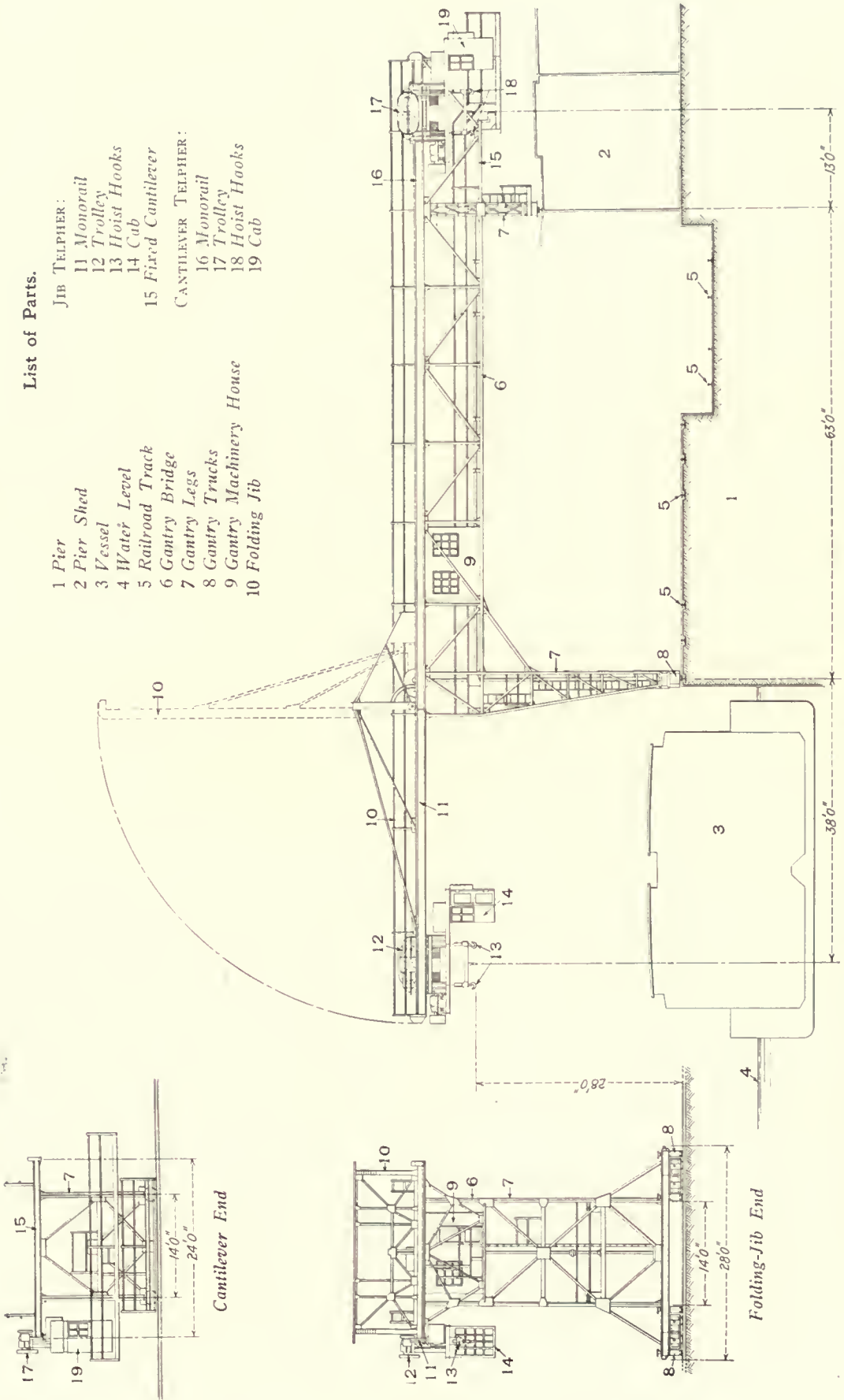

Electric Traveling Folding-Jib, Cantilever Gantry Wharf Crane Equipped with Monorail Telpher on Jib and on Cantilever



Rotary-Jib Type of Wharf Roof Crane Installed on Steep-Pitched Shed Roof for Handling Cargo

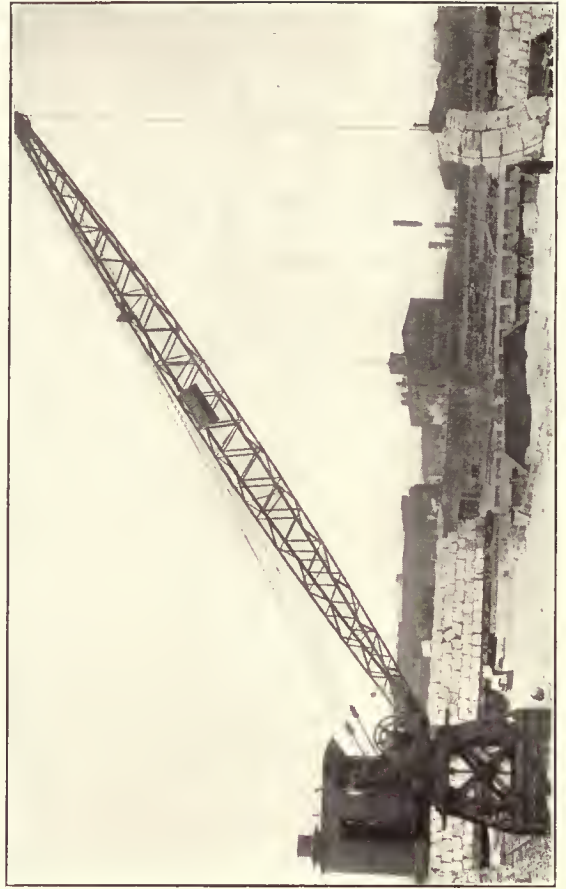

Traveling Raised-Pier Boom-Jib Crane Handling Paper Pulp



Two Hinged-Boom Trolley Type of Wharf Roof Cranes Adapted to Handle Cargo Direct from Hold to Warehouse

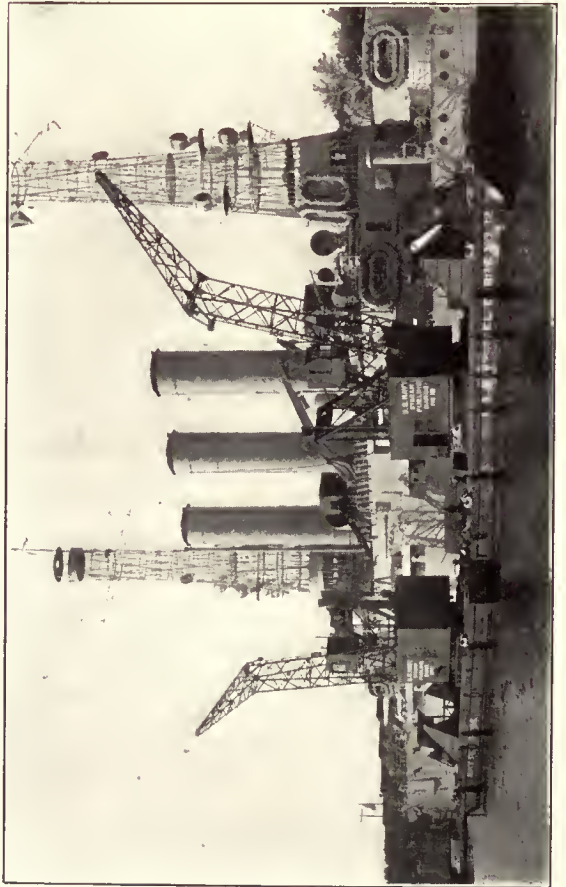

Boom-Jib Cranes with Bent Boom. Mounted on Pontoon for Marine Service

shed. In this case the inclined boom is supported by a single gantry leg traveling on a rail laid along the edge of the wharf and is held in an upright position by wheels bearing against the inside of an overhanging single rail runway secured to the shed. The inclined boom is controlled by a topping-lift and is equipped with a racking trolley hoist. This machine handles the cargo directly from the hold of a vessel to the inside of the shed where it may be distributed as desired.

Cranes of the inclined boom type have no circular movement. They have a capacity of about 3 tons to 4 tons at the maximum effective reach which ranges upward to about 40 ft. outboard or inboard.

Racking-Cantilever Crane

A wharf crane of the racking-cantilever type has been designed to handle cargo inside of the pier shed as well as to load or unload vessels. This crane consists of an overhead traveling bridge, mounted on a runway installed inside of the pier shed and having a racking cantilever which may be extended outward—through a doorway or other opening—over the wharf or over a vessel at either side. The cantilever may be equipped with a crane trolley which can be used in the same manner as on any overhead traveling crane; or a monorail hoist or a telfer may be installed on a monorail secured to the cantilever and operated as an auxiliary to the crane.

This type of crane may be used to load cargo into a vessel either from the pier shed or direct from railroad cars, on tracks on or adjacent to the wharf. The process is reversed for unloading cargo. When the crane is not required for loading or unloading purposes, the cantilever is drawn in under the traveling bridge and the apparatus may be used inside of the pier shed for handling material in the same manner as with an ordinary overhead traveling crane. These cranes usually have a total span of 100 ft. to 150 ft. and a capacity of 4 tons to 5 tons at either end of the cantilever.

Raised-Pier Crane

The raised-pier wharf crane⁶ usually consists of a rotating hoisting machine, similar to the rotating portion of a locomotive crane, mounted on a structural steel traveling pier or low tower. The form of construction is similar to that used for a portal-tower but the pier structure usually is lower and has no portal to permit a passage underneath the crane. This type of crane may be used for many of the same purposes and in the same manner as an ordinary locomotive crane.

For some purposes, such as at a small coaling wharf, the pier is made stationary. The pier structure is then built of structural steel and fixed to a solid foundation; or the crane turntable may be mounted directly on a pier of concrete.

Barge or Pontoon Cranes

Barge cranes are sometimes used for handling cargo at wharves or for coaling vessels. Such cranes consist of some form of rotary crane—usually similar to the rotating portion of a locomotive crane or a modification of the pintle tower type—mounted on a barge or pontoon. Generally the boom is of the goose-neck type so that the crane may operate close alongside a vessel with the boom raised to an approximately vertical position but at the same time have a radius of action sufficient to move the material over a considerable area. Sometimes these cranes are also

used in shipyards for erection work or for fitting-out purposes. The booms range in length up to about 90 ft. or 100 ft. as on other boom-jib cranes. The capacities range upward to 150 tons or more.

Roof Cranes

Roof cranes are made with the crane structure in various forms and are mounted on a runway installed on the roof of the pier shed. Cranes of the roof type may be installed on any pier shed having sufficient strength to sustain the load. They are particularly desirable for use on piers having very little or no apron or wharf space to permit the installation of other types of hoisting machines. These cranes may be of the fixed horizontal jib type or of the hinged or folding boom type without rotary motion; or may be of the boom-jib type having a variable radius and a rotary movement. They are designed solely for cargo handling and may be used to supplement the cargo handling gear installed on a vessel or may be used independently of it.

Trolley Type—Hinged Boom

One type of roof crane consists of a boom hinged to a traveling frame constructed in a manner similar to that of the bridge of an overhead traveling crane. This traveling frame is built of structural steel and is mounted on a runway installed on the roof of the pier shed. It carries the machinery house and the boom topping-lift frame. The boom is hinged—at an intermediate point—to the traveling frame and the topping-lift is rigged so that the boom may be raised to a vertical position to permit the crane to travel along the wharf without interference with the pier shed, a vessel alongside of the wharf, or any other obstruction. The boom hinge is located so that when the boom is lowered the outer end of it will project over the edge of the wharf or the hatch of a vessel while the inner end of the boom extends through a doorway to the inside of the shed. A racking trolley hoist similar to that used on many overhead cranes is installed on the boom and traverses practically its entire length. The operator's cab is suspended from the structure so that the operator has a close view of the work.

With this type of crane the vessel is placed so that the hatch is in line with a doorway in the pier shed, the boom is then lowered into a horizontal or an inclined position—it will operate at any angle up to 45 deg.—and the trolley hoist is lowered directly into the hold. The load is hoisted from the hold and carried along the boom to the inside of the pier shed where it may be deposited directly on a delivery truck, or on some other vehicle for sorting and distribution to storage on the pier. Two of these cranes may be used simultaneously over different hatches of the same vessel for loading or unloading; or one crane may be used for unloading while the other is loading cargo. They have a reach of about 25 ft. outboard and about 10 ft. inside of the shed, with a capacity of 1 ton to 2 tons at the maximum reach.

Trolley Type—Fixed Jib

The fixed-jib type of wharf crane is adapted to light cargo handling. It consists of a fixed horizontal top and back braced jib mounted on a frame or carriage which travels on a runway on the shed roof. A racking trolley hoist, operated by power carried on the traveling structure, traverses the jib. This type of crane may be propelled along the shed so that the jib is over the hatch of a ves-

HOISTING MACHINERY

List of Parts.

- | | | |
|----------------------|-------------------------------|--|
| 1 Pier Shed | 10 Racking Cantilever | |
| 2 Pier | 11 Cantilever Motor | |
| 3 Water Level | TELPHER: | |
| 4 Railroad Track | 12 Monorail | |
| 5 Traveling Bridge | 13 Trolley | |
| 6 Bridge Runway | 14 Motor | |
| 7 Bridge Drive Motor | 15 Hoist Hooks | |
| 8 Squaring Shaft | 16 Operator's Cab | |
| 9 Bridge Truck | 17 Enclosed Automatic Control | |

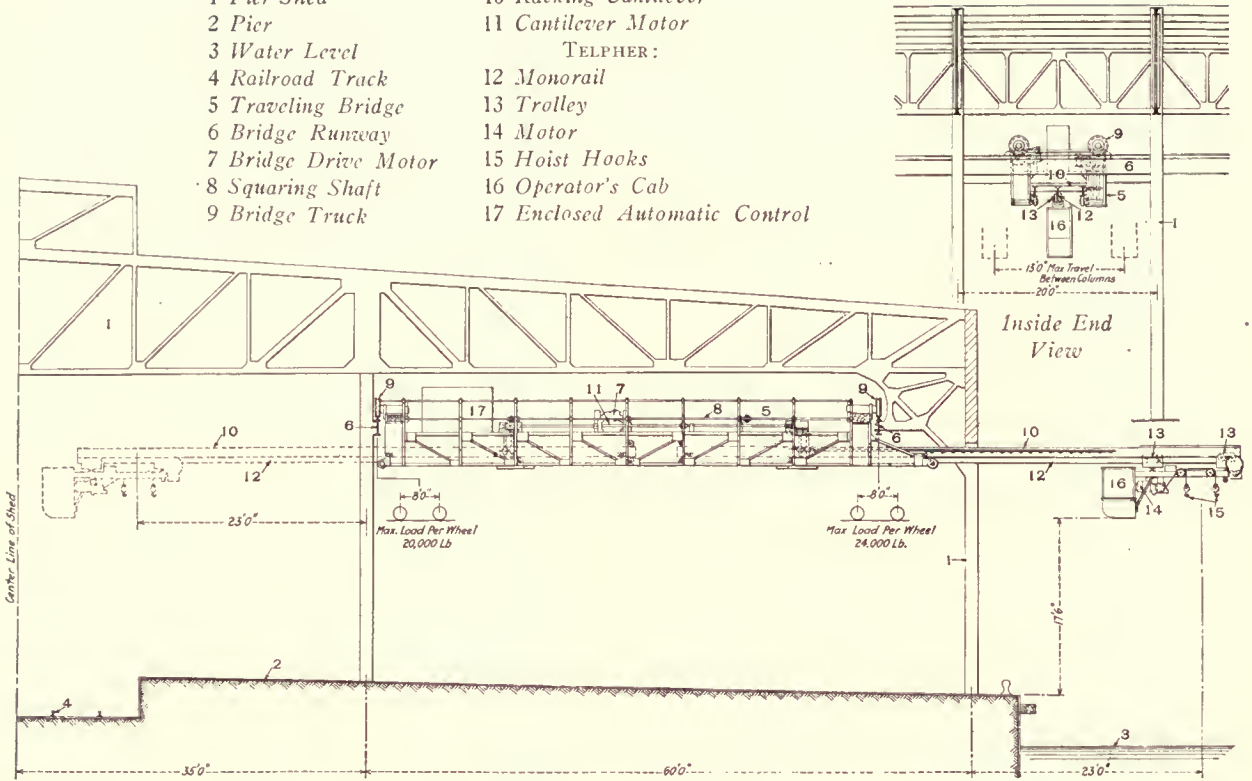

Electric Traveling-Bridge Racking-Cantilever Crane with 4-Ton Capacity Monorail Telfer



Stationary Hammerhead Portal Crane Installed in Philadelphia Navy Yard. Capacity 350 Tons at 115 ft. Radius; 50 Tons at 90 ft. Radius. Overall Height, 230 ft.

set and the hoisting apparatus may then be operated in the usual way. The jib has a maximum effective reach of about 40 ft. with a capacity of about 1½ tons at that distance. As the jib rarely has a clearance of more than about 35 ft. above the wharf, this type of crane can be used only for unloading barges or other vessels having low masts or superstructures.

Rotary Type

The rotary type of wharf roof crane is used largely in British practice for cargo handling. It is installed on pier sheds having a ridge roof. In this design a boom or jib is supported by a short pivoted mast mounted on a frame carried on trucks which travel on a runway on the shed roof. One rail of the runway is laid at the edge of the roof, the other at the ridge. The mast is pivoted in a frame resting on the lower truck and supported by a truss extending to the upper end of the traveling frame which usually projects beyond the upper or ridge truck. A portion of the crane machinery or a counterweight is placed on this extension to give stability to the structure. The boom usually has a fixed radius and is secured to the base of the pivoted mast. The hoist line operates over sheaves at the outer end of the boom and on the mast. The operator's cab is carried on the traveling structure and is located at the edge of the roof so that the operator has a clear view of the work.

This type of crane may be used in the same manner as other rotary cranes of fixed radius construction but, because of its location, should be used only for comparatively light work.

Shipbuilding Cranes

Shipbuilding cranes are made in many different designs and most of them are used in shipyards for both erection work and for fitting out. Many of them are also used at dry docks or basins for repair work. As the service in which they are used requires high clearance with a wide range of action, most cranes designed for shipbuilding purposes embody some form of tower construction and have the hoisting apparatus on a boom or a cantilever truss of considerable length.

Cantilever structures of both the hammerhead pintle type and the turntable type mounted on towers; traveling tower boom-jib cranes; and various modifications of the traveling or the stationary gantry, are used. In some shipyards the operating conditions permit the use of the overhead traveling crane or the locomotive crane. The latter is generally mounted on broad gage tracks and is fitted with a boom of the goose-neck type. Shipbuilding cranes may be operated by steam or by electric power.

Revolving Cantilever—Hammerhead Type

The hammerhead crane—so called because it resembles a hammerhead in shape—is extensively used for shipbuilding purposes. It consists of a rotating cantilever structure secured to a pintle and mounted on a tower which usually has a portal base and is fixed to a solid foundation but sometimes is mounted on trucks and travels on rails. The cantilever rests on the top of the tower and is supported by the pintle. The pintle is constructed in the form of a mast of the lattice truss type. It rests in contact with side bearings at the top of the tower and extending downward is stepped in a lower bearing secured to the inside of the tower.

On some hammerhead cranes of very heavy capacity, the

pintle is secured to the portal base structure instead of the cantilever truss, and projects upward inside of a rotating tower or skirt fixed to the cantilever truss. The entire structure revolves on a turntable resting on the portal base.

The forward end of the revolving cantilever crane is fitted with one or more racking trolleys operated by machinery which is carried on the extended rear end of the cantilever and is enclosed with the rotating mechanism in a machinery house. The crane counterweight is installed at the rear of the machinery house. The operator's cab is suspended underneath the cantilever truss near the tower so that the operator has a clear view of the work at all times.

Cranes of this type commonly have a radius of action upward to about 100 ft. with a capacity of 5 tons to 75 tons at the maximum effective radius of the hoist. They are, however, made with effective radii upward to 190 ft. or more with a capacity of about 50 tons at that radius, and upward to 350 tons capacity at a shorter radius. The towers range in height upward to 200 ft. or more. These cranes may be used singly to serve one or two ships ways but usually are installed in groups with the cantilevers overlapping so that an entire shipyard, including the ways and the storage yard, may be served. The following tables illustrate the wide range in the proportions of cranes of the hammerhead type.

5-10 TON CAPACITY HAMMERHEAD CRANE

	Ft.	In.	Cap. in Tons	Ft. Per Minute
Maximum radius	95	0
Minimum radius	11	6
At 95 ft. radius	5
At 70 ft. radius	7.5
At 50 ft. radius	10
Hoisting speed with two-part line	5,000 lb.		90
	10,000 lb.		50
	20,000 lb.		25
Trolley racking speed	No load		140
	5-ton load		100
	10-ton load		55
Slewing speed	No load		300
	Maximum load		200

350-TON CAPACITY HAMMERHEAD CRANE

	Min. Rad., Ft.	Max. Rad., Ft.	Cap. at Max. Rad., Tons	Ft. Per Minute
Each main hoist	41	115	175
Both main hoist, acting as a single unit	41	115	350
Two 8-part lines on each hoist, 32-part line for maximum lift.				
Auxiliary hoist	41	190	50
Two 4-part lines.				
Hoist speed:				Ft. Per Minute
Main hoists, single or jointly with maximum load				2.5
Main hoists, singly or jointly with no load				10.0
Auxiliary hoist with maximum load				12.0
Auxiliary hoist with no load				30.0
Trolley racking speed:			
Main hoists, single or jointly with maximum load				12.0
Main hoists, single or jointly with no load				100.0
Auxiliary hoist with maximum load				100.0
Auxiliary hoist with no load				150.0
Slewing speed = one revolution in 12 minutes.				

Revolving Cantilever—Turntable Type

The turntable type of revolving cantilever crane is similar in general construction to the hammerhead pintle type. It consists of a rotating cantilever truss mounted on a turntable installed at the top of a tower—usually a stationary tower. The forward end of the cantilever is equipped with a racking trolley which carries the hoisting tackle. The hoisting mechanism and the crane rotating mechanism is installed on the cantilever truss and is enclosed in a machinery house which generally also serves as the operator's cab. The machinery house may be directly over the turn-



Portal Gantry Cranes Equipped with Boom-Jibs for Shipyard Work

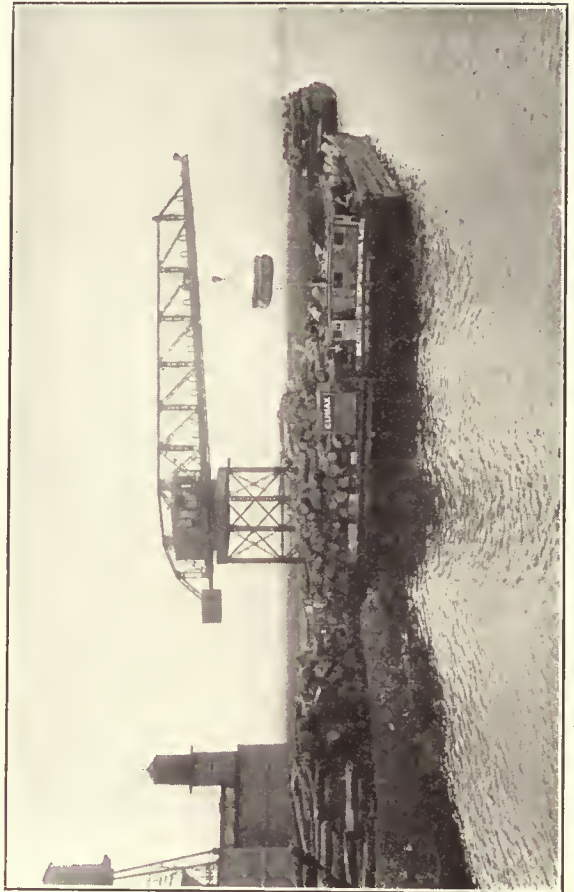

Thrrtable Type of Revolving Cantilever Crane Unloading Logs at Wharf of Paper Pulp Mill



Battery of Traveling Portal Cranes, Boom-Jib Type, Installed at Ship Fitting-Out Basin

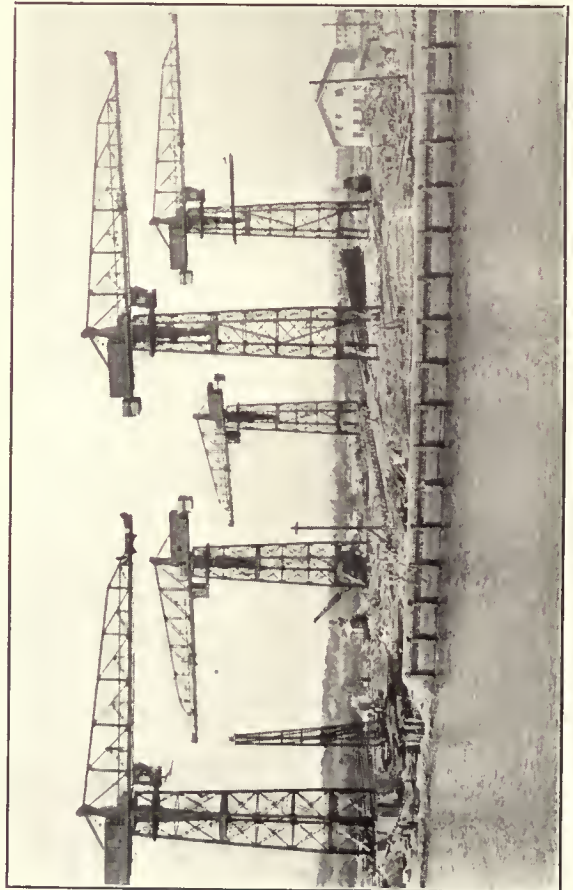

Battery of Stationary Hammerhead Type of Revolving Cantilever Cranes, Installed in Shipyard

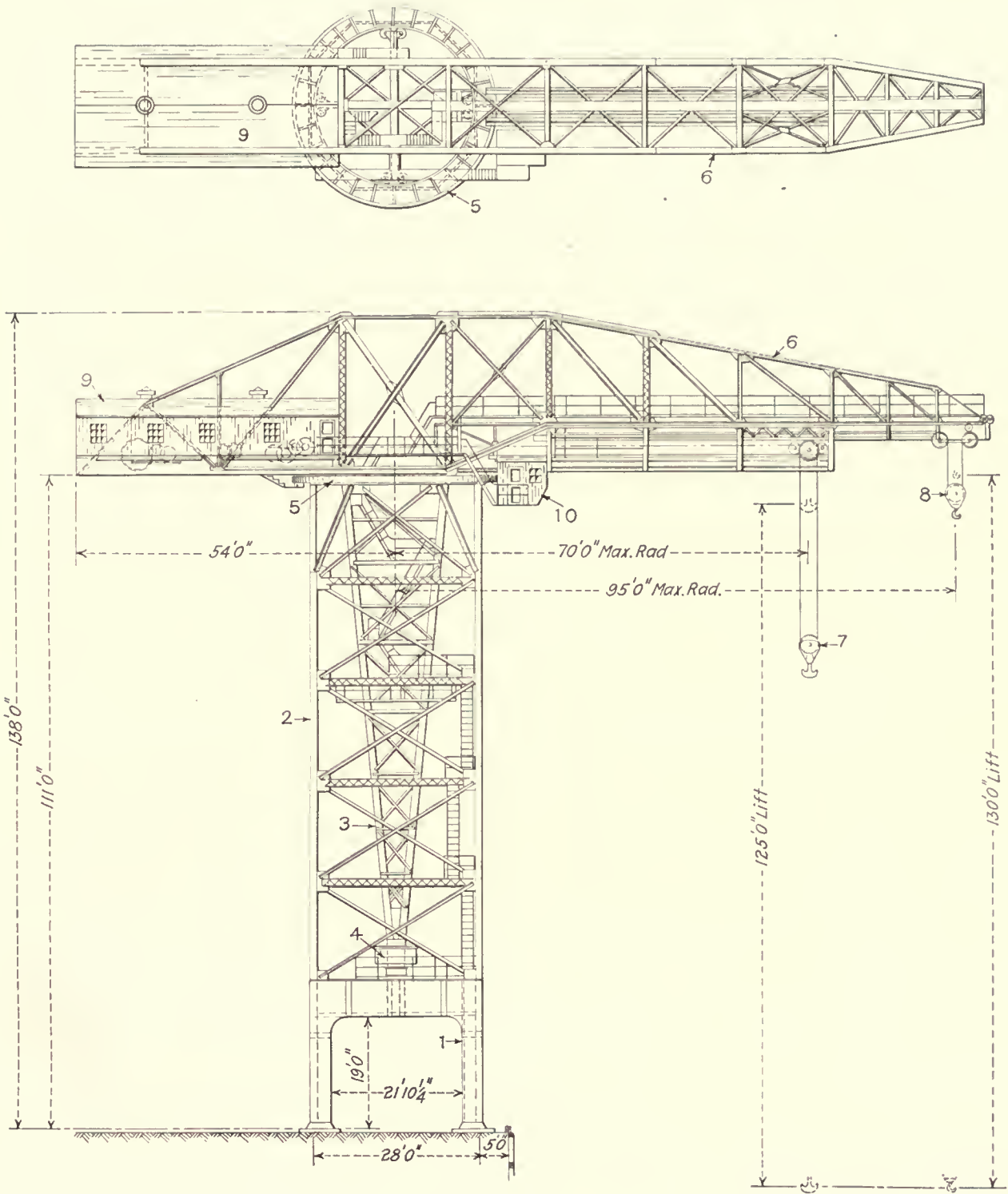

List of Parts.

- | | |
|---------------------|-------------------------|
| 1 Fixed Portal Pier | 6 Hammerhead Jib |
| 2 Tower | 7 Main Hoist Block |
| 3 Pintle | 8 Auxiliary Hoist Block |
| 4 Pintle Bearing | 9 Machinery House |
| 5 Turntable Ring | 10 Operator's Cab |

Electrically Operated Hammerhead Crane for Fitting Out Service in Shipyards. Pintle Type, 75-Ton Capacity

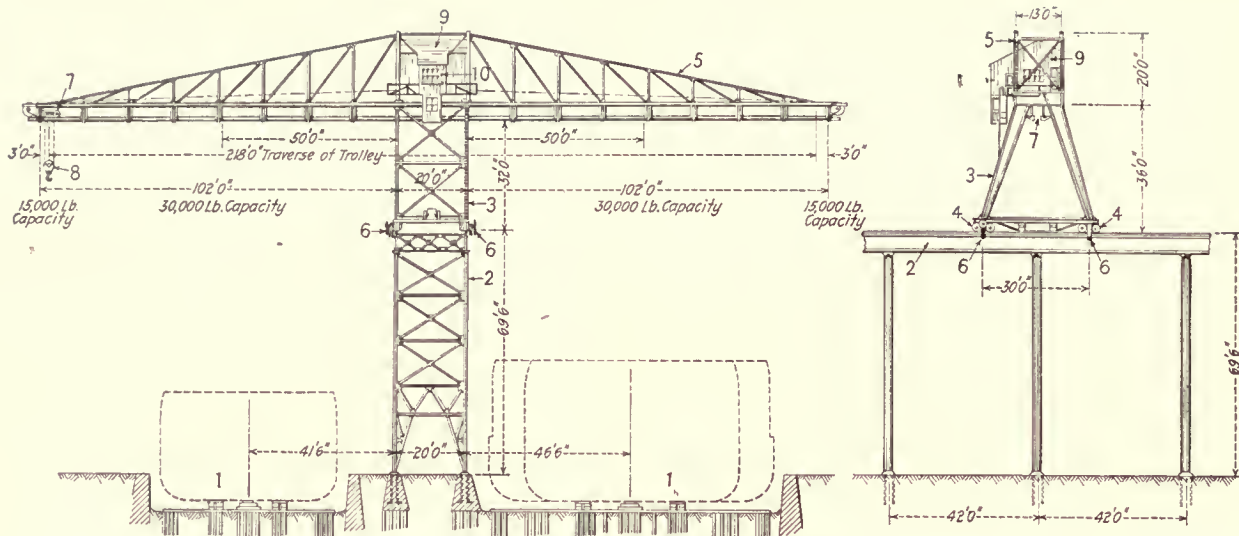

List of Parts.

- | | | |
|----------------|---------------------|-------------------|
| 1 Ship Ways | 4 Gantry Truck | 7 Trolley |
| 2 Crane Runway | 5 Cantilever Bridge | 8 Hoist Block |
| 3 Crane Gantry | 6 Current Collector | 9 Machinery House |

Electric Traveling Double-Cantilever 15-Ton Capacity Shipyard Gantry Crane on Elevated Runway

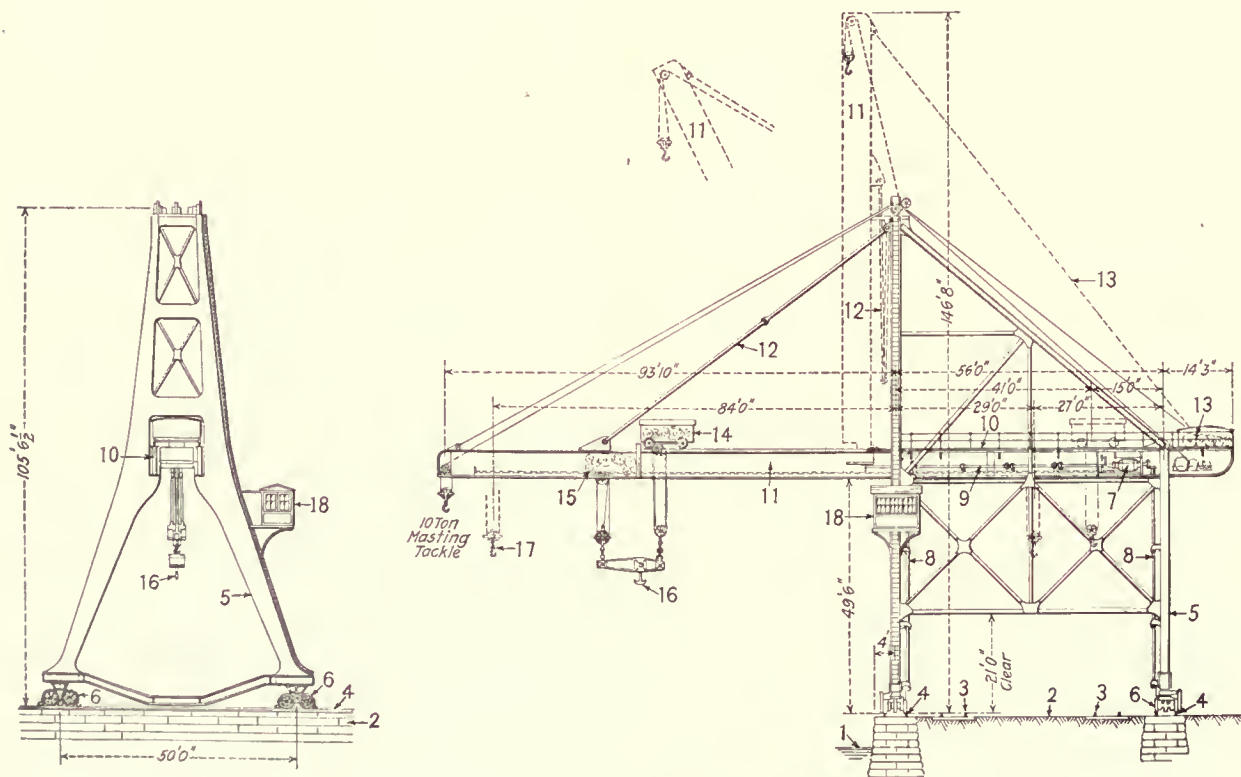

List of Parts.

- | | | |
|-------------------|---------------------|--------------------|
| 1 Water Level | 7 Truck Drive Motor | 13 Jib Hoist |
| 2 Wharf | 8 Truck Drive Shaft | 14 50-Ton Trolley |
| 3 Railroad Tracks | 9 Squaring Shaft | 15 25-Ton Trolley |
| 4 Crane Runway | 10 Bridge | 16 Main Hoist Hook |
| 5 Portal Gantry | 11 Folding Jib | 17 Maximum Reach |
| 6 Gantry Trucks | 12 Jib Truss-Rod | 18 Operator's Cab |

Folding-Jib Traveling Gantry Wharf Crane for Shipyard Fitting Out Service. 75-Ton Capacity

table with a counterweight on the rear end of the cantilever; or the machinery may be located at the rear end and serve as a counterweight.

Cranes of this type are used in shipbuilding service and also in some industrial operations such as handling lumber and logs. They are made with an effective radius up to about 75 ft. to 100 ft. and with towers upward to 100 ft. or more in height. The lifting capacity at the maximum effective radius ranges from 5 tons to about 15 tons with an increasingly greater capacity at shorter radii.

Folding-Jib Gantry Cranes

Folding-jib gantry cranes are used in shipyards chiefly for fitting out ships but they are also adaptable to other purposes such as unloading cargo vessels. This type of crane consists of a traveling gantry structure spanning one or more railroad tracks and having a superstructure which supports a folding-jib. The jib is hinged to the gantry structure at the outboard end of the bridge so that it may be raised, by means of a topping-lift, and folded back against the vertical member of the superstructure. This permits the crane to travel along a wharf, with a vessel alongside, without interference. Usually a main trolley and an auxiliary trolley are arranged to travel on both the bridge and the folding jib so that the hoists may be used for practically the entire length of the structure. Many cranes of this type are also equipped with a hoisting tackle fixed at the end of the folding jib. The operating mechanism is installed on the inboard end of the gantry bridge. The gantry legs or trestles are constructed so that the load may be taken by the trolley hoist from a railroad car or other vehicle on the wharf underneath the bridge and carried between the trestle columns outward on the jib and placed on a vessel. The structure is equipped with a driving

mechanism similar to that used for propelling other traveling gantry cranes.

Such cranes are made with a combined length of bridge and folding-jib upward to about 150 ft. and with a total capacity of about 75 tons to 100 tons.

Boom-Jib Revolving Tower Cranes

Revolving tower cranes of the boom-jib type are used largely in shipyards for fitting out and also are used for general hoisting purposes. This type of crane consists of a rotating boom-jib crane, similar to the rotating portion of a locomotive crane, mounted on a tower which is carried on a traveling portal base. The portal base spans one or more railroad tracks and is mounted on trucks which travel on rails laid on the wharf. Such cranes are generally operated by steam power generated by a power plant installed on the rotating portion of the crane. The approximate proportions and capacities of some cranes of this type are given in the following table:

BOOM-JIB REVOLVING TOWER CRANES				
Capacity	6 Tons at 40 Ft. Rad.	9 Tons at 40 Ft. Rad.	15 Tons at 60 Ft. Rad.	25 Tons at 60 Ft. Rad.
Height of tower, ft....	35	45	44	44
Length of boom, ft....	55	70	98	60
Maximum operating radius, ft.	55	70	100	60
Minimum operating radius, ft.	15	20	25	20
	Feet Per Minute			
Hoisting speed	120	100	75	50
Traveling speed.....	125	125	150	100
Stewing speed, revolutions, per minute....	3	3	3	2

Various other cranes which combine features of several different types are used in shipbuilding. However, as they are constructed to meet the requirements of a particular service they will not be treated in this book.

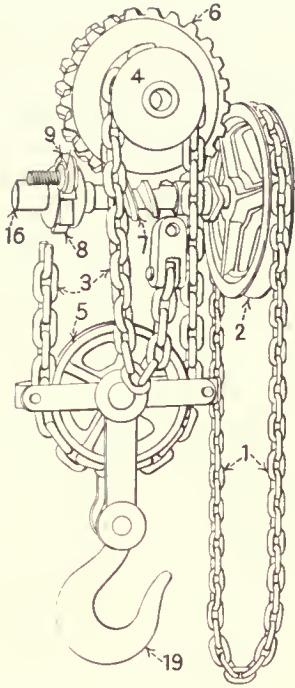

Worm Gear.

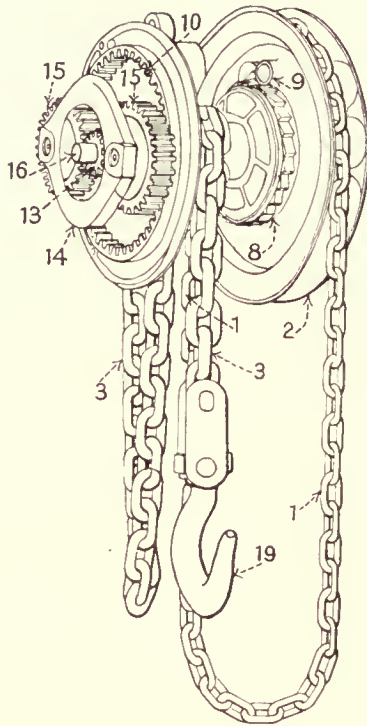

Planetary Gear.

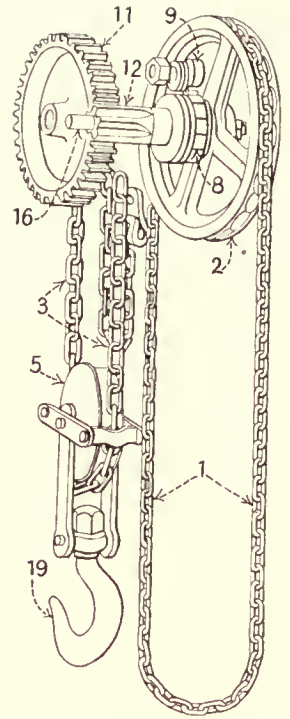

Single Spur Gear.

Chain Hoists—List of Parts.

- 1 Hand Chain
- 2 Hand Chain Wheel
- 3 Load Chain
- 4 Upper Load Sheave
- 4a Differential Sheave
- 5 Lower Load Sheave
- 6 Worm Gear

- 7 Worm
- 8 Ratchet Wheel
- 9 Ratchet Pawl
- 10 Internal Gear
- 11 Load Gear
- 12 Spur Gear
- 13 Gear Pinion

- 14 Pinion Case
- 15 Intermediate Gear
- 16 Central Shaft
- 17 Shock Absorber
- 18 Top Hook
- 19 Load Hook

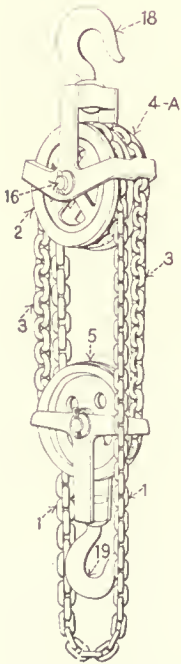

Differential.

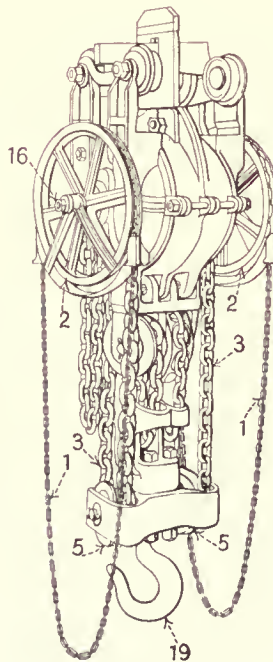

Duplex Gyrotory Gear.

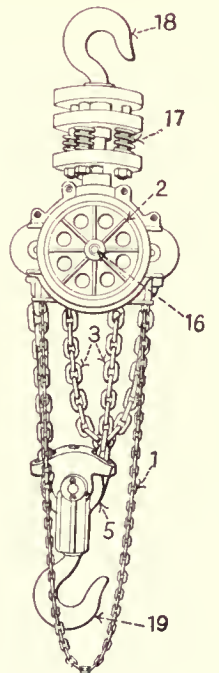

Two-Speed.

Hoists

HOISTS ARE USED for lifting purposes in practically every modern industry and they have come to be considered as an essential part of shop equipment. Being easily portable they may be moved to various parts of a shop and thus be kept in service for a greater portion of the time. They are made in various types: Chain hoists, steam-hydraulic hoists, pneumatic hoists, and electric hoists. The chain hoist which is hand-operated is adaptable to almost any service and is particularly desirable for use where air, steam, or electric power is not available. Pneumatic hoists are used largely in foundry work for handling molds or cores, or in other industries for handling fragile materials. Pneumatic hoists of the air-motor type are, however, now coming into use in more general service. The steam-hydraulic hoist, which in some respects is also a pneumatic hoist, is used in practically the same service as the strictly pneumatic types, being especially adapted to foundry service. Electric hoists have become a most widely used equipment and because of their adaptability to all classes of service are preferable to other types of hoists when electric current is available.

Hoists are so designed that they may be installed in a fixed location for use as a separate apparatus but, with the exception of the steam-hydraulic type, they generally are equipped either with a top hook or a rigid connection and are suspended from a trolley on a jib crane, a monorail system, or some type of traveling device—generally an overhead crane.

Chain Hoists

Chain hoists—often called chain blocks—are a hand-operated type of hoist used in shops and garages or other places for lifting heavy parts. They are easily portable and usually are provided with a hook by which the hoist may be suspended from a fixed object or they may be used with a trolley or traveler on a crane or a monorail. When it is to be used only with a traveler, the hoist generally is permanently attached to it.

These hoists are made in several types: the spur-gear type—variously termed triple-gear, single-gear, multiple-gear; the screw or worm-gear type; and the differential type. These hoists consist primarily of a load chain, to which the hoisting hook is attached; a hand chain, by which the power is applied; and a system of gears or sheaves by which the power is transmitted to the load chain. Hoists of this type generally carry the load on chains—hence the name—but sometimes a wire cable is used instead of the load chain.

Chain hoists of the lighter capacities generally have the hoisting hook suspended from a single chain but on many hoists of this type the hook is suspended on two or more strands of chain attached directly to the hook or passing through a sheave block to which the hook is attached.

Usually the hoisting speed is variable only by means of the movement of the power sheave, but on hoists where the load chain passes through a lower sheave, two speed arrangements may be obtained. One speed is obtained by permitting the chain to run free through the lower sheave, while a faster speed for light loads may be obtained by making the chain fast to the lower sheave so that single action is obtained and the hoist operates in the same manner as the single speed type.

Chain hoists usually have the complete hoisting mechanism in one compact unit suspended from a single hook but sometimes are provided with an extension shaft to transmit the power to the load chain; or two hoists—twin hoists—may be secured to a single shaft and be operated in unison by one hand chain. Hoists arranged in this way are especially adapted for use on a crane or a monorail for handling containers or long objects or for suspending a spreader

bar carrying two or more hooks or tongs. Many special attachments, such as tongs, clamps, yokes, etc., are substituted for the hoisting hook and the hoist is then used for special service in handling parts of uniform size. Shock absorbers are applied to hoists which are intended for use in handling material for a power hammer or in other service where there may be considerable vibration of the load. These devices consist of one or more spiral springs held in a frame or yoke at-

tached to the hoist block so that the vibration of the load is absorbed by the springs, thus preventing injury to the hoist mechanism.

The relative efficiency of chain hoists as commonly rated is as follows:

PERCENTAGE OF POWER APPLIED TO HAND CHAIN CONVERTED INTO USEFUL ENERGY

Type of Hoist	Efficiency, Per Cent
Spur-gear	80 to 90
Screw-gear	40
Differential	30

Spur-Gear Type

The spur-gear type of chain hoist is adapted for general service but is particularly useful where a heavy lifting capacity and high speed of operation are desired. It is used largely with some form of crane, or monorail, in machine shops or foundries for handling heavy parts and in warehouses, or in other operations, particularly when the efficiency of other equipment is dependent on the facility with which the materials are handled. These hoists are made with triple gears of both the planetary and the gyratory type; or with single or multiple gears and pinions.

Planetary Gear

The spur-gear hoist of the planetary gear type is used extensively. It consists of a load chain carrying the hoist-

Chain Hoists: Multiple Spur Gear; Single Spur Gear; Worm or Screw Gear; Differential Sheave.

Pneumatic Hoists: Cylinder Type (Single Acting, Air-Balanced, Double Acting, Oil-Governed, Steam-Hydraulic); Air-Motor Type (Oscillating Cylinder, Rotating Cylinder, Reciprocating Square Piston).

Electric Hoists: Floor-Operated; Cab Operated; Variable Speed; Single Speed.

Monorail Hoists; Telfers.

ing hook; a hand chain operating a power wheel or sheave; and a train of planetary gears secured within a gear case or block. Both ends of the load chain are secured to the hoisting hook and the chain passes over a load sheave keyed to a short shaft suspended from the top crosshead of the hoist. The hand or power chain consists of a pendant endless chain passing over a power sheave or hand-wheel turning on the screw hub of a ratchet friction disk secured to the central shaft of the planetary gear and controlling the operation of the central pinion. The central pinion meshes with two intermediate gears held diametrically opposite to each other in a pinion case which is secured to the load sheave. Pinions on the shafts of the two intermediate gears mesh with an integral gear secured to the gear case and serve as a fulcrum to rotate the planetary gear. When power is applied to either side of the hand chain loop, the central pinion rotates the intermediate gears in opposite directions, causing their pinions to travel around the internal gear and rotate the pinion case. The pinion case being secured to the load sheave, transmits the power to it, causing it to rotate and raise or lower the hoisting hook. A pawl which engages the ratchet disk prevents the load from lowering when the pull on the hoisting side of the hand chain loop is discontinued.

To lower the load the opposite side of the chain loop is pulled downward, thus reversing the movement of the power sheave and unscrewing it from the hub of the ratchet disk. This releases the central shaft of the planetary gear and permits the weight of the load to rotate the gear in the opposite direction. The lowering movement continues until the pull on the lowering side of the hand chain loop ceases, when the revolving of the ratchet disk causes it to again screw into the power sheave. This stops the movement of the gears and holds the load.

Hoists of this type are made with a single gear train for capacities upward to 10 tons. Two gear trains, contained in separate gear cases connected by a yoke and operated by separate hand chains but having a single hoisting hook, are used for capacities from 10 tons upward to 20 tons. The following table gives data on spur-gear hoists of the planetary gear type:

TRIPLE SPUR-GEARED CHAIN HOISTS—PLANETARY TYPE

Capacity, Tons	Pull Required on Hand Chain to Lift Capacity Load, Lb.	Hand Chain Overhauled to Lift Load 1 Ft., Ft.	Hoisting Speed with Full Load, Ft. Per Min.	Load Lifted with Pull of 80 Lb. on Hand Chain, Lb.	No. of Men
1/4	50	12 1/2	16.	500	1
1/2	62	21	8.	1,000	1
1	80	31	4.	2,000	1
1 1/2	110	35	4.8	2,300	2
2	120	42	3.6	2,600	2
3	114	70	2.3	4,000	2
4	124	84	1.7	5,000	2
5	110	126	1.3	6,500	2
6	130	126	1.1	7,000	2
8	135	168	.8	9,000	2
10	140	210	.6	11,000	2
12	130	126	1.1	13,000	4
16	135	168	.8	17,000	4
20	140	210	.6	20,000	4

Note—Figures given for 12, 16, and 20-ton hoists are based on hoists having two hand chains operated in unison, thus permitting double speed.

Gyratory Gear

In another form of triple-gear hoist a fixed gear train with a floating duplex internal gear which is cut in a two-part yoke, is used instead of the planetary gear and the fixed internal gear. The gear train consists of three spur-gears on short shafts rotating in bearings in the frame of the hoist block. The shafts of the two outer gears have double eccentrics which rotate in bearings in the two-part yoke. The center spur gear is keyed to the power sheave

shaft which passes through the hollow shaft of the lift wheel—a toothed wheel fixed to the load sheave. This lift wheel has less teeth than the duplex internal gear, and the lower teeth in one side of the two-part yoke mesh with the lower teeth of the lift wheel, while the upper teeth in the other side of the yoke mesh with the upper teeth of the wheel. A downward pull on either side of the hand chain rotates the gear train, causing the eccentrics on the shaft of the two outer gears to impart a gyratory motion to the two-part yoke. The movement of the yoke rolls the lift wheel within the duplex internal gear and revolves the load sheave, thus raising or lowering the hoisting hook.

A high capacity hoist of the gyratory type is made with the gear case of block divided into three compartments, the two outside compartments each containing a load sheave mounted on a hollow shaft, and the central compartment a pinion and three spur gears. The pinion is secured to the power sheave shaft which passes through the hollow shafts of the two load sheaves and drives the three spur gears which are mounted on shafts having eccentric ends. These three eccentrics carry, in each of the outer divisions, a spur gear which meshes with an internal gear secured to the load sheave. The internal gears have a greater number of teeth than the spur gears so that at each revolution of the eccentrics, a gyratory movement is imparted to the spur gears and the load sheaves are rolled over within the internal gears, thus raising or lowering the hoisting hook. A multiple disk ratchet brake locks the hoist and holds the load at any point but permits the lowering of the load by a downward pull on the other side of the pendant hand chain loop which reverses the movement of the power sheave. The hoist has two independent load chains moving over the load sheaves simultaneously. Idler sheaves permit the doubling up of these load chains, so that the load is carried by eight strands of chain.

Hoists of the gyratory gear type operate with a minimum of vibration and are especially adapted for handling molds in a foundry or for handling other fragile materials. They range upward to 40 tons in capacity as shown in the table:

TRIPLE SPUR-GEARED CHAIN HOISTS—GYRATORY TYPE

Capacity Tons	Height of Lift, Ft.	Pull Required to Lift Capacity Load, Lb.	Chain Overhauled to Lift Load 1 Ft., Ft.
1/4	8	70	9
1/2	8	56	20
1	8	79	22
1 1/2	8	102	39
2	9	109	47
3	10	115	70
4	10	120	91
5	12	104	123
6	12	109	140
8	12	135	159
10	12	144	191
12	12	160	195
16	12	75	285
20	12	90	336
30	12	90	504
40	12	90	670

Multiple Spur-Gear Type

One type of multiple spur-gear hoist is operated by means of a pinion turning loosely on the main shaft but attached to the hand-chain wheel or power sheave. This pinion drives a spur gear keyed to a second shaft at the end of which is another pinion meshing with an internal gear keyed to the end of the main shaft. The load-chain sheave is also keyed to the main shaft between the side frames of the hoist block. A downward pull on either side of the hand-chain rotates the gear and thus raises or lowers the load.

This hoist is controlled by means of an automatic ratchet friction brake. The ratchet turns on the extended hub of

the operating pinion and has friction surfaces which are gripped between the hand-chain wheel and the operating pinion by means of a cam which is actuated by the speed of hoist during the lowering movement. In the hoisting movement the ratchet brake wheel is free on the pinion hub and the pawl rides over the ratchet teeth. When the pull on the hand chain ceases, the pawl engages the ratchet teeth, preventing the backward movement of the shaft and thus holding the load suspended until the gear is rotated with sufficient speed to overcome the action of the cam and again releases the friction disks. The capacities of these hoists are given in the table:

MULTIPLE GEAR CHAIN HOISTS

Capacity, Lbs.	Height of Lift, Ft.	Pull on Hand Chain to Lift Capacity Load, Lbs.	Chain Handled, Ft.
500	8	40	20
1,000	8	50	27
2,000	8	78	32
3,000	8	110	33
4,000	9	150	36
5,000	9	130	53
6,000	10	120	66
8,000	10	145	80
10,000	12	135	105
12,000	12	155	108
16,000	12	160	158
20,000	12	165	210
25,000	12	170	260
30,000	12	175	150
40,000	12	180	160

Note—Hoists of 30,000 lb. and 40,000 lb. capacity are equipped with two chain blocks and two hand chains.

Single Spur-Geared Type

The single spur-geared chain hoist is adapted for use in machine shops or other service requiring a lifting capacity upward to about 5 tons. This type of hoist has a single spur gear wheel to which the load chain sheave is secured; a central shaft having a lifting spur or pinion on one end, a quick pitch screw on the other end and a ratchet disk friction brake keyed to it near the center; and a power sheave turning loosely on the central shaft. As the hoisting side of the hand chain is pulled downward the power sheave screws tightly against the ratchet disk and rotates the lifting spur. This revolves the spur gear wheel and the load chain sheave and thus raises the load. A pawl, which engages the ratchet disk, holds the load suspended at any point until a pull on the lowering side of the hand chain unscrews the power sheave and permits the weight of the load to reverse the movement of the gear. Single spur-geared hoists develop about 90 per cent of the power applied to the hand chain but operate at a comparatively slow speed. These hoists range in capacities as given in the table:

SINGLE SPUR-GEARED CHAIN HOISTS

Capacity, Long Tons	Pull on Hand Chain to Lift Capacity Load, Lbs.	Hand Chain Overhauled to Lift Load 1 Ft., Ft.	Hoisting Speed, Ft. Per Min.
1/8	70	4	37
1/4	70	8	19
1/2	56	20	7 1/2
3/4	66	25	6
1	56	41	3 1/2
1 1/2	69	50	3
2	75	62	2 1/2
3	57	125	1 1/2
4	85	112	1 1/4
5	96	126	1

Screw-Geared Type

The screw-geared or worm-geared chain hoist—sometimes called a duplex hoist—is used where heavy loads are to be handled but speed of lift is not essential. The worm

gearing gives great hoisting power but is slow moving and therefore this type of hoist is particularly adapted for use in storehouses, garages, or other places where only occasional heavy lifting is required. Screw-geared chain hoists generally are designed to operate at any angle so that they may be used successfully in a horizontal position for hauling, as well as in a vertical position for hoisting purposes.

In the most common type of screw-geared hoists, the hoisting hook is secured to both ends of the load chain, which passes over two load sheaves secured to the extended hubs of a single worm gear. A separate hand chain operates the power sheave, on the shaft of which is a worm meshing with the worm gear. A downward pull on either side of the hand chain rotates the power sheave and the worm and transmits the power through the worm gear to the load sheaves thus raising or lowering the load.

Another form of screw-geared hoist has a double screw or worm—cut right and left hand—on the power sheave shaft which operates two worm gears turning on separate shafts set in the hoist frame. One of these worm gears rotates the load sheave which is secured to it, while the other worm gear, rotating in the opposite direction, is geared back to the shaft of the load sheave thus supplementing the direct motion of the load sheave gear.

The relative proportions and capacities of the screw-geared chain hoists are given in the following table:

SCREW-GEARED CHAIN HOISTS

Capacity, Tons	Height of Lift, Ft.	Pull on Hand Chain to Lift Capacity Load, Lb.	Hand Chain Overhauled to Lift Load, 1 Ft.
1/2	8	49	60.5
1	8	71	76.0
1 1/2	8	99	89.5
2	9	129	98.0
3	10	163	98.0
4	10	190	128.0
5	12	293	106.5
6	12	293	110.0
8	12	358	158.0
10	12	403	198.0

Differential Type

Differential chain hoists are especially adapted for use in shops, garages, stores, or other places where only occasional light lifting is required. They may be suspended from a stationary hook secured to some part of the building or to a separate structure. They may also be used with a trolley on jib cranes, on monorails, or on light capacity overhead cranes, but rarely are used in such service as other types of hoists are preferable where frequent use is necessary.

This type of hoist is simple in construction and consists of a single endless chain operating over a double or differential upper sheave and through a lower sheave. The differential sheave has two chain grooves, one of smaller diameter than the other which causes a greater length of chain to pass over the larger diameter than over the smaller at each revolution of the sheave. The hoist hook is suspended from the pin of the lower sheave and is raised or lowered by pulling downward on either side of the pendant loop of the endless chain.

The differential—the difference in the diameter of the grooves in the double sheave—is small and not sufficient to permit the weight of the load to overcome the friction of the parts. This allows the load to remain suspended at any point when pull on the hand chain ceases. The speed of lift and the length of chain haulage required per foot of lift is proportional to the amount of differential in the upper sheaves. There being four parts of chain

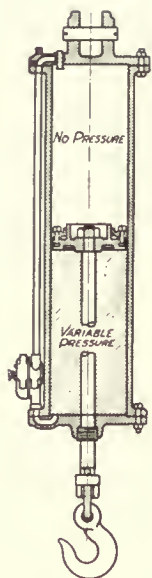

Single Acting

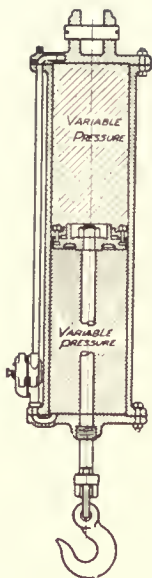

Balanced

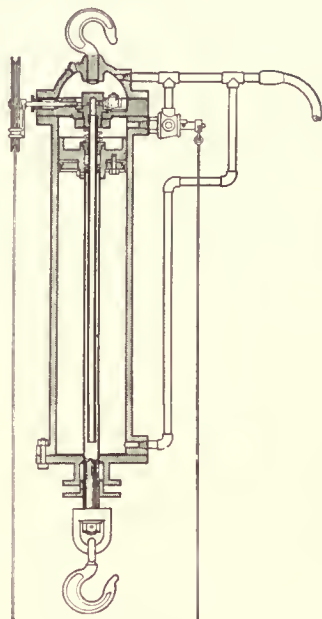

Oil Governed

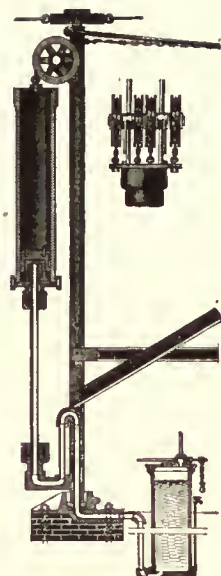

Steam-Hydraulic

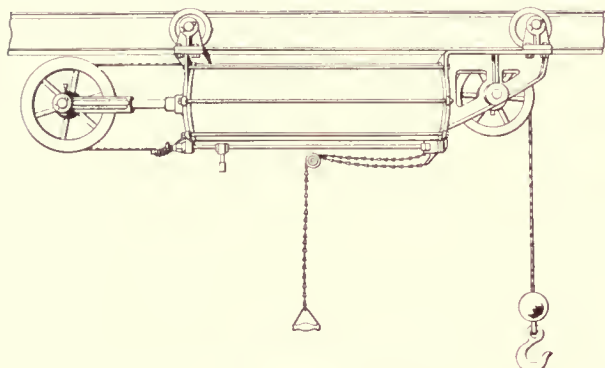

Horizontal Air Cylinder

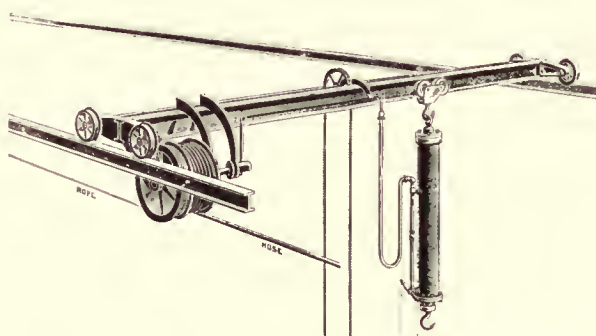

Hand Operated Traveling Crane With Air Hose Reel

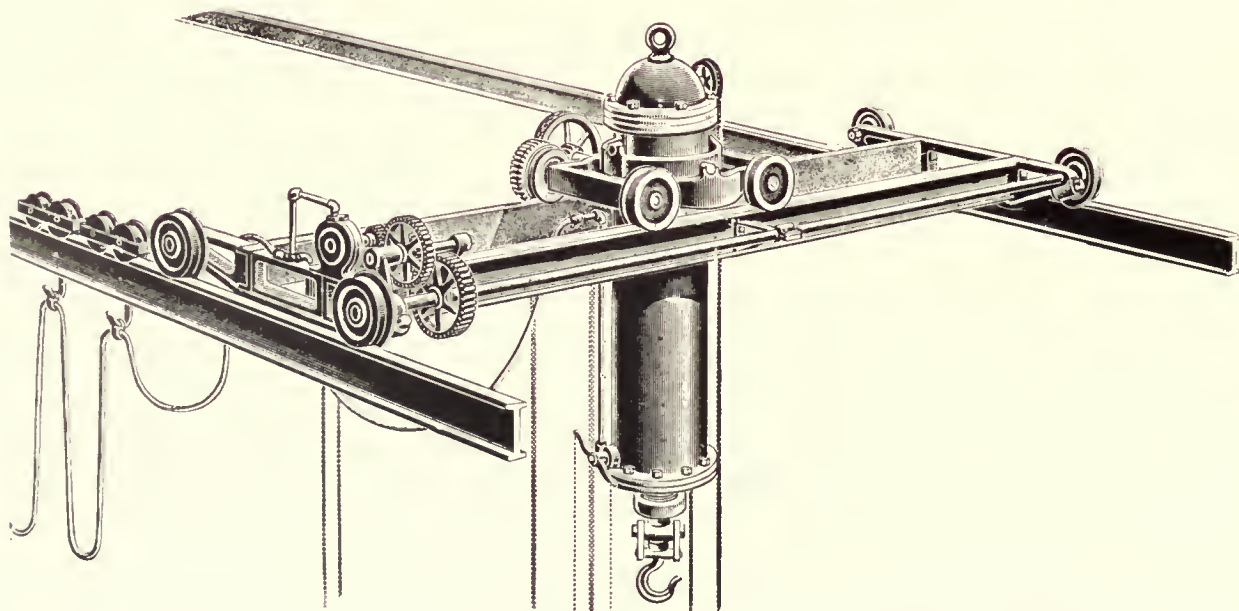

Hand Operated Overhead Traveling Crane With Oil Governed Hoist and Air Hose Trolleys

Pneumatic Hoists

suspended, it requires 4 ft. of chain for each foot of lift.

Differential chain hoists range in capacity upward to about 3 tons the approximate proportions being given in the following table:

DIFFERENTIAL CHAIN HOISTS

Capacity, Tons	Minimum Distance Between Hooks, Ins.	Height of Lift, Ft.	Length of Endless Chain, Ft.	Chain Overhauled to Lift Load, 1 Ft.
1/4	17	6	22	18
1/2	21	7	26	24 1/2
1	26	8	30	29 1/2
1 1/2	32	8 1/2	33	35 1/2
2	39	9	36	38
3	44	9 1/2	38	37

Pneumatic Hoists

Pneumatic hoists—commonly called air hoists—are used extensively in foundries, where certain types of air hoists are especially adapted to handling molds, and also in other places where a compressed air supply is available. They are particularly suitable for use in power plants and some classes of warehouses where the fire hazards render the use of electric equipment undesirable. Air hoists are made in several piston-operated cylinder types and in the air-motor type. They may be installed in a fixed location but generally are used on some form of crane or monorail. In some cases they are adapted to operate a small platform type of elevator.

Cylinder Type

The cylinder type of air hoist is made in three forms: the single-acting type; the air-balanced type; and the double-acting type. These hoists consist of a cylinder and a piston operated by compressed air and controlled by air valves operated from the floor by pendant cords. They are connected to the compressed air line by a hose so constructed as to withstand the pressures necessary to operate the hoist. When these hoists are used on any form of traveling crane, the flexible air hose is carried on specially designed hose trolleys which may travel on the crane runway or on a separate rail or cable, the hose hanging in loops or tending to straighten in a horizontal position as the machine travels toward or away from the fixed connection.

A hose reel is sometimes used instead of the trolley. This device permits the hose to pay out as the crane travels away from the connection to the shop pressure line, but has sufficient torque to reel in the hose when the travel is toward the connection. The air is conducted to the hoist through the hollow shaft of the reel.

Only a comparatively short lift may be obtained with an air hoist of the cylinder type as the travel of the piston rod, to which the hoisting hook is attached, is limited by the length of the air cylinder. The most efficient service is obtained when the air cylinder is in a vertical position, but where the headroom is limited the cylinder may be placed in a horizontal position. When used in the latter position, a sheave is placed on the end of the piston rod—on hoists having only a short stroke—and the hoisting hook is suspended from a wire rope which passes over the sheave and is made fast to a fixed point on the hoist. As the piston moves outward the rope passes over the sheave and raises the hoisting hook. On hoists having a short stroke—30 in. or less—the piston rod is constructed so that it has sufficient rigidity to sustain the full capacity load but for longer strokes the hoisting rope passes over the sheave at the end of the piston rod and thence over another sheave which is secured to some fixed part of the air cylinder or on the trolley and supports the load. Multiple sheaves may be in-

stalled and a greater height of lift obtained by reeving two or more parts of the hoisting rope.

The capacities of air hoists of any of the cylinder types vary with the diameter of the cylinder, which ranges from about 3 in. to 24 in., and the air pressure, which varies from about 60 lb. to 100 lb. per sq. in. of piston surface. They are used largely for handling weights up to about 5 tons but are made in capacities ranging upward to about 20 tons. The following table gives the approximate relative proportions of this type of hoist:

CYLINDER TYPE PNEUMATIC HOISTS

Inside Diam. of Cylinder, In.	Lifting Capacities, Air Pressures of 60 to 100 Lb., Lb.	Approximate Length of Stroke, Ft. In.	Free Air Used in One 4-Ft. Lift, Cu. Ft.
2	165 to 270
3 1/4	350 to 600	1.1 to 1.6
4	600 to 1,050	1.7 to 2.5
5	1,000 to 1,700	2.7 to 4.1
6	1,500 to 2,500	3.8 to 5.8
7	2,000 to 3,300	5 8	5.2 to 8.0
8	2,500 to 4,500	6 0	6.9 to 11.
9	3,500 to 5,500	6 0	8.7 to 14.
10	4,000 to 7,000	7 0	11. to 17.
12	6,000 to 10,000	7 0	16. to 24.
14	8,000 to 13,000	8 0	22. to 33.
16	10,000 to 18,000	8 0	28. to 43.
18	12,000 to 23,000	8 0	36. to 55.
20	16,000 to 28,000	8 0	44. to 68.
24	24,000 to 40,000	8 0	63. to 97.

Single-Acting Type

The single-acting type of air hoist is used only in a vertical position and for hoisting loads which do not require delicate handling. It is used largely in machine shops or in assembly work for lifting heavy parts. The air from the pressure line is admitted through a valve controlled by the operator from the floor to the underside of the piston for the hoisting movement and is exhausted from it for the lowering operation. The upper part of the cylinder is vented at the top to prevent the formation of an air cushion that would otherwise interfere with the free upward movement of the piston. To lower the load, the air is exhausted from under the piston—either directly to the atmosphere or to the upper chamber of the cylinder and thence through the lower chamber of the cylinder and allows the weight of the load to lower the piston. Various types of automatic cut-off devices are used so that the movement of the hoist is under control and cannot operate beyond certain predetermined points.

Balanced Type

The air-balanced type of hoist is used chiefly in foundries for handling molds or cores, or for drawing patterns. It may also be used in other industrial work for handling fragile material which requires a hoist having a delicate control. It is similar in construction to the single-acting type but air pressure is used both above and below the piston, thus balancing the pressure and permitting a very slow movement of the piston and a very accurate control of the hoist.

In some hoists of this type the full air pressure is always maintained below the piston. The hoist is raised by exhausting the air from the upper chamber. To lower the hoist the exhaust valve is closed and the air from the pressure line is admitted to the upper chamber, thus equalizing the pressure, which, because of the greater area of the upper side of the piston—due to the area occupied by the piston rod—causes the piston to descend and lower the hoist.

In another method of operation the air pressure is variable both above and below the piston. To raise the hoist, the air from the pressure line is admitted below the piston and forces it upward against the pressure in the upper

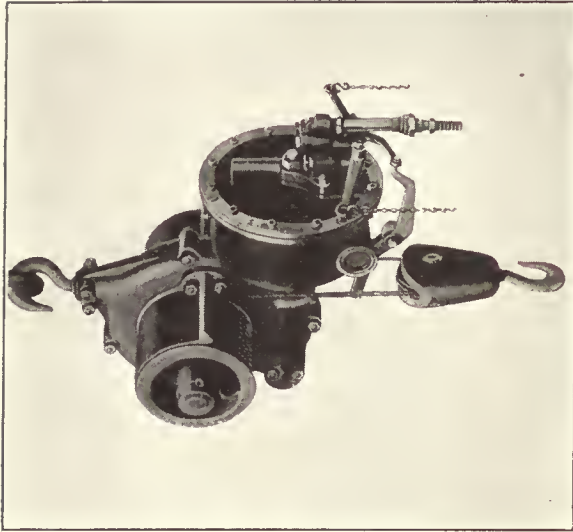

Air-Motor Hoist with Rotating Cylinders, Two-Ton Capacity with Two-Strand Load Cable

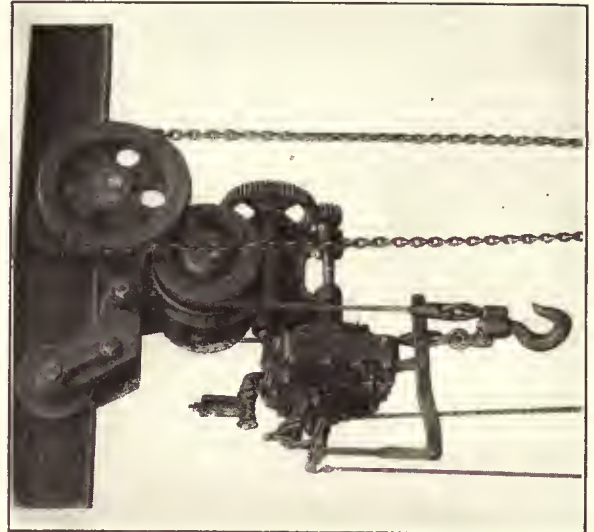

Air-Motor Hoist with Square Piston, Two-Strand Load Cable and Hand Racking Trolley

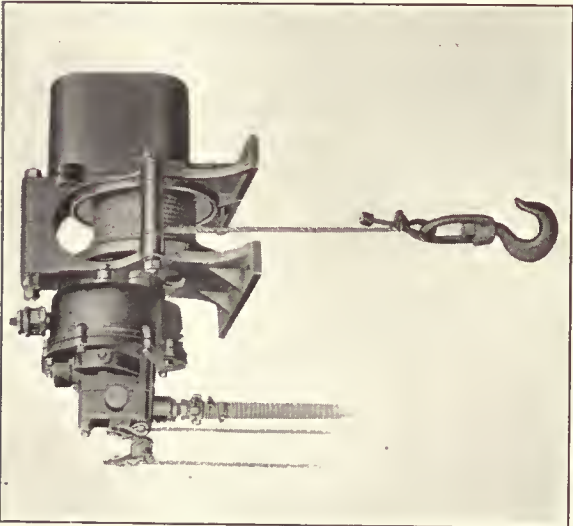

Air-Motor Hoist or Portable Winch with Oscillating Cylinders, One-Ton Capacity with Single-Strand Load Cable

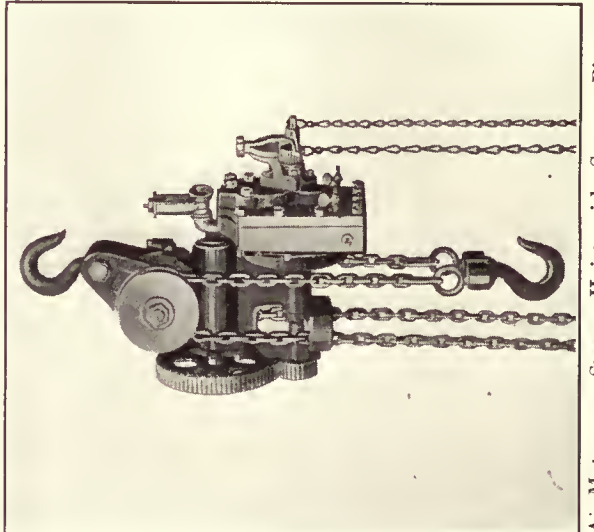

Air-Motor--or Steam--Hoist with Square Pistons, Five-Ton Capacity with Two-Strand Load Cable

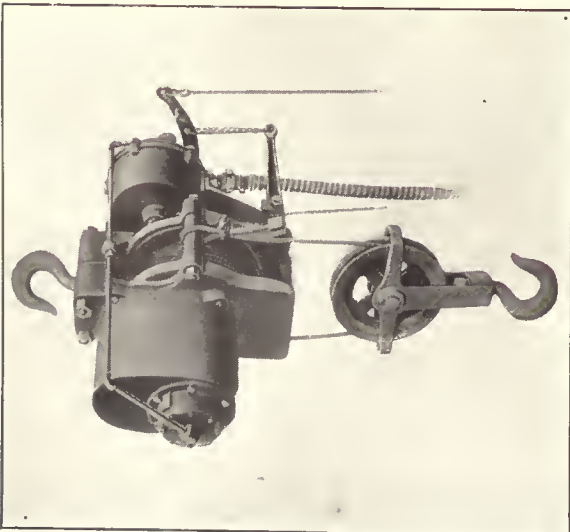

Air-Motor Hoist with Oscillating Cylinders, Two-Ton Capacity with Two-Strand Load Cable

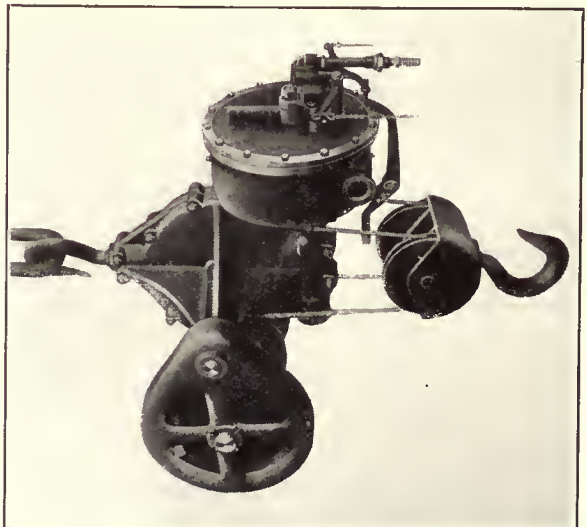

Air-Motor Hoist with Rotating Cylinders, Five-Ton Capacity with Four-Strand Load Cable

chamber thus raising the load. To lower the hoist the upper chamber is connected to the lower chamber through an air valve, thus equalizing the pressure above and below the piston and allowing the piston to descend by force of its own weight.

Double-Acting Type

The double-acting type of air hoist operates with equal force in either direction and is used when a hoisting or pulling movement and also a pushing action is desired. In this type both the upper and lower chambers of the cylinder are so arranged that air under pressure may be admitted to and exhausted from it as in the lower chamber of the single-acting hoist. This permits a movement in either direction at the full capacity of the cylinder. This type of hoist is not used extensively as the single-acting and air-balanced types are less complicated in construction and meet all the requirements for the usual hoisting purposes in most shops.

Oil-Governed Type

The oil-governed type of air hoist operates in a manner similar to the air-balanced type and is used chiefly in foundries in the same class of service. This type has a hollow piston rod and a cylinder with a double top-head which forms a reservoir and contains a small quantity of oil under pressure by means of which the upward movement of the piston is governed. The lower chamber of the cylinder is under constant air pressure, which serves to raise the piston in the hoisting movement and acts as a cushion as the piston descends in the lowering movement and thus gives a very delicate control.

The hollow piston rod is connected with the oil reservoir by a tube fixed to the lower wall of the reservoir and passing through a stuffing box in the piston head into the hollow piston rod. When the piston is down the oil passes through a check valve and fills the hollow piston rod. As the oil is also under pressure this resists the air pressure in the lower chamber and when, by means of a regulating valve which is controlled by the operator, the oil is allowed to escape from the hollow piston rod to the reservoir, it permits the upward movement of the piston but at the same time governs its speed.

The hoist is lowered by admitting air under pressure to the upper chamber; this overbalances the pressure on the lower side of the piston head causing the piston to descend. A hoist of this type may be operated without using the oil governing feature and it is then controlled in the same manner as other air-balanced hoists. The oil-governed method of control permits the movement of the piston in either direction without the jerkiness sometimes experienced with air hoists.

Steam-Hydraulic Hoist

The steam-hydraulic hoist usually is not portable and it is used chiefly on stationary jib cranes. Because of its special control features this type of hoist is particularly adapted to foundry work for setting large cores and for handling molds or ladles of molten metal. The hoist consists of a pressure tank or cylinder, fixed on a foundation near the base of the crane, and an upper or lifting cylinder suspended from the crane structure. Unlike other hoists of the cylinder type the piston is stationary while the lifting cylinder moves upon it. This type of hoist may be operated by a combined use of water, air, and steam; by water, oil and air; by water and air; or by oil and air.

A detailed description of the operation of the steam-hydraulic hoist is given in this book in the chapter on

cranes under the title of "Steam-Hydraulic Balanced Jib-Crane."

Air-Motor Hoists

Air-motor hoists have been developed to a considerable degree of efficiency and are used to quite an extent in industrial plants, particularly in foundries where a hoist having a delicate control is especially desirable. Hoists of this type consist of some form of geared hoisting mechanism operated by an air driven motor of the piston type. These hoists are provided with a throttle or control valve and are designed to operate so that an accurate control may be obtained. This feature makes such a hoist especially desirable not only for handling fragile materials but for other work requiring an easily controlled and quick-acting hoist of moderate capacity. Usually the control valve is placed on the hoist itself but if necessary it may be placed at a remote point on the pressure line so that the hoist may be controlled from an elevated platform or other location from which the operator may have a clear view of the work. It is also quite general practice to provide a limit stop which automatically cuts off the air pressure when the hoist reaches a predetermined point.

Air-motor hoists of the smaller sizes—up to about 1-ton capacity—may be geared with but one speed reduction, which generally is of the worm type. Hoists of greater capacities, however, generally have two speed reductions, a worm on the motor shaft rotating a worm wheel on the shaft of which is a pinion which meshes with a spur gear keyed to the shaft of the cable drum or the lead chain sheave.

Oscillating Cylinder Type

One form of air motor used with hoists of this type consists of two double cylinders set at right angles to each other and arranged to oscillate on a shaft. Piston valve mechanism is dispensed with as the oscillation of the cylinders alternately opens and closes the cylinder air ports. The motor may be run in either direction, the admission of air from the pressure line being regulated by a control valve of the balanced slide valve type. This valve is equipped with a double end control lever which is operated from the floor by pendant cords or chains. A downward pull on either side of the lever starts the motor and raises or lowers the hoist. The lever automatically assumes a central position and cuts off the air when the pendant control cords are released. This type of hoist is made in capacities given in the following table:

OSCILLATING CYLINDER AIR-MOTOR HOISTS

Capacity. Tons	Height of Lift, Ft.	Speed of Lift 80 Lb. Pressure Per Min., Ft.	Cu. Ft. of Free Air Consumed Per Foot Lift
1	9	27	3
2	9	16	4
3	11	10	8
5	12	7	15
10	12	4	27

Rotating Cylinder Type

Another type of air motor used on such hoists consists of three cylinders formed in a single casting and arranged radially around a crank shaft. The cylinders rotate about the crank and the air is thus successively admitted to the cylinders or exhausted from them through ports in the crank itself; this eliminates the need of a special valve mechanism. This hoist may be operated in either direction, the air supply being controlled by a self-centering valve of the reversing type. The valve is operated by pulling on pendant control cords or chains attached to the starting levers, a downward pull on either lever starting the motor

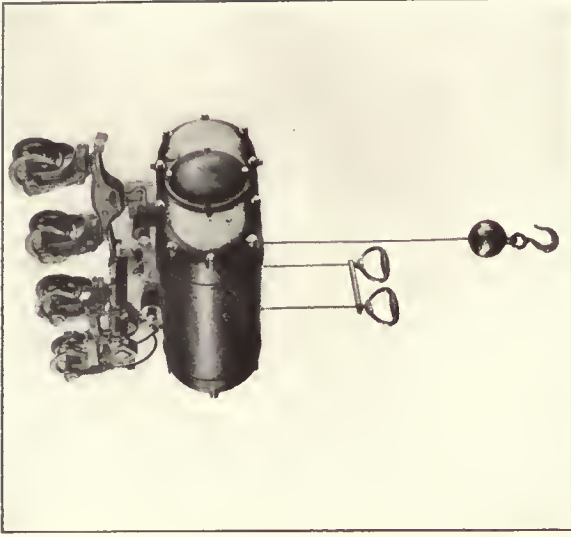

Floor-Controlled Electric Hoist

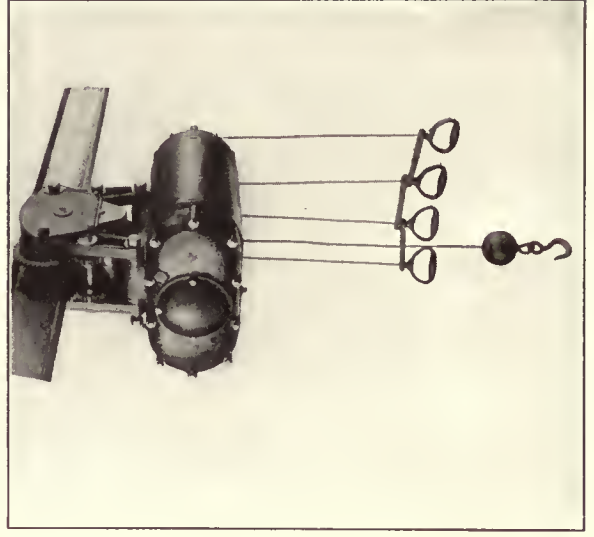

Floor-Controlled Electric Hoist with Racking Trolley of the Equalizing Type

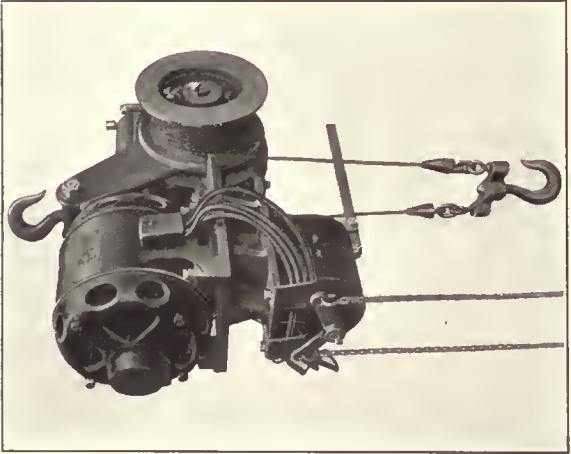

Floor-Controlled Hook Type Electric Hoist

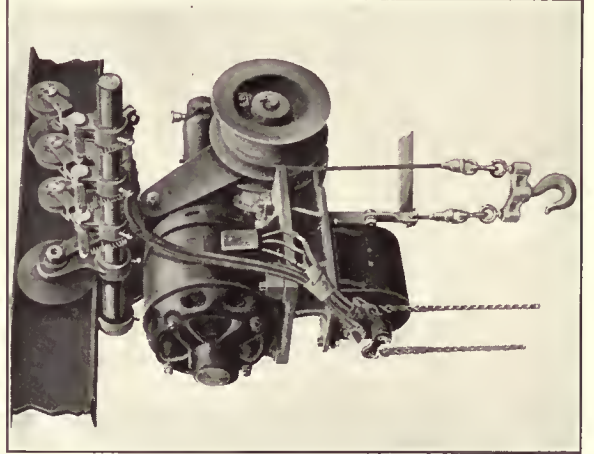

Floor-Controlled Trolley Type Electric Hoist Showing Wheel Type Current Collectors

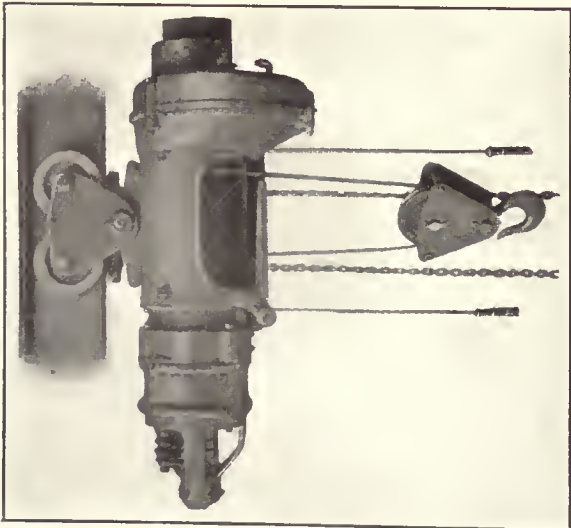

Floor-Controlled Trolley Type Electric Hoist

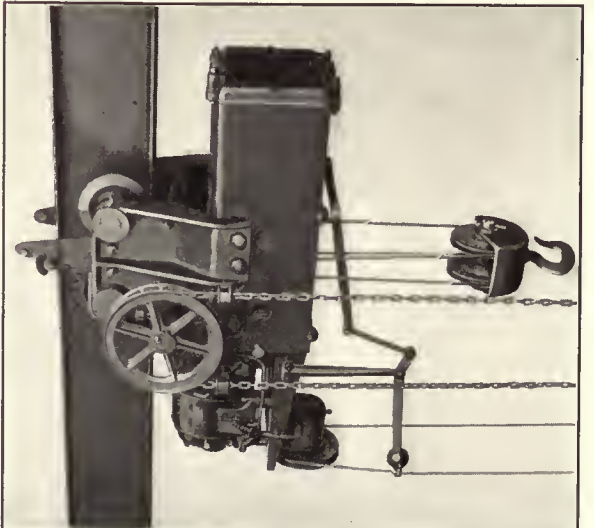

Floor-Controlled Trolley Type Electric Hoist with Hand Chain Racking Trolley

and raising or lowering the hoist as may be desired. When the control cords are released the valve automatically centers and cuts off the air pressure. The following table gives the capacities of air-motor hoists of this type:

ROTATING CYLINDER AIR-MOTOR HOIST

Capacity, Lb.	Maximum Lift, Ft.	Feet Lift Per Min. 80 Lb. Pressure	Cu. Ft. Free Air Per Min.
1,000	20	32	45
2,000	20	16	45
4,000	20	8	45
7,000	20	8	80
10,000	20	7	80

Reciprocating Square-Piston Type

Another type of air motor used on many pneumatic hoists is designed with a double piston, one working inside of the other; the outer piston is square and the inner one round. These pistons are placed in a rectangular steam chamber—the cylinder—so that a bearing at the center of the inner piston fits over the pin of the crank shaft. Both pistons take air and also exhaust it through four ports in the inner piston which alternately communicate with two circular ports in the steam chamber cover. These circular ports are connected with the throttle; thus as the motor operates, two of the ports in the piston are always taking air—one for the inner piston and one for the outer—while the other two ports exhaust it to the atmosphere. The two pistons are set at right angles to each other, the outer piston having a lateral reciprocating movement while the inner piston has a vertical movement. These movements are timed so that the pistons work in unison and transmit a uniform rotary movement to the crank shaft. This motor is of the reversing type and is designed to be operated by either air or steam. Hoists thus equipped range in capacities as shown in the following table:

SQUARE PISTON AIR-MOTOR HOISTS

Capacity, Tons	Height of Lift, Ft.	Speed of Lift, Ft. Per Min.
1/2	8	24
1	10	16
2	16	14
3	10	10
5	10	7
7	10	8
10	10	8

Electric-Motor Hoists

Electric-motor hoists have reached a high state of efficiency, and because of the ease of control are preferable to other types of hoists where a great amount of hoisting is required and where electric current is available. They are adaptable to practically any class of service and may be used in machine shops for handling heavy parts to and from the finishing machine; in foundries for handling molds or ladles, or for transporting materials about the shop; and in warehouses, ice plants, or in other operations where a hoisting machine may be used. These hoists may be suspended from a hook in a fixed location, or they may be installed on a plain trolley or a geared trolley traveling on the jib of a crane or on a monorail and operated either by hand-power or by an electric motor. Some hoists of this type are made for stationary mounting and are used in a permanent location, or are installed on the bridge of a crane or on some other type of hoisting machine. They then may be used to operate a hoisting line or may be used solely to rack a trolley across the crane bridge structure.

The hoisting mechanism of an electric hoist consists of a gear train of either the worm-gear or the spur-gear types or, in some cases, a combination of the two

types. On some hoists a link-chain belt is used to transmit the power from the motor to the hoisting gear. On the most modern designs the gears are enclosed in tight cases and rotate in a bath of lubricant. This insures proper lubrication of the gears and at the same time protects them from dirt or injury.

Generally a hoisting cable made of a good grade of steel wire rope is used but crane chain is sometimes used on hoists of this type. The cable winds on a single or a double drum on the main shaft of the hoisting gear, a single strand of cable being used on hoists of light capacity—up to about 1 ton; two strands on hoists having a capacity upward to about 5 tons; and four strands on hoists having a capacity of 7 to 15 tons.

The electric motor may be of either the direct current or the alternating current type and may be equipped with either a single-speed or a variable speed controller. The controller may be placed on the hoist itself and be operated from the floor by pendant cords attached directly to the control lever or to outrigger arms (floor control); may be placed in a fixed location in some part of the building and connected to the hoist by electric wiring (remote control); or, when used with a man-riding trolley on a monorail or a bridge crane, it may be installed in the operator's cab (cab control).

The single-speed controller serves only to start, stop, and reverse the motor, the full speed of the motor being obtained when the controller is in the "on" position. This type of control is suitable only for hoists having a comparatively slow speed and which are used entirely in general service where delicate handling of the material is not essential.

The variable-speed controller—also called foundry-controller—permits the operator to obtain a change in the running speed by moving the controller handle to various speed indicating marks on the controller case. This type of controller automatically centers and cuts off the current when the lever is released and the load may therefore be suspended at any point. This is a desirable feature and makes this type of hoist especially adaptable to foundry service—hence the term "foundry control." A limit stop automatically operates the controller, turning off the current and stopping the motor, when the hook reaches a pre-determined upper limit of travel, thus preventing the shock which would otherwise occur.

Load Brakes

A mechanical load brake is generally used on electric hoists in order to give the operator positive control of the load. This form of brake is made in various designs: One type of mechanical load brake is of the screw-and-disk type geared to the intermediate shaft and usually having three friction disks. Lowering the load tends to operate a coarse pitch screw through the gearing, gripping the middle disk which, by means of a roller-pawl, is prevented from turning during the lowering movement but is free to turn when the load is being raised. The resulting friction arrests the downward movement of the load until the hoist motor is again started and drives the hoist gearing with sufficient speed to overcome the action of the screw. The pitch of the screw is such that the friction and resistance of the disk is always in excess of the lowering effort of the load. This insures the prompt application of the load brake when the motor stops and prevents accidents in case of a failure of the electric current or the motor.

In another design of the flat friction-disk type of load brake the center disk remains stationary both in the lowering



Electric Hoist Installed on Overhead Traveling Crane Handling Block Stone with Stone Tongs



Electric Hoist Installed on Cantilever Monorail, Handling Loose Material with Turnover Bucket



Monorail Hoist Handling Pipe with Rectangular Lifting Magnets on a Spreader Bar

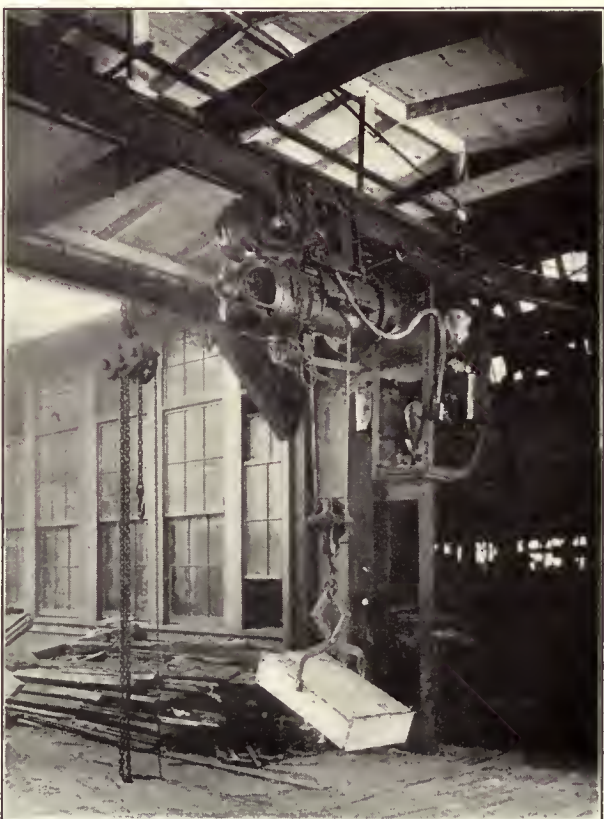

Monorail Hoist Handling Boxed Material with Tongs. Chain Hoist in Background

and the hoisting movement, and no pawl or retaining bands are used. The arrangement of the gears and a cam causes the motor gear to drive the intermediate gearing direct, with the brake released while hoisting, and the intermediate pinion acting on the cam automatically sets the brake when the hoisting movement ceases. When lowering a load the rotation of the motor gear relieves the pressure on the disks sufficiently to allow the load to descend but absorbs only enough power to prevent excessive acceleration, thus insuring a uniform speed. With this type of load brake, no brake is required on the motor itself.

Another type of load brake consists of a series of asbestos-lined wire-woven friction rings running on steel disks. This brake automatically adjusts itself and controls the load in the lowering operations.

Motor Brakes

Several different types of motor brakes are used. These may be either of the mechanical or the electrically operated types: One type of mechanically operated motor brake consists of two brake jaws or levers fitted with friction lining and gripping a wheel on the motor armature shaft. It operates in conjunction with the controller, the brake jaws closing automatically when the current is off, and releasing when the controller lever is pulled to the "on" position.

A magnetic type of disk brake is used on many motors, in which two disks are keyed to and rotate with the armature shaft. They are interposed between three stationary disks, and when the current is off a spring presses all five disks together and prevents the armature from revolving. When the current is on a magnet pulls the five disks from contact with each other and this allows the two rotating disks to revolve with the armature.

An electrically operated shoe brake is used on some hoists. This brake has a pulley-wheel mounted on the armature shaft and this wheel is gripped between pivoted levers

which are connected to a solenoid. When the current is off, the weight of the solenoid plunger holds the levers firmly against the pulley and the resulting friction prevents the armature from revolving. When the current is on the magnet lifts the plunger, thus releasing the pivoted levers and allowing the pulley-wheel and the armature to revolve freely.

On electric hoists of the hook-suspension type or the stationary-mounting type the electric current is conducted to the hoist motor by a flexible conductor cable attached to some part of the machine on which the hoist is installed. On hoists suspended from a trolley the current is taken from conductors, on one or both sides of the monorail, by current collectors of the trolley-wheel type, the roller type, the spoon type, the hook type, or the sliding contact-shoe type. Electric hoists range in capacity upward to about 20 tons with approximate proportions as given in the following table:

FLOOR OPERATED ELECTRIC HOIST—FOUNDRY CONTROL

Capacity, Lb.	Hoisting Speed in Ft. Per Min.	No. of Hoisting Ropes	Maximum Lift in Ft.
1,000	40	2	20
2,000	40	2	20
4,000	20	2	20
6,000	20	2	22
8,000	25	2	22
10,000	26	2	23
15,000	27	2	23
20,000	20	2	23
25,000	16	2	23
30,000	14	3	15
40,000	10	4	11

FLOOR OPERATED ELECTRIC HOIST—SINGLE SPEED

Capacity, Lb.	Hoisting Speed in Ft. Per Min.	No. of Hoisting Ropes	Maximum Lift in Ft.
500	25	2½	14
1,000	28	2½	14
2,000	20	2½	18
4,000	20	2½	40
6,000	13	2½	32
8,000	10	4½	20
10,000	8	4½	20

Monorail Hoists and Telfers

Monorail hoists and telfers are used in many industrial operations where some method of quickly lifting and transporting the materials to various parts of the plant is essential. The character of the work required of a hoisting and transporting machine in many of the processes of manufacturing precludes the use of the overhead traveling crane and, in cases where comparatively light objects must be moved from one department to another, some form of hoisting machine traveling on a monorail has been found best adapted to the work. The monorail being suspended from the ceiling or other overhead portion of the building may be installed and used without interfering with operations in the area underneath and therefore is preferable to the industrial platform car, which requires a clear floor space in which to lay the necessary track and which must also be kept open to operate the car.

The monorail hoist of the cab-operated type and the monorail telfer are similar in general design and usage and are often classed as identical machines. There are, however, some distinctive differences in their construction: The cab-operated monorail hoist consists of an electric hoist to which is attached an operator's cage or cab. Generally a flexible connection is used between the hoist and the cab, but many machines of this type are built on a rigid frame. The cab contains the motor controls and space is provided for the operator so that he may travel with the load. This apparatus usually is suspended from and travels on the lower part of the monorail in the same manner as the ordi-

nary floor-controlled electric hoist and is used chiefly in indoor work, although it may be and frequently is used in outdoor service. It is commonly used as a single unit to handle some form of accessory such as bucket, a magnet, or hooks of various types but in some instances it also hauls a trailer.

The telfer differs somewhat from the cab-operated monorail hoist, the hoisting machinery and the operator's cab being built on a rigid frame and suspended from small swiveling trolleys or trucks, usually traveling on a rail laid on top of a supporting structure and taking power from an overhead line through one or more short trolley poles equipped with collector wheels or flat sliding shoes. Generally some form of double-hook hoisting apparatus is provided and the telfer is operated in the same manner as the ordinary monorail hoist. Some forms of telfers are designed to travel on a cable instead of the rigid monorail and many of them are equipped for automatic operation at predetermined points, the operator being stationed at a remote fixed point.

Monorail Hoists

Many electric hoists of the floor-controlled types installed on a monorail and used to handle material over a limited area—an area restricted to a comparatively short distance—are frequently referred to as "monorail hoists." This term has, however, by common usage, come to mean more specifically an electric hoist having attached to it a cage or cab



Double-Hook Electric Monorail Hoist, Installed to Handle Material Delivered by Chute from Upper Floor



Electric Monorail Hoist Handling Rolls of Paper



Electric Monorail Hoist Handling Baled Material with Grapple Hooks and Loading from Storage to Cars or from Cars to Storage

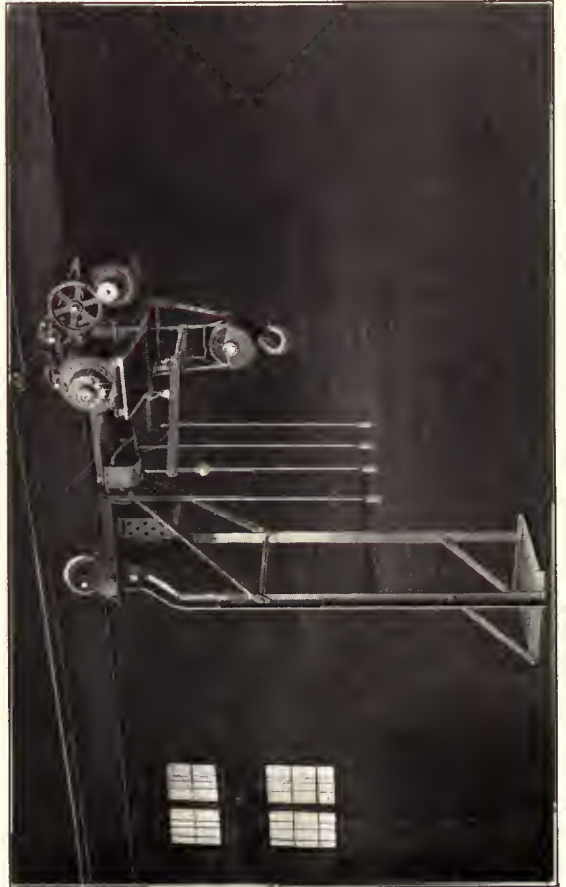

Electric Monorail Hoist with Low Platform for Operator

in which the controllers are installed and space is provided for the operator so that he may travel with the load.

These machines are used chiefly in industrial plants, power plants, or warehouses, but they may be used wherever the necessary trackage can be installed. They may be equipped with the ordinary fall-block and hook or with a plain hook suspended from the hoisting drum and may be used in machine shops and foundries or in any other indoor or outdoor service where a hoist is required. They may also be equipped with hoisting accessories, such as a magnet for handling metals; with an automatic grab-bucket to handle fuel in power plants or in operations such as handling gravel or sand; or they may be equipped with any of the various types of grab hooks, clamps, grapples, or slings and be used in practically any class of service where hoisting is necessary. They are particularly adapted to handling some form of container for transporting materials about a shop or in a warehouse. Being suspended on an overhead track the entire floor space underneath may be utilized for other purposes.

The complete equipment consists of an electric hoist, generally constructed in substantially the same manner as the floor-controlled types and suspended from the monorail on two pairs of trolley wheels propelled by electric power; and the operator's cab, also suspended from the monorail, generally on a plain trolley and connected to the hoist frame so that it travels with the hoist. The entire machine travels on the lower flanges of the monorail and has sufficient flexibility to pass around curves of very short radius. Various forms of switches and turntables are also provided in the trackage system which allow the machine to make 90 deg. turns and to travel into any part of a building from room to room, thus making a most efficient means of conveying the raw materials to the machines and for removing the finished products. Power is taken from a line installed on the monorail itself, or on the supporting structure, and is conducted to the motors through a rolling or sliding type of current collector. These machines may be operated on either a direct current or an alternating current.

Approximate capacities, speeds, etc., of cab-operated monorail hoists are given in the following table:

CAB-OPERATED MONORAIL HOISTS

Capacity, Tons	Hoist				Trolley		
	Speed, Ft. Per Min.	Lift, Ft.	No. of Ropes	Motor H. P.	Speed, Ft. Per Min.	Motor H. P.	Min. Ra- dius of Curve, Ft.
DIRECT CURRENT							
1/2	30	28	1	1 1/2	350	2	8
1	20	30	2	3	350	2	8
1 1/2	26	50	2	6	350	4	8
2	30	50	2	9	350	4	8
3	23	21	3	6	350	6	6
4	17	15	4	6	350	6	6
4 1/2	33	31	3	12	350	8	6
6	25	23	4	12	350	10	6
ALTERNATING CURRENT							
1	40	30	2	5	350	2	8
1 1/2	30	50	2	5	350	2	8
2	30	50	2	5	350	3	8
3	23	21	3	5	350	5	6
4	17	17	4	5	350	6.5	6
4 1/2	33	31	3	15	350	10	6
6	25	23	4	15	350	10	6

Telphers

The telpher is similar in construction to the cab-operated monorail hoist and is used in much the same class of service. Telphers have, however, been adapted to a more extensive outdoor use and are used to transport materials for considerable distances. They may be installed on specially constructed trestles, on bridge structures, or on brackets secured to the side wall of a building. They gen-

erally travel on a rigidly supported monorail taking power from an overhead wire, but in some cases they are designed to travel on a suspended traction cable, often taking power through the cable itself. They are made in the man-riding or cab-operated types or may be equipped for automatic control, the operator manipulating the machine from a distance. Some form of automatic bucket or other accessory may be used, or the telpher may be provided with double hoisting hooks from which may be suspended a small platform car or a rack or other form of container into which the material may be loaded.

The facility with which a machine of this type may be manipulated in close quarters—as usually is necessary, particularly in warehouse work—makes the telpher a most efficient apparatus for handling miscellaneous freight or for handling any class of loose or package freight in constant volume.

In many cases the installation of a telpher may entirely supersede the use of manual labor or of trucking material by teams or by other forms of transportation. It is also possible to install the overhead trackage in many otherwise inaccessible places, as over ravines or rivers or rough country where it would be impossible to establish many of the other modes of transport.

Cab-Operated Monorail Telphers

In the most commonly used type of telpher, the operator travels with the machine and controls its operation from the cab. The complete machine consists of an electric hoisting apparatus and the operator's cab, both being built into a rigid frame and suspended from trolley trucks which travel on a monorail; and some form of fixed or detachable car or container which may be lowered to the floor, and then filled and hoisted and transported where desired.

The hoisting apparatus may either be similar to the ordinary type of electrically operated geared hoist or may be designed with one or more hoisting drums similar to those on trolleys used on the overhead bridge type of traveling crane. In some cases where it is necessary to hoist through a considerable height the telpher is designed so that the cab may be raised or lowered with the load, thus giving the operator a close view of the work at all times. This feature is especially desirable where fragile materials are being handled and it also permits the operator to assist in loading if necessary.

The trolleys may be of the two-wheel geared type and be used in multiple, or two trolleys of the swiveling-truck type may be used. These trolleys are commonly designed to travel on top of the monorail but in some cases, where the headroom is limited or for other reasons, trolleys similar to those used on monorail hoists are installed and travel on the lower flanges of the rail—usually an I-beam. The power for the hoisting motor and the trolley traveling motor is taken from an overhead wire through short trolley poles having either the revolving or the sliding type of current collector.

Telphers of this type range in capacities upward to about 6 or 8 tons and may attain a speed ranging upward to about 1500 ft. per min. on straight track. They are frequently used in trains consisting of one or more trailers which are suspended from trolleys and are hauled by the main or driven telpher.

Many installations of telphers of this type have been made in coal storage plants; in warehouse work, particularly where the telpher is required to unload from a car or vessel and also to distribute the material in the warehouse; in steel mills for handling fuel or raw materials; or in paper mills or any similar industries for handling either

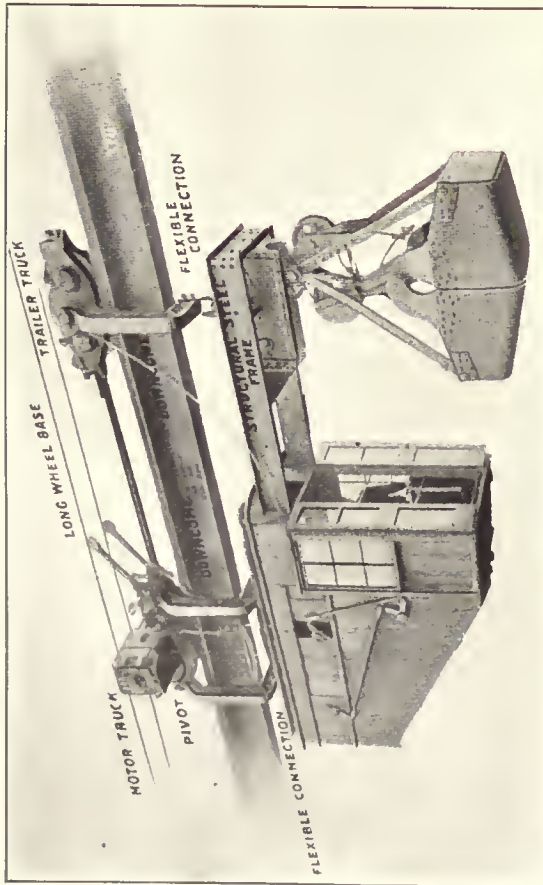

Monorail Trolley Equipped with Grab Bucket for Handling Loose Materials

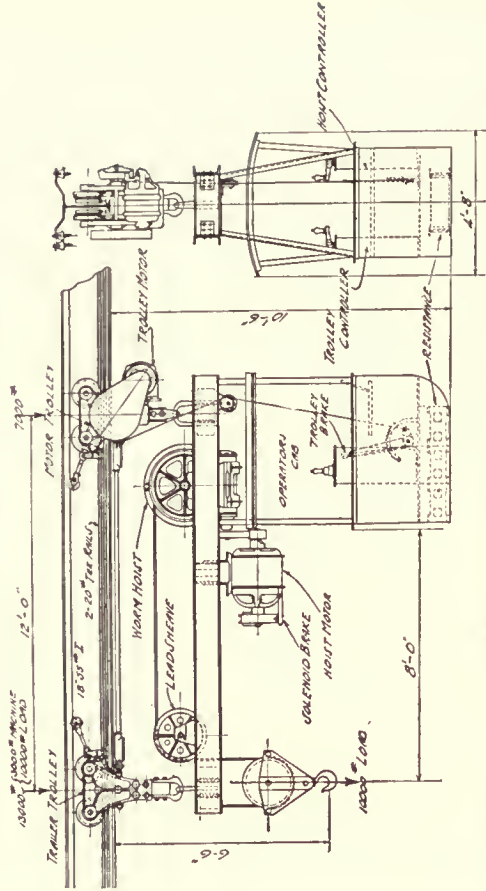

General Drawing of Monorail Trolley Traveling on Lower Flanges of Rail

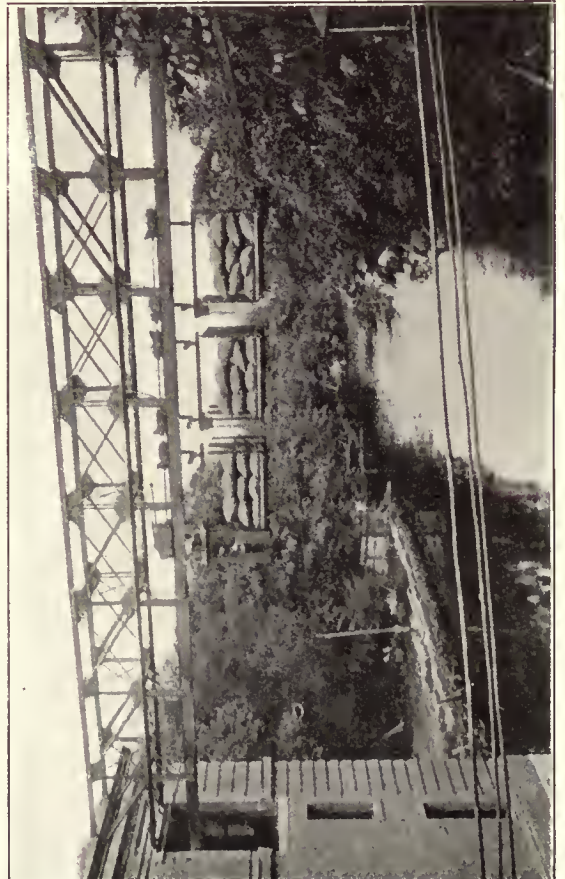

Cab-Operated Monorail Trolley Handling Trailers Loaded with Bags

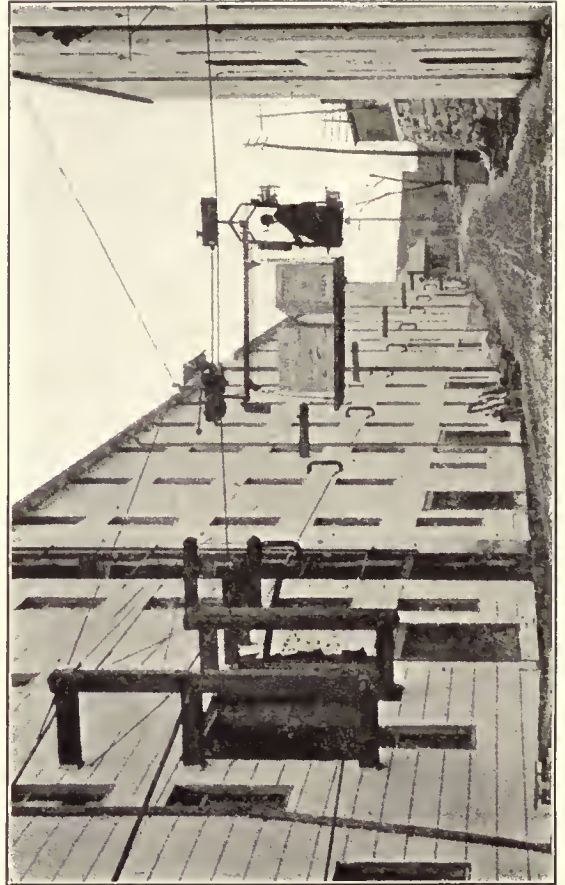

Cable-Operated Cable Trolley Handling Material in Industrial Plant

loose or package materials. They vary considerably in capacity, depending upon the class of material being handled and the distance which it must be hoisted and transported.

In one typical installation the telpher system was designed to take material—contained in bags—from an upper floor of a building and convey it across a river to the upper floor of a building on the opposite shore. The monorail is installed on supports consisting chiefly of wooden trestles built partly on level ground and in some places along the side of a cliff. The track includes several 90 deg. curves of 20 ft. radius and passes over the roof of an intervening building and thence over the river at an elevation of about 50 ft. on a specially constructed steel bridge. A telpher train consisting of the power driven telpher and two trailers having a total capacity of about 4 tons is used. The complete train has a total length of 30 ft. and attains an average speed of 700 ft. per min. This installation with one man performs the same work that formerly required the use of several teams and men. The cost for electric power is comparatively negligible.

In another installation the telpher system is used to handle miscellaneous freight on a steamship pier. In this case the track is extended outward over the pier and the vessel by a folding-jib wharf crane. A number of platform cars having a capacity of about 3 tons each are used. The freight is placed on a car and then hoisted and transported to or from a vessel. As one car is being handled by the telpher another car may be loaded, thus keeping up a continuous movement of material. Similar installations may be made in a series so that a vessel might be unloaded through one port while material is being loaded through another port. By the use of switches and by-passes inside of the warehouse several telfers may be utilized on a single track monorail system.

Many adaptations of the telpher have been made to handle loose materials with an automatic grab bucket. In a typical installation for such service, the telpher is used to deliver coal into a power house and to remove the ashes from the house, thus making it possible to make many round trips carrying a load each way. The bucket lines are manipulated by the drums on the hoisting apparatus in the same way as on other hoisting machines. A telpher of this type has a capacity of upward to 150 tons or more per day depending upon the capacity of the bucket and the distance traveled.

Cable Telfers

The cable telpher is used in certain classes of service where the construction of the rigid monorail is not possible or desirable. This type of telpher is designed to travel on a suspended cable which in many cases also serves as a power line to transmit the current to the telpher motors.

A common method of construction consists of a traction cable suspended from trestles or bents, or from brackets secured to the side wall of a building or other structure. The cable is suspended between the side members of the bents and is supported at midway points by a suspension cable secured to the top of the bent. The bents may be placed 50 ft. or more apart, depending on the weight of the

load to be carried. This form of trackage does not require that the supports be so closely spaced as the rigid monorail.

This method of telpherage is particularly desirable where it is necessary to cross a ravine or a body of water or where the placing of trestle supports for a monorail would interfere with the use of the space underneath. The telpher itself is constructed in substantially the same manner as the monorail telpher except that the trolley truck wheels are designed to travel on the cable.

The cable telpher is suitable for use in light service where the load will not exceed 1500 lb. to 2000 lb. and the line of travel is comparatively straight, or the curves are of very long radius. It is employed chiefly in large industrial plants, particularly where it is necessary to transport material between remote points about the plant. The cable telpher may be equipped with various forms of material handling accessories or may have a small car or container into which the material may be loaded.

In a typical installation of the cab-operated cable telpher a platform type of carrier having a capacity of one ton is used. The cable is supported partly by trestlework and partly by a special bracket structure secured to the side of a building. In the operation of this telpher the material is loaded on the carrier and is brought to the telpher line at the door of the building on a truck from which it is hoisted and carried—by the telpher—into the second story of an adjacent building. A telpher of this type is particularly useful for handling material which must be transported to various parts of a plant in the process of manufacture. It may also be used to handle raw or finished materials into and out of storage.

Automatic Telfers

Automatic telfers of both the monorail and the cable types have been adapted to many industries. They are particularly suitable for use where such materials as coal, coke, sand or gravel, or various forms of package materials, are handled in constant volume. In this type of telpher the operator is stationed at a remote point and generally controls only the starting of the telpher, the stopping and unloading operations being controlled by automatic switches and stops installed on the monorail or the cable at the desired discharge point. In some cases, however, the entire operation of the telpher is controlled from the ground or from a fixed platform so located as to give the operator a constant view of the work.

The performance of an automatic telpher of the monorail type installed in a coke and gas works is illustrative of the service for which this type of machine is adapted. In this installation, the telpher is equipped with a strongly constructed steel basket having a capacity of about six tons. The coke is pushed from the ovens directly into the basket and is carried by the telpher and lowered into the quenching tank. After quenching it is hoisted from the tank and conveyed to the coke pile and dumped. This telpher has a hoisting speed of 60 ft. per min. and travels at the rate of 800 ft. per min. The entire operation of the machine is controlled from the ground.



Wooden Guy Derrick Equipped with Turnover Bucket for Handling Loose Material



Wooden Stiff-Leg Derrick Equipped with Sling for Handling Materials in Construction



Wooden Traveling-Car Derrick Equipped with Automatic Grab Bucket

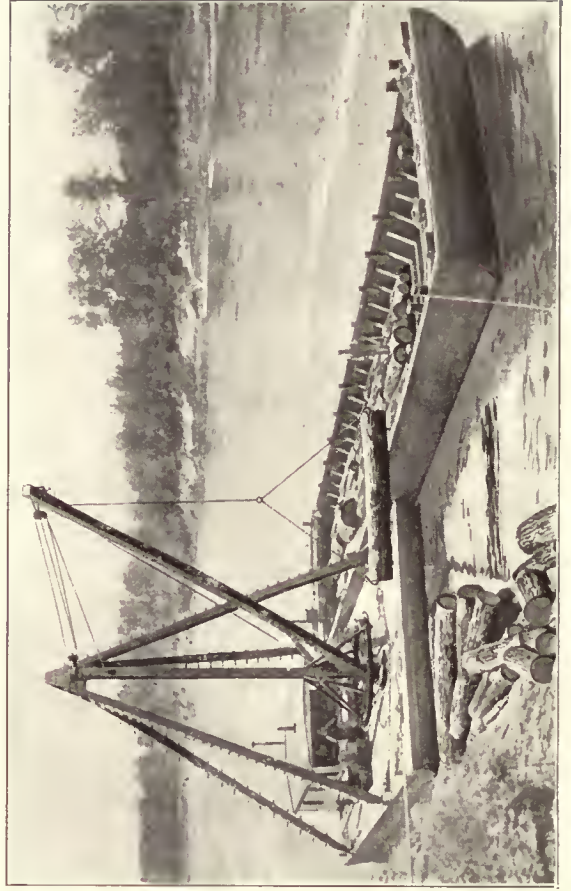

Wooden Barge Derrick Handling Logs with Grab Hooks

Derricks

A DERRICK WILL PERFORM many of the same operations as a crane, and, when the service required is within the scope of the machine, it may be used to advantage as a component part of material handling equipment in construction work, railroad yards, ship yards, coal, lumber, or other storage yards, foundries, quarries, and in many other similar operations. When installed on a pier or on a barge, a derrick becomes an efficient means of loading or unloading vessels, or it may be used to advantage in dredging operations. As an integral part of ships' gear derricks are an important factor in cargo handling.

Many derricks of both light and heavy capacity are constructed of wood reinforced by iron and steel fittings. In such construction the timbers should be carefully selected in order to secure straight-grained, well-seasoned, tough wood and the fittings should be of such design and so applied as to insure a free movement of the derrick mast and the boom and to permit the easy operation of the tackle and the accessories, such as buckets, slings, or grapples.

In steel construction, which, because of its greater durability and the greater accuracy with which its strength may be determined is preferable where a permanent derrick is desired, or when constant heavy service is required, the members should preferably

be of the lattice-truss type, so proportioned as to give the required strength against collapse under load and to resist the twisting strain due to slewing the derrick.

The general principles of construction followed in all derricks are similar, but there are three distinct types: the guy derrick having the mast supported by guys; the stiff-leg derrick, having the mast supported by stiff-legs or props; the tower derrick, having a tower structure, to which the mast is secured, held in an upright position by weights placed at the base and by short braces or guys at the lower part of the tower frame, but without the guys or stiff-legs usually secured to the top of the mast. There are many special designs of derricks but the essential characteristics are modifications or combinations of these three types.

The most important considerations in derrick design are: maximum strength and capacity, minimum weight, and convenience in transporting, assembling, and operating.

The capacity of a derrick depends on the relative length of the mast and of the boom; these are determined by the character of the service desired. The shorter the length of the boom with a given height of mast, the greater the capacity. When heavy loads are to be handled within a short radius of action it is desirable to use a short boom and a mast having a height sufficient to cause the topping lift always to act in a horizontal or in an upward direction. This condition rarely is obtainable in derricks of the stiff-leg type, the boom usually being longer than the mast. However, due consideration should be given to

any other service in which the same machine may be used so that the range of work handled may be as wide as possible. When it is desired to handle material over a large area the length of the boom should be as long as is consistent with the structural strength and the efficient operation of the tackle.

Many derricks are fitted with a ball-bearing foot block so that they may easily be swung by hand; this serves admirably for certain classes of work. However, the efficiency of a derrick used constantly, or for heavy work, will be greatly increased if it is equipped with a self-slewing gear or with a bull-wheel. These devices are practically essential in heavy work in order to avoid undue strains to the derrick structure and to facilitate operation.

The method of applying the power required to operate a derrick depends on the character and volume of the work to be done. The lighter capacity machines, especially when used only at infrequent intervals, are equipped with a hand-power winch. Winches used on derricks of heavy capacity or in constant or frequent service generally are operated by steam, gasoline, or electric power: sometimes by a horse or a mule.

Guy Derricks

There are various forms of guy derricks, the simplest type being a plain mast and boom with a hand-power winch attached to the mast for raising and lowering the fall block, the boom being controlled by a topping-lift hauled by hand and secured to a cleat on the mast. Other forms of guy derricks are designed for half hand and half power operation, or for full power operation by steam or electricity. The heavier capacities are equipped with self-slewing gear or with a bull-wheel.

Guy derricks are used with a fall block and a hook or a sling for general hoisting purposes or they may be equipped to handle an automatic hucket and in some cases are used to handle an electric magnet. They are used in quarries, lumber yards, shipyards, etc., in construction work for general hoisting purposes, or, when operated by a suitable hoisting apparatus, are used for bucket work in handling loose materials such as coal, sand, gravel or similar materials.

For heavy work the guy derrick is a most common type. The guys are secured to a building or to any fixed object in the vicinity of the derrick. The outer ends of the guys should be secured at the highest available point below the top of the mast, but, if possible with the guy lines above the top of the boom when at its highest working point so that the derrick may be free to swing in a full circle without unnecessary lowering of the boom. When this condition is obtainable the derrick is termed a full-circle guy derrick.

In locations where it is not possible to secure a guy line at a height or a distance from the derrick that will permit

Stationary Derricks: Guy; Stiff-Leg; Sheer-Legs; Tower.

Portable and Traveling Derricks: Barge; Car; Stiff-Leg; Skid; Jinniwink; Pile Driver; Counterweight.

Light Capacity Derricks: Pole, Gin Pole; Breast; Tripod; Sulky; A-Frame.

Derrick Details: Fittings; Slewing Apparatus. Cargo Handling Gear.

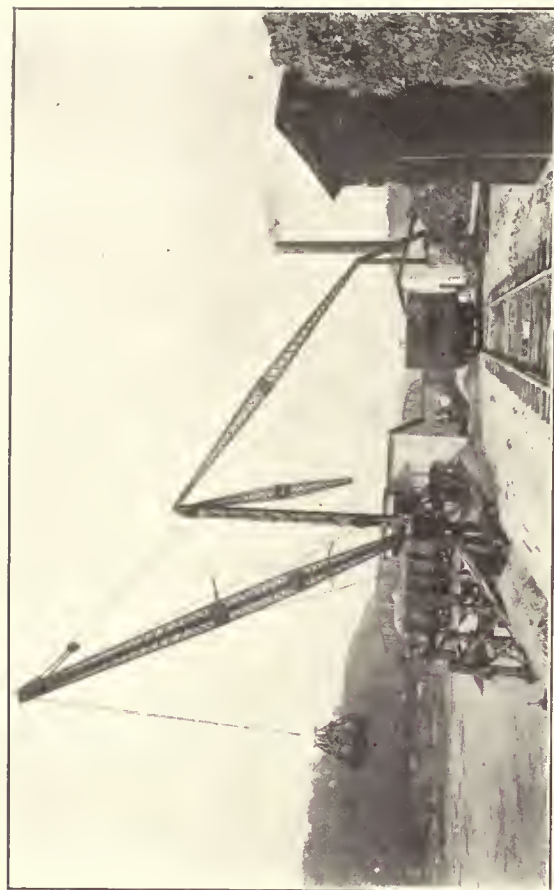

Steel Stiff-Leg Derrick Equipped with Grab Bucket for Loading Loose Materials

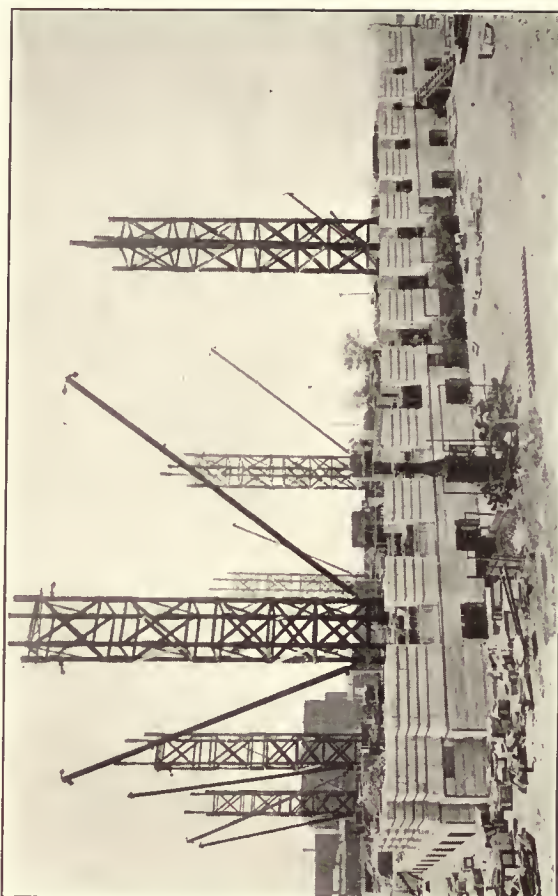

Group of Tower Derricks Installed for Handling Stone Block and Other Material in Building Operations



Full-Circle Steel Stiff-Leg Derrick Installed in Storage Yard

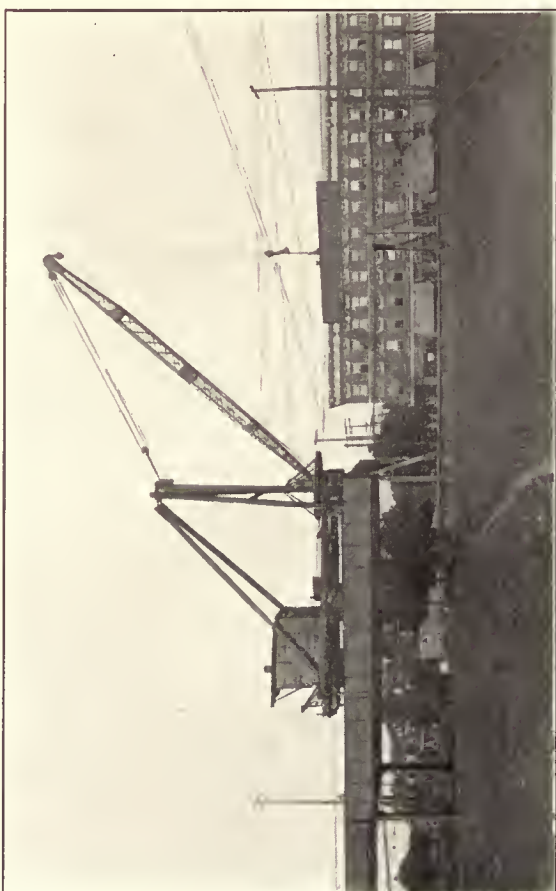

Traveling-Car Stiff-Leg Derrick Handling Girders in Elevated Railroad Construction Work. Wooden Frame, Steel Boom

full circle operation, and to avoid obstructing the passage about the derrick, a deadman or strut is sometimes used under the guys. This permits the use of shorter guys, requires less yardroom and eliminates the necessity of continually lowering the boom to clear the guys when it is necessary to slew the derrick.

The number and size of the guys has a direct effect on the strength and capacity of a derrick; they should range from five 3/8 in. lines for light capacities to ten 1 1/4 in., or, larger, lines for heavy work. For average service, on level ground, the length of the guys should not be less than three times the height of the mast.

Guys, particularly for derricks of heavy capacity and for installations extending over a long period, or for a permanent derrick, should be of steel or iron wire rope, galvanized to protect it from rust. A good quality of manila rope may be used on small derricks that are moved frequently.

The construction and strength of guy ropes is treated in the chapter on wire rope.

Wooden Guy Derricks

The capacities of guy derricks constructed of wood, reinforced with iron and steel fittings, range upward to 40 tons, and of steel construction to 100 tons, or more. The following table gives recommended lengths for masts and booms for wooden derricks.

GUY DERRICKS—WOOD

Capacity, Tons	Mast		Boom	
	Length, Ft.	Section, In.	Length, Ft.	Section, In.
1 1/2	34	8x8	25	6x6
3	42	10x10	34	8x8
6	50	12x12	40	10x10
10	55	14x14	45	12x12
16	60	16x16	50	14x14
24	65	18x18	55	16x16
32	70	20x20	55	18x18
40	70	22x22	55	20x20

Steel Guy Derricks

The proportions of the members of steel derricks are so varied in order to meet specific requirements that there are no strictly defined sizes. They range in capacity upward to 100 tons or more. Steel derricks built for unusual service conditions sometimes have a length of boom as great as 125 ft., but for the average service the proportions of mast and boom given in the following table are used.

GUY DERRICKS—STEEL

Capacity, Tons	Mast		Boom	
	Length, Ft.	Section	Length, Ft.	Section
5 to 50	50	Lattice	40	Lattice
5 to 50	60	Lattice	50	Lattice
5 to 50	70	Lattice	60	Lattice
5 to 50	80	Lattice	70	Lattice
5 to 50	95	Lattice	80	Lattice
5 to 50	105	Lattice	90	Lattice
5 to 50	115	Lattice	100	Lattice

Stiff-Leg Derrick

The stiff-leg derrick is similar to the guy derrick except that the mast is supported by stiff-legs, or props, anchored securely at the bottom by bolting to a concrete anchor block or to any firmly secured point on the floor or in the ground. The circular range of this type of derrick is restricted by the location of the stiff-legs and for this reason the stiff-legs sometimes are supported by A-frames, at a height sufficient to allow the boom to clear the legs, thus permitting it to swing through a complete circle. It is then called a full-circle stiff-leg derrick. In the light capacity derricks, the stiff-legs are bolted to sills, or lie-legs, instead of to isolated anchorages.

As with guy derricks, the relative proportions of steel masts and booms for derricks of the stiff-leg type may be

varied to suit the service required, but the commonly used proportions are that the length of the boom shall be one and one-half to two times the height of the mast, which ranges upward to 50 or 60 ft.

It is not practicable to have extremely high masts on stiff-leg derricks, nor for general service should the length of the boom be much more than one and one-half times the height of the mast. The proportions given in the tables have been established by operating experience and are recommended for the average service.

STIFF-LEG DERRICKS—WOOD

Capacity, Tons	Mast		Boom	
	Length, Ft.	Section, In.	Length, Ft.	Section, In.
1 1/2	16	8x8	25	6x6
3	22	10x10	35	8x8
5	26	12x12	40	10x10
8	30	14x14	45	12x12
12	33	16x16	50	14x14
18	36	18x18	55	16x16
24	36	20x20	55	18x18
33	36	22x22	55	20x20

Derricks of this kind are used for the same class of work as the guy derrick and may be equipped in the same way with self-slewing gear or with a bull-wheel. They are used where the surroundings will not permit the use of guys or where a permanent derrick is required, as on freight platforms, in railroad yards, on wharfs, at industrial plants, or for extensive construction work.

Stiff-leg derricks sometimes are mounted on towers so that the boom will clear the side of a vessel and are used on fitting-out docks to place machinery and boilers in ships. Such derricks usually are fitted with a several part main fall-block for heavy loads and an auxiliary fall for handling and setting winches, capstans and other light pieces. They also are mounted on cars, on barges, on road wheels, or on skids and are used with a hook and tackle for general hoisting purposes or may be equipped for bucket operation and be used for handling coal or sand; in general excavation work; or for dredging. When erected on a rigid foundation, derricks of the stiff-leg type have a capacity up to 40 tons for wooden construction and to 150 tons for steel construction.

A wooden derrick having the stiff-legs secured to lie-legs, and equipped with a single hoisting line, operated by a hand-power winch secured to the mast and slewed by hand, is useful in light service. Such a machine is adapted to use in construction work or for the yards of industrial plants where only comparatively light loads are handled and speed of operation is not required. It can easily be moved from one location to another.

A group of wooden stiff-leg derricks may be installed on the partly erected inner walls of a building and used to handle the heavy blocks of stone for the outer walls. These derricks are usually of light construction and have trussed booms in order to cover a wide area without excessive weight of parts. They can also be used to place heavy beams and girders as the building progresses.

Tower Derrick

A tower derrick has special advantages in the erection of large buildings or in locations where it is impossible or not desirable to use either the guy or the stiff-leg derrick. The tower may be built of any desired height and placed at any point near the building under construction. The derrick timbers and fittings may be secured to any of the corners of the tower and, if needed, two derricks may be applied to one tower—at diagonal corners. As the building progresses, the height of the tower may be increased and the derrick moved upward by changing the location of the brackets supporting the mast and the boom.

Tower derricks are useful not only in handling building

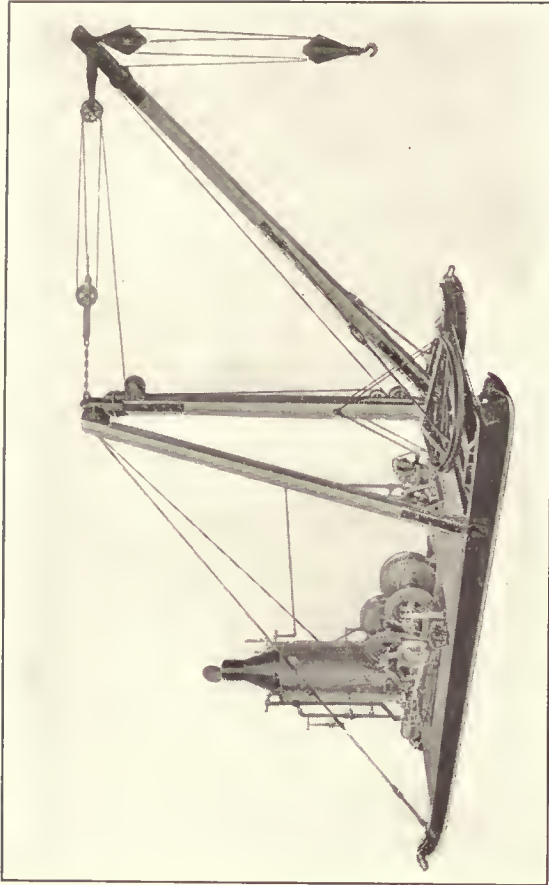

Skid Derrick Equipped with Built-Wheel and with Fall-Block for General Hoisting Service

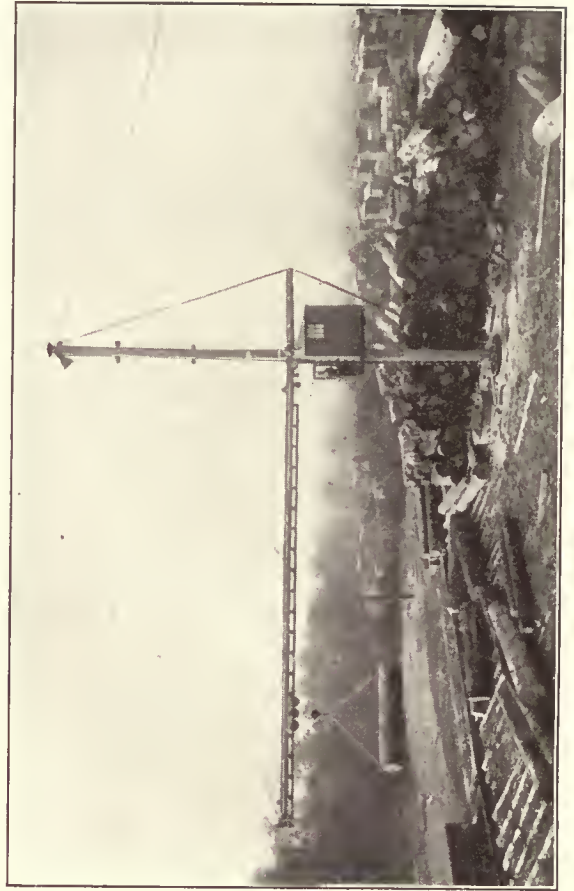

Crane-Derrick Equipped with Fall-Block and Chain Grab-Hooks for Handling Logs



Barge Derrick Equipped with Grab Bucket for Excavation Work or Handling Loose Materials



Crane-Derrick Equipped with Automatic Grapple for Handling Sugar Cane at Mill

material in construction work but may be utilized for many of the same purposes for which the guy or the stiff-leg derricks are used.

The capacities of these derricks, as in the two other types already described, are in proportion to the relative lengths of the mast and boom. Having the same proportions of members the capacity is approximately the same as for a similar size in either of the other types. On some towers the derrick mast is omitted and a beam placed diagonally across the tower to serve as a support for the boom seat. The topping lift and the hoist line are secured to an upper post bracket. This construction is thoroughly efficient for light service and the location of the derricks on the tower structure can be changed quickly.

Portable and Traveling Derricks

It frequently is desirable to have a derrick so arranged that it may be transported easily without the necessity of dismantling it. To meet such conditions derricks are erected on skids or on barges, on trucks having wheels which may run on standard gage railroad tracks or which may require a specially laid track, or the trucks may have wheels with a plain tread which run on the ground or on the floors of warehouses and shops.

Floating or Barge Derrick

The floating or barge derrick is a development due to the need of a derrick of sufficient capacity for heavy work, yet easily transportable, for use alongside wharves and for shipping on the water front or for dredging purposes. A derrick of this type is used for general hoisting purposes in handling freight when loading or unloading vessels; for bucket work in handling loose materials such as coal, sand and gravel; and for digging or for grapple work in dredging operations.

When constructed for dredging work in streams or other open waters the barge usually is built of a size sufficient to provide storage space for a considerable amount of the material excavated. If, however, the derrick is required chiefly for use in excavating a channel or a canal through marshy land the barge is designed only to carry the derrick and the hoisting machinery, the material excavated being discharged from the bucket at either side of the barge. The barge derrick generally is either of the stiff-leg or the A-frame type of construction and ranges in capacities up to 100 tons for the average service. Floating or pontoon derricks have, however, been constructed of much greater capacities for special service in marine work.

The relative capacity of such derricks when used in hoisting service and for bucket operation is as follows:

BARGE DERRICKS

Nominal capacity (tons)	3	5	8	12	18
Size of bucket (cu. yds.)	¾	1½	2	3	4
Length of mast.....	22 ft.	26 ft.	30 ft.	33 ft.	36 ft.
Length of boom.....	34 ft.	40 ft.	45 ft.	50 ft.	55 ft.

Those of the lighter capacities generally are equipped with a bull-wheel, but in the heavier capacities the derrick usually is rotated by means of side tackle attached to the boom and operated by a two-drum winch acting independently of the main hoisting apparatus. The tendency of a barge to list when a load is suspended from the boom end at either side of the barge greatly increases the strain on the derrick structure and for this reason the capacity of a barge derrick is less than for a similar size of the stiff-leg type mounted on a rigid base.

A type of barge generally known as a lighter and used in transferring the cargo from the ship to the wharf, or

vice-versa, sometimes is equipped with a derrick. Lighters ordinarily are towed but often are provided with means of self-propulsion.

Traveling-Car Derrick

The traveling-car derrick is mounted on a standard gage platform car which is provided with means of self-propulsion—generally steam or electric power. The derrick structure is similar to the stiff-leg type except that the mast usually is given additional support by an A-frame or sheer legs. Sometimes the mast is dispensed with and the upper sheaves are installed at the peak of the A-frame. Tie rods may be substituted for the stiff-legs and provision made to lower the frame and the boom so that the car will pass through tunnels or over any part of a railroad line. These derricks are used in the construction of railroad bridges, or in similar work, but may serve for many of the same uses as the locomotive crane. Being of much lighter and more simple construction they are not so costly as locomotive cranes and where the service required is not extremely heavy nor frequent a car derrick is an economical piece of equipment. They seldom are made in capacities greater than 25 tons, being especially adapted to comparatively light construction work. They also are used for bucket work in handling coal or other loose material as well as for hoisting purposes.

Traveling Stiff-Leg Derrick

A similar machine called a traveling stiff-leg derrick usually is mounted on trucks having double flanged wheels and running on a special track. One truck is directly under the mast and the stiff-legs are supported by outriggers resting on two-wheel trucks. These outrigger trucks carry a bin which may be filled with earth, stone, or any other heavy material to give stability to the derrick. Such derricks are used with a fall-block in construction work, or for general hoisting purposes in railroad or industrial works, or may be equipped for bucket operation to handle coal, ashes, sand, gravel or any similar material. They are commonly made in capacities ranging from 3 tons to 10 tons.

Generally both the car derrick and the traveling stiff-leg derrick are equipped with either the self-slewing gear or with a bull-wheel.

Pile Driver Derrick

A machine known as a pile driver derrick is used for driving piles along the water's edge, or in embankment work in loose earth or in marshy land. This derrick is used mostly in marine work and generally is mounted on a float or barge. The pile leader is formed of two parallel perpendicular timbers which also form a guide or runway for the pile-driver hammer. The leaders are supported by a vertical truss or tower structure.

The pile to be driven is placed in the leader and, by means of a hoisting apparatus operating over sheaves in the top of the structure, a heavy rectangular metal hammer is raised to the top of the tower and then released and, being guided by the leader frame, drops on the top of the pile, driving it into the ground or the river bed.

A derrick of this kind with the hoisting winch and engine sometimes is erected on a platform and mounted on rollers placed on a rollway of wood or metal, or it may be mounted on a car placed on a track.

Pile drivers of this type rarely are self-propelled and for certain classes of work, particularly railroad work, locomotive pile drivers are used. Such machines are de-

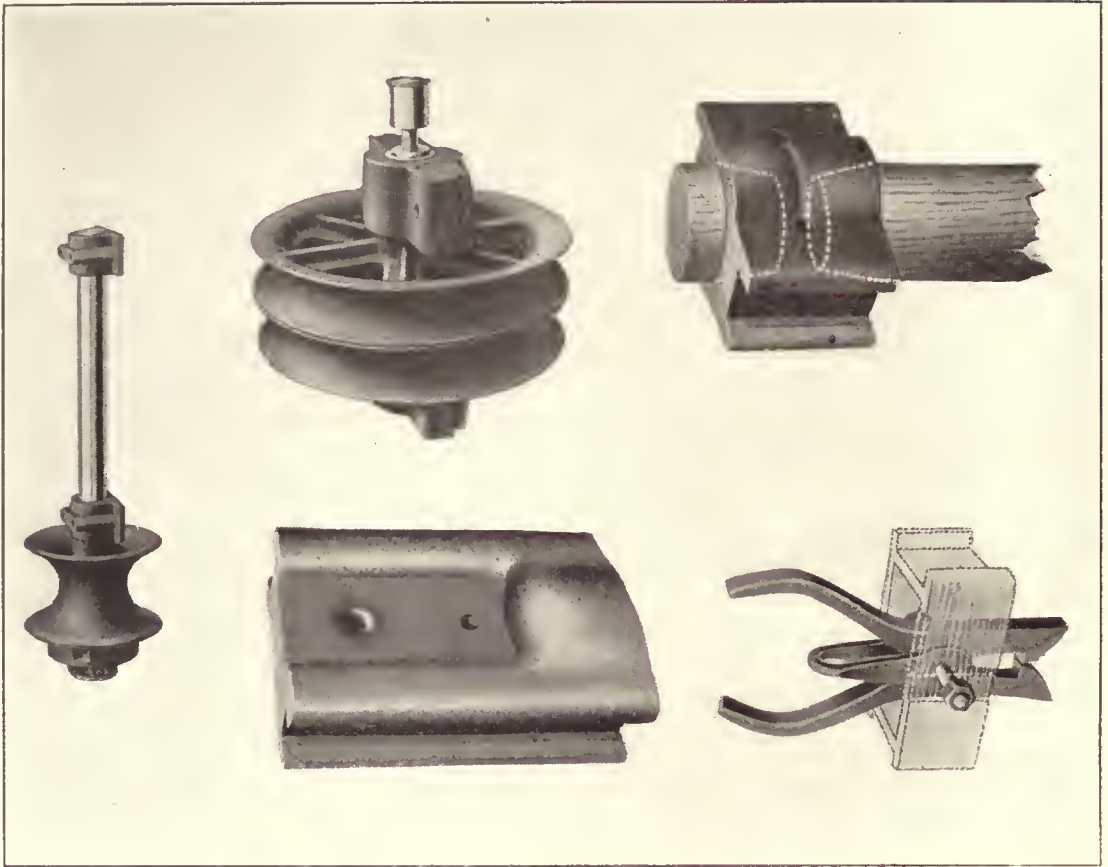

Pile Driver Details: Roller, Drop-Hammer, Top Sheaves, Trip Tongs for Horse Operation, and Pile Follower (lower right) for Pile End



Movable Steam-Operated Pile Driver Derrick, Mounted on Rollers and Traveling on Wooden Runway

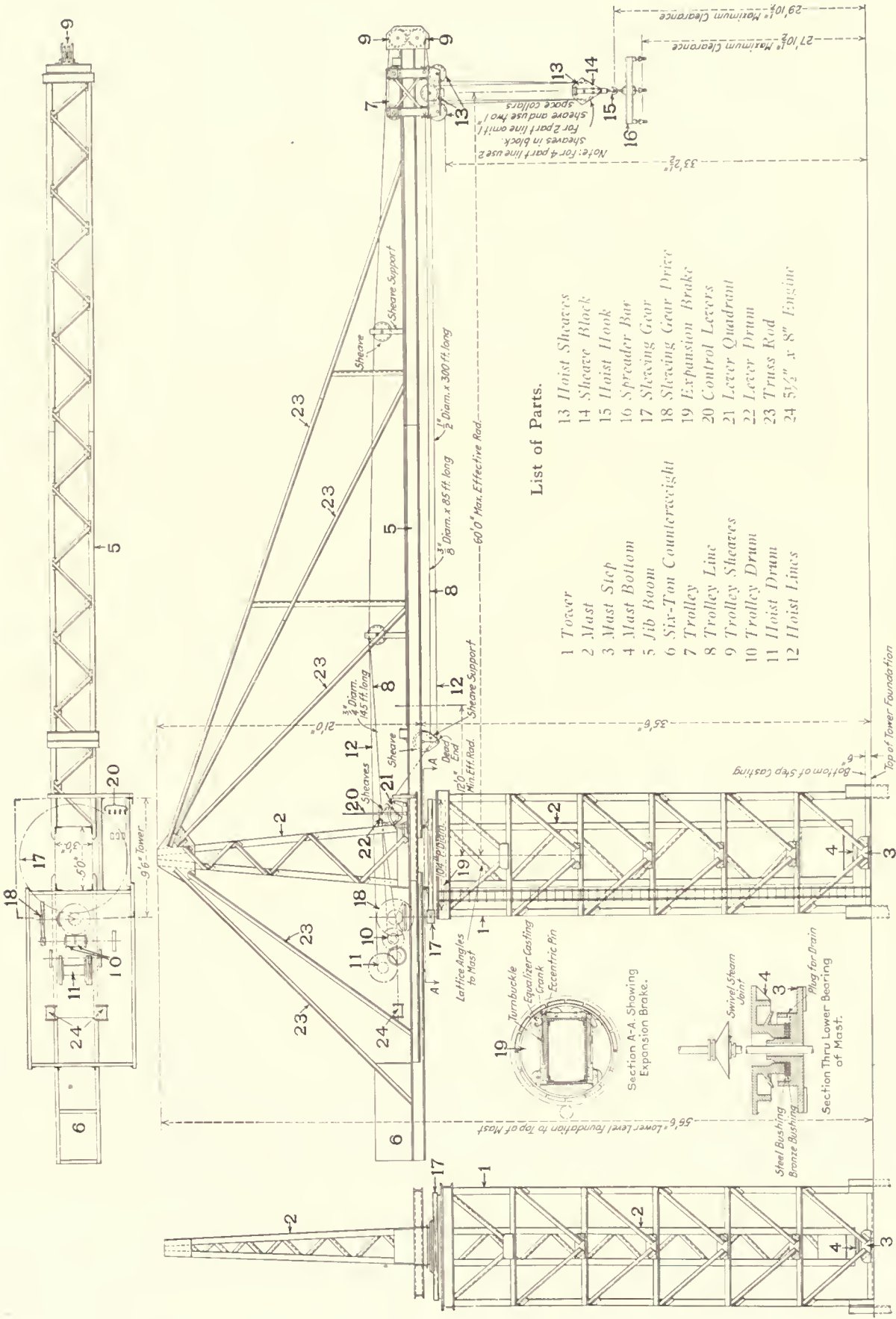

List of Parts.

- 1 Tower
- 2 Mast
- 3 Mast Step
- 4 Mast Bottom
- 5 Jib Boom
- 6 Six-Ton Counterweight
- 7 Trolley
- 8 Trolley Line
- 9 Trolley Sheaves
- 10 Trolley Drum
- 11 Hoist Drum
- 12 Hoist Lines
- 13 Hoist Sheaves
- 14 Sheave Block
- 15 Hoist Hook
- 16 Spreader Bar
- 17 Slewing Gear
- 18 Slewing Gear Drive
- 19 Expansion Brake
- 20 Control Levers
- 21 Lever Quadrant
- 22 Lever Drum
- 23 Truss Rod
- 24 5 1/2" x 8" Engine

Self-Supporting Steam-Operated Full-Circle Crane-Derrick. 5-Ton Capacity, 60 ft. Radius Jib Equipped with Rope Trolley

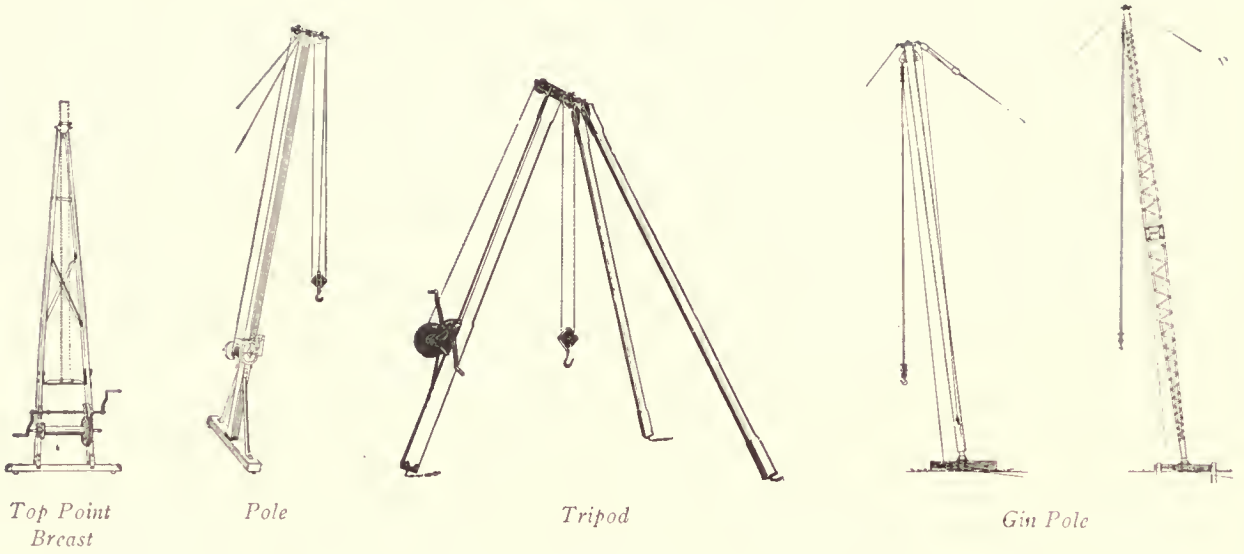

Top Point Breast

Pole

Tripod

Gin Pole

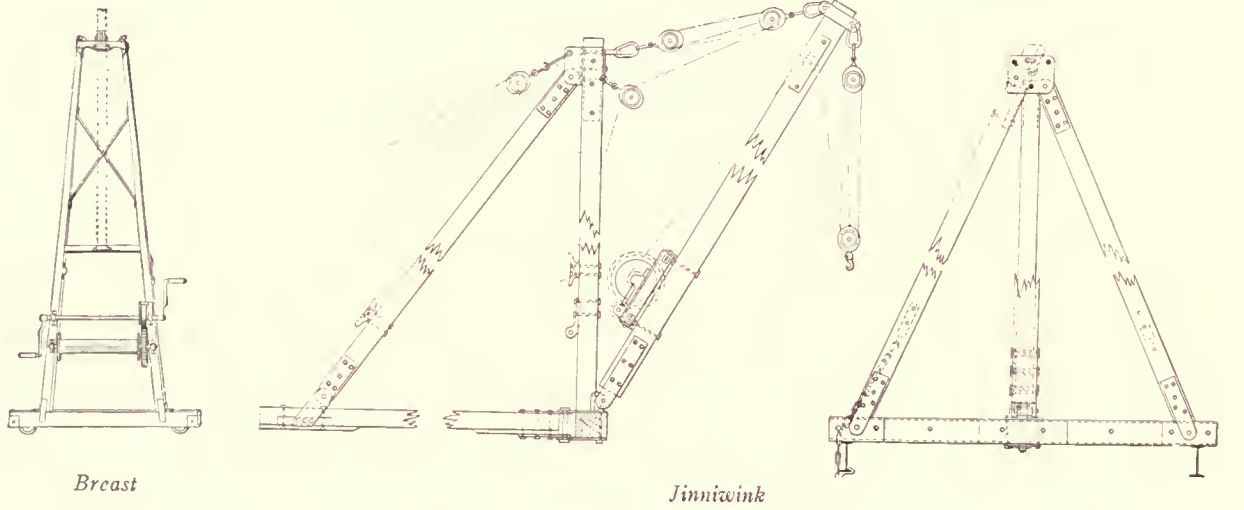

Breast

Jimmewink

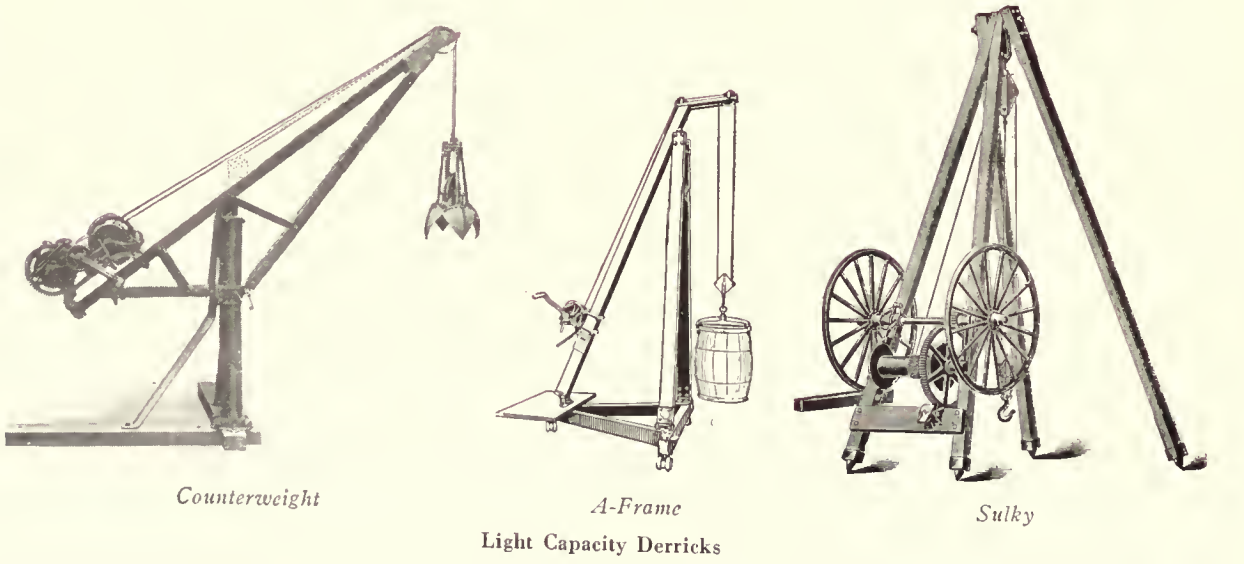

Counterweight

A-Frame Light Capacity Derricks

Sulky

scribed in this book in the chapter treating locomotive cranes.

Jinniwink Derrick

The jinniwink derrick is a light portable derrick extensively used in steel erection and other work where an easily moved and erected derrick is desired. These derricks seldom are made in capacities greater than 3 to 6 tons. The boom usually is about 30 ft. long and is secured to the base of an A-frame which has a height approximately one-half the boom length. In the lighter capacity derricks the main fall line, running over a sheave in the boom end, is operated by a hand-power winch attached to the boom. The boom is raised or lowered by hand, the topping lift being reeved through blocks secured to the top of the A-frame and the boom end and the line made fast to a cleat on the A-frame.

The heavier capacity machines usually are equipped with power operated hoisting winches.

Skid Derrick

The skid derrick is a light capacity portable derrick of the stiff-leg or the A-frame type, mounted with the hoisting winch and engine on a platform resting on wooden or metal runners or skids. It can be drawn on the skids to any desired location and if, in addition to the stability imparted by the weight of the machine itself, it is clamped or bolted to a firm foundation its capacity is practically the same as that of a similar size of fixed derrick. The capacity of such a derrick is limited by the gross weight of the machine so that it may be easily portable, and it therefore is seldom made in capacities greater than 8 to 10 tons. The full working capacity of these derricks is obtained when the boom is working directly forward but, by securing side guys to the structure after it is placed in the desired position, approximately the full capacity of the derrick may be obtained when working to either side.

The average capacities of skid derricks of this type are given in the table:

SKID DERRICKS

Cap. With Boom Forward, <i>Tons</i>	Cap. Boom with Side With-out Guys, <i>Tons</i>	Radius Full Load at Side With-out Guys, <i>Ft.</i>	Height, <i>Ft.</i>	Length of Boom, <i>Ft.</i>	Size of Frame, <i>Ft.</i>	Size of Mast, <i>In.</i>	Total Weight of, <i>Lb.</i>
3½	1½	10	15	20	9x25	10x10	14,000
4	2	15	22	30	9x25	10x10	19,000
5	2½	15	22	30	9x25	10x10	22,000
8	3	15	22	30	9x30	12x12	27,000

It is desirable that such derricks be fitted with a bull-wheel but in the lighter capacities this may be dispensed with. When it is not necessary to change the inclination of the boom, except occasionally, it may be done by hand power and in such cases a single-drum winch will serve for hoisting the load.

Counterweight Derrick

The counterweight derrick is a small derrick used around foundries or in industrial yards for handling heavy castings, iron or pipe, timber or stone. They also are used in building operations where, due to the compactness of the entire machine and the fact that no guys are required, they can be placed in any location desired as the building progresses. Generally the boom is pivoted at an intermediate point—sometimes at the top—on the derrick mast, which is fixed to the base and does not rotate. The hoisting apparatus, and if necessary additional weight, is placed at one end of the boom to act as a counterweight to the load. For excavation work the derrick may be equipped with a

double-drum winch and a small grab bucket—usually an orange-peel bucket—and be used for digging wells, sinking pipe, cleaning out catch-basins or similar work. They usually are operated by hand, but the heavier capacities often are equipped with electric power.

Derricks of this type may be mounted on trucks and be used in shops or yards where a light capacity portable derrick is desired.

Light Capacity Derricks

For a very light service and where it is desired to erect or to remove a derrick quickly, there are various small types which are used by builders and contractors for lifting stone, lowering pipe into trenches or for any light work in which only a direct vertical movement is required. These include the pole or gin pole derrick; breast derrick; tripod derrick; simple A-frame derrick; and sulky derrick. In all of these derricks, either the guyed mast or the hinged boom used in derricks of heavier capacities is dispensed with.

Pole Derrick

The pole derrick is the simplest form of derrick for light work. The single pole or mast is secured to a cross-bar base and is held in a slightly inclined position by guys which may be attached to any convenient fixed objects. The hoisting rope passes over a sheave in the top of the mast and thence to a hand-power winch at the base of the pole. Usually the base is provided with rollers so that the derrick may be moved easily. This derrick can only be used for handling comparatively small and light weight objects and usually where only a straight vertical lift is required. A limited horizontal movement may be obtained by securing the base of the pole against slipping and slackening off the guys.

Gin Pole Derrick

The gin pole is a type of pole derrick having a somewhat wider scope and it may be used to advantage in erection work and other operations. The pole rests in a socket base and may be inclined in any direction by the adjustment of the guys. This type is made in much greater heights than the ordinary pole derrick and will handle considerably larger and heavier objects. The shorter lengths and light capacities are made with a single wooden pole with iron or steel fittings, but those of greater height and heavier capacity generally are made in the lattice type of steel construction used in steel boom derricks.

Breast Derrick

The breast derrick is a type similar to the pole derrick but having two poles spaced apart and inclined toward each other at the top. The poles are secured to cross-bars and, like the pole derrick, are held in the desired position by guys. Sometimes the poles are brought to a point at the top and the derrick is then called a top-point breast derrick. The hoisting line passes through a block on the top cross-bar, or at the apex when the top bar is omitted, and thence to a hand-power winch secured between the poles near the base of the derrick. The breast type is used in the same way as the pole derrick but, having greater stability, can be used for heavier work.

Tripod Derrick

The tripod derrick is used in the same class of work as the pole or the breast types but requires no guys and therefore may be more quickly erected. Its construction is simple, consisting of a pole supported in an inclined position by two legs or props. It is used for laying sewer



Cast Steel Stiff-Leg Derrick Mast Top with Wrought Iron Timber Straps and Chain Topping-Lift Connection

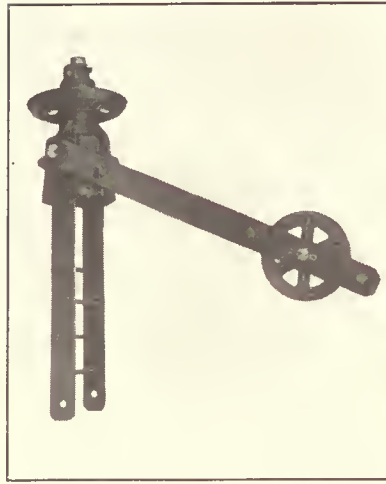

Cast Steel Guy Derrick Mast Top with Wrought Iron Strap Timber and Topping Lift Connections

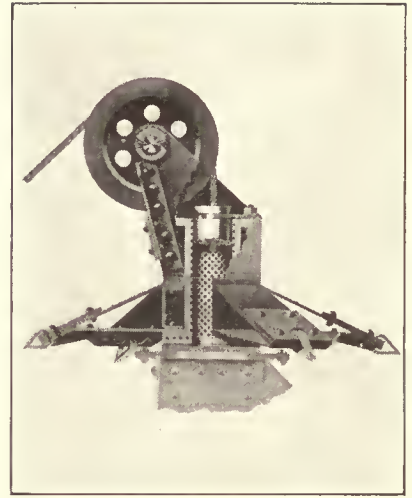

Structural Steel Guy Derrick Mast Top with Single-Sheave Rooster for Three-Line Work



Structural Steel A-Frame Top with Chain Topping-Lift Connection



Structural Steel A-Frame Top with Single-Sheave Rooster and Chain Topping-Lift Connection

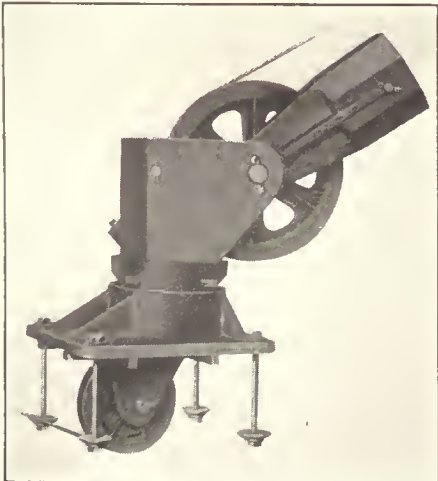

Cast Steel Mast Base and Step with Cast Steel Boom Heel and Sheave

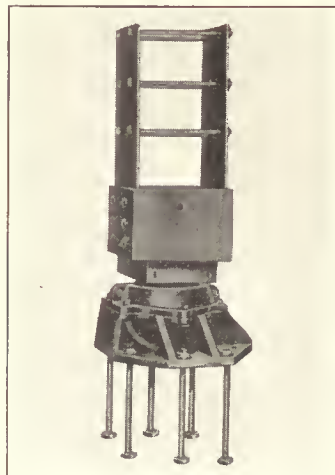

Two-Piece Cast Steel Base with Steel Plate Mast Connection

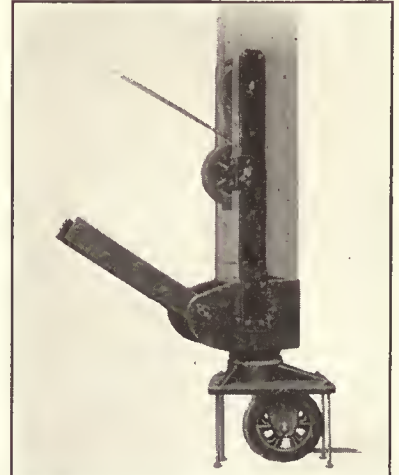

Cast Steel Mast Bottom and Double Step

pipe, setting monuments, digging trenches and work of a similar character.

This derrick has a small winch on the pole and is operated by hand. The height of such derricks ranges from 12 ft. to 14 ft. and in capacities upward to 2 tons.

Sulky Derrick

A light capacity derrick known as the sulky derrick is used in much the same manner as a tripod derrick. Four poles are mounted on two wheels and may be moved from place to place by resting the wheels on the ground and folding the poles on the axle. When erected for use, the poles form a rectangular pyramid secured at the apex by a bolt. A means of suspending tackle is provided and the hoisting line passes from the block to a winch secured to two of the poles near the base. The winch gear meshes with a pinion on the sulky axle and is operated by turning the sulky wheel. Derricks of this type do not require guys and may be set up over a well or at any point where the work to be done may be brought directly under the center of the derrick.

A-Frame Derrick

A small portable A-frame derrick, substantially a type of stiff-leg, is used in building operations for setting girders, timbers and columns, or for other purposes.

A pole or mast is supported in a fixed inclined position by an A-frame and the fall lines are suspended from the top of the mast, which extends beyond the top of the A-frame. The derrick is operated by means of a hand-winch, placed on the inclined pole or mast, and has a capacity up to about 2500 lb.

Such derricks usually are mounted on rollers so that they can be moved readily. They are also mounted on four-wheel trucks and then have a wider range.

Mast and Gaff

The mast-and-gaff rig is a modification of both the guy and the stiff-leg derrick. It includes a mast, a gaff or light boom, usually some type of grab bucket and a hopper or bin into which the material is dumped. It is used chiefly at wharves or in coal yards for handling loose materials. It usually is classed as an unloading machine and is fully described elsewhere in this book.

Sheer-Legs

Sheer-legs are a type of derrick used largely in foreign countries. This machine consists of two legs forming an A and pivoted to a fixed base. The hoisting tackle is suspended from the apex. A single back-leg is pivoted to the top of the A and its base is fitted with either a screw connection or a tackle connection so that it may be moved back and forth in a guide resting on the foundation. A forward or backward movement of the back-leg tilts the sheer-legs and thus gives a limited horizontal movement to the load. A machine of this type is installed on the edge of a wharf so that the fall-line may be dropped into a vessel alongside. It may also be used in other service when the conditions will permit.

Derrick Fittings

Careful attention to the design of derrick fittings is essential in order to secure the greatest strength of the derrick structure without unnecessary weight and to avoid undue strains, particularly at the base of the mast where excessive friction will reduce the speed of operation. The life of the derrick and the efficiency of its operation depend largely on the character of the fittings. All derrick fittings subjected to a tensile stress should be of steel, preferably steel plate or forgings, but they may be of cast steel having

adequate sections to insure the required strength and to eliminate probability of failure under load. Cast iron is sometimes used for base plates, step castings and other parts not subject to severe shock or tensile stress. The lubrication of all bearing surfaces should be provided for.

In the type of construction generally followed the derrick mast is supported in a foot block secured to the bottom of the mast and resting on a base plate. This foot block is provided with a pivot which rests in the mast step. There are various types of mast steps, some having a cylindrical form while others have a ball and socket joint. The mast step and the base plate usually are a single casting and the brackets for the bottom mast sheaves are either cast on or bolted to the base plate. In some cases, particularly when the derrick is not equipped with power slewing apparatus and must be swung by hand, the foot block and mast step are provided with ball bearings.

The boom seat usually is an integral part of the foot block, though a separate boom seat is used on some derricks and is then secured to the mast above the foot block. When the boom seat is designed for use on a derrick having a pivoted mast—as most of them have—it provides only for a hinge to permit the changing of the angle of inclination of the boom. In other cases, as when the derrick has no mast or as in cargo handling gear having a fixed mast, the pivot is integral with the boom seat.

The complete combination of base plate, foot block, mast step, boom seat, and the timber straps, together with any required number of sheaves at the bottom of the mast and the boom, is known as a derrick bottom.

The top of the mast is fitted with irons collectively known as the mast top. These fittings are preferably made of rolled plate or bar steel, but cast steel fittings have now come into general use and, when properly designed, give satisfactory service. An essential feature is that the top shall be so designed that the gudgeon and the pivot at the bottom shall be in the same axis and preferably centrally located on the mast. The mast top is of similar design for either the guy or the stiff-leg type of derrick.

In the guy line type the mast top includes a guy cap which centers on the gudgeon and is provided with holes or eyes to which the guy lines are secured in such a manner as not to interfere with the swiveling movement of the machine. Various designs of guy caps are of cast steel, others are made of steel plates, but all provide a wide bearing surface for the gudgeon to prevent the cutting of the pin as the derrick rotates. The guys are secured directly to the cap or in some designs to thimbles or rope sockets or to shackles secured to the guy cap itself.

In the stiff-leg type of derrick the guy cap is omitted and gooseneck irons having holes to fit over the gudgeon are secured to the upper ends of the stiff-legs and serve to support the mast in an upright position while permitting it to swivel freely. The stiff-legs are secured to sills or other anchorages by means of stiff-leg irons.

The design of the mast top varies somewhat, depending on the use to which the derrick is to be put. Some tops are fitted only with the topping lift connection while others have one or more sheaves so that the various lines may pass through the mast top.

When a derrick is intended for grab bucket operation or for any other service requiring three-line work the derrick top generally is equipped with a rooster which fits over the gudgeon and provides a sheave at the mast top. The rooster bracket is fixed in any desired position by means of a comb on the mast top. Usually the gudgeon is bored so that the line may pass over the sheave and downward through the center of the mast top. If an addi-

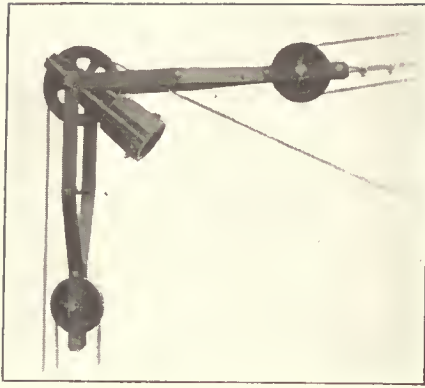

Cast Steel Boom End or Point with Topping-Lift and Fall-Block Sheaves and Strap Connections

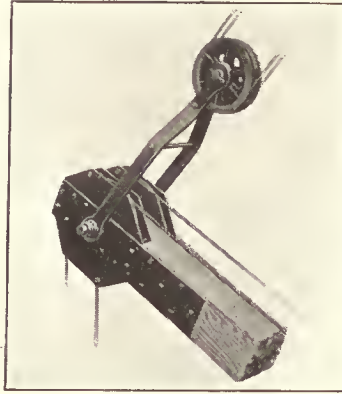

Wrought Iron Plate Boom End with Two Sheaves for Fall Lines and Double Sheave Topping-Lift

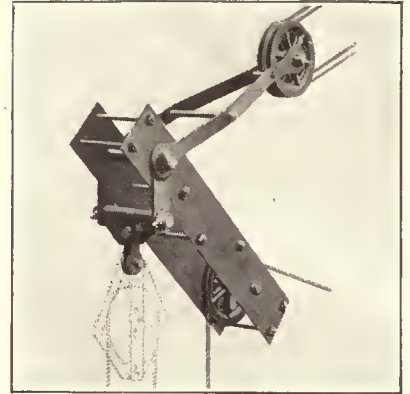

Wrought Iron Boom End with Flexible Fall-Block and Topping-Lift with Fixed Sheave in Boom

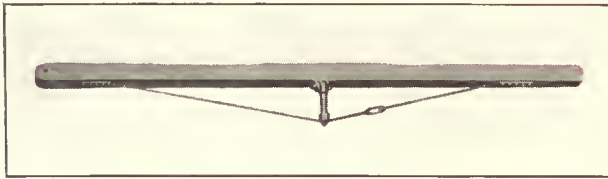

Single-Rod Trussed Boom.

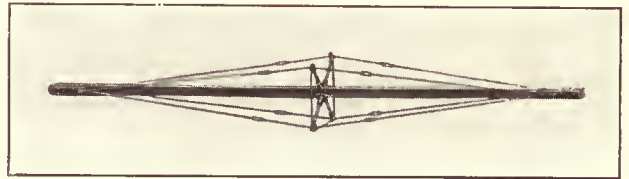

Four-Rod Trussed Boom

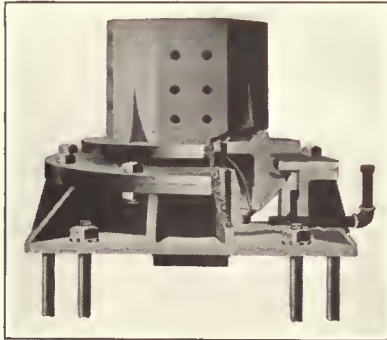

Cast Steel Base with Intermediate Mast Step Casting

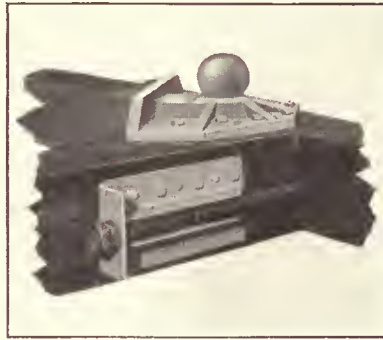

Cast Iron Ball Socket Foot Block or Base

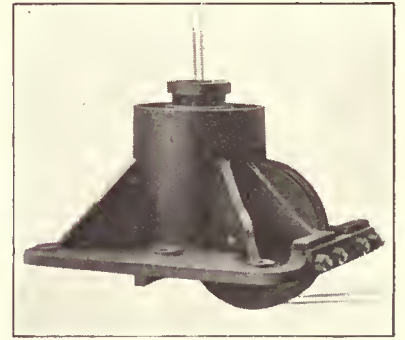

Cast Steel Mast Step and Base with Center Bore and Bottom Sheave

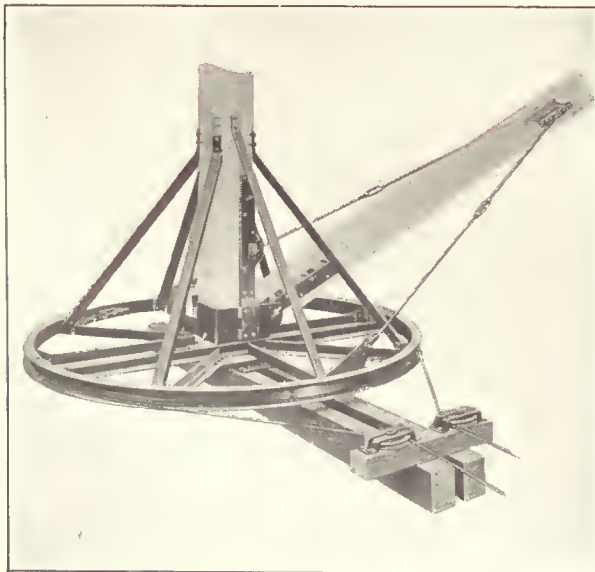

Structural Steel Bull-Wheel Slewing Apparatus with Slewing Lines Rigged

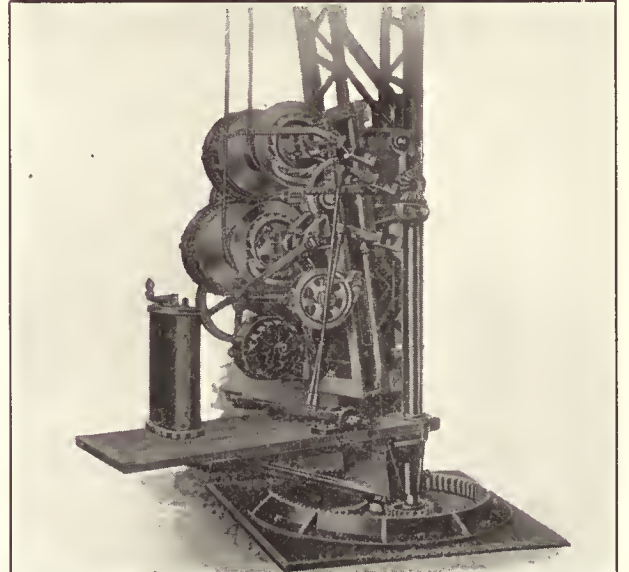

Electrically Operated Hoisting Winch with Self-Slewing Gear for Use on Stationary Derrick

tional sheave is desired, as frequently is the case on barge derricks, the top may be equipped with two roosters.

The boom end, or boom point, fittings vary with the character of the work to be performed. The boom end may be built up of structural steel parts or may consist of a combination of steel castings and plates or straps. The number of sheaves to be provided at the boom end depends on the service desired from the derrick. The sheaves sometimes are set in the end of the boom while other boom ends have sheaves attached by means of bails or links. On derricks of light capacity and on cargo handling gear, boom bands or rings are used, to a large extent, to provide connections for the tackle required.

Tower derricks require a special design of upper and lower post brackets, which serve the same purposes as the mast top and mast bottom in the other types of derricks. These brackets are designed to bolt or clamp on the corner of the tower. They usually are steel castings with iron strap bolts or clamps.

It often is desirable to use comparatively light timbers for derrick booms and, when this is done, the timbers are reinforced by from one to four truss rods. These trussed booms vary in length from 30 ft. to 70 ft., the rods being from $\frac{1}{2}$ in. to $1\frac{1}{8}$ in. in diameter. The use of truss rods permits the use of exceptionally long booms without unnecessary increase in the size of the timbers and consequently the weight of the machine.

Slewing Apparatus

The speed of operation and therefore the volume of work done by a derrick is greatly increased if some method of slewing by power is provided. An efficient means of doing this is the bull-wheel or the self-slewing gear.

The bull-wheel, which is largely used, preferably is constructed entirely of steel so braced and reinforced with channel and angle iron girders and braces that the force applied to the rim of the wheel will be transmitted to the mast and to the boom without excessive strains on the derrick structure or danger of buckle in the wheel rim. The wheel is fastened to the base casting and to the mast itself by braces extending outward to the rim of the wheel and to the boom by slewing rods which are hinged on

brackets secured to the wheel rim. The hinge pins of these brackets and of the derrick boom should be in a common line to insure the easy raising or lowering of the boom. The slewing rods are provided with turnbuckles so that adjustments can be made. The slewing lines pass around the rim of the bull-wheel and over sheaves to a slewing drum on the hoisting apparatus. The bull-wheel gives the operator control of the load and permits the boom to be swung while the load is being raised, thus increasing the speed of operation.

The relation of the diameter of the bull-wheel to the length of the boom, as given in the following table, has been determined by common usage:

BULL-WHEEL SLEWING APPARATUS	
Wheel Diameter, Feet	Boom Length, Feet
8	40
10	50
12	60
14	70
16	80
20	100

Self-slewing gear serves the same purpose as the bull-wheel. It is operated by means of a pinion geared to the hoisting apparatus and meshing with a large ring-gear surrounding the base of the mast. It is used only when the hoisting apparatus, generally including the boiler or other source of power, is mounted on a platform at the base of the mast and revolves with the derrick. All of the machinery being on the opposite side of the mast, it serves as a counterweight to the boom and its load.

The operator is stationed on the platform and has complete control of the derrick and also has an unobstructed view of the work. In permanent installations, the boiler can be dispensed with and steam may be piped from a stationary boiler plant through a line leading up through the mast pivot and thence to the hoisting engine. Electric power may also be used for derricks equipped with self-slewing gear.

Tackle

The tackle used on derricks includes a large variety of blocks, wire rope and special fittings. These are treated in this book in the chapters describing such material.

Cargo Handling Gear

Cargo handling gear aboard ship is a large factor in determining the commercial value of a vessel as the length of a ship's stay in port depends largely upon the efficiency of the loading and unloading facilities.

Vessels regularly engaged in carrying a particular class of cargo, such as coal, ore, grain, or oil, are most economically loaded or unloaded by some special type of machine such as conveyors, elevators, cranes, pumps, etc., installed on the wharves or, in some cases, on the vessels. These special devices are described and illustrated elsewhere in this book. Also in many cases, as on river and harbor steamers, cargo is handled by trucks of either the hand operated or power operated types.

Vessels carrying miscellaneous cargo, however, require handling gear—installed on the vessel—that may be adapted to a wide variety of purposes. To handle general cargo such as boxes, barrels, bales, etc., varying greatly in weight and in size, and frequently of irregular shapes, the derrick type of gear has been found most efficient and practically all cargo vessels are thus equipped. Such derricks are similar in construction to those used on land and they are provided with various forms of slings, hooks, tongs, rope nets,

etc., so that cargo may be hoisted from the hold of a vessel and transferred to a wharf or directly to a conveyance.

Mast or Derrick Post

On cargo handling gear the mast is fixed, instead of being pivoted as on the ordinary type of derrick, and on many small cargo vessels and on auxiliary craft for handling cargo, such as steam lighters, the derrick boom usually is applied directly on the mast. On larger vessels a special derrick post—sometimes called king post—is built up either of steel plating or is constructed of pipe. Sometimes the derrick post is also utilized as a ventilator, the mushroom type of ventilator generally being used, although a cowl fitted to the top of the post is often used. In some designs, a slide is fitted in the post to permit regulation of the ventilation below decks.

Derrick or Boom Tables

A derrick or boom table is used when more than two booms are required on each side of the mast, or when it is desired to set the hoisting winches parallel to the center line of the ship. The width of a derrick table is deter-



Ships Deck at Foot of Mast, Showing Cargo Handling Gear with Two Hoisting Winches and with the Derrick Booms Pivoted to the Mast



Cargo Handling Gear with Derrick Booms Pivoted to Boom Table. Handling Package Cargo with a Sling



Cargo Handling Gear Rigged with Hook for Handling Package Cargo with a Net

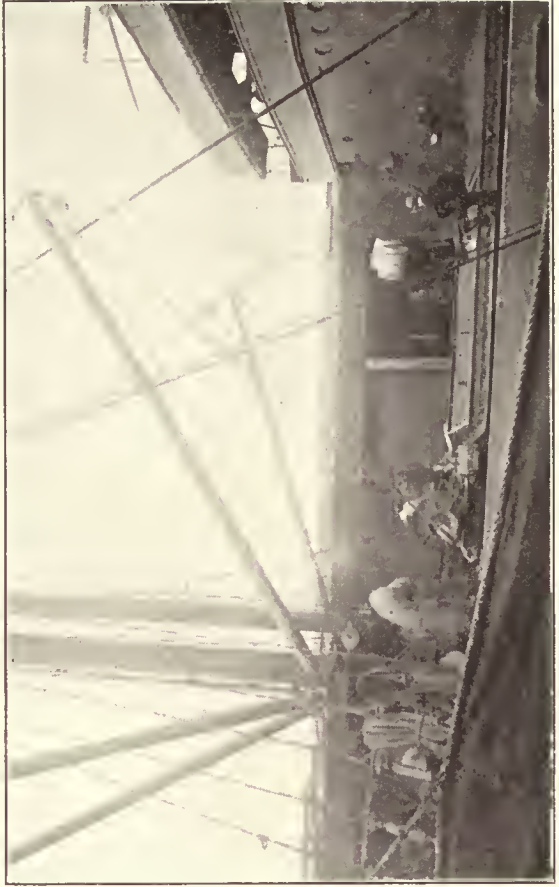

Cargo Handling Gear Rigged to Handle Barrels with a Hook and Sling

mined by the number of booms required. The smaller sizes of boom tables are usually bracketed to the mast but when the space between hatches will permit a wide boom table to be built around the mast it is supported by stanchions, and sometimes is enclosed and used as a deck locker.

An upper table or ontrigger, to which the topping-lifts are connected, must be provided when a derrick table is fitted around the mast at the deck. The connections for the topping-lift blocks should be located directly above the boom pivots on the derrick table. Sometimes the upper table is so constructed as to provide connections for parts of the ship's rigging in addition to the topping-lifts of the cargo handling gear.

Booms and Fittings

Wooden booms—chiefly of Oregon pine—are used for capacities up to about 10 tons, although occasionally they are made of steel. Booms above 15 tons capacity are practically all constructed of steel, the most common type being of pipe construction but the plate and channel type or the lattice type as employed in construction of land derricks is also used to some extent.

On a boom of the circular wooden type the fittings consist of a goose-neck fitted at the heel or foot of the boom, with an eye-bolt near the goose-neck for securing the block bail; at the upper end of the boom are fitted one, two or three bands—the number of bands required for a boom being determined by the class of cargo carried—spaced from six to seven feet apart. The outer band usually is fitted so that it shoulders on a reinforcing band; the inner bands are made in halves, and bear against half rounds secured to the boom.

The boom pivot sometimes is designed with a connection for the lead block. When the boom is stepped on a table a pad-eye, with a link to which to shackle the lead block, is riveted to the table. A heavy lift boom usually is stepped on a pedestal riveted to the deck and a pad-eye for the lead block is secured on the deck. The fittings for the heavy lift boom consist of a goose-neck—sometimes called a Pacific iron—at the lower end; at the upper end there are either bands or pad-eyes, depending on the construction of the boom, to which are connected the vang—lines used aboard ship to control the slewing movements of a boom—the topping-lift, and hoisting blocks.

Winches

One of the most common types of winches for handling the average cargo is the single gear winch with a single hoisting drum and with one winch-head on the outboard side. When there is sufficient deck space winches fitted with two winch-heads are used, as there are some classes of cargo where a number of whips—a term usually applied to light cargo hoisting tackle—can be operated from one hatch, and both the hoisting drum and each of the winch-heads can be used to good advantage. Winches that are used aboard ship for handling very heavy loads and for warping are subjected to severe strains and generally are compound geared.

The location of the winches has an important bearing on the facility with which cargo may be handled. An ar-

range which has been found very efficient for certain classes of cargo, and which has been extensively adopted where two booms are fitted on each side of a mast, is to locate the winches in an athwartship direction with sufficient space between them for an operator at each winch but close enough to permit one man to operate both winches by extending the levers and brakes. Where possible, it is desirable that one man should control both winches.

Usually only one winch is required for each boom, but where a heavy lift boom is used and the ship is not fitted with double-drum winches, the hoisting drums of two single-drum winches are brought into play. With this arrangement one winch is used for the topping-lift and the other for the hoisting line.

Method of Operation

Ships built in the United States generally are fitted with two booms of about 5 tons capacity on the forward and after side of each mast. In some cases large ships have one boom of from 25 tons to 35 tons capacity in addition to the 5-ton booms. When handling cargo with 5-ton booms, one boom usually is guyed down over the center of the hatch, the other being guyed down over the side of the vessel so that the cargo whip or tackle will clear the vessel's side from 8 ft. to 12 ft., depending upon the class of cargo handled. In handling barrels, boxes, or crated goods in light loads up to about 3 tons a single whip is used on each boom. These whips are brought together at the lower end and made fast by connecting them to a ring or a shackle on which is secured a cargo hook, barrel hooks, bale hooks, net or other device most suitable for handling the particular class of cargo.

When discharging cargo a load is lifted from the hold of the vessel by the whip on the boom over the hatch and after it is clear of the hatch coaming, it is swung outboard by hauling in with the whip on the outboard boom and slacking away on the whip on the inboard boom. This operation is reversed when loading the vessel. This system of handling cargo is a very efficient one for certain classes of materials, but sometimes, as when handling a great number of similar pieces, it is advantageous to work the whips independently. In such cases, the load is lifted from the vessel's hold and then hauled outboard by a line made fast to the load as the whip is slacked away. For the heavier loads—from 3 tons to 5 tons—it usually is necessary to substitute a three-part tackle in place of the single whip.

When heavy cargo is to be handled, booms of 25 tons to 35 tons capacity are used. Usually they are stepped on deck and are fitted with an eight-part fall for hoisting and also an eight-part topping-lift. When hoisting a load from the hold the heavy boom is guyed securely over the center of the hatch, by means of vangs on each side of the boom, the load then hoisted until high enough to clear the hatch coaming and the bulwark, and then swung outboard by slacking away on one vang purchase and hauling in on the other with the aid of the winch head. This method gives complete control of the gear and permits the handling of heavy, cumbersome packages without danger to the operator from unexpected slewing of the load.



Railroad-Type Steam Shovel with Side Outriggers in Place



Small Revolving Steam Power Shovel Mounted on a Single Truck Equipped with Creeper Traction

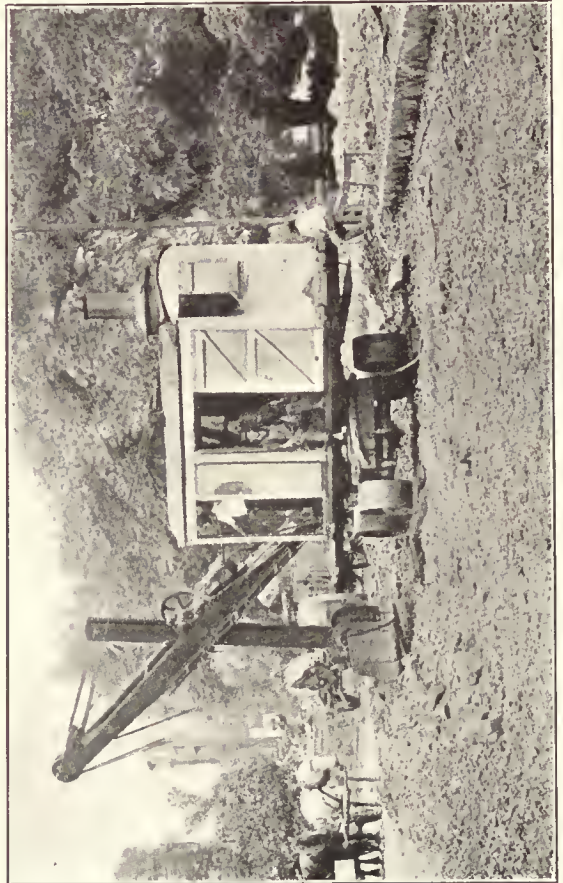

Small Revolving Steam Power Shovel Mounted on Plain Tread Traction Wheels, Shallow Excavation Work in Road Construction



Skid-Derrick Type Steam Power Shovel Equipped with Drag-Scoop, Excavation Work in Marshy Land

Excavating Machines

MANY SPECIAL TYPES of excavating machines have been developed for the digging and disposal of earth, sand, gravel, coal, ore and other materials. The use of these machines has resulted in the more economical operation of many industries such as the open mining of coal and ore, and other minerals; the handling of sand and gravel for commercial use; and the more efficient maintenance of railroads. They have also been extensively adapted to such work as filling along the water front, for levee construction and similar service. In addition to cableways of the excavating type and the various special appliances by means of which locomotive cranes, derricks and other similar machines are adapted to excavation work, there are certain types of machines which are especially suited to a particular class of excavation service on dry land and on water.

Those adapted to land service are: Power shovels equipped with a dipper or shovel for work within a comparatively restricted area; dragline excavators for more extensive operations; and trenching machines for specialized service. They are operated by steam, gasoline, or electric power.

Those types of excavating machines adapted for use on water are: the dipper dredge, similar in design to the land type of power shovel; the elevator or placer dredge, of the endless chain bucket type; and the hydraulic or suction dredge.

Power Shovels

Power shovels are extensively used for general excavation work and also to some extent for loading loose materials. They are adapted to digging such materials as sand, gravel, clay, shale and earth without blasting; or for handling all classes of loose materials such as coal, ore, rock, or other similar material after blasting. They have been applied to such service as stripping overburden and digging ore or coal in open mining operations; for loading stone in quarry work; handling clay at tile and brick plants, for excavating service in railroad work; and for general construction work where excavating and loading of material is necessary. They have also been adapted to dredging service and are used for digging canals; for deepening channels; or for excavation work along shore.

The general form of construction consists of a shovel or dipper fixed to the end of a handle or arm which is supported by an A-frame, a mast, or a pillar similar to the construction employed on a derrick or a locomotive crane. The A-frame rests on a structural frame or car body which may be mounted on standard railroad trucks and travel on standard gage track; may be mounted on rollers or small wheels and travel on a special runway laid on the ground or on top of flat cars; or may be mounted on trucks of the trackless type having wheels with plain tread, tractor tread, or of the creeper traction type. These shovels generally are self-propelled, but they are sometimes mounted on a platform which is moved on rollers when it

is necessary to change the location of the machine. In the case of a dipper dredge the machine generally is mounted on a barge or float, but in some cases it is mounted on a platform which rests on land while the dipper is operated in the water.

Power shovels for dry work are made in several different forms: These are commonly known as the standard railroad type for heavy service; the revolving type for general service; and the ditching machine, generally known as the railroad ditcher.

Railroad Type

The standard railroad type of power shovel—commonly called a steam shovel because of the type of power generally used—is adapted to the most severe service. It is used not only in railroad construction and maintenance service, but also in open mining; quarry work; at cement, tile and brick plants; and for general excavation work in other fields. In this type of machine the shovel or dipper is fixed to the end of a handle or arm and is suspended from the outer end of a boom by means of chains or wire rope passing over sheaves installed on the boom. The other end of the handle passes through guides

located at an intermediate point on the boom. Sometimes this form of construction is reversed and the boom passes between the side members of a double dipper handle. In other cases the end of the handle is hinged to the boom. The heel of the boom is secured to a turntable or swing-circle very similar in construction to the bull-wheel used on many derricks, but generally mounted on roller bearings similar to a turntable. The outer end of the boom generally is supported by rigid guys or rods secured to the top of the A-frame structure, thus keeping the boom at a fixed angle of inclination. In some cases, however, the guys are dispensed with and a topping-lift is used, thus permitting an adjustment of the boom as may be desired to change the radius of action, or the height of dump. The A-frame is held in a rigid position by guy-rods or props secured to the body of the car.

Generally the machine is provided with a dipper hoisting engine, and a swing engine for rotating the swing-circle—both engines being mounted on the car; and with a dipper thrusting engine usually mounted on the boom, but sometimes also being installed on the car. A steam boiler of the locomotive type is mounted on the rear end of the car where it may also serve as a counterweight. The machinery is enclosed within a superstructure similar to a railroad car body and the entire apparatus is carried on two 4-wheel trucks of the standard railroad type. The car is propelled by chain gearing connecting the truck axles with the power plant on the car. Adjustable side outriggers are provided to give stability to the machine. The car on which a railroad type of power shovel is installed generally is equipped with standard automatic couplers and air brakes so that it may be hauled in railroad train.

In the operation of this machine, the shovel or dipper is

Power Shovels: Railroad Type; Revolving Type; Ditching Machine.

Dragline Excavators. Trenching Machine. Back-Filling Machine.

Dredges: Dipper Type; Hydraulic Type; Placer Type.



Large Revolving Steam Power Shovel Stripping Overburden in Open Mining Operations

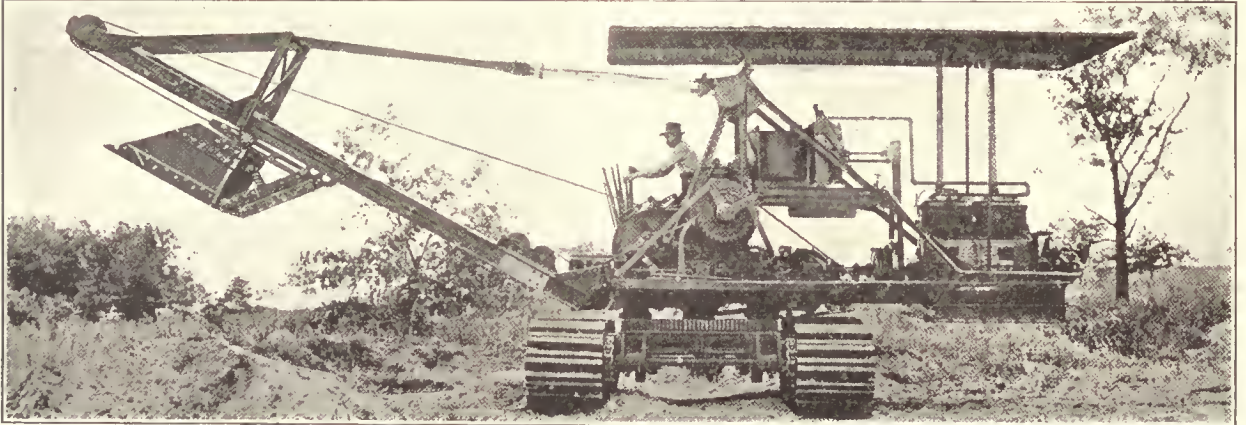

Skimmer Type of Power Shovel as Used in Excavation Work. Gasoline Operation



Skimmer or Coal Loader Working in Conjunction with Large Revolving Steam Power Shovel

lowered to the base level and is thrust into the material by means of a rack gear on the under side of the dipper handle. It is operated by gears propelled by the thrusting engine on the boom and moves the dipper handle through the guides. As the dipper is thrust forward into the material the hoisting engine operates the hoisting chains or rope and raises the dipper in a vertical semi-circle scooping a load as it rises. The boom is then rotated to either side by the swinging engine and the material loaded into a wagon or car by opening the hinged back or bottom of the dipper and dropping the load.

This type of machine may be equipped with a dipper having a capacity ranging upward to about 6 cu. yds.; a radius of action upward to about 35 ft. swinging through an arc ranging upward to about 10 deg. beyond a right angle on either side of the car or a total swing of about 190 to 200 deg., and a dumping height of about 20 ft. above the surface on which the machine rests.

The proportions of some power shovels of the railroad type are given in the following table:

Capacity of Dipper	3½-6 yds.		3½-5 yds.	
	ft.	in.	ft.	in.
Length of Boom	31	6	30	3
Length of Dipper Handle	20	6	19	6
Dumping Radius	32		31	9
Height of Dump	17		18	6
Depth of Cut				
Shovel Track to Leading Track	10		11	6
Depth of Cut Below Rail	6		6	9
Digging Radius at 8 ft. Elevation	33		23	
Radius of Level Floor	19		20	

A modification of the railroad type of power shovel mounted on traction wheels having a very broad tread has been adapted to such classes of service as making narrow cuts; for use in gravel pits; and for quarry work or other operations where a heavy capacity shovel may be desired, but where it is not practicable to lay tracks for the standard railroad type of machine. Except for the type of truck on which the machine is mounted, this type of shovel is constructed in substantially the same manner as the larger railroad type. The radius of action ranges upward to about 20 ft. through arc of about 260 deg., and the height of dump above the base is about 12 ft.

Revolving Type

The revolving type of power shovel performs practically the same class of work as the heavier railroad type, but is designed for lighter service. It also is adapted to other uses such as excavating cellars and trenches where the larger machines could not be economically operated. It embodies many of the features of construction used in the railroad type, but instead of being arranged so that only the boom and dipper rotate, the entire superstructure is mounted on a turntable similar to that used in the construction of a locomotive crane and it may be rotated in a complete circle. This permits the operation of the shovel in any direction within a comparatively small area and it also will perform a maximum amount of work without changing the location of the machine.

In the smaller types of revolving shovels the boom and the dipper handle ordinarily are of a length only sufficient to permit of excavating to the level of the surface on which the machine rests, but in many cases, in order to excavate trenches or pits below the machine level, a very long boom and dipper handle are used.

These machines are mounted on trucks which may have wheels of the trackless type, having a plain broad tread for traveling on a smooth firm surface; with tractor wheels for traveling over rough ground; on trucks of the creeper type

for traveling on soft yielding ground; or they may be mounted on a 4-wheel—sometimes more—self-propelled car traveling on rails. The radius of action ranges upward to about 25 ft., they have a dumping height of about 15 to 20 ft. and a dipper capacity of from ¾ cu. yd. to 6 cu. yds.

Approximate capacities of the small sizes of revolving power shovels are given in the following table:

SMALL REVOLVING POWER SHOVELS						
Capacity of Dipper Cu. Yd.	Length of Boom		Length of Dipper Handle		Digging Radius at 8 Ft. Elevation	
	Ft.	In.	Ft.	In.	Ft.	In.
¾	18	0	11	0	23	6
1	20	0	14	0	27	9
1½	25	0	16	3	32	6

A larger, heavier type of revolving power shovel has been developed for special service such as stripping overburden in open mining operations and for mining the deposits after the overburden has been removed. This type of machine has also been adapted to other service such as digging canals, digging gravel and clay, and in other ex-

RAILROAD TYPE POWER SHOVELS

Capacity of Dipper	3½-4½ yds.		2½-3½ yds.		2½-3 yds.		2½ yds.	
	ft.	in.	ft.	in.	ft.	in.	ft.	in.
Length of Boom	30	3	29	0	27	3	24	3
Length of Dipper Handle	19	6	18	6	16	9	18	4
Dumping Radius	30	3	29	7	26	5	27	7
Height of Dump	18		17		16		16	6
Depth of Cut								
Shovel Track to Leading Track	11		10		9		9	6
Depth of Cut Below Rail	6		6	6	5	9	4	
Digging Radius at 8 ft. Elevation	33	1½	30	10	28	4	26	
Radius of Level Floor	19	6½	18	4	17	3	16	

tensive operations where the amount of work to be done warrants the installation and use of a heavy high capacity machine.

The superstructure of this type of machine is similar to that of the smaller type, but it is mounted on a very large turntable which rests on a structural frame usually carried on four trucks of the railroad type and traveling on a double track. An extremely long boom and dipper handle is provided so that a wide radius of action and a high dumping range may be obtained. The machine may be equipped for self propulsion or may be moved by other motive power. Power shovels of this type have a digging radius of about 100 ft., a dumping radius ranging upward to 90 or 95 ft. and a height of dump of about 60 ft. The proportions of some of the large types of revolving power shovels are given in the following table:

LARGE REVOLVING SHOVELS

Capacity of Dipper Cu. Yd.	Length of Boom		Length of Dipper Handle		Digging Radius at 40 ft. Elevation	
	Ft.	In.	Ft.	In.	Ft.	In.
2½	60		38		78	
3½	75		48		90	
6	80		58		103	

Skimmer Type

The skimmer type of power shovel is constructed in substantially the same manner as other revolving shovels except that, instead of having the dipper or shovel mounted on a hinged or pivoted handle and operating in a vertical semi-circular path, it is provided with a dipper or scoop attached to a frame arranged to travel on the under side of a hinged boom having two side members which form a runway for the dipper frame. This gives the dipper a horizontal thrust which makes the machine especially adapted to excavating or "skimming" thin veins of coal in open mines. It was primarily intended only for coal digging and loading, but it has since been applied in other service such as digging and loading sand and gravel or



Dragline Excavator Mounted on Skids



Large Revolving Dragline Excavator

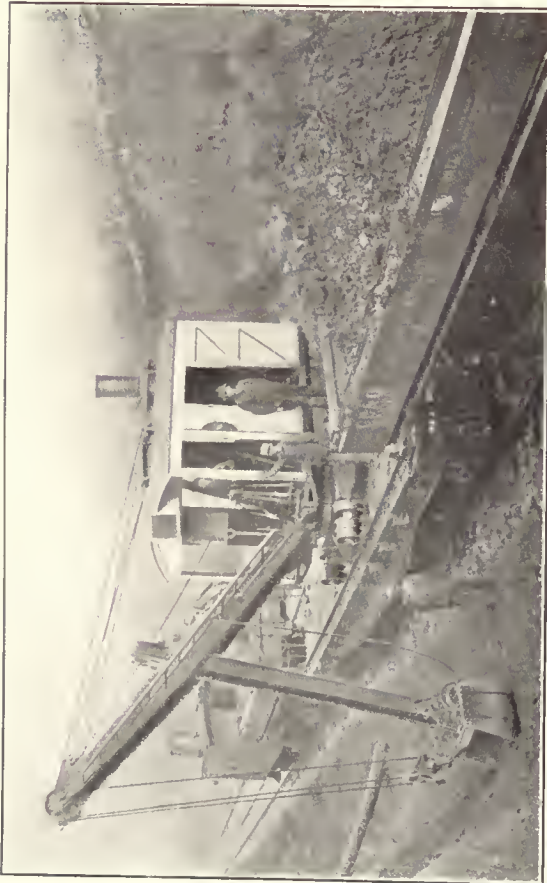

Railroad Ditcher Mounted on Flat Car and Loading to Dump Cars



Small Revolving Dragline Excavator

other similar materials. In the operation of this machine the boom—which is controlled by a topping-lift—is lowered so that the dipper rests on the ground and the thrusting mechanism then forces it into the material. When the dipper is filled—which may be at any point on the outward thrust or line of travel—the boom is hoisted and the travel of the dipper is continued until the desired dumping point is reached. The material is then dumped by tilting the dipper forward by means of a dumping mechanism installed on the boom.

Power shovels of the skimmer type are equipped with dippers having capacities upward to about 1½ to 2 cu. yds.; they have a dipper stroke of from 10 to 12 ft.; booms having a radius of 30 to 35 ft.; a dumping radius of about 30 ft., and a dumping height of about 10 to 12 ft.

Ditching Machine

The ditching machine—commonly called a railroad ditcher—is used chiefly in railroad maintenance work for drainage ditching alongside of the tracks—hence the name “ditcher.” It may also be utilized for other similar work within range of the dipper. This machine is self-propelled and is mounted on a turntable which is carried on a truck having 4 wheels—usually double flanged and of small diameter—generally traveling on tracks laid on the platform of a standard railroad flat car, but laid sometimes on the ground. It differs from the railroad type of power shovel in that its movement is circular—full circle—instead of radial and, except for the manner of mounting, being of substantially the same construction as the revolving type of power shovel.

Two different methods are employed in the operation of the railroad ditcher: a flat car train, or a dump car train. When using a flat car train the ditcher travels from car to car over portable sectional tracks which it transfers ahead after passing over them. As it progresses it loads the material on the cars behind it. The train is then hauled to the dumping ground and the material unloaded with an unloader plow or by manual labor with hand shovels. In the dump-car method, which to a large extent, has superseded the flat car, two dump cars are used and the ditcher is mounted on a flat car between them. The rapidity with which the load may be dumped makes this method particularly desirable.

The following table gives the approximate scope of railroad ditchers:

DITCHING MACHINE

	Ft. In.		Ft. In.	
Radius of cut at grade.....	15	6	18	0
Radius of cut at 8 ft. elevation.....	23	6	28	0
Radius of dump from pivotal center.....	22	0	26	6
Radius of boom from pivotal center.....	18	4	22	¼
Depth of cut below top of rail.....	3	0	3	0
Height of dump above top of rail.....	10	0	11	0

Dragline Excavator

The dragline excavator is used for digging and loading such materials as sand, gravel, clay, earth, coal or ore and may be used in mining operations, canal and drainage work, or for handling any class of loose materials. The superstructure combines many of the features of power shovel and locomotive crane construction. It consists of the usual platform or base, carrying the operating mechanism and power plant and mounted on a turntable; a long boom controlled by a topping-lift, and a dragline or scraper type of bucket. Generally the turntable is of very large diameter and is carried on four trucks—either 2-wheel or 4-wheel type—traveling on a single track of very broad gage

or on double tracks. In some cases the trucks are dispensed with and the turntable base is mounted on skids and rollers and is moved as required. The bucket is of the dragline type described elsewhere in this book.

In the operation of this type of machine the bucket is first raised from the ground by the hoisting line attached to the bucket bail and then lowered to the desired point of excavation. The dragline, attached to the bucket bridle-chain, is then brought into action and drags the bucket through the material, filling as it goes. The hoisting line is then hauled in and raises the loaded bucket which is then carried to the desired dumping point by raising the boom, with the topping-lift, and rotating the entire machine.

Dragline excavators are equipped with booms ranging in length upward to 150 to 155 ft. This gives a very wide radius of action, but additional area may be served by raising the bucket on the hoisting line and then by manipulating the dragline, the hoisting line, and the boom, swinging the bucket outward a considerable distance—ranging upward to from 30 to 40 ft.—beyond the end of the boom. This method is an advantage in certain classes of work as the excavator may be installed well back from the edge of a body of water or an embankment thus avoiding the danger of causing slides, but at the same time it permits the machine to serve a comparatively wide area.

This type of machine—generally those of light capacity—is also sometimes mounted on trucks having wheels with plain tread, traction tread, or the creeper type. This permits a more varied application of the dragline machine to general excavation service.

Dragline excavators mounted on the various forms of trucks or skids range in capacities approximately as given in the following table:

DRAGLINE EXCAVATORS

Capacity of Bucket Cu. Yd.	Length of Boom Ft.	Radius of Boom		Digging Reach		Dumping Reach		Dumping Height		Digging Depth Side Cut		Digging Depth End Cut	
		F.	In.	Ft.	In.	Ft.	In.	Ft.	In.	Ft.	In.	Ft.	In.
¾	40	41	10	41	8	42	8	12	0	12 to 14	18	0	
		36	2	36	0	37	0	20	10	11 to 13	16	0	
1½	45	49	6	43	6	48	6	15	6	15 to 18	20	0	
		42	11	37	6	40	6	25	6		13	0	
2	60	67	2	61	8	65	9	18	6	20 to 25	32	0	
		58	6	53	0	58	0	31	0		20	0	
2½	85	92	0	87	9	92	2	26	6	30 to 35	58	0	
		79	11	75	9	80	0	45	4		40	0	
3½	100	107	4	103	0	107	6	28	8	35 to 40	58	0	
		93	5	89	0	93	7	50	10		36	0	
4	125	130	2	125	3	129	9	40	4	45 to 50	69	0	
		113	0	109	0	113	8	67	4		43	0	
5	155	165	0	195	0	164	0	39	0	50 to 55	75	0	
		153	0	185	0	152	0	71	10		43	0	

Trenching Machine

The trenching machine, as its name implies, is designed to excavate trenches for sewer work, water systems, gas mains and other similar purposes. The rapidity with which this type of machine excavates and disposes of earth and rocks makes it an especially desirable apparatus where the amount of work to be done or where the speed of operation required, as in street work where trenches must be closed quickly, will warrant its use.

This class of excavator is made in two different types: the endless-chain bucket elevator or ladder type, and the wheel type. Both types of machines are mounted on trucks having the front wheels, or the entire truck, equipped with broad treads of the creeper-traction type. The machine straddles the trench, the entire apparatus moving for-

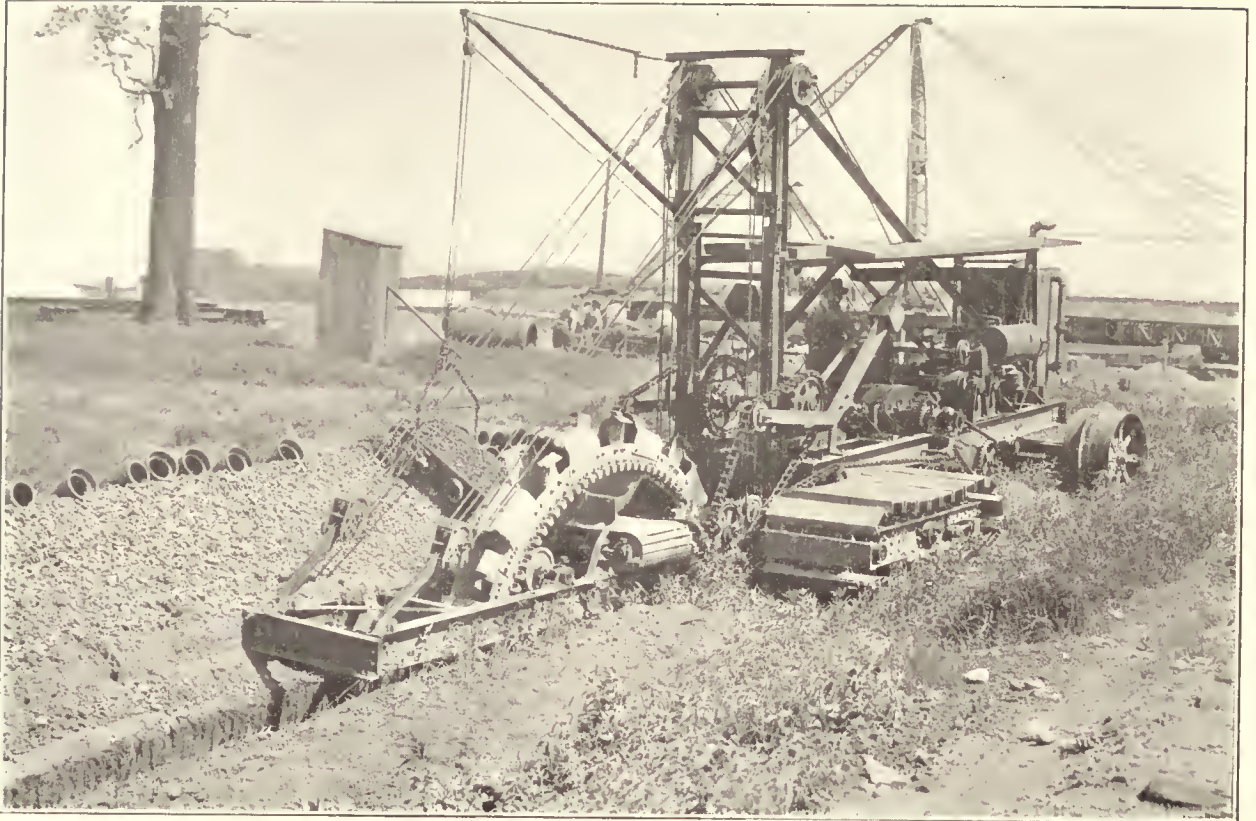

Wheel Type Trenching Machine with Topping-Lift and Disposal Conveyor Gaff-Rig



Endless-Chain Bucket Type Trenching Machine with Ladder Racking Gear

ward as the material is excavated. They are self-propelled, either gasoline or steam power being used.

Endless-Chain Bucket Type

The endless-chain type of trenching machine consists of a continuous-elevator type of digging conveyor hinged to the machine frame and equipped with a number of buckets each provided with a cutting edge or teeth, and a disposal conveyor.

In the operation of this apparatus the buckets are forced into the earth, filling as they advance. As the endless elevator apparatus revolves it carries the material upward to the disposal conveyor which extends to one side of the machine and deposits the material alongside of the trench convenient for refilling or loads it into a wagon for removal. This type of trenching machine has an approximate capacity as given in the following table:

ENDLESS-CHAIN BUCKET TRENCHING MACHINE

Width of buckets.....	72 in.	60 in.	48 in.	36 in.	24 in.
Digging Depth					17 ft.
Road speed					$\frac{3}{4}$ mile per hour
Digging speed			20 ft. to		275 ft. per hour

In the most commonly used bucket type of trench excavator the bucket travel is in a fixed line but in some machines designed for wide trench work the digging apparatus is arranged to oscillate between the side members of the elevator frame. This permits the use of a comparatively narrow bucket for digging a wide trench, but avoids the excessive stress that would be imposed on the structure by using an extremely wide bucket, such as would be required in sewer work.

Wheel Type

The wheel type of trenching machine is equipped with a digging wheel instead of the endless elevator apparatus. This wheel consists of a large internal gear and pinion mounted in a hinged-frame boom which is supported by a topping-lift so that it may be raised or lowered as desired. It is provided with a series of digging blades which are forced into the earth as the wheel revolves and carry the material around the periphery of the wheel until it reaches the disposal conveyor. This conveyor passes inside of the digging wheel, at right angles to the trench, the outer end of the conveyor being suspended from a small boom or gaff supported by the boom topping-lift frame. The material is deposited alongside the trench for refilling or removal.

Back-Filler

The back-filler or filling machine is used for filling in trenches or other narrow excavations being especially adapted for following behind a trench excavator and filling in a pipe trench after the pipe has been laid. This type of apparatus consists of a scoop or scraper which is dragged through the material by a dragline attached to the front of the scraper and to a winch mounted on a machine very similar in construction to a small dragline excavator. In some cases a back-filling scraper is attached to the line of a small locomotive crane of the trackless type which then serves for back-filling purposes.

One design of back-filler has a light trussed-boom about 30 feet long which is supported by an A-frame structure carried on a small truck on which are also mounted a winch and a gasoline engine. The truck may have complete creeper traction; or two wheels having plain traction tread and the other wheels equipped with creeper traction. In the operation of this machine the scraper is hauled beyond

the material from the ground by a line attached to the rear of it and passing through a sheave at the boom end, and thence to the winch. It is then swung or cast and dropped by slacking off on the line. The dragline attached to the front of the scraper is then brought into operation and the material drawn forward into the excavation. The scraper is provided with handles so that a man may follow behind to guide it if necessary.

In a smaller type of back-filler the boom is dispensed with and the scraper is hauled behind the material by manual labor. The dragline is then brought into action and the material drawn into the excavation.

Dredges

Dredges are used for excavating work such as drainage ditching in marshy land, canal work, opening up and deepening channels in rivers, mining operations, and for excavating and filling work in embankment or levee construction. They are made in the dipper or shovel type similar to the land type of power shovel—dipper dredge, the elevator or ladder type—commonly called placer dredge, and the hydraulic or suction type. Many floating derricks and cranes are sometimes equipped with some form of excavating device such as an automatic grab bucket or a dragline bucket and are used for dredging service. These machines, however, do not come within the class of equipment commonly known as dredges.

Dipper Dredge

The dipper dredge is extensively used because of its adaptability to a varied class of work. It is especially suitable for ditching work or other excavation service in marsh land or in shallow water. It is constructed and operated in the same general way as the railroad type of power shovel, but is provided with a much longer boom and dipper handle so that it may excavate below the surface of the water and also have a comparatively wide dumping range. Generally the machine is mounted on a hull or float and rests in the water, but in some instances it is mounted on a platform carried on wheels or rollers running on tracks laid on land.

In drainage ditching where there is sufficient width of excavation and sufficient water to permit the use of the floating dredge, the machine works with the dipper forward and progresses as the ditch is dug. In order to give stability to the machine when working toward either side the hull is provided with spuds which serve the same purpose as the outriggers used on locomotive cranes and other machines operated on land. These spuds are made in two forms: bank spuds, and vertical spuds. They may be manipulated by a friction hoist on the engine which operates the dredging machine but in some cases an independent spud engine is provided.

The bank spud consists of a lie-leg and a stiff-leg similar to the construction used on small stiff-leg derricks, but arranged so that they will telescope and may be drawn in on the float when not in use. The lie-leg extends from the side of the float and rests on the bank of the ditch while the stiff-leg extends from the outer end of the lie-leg to the top of the A-frame supporting the boom. It thus prevents listing of the hull to either side.

Vertical spuds are used when the width of the ditch or canal will not permit the use of lie-legs or when the dredge is being operated on a river or other wide body of water. They consist of upright legs, at each side of the A-frame on the edge of the float, which are provided with



Endless-Chain Bucket Type Trenching Machine with Topping-Lift. Bucket Equipped with Side Cutters



Boom Type Back-Filler Equipped with Complete Creeper Traction



Boom Type Back-Filler Equipped with Plain and Creeper Traction



Boom Dredge—Barge Derrick—Equipped with Bull-Wheel and Automatic Grab Bucket



Dipper Dredge with Pile-Driver Derrick Installed on Opposite End of Hull

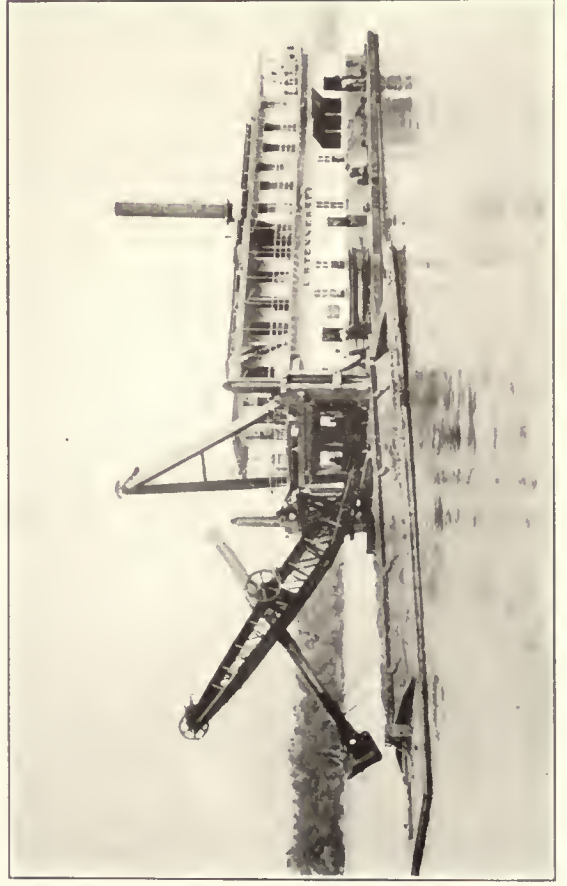

Dipper Dredge with Vertical Spuds, Scow Alongside for Temporary Disposal of Material



Hydraulic Dredge with Suction Apparatus Raised Showing Cutter-Head



Hydraulic Dredge with Vertical Spuds. Disposal Pipe Line Laid for Filling Behind Bulkhead



Two Placer Dredges at Work. Elevator or Dredging End Shown at Right, Disposal End at Left

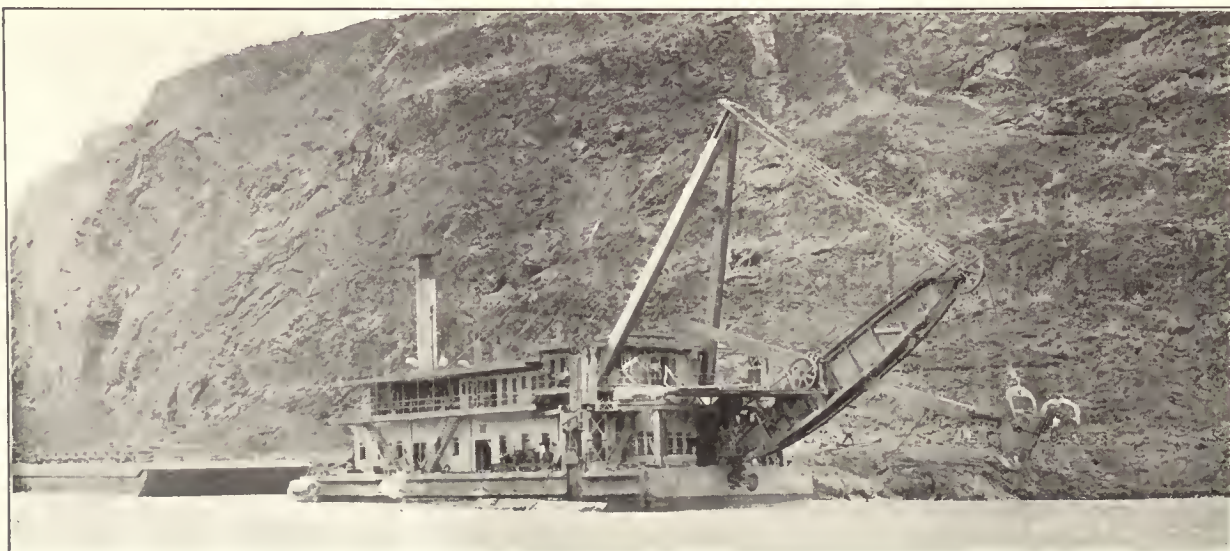

Dipper Dredge with Vertical Spuds Lowered in Position

a broad, flat base and arranged so that they may be extended downward to rest on the bottom and then rigidly secured to the float. This prevents the listing of the float when the dredge is raising a heavy load.

When dredging where the water is too shallow or the ditch too narrow to float the hull, the dredge is mounted on a platform carried on rollers, or on a framework which straddles the excavation and is carried on wheels traveling on rails laid on the banks of the ditch. The material is deposited at either side.

A dipper dredge is generally applied to service where the range of the dipper will permit the dumping of the material on either side of the excavation, but in digging very wide ditches or in dredging streams, where this cannot be done, it is customary to first work along one bank and then the other. This method, however, cannot be used when the area is more than twice the range of the dredge and in such cases, some other type of excavating machine should be used or a barge or scow provided to carry the material excavated. Dipper dredges range in capacities as given in the following table:

Capacity of Dipper Cu. Yd.	Length of Boom Ft.	Length of Dipper Handle Ft.	Depth Dig Below Water Ft.	Height of Dump Ft.	Dumping Reach Ft.
1	30	24	11	9 -12	29-34
	45	33	15½	16½-19½	41-49
1½	40	30	14	13½-16½	37-44
	55	39	18½	21 -24	50-60
2	50	37	17½	18½-22	45-55
	65	46	22	26 -29½	59-71
2½	60	43	20½	23 -26½	54-66
	75	52	25	30½-34½	67-80
3	70	50	24	28 -32	63-77
	85	59	28½	34½-39½	76-94
4	75	53	25½	29½-34	68-83
	90	62	30	37 -41½	81-99
5	85	59	28½	34 -38½	76-94
	100	68	33	41½-46	89-109

Placer Dredge

The placer dredge—so-called, because of its application to placer mining—is a special type of excavating machine. It is used in the mining of gold, platinum, tin, or any other deposits which may be mined by the placer method. This type of machine consists of an elevator-conveyor equipped with digging buckets and carried on a boom structure hinged to one end of the hull, a washing apparatus installed within the dredge superstructure, and a refuse disposal apparatus of the conveyor type.

In the operation of the placer dredge the boom is lowered into the water so that the elevator buckets come in contact with the bottom. The deposits are thus excavated and carried up inside of the machine to the washing apparatus where the sand and other refuse is separated from the minerals and is carried away by the refuse conveyor and

dumped behind the dredge as it progresses. The dumping apparatus may be arranged to carry the refuse to either side if desired. The approximate capacities of placer dredges is given in the following table:

Capacity of Bucket Cu. Yd.	Depth of Dig Below Water Ft.	Height of Bank Above Water Ft.	Capacity per Month Cu. Yd.
3½	15	5	40,000
	to	to	to
	40	15	60,000
5½	20	5	80,000
	to	to	to
	40	15	100,000
7½	25	7½	100,000
	to	to	to
	60	20	150,000
10½	30	10	150,000
	to	to	to
	60	20	200,000
17½	30	10	295,000
	to	to	to
	80	20	368,000

Hydraulic Dredge

Hydraulic or suction dredges are used for deepening channels, for excavating sand and gravel for commercial use, for levee construction, and for excavating from under water and filling low land in reclamation work. This type of machine consists of a suction apparatus which is carried on a boom type of structure and may be lowered into the water, a suction pump, a force pump, and a disposal pipeline which may be of any desired length. The lower end of the suction apparatus is provided with a revolving cutter-head which loosens the material so that it may be readily drawn into the suction line and pass through the suction pump.

In the operation of the dredge the suction apparatus is lowered to the bottom, the cutter-head rotated and the suction pump then draws the material upward through the intake pipe. It is then pumped through the disposal pipe to the outlet where it is discharged. By this method of dredging the material may be excavated from under water and may be conveyed to any desired point. The impact of the wet material as it is discharged from the disposal pipe, makes a solid compact fill which is especially desirable for embankment construction or where it is desired to erect buildings on the filled area.

The hydraulic dredge will handle any class of material ranging from sand or gravel to blasted rock which does not exceed the size of the suction pump intake. Hydraulic dredges range in capacity upward to 300 to 350 cu. yd. per hour and may be extended for a distance of several miles by using booster pumps at intervals on the line thus making the scope of the machine practically unlimited.



Suspension Cableway Dredging Sand from the Bed of a River and Delivering to a Bin for Drying



Head Tower and Sand Bin



Head Tower with Projecting Boom



Suspension Cableway with Projecting Boom on Head Tower for Unloading Loose Materials from Boats

Cableways

CABLEWAYS ARE USED in many fields of industry. They are especially adapted for operations extending over a considerable area or over rough or difficult ground, such as a ravine, a river, or a marsh which could not readily be served by a derrick, a crane, or other machine of more limited scope. The method of construction and operation permits the use of a cableway where other modes of transport are not feasible because of the topography of the locality. In mountainous or marshy land, or over rivers, they are particularly desirable because of the ease with which they may be erected and because of the comparatively small cost of operation. They may be equipped for digging and handling sand or gravel; excavating and filling; stripping overburden in open coal or ore mining operations; dredging in rivers or marshland; handling materials at cement works; handling coal or ore in storage, or for transporting such materials; hauling and loading logs in lumber operations; and in the construction of bridges, dams, and similar work. When used for excavation work they may be operated with equal facility on dry land or with the material handling device—usually a bucket—operated under water.

Cableways may be of the suspension cable type with some means of raising and lowering the material handling devices; they may be of the dragline type in which the handling devices are attached to a load cable and are dragged through the material; or they may consist of a series of cable spans supported at intervals by trestles or towers in which case they are called cable tramways. They are operated by a winch having one, two, or more, drums as may be required for the class of work and the operation of the material handling devices. Steam or gasoline power is widely used, but electric power may be used when available.

Suspension Cableways

Suspension cableways are made in two different types: the inclined or semi-gravity cableway, in which the operation in one direction is by force of gravity; and the horizontal cableway, in which the operation in both directions is entirely by power. They may be of the endless-rope type in which the carriage or trolley travels on a fixed track cable and the traction is supplied by an endless-rope secured to the cable carriage; or they may be of the slack track cable and load cable type in which the carriage and the material handling device is hauled by the load cable. A mast or a tower usually supports one end of the cable span while the other end is either supported by a tail-tower or is secured to some form of sheave or tackle connection anchored in the earth. The head tower—also the tail tower, if desired—may be mounted on wheels or rollers running on rails so that the range of action may be shifted to serve a new area when required.

Either type may be equipped to handle some form of bucket—usually of the dragline type although the turn-over type or the grab bucket type is frequently used; or they may

be equipped with a fall-block and hook to handle a skip, a sling, or various types of tongs or grapples.

Endless-Rope Semi-Gravity Cableway

In the inclined or semi-gravity type of endless-rope cableway, a head tower or mast is installed at a convenient point on high ground so that there will be sufficient incline to the cableway to insure the travel of the carriage in one direction without the use of power.

The main cable, or standing rope, is stretched from the top of the head tower to the opposite side of the span and is anchored at a point low enough to produce the inclination necessary to run the carriage down by force of gravity. The cable passes over a sheave or a saddle at the top of the tower, the latter, being preferable in order to eliminate the damage to the cable resulting from the vibration of the rope when the cableway is in operation.

The hoisting rope is secured to the drum of a winch, passes over a sheave at the top of the mast and is received through a sheave on one end of the carriage, then through the fall-block, thence through a sheave on the other end of the carriage; the end of the rope

is then secured to the fall-block.

The endless-rope by means of which the carriage and the load is hauled along the track cable makes several turns on an endless-rope wheel to prevent it from slipping and both ends are passed over sheaves at the top of the tower or mast. One end of the rope is secured to the front of the cable carriage, and the other end passes through the carriage, around a return sheave secured to the main or track cable at the opposite end of the cable span and is fastened to the rear end of the carriage.

Both the hoisting rope and the endless-rope pass through and are supported by rope trolleys which travel on the track cable. These trolleys are connected to each other by a chain which holds them spaced at regular intervals as the carriage runs down the incline and hangs in festoons as the trolleys are drawn together when the load is hauled up the track cable by the hoisting line. This chain may be fastened to the cable carriage and be drawn down the incline with it or it may simply connect the rope trolleys.

The endless-rope wheel is secured near the base of the mast and is provided with a hand brake by which the carriage may be held securely at any point on the track cable. This brake is supplemented by a gate, consisting of two pieces of timber pivoted at the top of the mast so that they may be dropped over the carriage to relieve the strain on the endless-rope.

In the operation of this type of cableway the fall-block is hoisted to the carriage, the gate raised, the endless-rope wheel brake released, and the hoisting drum thrown out of gear permitting the carriage to descend the inclined cable by the force of its own gravity, pulling the hoisting rope, after it as it uncoils from the drum. The rope trolleys follow the carriage, also by gravity, supporting the endless-rope and

Cableways: Endless-Rope; Inclined Dragline Scraper; Power Scraper; Cable Drag Scraper; Rocking Cableway; Single-Rope Cableway.

Tramways: Friction-Grip; Two-Bucket; Single-Bucket; Double Cable; Stacking; Suspended-Rail.

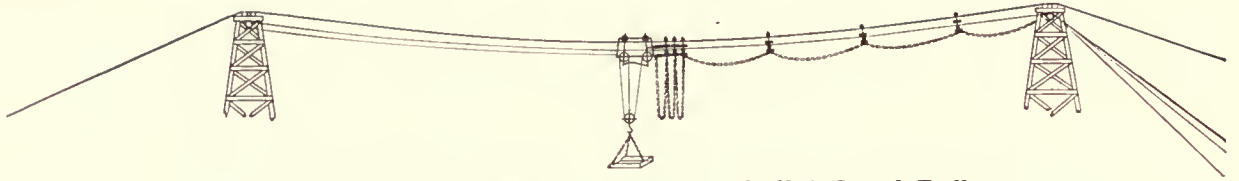

Horizontal Endless-Rope Cableway Equipped with Chain-Spaced Trolleys

List of Parts

- | | | | |
|----------------------|------------------------|-----------------------------|-------------------|
| A Mast | E Hoisting Rope | h Endless-Rope Sheaves | L Trolley Chain |
| a Cable Saddle | c Hoisting Rope Sheave | I Return Sheave | M Fall Block |
| B Main Cable | F Hoisting Winch | J Endless-Rope Sheave Wheel | N Chain Grab-Hook |
| C Main Cable Tension | G Carriage | K Trolley | O Carriage Gate |
| D Cable Anchorage | H Endless-Rope | | |

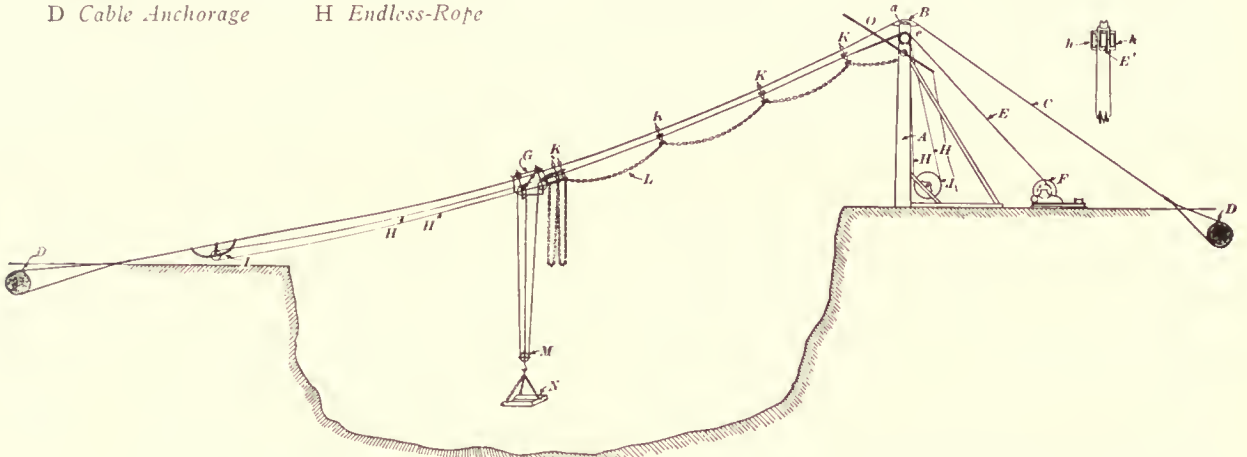

Inclined or Semi-Gravity Endless-Rope Cableway Equipped with Chain-Spaced Trolleys

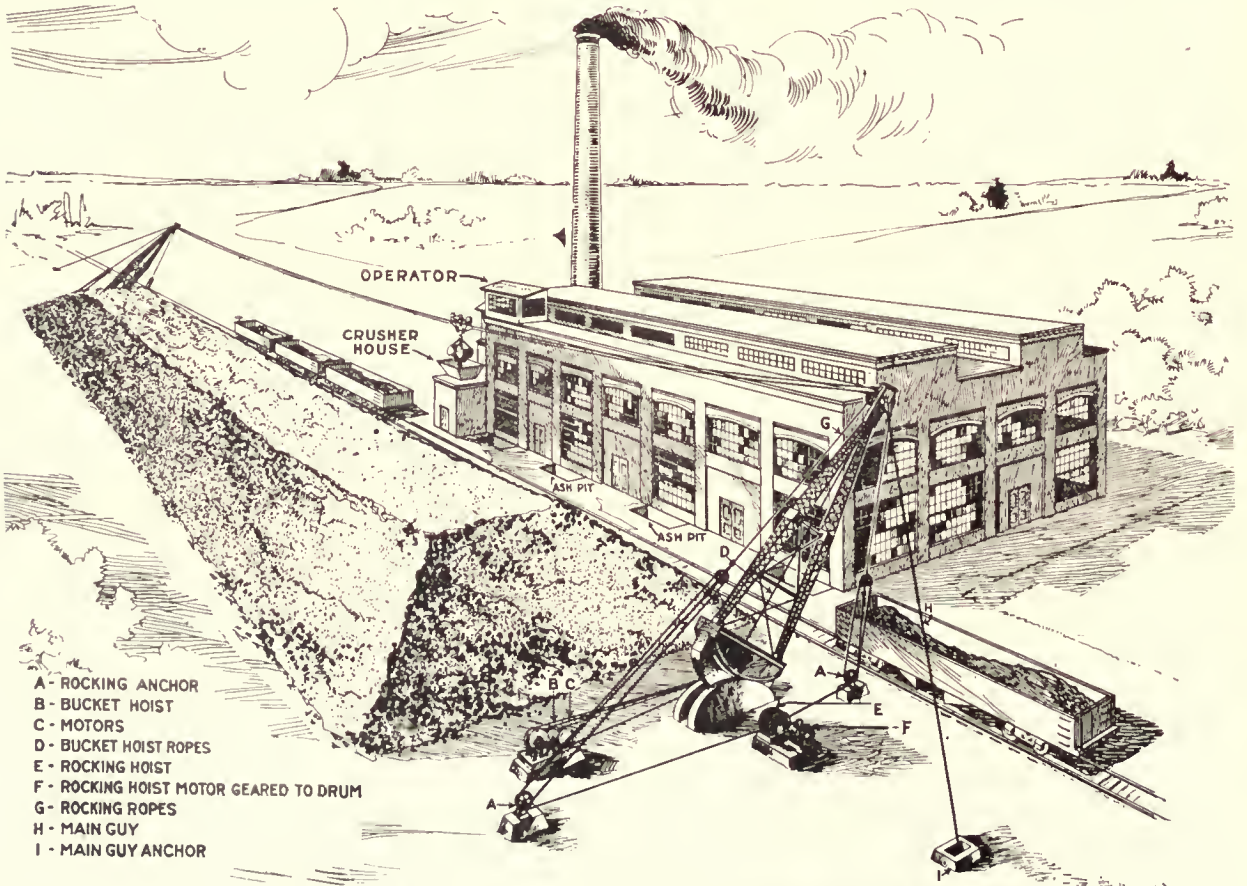

- A - ROCKING ANCHOR
- B - BUCKET HOIST
- C - MOTORS
- D - BUCKET HOIST ROPES
- E - ROCKING HOIST
- F - ROCKING HOIST MOTOR GEARED TO DRUM
- G - ROCKING ROPES
- H - MAIN GUY
- I - MAIN GUY ANCHOR

Rocking Cableway Installed at Power House for Handling Fuel and Ashes

the hoisting rope thus preventing excessive sagging of these lines.

When the carriage reaches the point where it is desired to lower the fall-block, the endless-rope brake is applied and holds the carriage stationary. The fall-block by its own weight lowers as the hoisting rope uncoils from the drum and when it reaches the ground the brake is applied to the hoisting drum to prevent further uncoiling of the rope. When a load has been attached to the hook of the fall-block, it is hoisted until the fall-block is drawn up against the carriage and the endless-rope brake is then released. By continuing the pull on the hoisting rope the carriage with its load and the rope trolleys are pulled up the incline until the carriage reaches the place of landing. The gate is then dropped over it and holds it until the load has been lowered and discharged.

Cableways of this type are made with a span ranging upward to 1,200 ft. or more, and an individual load capacity up to about 15 tons.

Horizontal Endless-Rope Cableway

The horizontal endless-rope cableway is an improvement on the inclined or semi-gravity type and makes possible the application of such cableways in a more general way, not being restricted by topographical conditions as is the case with inclined cableways. The term "horizontal" does not mean that the cable is held in a level position or is suspended from supports having the same elevation but is used to denote the method of operation.

The operation of the horizontal cableway is similar to that of the inclined or semi-gravity type except that the endless-rope wheel used in the inclined type is omitted and the endless-rope is secured to the drum of a winch. The inclined system is operated with a single-drum winch and consequently its movement in one direction is limited to gravity while the horizontal cableway requires a double-drum winch, is reversible, and has no restrictions except the length of the span. It may be operated with the track cable at any inclination and either from the low or the high point. If possible, however, the operating machinery should be placed on the higher elevation as this will insure the most satisfactory results. The endless or traction rope being attached to one of the drums of the winch the operator has complete control of the movements of the carriage on the cable.

The ropes on this type of cableway may be supported by chain connected rope trolleys, similar to those used on the endless-rope inclined cableway, or they may be carried on fall rope carriers which perform the same service as the chain connected type. When not in use these carriers are supported on a self-adjustable carrier horn pivoted to the cable carriage or trolley and riding on a wheel running on the main or track cable. A series of tapered buttons or sleeves is secured to a small carrier cable placed above the main cable; these buttons each successively engage a hinged eye on the carrier, stopping their travel and picking them off the carrier horn. This is repeated at each of the buttons until all of the carriers are distributed along the cable at regular intervals, thus supporting the ropes. On the return travel of the cable carriage the carrier horn picks up each of the carriers as the ropes are hauled in by the winch.

The horizontal type of endless-rope cableway is made with spans ranging upward to 2,500 ft. and has an individual load capacity up to about 20 tons.

Typical Installations

A typical installation of the horizontal cableway is in use at the mine of a coal company where it is used to transport coal across a river—a cable span of 2,200 ft. being re-

quired—to a paper mill on the opposite shore and to carry other material back to the mine. All of the coal used by the mill and many of the materials used at the mine were formerly carried several miles over a roundabout route.

The head-tower or operating end of this cableway is located on the side of the river close to the mine; the tail-tower on the opposite side near the paper mill. The main or track cable, is 2,500 ft. long, the hoisting rope 2,500 ft. long, and the endless or traction cable is 4,500 ft. long. The clear span between the towers is 2,180 ft., the head-tower being 80 ft. high and the tail-tower 100 ft. high with favorable land elevations on both sides of the river. The anchorage for the main cable consists of logs 24 ft. long and about 26 in. in diameter, buried in the ground to a depth of about 5 ft. and weighted down with stone sufficiently to resist the pull of the cable and the load. The cable also spans railroad tracks and to prevent the skip striking passing trains while in transit or in case of the breaking of the main cable, a safety bridge built of structural steel was provided at that point. Wire rope nettings are frequently used for this purpose, and are preferable because of their lighter weight. The chain-connected rope-trolley system is used on this cableway and the trolleys are spaced about 40 ft. apart. Because of the extreme length of the span and the consequent deflection in the cables it was necessary to put one set of rope trolleys in front and another set in the rear of the carriage.

The load is carried in a skip and varies from 2½ tons to 3 tons of coal, while the skip itself and the other parts weigh about 4 tons more, but this weight is distributed over a considerable portion of the cable. This cableway is operated by steam power and has an average daily carrying capacity of about 100 tons of coal.

Another cableway of this type erected at a cement mill has a 1,200 ft. clear span between the towers, which are stationary and were built 160 ft. high for the purpose of creating a large storage area for the cement clinkers. Towers of this height with the 1,200 ft. span give a storage area approximately 200 ft. wide, 1,200 ft. long and 100 ft. high, or a storage capacity of about 1,000,000 barrels of clinkers.

The clinkers are handled with steel skips of 25 barrels capacity which are filled from chutes under the coolers and conveyed by the cableway to the clinker storage. Openings are provided in the bottom of the storage bins through which the clinkers are dropped on a belt conveyor which carries them to the mills.

The mills are located on the side of a hill having an even slope from the crusher and nearly in line with the grinding buildings, thus affording a very favorable storage place. This also obviates the necessity for rehandling the clinkers with the cableway.

The Rocking Cableway

The rocking cableway is an adaptation of the suspension type cableway, so designed as to permit both a longitudinal and a transverse movement. It may be equipped with an automatic bucket and be used to handle loose materials such as coal, coke, ore, crushed stone, or cement; or it may be equipped with some form of hoisting tackle and be used with grab hooks, slings or other devices to handle lumber and logs, or other materials. It is adaptable to practically any class of hoisting and conveying work but it is particularly serviceable for unloading coal or similar materials from railroad cars to storage, and for reclaiming the material from storage when it is to be used.

This type of cableway consists of a track cable suspended from a main or hoist tower and a tail tower, both of which

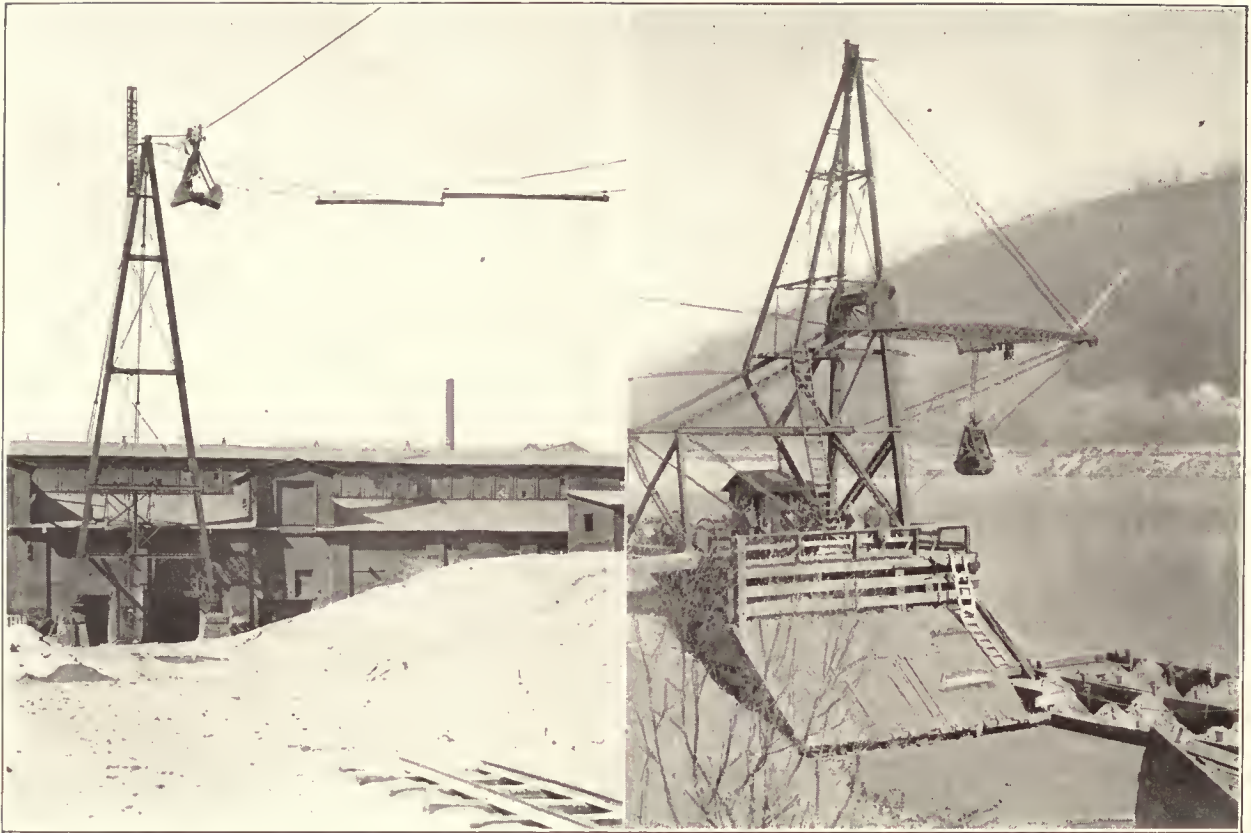

Single Rope Cableway with Hinged Boom on Head Tower for Unloading Materials from Boats



Single Rope Cableway Equipped with Single Line Automatic Grab Bucket for Handling Loose Material

are supported longitudinally by guys or tension cables, and transversely by side-tackle and rocking-ropes. Each tower rests on a quadrant base and is pivoted at the bottom so that it may be tilted or rocked to an angle of about 60 deg. each side of the vertical center line. The rocking motion is imparted by the rocking-ropes which are secured to the top of the tower and to the upper sheave blocks of the side-tackle. The lower sheaves of the tackle are secured to an anchor-block resting in the ground at each side of the tower and the lines pass thence to a drum on a winch which may be located near the base of the tower or in a machinery house which will also serve to shelter the operator. As the drum of the winch is rotated in either direction, the tackle pays out on one side and is hauled in on the other side thus pulling the top of the tower to either side as desired—hence the name “rocking cableway.”

The track cable is kept taut by the tension cables and a cable carriage or trolley is hauled in either direction on the track cable by a load or haulage cable secured to the carriage and operated by a drum on a winch which may be located at one side of the main tower or in the machinery house. The carriage is provided with suitable sheaves for one or more hoisting lines as may be required for the operation of an automatic bucket or for fall-blocks. The hoisting lines are operated by drums on the same winch as is used for the load cable. Steam, gasoline, or electric power may be used and the entire equipment is under the control of one operator.

The use of a rocking tower at both ends of the cableway permits the handling of material over a rectangular area and thus will serve a maximum amount of storage space. In cases where great capacity is not required, a modified form of the rocking cableway may be used in which the tail-tower is held rigid, only the main or hoist tower being designed to rock from side to side. This form of cableway serves a fan-shaped area.

The sidewise scope—width of the area served—of a cableway of the rocking type varies with the height of the tower, the greater the height of a tower tilting at a given angle, the greater the width of the area served.

This type of equipment is made in various capacities ranging upward to 100 tons an hour. A typical installation for handling fuel and ashes at a power house serves an area 500 ft. in length and 100 ft. in width. Similar installations may be made at blast furnaces for handling ore and other materials; at cement mills for handling hot clinker or for other service; and also in foundry yards, structural steel storage, or in any industry having large quantities of materials which must be handled into and out of storage.

Single-Rope Cableway

The single-rope cableway requires only one hoisting cable for its operation and when equipped with a single-line bucket, is used for unloading loose materials such as coal, coke, or sand and gravel from cars to storage piles or for loading it from storage piles to cars. The track cable is stretched on an incline between towers, the loading point usually being at or near the higher tower. The carriage, to which a single-line clam-shell bucket is suspended by a bail, travels on this track cable. The hoisting line passes from the winch to a sheave at the top of the head tower, thence beneath the track cable to the carriage and then over a sheave in the carriage. It is then reeved through the bucket heads and thence back to the carriage where it is made fast. When this line is allowed to pay out, the carriage, carrying the bucket suspended below it, moves down the track cable until a latch on the end of the carriage engages the stop on the cable automatically releasing the

bucket bail. The bucket is thus suspended in the bight of the line and is then lowered by further paying out of the line until it rests upon the material to be handled and is ready to dig.

Pulling in on the hoisting line closes the bucket and lifts it with its load of material to the carriage which is automatically released from the stop so that it is free to move upward along the track cable until it comes in contact with the upper stop. The line is then allowed to pay out, the carriage engaging itself on the upper stop and releasing the bucket, which is lowered and the load discharged by pulling a trip-lever. Upon again being hoisted to the upper stop, the bucket bail engages the carriage causing it to release the stop. Paying out the line then allows the carriage to travel downward by gravity and convey the bucket along the cable.

The bucket may grab a load beneath either stop but it cannot be detached from the carriage between stops, therefore, in order to change the location of the loading and dumping points it is necessary to shift the stops on the track cable. This is easily done by pulling on hand lines suspended from the stops. A pull on the line releases the clamps which prevent the stops from slipping on the track cable and the stop may then be moved as desired. Because of the necessity of moving the stops the single-rope system is not suitable for use where the work is of such a character as to require the bucket to be spotted at a different point each time it takes a load.

Any hoisting winch capable of lifting one-half of the weight of the loaded bucket may be used, but it is essential that the speed be completely under control of the operator, as the carriage must be traveling slowly when it engages the stops.

The single-rope cableway has the advantage of being low in first cost; is simple to operate; requires few lines and sheaves to keep in order; and is easy to erect and to move. It should not, however, be applied where a span greater than 300 ft. is required unless a pull-back line and a counterweight tower is used in order to avoid having an excessively high head tower. With a pull-back line the span should not exceed 500 ft.

Inclined Dragline Cableways

The inclined dragline cableway—also called straight-line or slackline—is a type of semi-gravity cableway used chiefly for excavation work in sand or gravel pits, or for handling ore, coal, or similar materials. It consists of a guyed mast or a tower; an inclined track cable; a load cable; and some form of scraper or dragline bucket.

The track cable is supported at the higher end of the span on a sheave or a saddle at the top of the mast or tower, and the lower end is secured to a suitable ground anchorage at a distance from the mast depending upon the length of cableway span desired. A carrier is mounted on the track cable, and a scraper or dragline bucket is attached to this carrier by flexible connections—chains generally being used. The load cable is attached to the front of the bucket and the carrier and is used for the operation of loading the bucket and for hauling it on the track cable to the dumping point. A tension cable having tension or fall-blocks secured to the track cable at the top of the tower, and to a ground anchorage at the lower end, serves to tighten or slacken the track cable as may be required. Both the load and tension cables lead from guide blocks at the top of the tower down to a double-drum friction winch, usually located at ground level.

To provide an easy means for shifting the lower end of the track cable it is usually secured to a bridle cable. This



Endless-Rope Suspension Cableway Handling Loose Material with a Skip



Endless-Rope Suspension Cableway Handling Coal at a Power House with an Automatic Grab Bucket



Endless-Rope Suspension Cableway Handling Block Stone in a Quarry

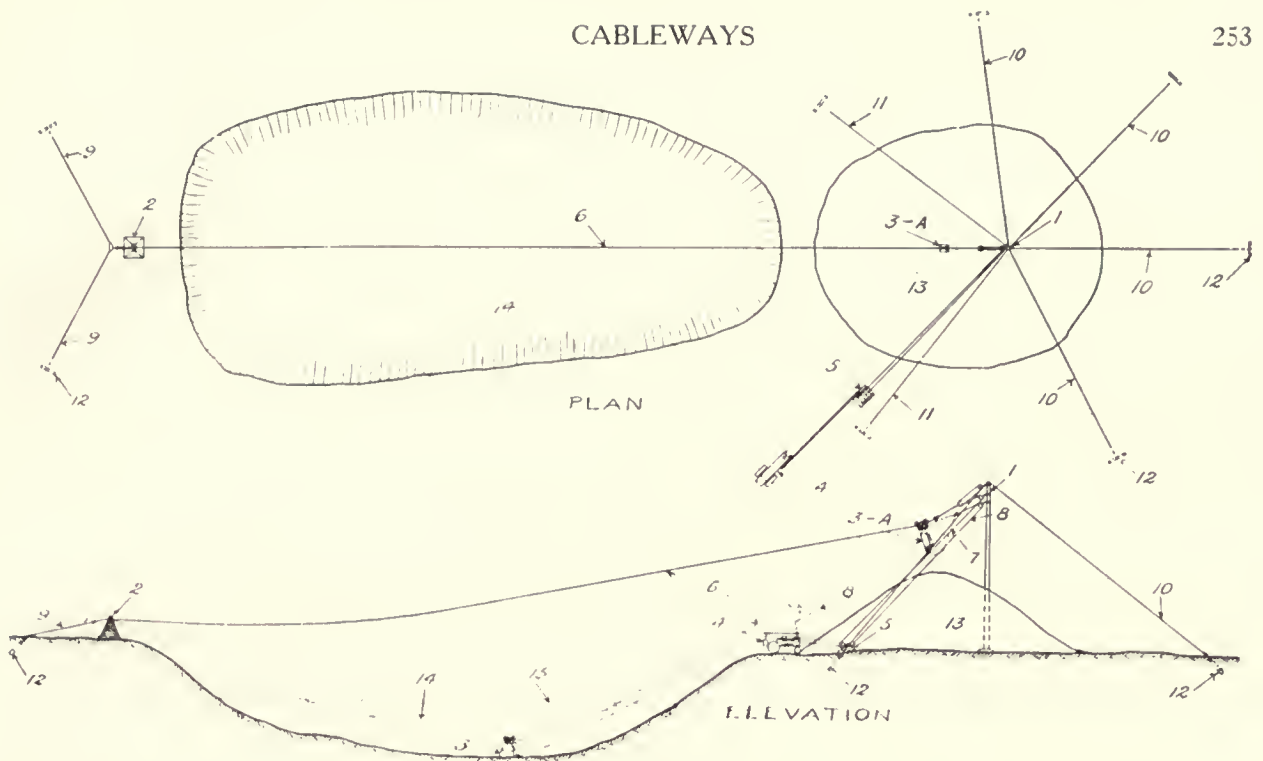

List of Parts

- | | | | |
|--------------------|------------------|------------------|----------------|
| 1 Mast | 4 Tractor Engine | 8 Load Cable | 12 Guy Anchor |
| 2 Tail Tower | 5 Winch | 9 Bridle Cable | 13 Gravel Pile |
| 3 Bucket, Digging | 6 Track Cable | 10 Main Guy | 14 Gravel Pit |
| 3a Bucket, Dumping | 7 Tension Cable | 11 Auxiliary Guy | 15 Water Line |

Semi-Gravity Dragline Cableway Digging Sand and Gravel from Under Water and Delivering it to Storage Pile
Rigged for Forward-End Dump

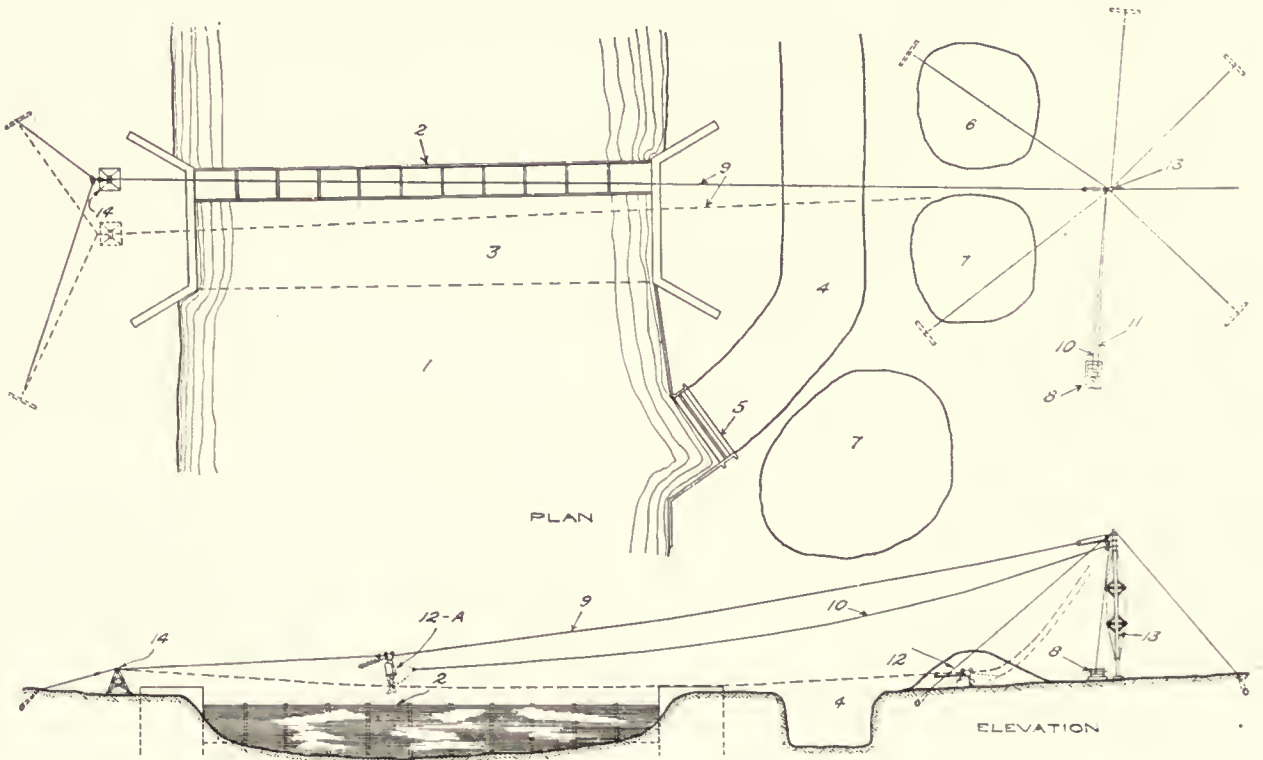

List of Parts

- | | | | |
|-----------------------|--------------|--------------------|---------------------|
| 1 River | 5 Head Gate | 9 Track Cable | 12a Bucket, Dumping |
| 2 Stone Crib Dam | 6 Rock Pile | 10 Load Cable | 13 Mast |
| 3 Rock and Earth Fill | 7 Spoil Pile | 11 Tension Cable | 14 Tail Tower |
| 4 Tail Race | 8 Winch | 12 Bucket, Loading | |

Semi-Gravity Dragline Cableway Installed for Service in Dam Construction Work. Rigged for Low-End Dump

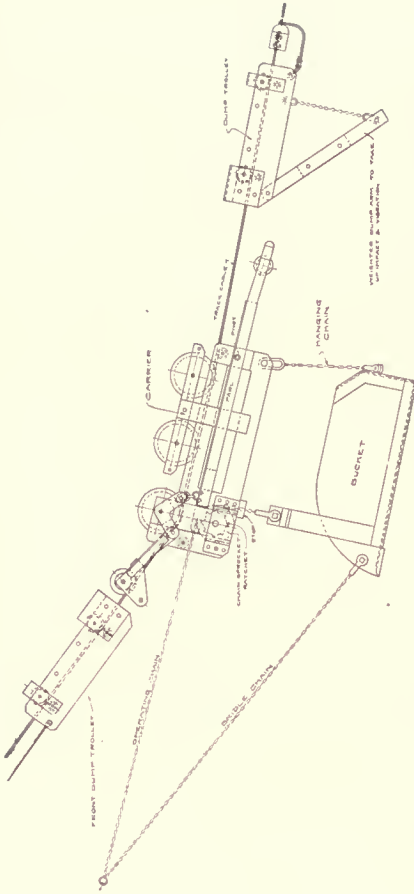

Dragline Cableway—Combination Forward and Low-End-Dump Carrier and Bucket

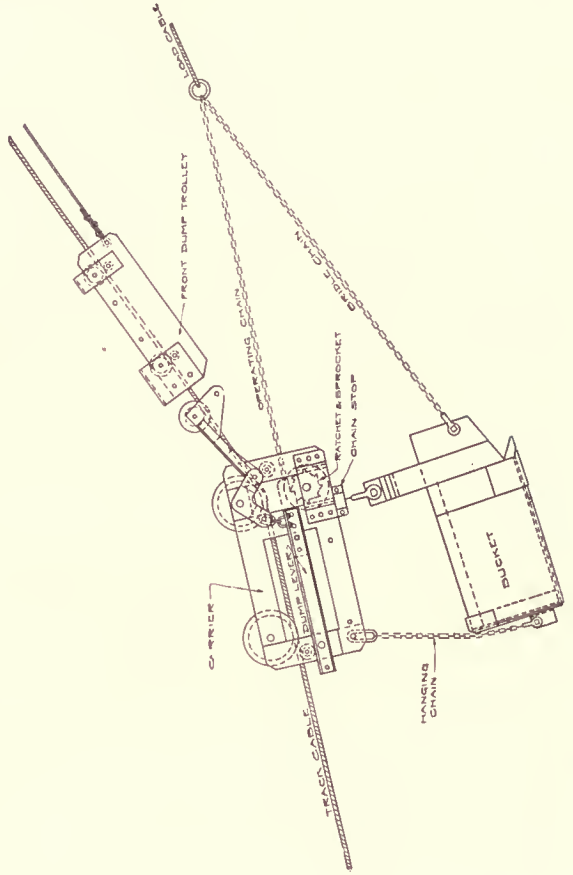

Dragline Cableway—Ratchet Type Forward-Dump Carrier and Bucket

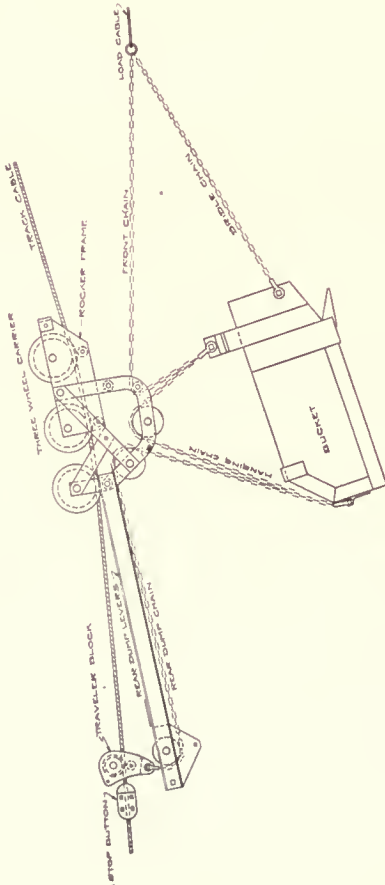

Dragline Cableway—Chain Type Low-End-Dump Carrier and Bucket

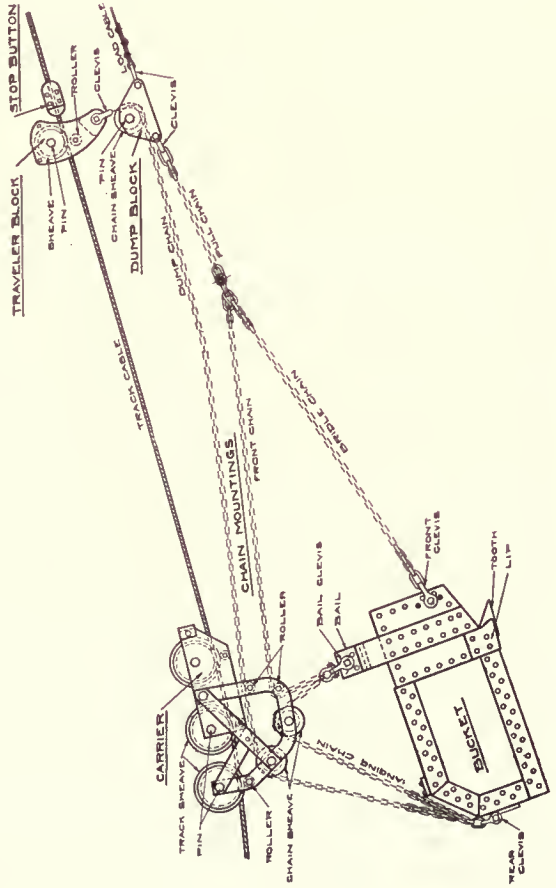

Dragline Cableway—Controlled Forward-Dump Carrier and Bucket

bridle cable is installed by placing two anchor logs some distance apart, the usual distance being about 150 ft. One end of the bridle cable is brought around one of the anchor logs and then fastened. The other end of the bridle cable is passed through the bridle frame and then brought around the other anchor log. This cable may be provided with tackle so that in using a movable tower a considerable lateral movement of the cableway may be obtained without changing the location of the anchorages.

The operation of this cableway usually begins with the track cable taut and the empty bucket near the top of the cableway. The operator then releases the friction of the front drum of the winch, which releases the load cable. This allows the carrier and bucket to travel by gravity down the inclined track cable, the speed being controlled by the brake on the friction drum. When the point of excavation has been reached the downward travel of the bucket and carrier is stopped by the brake on the front drum, and the bucket is lowered to the material by slacking off the track cable. The load cable is then hauled in, drawing the bucket into the material. After it is filled the track cable is again hauled taut and the bucket is either drawn upward by the load cable to a dumping point at the upper end of the cableway or it is allowed to travel by gravity further down the inclined track cable to a lower dumping point.

In the operation of this type of cableway the load is always gathered as the bucket is hauled toward the main tower but the material may be dumped either at the upper end of the cableway on the upward travel, or it may be allowed to travel down the inclined track cable and be dumped at the lower end. This is accomplished by special dumping devices attached to the bucket and to the track cable.

Controlled Front-Dump Type

One type of bucket used on dragline cableways is designed to dump during the upward travel of the load. A bucket hanging chain is secured to a rigid hail at the front of the bucket, passing upward over a sheave on the cable carrier and thence to a clevis on the rear of the bucket; a front-chain is secured to the bail clevis and a bridle-chain is secured to the front clevis, both these chains being brought together and connected to a pull-chain which in turn is connected to a dump-block attached to the load cable; a dump-chain is secured to the rear clevis and, leading upward over a sheave in the carrier frame, passes under a sheave in the dump-block from whence it passes upward and is secured to a clevis on a traveler-block running on the track cable.

The cycle of operation is as follows: Starting with the bucket empty in the dumping position at the point of discharge, the load cable drum is released allowing the bucket to travel by gravity down the inclined track cable, automatically righting itself as it goes. When the digging point is reached, the track cable is slacked off lowering the bucket to the material and the load cable is then hauled in, the bucket being drawn into the material filling as it goes. When the bucket is filled, the track cable is hauled taut raising the bucket with it. The travel continues until the travel-block comes in contact with a stop clamped to the track cable at the desired dumping point. This provides a fulcrum for the dump-chain, which passes through the sheaves as the dump-block attached to the load cable continues its forward movement, drawing the rear end of the bucket upward to the carrier and dumping the load.

Low-End Dump

In another method of operating a dragline bucket on the dragline cableway the dumping point is at the low end

of the inclined track cable. In this arrangement, the rear of the bucket is connected to the rear of the carrier by a hanging chain. Bridle chains are connected to the front end of the side plates of the bucket and an operating chain is connected to the top of the bail at the front of the bucket. This operating chain passes over and engages a chain sprocket wheel mounted at the front end of the carrier. The sprocket wheel has ratchet wheels on each side which engage two pawls that are pivoted to the side of the carrier and are connected to lever arms which extend from the pivot point on the carrier to the rear and outside of the carrier. A roller is provided between the outer end of these lever arms and engages a dump trolley which is equipped with an inclined dump lever and is secured to the track cable at the desired dumping point. To meet special conditions, this arrangement sometimes is modified and a traveler block provided to operate the rearward extending arms.

In the operation of this type of bucket, the bucket is lowered at the point of excavation by slackening the track cable until the bucket comes in contact with the material. A pull on the load cable draws the bucket into the material and after it is filled the track cable is tightened and the bucket is raised clear of the excavation. When the bucket is raised, the pawls on the side of the sprocket engage with the ratchets and this prevents the sprocket from revolving backward. The front of the bucket is thus prevented from lowering and dropping its load. The loaded bucket then travels by gravity down the inclined track cable, the speed of travel being controlled by a band brake attached to the drum which operates the load cable. When the dumping point is reached, the roller on the rearward extending arms comes in contact with the inclined dump lever of the dump trolley, forces the lever downward and disengages the pawls. The chain sprocket wheel may then revolve and the material is dumped by simply slacking off the load cable.

Other Methods of Operation

To meet special working conditions a carrier having both the forward end and the low end dumping arrangement may be used. This device operates at either end in the same manner as either of the other types, but requires both a front and rear dumping-trolley on the track cable.

In another type of slack-cable dragline cableway the bucket is secured directly to the carriers which travel on either a single or a double cableway—two cables stretched parallel to each other. The cables are supported on towers and are so arranged on the hoisting winch that they may be slacked off to lower the bucket to the material. The bucket is so designed that it readily digs into the material as it is hauled forward. When the bucket is filled the cables are drawn taut and the load cable is hauled in drawing the bucket to the dumping point where the load is automatically dumped by a tripping device.

Power-Scraper

The power-scraper is a type of cable apparatus adapted to handling loose material, such as coal, ore, sand or gravel in storage, or for handling coarser, harder material which has first been broken up by a plow or by other means. It may also be used for excavation and filling work in easily dug materials, or for stripping overburden from gravel banks, stone quarries, or open coal or ore mines. This apparatus is a form of cableway or dragline equipment in the operation of which the bucket or scraper is not hoisted but is dragged through the material when being filled and is hauled on top of it when being drawn back for another load. It consists of a load cable secured to the bridle chains of the

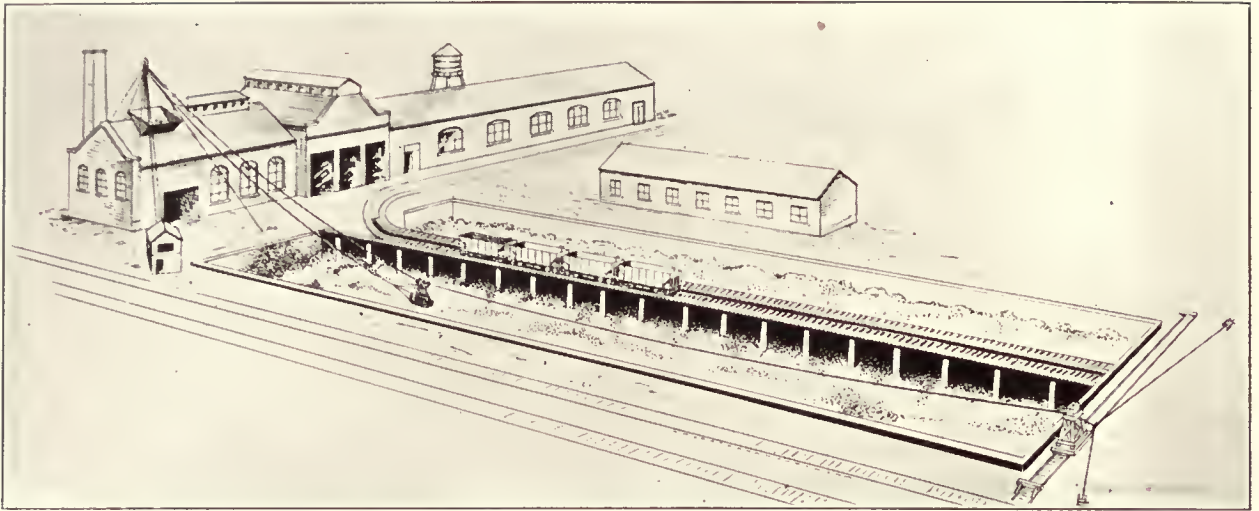

Dragline Scraper Cableway Handling Coal from Storage to Power House

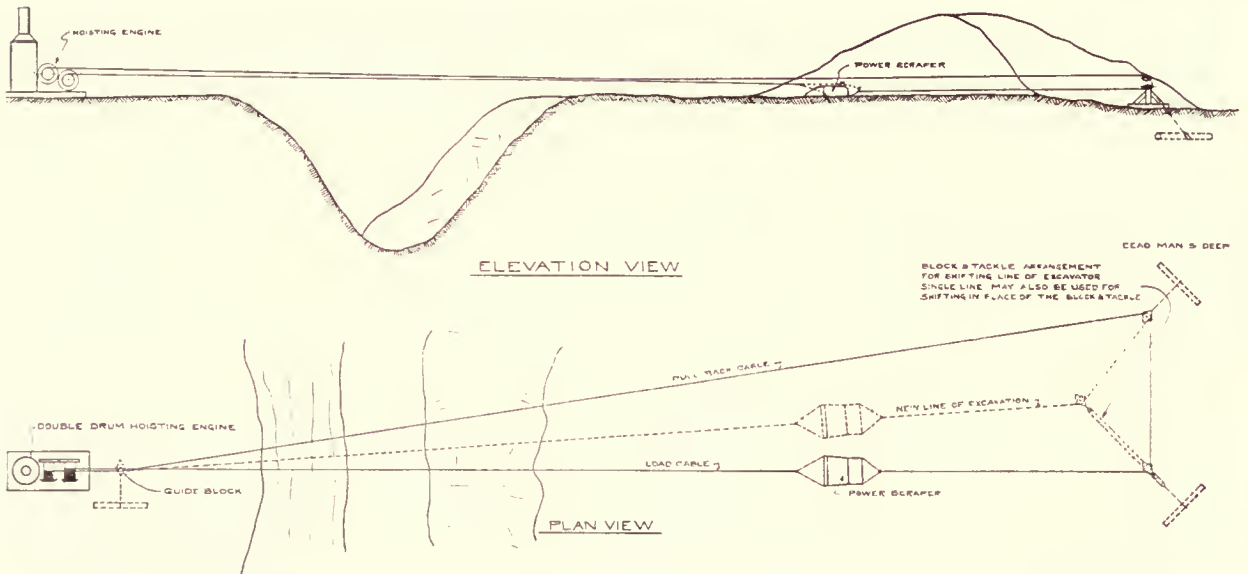

Dragline Power Scraper Digging and Filling in a Continuous Operation



Dragline Scraper Cableway Digging Sand and Gravel from Under Water and Dumping Into Disposal Bin

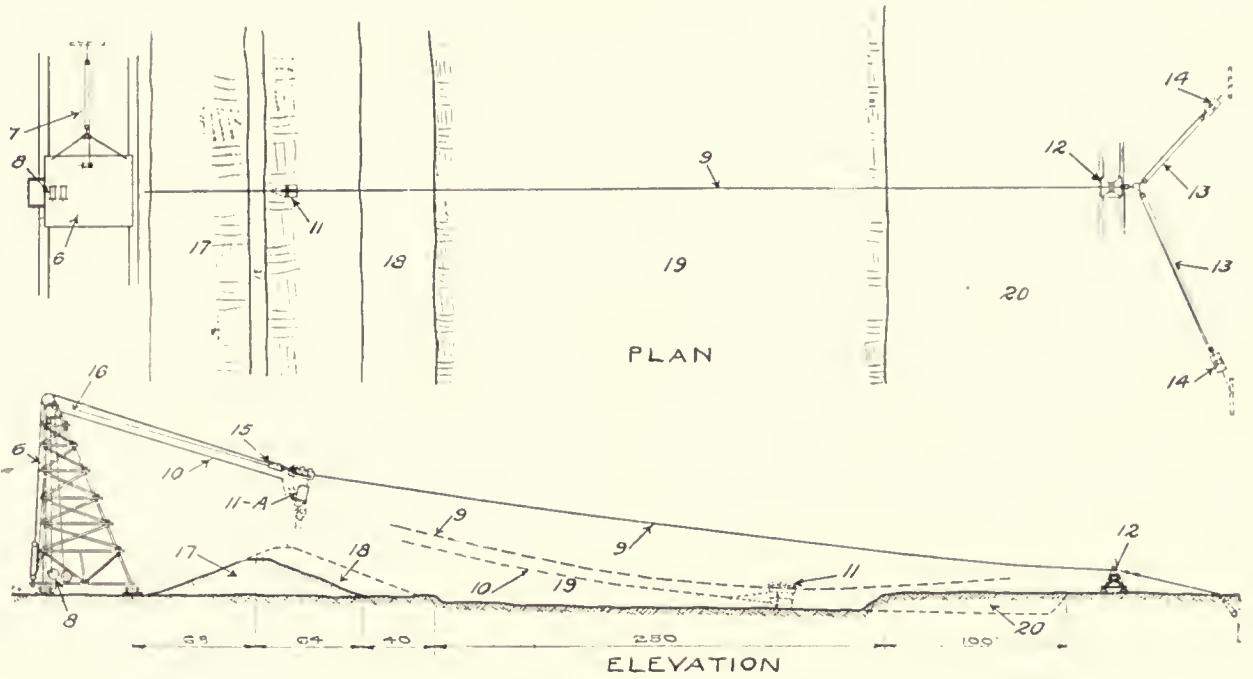

Semi-Gravity Dragline Cableway with Self-Supporting Movable Head Tower and Bridle Shifting Cable for Levee Construction Work. Rigged for Forward-End Dump

List of Parts.

- 1 A-Frame
- 2 Guys
- 3 Hopper
- 4 Industrial Car
- 5 Track to Plant
- 6 Movable Tower
- 7 Tower Shifting Cable

- 8 Winch
- 9 Track Cable
- 10 Load Cable
- 11 Bucket, Digging
- 11a Bucket, Dumping
- 12 Movable Tail Tower
- 13 Bridle Shifting Cable

- 14 Hand Winch
- 15 Dump Trolley
- 16 Dump Trolley Cable
- 17 Levee
- 18 Levee Enlargement
- 19 Exhausted Pit
- 20 Borrow Pit

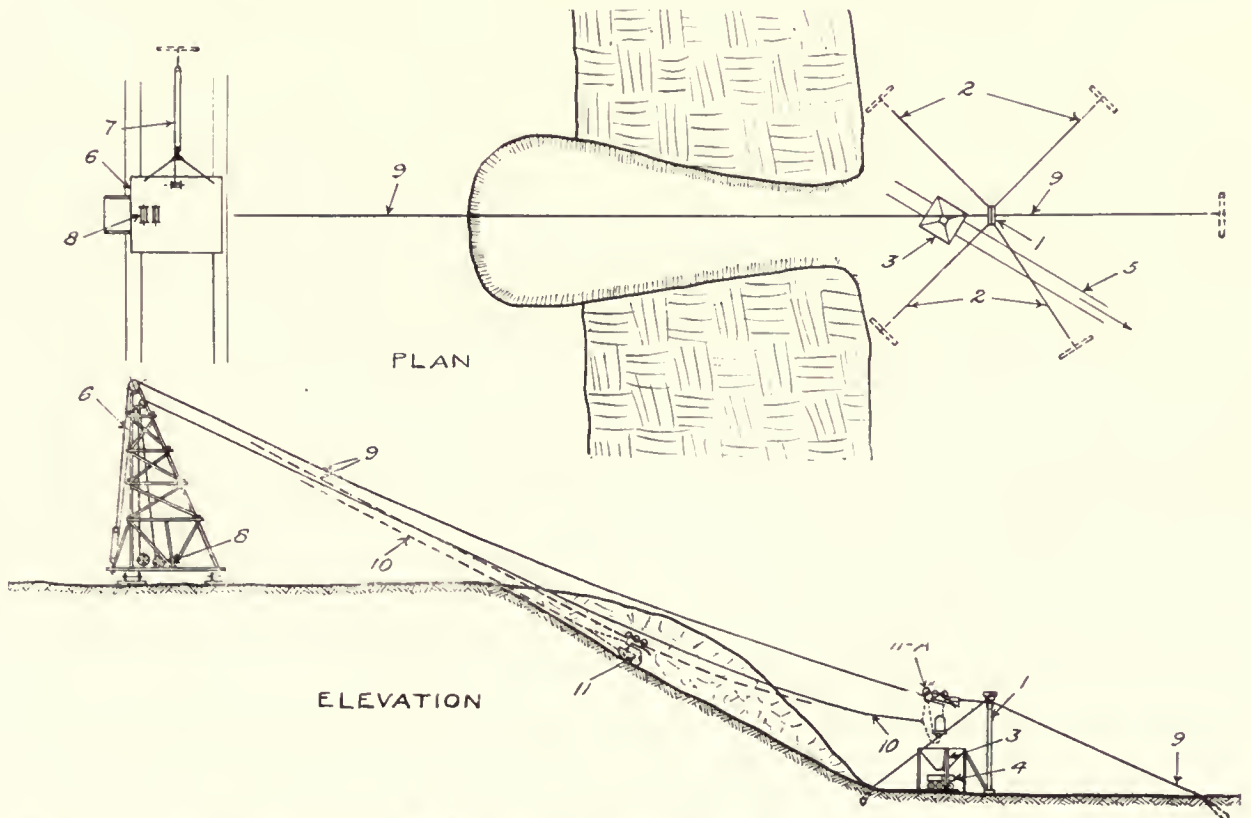

Semi-Gravity Dragline Cableway with Movable Head Tower and A-Frame Tail Tower Handling Clay at a Brick Plant. Rigged for Low-End Dump Into Receiving Hopper for Discharge Into Industrial Cars

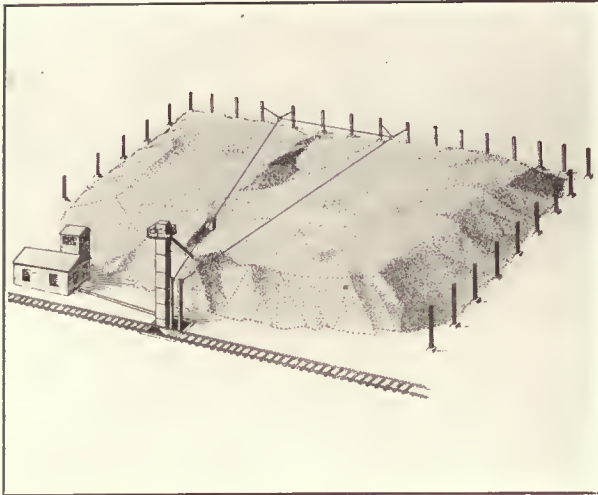

Cable Drag-Scraper Installed at Coal Storage Plant



Dragline Scraper Cableway Excavating from River Bed

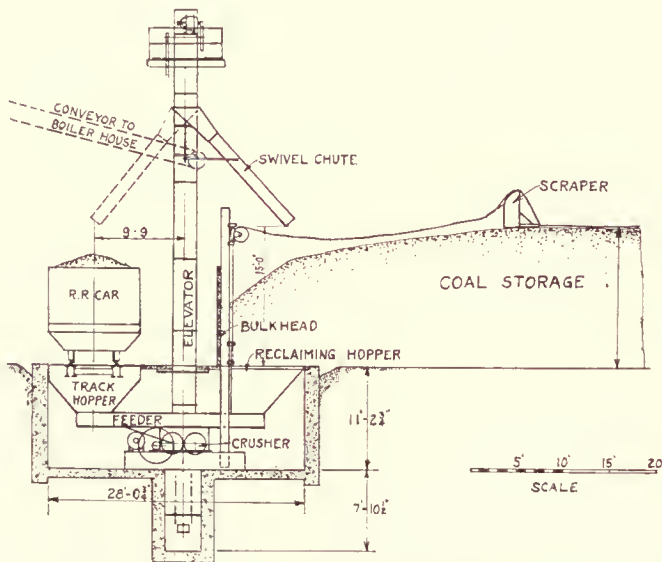

Cross Section Showing Construction of Cable Scraper with Hopper, Elevator and Conveyor for Distributing Coal

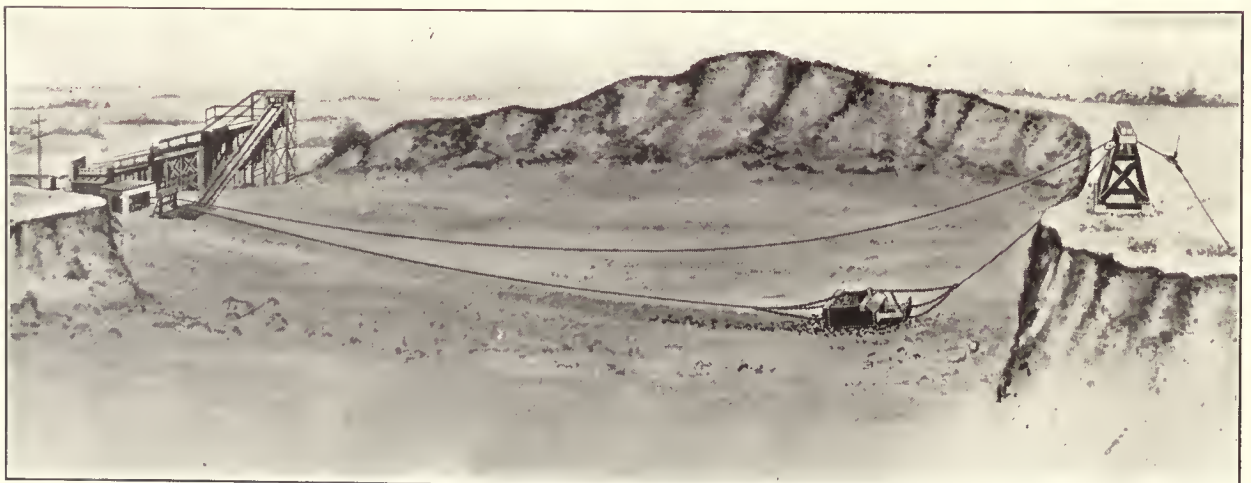
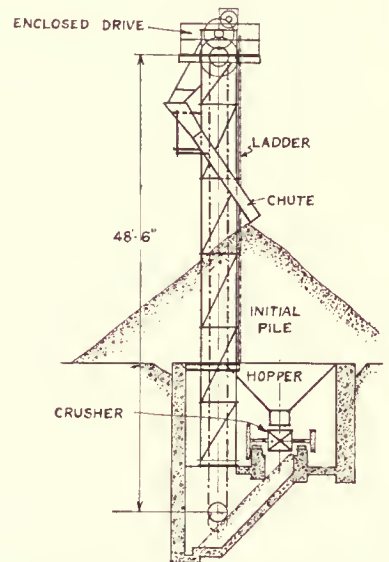

Cable Dragline Scraper Cableway Operating Bottomless Scraper in Sand and Gravel

drag scraper or bucket; a pull-back cable secured to the rear of the bucket; and two lead-blocks secured to stakes or other supports anchored in the ground at suitable points on the far side of the area served. Both the load cable and the pull-back cable are wound on a two-drum winch which usually is located at one side of the area containing the material to be handled. This winch may be operated by steam, gasoline, or electric power.

The load cable either leads through sheaves on the winch frame or directly from the front drum of the winch to the front or bridle chains on the scraper. The pull-back cable leads from the rear drum of the winch through a guide block located so that the cable will wind properly on the drum. The cable then passes through two other guide blocks located in the rear of the scraper at the far side of the excavation and is brought to the rear chains of the scraper and attached. The rear guide blocks are usually set from 50 ft. to 150 ft. apart and one of them is attached to a block tackle. By either slacking off or hauling in on this tackle the line of operation of the scraper may be shifted to any intermediate position between the two rear guide blocks.

The scraper is a bottomless type of dragline bucket open at the front and having a runner frame which is equipped with digging teeth and a cutter edge. The cutter edge is pivoted and adjustable which makes it possible to adjust the angle of it so that the greatest efficiency may be obtained in excavating and handling various kinds of materials. It is so designed that the cutter edge becomes inoperative after the scraper is filled with material thus saving considerable power as the loaded scraper is pulled to the dumping point. When the scraper reaches the dumping point, the pull-back cable is put into operation and this draws the scraper away from the material and back to the digging point. The runner frame has a pivoted connection to the scraper body and this allows it to ride over stones or other obstructions which may be in the path of the scraper when it is drawn backward instead of expending power to force the scraper through or to push the obstructions to one side.

In the operation of this machine, starting with the scraper at the digging point, the operator disengages the friction of the rear drum and throws in the friction of the front drum. This puts the load cable in operation which pulls the scraper forward and causes the cutter edge to dig. The material thus loosened fills in between the two side plates of the scraper and the loaded scraper is then hauled over the ground to the dumping point. The operator then disengages the front drum and throws in the friction of the rear drum putting the pull-back cable in operation and drawing the scraper to the rear. The scraper, being of the bottomless type, is readily drawn away from the load and back to the digging point, practically no time being lost in the dumping operation.

By installing the front sheaves on an elevated frame or tower the power-scraper type of cableway may be utilized to draw material up an inclined runway and deposit it in a hopper. From the hopper it may be dumped into a railroad car or on a conveyor and disposed of as desired. It may also be used to bring material within reach of a dragline cableway excavator. In this case, a duplex power-scraper should be used and the rear sheave blocks mounted on a bridle-cable which will permit a change in the line of operation by simply shifting the guide-block attachments on the cable. With this rigging, as one scraper is drawn forward with its load the other scraper travels back to the digging point.

In the operation of the power scraper the loaded scraper may travel at an approximate speed of 200 ft. per min. and the empty scraper may travel back to the digging point at

a speed ranging upward to 600 ft. per min. The amount of material that may be handled per hour depends upon the length of the haul or cable span which may be upward to about 1,000 ft.; the scraper capacity ranging from about $\frac{1}{2}$ cu. yd. to 2 cu. yd. or larger; and the class of material being handled

Power-Scraper Cableway

The power-scraper cableway is a combination of the slack track cable and the cable dragline scraper. The scraper is suspended on a carrier traveling on the track cable, which can be raised or lowered by a tension cable mechanism. A two-drum hoist is used to operate this machine, the front drum operating the load cable and the rear drum the tension mechanism. When the track cable is raised and pulled taut over the top of the mast or tower, the carrier and the scraper travel by gravity down the inclined cable. When the digging point is reached the track cable is slackened and thus the scraper is lowered to the material. The load cable is then put in operation pulling the scraper forward so that it digs its load, and it is then pulled over the ground to the dumping point. The track cable is then again tightened and the scraper is drawn away from the load and is raised off the ground sufficiently to return by gravity to the digging point.

This apparatus is designed to handle the same classes of materials as the power-scraper but has a considerably greater capacity. Because of the cost of the towers, tracks, etc., this type is not an economical one where only a small amount of material is to be handled; therefore, the power-scraper cableway should be installed only where a large amount of material must be moved.

Cable Drag-Scraper

The cable drag-scraper is a type of dragline cable apparatus used chiefly at power plants for handling coal from railroad cars into storage and for reclaiming it when desired for use. To install this apparatus a series of posts is set around the sides and rear of the storage space—which may be of any desired shape. A chain-bucket elevator is placed in a tower at the front or railroad side of the storage space. This tower has a discharge chute projecting over the storage area and a combined receiving hopper, reclaiming hopper, and elevator pit is located under the elevator tower and the adjacent railroad tracks. A single haulage or drag cable is reeved through sheaves or tail-blocks attached to any two of the posts on the sides or rear of the storage space and passes through sheaves on two front posts located near the elevator tower and thence to the drums of a haulage winch located in a nearby machinery house which also serves as a shelter for the operator. The scraper, which is an open-end and practically bottomless form of dragline bucket, is attached to one side of the drag cable and is thus dragged back and forth over the storage area as the cable runs through the sheaves on the posts.

The coal is received in railroad cars and is discharged into the receiving hopper below the tracks. The bucket elevator then picks up the coal and delivers it down the chute to one side of the storage space, forming an initial pile within reach of the cable drag-scraper. The scraper is then dragged back and forth over the coal and distributes it over the storage space. To reclaim the coal from storage for use, the scraper is reversed on the cable and the coal is scraped back to the reclaiming hopper and delivered to the bucket elevator, which may be arranged to discharge the coal either to railroad cars or to a conveyor running to a bin or bunker in the boiler house.



Logging Cableway Skidding Logs Across Flat Country

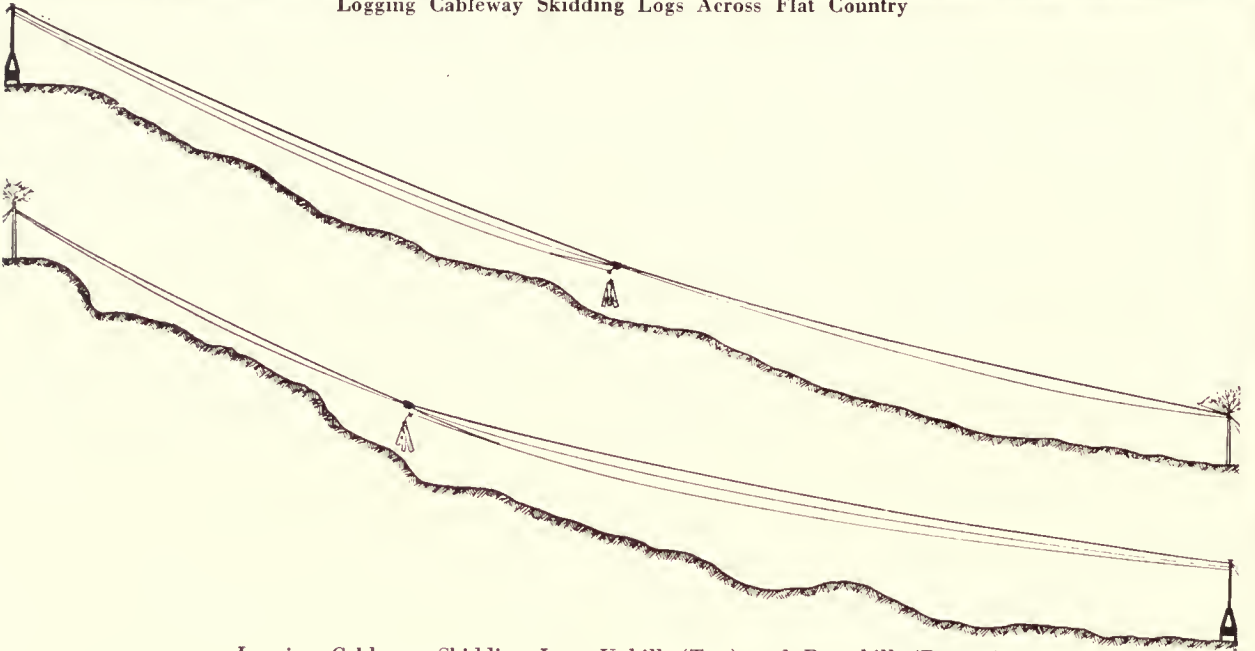

Logging Cableway Skidding Logs Uphill (Top) and Downhill (Bottom)

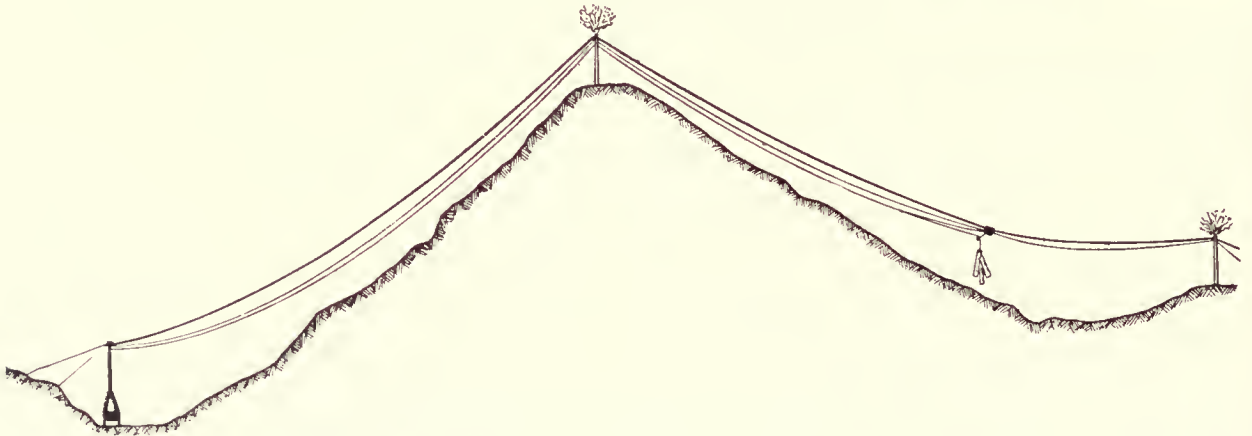

Logging Cableway Skidding Logs in Relays Over Hilly Country

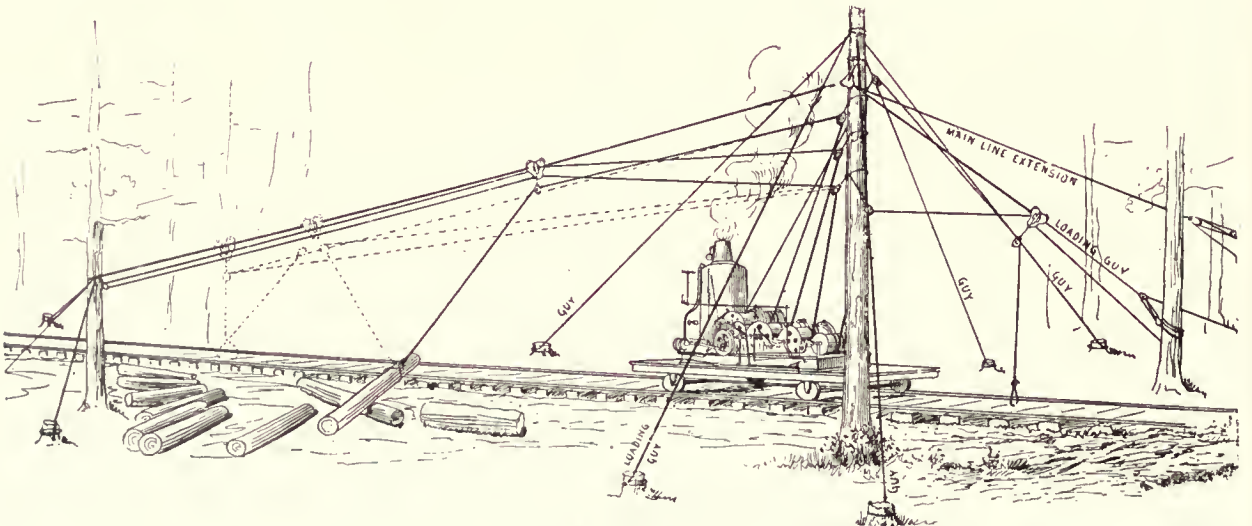

Logging Cableway Using Growing Timber for Supports

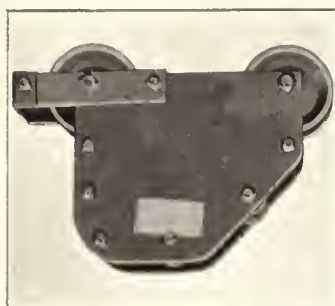

2-Wheel Plate Carrier

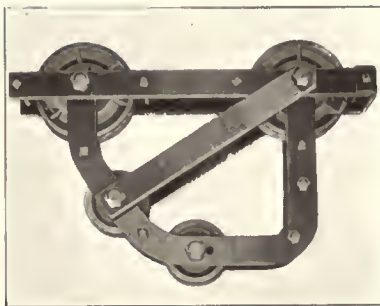

2-Wheel Bar-Frame Carrier

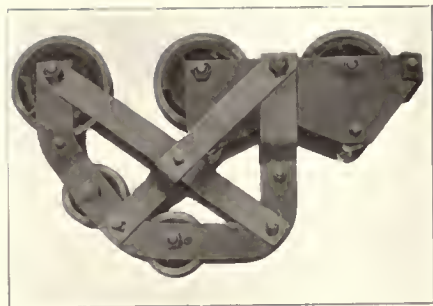

3-Wheel Bar-Frame Carrier

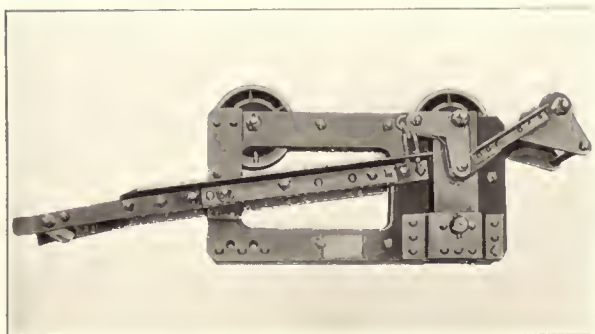

2-Wheel Carrier. Forward and Low-End Dump

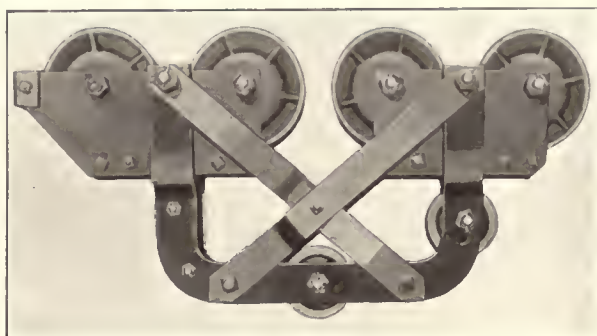

4-Wheel Bar-Frame Carrier with Rocker Wheel Frames

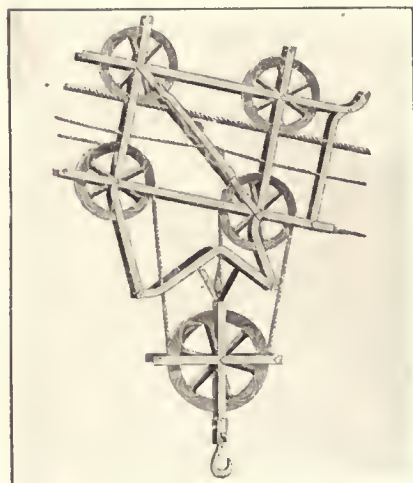

Inclined Cable Carriage

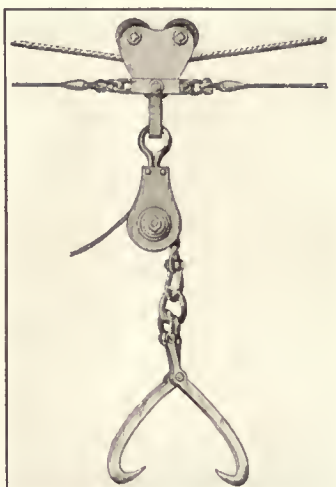

Log Loading Carriage

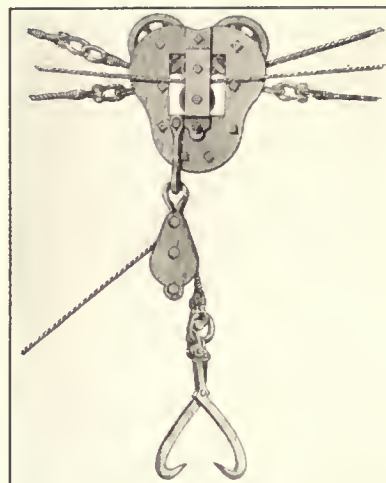

Log Skidding Carriage

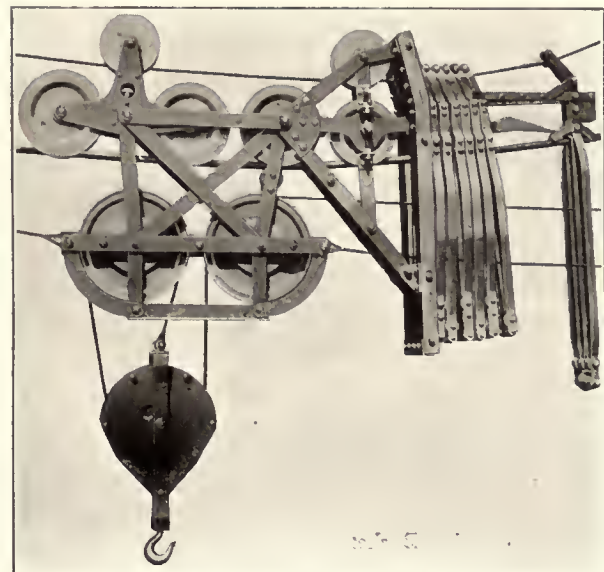

Cable Carriage with Rope Trolley Carrier Horn

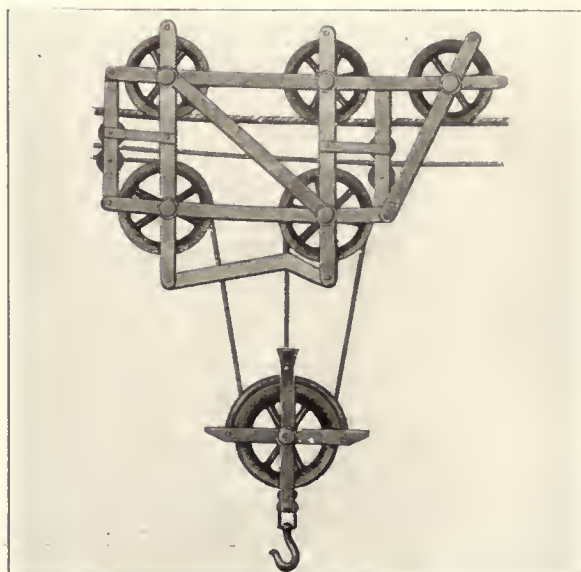

Horizontal Cable Carriage

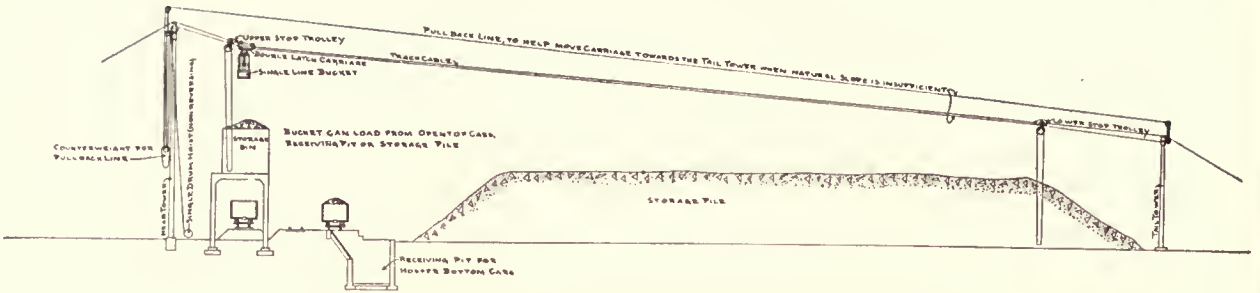

Single-Rope Cableway with Pull-Back Line and Counterweight

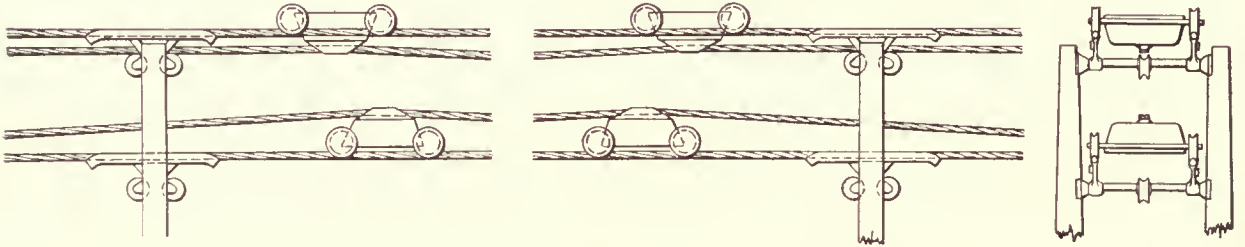

Double-Rope Cable Tramway Equipped with Tram-Cars

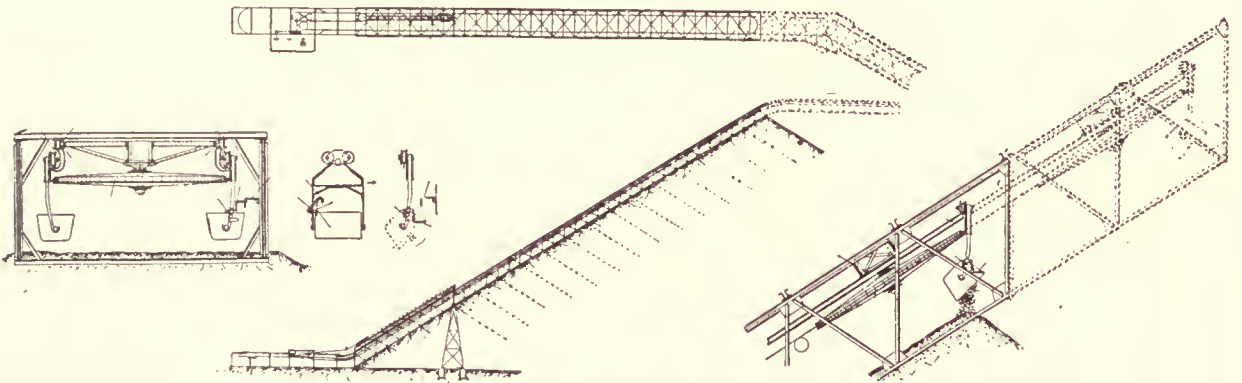

Stacking Tramway Showing Method of Extending Bridge

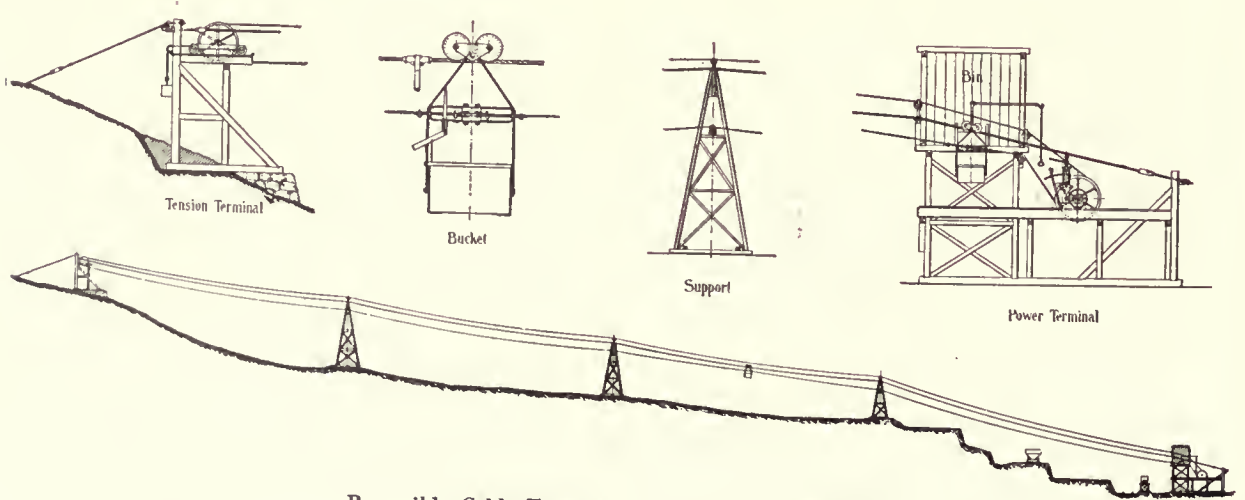

Reversible Cable Tramway with Self-Dumping Bucket

A drag-scraper will handle either run of mine coal or a crusher may be placed in the pit and the coal crushed for stoker use. In the winter when the coal becomes frozen, large lumps can be dragged by the scraper directly to the track hopper and thence to the crusher and broken up so that it may be handled by the elevator and conveyor.

Cable apparatus of this type has a handling capacity of from 50 to 100 tons of coal per hour depending upon the size of scraper used and the length of haul required.

Another type of power-scraper cable apparatus embodies the general principle of the taut suspension cable and the endless-rope traction to which is added a bucket or scraper device for scraping and automatically dumping the material. The supports for the track cable may be of the traveling-tower type similar to the head tower used on other cableways, but a light, portable A-frame which may readily be moved may be used for the tail tower.

The winch for operating the apparatus is mounted at the base of the head tower. It generally is of the three-drum tandem type fitted for operating both the scraping and the dumping lines. The automatic dumping operation is effected by a dumping line which is fastened to the rear of the scraper and, passing through a pulley at the top of the hoisting bail, is secured to the scraping line a suitable dis-

tance from the end of the bail. When digging the material, the bail to which the hoisting line is fastened lies loosely on the scraper and hence there is no tension on the dumping line. After the scraper is filled and is hoisted this line is shortened as the hoisting bail is raised and then, by winding up the scraping line, the rear of the scraper is tilted and its contents discharged. With the use of the endless-rope all the movements of the carriage are under control and the material can be taken up or deposited at any point.

For excavation work where the use of towers may not be practicable, a derrick may be substituted for the head tower by using a separate line to drag the bucket or scraper to the opposite end of the span where a sheave-block, through which to reeve the outhaul line may be arranged to move in either direction so as to cover the entire width of the excavation.

With this equipment, the material can be conveyed to either side of an excavation and automatically dumped. It is adapted for excavating sewers, canals, or cellars, and when required the material can be loaded direct on cars or wagons for removal. It may be rigged to excavate in the direction parallel to the track cable or, by placing suitable sheaves or blocks at either side of the area being excavated, it may be operated at right angles.

Cable Tramways

The cable tramway—or aerial tramway, as it is termed—is used to transport materials, such as coal, ore, sand, gravel or cement, that may readily be carried in buckets, or it may be used for handling logs, lumber, or other materials with the aid of suitable handling devices. It is also possible to carry at the same time on one line several kinds of material, such as ore, logs, and timbers. This type of equipment is of substantially the same design as the suspension cableway, the chief difference being that instead of using the single-span, typical of the suspension cableway, the tramway cables generally are of much greater length and are supported at each end by terminal towers or stations and at intermediate points by trestles.

Track Cables

Cable tramways ordinarily have two parallel stationary track cables stretched taut between the two terminal stations. One side of the tramway is generally used entirely for carrying the load and the track cable on this side usually is of larger diameter than that on the side which carries the empty receptacles. Both cables are attached to swivels in the terminal stations so that they may be turned at regular periods, the wear on the cable thus being distributed around its entire circumference.

The cables are supported on intermediate towers or trestles constructed of wood or steel and varying in height according to the character of the ground. The distance between towers varies from 50 ft. up to several thousand feet, depending upon the contour of the tramway route. Generally the cables rest on saddles placed on the top of the towers thus eliminating much of the wear and prolonging the life of the ropes. Where the individual loads are heavy, and the tonnage carried is great, a rocking saddle is sometimes used to ease the action of the carriers as they travel over the track cable at the towers.

To further reduce the wear and to permit free movement of the track cables, they are kept taut by tension weights. The cables are anchored at one end—preferably at the higher elevation to take advantage of the weight of the cable itself—while at the other end they are

attached to chains or ropes which pass over sheaves from which tension-weight boxes are suspended. These boxes are loaded with weights, the total weight being determined by the size and strength of the track cables used and the load to be carried. These weights rise and fall with the varying sag of the track cable, due to the number and weight of the carriers and to the expansion or contraction of the cables caused by changes in temperature. Where conditions are such that weights cannot readily be installed a take-up block or tackle may be used.

When the distance between the two terminal stations is very great—exceeding 1 to 1½ miles—or the grades are very severe, an intermediate tension station is installed. At this point the track cables are parted, one end being attached to a fixed anchorage and the other end to a tension gear similar to that used at the terminal stations. This prevents the excessive stresses developed in a cable of great length. A section of overhead rail is used with this arrangement to connect the track-cable ends.

Where the tramway line passes over the crest of a hill or mountain range, and the contour is such as to require towers spaced too closely together, a breakover or a rail station is generally used, instead of the ordinary tower, to prevent excessive wear of the track cables at that point. The rail station consists of a series of bents or trestles supporting two parallel steel rails curved to a large radius and over which the carriers travel instead of on the track cable. At such points the track cables either may be cut and the ends anchored separately, or they may continue through the station underneath the rail.

Traction Cable

The traction cable by means of which the load is hauled on the track cable is spliced endless and passes around horizontal sheave wheels of large diameter located at the terminal stations. Under severe conditions either the number of grooves in the sheave and turns of the cable around the sheave is increased or an automatic grip-wheel is substituted. The grip-wheel is so designed that the harder the pull on the traction cable, the more firmly the

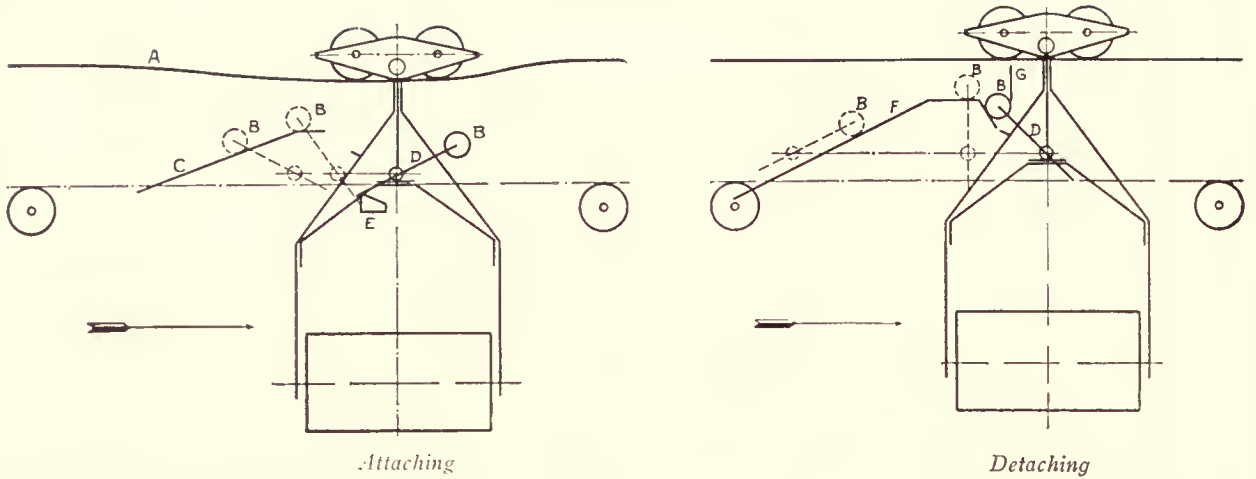

Cable Tramway—Carrier Attaching and Detaching Device

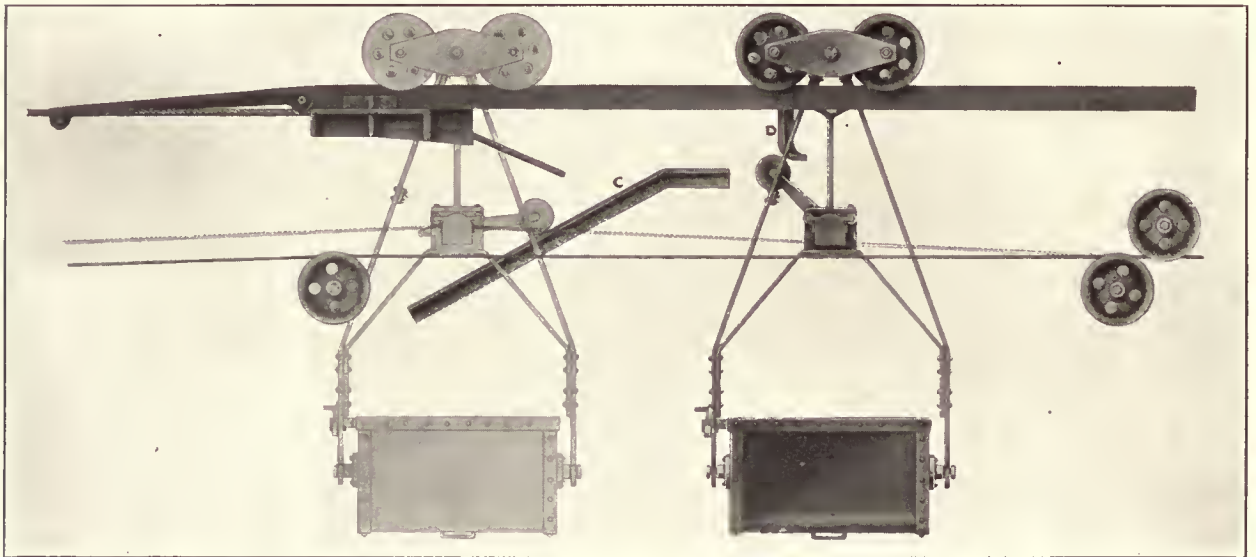

Cable Tramway—Carrier Detaching Device at Discharge Terminal

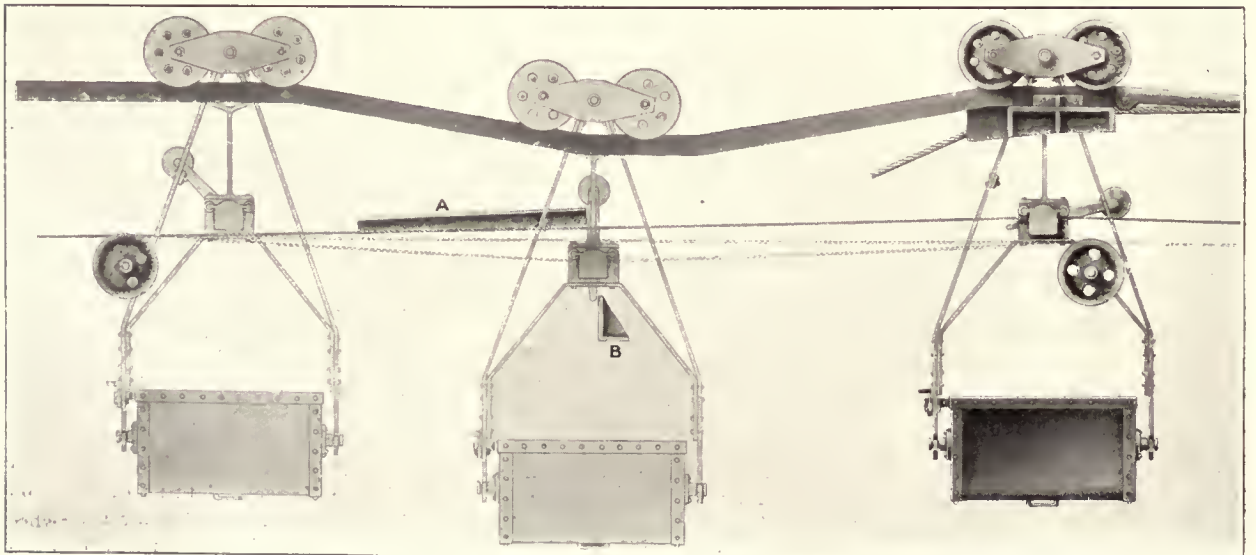

Cable Tramway—Carrier Attaching Device at Loading Terminal

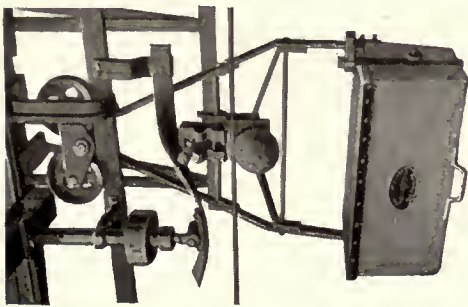

Carrier with Compression Grip Passing Through Automatic Attacher

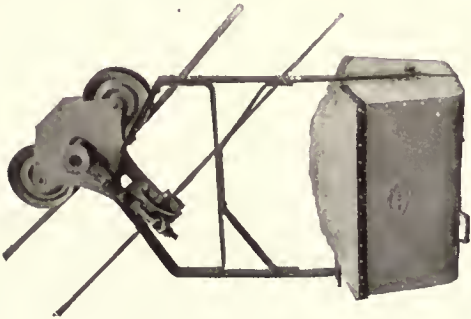

Carrier with Automatic Underhung Grip Operating on Inclined Cable

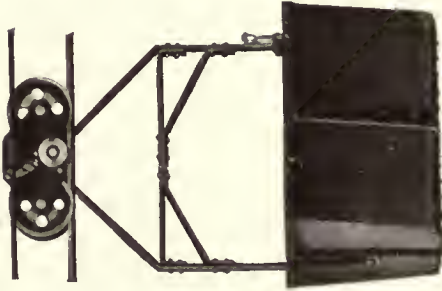

Overhead Grip with Traction Rope Placed Above Track Cable



Self-Dumping and Self-Righting Bucket for Reversible Tramway

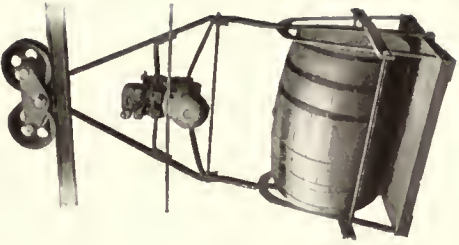

Platform Carrier for Barrels, Boxes, etc. Compression Grip



Loading Terminal Showing Carrier with Overhead Grip Passing Down Inclined Rail to Attaching Point



Transferring Buckets to Surface Cars on Inclined Track



Loading Terminal Showing Carriers with Underhung Grip in Attaching and Detaching Positions

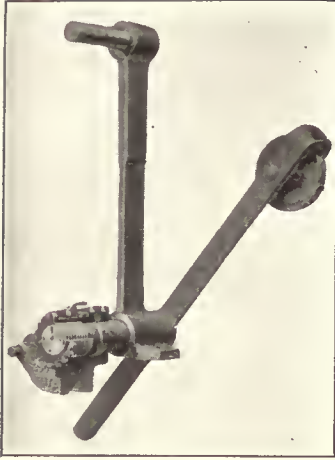

Friction Grip

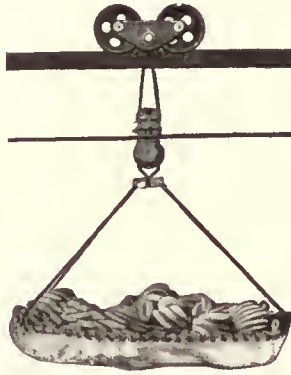

Tray-Carrier

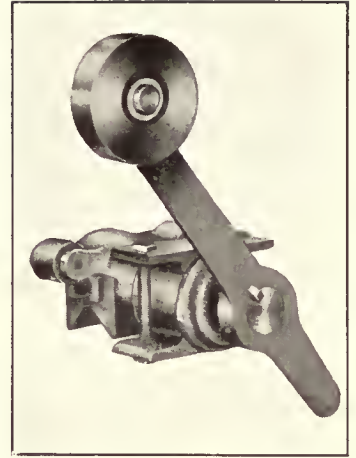

Friction Grip



Bucket Carrier with Friction Grip

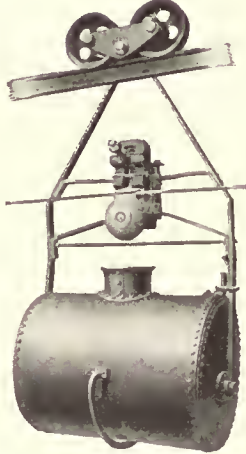

Liquid Carrier with Compression Grip



Bale Carrier with Overhead Grip

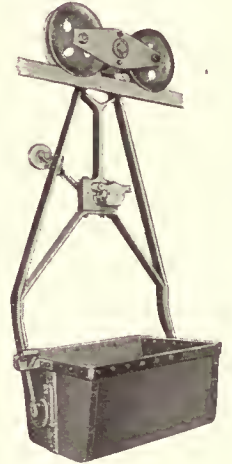

Bucket Carrier with Friction Grip

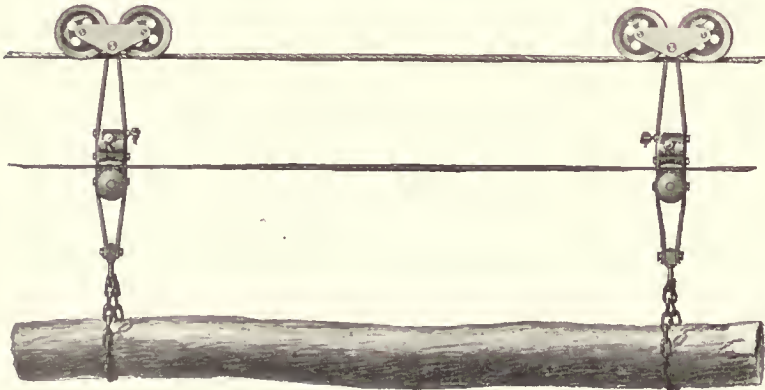

Log Carrier with Two-Compression Grips

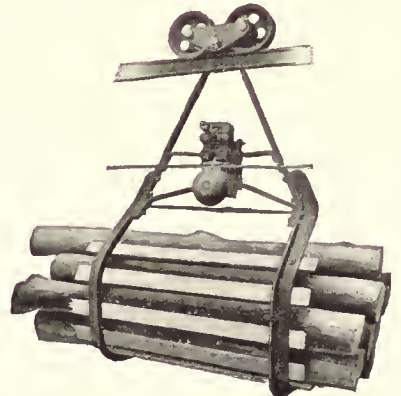

Cordwood Carrier



Cable Protector-Saddle

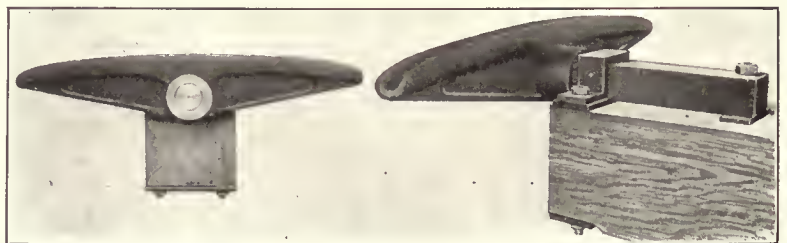

Rocking Cable Saddle

cable is gripped, and thus slipping of the cable is prevented. During the operation of the tramway the traction cable is usually supported by the grips on the carriers, but when a portion of the line is free from carriers the traction cable is supported by rollers placed on the towers, far enough below the track cables to allow the carriers to clear them. These rollers vary in diameter according to the pressure imposed upon them, thus insuring maximum service from the traction cable.

Where the length and capacity of the tramway and the conditions of land profile are such as to require an excessively large traction cable the tramway is usually divided into two or more sections, each being a complete unit in itself. In such cases the carriers are detached from the traction cable and are transferred from one section to the other over an overhead rail connection. When rail stations are necessary the endless traction cable need not be cut but may continue through the station supported by rollers or sheaves secured to the structure.

An aerial tramway does not always require power for the operation of the traction cable as, when there is sufficient fall between the loading and discharge stations, the loaded carriers going down on one side will pull the empty carriers up on the opposite side. When it is necessary to have a driving gear, it should be placed at the terminal at the higher elevation. This gear usually consists of one or more grooved sheave wheels—around which the endless traction cable passes—attached to a vertical or a horizontal shaft and driven through a level gear and pinion by a steam engine or any other available power. The shaft of the sheave wheel at the opposite terminal station structure, and is then connected to the crosshead, horizontal guides. A suspended weight is attached to a chain or a rope which passes over a sheave fixed to the station structure, and is then connected to the crosshead, the weight thus maintaining a constant tension in the traction cable. When the loaded carriers travel down grade, and the resulting pull of the descending carriers exceeds that of the ascending ones, no power is necessary and the line works by force of gravity. The surplus power thus developed is absorbed and the travel of the load is controlled by suitable brakes operated by levers; by hydraulic controllers; or by air compressors.

To secure the best results from the cable tramway system in handling loose materials in buckets, the material to be transported should be brought to the loading station and dumped into a small bin or hopper, from which it may be transferred to the tramway buckets. In cases where it is impracticable to load the material through a bin the buckets may be made detachable from the carriers and be taken to the material either on small cars, or on wheels attached directly to the buckets. Another method sometimes used is to detach the buckets from the traction cable and to run them to the desired point on shunt rails leading from the terminal.

Carriers

The carriers from which the material handling devices are suspended travel over the track cables, being moved by a friction-grip and the endless traction cable which is placed below the track cables and passes around sheaves at the terminals. These carriers are distributed on the track cable at regular intervals, according to the quantity of material to be transported. Usually they move in a circuit between the loading and discharge terminal stations, the loaded one always traveling on one side of the line, while the empties return on the parallel cable on the opposite side. The carriers are equipped with material

handling accessories made in various designs to suit the particular class of material to be transported. Bucket carriers which are used for ore, coal, and similar materials are usually of the self-dumping turnover type and are made in capacities ranging from 4 cu. ft. to 20 cu. ft., the capacity depending upon the weight of the material and the tonnage it is desired to transport. Various other devices, such as slings, grab-hooks, tongs, and grapples, are also used to handle stone, lumber, logs, etc. Tanks for carrying liquids have also been used in some localities.

The Friction-Grip

The friction-grip system of attaching or detaching the carriers is largely used on aerial tramways of the continuous double-cable type. The friction-grip, which is secured to the hanger of the carrier, is provided with movable jaws for gripping the traction cable, the jaws being opened and closed by a lever arm. The grip mechanism consists of a short shaft on which are cut both coarse and fine pitch threads or opposite leads. This shaft passes through the two movable jaws which have corresponding threads and this forms the clamp by which the traction cable is gripped. The shaft also passes through a bearing on the carrier and on one end of the shaft is keyed a double lever which at its upper end carries a disk-shaped weight, free to revolve on a pin.

In the operation of this device a downward movement of the lever causes the shaft to revolve and the coarse thread engages the inner jaw. This closes the clamp until both jaws are in contact with the rope when the effect of the coarse thread on the inner jaw ceases. The further turning of the shaft by downward pressure on the lever causes the outer jaw with the fine thread to continue its motion and thus clamp the cable tightly.

An important feature of this type of grip is that it automatically adjusts itself to any variation in the diameter of the traction cable due to wear or to splices. As the rope wears, the lever arm turns farther around on the fine thread, thereby bringing the gripping jaws close together. Thus from a position of the lever arm at 25 deg. above the horizontal, to a position at 25 deg. below, a wear of approximately 1/16 in. in the diameter of the traction cable can be taken up. When the wear on the cable has progressed so that the attaching lever arm reaches a position of more than 25 deg. below the horizontal, it can again be thrown up into the initial adjustment by the use of an adjusting nut. In this way, a wear of 3/8 in. or more may be taken up without difficulty and without changing any of the parts in the grip.

To place a carrier in service it is brought to the attaching point in the terminal station where a slight dip or incline in the station rail serves to accelerate the movement of the carrier to approximately the same rate of speed as the traction cable and also to bring the cable into position between the friction-grip jaws when the carrier reaches the lowest point in the rail. Simultaneously the revolving weight on the lever arm of the friction-grip rolls up an inclined guide until the operating lever assumes a vertical position and the grip jaws are closed on the cable. The action of the coarse thread on the shaft or spindle of the grip then ceases and the actual gripping power is exerted by the fine threads as the lower end of the grip lever strikes a stop and completes the lever movement.

In the operation of the friction-grip system it is necessary to detach the carriers from the traction cable at both the loading and discharge terminal stations and this is done by a detaching device, located near the front of the terminal. As a carrier enters the loading station, it passes from the

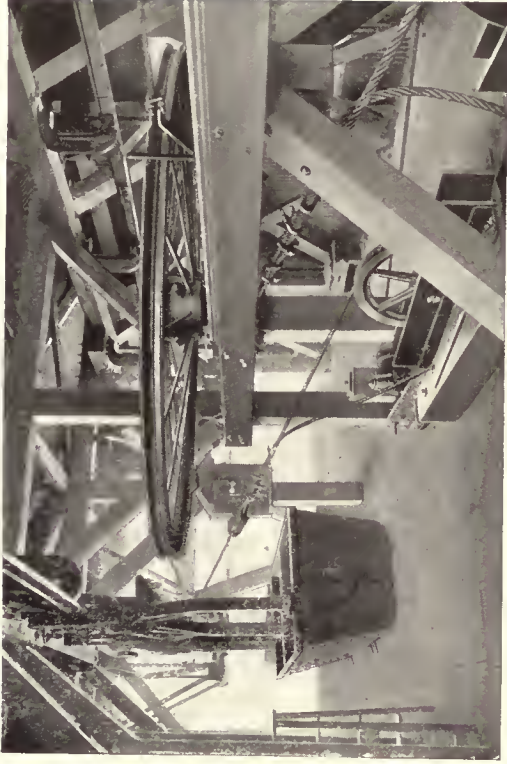

Cable Tramway—Discharge Terminal



Cable Tramway—Rail or Break-Over Station



Cable Tramway—Tension Station



Cable Tramway—Loading Terminal

stationary track cable to the track rail, where the detaching device engages the roller on the lever arm, pushing up the lever and automatically detaching the grip from the traction cable. Usually the carrier, by its own momentum, will continue to the loading point but if the distance is too great it may be pushed by hand.

The compression type of grip is also extensively used on aerial tramways. This device is designed so that when the carrier is pushed down the rail incline at the attaching point a roller on the grip lever-arm is brought into contact with an attaching guide. This guide pushes the lever downward as the carrier moves forward and causes a gradually increasing compression of the grip jaws on the traction rope. After passing out of the attaching device, the lever arm remains locked until the roller comes in contact with the detaching device at the discharge terminal or at the loading terminal after making a complete circuit through the discharge terminal. The detaching device causes an upward movement of the grip lever-arm and thus releases the jaws from the traction rope. The carrier may then be removed for loading if desired.

On some tramways, in order to secure necessary clearances, it is desirable to place the traction rope above the track cable and in such cases an overhead type of compression grip is used. This device is an integral part of the carrier, the weight of which automatically acts as the gripping force and clamps the grip jaws on the traction rope. An underhung modification of this type of grip is also used. Like the overhead type its operation is dependent on the weight of the carrier from which it is suspended.

Terminal Stations

At the terminal stations, which are located at each end of the tramway, the track cables are connected by an overhead rail which forms a terminal loop, and over which the carriers travel when passing through the station. This rail is supported about 7 ft. to 9 ft. above the terminal floor to permit sufficient headroom for free movement underneath and it is arranged to co-ordinate with the terminal arrangements consisting of switches, crossings, rail-shunts and rail extensions. Some form of receiving hopper or bin is usually built in the loading terminal. For loading ore, coal, sand, and similar materials, these bins are ordinarily fitted with under-cut chutes, which allow the material to pass directly into the buckets. At the discharge or unloading terminal the cables pass around large sheave wheels but, as at the loading terminal, the carriers pass from the cable to a rigid rail. For handling material with buckets a discharge hopper is usually built into this terminal and the dumping device is so located that the material may be discharged directly into the hopper. The loading and unloading of miscellaneous goods and material is performed by hand.

When it is desired to dump ore, sand, stone, refuse, tailings or similar materials at a point between the terminal stations a tripping-frame is attached to the track cable at the desired dumping point. This device may be moved to any point along the line and automatically unlatches the buckets while they continue in motion. In such cases, the terminal station at the far end may be built to allow the carriers to pass around the large horizontal sheave and return to the loading station without being detached from the traction cable.

When desired, intermediate loading or discharge stations, may be installed at one or more places along the line, without in any way affecting the operation of the

tramway. In this manner the products of other mines or manufacturers may be handled to advantage.

Limited Service Tramways

The larger types of tramways usually are equipped with a number of carriers which are designed to carry any of the various types of slings, hooks, or grapples, or automatic grab-buckets, bottom-dump buckets or turnover buckets. However, for a somewhat limited service smaller tramways are often equipped with the two parallel track cables but with only two buckets; or with a single track cable and a single bucket. Where the incline is sufficient and the carriers are loaded only on the downward trip these tramways may be operated by gravity alone, but, to permit service in either direction a power plant is required.

Two-Bucket System

The two-bucket tramway system, as the name implies, consists of two buckets suspended on carriers operating back and forth upon separate parallel stationary track cables. They are operated and controlled by the endless traction rope and are spaced so that when the bucket on one side of the line is at the loading station, the second bucket on the opposite side will be at the discharge station.

When the fall or incline of the tramway cable is sufficient, the two-bucket system will operate by gravity, the loaded bucket going down on one side pulling the empty bucket back up to the loading point. When power is required to operate the tramway it can readily be applied at the loading station in the form of a gasoline or a steam engine, or an electric motor.

The two-bucket system is especially adapted to the transportation of ore, sand, gravel, clay and similar materials. It also is an economical method of disposing of waste rock, coal slack, earth, etc., the buckets being dumped automatically while in the air by aerial trips. Owing to the fact that there are only two buckets in transit this system is somewhat limited as to capacity, which is inversely proportional to the length of haul required.

In a typical installation at the plant of a brick manufacturing company two tramways of the two-bucket type are used for transporting sand from the bank to the plant. One of these tramways is 1,400 ft. in length and has a capacity of 20 tons per hour. The other is 500 ft. long with a capacity of 35 tons per hour. At the loading stations wheeled scrapers are used to bring the sand to the loading bin from which the tramway buckets are filled. At the discharge stations the buckets are tripped automatically and the sand is dumped into a bin from which it is taken for use in the plant.

A special application of the two-bucket system is in use at the plant of another brick company. The buckets on this tramway are made detachable from the hangers and are equipped with wheels. At the loading station they are detached and run out into clay pits, where they are loaded by a steam shovel. At the discharge end the buckets are not detached, the clay being automatically dumped on the floor in front of the dry pans. This type of tramway requires a number of extra buckets in order to have a supply in the pit while others are in transit.

In another installation, a two-bucket gravity tramway 900 ft. in length is used to bring coal down from the mine to the tipples at the railroad tracks. This tramway has a fall of 430 ft. between the loading and discharge stations and one intermediate supporting tower is used. It has a capacity of 45 to 50 tons per hour. The coal is brought



Cable Tramway—Breakover or Rail Station

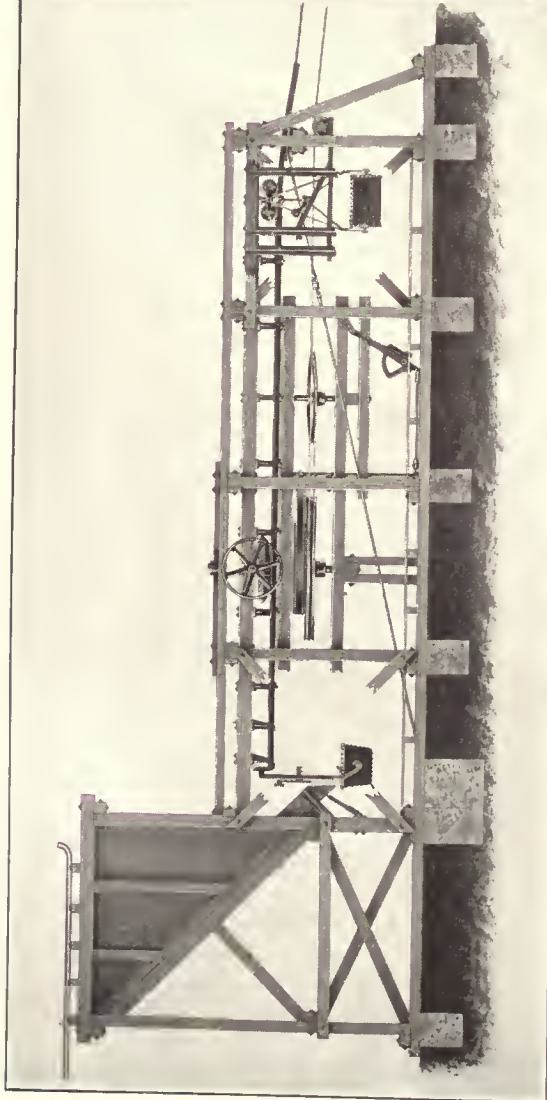

Cable Tramway—Loading Terminal



Cable Tramway—Discharge Terminal

Cable Tramway—Intermediate Anchorage and Tension Station

in cars from the mine to the loading station of the tramway, where it is weighed and transferred into a hopper and then into the tramway buckets to be carried down the mountainside and discharge into shaker screens located at the tippel.

Single Bucket System

The single bucket system is a modification of the two-bucket system. But one bucket is used, which operates back and forth on a single stationary track cable and is controlled by the endless traction cable. Power is necessary for the operation of this type of tramway and may be supplied by a steam or gasoline engine or may be obtained from an electric power line.

The capacity of this type of tramway is considerably less than the two-bucket system.

In another type of single-rope tramway, one rope serves as both the load carrying and the traction cable, the carriers being attached to the rope at intervals as it moves continuously in one direction. The cable passes around the large sheaves in the terminal stations and thus the loaded carriers pass in at one side and the empty carriers out at the other. These tramways are adapted only to light service.

Many single-rope tramways—sometimes double-rope also—are of the reversible type, the direction of travel being reversed each time a trip is made from terminal to terminal.

Double-Cable Tramway

Another type of cable tramway is provided with two parallel track cables which rest on pivoted saddles secured to the supporting towers and form an upper and a lower two-cable track. In this type of tramway the load is carried in a small 4-wheel car mounted on the track cables and drawn by a traction cable secured to the car and to the drum of a winch. The material to be handled is first dumped into a bin from which it passes to a traveling hopper mounted on the tramway. It is then discharged into the car, the hopper traveling with the car until the loading operation is completed. The loaded car is hauled on the upper track and the material is dumped at the end of the tramway as the car passes around a large drum. The return trip to the loading point is made on the lower track with the car in an inverted position. At the loading

point the car again passes around a drum and comes to the loading position.

Stacking Tramway

A stacking type of tramway has been developed for use in disposing of waste products where the available piling space is limited. They are used chiefly in mining and metallurgical operations where the percentage of waste is very high and a very wide area would otherwise be required for a dumping ground.

This type of tramway consists of an inclined bridge which is constructed of two parallel trusses connected with cross members at the upper and lower ends. This leaves the space between the trusses free for the installation of a cable tramway of the endless-rope type. The bridge itself is made in a number of short sections and as the waste heap grows, new sections built on the cantilever principle may be added and the tramway extended. The charging or loading station may be at the bottom or at an intermediate point on the bridge. The discharge terminal is at the upper end of the structure and as the bridge is extended by adding new sections, the terminal pulley is shifted to the end section. To facilitate the extension of the tramway, the upper pulley and rail section are built into a frame which is suspended from rollers running in guides rigidly connected to the girders. As each new section is added to the bridge, this pulley frame is advanced to the end, the cable tramway extended, and the operation of the apparatus continued as before.

Stacking tramways may be arranged to transport material to a considerable distance and stack it in piles ranging in height upward to about 300 feet. The cubic capacity depends upon the size of bucket used and the speed of operation and may reach 200 cu. yd. or more per day.

Suspended-Rail Tramway

Suspended-rail tramways are used for transporting materials in factories, warehouses or other places where a perfectly straight track may be placed. The track system consists of suspended rails which serve the same purpose as the track cable used in the cable type of tramway. The carriers are moved along the track by means of an endless traction rope to which they are secured by an automatic grip. The operation of this type of tramway is substantially the same as in other tramways.



Tramway Type of Ore Unloader

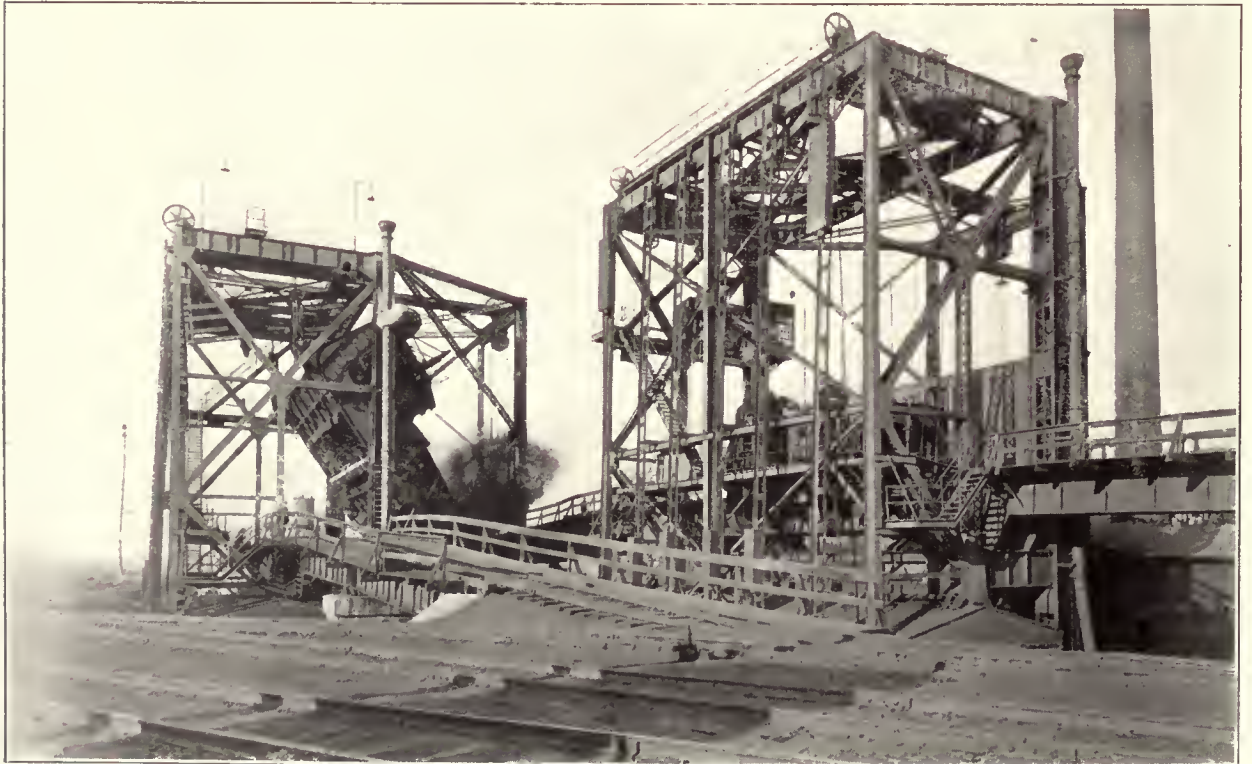

Lifting Type of Car Dumper

Loaders and Unloaders

IN THE LOADING AND UNLOADING of railroad cars and vessels the necessity for handling large quantities of bulk material more rapidly than is possible with ordinary hoisting apparatus has resulted in the development of many special types of machines each designed for a specific service. The most essential requirement of such apparatus is that it shall handle the material in a minimum of time so that the cars and vessels may be released for further service. Machines of this class have been adapted to handle coal, ore, sand and other loose materials; and for handling logs in lumbering operations. They may be divided into two general classes: one for loading and the other for unloading service.

Loaders

Loading machines are made in several different types, some being designed to handle the material by means of special attachments secured to a hoisting line or cable, while in other types the material itself, or the vehicle containing it, is handled by the main apparatus.

Log Loaders

Log loading machines of several different designs have been developed for handling rough logs in lumbering operations. These machines may be operated in conjunction with a logging cableway or with other logging apparatus. When properly equipped they are also adapted to short-haul log skidding and may be used in both skidding and loading service.

One type of log loader which is used quite extensively is designed to span the track on which it travels and permits the passage of cars underneath it. In this type of apparatus the operating machinery is carried on a raised platform supported on side legs or standards which span the track. These legs are curved in at the base and terminate in a heavy steel foot casting which rests on the ties outside of the rails. In order to secure a substantial foundation these shoes are sufficiently long to permit them to rest on several ties at the same time. The shoes are flexibly attached to the foot castings and automatically adjust themselves to any unevenness of the ties. This machine is equipped with trucks having swinging wheel-frames and, by means of sprockets and chains, is driven by the engine carried on the loader platform. The wheel-frames with their propelling chains are drawn up under the loading platform when the machine is at rest, thus leaving a clear track between the legs. When it is desired to move the machine to the next loading place the frames are lowered until the wheels engage the track and the side legs are then raised until the shoes are high enough to clear the top of the rail.

This type of machine is moved under its own power and pulls the empty cars behind it. When in the desired location for log loading the trucks are raised to permit the passage of the empties and the car spotting-line is carried back and made fast to the rear end car. Then as required each car is drawn forward through the machine into a position

below the boom, and, when loaded is pushed out of the way by the next empty. When the loading of the entire train is finished, the loader stands at the rear of the train and then if it is not convenient for a locomotive to come in, the loader may be used to push the train out on the main line.

This type of loader may be operated with a crew of only 3 men and with such a crew sometimes will handle from 120,000 ft. to 130,000 ft. of logs in a day. However, a crew of 4 or 5 men will insure greater efficiency. The capacity of a log loader depends upon the size and supply of logs but under favorable conditions a single loader may sometimes load 300,000 ft. in a day.

In another type of log loader the trucks on which it is mounted are fixed and carry a track laid on top of the truck frames. The machinery platform is raised to a given sufficient height to permit the log cars to pass through the machines. Inclined sections of track connect the raised track

with the fixed railroad track and the cars are then drawn up and through to the front of the machine and loaded.

The operation of this type of machine is substantially the same as with the swinging-truck type.

Loader Used as Skidder

Where conditions do not warrant the use of an independent machine for bringing logs to the track, a log loader may be equipped for skidding work also. For such service provision should be made to guy the boom to stumps beside the track and extra drums, blocks and cables should be provided. It usually is not necessary to guy the boom for loading service nor for skidding logs short distances up to about 150 ft. but, when working at longer ranges, the guys should always be used. One or two skidding lines may be used depending on the capacity desired, and they are usually outhauled by horses or mules, the skidding tongs being taken direct to the log. In rough or swampy country which would hinder the movement of animals, or where logs have been collected at some distance from the track a single line may be used for skidding and the other winch drum used to operate a mechanical outhaul. The logs may be loaded direct to waiting cars with the skidding line or with a separate loading line if only one skidding line is in use; or they may be left beside the track for future.

Box Car Loaders

In loading a box car the material must be delivered through one of the side doors at the center of the car and then moved a distance of from 15 to 20 ft. into the ends of the car and piled to the proper height. To do this work expeditiously and economically several types of box car loaders—usually operated by electric power—have been developed. These may be divided into three classes:

1.—Conveyor loaders which convey the material to the ends of the car.

Loaders: Conveyor, Projecting and Tilting Types for Loose Bulk Materials; Log Skidders and Loaders.

Unloaders: Box Car—Scraper, Tilting, Suction; Car Dumpers—Tilting, Rotating; Mast and Gaff; Boston Tower; One-Man Tower; Hulett.



Steam-Operated Stump Puller for Clearing Cut-Over Land

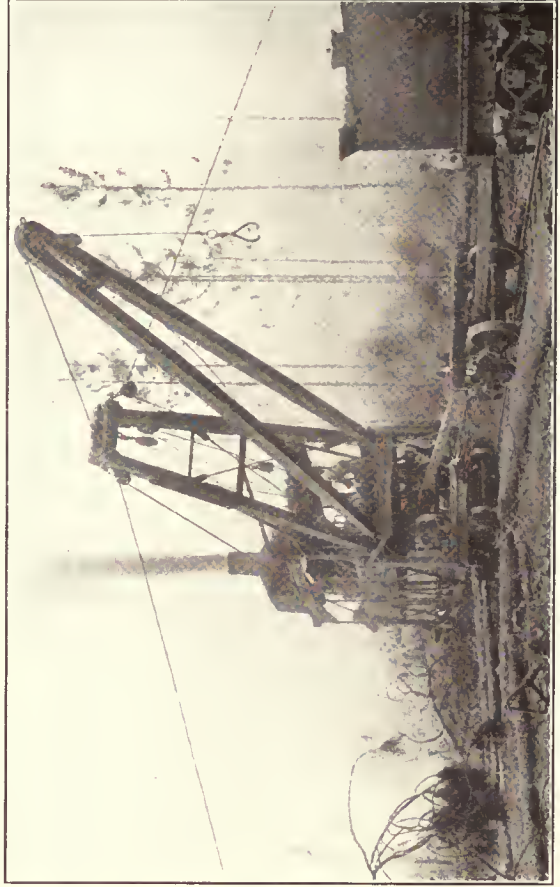

Logging Machine with Car Passing Through Into Loading Position



Log Loader with Train of Log Bunks Passing Through

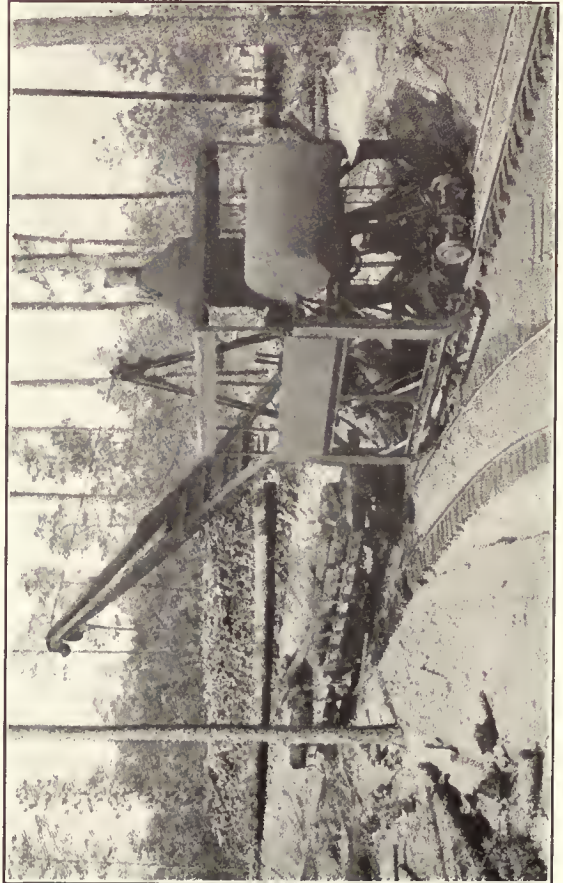

Rear View of Log Loader with Flat Cars in Loading Position

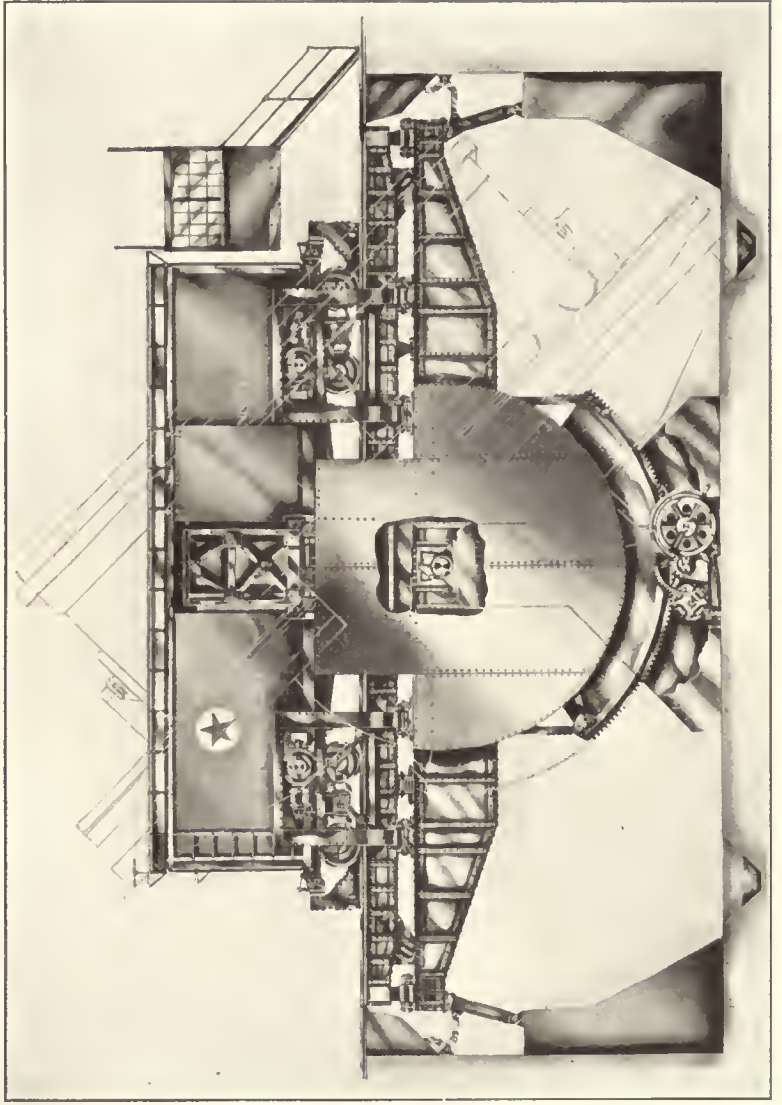
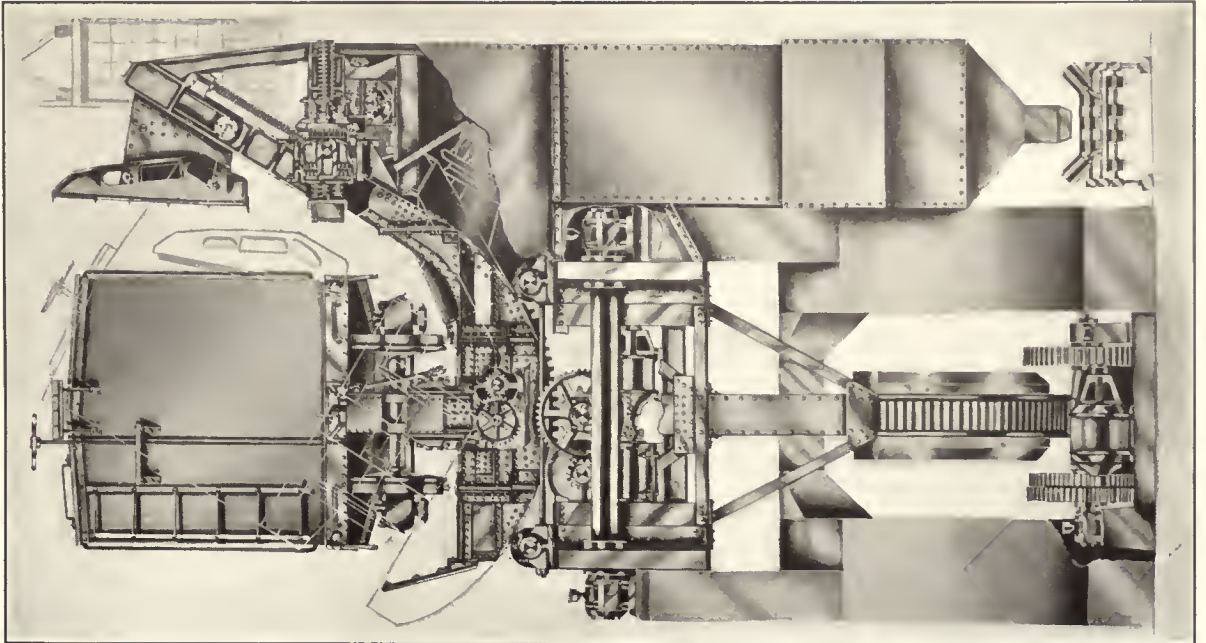
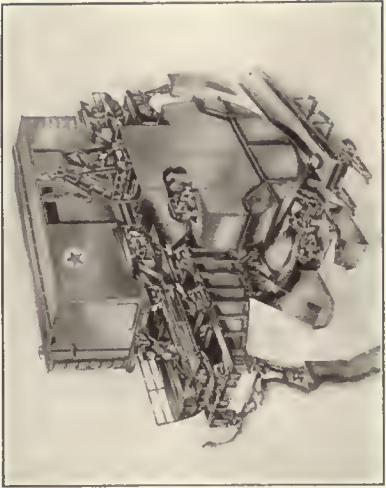
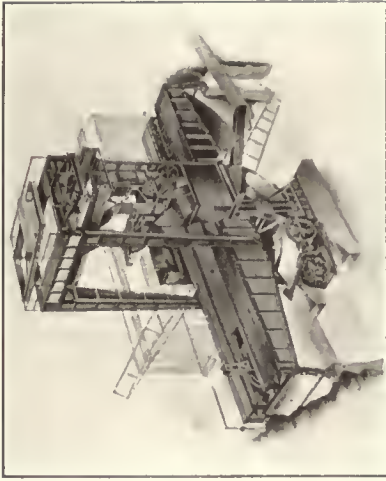

Longitudinal View of Tilting Box Car Unloader. Portal in Position at Upper Right

Cross Section of Tilting Box Car Unloader

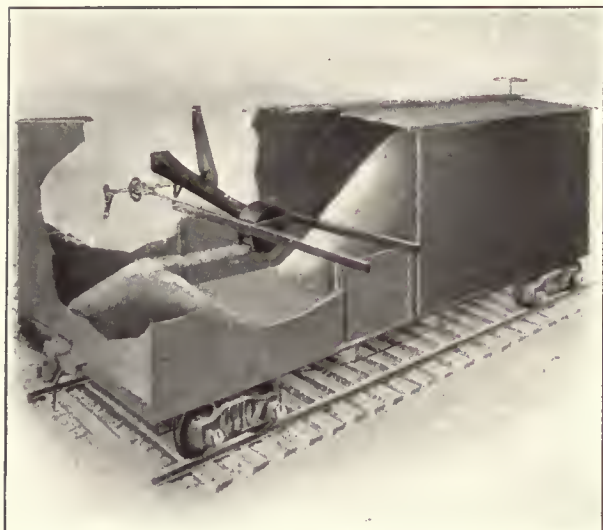

Single-Fan Box Car Loader

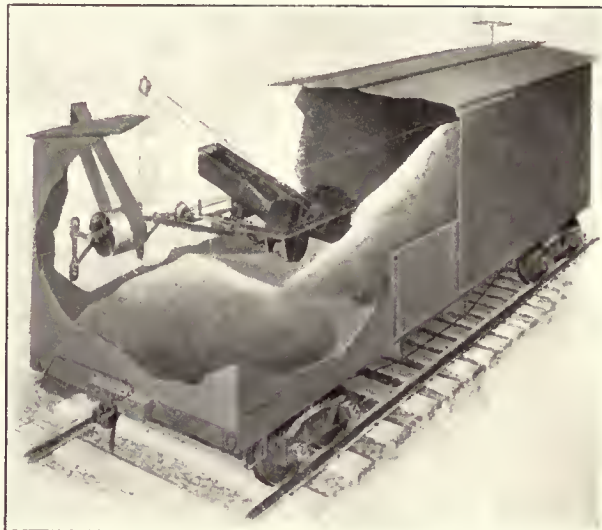

Two-Fan Box Car Loader

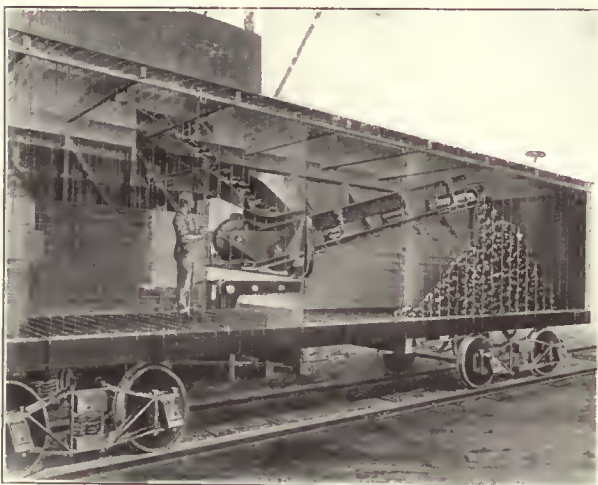

Belt Type Loader Fed by Extension Chute



Belt Loader Fed by Double Acting Chute



Belt Conveyor Box Car Loader



Tilting Box Car Loader

2.—Projecting loaders which project or throw the material into the ends of the car by means of rapidly moving conveyors or other apparatus.

3.—Tilting loaders which tilt the car endwise so that the material may be delivered to the ends of the car by gravity.

Conveyor Type

The simplest type of box car loader consists of a small portable belt conveyor which is placed in the car close to the door in a position to receive the material from the chute of a bin or from another conveyor. This is a semi-projecting type of machine as the conveyor belts are operated at high speed—usually 500 ft. to 1,200 ft. per min.—and, being inclined somewhat, discharge the material upward at a considerable angle throwing it back into the car ends. To handle light material, such as grain, cleats are secured to the conveyor belt and guards are provided to prevent the material from spilling off the sides. For lumpy or abrasive materials, such as lime, and coke, the belt is armored with steel plates placed at close intervals on the belt and having the edges bent up to prevent loss of material. For sticky materials, such as fertilizer, plain flat belts are used, the material being confined to a narrow stream in the center of the belt which prevents it from getting on the conveyor frame and hardening and thus interfering with the operation of the apparatus. A loader of this type having a reach of about 12 ft. from the center of the car towards the end and a 16 in. belt should handle about 3 tons of coal per min.; one with a 24 in. belt about 5 tons per min.

Box car loaders of the apron conveyor type are also used. They are mounted on jointed arms arranged in such a way that the machine may be easily moved through the door of the box car and extended back into the ends. These machines are not designed to throw the material but actually carry it into the car and therefore the belt speeds are somewhat slower than in the projecting types of machines and ranging from 400 ft. to 800 ft. per min. A loader having a 24 in. apron conveyor has a maximum capacity of about 12 tons of coal per min. and will handle a similar volume of other materials, the tonnage depending upon the weight and the character of the material.

Conveyor loaders of the telescopic or extension type have been designed to extend back towards the ends of a car. Usually they are either of the belt or the drag-chain conveyor type, the reach of the machine, when fully extended, being about 18 ft. By using a conveyor long enough to carry the material practically the entire distance, instead of partly conveying and partly projecting it, lower conveyor speeds may be used, the usual speeds for extension machines ranging from 250 ft. to 500 ft. per min. The capacity of a loader of this type having a 20 in. belt is about 6 tons of coal per min. and for a 20 in. drag-chain conveyor loader about 10 tons of coal per min.

Projecting Type

Box car loaders of the projecting types distribute the material to the ends of the cars by means of rotating paddle wheels of fans enclosed within receiving chambers.

The paddle-wheel type of machine successfully loads sand, gravel, crushed stone, fertilizers and other small bulk materials. The material to be loaded is first spouted to a circular receiving chamber and is then discharged to either end of a car by revolving the paddle wheel in the chamber.

The fan types are made with either one or two receiving chambers. In the two-chamber machine the fans throw the material in opposite directions thus filling both ends of the

car at the same time. In the single-chamber machines, the fan is reversed to load the opposite ends of a car. The fan machines are particularly adaptable for handling grain and similar materials. The speed of the fans varies from 200 to 600 revolutions per minute, single machines having a capacity of from 600 to 2000 bushels per hour; the double machines from 3000 to 7000 bushels per hour.

Tilting Type

The tilting type of box car loader is designed so that the car is placed on a cradle, being held in place by stops at each end, the cradle rotated so as to tilt the car endwise, and the material then delivered by gravity through a chute direct to the ends of the car. This type of loader requires a more expensive structure and operating mechanism than the projecting and conveyor types of loaders and therefore should be installed only where large quantities of materials are handled.

Box Car Unloaders

The unloading of box cars is an expensive operation when done by hand and several different types of machines have been devised for performing this work more economically. They may be divided into three classes, as follows:

1.—Scraper type—using a power-operated scraper or hoe for scraping the material to the car door.

2.—Air suction type—the material being sucked into an air hose in the same manner as with a pneumatic sweeper.

3.—Car tilting type, in which the cars are tilted on a cradle so that the material will run out.

Scraper Type

The simplest form of the scraper type of unloader—usually called an automatic power shovel—consists of a scraper which is moved back into the car and pushed down into the material by manual labor and then pulled forward by a rope winding on a small drum or winch. The material is thus scraped along the car floor and is drawn through the door into a hopper underneath the car for future re-handling or to a conveyor or elevator for immediate disposal. The winding drum has a clutch arrangement which allows the rope to be unwound easily as the operator moves the shovel back into the pile, but, as soon as the pull on the rope ceases the clutch is automatically thrown in thus winding up the rope and pulling the shovel forward. These machines are used extensively for unloading grain, small sized coal, sand, and similar materials.

In a more recent design of the scraper type of box car unloader the use of manual labor for drawing the scraper through the material and back into the car has been eliminated. The scraper cable or rope is passed around sheaves mounted on the end of an adjustable arm which can be extended back into the ends of the car. Then, by pulling on the ropes by means of a power winch the scraper can be moved back and forth in the car. This arrangement makes it possible to haul the scraper into the ends of the car, and to scrape the material out, without the necessity of the operator going back into the car.

Suction Type

The suction types of box car unloaders are equipped with rotary fans which, by drawing the air out of an air tight bin or hopper, cause a vacuum which in turn creates a suction in a pipe attached to the bin and in a hose attached to the pipe. The hose which is provided with a special nozzle is then placed in the car and pushed into the mate-

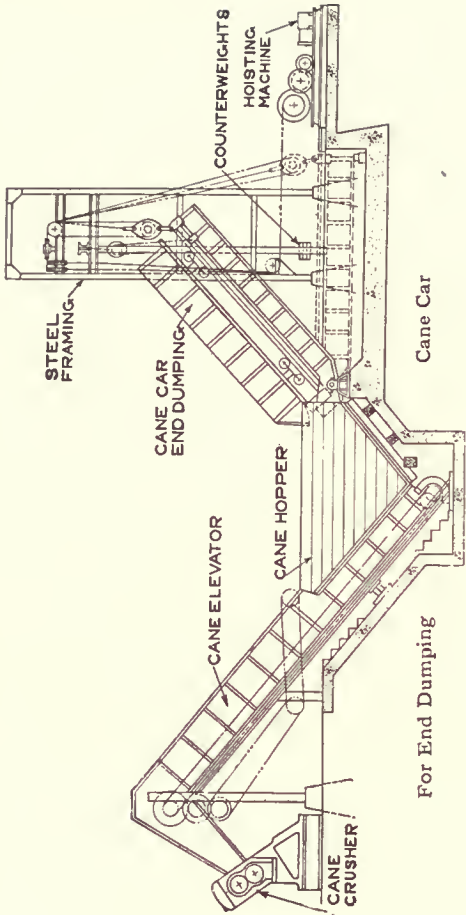

End Tipping Sugar Cane Car Dumper

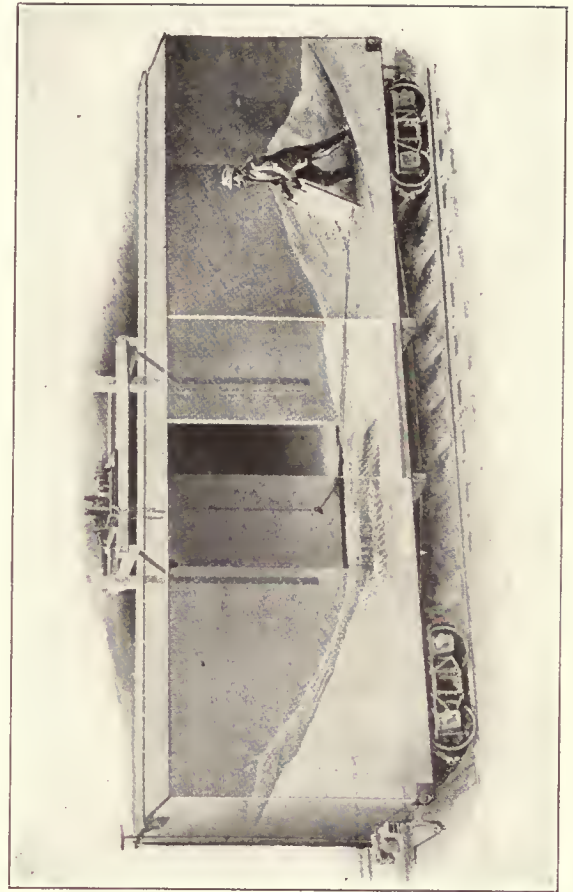

Automatic-Cable Scraper Box Car Unloader

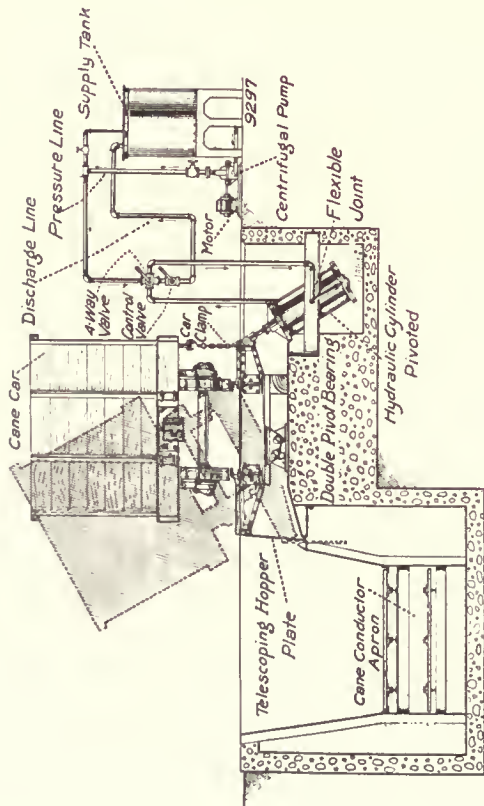

Side-Tipping Sugar Cane Car Dumper

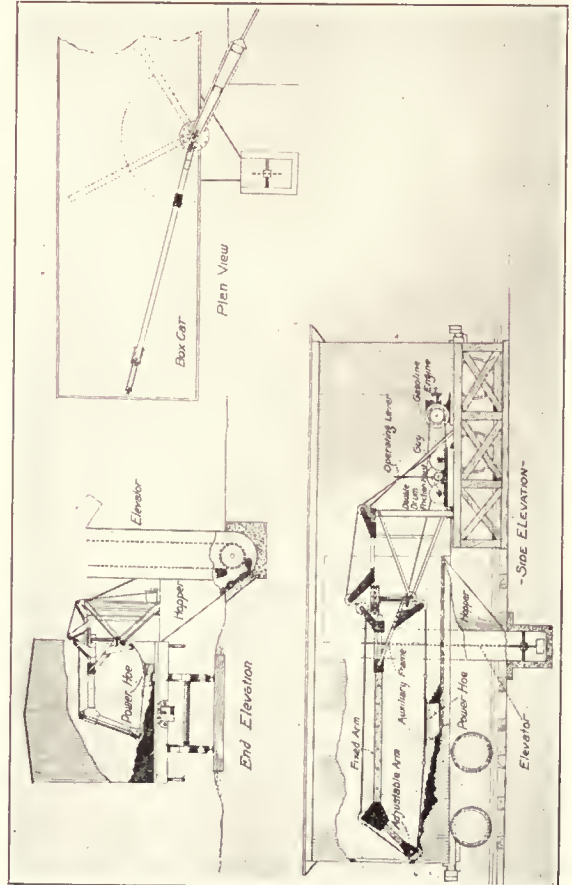

Adjustable-Arm Scraper Box Car Unloader

rial, which is sucked up into the hose and thence through the pipe to the hopper, where, because of the larger area of the hopper velocity of the air, is very much reduced and allows the material to fall into the bin. It may then be disposed of as desired by means of conveyors or other material handling apparatus.

Tilting Type

The difficulty of quickly unloading loose bulk materials from box cars has in the past been a limiting factor in the amount of grain and similar materials that could be handled from railroad cars to ships or elevator bins. Several different types of box car unloaders have been developed and are now used quite extensively in such service.

One type of box car unloader designed especially consists of an end tilting cradle which holds the car and tilts it endwise in either direction to an angle of about 40 deg.

In the operation of this machine the doors are opened and the car run on the unloader. A specially designed plow, operated by electric motors, is placed in the car with the point toward either end and the car then lifted or tilted endwise causing the material to flow over the point of the plow which deflects it to either side and discharges it through both doors of the car. The material is caught by chutes adjusted to suit the car doors and is delivered to conveyors located below the cradle at both sides. After the car has been tilted in one direction and the material in one end has run-out it is brought back to the horizontal position, the plow is reversed and the car then tilted in the opposite direction discharging the material in the other end.

The plow moving and turning mechanism is mounted on a portal gantry built in conjunction with the unloader and is controlled by means of electric motors mounted on the plow arm and the gantry. The overhanging weight of the plow is counterbalanced so that the operator, by means of a foot lever, is able to adjust it to suit the varying heights of car floors.

The entire load is emptied in two tiltings—one in each direction—and the time required for a complete cycle of operation makes it possible to unload from 6 to 8 cars per hour.

Four box car unloaders of a type designed to tip the car sidewise as well as endwise, are in use in a large grain elevator built by the Pennsylvania Railroad Company at Baltimore, Maryland. The grain elevator has a capacity of 5,000,000 bushels and the four unloaders, have a combined capacity of 320 cars in 8 hours, or 40 cars per hour.

Each movement of the unloader is controlled by an individual motor arranged so that when it performs the service for which it was designed it automatically stops and connects the motor for the next operation. The unloader discharge to conveyor belts which in turn carry the grain to the headhouse.

When operating these unloaders to their full capacity cars are received simultaneously over 4 tracks, each leading to an unloader and there is sufficient space to allow 16 loaded cars to be placed on each of the tracks. The cars are passed through the unloader without the use of a switch engine each track being equipped with a "barney" or pusher—controlled by heavy endless cables—which pushes the cars back and forth as may be desired. The cars are pushed to the middle of the unloader by the "barney" and anchored on the cradle by clamps which engage the couplers at the ends of the car. These clamps are so arranged that they will firmly engage the couplers

of a car of any length and, when not in use, they drop down below the level of the rails out of the way. When the end clamps have exerted a predetermined pressure, the power is automatically cut off and the motors controlling the side supports are set in operation. These side supports move up against the side and sill of the car on the receiving sink side, and they also, when they have exerted a predetermined pressure, automatically throw off the power and start the motor for the next operation.

The operator is stationed in a glass house built on the unloader just above the side of the car and has a good view of the work at every stage of the operation. Another man is required to uncouple the cars and to operate an air hose which thoroughly cleans out the car.

Cane Car Dumpers

Car dumpers of the tilting types are used extensively in the sugar cane industry for dumping the cane from the cars at the mills. These machines consist of some form of movable platform on which the car is placed and then tilted, thus discharging the sugar cane into a hopper from which it is carried into the mill by conveyors or elevators. They are made in either the end-dumping or side-dumping types and usually are operated by hydraulic pressure acting on a plunger connected to the platform lifting mechanism. These loaders are designed to handle cars having a capacity up to about 30 tons of sugar cane.

Car Dumpers

Car dumpers are used chiefly for unloading open-top railroad cars by overturning them and dumping the material into a chute which carries it to a boat, a bin, to a storage yard, or in some cases to a transfer car which disposes of it at some other point. This class of machine is made in several different types and is used largely on coal docks for coaling vessels; at blast furnaces for unloading ore; and at coke ovens for discharging coal from cars into bins. The general principle of this type of apparatus has also been adapted to dumpers designed especially for unloading grain cars, of the closed-top, side-hopper type and for dumping sugar cane from cars of the open-top rack type commonly used in the sugar industry. They are made in both the lifting or tilting type which is generally a stationary machine; and the rotating or turnover type which may be stationary, or of the movable type—usually self-propelled.

The general form of construction consists of a structural steel frame supporting a cradle in which the loaded railroad car is held while the contents are discharged. An automatic clamping device holds the car in the cradle which is rotated by dumping mechanism installed on the frame and either tilts the car sidewise or completely overturns it and discharges the contents into a chute. These machines may be operated by either steam or electric power, the latter being in more general use.

Tandem Car Dumper

A tandem car dumper of the tilting type is in use at the coal handling pier of the Virginian Railway at Sewall's Point, Virginia. The pier equipment also includes six 120-ton hopper-bottom motor transfer cars and a transfer car elevator. This machine will handle two cars of any capacity up to 60 tons each—hence the name "tandem"—or one car having a capacity of more than 60 tons and upward to 120 tons each.



Tandem Car-Dumper with Two Cars in Dumping Position

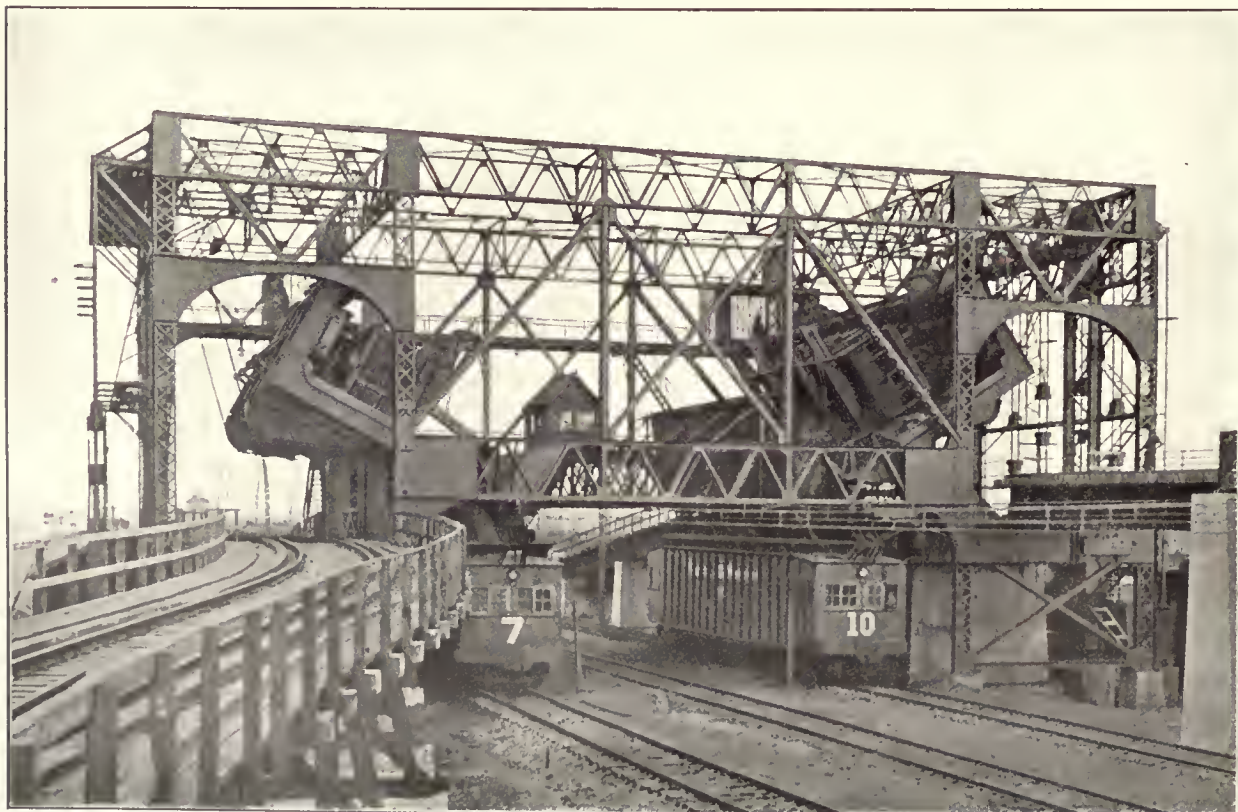

Double Car-Dumper with Two Cars in Dumping Position

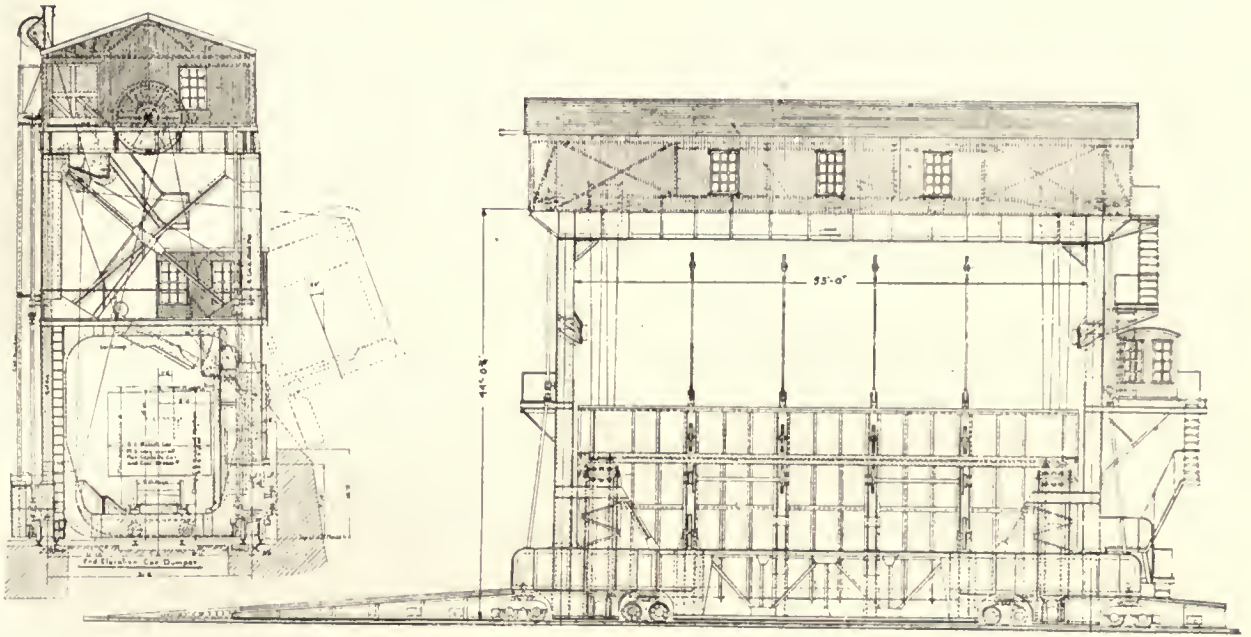

Movable Car Dumper with Portable Inclined Rail Sections

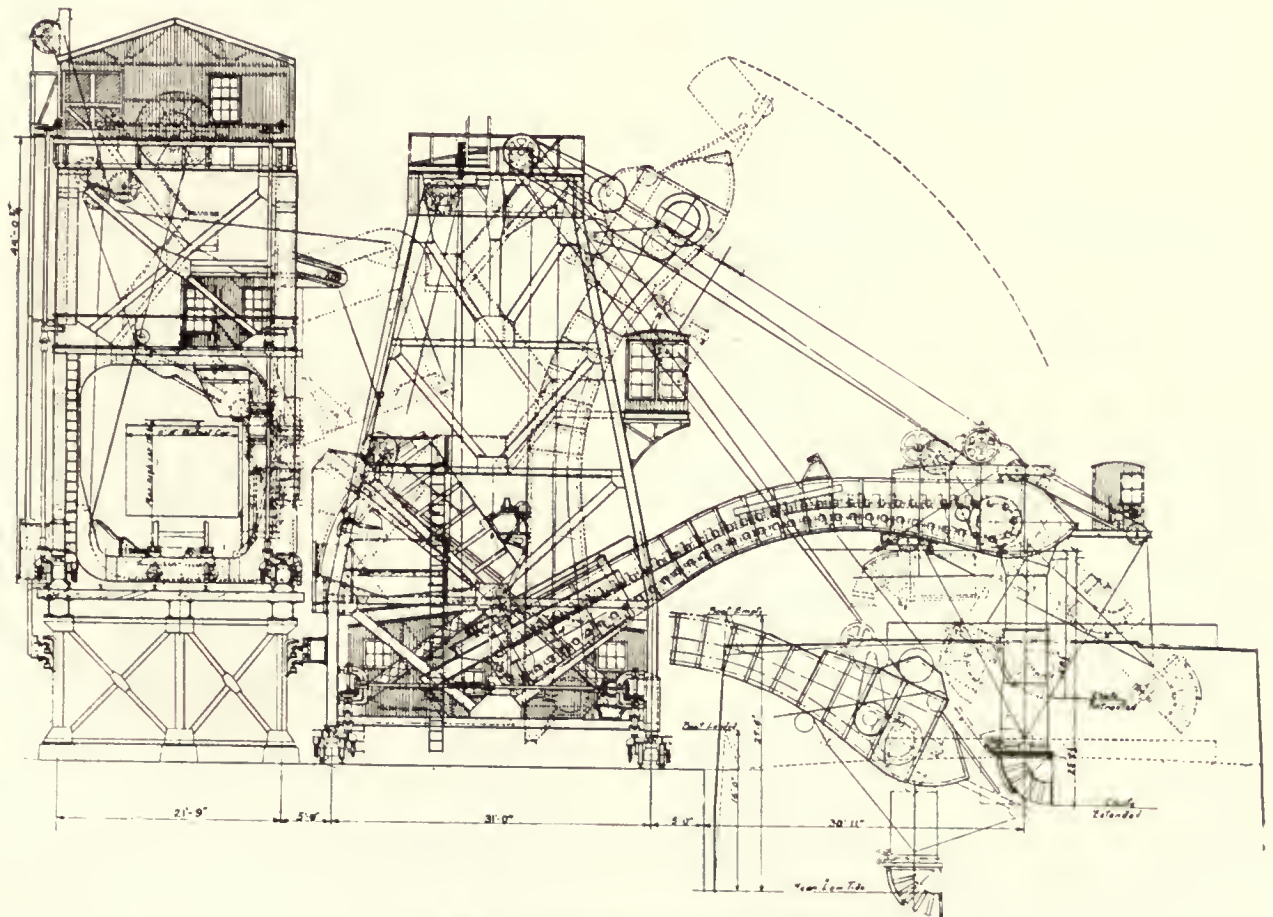

Combined Movable Car-Dumper and Coal Loading Tower

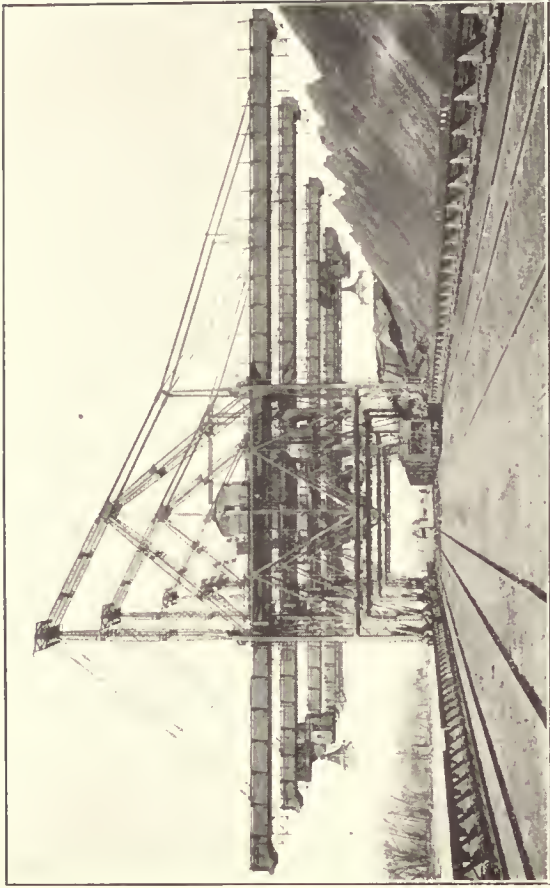

Battery of Unloaders of the Traveling Cantilever Gantry Type

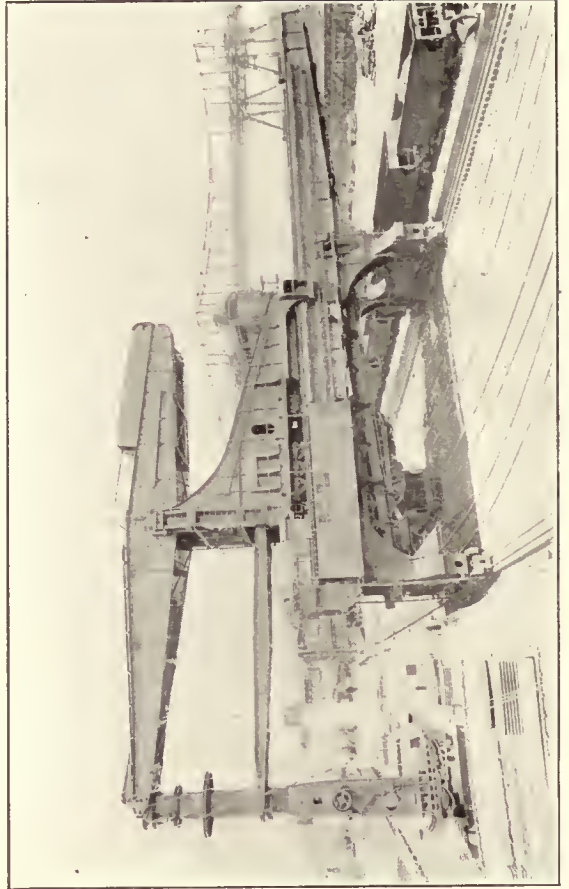

Hullett Type of Ore Unloader with Bucket Entering Hatch of Vessel



Mast and Gaff Unloader Handling Automatic Grab Bucket



Hold of Vessel Showing Hullett Unloaders at Work

The dumper consists of a main frame which supports a rotating cradle in which the cars are held while being dumped. The cradle is carried on heavy pivots supported in frames built into the main frame and is rotated by machinery located on top of the main structure. The cars are held in place on the cradle while dumping by eight automatic clamps operated by means of counterweights which travel in guides at the rear of the machine. These clamps are automatically adjustable to any height or width of standard railway car and are placed so that they will engage cars of various lengths. They are arranged symmetrically each side of the center line and may be operated independently of each other. Each clamp consists of a steel beam hinged to a sliding casting on the dumping side of the cradle. The opposite end of the beam is suspended in operating cables attached to the counterweights. As the cradle rotates, the sliding casting descends and rests on the top flange on one side of the car. Then as the movement continues the beam swings downward until its free end engages the opposite top flange thus holding the car firmly in place on the cradle. Cradle counterweights, operating in a similar manner, are attached directly to the cradle and, together with the clamp counterweights, assist the motors in rotating the cradle.

In the operation of this machine the loaded cars are pushed on the dumper cradle by an electric pusher-car called a "mule." The contents are then dumped down a chute to the transfer car which is then run on the elevator, raised to the upper track level on the pier, and, then under its own power, run out on the pier, where the contents are dropped through the car hopper into the loading pockets. The coal may then be discharged through chutes into vessels lying alongside the pier. After the transfer car has been emptied it is run to the end of the pier and switched to a return track located in the center of the pier on which it runs down a grade of about $2\frac{1}{2}$ per cent to the yard level. It is then switched back to the loading track which passes in front of the car dumper and is ready for another trip.

Hulett Unloader

An automatic type of unloader—generally known as the Hulett—has been widely adapted to unloading ore from vessels and conveying it to railroad cars for further transportation or for placing it in storage. It may also be used for unloading other loose materials such as coal, crushed stone, and gravel. This machine consists of a main framework, similar to a crane bridge, mounted on trucks which travel on a runway laid on the wharf; a trolley which traverses the bridge; a balanced walking-beam carried on the trolley; and a bucket of the grab type secured to the lower end of a rigid leg pendant from the outer end of the walking-beam. The bucket is moved vertically by the action of the walking-beam and horizontally by traversing the trolley on the bridge. It is arranged so that it may be rotated in a complete circle which permits it to turn in any direction to gather a load. The bucket operating mechanism is installed in the vertical leg on which it is suspended and the operator is located just above the bucket in a cab built within the leg structure.

In the operation of the machine it is moved to a position opposite one of the hatches of a vessel and the bucket is then lowered through the hatch. After filling the bucket, it is hoisted by means of the walking-beam hoisting mechanism which is installed in a machinery house on the rear end of the beam where it also serves as a counter-balance. The trolley is then traveled back on the bridge

so that the bucket is brought over a hopper located between the girders in the main framework, the contents discharged into the hopper and the bucket then returned to the boat for another load. Meanwhile the ore in the hopper is discharged into a larry which has been brought to a point underneath the discharge gates of the hopper. When the larry is filled it is moved along the bridge to the desired point and the gates of the larry hopper are opened discharging the ore into a railroad car or, if a car is not available, the larry is moved to the rear cantilever of the bridge and its contents discharged into a temporary storage pile. Usually the material is reclaimed from this pile for shipment or other storage by means of an ore bridge, located at the rear of the unloader. The larry hopper is equipped with scales so that the material may be weighed as it passes through. Thus an accurate record may be kept of the amount of material loaded into a car and makes it possible to dispense with the use of track scales.

Two operators are required for one of these machines. One operator is stationed in the bucket leg directly over the bucket shell and controls the raising and lowering of the bucket; the travel of the trolley; and the movements of the machine from one hatch to another. The other operator is stationed in a cab on the larry and controls the movement of the larry; the operation of the larry gates; and the weighing of the ore.

Unloading machines of this type are equipped with buckets ranging upward to 15 tons in capacity and they will handle from 500 to 1000 tons of ore per hour.

Boston Tower

The Boston or two-man tower unloader is used at wharfs for unloading coal or similar materials. It consists of a tower of steel or wood, carrying a boom on which travels a trolley from which is suspended an automatic grab-bucket. The bucket closing line passes over a sheave on the trolley then over a sheave at the head of the tower and is then attached to one of the drums of a winch installed on the tower. The bucket holding line passes over a sheave on the trolley, thence over a sheave at the head of the tower and is then attached to a drum on the winch.

In the operation of this machine, after the bucket is closed and raised by the closing and holding lines, the trolley rope is slacked off allowing the bucket to run in over the hopper. After the load is dumped the bucket is hauled out by the trolley rope and is again lowered into the vessel. Two operators are required, one operator controlling the opening and closing and the raising and lowering movements of the bucket, the other controlling the movement of the trolley on the boom.

Unloaders of this type have a capacity of from 75 to 300 tons per hour, depending on size of bucket which ranges in capacity upward to about 2 cu. yd.

One-Man Unloaders

The one-man type of tower unloader is used chiefly for unloading coal, ore, etc., from vessels. This machine consists of a steel-frame tower having a hinged boom carrying a hoisting unit of the man-trolley type which may be moved along the boom. The trolley carries the drums, motors and controllers required to operate a grab bucket and also the operator. The boom may be raised to clear the masts of vessels, alongside the wharf. After the bucket has been filled and hoisted, the trolley is moved along the boom and the material is discharged into a hopper. From the hopper

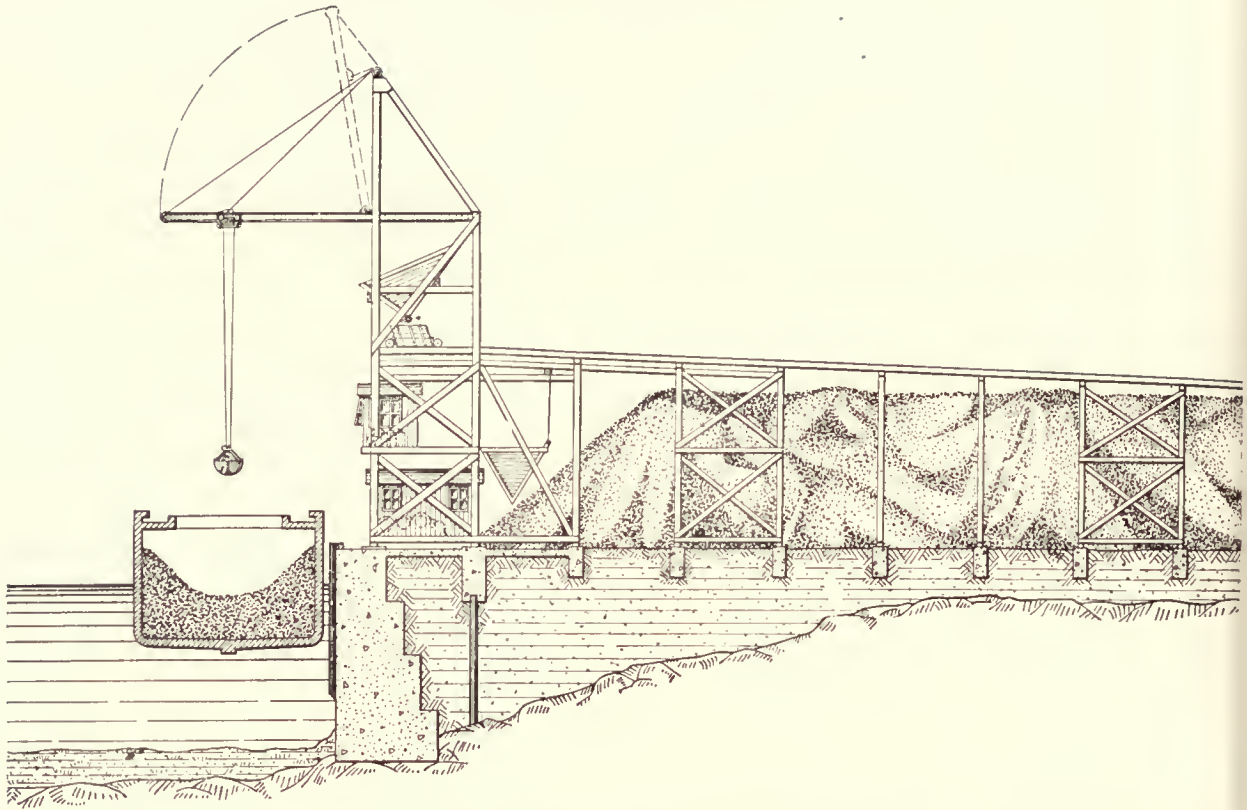

Coal Hoisting Tower Unloading from Vessel to Storage



Handling and Cleaning Tower with Conveyor



Coal Handling Tower at Power Plant

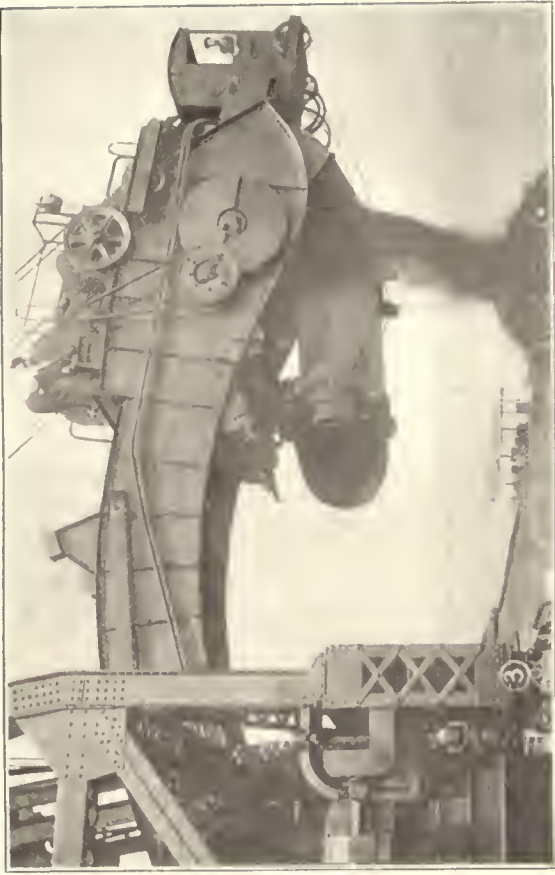

Discharge Nozzle of Coal Dumper and Vessel Loader

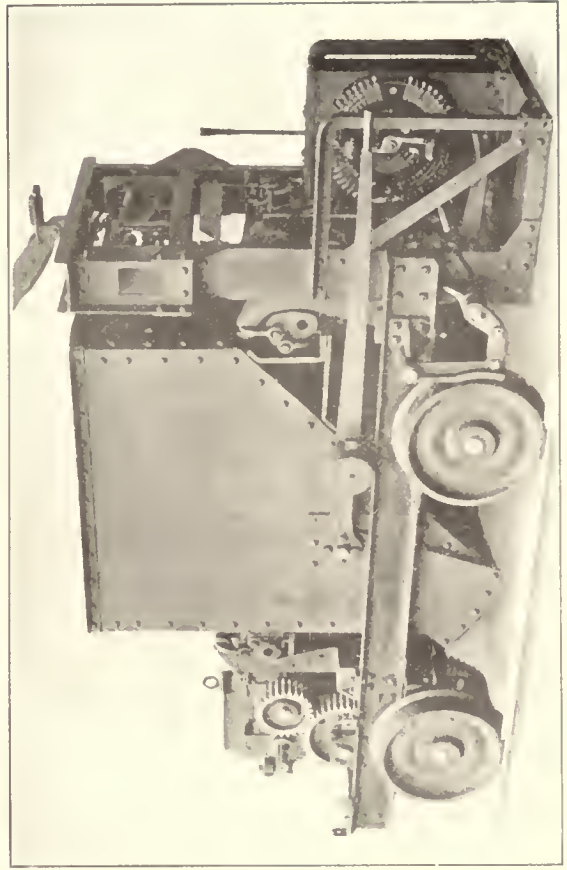

Traveling Weighing Lorry for Use on Hulett Type of Ore Unloader

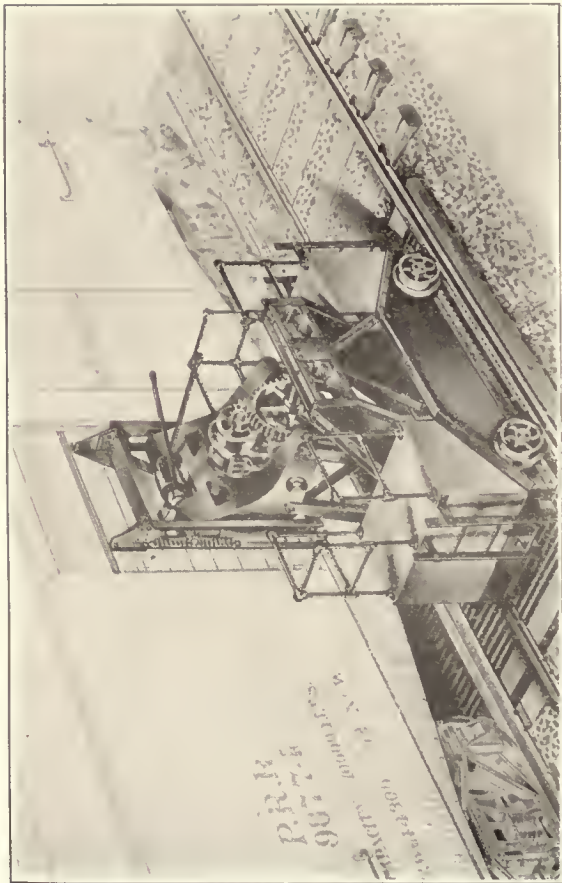

Self-Propelled Mechanical Grain-Door Opener, Electric Operation

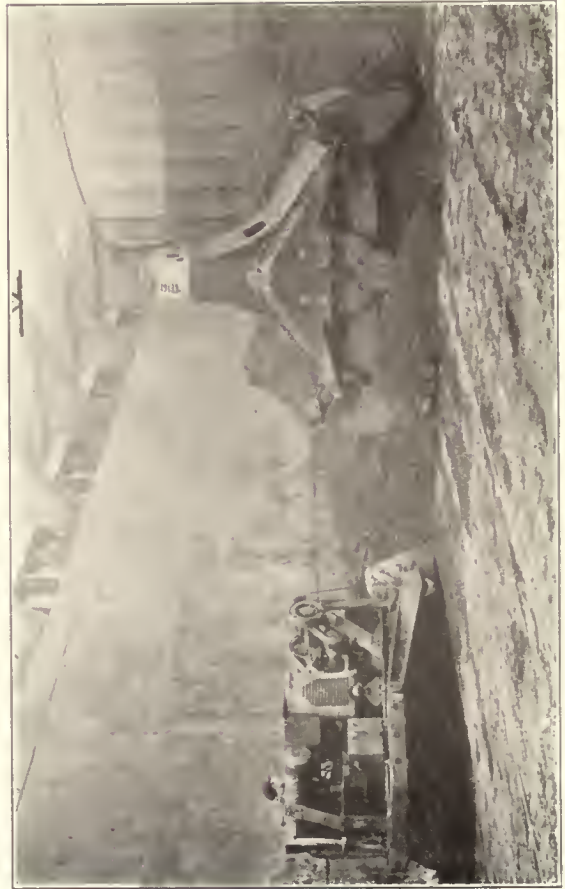

Power Scraper-Shovel for Clean-Up Work in Ore Vessel

it may pass to a railroad car or to a trough or bin back of the unloader, from which it may be moved to a storage pile by the use of a storage bridge crane.

Tower unloaders of this type are also sometimes equipped with buckets operated by a rope trolley. The bucket lines are reeved through sheaves on the boom and on a trolley which may be moved in either direction on the boom by an endless rope attached to the two ends of the trolley and making several turns around the winch drum. A machine of the one-man type has a capacity ranging from 100 to 1000 tons per hour, depending on the size of the bucket.

Mast and Gaff

The mast and gaff type of unloader is particularly adapted for use in small coal yards; at small coal wharves; or at power plants. This rig is a modification of the guy and the stiff-leg derricks. Being used chiefly for light bucket work, it generally is of comparatively light wooden construction although steel members of light lattice construction, sometimes are used.

The mast is fixed and is supported by stiff-legs, secured to the mast about midway from the top, and by guys attached to the top of the mast. The gaff or boom is pivoted on a swivel block clamped to the mast and is provided with a topping-lift similar to other derricks. Usually, however, the topping lift is used only to adjust the inclination of the gaff to a convenient radius suitable to the work required. The bucket operating lines are reeved through load sheaves at the gaff end and through guide sheaves

spaced wide on a crosstree secured to the mast at a point near the swivel block, and thence to the hoisting winch drums. The gaff is slewed by manipulating the bucket lines through the guide sheaves on the crosstree, slacking off on one line as the other line is hauled in.

This apparatus provides an inexpensive equipment and can be used advantageously with two-line grab-buckets having a capacity up to about $1\frac{1}{2}$ cu. yds. or with buckets of the bottom dump or the turnover types. The capacity of the mast and gaff rig ranges upward to about 30 tons per hour depending on the size of bucket used and the class of material handled.

Self-Unloading Vessels

Self-unloading vessels are sometimes used in ore service or where other similar materials are handled in large quantities. These vessels are made with a hopper bottom having a series of gates through which the material is discharged to pan or belt conveyors. These conveyors carry the material to an elevator which lifts it above the deck line and then discharges it to a belt conveyor carried by a swinging boom. The boom carrying the conveyor may be elevated to an angle of about 18 deg. and is made from 100 ft. to 150 ft. long which gives it a wide scope. The material is discharged from the conveyor to a storage pile or to railroad cars for further transportation. Apparatus of this type will handle from 500 to 1000 tons of ore per hour depending on the size and number of conveyors used.

Trolleys and Carriers

TROLLEYS AND CARRIERS of various designs are used on cranes having a horizontal jib or bridge, on many types of unloading machines, on monorail and tramway track-age systems, and on suspension cableways. These devices may consist of plain travelers propelled by pulling or pushing on the suspended load; may be of the geared type and be propelled by racking gear operated by a drum on a remote engine, or by pendant hand chains passing over sheaves geared to the traveler wheels and operated from the floor; or may consist of a carriage or truck operated by an independent motor—generally an electric motor—carried on the trolley itself.

The larger types of trolleys—called specifically crane trolleys or trolley trucks—consist of a truck or carriage composed of a rectangular frame mounted on four or more wheels and traveling on a track laid on top of the crane girders. The hoisting drums are built in the frame as an integral part of the apparatus and the hoisting motors as well as the trolley traversing motor are also mounted on the frame.

On trolleys of the smaller types, of light capacity, the hoisting apparatus may consist of a simple tackle; a chain hoist; a pneumatic hoist; or an electric hoist, suspended from the trolley and traveling underneath. They may be used singly to carry a hoist; or in multiple to suspend a twin-hoist or an outrigger for the power sheave, for suspending a spreader bar, or for carrying a cab-operated monorail hoist or telfer.

Crane Trolley Trucks

Crane trolleys—a name applied more specifically to trolleys having a truck frame and mounted on four or more wheels traveling on a crane bridge—must be constructed in a most substantial manner to meet the exacting requirement of modern industrial plants. They are designed in many different forms, the particular class of service required of them determining the type of trolley to be installed. They vary in size from a small four-wheel truck, propelled by gearing attached to the trolley structure and operated by a remote engine on the crane structure or from the floor by a pendant hand chain, to immense electrically operated truck trolleys having several hoisting drums and various special attachments and having upward to 16 wheels.

Essential and desirable features of crane trolley construction are: Adequate strength of parts; compact arrangement of machinery; ample motor capacity; and thorough lubrication.

Truck Frames

Trolley truck frames for cranes of comparatively light capacity, upward to about 20 tons, may be made of a good grade of cast iron or semi-steel but for heavier capacities structural steel or annealed cast steel should be used. The side frames are designed to carry the bearings for the truck axle and for the various shafts of the hoisting drums and motors. The two side frames are connected by a girt which serves to stiffen the truck frame and generally also to provide a support for the motors used to operate the trolley. The girt may be made either of structural steel parts or may be a substantial steel casting and should be firmly secured to the side frames to

prevent any distortion of the frame and consequent dis-alignment of shafts.

Wheels

The truck wheels on crane trolleys generally are double flanged. For trolleys of the lighter capacities, they may be made of a good grade of chilled cast iron but for heavy severe service they should be made of cast steel or rolled steel. They should be ground to a true diameter to insure smooth travel. The wheels on many crane trolleys are mounted on axles of the pin-and-keeper type and are provided with bearings of bronze or other metals, or in many cases with roller or ball bearings. The M, C, B. type of bearing is preferable for heavy service and is used extensively on the larger crane trolleys.

Hoisting Drums

The hoisting drums are commonly made of cast iron and are mounted on steel shafting and geared to the hoisting motor. They should be made with a diameter of not less than 30 times the diameter of the hoisting rope, to avoid undue bending strain on the wire strands of the rope, and should have sufficient width to permit the rope to wind on the drum for the maximum lift of the apparatus without overlapping.

It is common practice to groove the surface of the drum so that the rope is guided as it winds on the drum in the hoisting movement. Preferably the drum should be grooved from the center outward right and left so that both ends of the hoisting rope may be attached to the drum—one end of the rope at each end of the drum. This method of suspension distributes the load stress uniformly on the truck and permits the hoisting hook to travel in a true vertical line—an important feature in some classes of work requiring accurate placing of the load as in placing molds in foundry work. Trolleys used on the ordinary three-motor crane have only a single hoisting drum but many crane trolleys are equipped with a main and an auxiliary hoist and in some cases for special service, with an additional drum.

Gearing

The trolley is traversed across the crane structure by gears secured to one or more of the truck wheels and meshing with a gear train operated by the trolley traversing motor. The hoisting drums are operated by a large gear secured to one end of the drum which meshes with a pinion on a gear train propelled by the hoisting motor. Many efficient cast gears are in use, but for crane trolleys of heavy capacity, or where a smooth running easily operated machine is desired, cut gears are preferable. So far as possible, all gears should be enclosed in oil-tight and dirt-proof cases. On the most modern designs of crane trolleys, the greater part of the gears are enclosed and operate in a bath of lubricant; this protects the gear from dirt and insures a smooth running efficient gear having a long life.

Motors

Electrically operated crane trolleys are equipped with one or more electric motors either of the direct current or alternating current types. They are installed on the truck

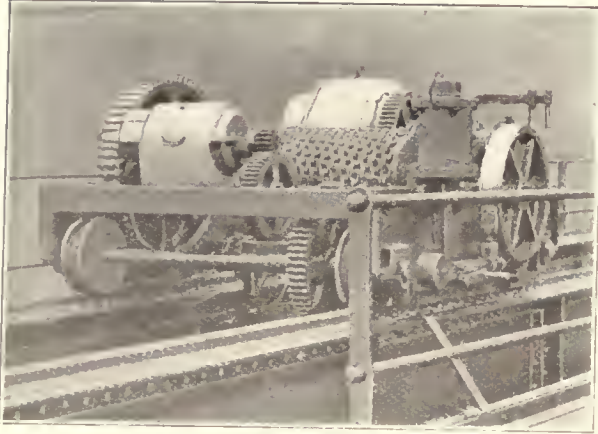

Chain Equipped Three-Motor Trolley

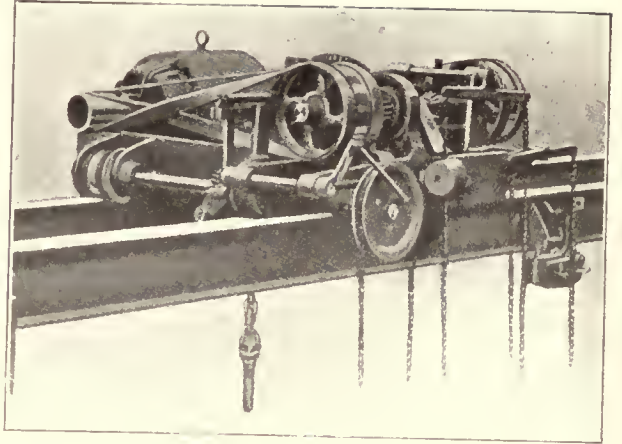

One-Motor Electric Trolley

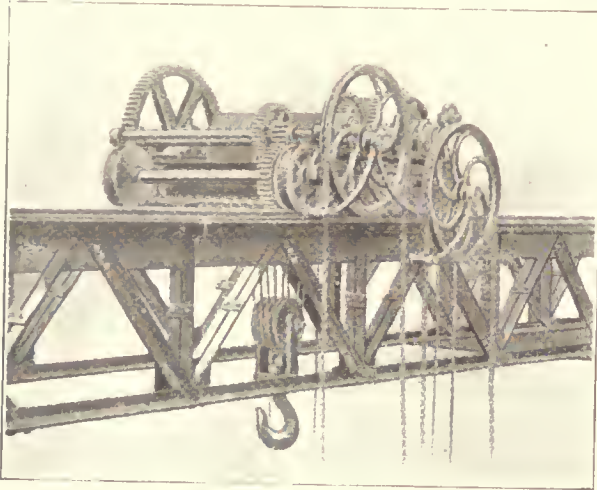

Spur-Gear Hand-Power Trolley

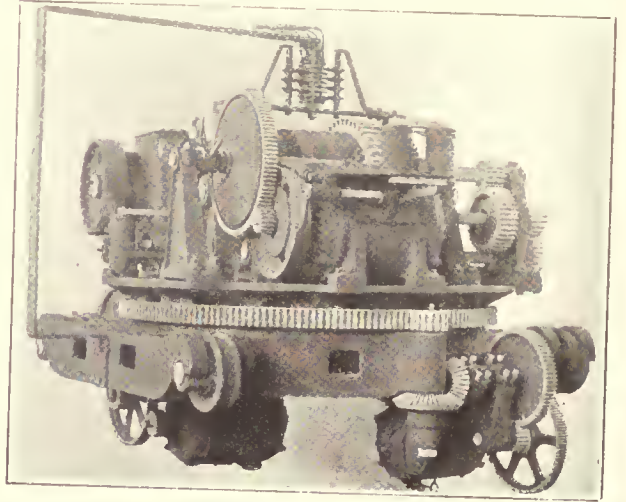

Ingot Charging Trolley

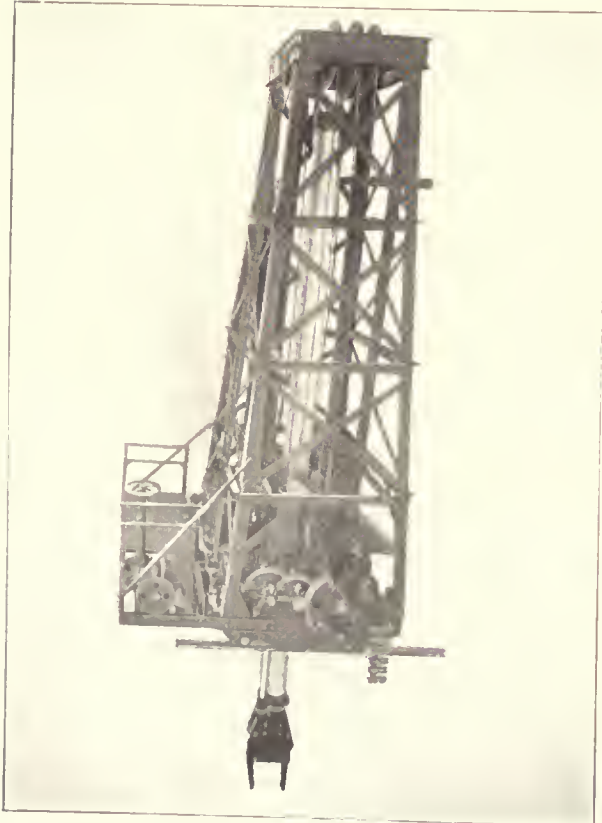

Electric Ingot Stripping Trolley

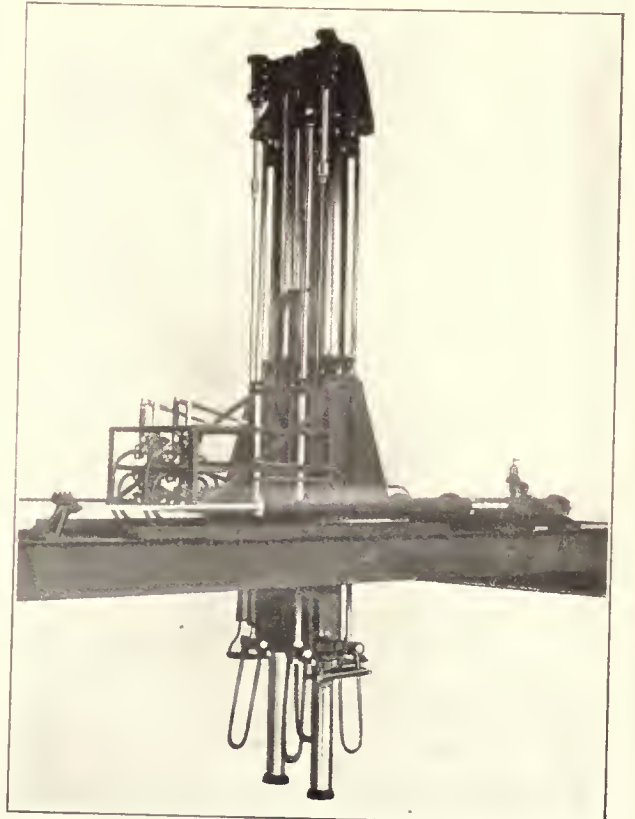

Hydraulic Ingot Stripping Trolley

frame—sometimes being secured on the girt, sometimes on the side frames or on brackets secured to the side frames. The motors vary in design with the needs of the service in which the crane is to be used and the method of design followed by various motor manufacturers. Therefore, no attempt will be made to describe the motor construction.

Crane trolleys used on the ordinary three-motor crane generally are equipped with two motors—one to operate the hoist and one to traverse the trolley. Auxiliary drums are installed on the truck for service requiring more than one hoisting line. They generally are operated by an independent motor but on some crane trolleys the auxiliary drum is connected to the main drum gear and both drums may be operated by a single motor.

In some cases, however, a non-reversing motor is used to operate the hoist and to traverse the trolley. By means of friction cones which are brought alternately into contact with either side of a friction disk, always rotated in one direction by the motor, the direction of travel of either the hoist or the trolley may be reversed without stopping or reversing the motor. Trolleys used in some classes of service, particularly steel manufacture, have upward to four or five motors to operate the various hoists or special attachments and accessories.

Brakes

Crane trolleys having motors of the alternating current type are usually provided with both load brakes and motor brakes which may be either mechanically or electrically operated. On trolleys operated by direct current motors the load brakes may be dispensed with and the dynamic braking system utilized.

Load Brakes

Various types of mechanical load brakes are used, generally employing friction disks to obtain the braking power. One type of friction disk brake employs a ratchet friction disk, two friction washers, a friction collar, a combined nut and gear having a friction surface on one side, and a screw shaft carrying a pinion which meshes with the gear train of the hoisting apparatus. This brake operates automatically in unison with the movement of the hoisting gear. When the motor is cut off—or the speed varied in the variable speed types—downward movement of the load tends to screw the shaft into the combined nut and gear, gripping one of the friction washers between the friction collar and the ratchet disk and the other washer between the ratchet disk and the friction surface of the gear. A pawl engages the ratchet teeth and prevents the backward movement of the ratchet, thus holding the load suspended. To continue the lowering movement or to raise the load, the motor must be started and rotate the gear train at a speed sufficient to overcome the action of the screw shaft. This type of brake is enclosed in an oil tight case and runs in a bath of lubricant.

Another type of mechanical load brake combines the use of friction disks and a brake band. In this type the brake wheel turns loosely on the shaft and is encircled by an automatic band which grips the wheel to prevent lowering but is released automatically in the hoisting movement. Two friction disks—the outside one keyed to the brake shaft, the inside one turning loosely upon it—are brought into contact with the brake wheel by a clutch operated by a two-part cam and acting upon the extended hub of the inner friction disk. One part of the cam is

keyed to the shaft, the other turns loosely upon it and carries a pinion which meshes with the intermediate gear of the hoisting drum. A pinion on the motor shaft meshes with a gear on the brake shaft so that when the load is being raised a shoulder on the cam causes the pinion on the brake shaft to drive the hoisting gear. When the motor is cut off, the cam, actuated by the force of the descending load assisted by a spiral spring encircling the cam, forces the inside friction disk against the brake wheel, gripping the wheel between the two disks. This causes the pinion on the cam to retard the movement of the hoisting gear and hold the load suspended until the motor speeds up the gear sufficiently to overtake the movement of the cam.

Dynamic Braking

Crane trolleys operated by direct current motors may be equipped with the dynamic braking system and the load brake may be dispensed with. In this system of braking the energy developed by the lowering of the load is converted into electric current, part of which is returned to the power line. A dynamo—when energized by the power line—acts as a motor and furnishes the power required to raise the hoist but when, in the lowering operation, the force of the descending load is sufficient to overcome the action of the motor, mechanical energy is supplied to the dynamo and it automatically acts as a generator and converts this energy into electric current.

The dynamic braking system serves only to retard the lowering speed and will not hold the load suspended. Therefore it is necessary to equip the hoisting motor with some form of brake having sufficient power to hold the load. On a crane thus equipped the dynamic brake is first utilized to retard the load and the motor brakes then applied to hold it suspended. This reduces the wear on the motor brake to a minimum.

Motor Brakes

Crane motors are equipped with various types of electrically operated brakes. They generally consist of some form of friction band, friction shoes, or friction disks, which are brought into contact with some portion of the rotating mechanism—usually a wheel or disk on the armature shaft. These brakes are magnetically controlled, usually by a solenoid type of magnet. This type of brake is actuated by springs either attached directly to the friction member or acting upon a plunger controlled by the magnetic action of the solenoid and operating levers which apply or release the brake. When the current is cut off the springs force the brake against the wheel stopping the motor. When the current is again turned on, the solenoid overcomes the tension on the springs and releases the brake.

The friction disk type of motor brake generally is controlled by a magnet of the horseshoe type.

Geared Trolleys

Geared trolleys designed for light service on cranes or other machines—upward to about 6 to 10 tons capacity—are generally operated by hand power and are constructed in a manner similar to that of the plain two-wheel or four-wheel trolleys. A power sheave is used to operate the gear and it may be attached directly to and act on only one wheel of the trolley; may be mounted on a separate shaft carrying a pinion which meshes with gears secured to one or more wheels on the trolley; or may transmit

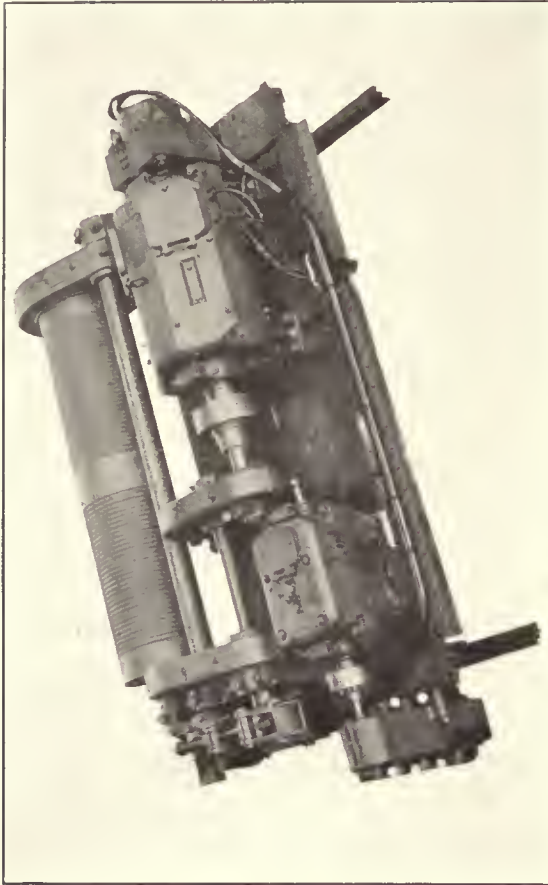

Three-Motor Electric Trolley

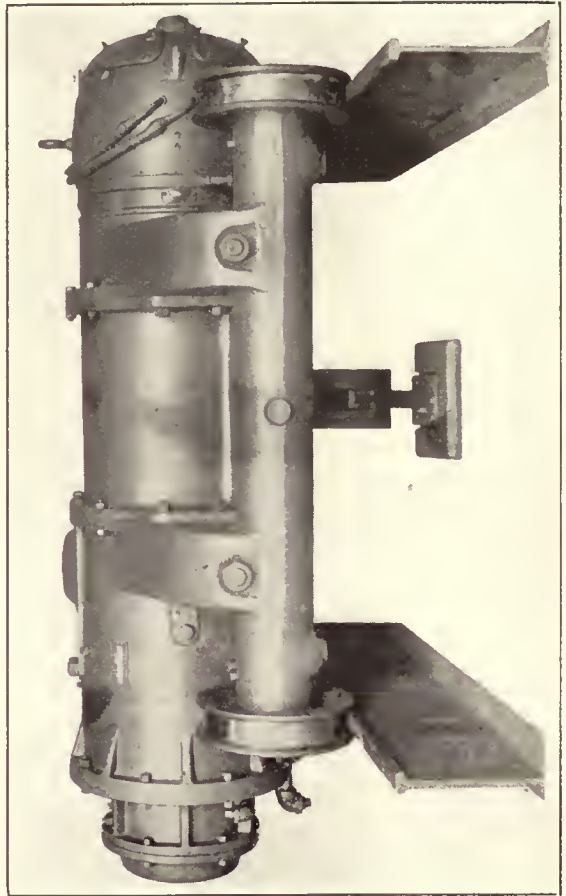

Enclosed Electric Crane Trolley

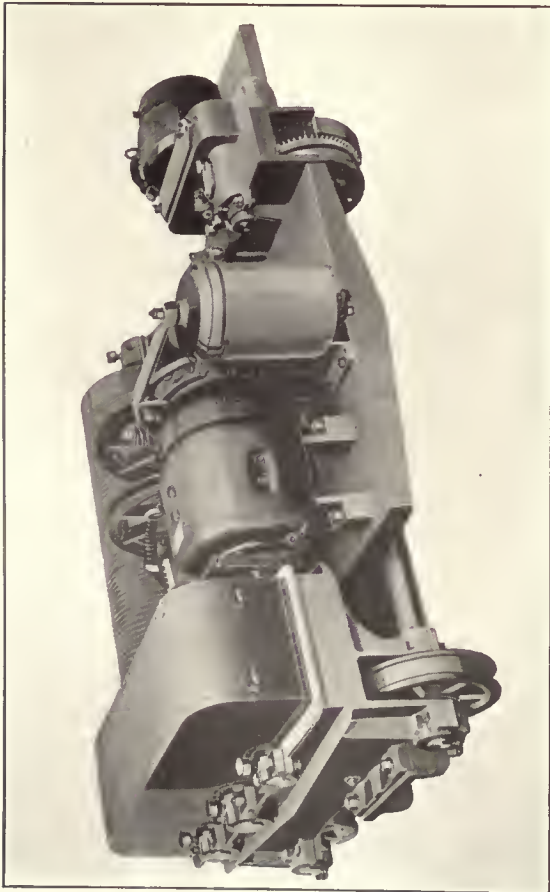

Two-Motor Electric Crane Trolley

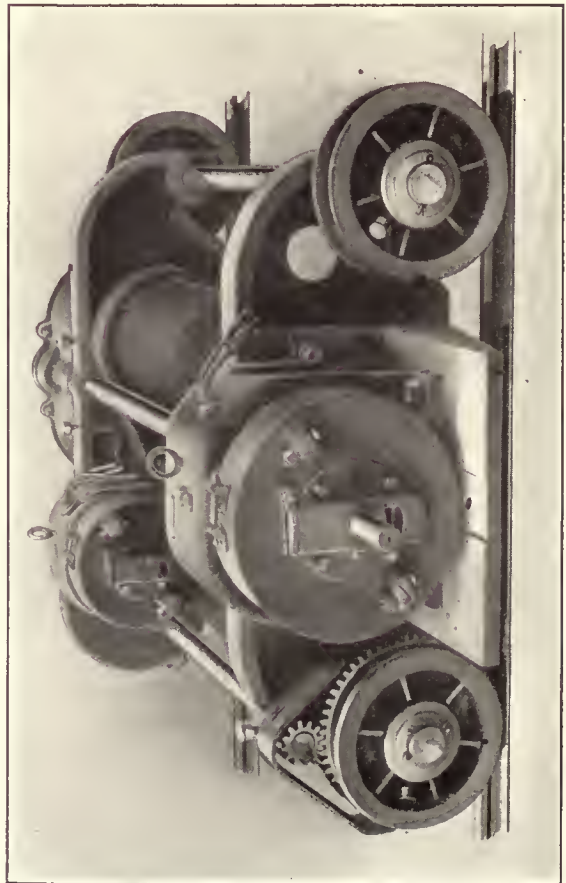

Two-Motor Electric Crane Trolley

the power to the trolley through a gear train having one or more speed reductions. The pendant hand chain is pulled downward on either side to propel the trolley in either direction. Any of the various types of hoists may be suspended from this type of trolley.

Power-operated geared trolleys are made in larger and more substantial designs having from 4 to 12 wheels and they are used chiefly with electric hoists. They are usually propelled by an independent motor carried on the trolley itself or, when the hoist is permanently attached to the trolley, on the hoist frame. They also are used in multiple for cab-operated monorail hoists and telfers.

Plain Trolleys

Plain trolleys—often called travelers or carriers—are the simplest form of the overhead carrier. They are used in conjunction with some form of hoist and are used in industrial plants, warehouses, power-plants or other places where only light or occasional service is required of the hoisting apparatus.

For very light service, a two-wheel carrier may be used. The wheels are double flanged and travel on top of a plain rail; on various special inverted rails; or on the upper flange of an I-beam. Usually the axles are

fixed in two side frames of steel plate which project below the track and support a hook, an eye, or a clevis, to which the hoist apparatus may be attached; or a hoist may be permanently secured to the frames. Generally the wheels are provided with some form of roller or ball-bearings and turn loosely on the axles. This type of trolley is suitable only for light service ranging upward to about two tons, and is not used where frequent heavy service is required.

For slightly heavier service, a plain four-wheel carrier is used on hand-operated cranes or on monorails. This type usually consists of two sets of wheels—one set of two wheels on each side of the I-beam—turning on pin type axles fixed at one end in side frames of steel plate, forged steel, or steel casting and traveling on the lower flanges of the I-beam. The hoist suspension is attached to an equalizing crossbar which is supported by the lower part of the side frame and distributes the load uniformly on all the wheels.

Lightly constructed trolleys and carriers are also used on cableways and rope tramways. These devices have features of construction and operation peculiar to the service for which they are designed. They are shown in the chapter on cableways and tramways.

Overhead Trackage

Overhead Trackage—generally called monorail—used with the various forms of hoists and other overhead carrying devices consists of some form of rigidly supported beam on which the trolleys or carriers may travel. It may be made of a plain steel bar, with the trolley traveling on the top of the bar; a single I-beam or double I-beam, with the trolley traveling either on top of the beam or on the lower flanges; or it may consist of a specially formed double-flanged rail. These tracks may be supported on specially constructed trestles or may be secured to brackets or other structures attached to some part of a building. A cable type of trackage—used chiefly for cable telfer systems and for cableways and tramways—consists of a single or double track cable carried on cable hangers, which may be suspended from special towers, bents, or trestles, or from brackets secured to a building. This type of trackage is described in the chapter on cableways.

Track

The I-beam form of overhead trackage is extensively employed in the construction of monorail systems and may consist of either a single or double beam. The single-beam type is the most commonly used, and it generally is suspended so that the lower flanges of the I-beam are unobstructed. This permits the free travel of the trolley or carrier from which the hoist or other material handling device may be suspended. In some cases, however, the beam is installed so that the travel may be on top of the beam. The double-beam overhead track is used where a very heavy capacity is required. This type of construction consists of two I-beams placed side by side, usually with the adjacent inside lower flanges free, so that the trolley wheels may travel on them. Sometimes the double track also is arranged so that the trolley may travel on top of the beams. In many cases the trolley wheels rest directly on the flanges of the I-beam, but in the best modern practice—particularly in heavy service—

the wheels travel on wearing strips of hard steel or on T-rails laid on the beam.

A form of double trackage used quite extensively for heavy service monorail systems consists of a single I-beam having a standard T-rail secured to each side. The heads of the T-rails rest on the top edge of the lower flanges and are secured in place by bolts extending through the webs of the rails and through filler or spacing blocks placed at intervals between the rails directly under the I-beam. The T-rails are thus held firmly in place without requiring the drilling of holes in the I-beam and provide a double-rail track with the use of only a single beam.

Another type of monorail known as the Coburn track is quite extensively used for light service. This track consists of a double-flanged rail, the flanges being turned inward and upward so that a double groove is formed on the inside of the rail with an open space between the flanges. The trolley wheels travel on these inside flanges and the trolley hangers extend downward through the opening between the flanges.

The plain bar or flat rail type of track consists of a simple straight bar—usually having the edges rounded. The load bearing trolley wheels travel on top of the rail, but in some cases an additional set of wheels running under the rail is also provided. This tends to give greater stability to the trolley as it is propelled along the track. This type of track is simple in construction and application and is especially suitable for a light capacity monorail system.

Switches

In a complete monorail system designed to operate throughout various departments of a manufacturing plant where continuous track can not always be installed, it is necessary that some means be provided to permit a trolley to pass from one line of trackage to another. In some cases, this is accomplished by a simple latching device

HOISTING MACHINERY

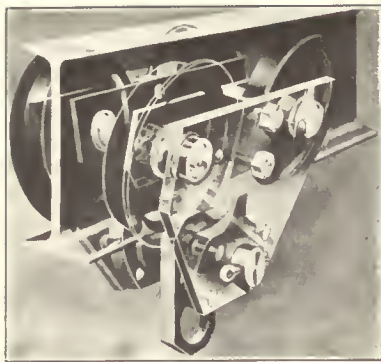

Equalizing Trolley

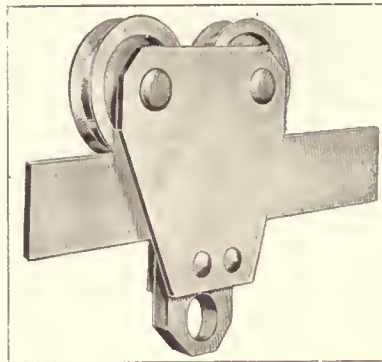

Plain Bar Trolley



Geared Trolley

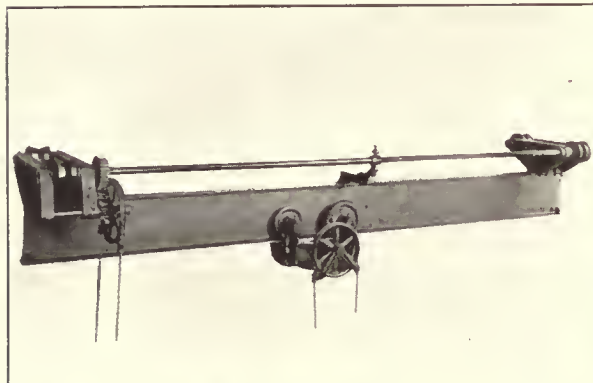

Racking Trolley Mounted on Hand-Operated Single I-Beam Crane

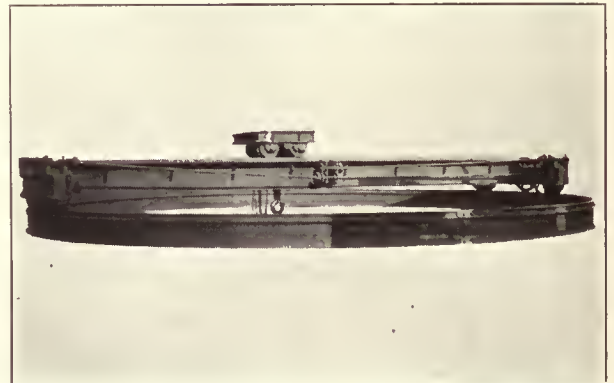

Circular Track for Rotating Overhead Traveling Crane

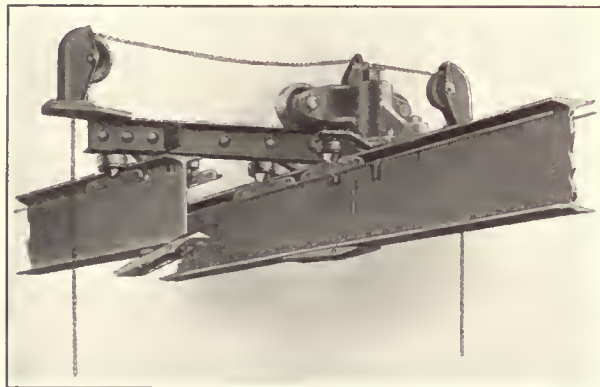

Two-Way Switch

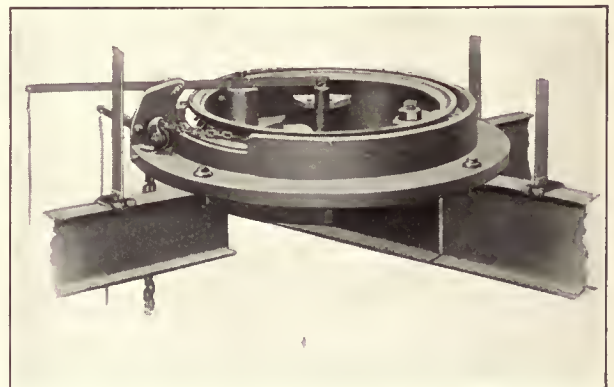

Turntable

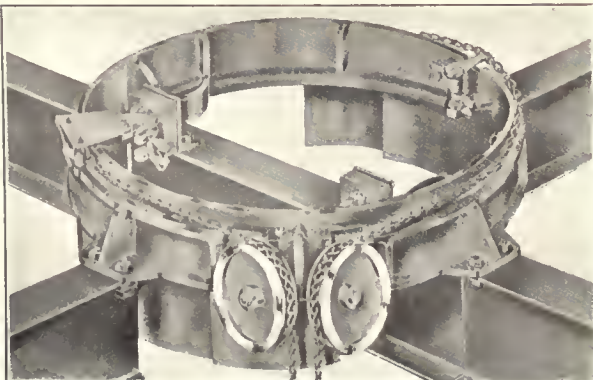

Turntable



Rotating Switch

which insures that a monorail on a traveling crane or transfer bridge will line up with a stub track or a cross-over, and thus permit the trolley to safely pass from one track to another. However, it sometimes is necessary to diverge from the main track at angles varying upward to 90 degrees, and this requires that special switching devices be employed. In such cases a tongue switch of the two-way or three-way type, a rotating switch, or a turntable is used. These may be arranged so that they may be operated from the floor or from the cab of a monorail hoist. On a single-track system a by-pass or side track is often provided so that the travel may be in both directions without interference.

Tongue Switch

The tongue switch is used where the track angle of divergence is not great. It may be made either two-way—connecting two tracks; or three-way, connecting three tracks. This type of switch is made in two parts, one part being fixed and the other—the tongue—being hinged so that it may be moved sidewise. The fixed part of the switch consists of two or three sections of rail secured to the ends of the converging tracks, and the tongue is a single section hinged to the end of the track with which the others are to be connected. In the operation of this type of switch, the movement of the tongue is controlled from the floor by pendant chains or cords. It usually is provided with an automatic alinement device and with rail guards or baffles which prevent the trolleys from running off the open track ends.

These baffles may be either mechanically or electrically operated. One type of mechanical baffle is designed to automatically raise or lower as the switch tongue is moved. As the tongue is moved away from a spur track the baffle at that point automatically lowers into place, and as the tongue engages with another of the connecting spurs the baffle at that point automatically raises. Thus the track ends are protected at all times.

The electric baffle is operated by means of circuit breakers on the current conductor line. It is arranged so that when the switch tongue is latched to the spur track the conductor on the switch and on the spurs leading to it are energized. If, however, the tongue is not securely latched to the spur the current is broken and the con-

ductor line is then dead for some distance each side of the switch. When the switch tongue is not in proper alinement a semaphore indicates the fact to the hoist operator. The break in the current circuit also causes the application of the electric brake on the hoist trolley and brings the apparatus to a stop.

Rotating Switch

The rotating switch is designed to connect either of two straight tracks or, by the use of curved sections of track, it may be arranged to permit the use of two tracks at the same time. It consists of a rotating frame or turntable having on the under side two curved sections and one straight section of track. The device is installed at the intersection of two monorail tracks crossing each other at right angles, the track sections being located on the frame so that, by rotating the switch, the straight section may connect either straight line of track or the curved sections may connect both right-angle lines, thus permitting travel on both tracks independent of each other. The rotating frame rests on roller or ball bearings and is manipulated by pendant cords, which may be reached from the floor or from a cab.

Turntable

The monorail turntable is used where there is not sufficient space to permit a curved section of track, but where it is sometimes necessary to transfer a trolley from one track to another at right angles to it. It differs from the rotating switch in that it does not connect two lines of diverging track and thus permit continuous travel. The trolley must be run from one track to the turntable rail-section and the turntable then rotated so that the trolley may pass from it to the other fixed track. The turntable base consists of a steel casting resting on and bolted to the four ends of the abutting tracks and the rotating portion of the turntable turns on ball or roller bearings resting in a groove in the base. It is provided with track guards, located so that as the table is rotated the trolley can not run off the ends of the fixed tracks. The turntable is operated by pendant cords or chains, generally arranged so that they may be reached either from the floor or from the cab of a monorail hoist.

List of Parts

- 1 Steam Chest Cover
- 2 Cylinder Jacket
- 3 Back Cylinder Head
- 4 Front Cylinder Head
- 5 Cross Head Guide
- 6 Piston Rod Gland
- 7 Piston Rod and Nuts
- 8 Cross Head Guide Bracket
- 9 Connecting Rod
- 10 Drain Cock Lever
- 11 Drain Cock Lever Shaft
- 12 Drain Cock Lever Socket
- 13 Drain Cock Lever Connection
- 14 Counter Weight
- 15 Foot Lever Connection
- 16 Rear Foot Lever Shaft
- 17 Foot Lever
- 18 Large Side Stand
- 19 Forward Foot Lever Shaft
- 20 Crank Disc
- 21 Foot Lever Treadle
- 22 Thrust Screw
- 23 Thrust Lever
- 24 Thrust Nut
- 25 Small Side Stand
- 26 Bed
- 27 Drum Shaft Bearing Cup
- 28 Thrust Bar
- 29 Thrust Collar
- 30 Grease Cup Holder
- 31 Ratchet
- 32 Thrust Screw
- 33 Thrust Bar
- 34 Thrust Collar
- 35 Ratchet
- 36 Drum Gear
- 37 Thrust Pin
- 38 Drum
- 39 Forward Brake Band
- 40 Drum Gear
- 41 Wreck Head
- 42 Gear Guard
- 43 Stay Strap for Brake Band
- 44 Rear Brake Band
- 45 Pawl for Forward Drum
- 46 Crank Shaft Bearing Cup
- 47 Pawl for Rear Drum
- 48 Hand Hole Crab
- 49 Boiler Rod
- 50 Throttle Valve Handle
- 51 Stand for Throttle Valve Handle
- 52 Throttle Valve Rod
- 53 Glass Water Gauge
- 54 Steam Gauge
- 55 Whistle
- 56 Safety Valve
- 57 Lubricator
- 58 Bracket for Lubricator
- 59 Throttle Valve
- 60 Coupling for Throttle Valve Rod
- 61 Injector
- 62 Boiler Hood and Stack
- 63 Rim for Smoke Stack
- 64 Lid for Smoke Stack
- 65 Bracket for Smoke Stack Lid
- 66 Handle for Smoke Stack Lid
- 67 Bracket for Smoke Stack Lid
- 68 Angle Bracket for Boiler Hood
- 69 Screw Collar
- 70 Drum Bushing
- 71 Drum Lagging
- 72 Wood Friction Block
- 73 Drum Spring Bridle
- 74 Drum Spring

Drum and Friction

- 96 Screw Collar
- 97 Drum Bushing
- 98 Drum Lagging
- 99 Wood Friction Block
- 100 Drum Spring Bridle
- 101 Drum Spring

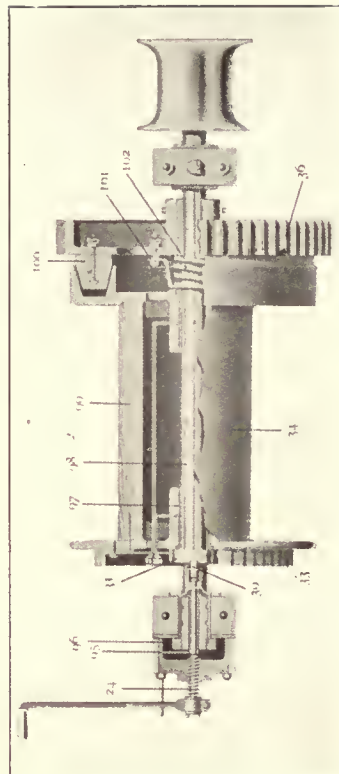

Friction Drum and Drive

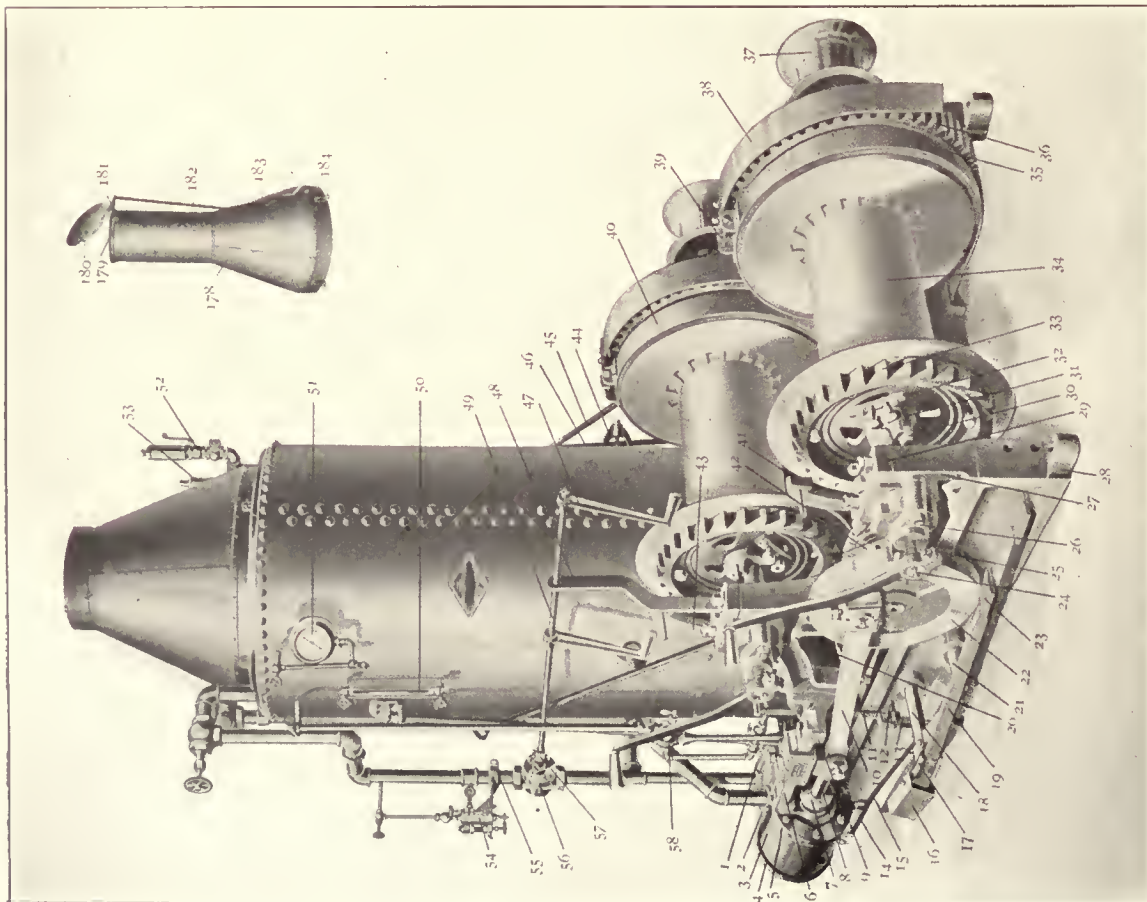

Two-Drum Steam-Operated Winch

Winches

WINCHES ARE USED to operate many of the machines used in material handling operations. They are adapted for use with general service hoisting apparatus such as elevators, derricks, or cranes; on board ship for operating the cargo handling gear; in mines for haulage or hoisting purposes; for operating cableways; and for various other similar purposes. They vary in design from the small single-drum hand-operated winches used on small derricks to the large multiple-drum power-operated types used on the larger material handling machines. They may be mounted on a separate fixed foundation; on a portable platform or on skids; or secured to some part of the machine which they operate.

In general design a winch consists of a wooden or metal frame in which one or more drums are mounted on horizontal shafts turning in bearings secured to the side members of the frame. The drums may be rotated by means of a large gear mounted directly on the drum itself and meshing with a single small gear or pinion on the power shaft; by a gear train acting directly on the drum itself; or—in the power operated types—by various designs of frictions drive or clutches.

The hoisting or haulage line is secured to one side of the drum and is wound or unwound as may be desired by rotating the drum in either direction. Sometimes the drum shafts are extended beyond the side frames and a winch-head—often called a gypsy-head or nigger-head—is secured to one or both ends. In the operation of this device the rope is not made fast but is simply given two or more turns around the winch-head, the loose end being held by the operator and hauled in or payed out as required, the friction thus obtained being sufficient to permit the moving of a considerable load.

Hand winches are operated by hand cranks which are applied to one or both ends of the power shaft and turned by manual labor, while power winches are usually operated by steam, gasoline, or electric power—sometimes by air or water power. Winches of very light capacity may be controlled without the use of a brake, only a pawl being used to engage the teeth of the large gear on the drum, but, on the larger types of winches, some form of friction brake or clutch is used.

Hand Winches

Hand-operated winches are used on small hand-power derricks, jib cranes and pillar cranes; on other material handling machines of light capacity; or as an independent hoisting or haulage apparatus. They are made with a single-drum; a double or two-part drum on a single shaft; or with two separate drums on independent shafts. They may be of the single-purchase type—power applied through a single gear and pinion; of the worm gear type—a type of single-purchase; of the double-purchase type—power applied through either a single gear and pinion, or through a gear train; or the triple-purchase type.

The single-purchase hand-power winch is designed to apply the power by means of a pinion mounted on the

power shaft and meshing directly with the gear on the drum. It is operated by one man or two men by placing a hand crank on either end or both ends of the power shaft. The capacity of hand winches of the single-purchase type ranges upward to about 1½ tons.

The worm-gear hand-power winch is especially adapted for use where it is necessary to hold the load suspended. In this type of winch a worm wheel is secured to one end of the drum and meshes with a worm on a short shaft to which is attached a hand crank by which it is operated. No brake is required as the load will remain suspended when the hand crank is released. It is made in capacities ranging upward to about 1,500 lb.

The double-purchase winch is operated by either or both of two power shafts. One shaft is geared through a pinion directly to the drum gear in the same manner as on a single-purchase winch and an intermediate gear on this shaft meshes with a pinion on the second shaft. This provides two speeds of operation as the power may be applied to either of the shafts, the shaft with direct action on the drum gear giving a greater speed but a lighter capacity than that which acts through the intermediate gear. Winches

of the double-purchase types may be operated by either one, two, or four men. They range in capacity upward to about 2½ tons.

Hand power winches may be either of the single-pole or the double-pole types. The single-pole winch as its name implies is designed to be attached to a derrick mast; to the column of a jib crane; or to any other single upright support. In construction this type of winch is a modification of the double-pole winch or of those mounted on a portable standard or frame. Being used chiefly for very light work requiring only a single hoisting line, the single-pole winch generally is provided only with a single drum but may have either a single or double-purchase gear and be equipped for either one or two-man operation as conditions require.

Power Winches

Power operated winches are made for both hoisting and haulage service and are used on practically all the heavier types of material handling machines. They are equipped with one or more winding drums and may also have extended shafts provided with winch-heads which permit the use of additional lines for slewing or other light work. They may be designed to perform work only when the drum is rotated in one direction or may be of the reversible type.

Friction clutches are extensively used on winches of the power-operated types. This form of control permits a gradual application of the power to the winding drum and may easily be manipulated so as to minimize the stresses due to starting a heavy load. The device usually consists of a series of cone or wedge shaped friction blocks secured to the side of the gear on the winding-drum shaft and aligned with a corresponding recess or groove on the ad-

Hand Power: Single, Double, and Triple Purchase; One-Drum, Double-Drum, Two-Drum.

Power Operated: Steam—Direct and Steam Line Connection; Gasoline; Electric. Belt and Gear Driven; Friction and Clutch Drive.

Portable and Fixed Types with Single, Double and Multiple Drums and Winch Heads.

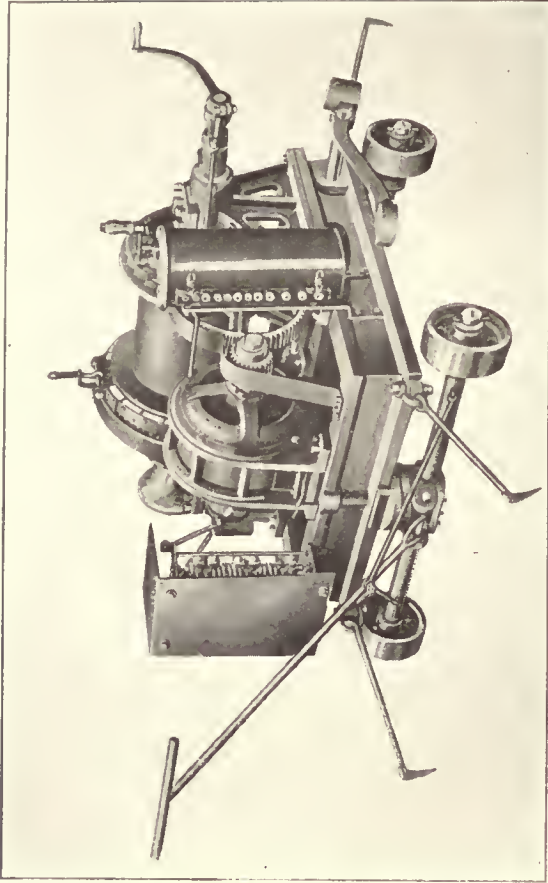

Portable Electric Winch with Plug-In Connection

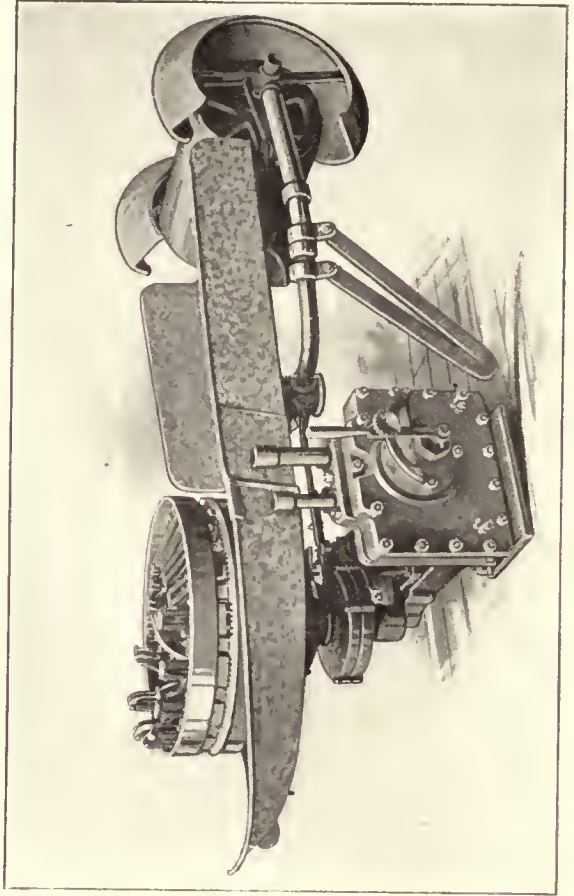

Steam Winch for Net Lifting

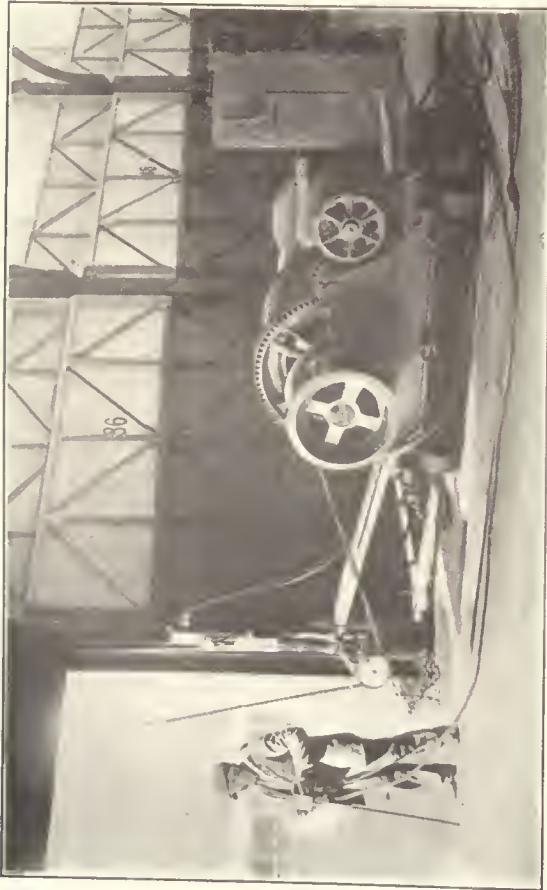

Electric Winch with Remote Control

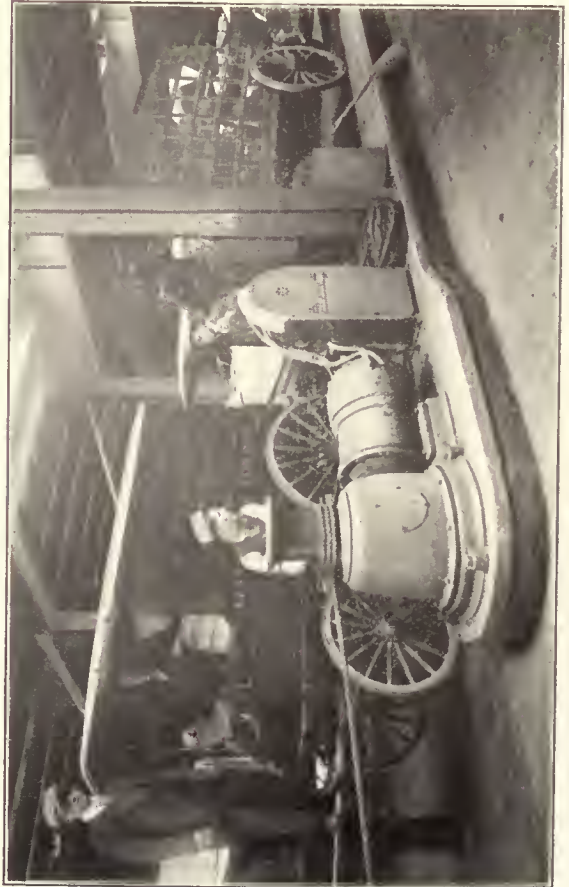

Electrically-Operated Capstan

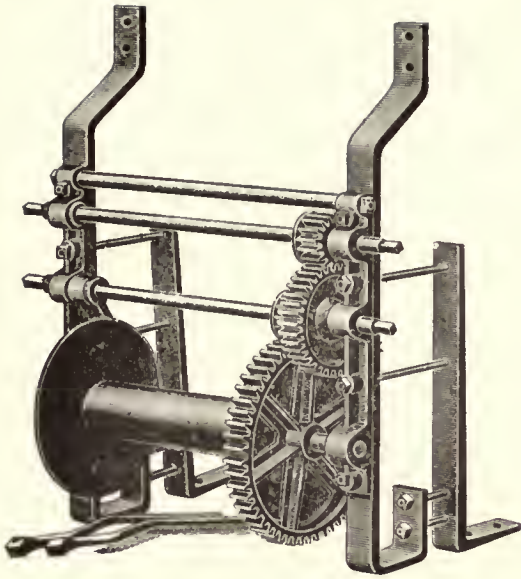

Single Drum, Double Purchase

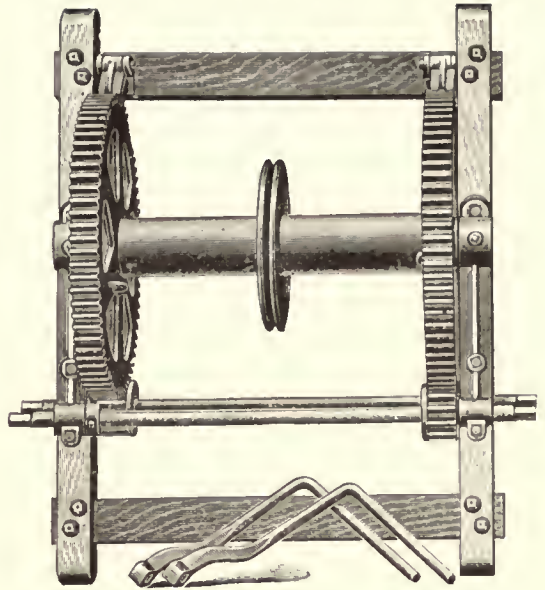

Double Drum, Single Purchase

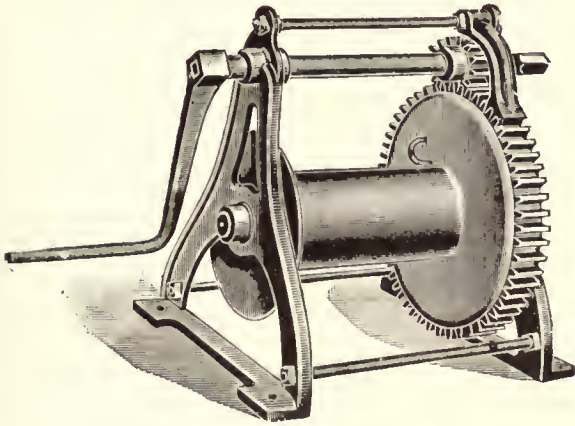

Single Drum, Single Purchase

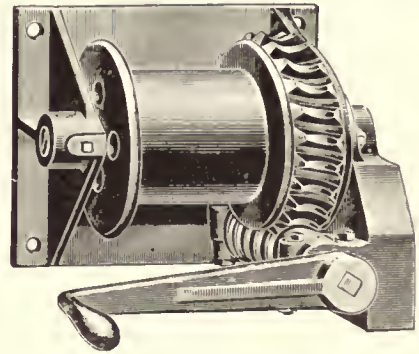

Worm Gear

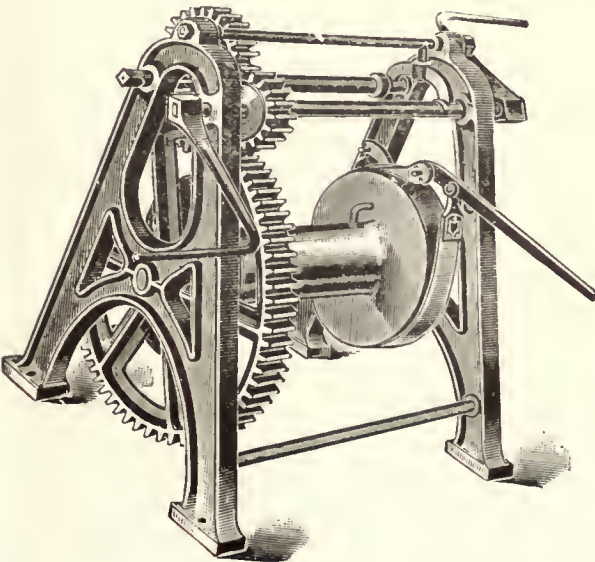

Single Drum, Double Purchase

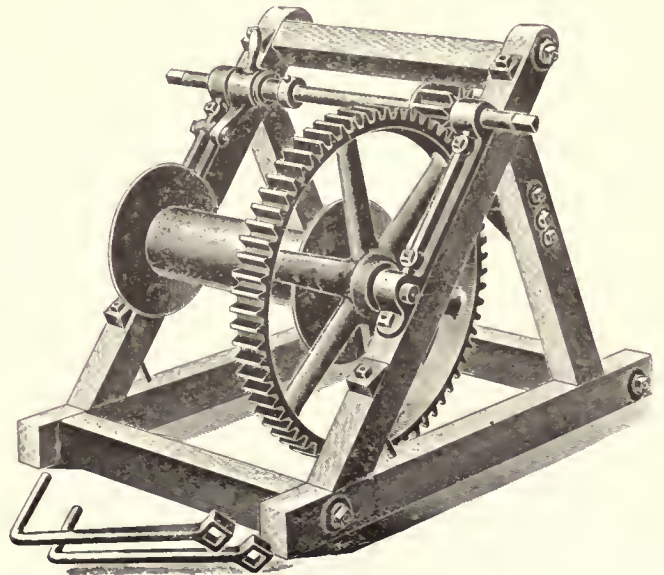

Single Drum, Single Purchase

Hand Power Winches

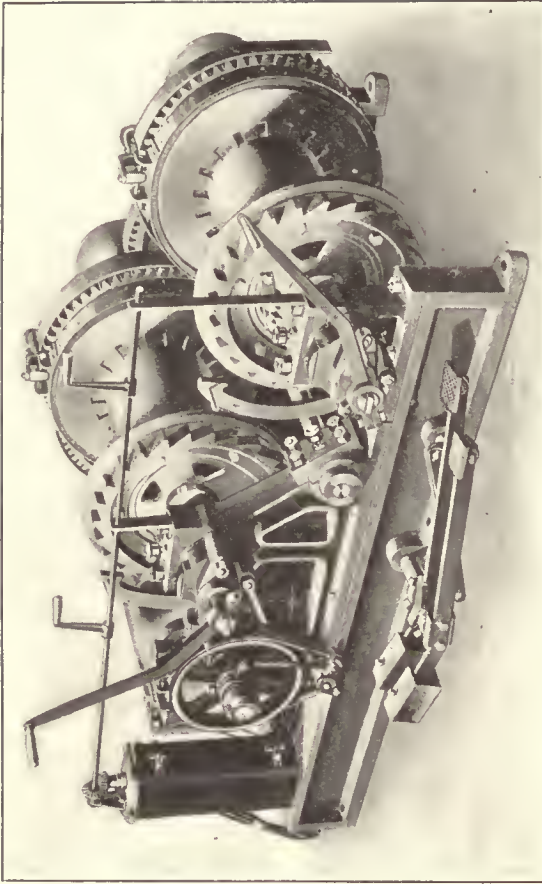

Two-Drum Electrically-Operated Winch

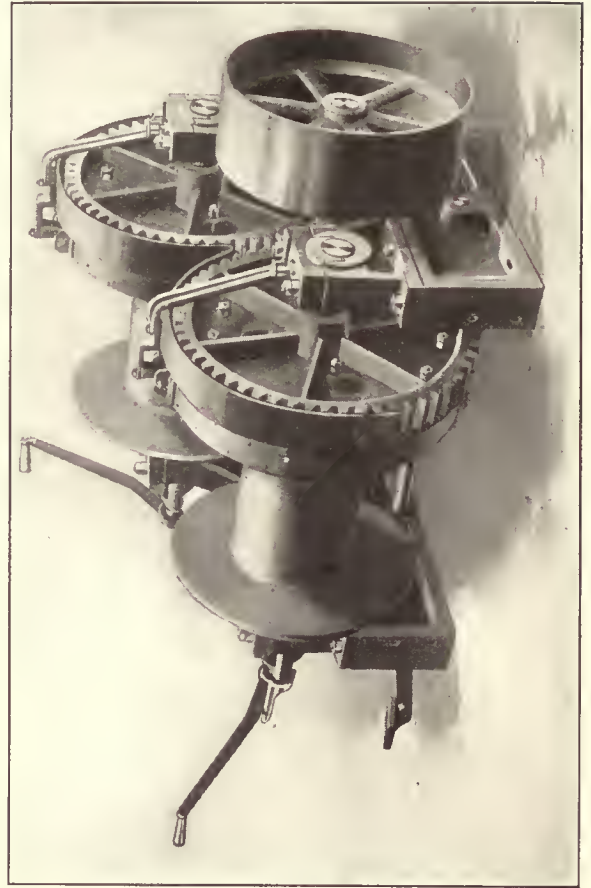

Two-Drum Winch Fitted with Pulley for Belt Operation

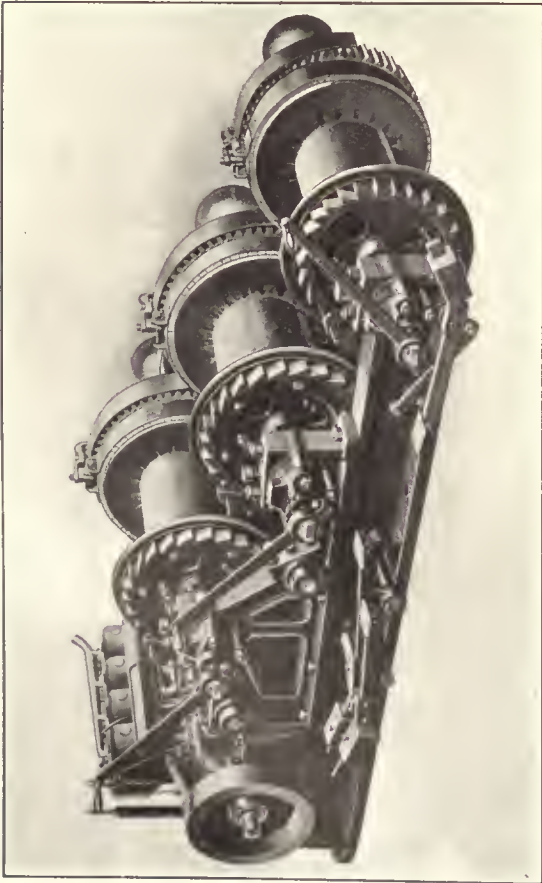

Three-Drum Gasoline-Operated Winch

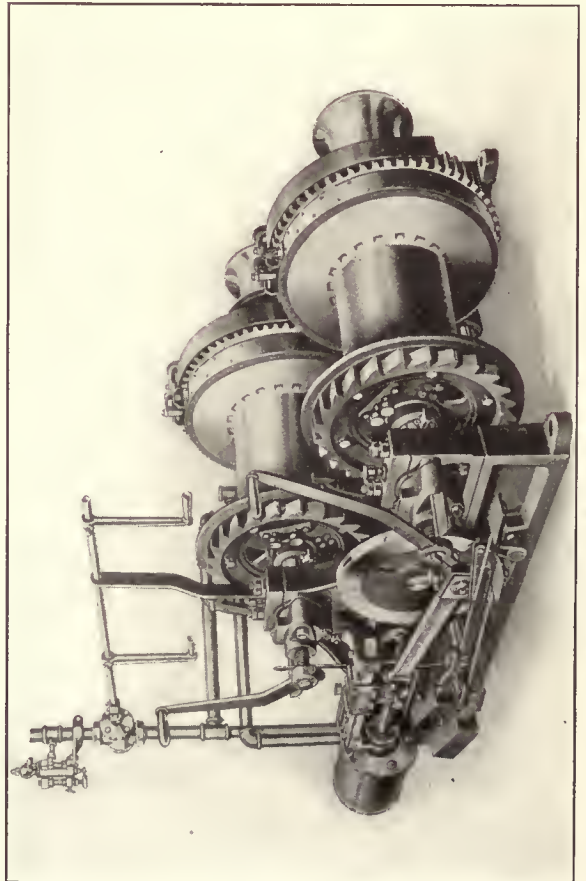

Two-Drum Steam-Operated Winch Piped for Connection to Steam Line

jaacent flange of the drum. The friction surfaces of the blocks may be of wood; asbestos; cork; various fabrics; or special compositions of metals having high frictional qualities. The clutch is operated by means of a quick-pitch screw which forces the drum along the shaft and into contact with the friction blocks.

Clutches of the sliding types are also used on many power winches. One design of this type consists of a planetary gear train and a three-part toothed clutch. Teeth cut in both edges of the internal gear, which is free to slide back and forth on the drum shaft, forms a double clutch member which may be brought into mesh with teeth on either of two fixed clutch members—one secured to the web of the large drum gear, the other to the gear case. This provides for two speeds the maximum speed being obtained when the sliding clutch is in contact with that on the drum gear. When the sliding member is in contact with the part fixed to the gear case the speed of the drum is reduced to that of the planetary gear which rotates about the drum shaft. When it is desired to stop the movement of the drum the sliding clutch is thrown into a neutral position—not in mesh with either of the fixed members.

Steam Winches

Steam winches generally have the boiler mounted on the platform with the winch thus making a self-contained portable unit. Where a power plant is available, however, many of them are provided with piping so that they may be connected to a steam line which permits their use without the necessity of maintaining an independent steam boiler.

Electric Winches

Electric winches obtain power from an adjacent power line, by means of a plug-in connection. They may have the control device installed on the machine itself or may

be provided with remote control—a portable controller connected to the winch motor by a flexible cable which permits the operator to stand in view the work while the winch itself may be placed in any convenient location.

Gasoline Winches

Gasoline winches are especially adapted for use where lack of suitable fuel and water makes it difficult and expensive to obtain steam power, or where electric power is not available. They are particularly suitable for use where a portable machine is desired. The construction of the winch itself is substantially the same as the steam or electrically operated winches but, as the gasoline supply is carried on the same mounting it is a self-contained unit and is easily moved as the work requires. They are made with one; two; or three drums, sometimes being also equipped with derrick swinging gear or with winch heads.

Horse-Power Winch

The horse-power winch or "whim" as it is sometimes called is adapted for use where only occasional light service is required or in remote districts where other power is not available. This type of winch usually consists of a single drum rotated by bevel gears attached to one of the drum flanges and meshing with bevel gears on a vertical shaft. This shaft is rotated by means of a beam—sometimes being 12 ft. in length—to which a horse or mule is hitched at the outer end and travels in a circle around the winch.

In a modification of this type of winch, the vertical shaft is placed apart from the winding drum and is connected to it by means of chains passing around large pulleys on the bevel gear shaft and the drum shaft. These machines may be equipped with single gears for one speed only or with double gears for two-speed operation.

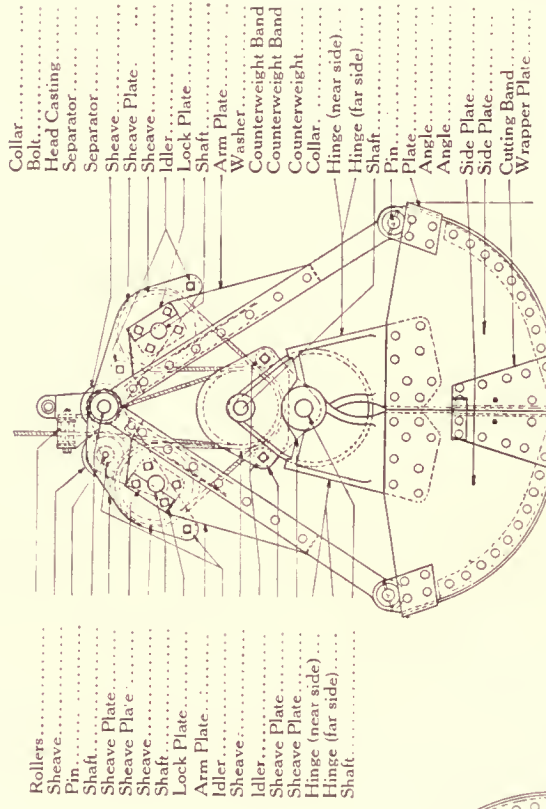
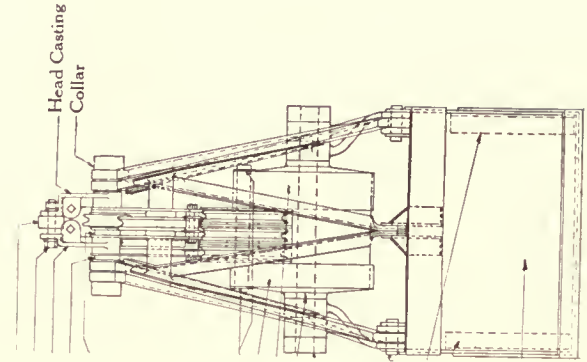
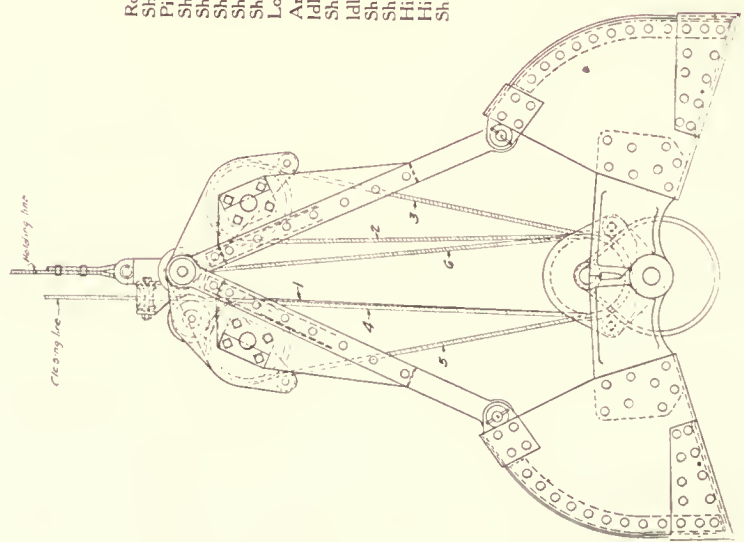
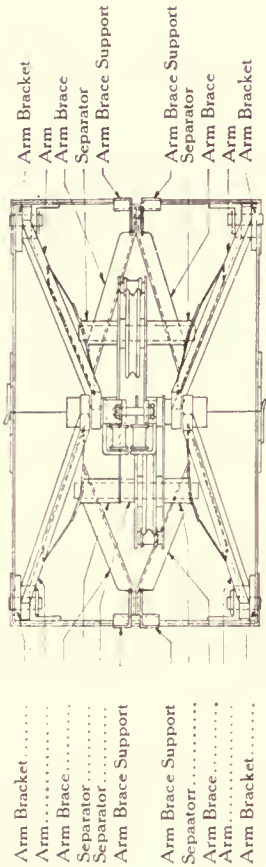

Diagram of Automatic Grab Bucket Reeved with Six Parts of Line and Showing Location and Name of Parts

Accessories

MANY DIFFERENT MATERIAL handling devices have been developed as accessories to cranes, derricks, cableways, and other material handling machinery, and they have greatly increased the usefulness of such machines. They include buckets, tubs, skips and baskets; electric magnets; grapples of both the manual and automatic types; grab-hooks, slings and other devices.

These accessories are indispensable to the proper utilization of material handling machinery in manufacturing plants, or in railroad or marine operations, for handling loose or heavy materials; or in construction work to handle the building materials and to facilitate erection work. Buckets, particularly grab-buckets of the automatic types, should be used where large quantities of loose material are handled; tubs and skips for loose material or small parts not suitable for, or liable to breakage if handled with a grab-bucket; grab-hooks and slings for large pieces, such as blocks of stone, poles, lumber, girders and bulky packages, and electric magnets for handling either scrap or manufactured metals.

Buckets

Automatic buckets originally were considered only as digging and loading devices, but their wider field of usefulness has now become generally recognized. Buckets of various designs have been developed, and these may be divided into four classes or types: Grab-buckets of the clam-shell, orange-peel or scraper designs; drag-line buckets; turnover buckets; and bottom-dump buckets. These may be used successfully on any machine having one or more hoisting lines. They are especially adapted to such service as handling fuel and ashes in power plants; in foundries, or other operations where loose materials such as coal, coke, and ore are used; to dig earth, sand, or gravel and load it into a car, barge or other vehicle; to unload any loose material and handle it into storage or to re-handle it from storage and convey it to the point at which it is to be used; to handle mortar or concrete in construction work; and for dredging.

Grab-Buckets

Grab-buckets of the various types are all operated in a similar manner, being opened and closed automatically by means of lines connected with the hoisting mechanism. They are designed with power wheels, power arms, or with a series of sheaves or levers, and they perform either a scooping, scraping or a digging operation as they close.

The closing power of a grab-bucket must be adequate to meet the conditions under which it is to be operated, and this may be assured by using a single part line, a two-part or a several-part line—the line being reeved through two, three, four, five, or six sheaves as the case may be. The closing power, and consequently the

digging capacity, becomes greater as the number of parts of the line passing over sheaves is increased, but the speed of operation becomes less. Therefore, a bucket for handling fine loose material requires only a single line, or a two-part line, while a bucket intended for handling heavy, coarse material, or for digging purposes should have a greater number of parts of the line reeved. In two-line operation, which is most commonly used, a holding line and a closing line—each controlled by a separate drum on the hoisting winch—are used. Buckets operated in this way are raised or lowered by the holding line, while the opening and closing of the bucket is accomplished by a closing line reeved through two or more sheaves. They may be used on any crane, derrick, or other machine equipped with two drums in addition to the mechanism required to operate the various parts of the machine itself.

For single-line operation the bucket is designed so that a single line acts as both a holding and a closing line. It is so proportioned that it is automatically opened by gravity, as it hangs free and is locked in the open position by means of a dog which engages in the bucket mechanism. In operation the bucket is lowered onto the material to be handled which causes

the release of the dog and permits the bucket to close and fill as it is hoisted. A trip is provided so that the bucket may be opened and the load dumped, while suspended in the air. Buckets of this type are used with overhead cranes, unloading bridges, monorail cranes, cableways and other material handling machinery having only one drum available for bucket operation.

Either the two-line or the single-line method may be used in duplicate and they are arranged in that way on some buckets to impart stability as well as to increase the closing power.

For general service, the ends of the lines are attached directly to the bucket but when used on some types of machines such as coal storage bridges and other unloading machines, the bucket generally is suspended and operated in the bight of the line. In such cases, one end of each line is secured either to the trolley or to the trackway. The lines then pass through sheaves in the upper and lower heads of the bucket and the other ends of the lines are attached to the hoisting drums.

A good quality of flexible wire rope is preferable for bucket operation and is in general use, but some parts of bucket operation may be properly performed by chains, and they are used on a great many buckets, particularly those of the power-wheel type. All ropes and chains should be reeved so that they are protected from chafing.

The scoops of grab-buckets should be constructed of steel plate and fitted with forged steel or properly annealed steel parts. The shape of the scoop must be

Buckets: Grab; Drag-Line; Self-Dumping (Turnover, Bottom Dump); Plain Bail.
Baskets; Nets; Skips; Cinch Boards; Grapples; Hooks; Tongs; Slings; Counterweights.
Magnets: Circular and Rectangular; Safety Devices; Magnet Control; Cable Take-Up.
Sheave Blocks. Wire Rope.

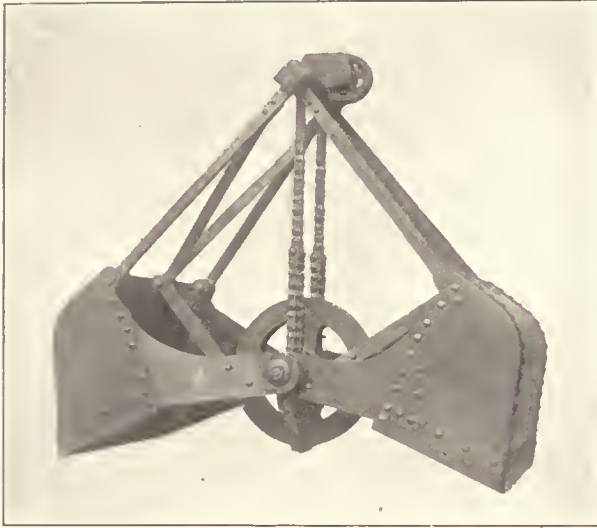

Chain Operated Power-Wheel Clam-Shell Bucket for Handling Loose Materials. Two-Line Operation

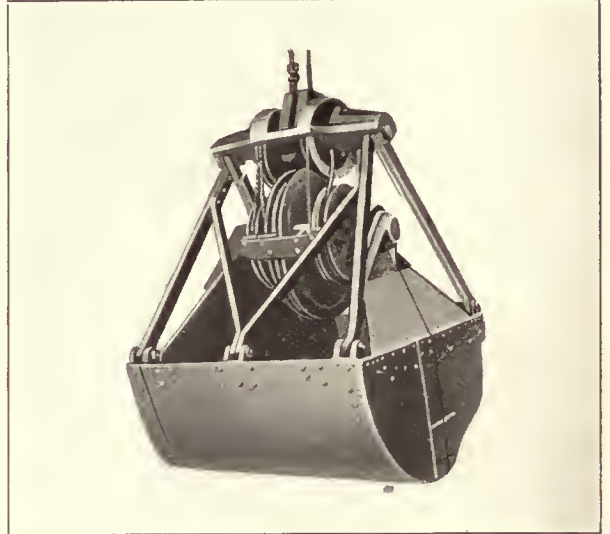

Rope Operated Power-Wheel Clam-Shell Bucket with Supplementary Sheaves. Two-Line Operation



Rope Operated Power-Arm Clam-Shell Bucket for Handling Loose Materials. Two-Line Operation

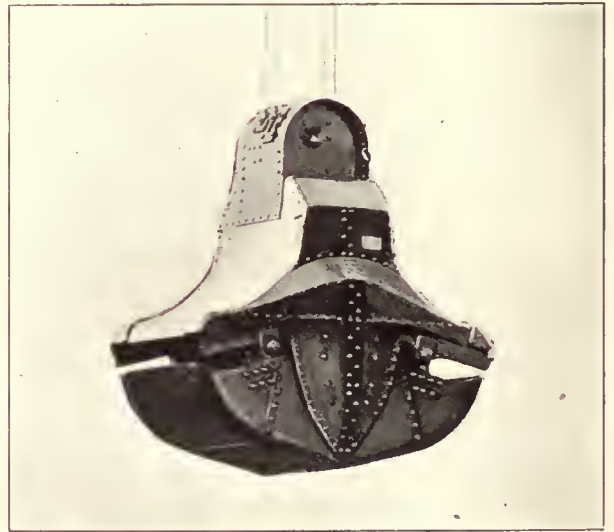

Two-Rope Grab Bucket for Handling Loose Materials and Light Excavation Work. Two-Line Operation

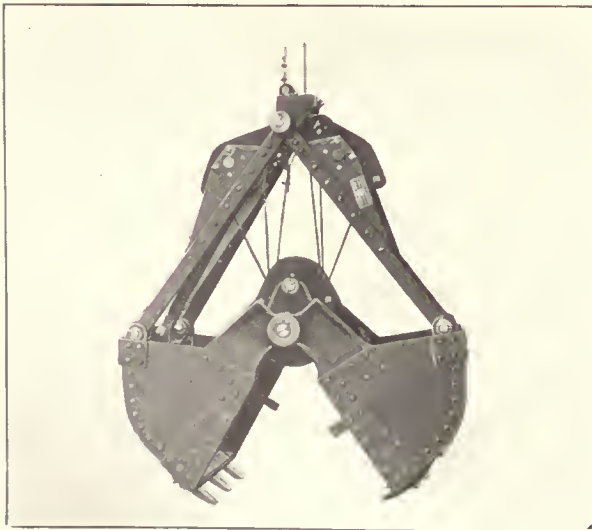

Rope-reeved Sheave Type Clam-Shell Bucket with Digging Teeth. Two-Line Operation

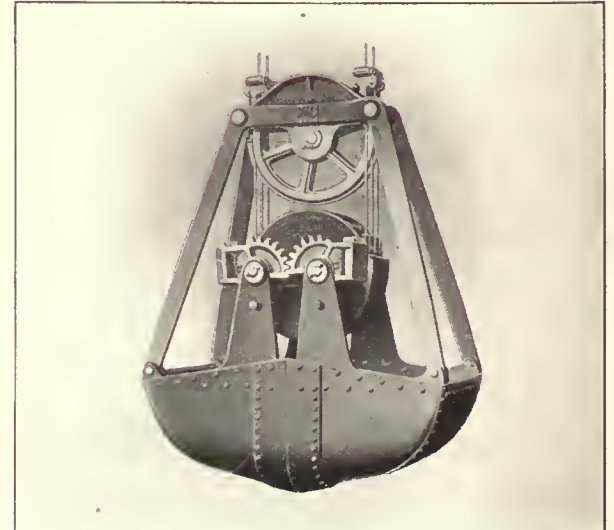

Rope-reeved Grab Bucket Operated in Bights of Line on Bridge Cranes, etc.

suitable for the service in which it is to be used. A bucket for handling loose material should have a scoop formed so that it will offer the least possible resistance to the material; the scoop of the scraper type should have a shape to facilitate its operation in a horizontal line for clean-up work and leveling off; and those buckets intended for dredging and general digging purposes should have the scoop so shaped that the downward or digging motion will continue until the bucket fills and closes. The digging capacity of a clam-shell bucket may be greatly increased by attaching hardened steel blades or pointed teeth to the working edges of the scoops, and it may then be used in heavy excavation work.

The closing or purchase arms, or the closing levers, should preferably be of a rolled steel, but some designs of closing arms may be constructed of annealed cast steel of adequate section to give the required strength. All sheaves and power wheels for buckets of large capacities should be of cast steel; a good quality of gray iron casting may be used on smaller buckets. The sheave pins and closing arm shaft should be of large diameter hardened rolled steel to reduce wear to a minimum.

The weight of the moving parts generally is concentrated as much as possible on the lower head and on many types of buckets this is sufficient to cause it to open promptly as the closing line is slacked off. In some designs, however, additional weight—a counterweight—is secured to the hinge shaft or some other part of the lower head of the bucket to insure a rapid opening movement when the lines are slacked off.

Provision should be made for the easy and efficient lubrication of all moving parts, and wherever possible such parts should be encased to exclude dirt and to prevent oil drippage.

Clam-Shell Type

The clam-shell bucket is a type of grab-bucket used largely for handling sand, gravel, ore, and coal, or for other loose materials which do not pack tightly or may be dug easily. This type of bucket usually is operated by the two-line method, though the single-line method sometimes is used. In the two-line method, the holding line is secured to some part of the bucket closing mechanism.

In the power-wheel type the closing line is secured to, and wound several turns around, a drum or power-wheel and passes upward, over a sheave, to the hoisting mechanism. Short closing chains or cables, fastened to the bucket head and to the drum or power-wheel shaft, wind on the shaft as the closing line is raised and, the drum shaft, being secured to the scoop arms, draws the arms upward, and the scoops inward, closing the bucket. The bucket is dumped by stopping the hoisting drum thus making fast the holding line and then slacking off the closing line.

Another design of power-wheel bucket has two closing chains fastened to shackles at opposite ends of the hinge shaft and carried up over sheaves suspended from the head block, thence around the closing drum, which is loosely mounted on the hinge shaft and provided—at opposite points on its circumference—with “U” bolts to which the closing chains are fastened. To insure an equal division of the load strain between the two chains, the sheaves are mounted in the opposite ends of an equalizing frame pivoted at the center to the head block of the bucket. Approximate

proportions of buckets of this type are given in the following table:

EQUALIZED CHAIN-OPERATED POWER-WHEEL CLAM-SHELL BUCKETS

Cap. Cu. Yd.	Closed				Width Ft. In.	Open				Wt. Lb.	
	Length		Height			Length		Height			
¾	5	0	5	11	3	1¾	6	5	7	0	1950
1	5	6	6	5½	3	5¾	7	1½	7	7½	2620
1½	6	2	7	3	3	10¾	8	1½	8	6½	3965
2	6	10	8	1¼	4	4	8	9	9	6¾	5200

A modification of this type of bucket has the power-wheel supplemented by sheaves at each side, while still another type dispenses with the power-wheel and has two or three groups of sheaves at the center of the bucket. These two types usually are reeved with wire rope, but chains sometimes are used for parts of the operation. This multiple arrangement of sheaves gives greatly increased power and permits easy handling of coarse and hard materials.

The rope-reeved sheave type of grab bucket is operated in several ways, a common arrangement consisting of a multiple sheave at the top head and a similar sheave secured to the hinge shaft, reeved with several parts of line in the same manner as an ordinary tackle. The bucket is closed by hauling in on the closing line or opened by slacking off on the line.

In a modified form of the rope-reeved type of bucket, the lower head slides up or down on two vertical guide rods secured to the upper head. The connecting rods on each side of the bucket are secured to separate pins on the upper head casting and the scoop arms on each side are fastened to the lower head casting, also on separate pins. As the closing line is hauled in, the lower head slides upward on the guides and, drawing the scoop arms with it, closes the bucket.

Another form of rope-reeved grab bucket is used chiefly on bridge cranes, hoisting towers and cableways. This type of bucket is constructed in a manner somewhat similar to an ordinary rope-reeved sheave type. It has a top head carrying three sheaves mounted on a long sleeve or bushing turning on a pin. The middle sheave, for the holding line, is keyed fast to the sleeve, the other two sheaves, for the opening and closing line, being loose. The bottom head has three sheaves for reeving the opening and closing line. They are constructed with long hubs and are loosely mounted on a central shaft. The movement of the scoops is controlled by gear segments secured to the scoop arms and to the bottom head and guiding the arms as the closing line is hauled in.

A bucket of this type specially arranged for conveying the material being handled is particularly adapted for use with coal-handling bridges, gantry-cranes and double boom hoisting towers with interconnected booms. The bucket is suspended, in bights of the opening and closing and holding lines, from a four-sheave trolley hauled along the trackway by a motor which is independent of the hoisting motor, but is controlled by the same operator. The bucket operating lines are both fastened at one end of the trolley trackway and are led over the first pair of sheaves in the trolley downward to the bucket and about its sheaves, thence upward over the second pair of shelves in the trolley, to sheaves at the other end of the trackway, thence to the stationary bucket operating drums. The trolley is traveled along the trackway by ropes leading from the trolley in opposite directions and actuated by an inde-



Electric Motor Clam-Shell Bucket with Electric Cable Take-Up Reel Attached. Single-Line Operation

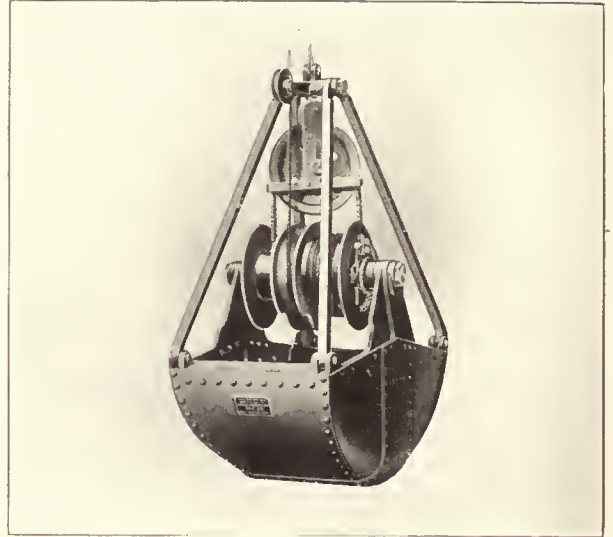

Differential Type, Rope Operated Clam-Shell Grab Bucket

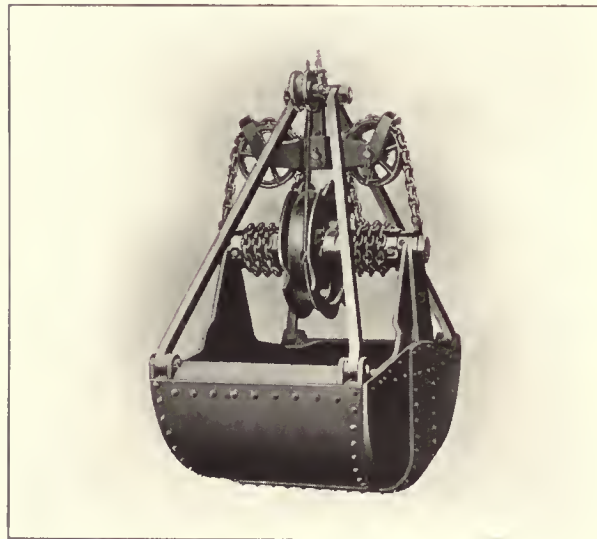

Rope and Chain Operated, Side Sheave Power Wheel Grab Bucket

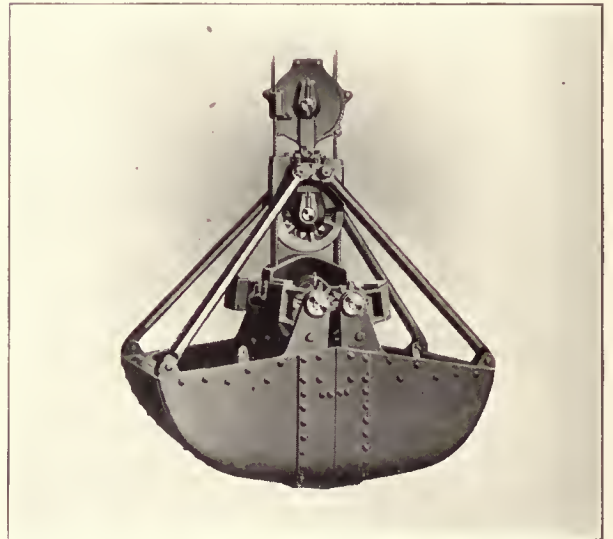

Rope-Reeved Grab Bucket Operated in Bigfts of Line on Hoisting Towers, Cableways, etc.

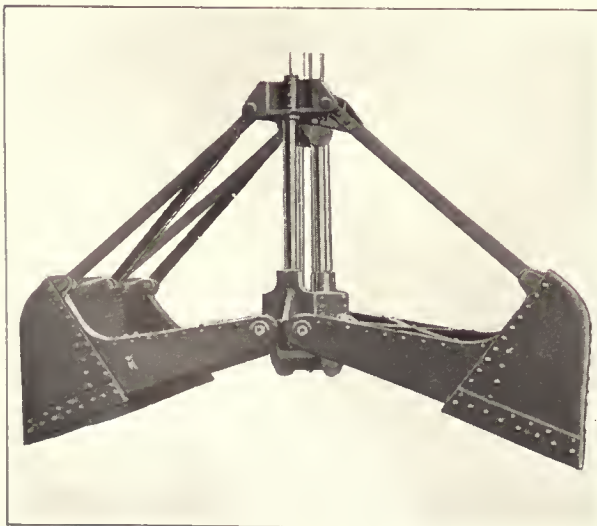

Vertical Guide, Rope-Reeved Clam-Shell Grab Bucket

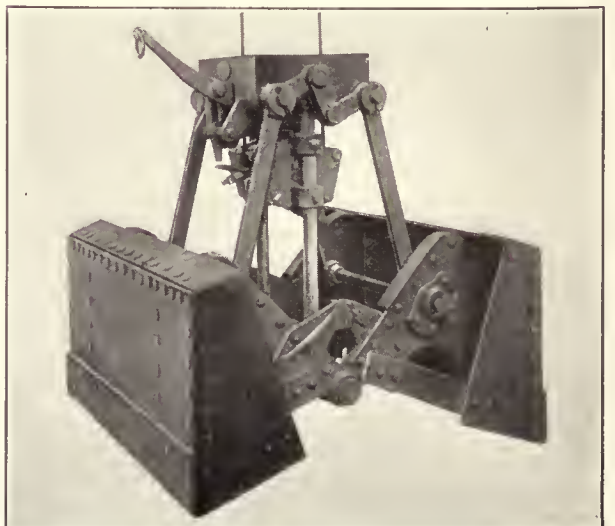

Vertical Guide, Rope-Reeved Scraper Clam-Shell Grab Bucket

pendent reversible trolley traveling machine. The proportions of some buckets of this type are given in the following table:

ROPE-REEVED SHEAVE TYPE CLAM-SHELL BUCKET FOR COAL HANDLING

Coal Cap. Tons	Closed				Open				Wt. Lb.		
	Length		Height		Length		Height				
	Ft.	In.	Ft.	In.	Ft.	In.	Ft.	In.			
1½	7	3	9	4	4	4	10	9	10	5½	6950
2	8	0	10	11	4	8	12	3	12	0	10800

Another bucket of this type is particularly adapted for use with an inclined-boom hoisting tower or with a suspension cableway, or other form of hoisting apparatus, in which it is desirable that the bucket be hoisted by a two-part purchase in order to reduce the strain at the hoisting drums and to prevent twisting of the bucket. Both operating lines are made fast to the trolley, or other supporting device, and are led downward to the bucket, thence upward to sheaves carried by the trolley or other support and thence to the hoisting drums. The holding line is reeved through a sheave carried in a frame flexibly connected to the top head of the bucket, and the opening and closing line through sheaves in the top and bottom heads of the bucket in the usual way.

Another method of operating a grab bucket is by means of a differential drum mounted on the hinge shaft which also carries the winding drum or power-wheel. The bucket is opened and closed by the differential action of the two parts of the differential drum—one part on each side of the power-wheel—about which a closing sling or cable of wire rope is coiled in opposite directions. One end of the closing sling is fastened to the larger portion of the differential drum and, passing over a sheave carried in a frame pivoted to the head block, has its other end attached to the smaller portion of the drum. To close the bucket the closing sling is wound upon the larger portion of the drum and is uncoiled from the smaller portion. As the sling moves faster over the large portion of the differential than on the smaller portion great closing power is secured. The movement is reversed to open the bucket. The following table gives the proportions of some buckets of this type:

DIFFERENTIAL TYPE CLAM-SHELL BUCKETS

Cap. Cu. Yd.	Closed				Open				Wt. Lb.		
	Length		Height		Length		Height				
	Ft.	In.	Ft.	In.	Ft.	In.	Ft.	In.			
¾	4	5½	6	8	3	13½	6	8	7	2	2973
1	5	0	7	6	3	5½	7	5	8	0	3900
1½	5	6	8	4	3	10¾	8	2½	8	10¾	4986
2	6	0	9	1	4	4	9	0	9	9	6600

Another design of the clam-shell bucket has a rigid power-arm fastened to one of the scoops and carrying one or more sheaves. The closing line passes from the hoisting mechanism, through a small sheave at the bucket head, to the sheave—or sheaves—fixed to the power-arm, thence to a large sheave—or sheaves—at the bucket head, and thence back to the scoop arm, where it is made fast. To close the bucket the closing line is drawn upward through the small sheave, drawing the large sheaves together at the top and raising the scoop arm, thus closing the bucket. As in the power-wheel type of bucket the holding line serves only to raise or lower the load, the actual operation of the bucket being controlled by the closing line.

These buckets range in capacity from ¼ cu. yd. to 10 cu. yd. and have a spread of scoop from 5 ft. to 17 ft. The following tables give capacities, weights and dimensions of some of the various designs of clam-shell

buckets. These proportions vary somewhat, depending on the service for which the bucket is designed.

POWER-WHEEL TYPE—LIGHT BUCKET

Cap. Cu. Yd.	Wt. Lb.	Width Ft. In.	Closed				Open				
			Height		Length		Height		Length		
			Ft.	In.	Ft.	In.	Ft.	In.	Ft.	In.	
½	1,800	3 4	5	3	4	2	5	10	5	11	
¾	2,500	3 4	6	3	5	0	7	0	7	0	
1	2,800	3 4	6	6	5	6	7	4	7	8	
1¼	3,200	3 10	6	6	5	6	7	4	7	8	
1½	3,800	3 11	7	3	6	2	8	3	8	9	
1¾	4,000	4 2	7	3	6	2	8	3	8	9	
2	5,200	5 0	7	8	6	2	8	6	8	9	
2½	6,800	5 0	8	7	7	0	9	8	10	0	
3	7,400	5 10	8	7	7	0	9	8	10	0	

POWER-WHEEL TYPE—HEAVY BUCKET

Cap. Cu. Yd.	Wt. Lb.	Width Ft. In.	Closed				Open				
			Height		Length		Height		Length		
			Ft.	In.	Ft.	In.	Ft.	In.	Ft.	In.	
1	3,700	3 4	8	1	5	7	8	10	8	3	
1¼	4,000	3 11	8	1	5	7	8	10	8	3	
1½	5,000	4 2	8	10	6	2	8	10	9	0	
1¾	5,200	4 6	8	10	6	2	9	10	9	0	
1¾	5,500	4 10	8	10	6	2	9	10	9	0	
2	6,375	4 10	9	4	6	11	10	6	9	0	
2½	6,625	5 3	9	6	7	0	10	9	10	0	
3	7,375	6 2	10	3	7	0	11	6	10	0	
4	11,000	6 3	11	6	9	0	13	6	11	6	

POWER-ARM TYPE—LIGHT BUCKET

Cap. Cu. Yd.	Wt. Lb.	Width Ft. In.	Closed				Open				
			Height		Length		Height		Length		
			Ft.	In.	Ft.	In.	Ft.	In.	Ft.	In.	
½	1,200	2 6	5	4	3	9	6	1	5	0	
¾	1,900	2 9	6	2	4	6	7	1	5	7	
¾	2,350	2 9	6	8	5	0	7	7	6	6	
1	2,750	3 3	7	0	5	7	8	2	6	11	
1¼	3,200	3 6	7	1	6	3	8	9	7	0	
1½	3,800	3 9	8	4	6	8	9	10	8	2	
1¾	4,000	3 9	8	8	6	9	9	11	8	10	
2	4,300	4 3	8	4	6	9	9	10	8	2	
2½	4,800	4 4	8	7	6	9	9	11	8	9	
2½	5,200	4 10	9	0	6	9	10	0	8	6	
3	6,000	5 4	9	5	7	3	10	9	9	10	

POWER-ARM TYPE—HEAVY BUCKET

Cap. Cu. Yd.	Wt. Lb.	Width Ft. In.	Closed				Open				
			Height		Length		Height		Length		
			Ft.	In.	Ft.	In.	Ft.	In.	Ft.	In.	
¾	2,760	2 10	7	6	4	10	8	3	6	5	
¾	3,200	2 11	7	4	5	3	8	4	7	2	
1	4,200	3 5	7	6	5	8	9	0	7	4	
1¼	4,500	3 8	7	7	6	3	9	6	7	7	
1½	5,900	3 11	9	2	6	9	10	10	9	0	
2	7,060	4 6	9	2	6	10	10	10	9	0	
2½	9,500	5 0	9	3	7	5	11	4	0	3	
3	11,000	5 6	10	5	7	5	12	5	9	10	
3½	13,500	5 6	10	8	8	0	12	6	10	4	
4	16,000	6 0	12	5	8	0	14	4	12	3	
5	20,000	6 0	12	0	9	0	14	5	13	3	
5	26,000	6 0	14	3	9	10	16	6	13	11	

ROPE-REEVED SHEAVE TYPE—LIGHT BUCKET

Cap. Cu. Yd.	Wt. Lb.	Width Ft. In.	Closed				Open				
			Height		Length		Height		Length		
			Ft.	In.	Ft.	In.	Ft.	In.	Ft.	In.	
¾	2,300	3 6	6	7	7	2	5	0	6	4	
¾	3,100	3 2	7	2	7	0	5	6	6	8	
1	3,500	3 4	7	4	7	7	5	7	7	2	
1½	4,500	3 10	8	1	8	10	6	7	7	2	
2	5,800	4 4	8	6	9	2	6	10	7	6	

Electric-Motor Bucket

An electric-motor clam-shell bucket, operated by a motor installed on the bucket itself, has been adapted for use with a hoisting machine having only one drum available. With this type of bucket, the hoisting apparatus is used only to raise and lower the load. A bucket thus equipped can be installed on a traveling or a monorail crane and is particularly adapted for use where there is only limited headroom; it may be used in foundries to handle sand on the molding floor or for handling fuel, ashes, slag, or other refuse. It can also be used with a locomotive crane, a derrick, or a telfer, for re-handling practically any loose material in industrial plants. When the bucket is equipped with digging teeth it may be used for light excavation work.

This bucket is similar in design to an ordinary clam-

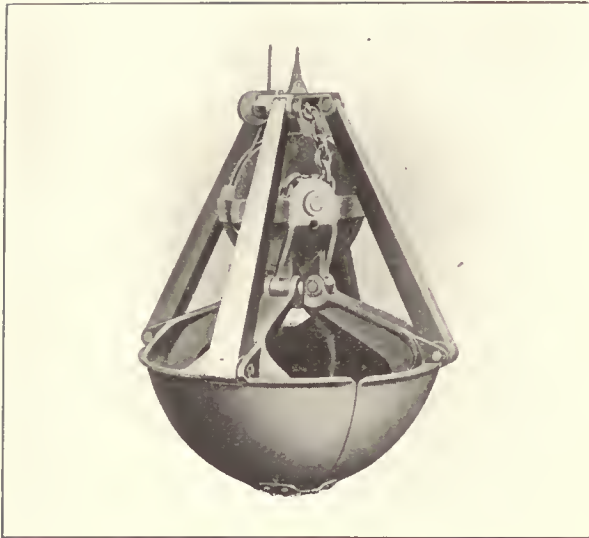

Four-Blade Chain Operated Power-Wheel Orange-Peel Bucket for General Excavation Work

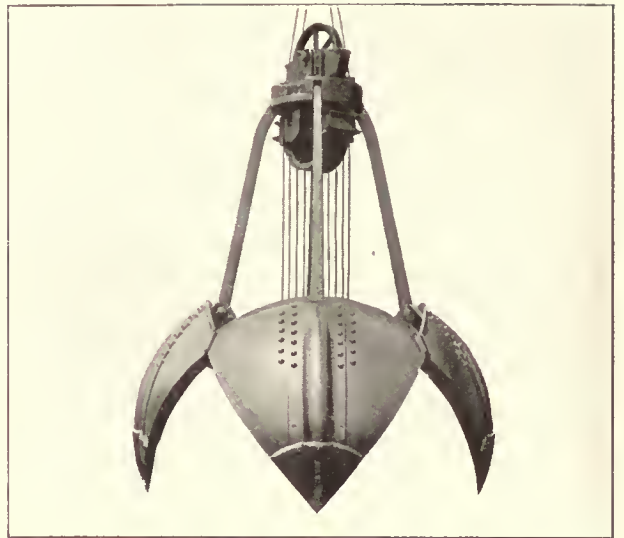

Four-Blade Rope-Reeved Sheave Type Orange-Peel Bucket for Excavation Work



Dwarf Orange-Peel Bucket without Hammer Attachment

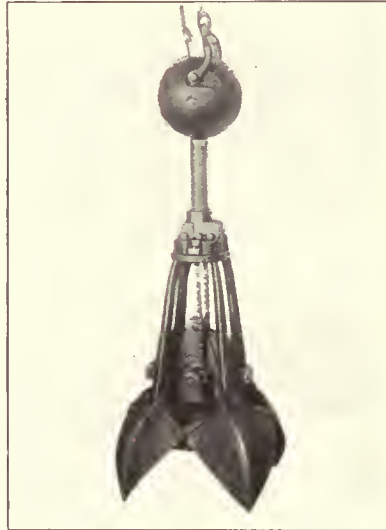

Dwarf Orange-Peel Bucket with Hammer in Raised Position



Dwarf Orange-Peel Bucket with Hammer Dropped and Bucket Closed

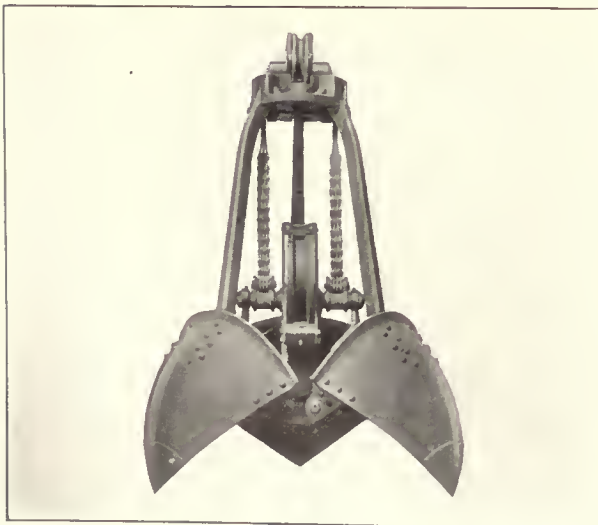

Three-Blade Chain Operated Orange-Peel Bucket for Handling Heavy Coarse Material

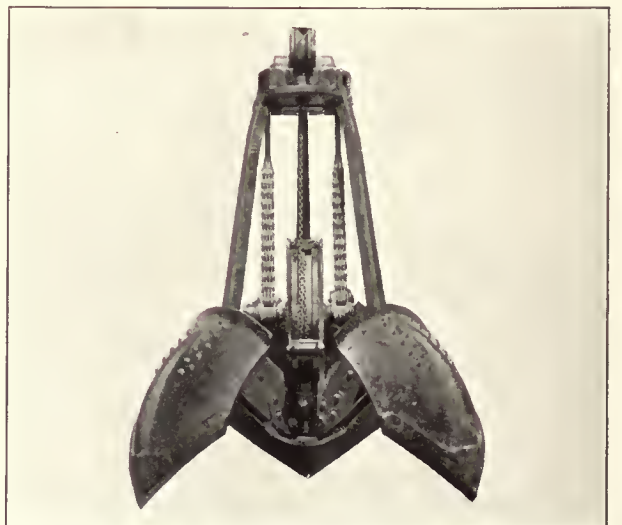

Three-Blade Orange-Peel Bucket with Blades Cut Off for Handling Large Lump Material

shell bucket, but is equipped with an electric hoist, which is secured at the bucket head and is used to operate the scoop. The motor is controlled by a simple form of controller which may be located at any convenient point near the main hoisting apparatus, or it may be located in the operator's cab.

The following table gives the proportions and weights of electric-motor buckets for light and heavy service:

ELECTRIC-MOTOR CLAM-SHELL BUCKET

Cap. Cu. Yd.	Wt. Lb.	Width Ft. In.	Closed		Open	
			Height Ft. In.	Length Ft. In.	Height Ft. In.	Length Ft. In.
3/4	2,600	3 10	5 9	4 1	6 5	5 5
3/4	3,200	3 10	6 10	4 1	7 6	5 8
1	3,700	4 0	7 7	4 8	8 4	6 4
1	4,600	4 0	6 7	4 8	7 4	6 4
1 1/4	4,700	4 3	7 5	5 1	8 1	7 4
1 1/2	4,900	4 11	7 5	5 1	8 1	7 4
2	9,000	5 7	9 0	6 1	10 0	8 9
2 1/2	10,000	5 0	9 4	7 0	10 5	9 9
3	10,500	5 10	9 4	7 0	10 5	9 9

Orange-Peel Type

The orange-peel type of grab-bucket is used for dredging and for excavating hard or sticky material; for handling large rocks or boulders; and for digging out old cribbing, pulling up piles or stumps and other similar work. It usually is operated by a power wheel in a manner similar to that used in the power-wheel type of clam-shell bucket, but is also made in the rope reeved sheave type. It is made with three or four pointed blades which gives a greater digging power for a given weight than can be obtained with the clam-shell type, and the manner in which the blades open insures the quick dumping of the material. The four-blade bucket is used for general purposes, but the three-blade type is especially adapted for very heavy duty in digging and rehandling rocks and boulders. Where such buckets are designed principally for use in handling rock, the blades are cut off at the upper corners, thus reducing the total weight of the bucket without reducing its capacity for handling such material.

Many orange-peel buckets are operated by a power wheel in a manner similar to that used in the power wheel type of clam-shell bucket. In a common method of power-wheel operation for this type of bucket, the closing chains are made fast to the bucket head and to the drum or power-wheel shaft. A chain is also sometimes used for that portion of the closing line in contact with the power-wheel.

In another design of orange-peel bucket the closing chain is a single piece of standard crane chain which passes over a saddle formed in the upper pivot of the bucket arms and has its ends fastened to lugs on the power-wheel. The chain is free to move over the saddle and thus equalizes the strain on the chain as the power-wheel is operated and the closing chain winds on the shaft.

Buckets of the orange-peel type usually are designed for use with a machine having two drums available for bucket work and for two-line operation—a closing line and a holding line. However, they may be used with a single drum machine by using a counterweight drum which can be attached to the derrick, or crane, or other machine and, by means of a counterweight, controls the operation of the bucket.

Dwarf Orange-Peel Bucket

A dwarf orange-peel bucket is used for such operations as the digging of wells or other excavation work; for cleaning out sewer catch basins; or anywhere that a small diameter of bucket may be required. In construction, these buckets are similar to the larger sizes,

of the power-wheel type. They generally are operated by hand on a small derrick, but can be suitably equipped for power operation on derricks, cranes, or other hoisting machines.

Because of the light weight of these small buckets a hammer attachment is provided for use when very hard digging is encountered. This hammer consists of a heavy metal ball bored to fit over and to slide on a shank on the bucket head. It is attached to the bucket holding line and rises or falls as the line is hauled in or payed out, the weight of the bucket being carried by a stop on the shank which prevents the ball from slipping off. When the bucket is lowered to the work the ball may be alternately raised and dropped on the bucket head, thus driving the points of the bucket blades into the material being excavated.

Orange-peel buckets range in sizes from the dwarf type, 11 1/2 in. in diameter when in the open position and having a capacity of 100 cu. in., to the largest size, 14 ft. 8 in. in diameter when in the open position and having a capacity of 10 cu. yd. The general proportions of orange-peel buckets are given in the following tables:

POWER-WHEEL TYPE—FOUR-BLADE BUCKET

Cap. Cu. Yd.	Wt. Lb.	Closed		Open	
		Diameter Ft. In.	Height Ft. In.	Diameter Ft. In.	Height Ft. In.
1/4	1,300	3 6	5 0	4 3	5 7
1/2	2,300	4 9	6 0	6 2	7 0
3/4	3,800	5 5	7 6	7 0	8 1
1	4,800	6 0	8 4	7 9	8 8
1 1/4	5,600	6 4	8 8	8 1	9 2
1 1/2	7,100	6 7	9 6	8 6	9 10
2	9,500	7 2	10 0	8 7	11 3
2 1/2	10,500	7 10	10 6	9 5	11 11
3	12,000	8 2	10 9	9 11	12 4
4	15,000	9 0	12 7	10 7	14 4
5	19,000	9 8	13 2	11 5	14 11
6	26,000	9 8	13 6	11 7	15 6
8	29,000	10 4	14 6	12 6	16 6
10	34,000	11 6	16 6	13 8	17 6
10	39,000	12 0	18 0	14 8	20 0

POWER-WHEEL TYPE—THREE-BLADE BUCKET

Cap. Cu. Yd.	Wt. Lb.	Closed		Open	
		Diameter Ft. In.	Height Ft. In.	Diameter Ft. In.	Height Ft. In.
3/4	4,500	5 1	8 0	6 3	8 9
1	5,200	5 8	8 3	7 0	9 3
1 1/4	4,800	5 8	8 3	6 10	9 3
1 1/2	5,400	6 0	8 6	7 3	9 6
2	8,500	6 4	9 8	7 10	10 8
2 1/2	9,000	7 0	10 2	8 6	11 6
3	11,800	7 8	10 4	9 5	11 9
4	13,200	8 0	10 7	9 9	12 0
5	25,000	8 10	12 8	10 10	14 6
5	30,000	9 8	13 3	11 7	15 0

ROPE REEVED BUCKET

Cap. Cu. Yd.	Wt. Lb.	Closed		Open	
		Diameter Ft. In.	Height Ft. In.	Diameter Ft. In.	Height Ft. In.
3/4	5,200	5 1	8 6	6 4	9 4
1	5,600	5 8	8 10	7 0	9 10
1 1/4	6,200	6 0	9 2	7 5	10 4
1 1/2	10,000	6 4	10 6	8 0	11 6
2	11,000	7 0	11 0	8 8	12 3
2 1/2	12,000	7 8	11 3	9 5	12 8
3	13,000	8 0	11 6	9 9	13 0

POWER-WHEEL TYPE—DWARF ORANGE-PEEL BUCKETS, FOUR-BLADE WITH AND WITHOUT HAMMER

Cap. Cu. In.	Wt. Lb.	Bucket Closed				Bucket Open			
		Diameter Ft. In.	Height Ft. In.		Diameter Ft. In.	Height Ft. In.			
100	35 65	0 10	1 6	2 0	0 11 1/2	1 8	2 7		
220	40 70	0 11	1 7	2 1	1 1	1 9	2 8		
300	45 75	1 1	1 8	2 2	1 3	1 11	2 10		
1,500	190 310	1 7	2 11	3 9	1 10	3 4	4 10		
1 cu. ft.	210 330	1 10	3 1	3 11	2 2	3 6	5 0		

* Without hammer; † with hammer

Scraper Type

The scraper bucket is a wide-opening grab bucket of the clam-shell type which gathers its load by a com-



Chain-Bridle Drag-Line Bucket Digging Loose Material



Chain-Bridle Drag-Line Bucket Dumping Loose Material

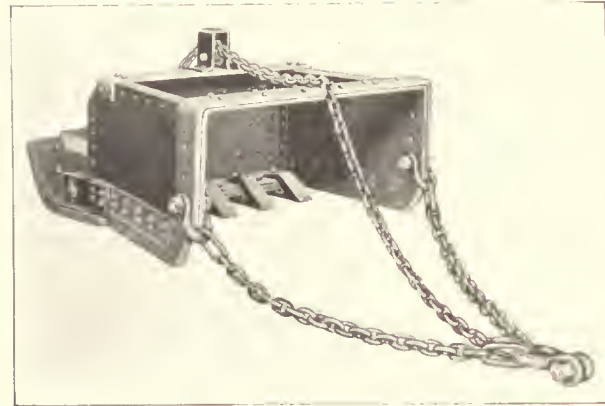

Bottomless Power-Scaper Drag-Line Bucket for Digging Hard-Packed Material

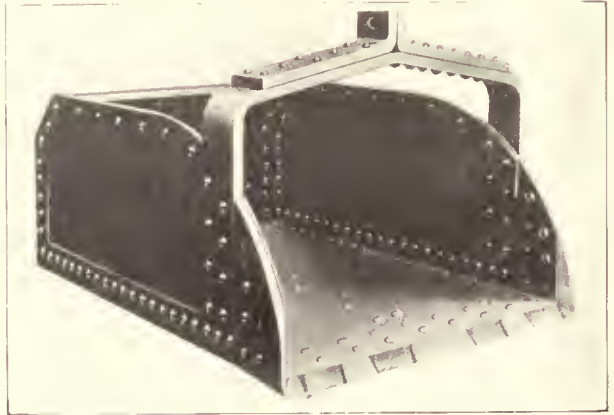

Rigid-Bail Drag-Line Bucket for Digging Gravel Under Water



Hinged-Bail Back-Gate Drag-Line Bucket Digging Loose Rock



Hinged-Bail Back-Gate Drag-Line Bucket Dumping Soft Clay

bined digging and scraping action. Buckets of this type have a very strong closing power and are especially useful in handling closely packed sand, large lump coal or heavy ore, or any similar material not easily handled by the ordinary clam-shell bucket. Because of their wide spread in the open position, they also are useful in cleaning up loose material in storage bins, or boats, or cars. When designed solely for clean-up service, they are made with an extra wide spread and large capacity. By adding steel teeth to the edges of the scoops to penetrate hard material, they may be used for excavation work in clay or hardpan.

These buckets differ from the ordinary clam-shell bucket in the shape of the scoops and the arrangement of the sheaves and rods, or levers, of the closing mechanism. This, with the extra wide spread in the open position and the line of action as the bucket is operated, gives the horizontal or scraping movement which is a distinguishing feature of this type of bucket.

They range in weight from 3,300 lb. to 24,000 lb., having capacities from $\frac{3}{4}$ cu. yd. to 10 cu. yd. and a spread ranging from 8 ft. 2 in. to 23 ft. 9 in. in the open position. The following tables give the most common sizes and proportions of scraper buckets:

ROPE REEVED SHEAVE TYPE

Cap. Cu. Yd.	Wt. Lb.	Width Ft. In.	Closed		Open	
			Height Ft. In.	Length Ft. In.	Height Ft. In.	Length Ft. In.
2½	10,000	4 8	10 6	8 3	11 7	13 0
3	11,000	5 8	10 6	8 3	11 7	13 0
4	12,000	7 0	10 6	8 3	11 7	13 0
5	14,000	7 0	12 0	9 0	13 6	14 6
6	18,000	7 9	12 0	9 6	13 6	14 6
8	22,000	7 9	13 0	10 6	14 6	15 6
10	26,000	9 0	14 0	11 6	16 0	17 0

CHAIN AND ROPE REEVED SHEAVE TYPE

Cap. Cu. Yd.	Wt. Lb.	Width Ft. In.	Closed		Open	
			Height Ft. In.	Length Ft. In.	Height Ft. In.	Length Ft. In.
1	4,300	2 9	6	5½	8	7½
1½	5,200	3 3	6	11½	9	12 4
2	5,900	3 8	7	4	7	10½
2½	8,000	4 4½	8 9	7 7½	11 1	14 11½
3	9,200	4 7½	9 3½	8 1½	11 9	15 10½
4	11,700	5 1½	10 3	8 11½	12 11½	17 6½
5	14,100	5 6	11 ¾	9 7½	13 11½	18 10½
7½	19,700	6 3½	12 7½	11 0	15 11½	21 7
10	24,000	6 11	13 10½	12 1½	17 7	23 9

Drag-Line Type

The drag-line bucket—sometimes called a drag-scraper—is used in excavation work when the conditions under which the bucket must operate will not permit the use of a grab bucket, or when a steam shovel is not available or can not be placed in a suitable position to do the work. It can be operated by any of the various types of skid excavating machines; on a cableway; by a locomotive crane; or by other types of machines when they are equipped with a double-drum winch. These buckets are also used for handling coal in storage or for other loose materials.

The manner in which the load is gathered permits the drag-line bucket to be swung a considerable distance beyond the end of the boom, when used on that type of machine, giving it a much wider range than a steam shovel or a grab-bucket. That feature, and its adaptability to cableway operation, make it most desirable for certain classes of work in locations not easily reached by other apparatus. This type of bucket has great digging power and it successfully digs such material as hardpan and shale; handles large pieces of rock, or other heavy lumpy material; sand or gravel; and soft sticky materials such as clay, or mud. It will operate on a downward slope as well as on an upward slope and may be manipulated to leave a finished grade, thus eliminating grading expense.

The bucket usually is a steel shell, or bowl, of a rectangular or slightly tapering form, with a wide cutting edge to clear a path for the bowl and permit its being easily drawn through the material being excavated. The shell must be adequately braced with cast or forged steel ribs and corner plates and equipped with steel hauling lugs and, for severe digging service, with steel teeth riveted to the working edge. A pulling bail—sometimes hinged, sometimes rigid—or an adjustable chain bridle, is attached to the shell. The action of the bail or bridle, together with the shape of the cutting edge or the teeth, imparts a diagonally downward thrust as the bucket is dragged through the material and causes it to fill. The drag line is then hauled further in, the bucket automatically taking a tilted position. The bucket is then carried by the excavating machine or the cableway to the point where the material is desired, and the load dumped—in some types by dropping the front of the bucket downward and in other types through a back-gate.

Drag-line buckets are made in capacities from $\frac{1}{3}$ cu. yd. to $3\frac{1}{2}$ cu. yd. The following table gives the proportions of some buckets of this type:

DRAG-LINE BUCKETS

Cap. Cu. Yd.	Wt. Lb.	Cutting Edge Ft. In.
1	2,850	3 0
1½	4,550	3 6
2	5,650	4 2
2½	6,850	4 10
3	8,200	5 4
3½	9,600	5 10

Self-Dumping Buckets

A self-dumping bucket or tub generally is used with a derrick or other type of hoisting machine not equipped for grab-bucket operation, or when for some other reason it is not practicable to use a grab-bucket. Buckets of this type are made in the turn-over and the bottom-dump types and are suitable for handling concrete, mortar, sand, gravel, ore and coal or any other material that may readily be shovelled into them or dropped in from a hopper or a chute. They are substantially constructed of steel plate and are carried by a bail pivoted on trunnions on the sides of the bucket, a bail-latch keeping the bucket in an upright position; or, in some of the bottom-dump types, by a bail connected with levers attached to the drop doors.

Turn-Over Type

The turn-over type of self-dumping bucket is designed so that the center of gravity is above the trunnions when the bucket is loaded and below them when empty. This permits the bucket automatically to overturn and dump the load when the bail-latch is released and—in most designs—to then right itself.

One type of turn-over bucket has a combined spherical and rectangular shape which best withstands the rough usage of general service; or this type may be made with all flat surfaces having either flaring or straight sides and is used for handling loose materials in construction work or other lighter service.

The carrying bail is provided with a clevis or shackle to engage the hook on the hoisting machine tackle. The bail-latch may be of a design engaging the bail at the side of the bucket near the rim; or it may be of the back-lever type engaging the bail at the center just below the hoisting hook. The bail-latch usually is provided with an automatic tripping device but may be manipulated by hand.

Many buckets of this type are mounted on small wheels or rollers so that they may be moved easily without the

HOISTING MACHINERY



Self-Dumping Straight Side Turnover Bucket with Rim Bail-Latch



Self-Dumping Semi-Spherical Turnover Bucket with Side Bail-Latch



Self-Dumping Cylindrical Turnover Bucket with Rim Bail-Latch



Controllable-Discharge Double-Bail Two-Line Bottom Dump Bucket

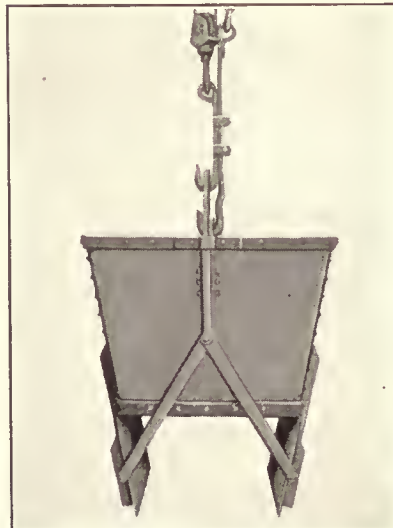

Controllable-Discharge Double-Bail Two-Line Bottom Dump Bucket

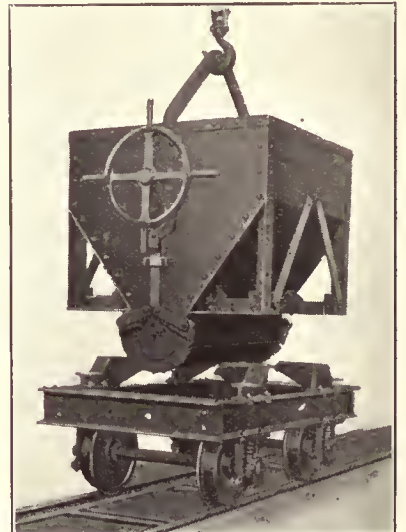

Controllable-Discharge Taper-Bottom Bucket. Hand Wheel Operation

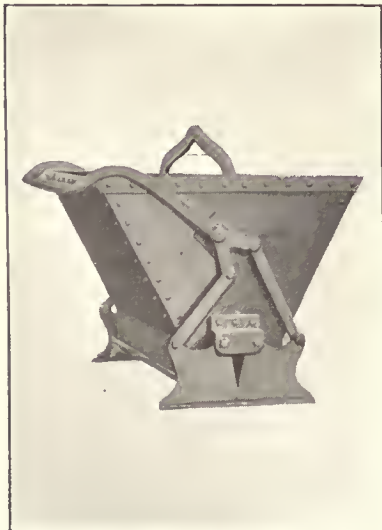

Controllable-Discharge Center-Hinged Bottom-Dump Bucket. Bell-crank Crossbar-Lever Operation



Bulk-Discharge Center-Opening Bottom-Dump Bucket. Side-Slot Crossbar-Lever Operation

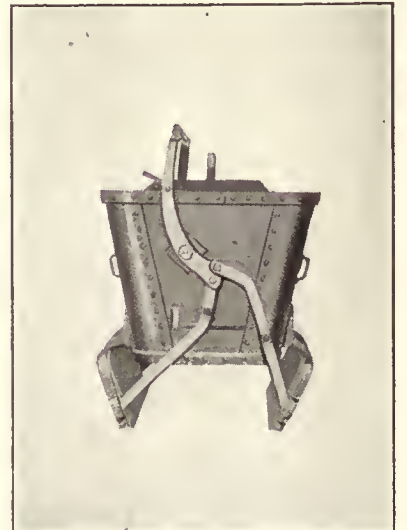

Bulk-Discharge Center-Opening Bottom-Dump Bucket. Extended-End Crossbar-Lever Operation

aid of the hoisting apparatus. The following tables give the proportions of some buckets of this type:

CONTRACTOR'S BUCKETS

Cap., Cu. Ft.	Width Over-all	Length, In.	Depth, In.
3	30	26	15
6	34	31	19
10	41	36	21½
14	46	42	25
21	48	47	28
27	53	50	31
36	65	58	35
42	66	59	34½

COAL BUCKETS

Cap., Cu. Ft.	Width Over-all	Length In.	Depth In.
20.2	42	47	34
29.7	53	52	39
41.4	51	60	44
61.3	50	73	54
82.5	67	74	54
140.0	88	83	60
292.7	103	108	76

ORE BUCKETS

Cap., Cu. Ft.	Width Over-all	Length In.	Depth In.
13.6	37	42	34
17.3	47	42	34
24.0	51	48	36
35.0	60	52	38
42.3	56	60	44
51.0	65	60	44
60.2	74	60	44
77.0	69	73	53
90.0	78	74	54
115.0	91	76	54
140.0	92	85	61

Turn-over buckets of a cylindrical form may be used with any type of hoisting apparatus for handling loose earth, sand, gravel, concrete, mortar, clay or coal. They are especially adapted for use in handling such materials in contracting work or where the service is not severe nor great speed of operation required. They are carried on a bail—sometimes having a spreader rod—pivoted on trunnions on the sides of the bucket. The bail-latch engages the bail near the rim and may be tripped automatically or may be operated by hand. These buckets range in sizes and capacities as given in the following table:

TURN-OVER BUCKETS OF CYLINDRICAL FORM

Cap. Cu. Yd.	Diameter In.	Depth In.
½	26 to 31	31 to 44
¾	32 to 35	37 to 44
1	36 to 37	43 to 48
1¼	42 to 43	49 to 51

Bottom-Dump Type

Bottom-dump buckets are used with the same types of machines as the turn-over buckets when the material must be dumped accurately, as in handling concrete or mortar in construction work, or in charging fuel or melting stock into a furnace or cupola. This type of bucket may be either rectangular or cylindrical in form and provided with double center-opening bottom doors or a single side-opening bottom door, operated by a system of levers or controlled by a latch at the base of the bucket. They are designed to permit the operator to regulate the rate of discharge; or to dump the entire load at once.

Controllable-Discharge Type

One type of controllable-discharge bottom-dump bucket is designed for two-line operation—one line attached to a fixed bail and supporting the bucket, the other attached to a sliding bail and controlling the operation of the bottom doors. The doors are operated by connecting rods attached to the sliding bail which slides—vertically—in guides on the bucket rim. Two hooks attached to the hoisting apparatus engage the double bail on the bucket. These hooks are arranged so that while the bucket is held sus-

pending the operating line may raise or lower the sliding bail attached to the door rods, thus controlling the operation of the doors and regulating the rate at which the load is discharged.

This type of bucket is easily controlled by the operator of the hoisting machine and is especially adapted to handling concrete. It is made in capacities ranging from 1 cu. yd. to 3 cu. yd. and weighing from 1,000 lb. to 2,400 lb.

Controllable-discharge bottom-dump buckets are made in several other forms—similar to the two-line bucket but controlled in a different manner. These buckets have a rigid carrying bail, secured to the rim of the bucket, and a system of door-operating rods controlled by a double lever which is pivoted at each side of the bucket and operated from a distance by means of a line attached to the lever cross-bar or operated by hand; or the door rods may be controlled by means of a wheel on the side of the bucket.

In one design of lever-operated controllable-discharge bottom-dump bucket, a bell-crank extension on the operating lever connects with the door rods which are pivoted to the bottom doors at the outer side. The bottom doors are hinged on the sides of the bucket, at the bottom near the center, and are pulled sidewise and upward instead of dropping downward. The doors are operated by pulling or pushing on the lever cross-bar. The arrangement of doors, rods and levers gives the operator complete control of the dumping operation and the rate at which the material is discharged.

Another type of controllable-discharge bottom-dump bucket is especially adapted to distribute concrete into narrow forms. This bucket has a tapering bottom with semi-circular doors operated by a system of levers connected with a hand-operated wheel on the side of the bucket. It is so designed that it may be used on a derrick or a crane in the same manner as other bottom-dump buckets, or it may be placed on a specially constructed four-wheel open-frame truck and moved on a track. Buckets of this type are especially adapted for use in handling concrete when it is to be deposited in forms and must be under constant control so that all or part of the load may be dumped.

The following table gives capacities and sizes of some buckets of the controllable-discharge type:

CONTROLLABLE-DISCHARGE BUCKET

Cap. Cu. Ft.	Bottom Open- ing, In.	Top Open- ing, In.	Depth In.	Wt. Lb.
15	16	50	37	500
23	16	54	38	750
28	16	54	42	950
36	16	54	42	1,125
45	16	66	47	1,250
55	16	66	47	1,750

Bulk-Discharge Type

The bulk-discharge type of bucket is similar in general construction to the controllable-discharge type. In one design of the bulk-discharge type, straight extensions on the operating levers, connect with the door rods and the doors are opened or closed by pulling or pushing on the lever cross-bar.

In another similar bucket the operating levers are connected to the door rods by means of a slotted plate attached to a bar moving vertically in guides on the side of the bucket. By pulling or pushing on the lever cross-bar, the bottom doors may be opened or closed.

This type of bucket is designed to handle sand, gravel, or concrete, or any similar materials when it is not necessary to control the rate of discharge. The capacities and

HOISTING MACHINERY

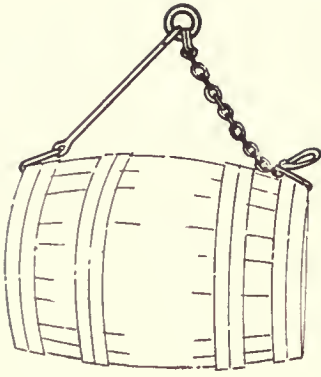

Barrel Hooks



Skip

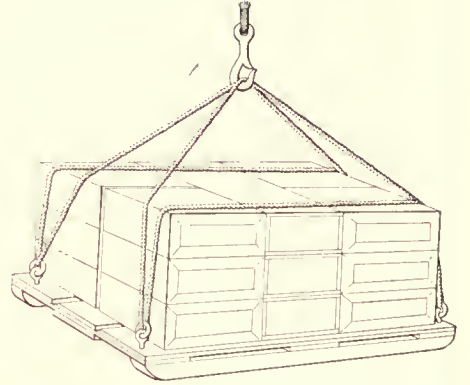

Cinch Board



Rope Sling



Chain Sling



Chain Grab Hooks

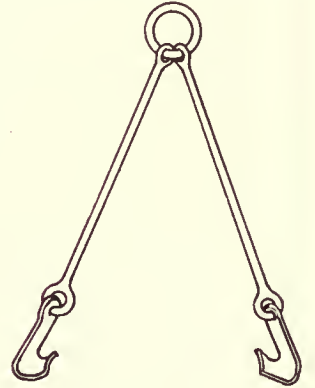

Can Hooks

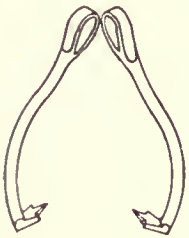

Box Hooks

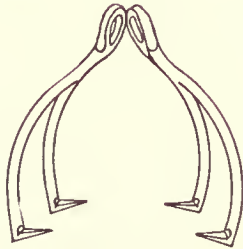

Bale Hooks



Grapple Hooks

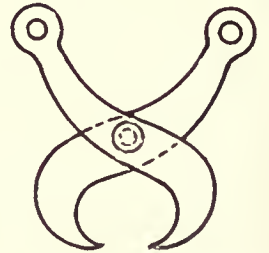

Rail Clamp

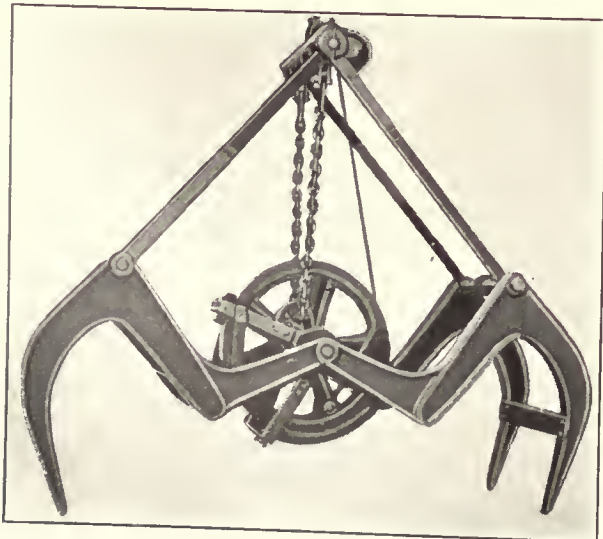

Automatic Wood Grapple

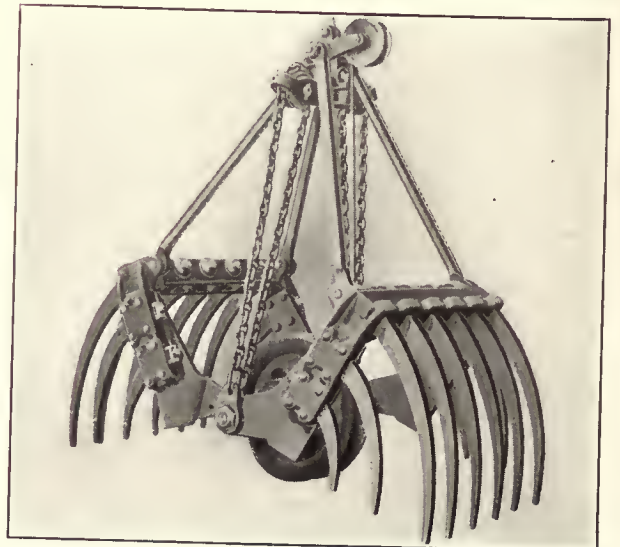

Automatic Hay and Manure Grapple

proportions of some buckets of this type are given in the following table:

BULK-DISCHARGE TYPE

Cap. Cu. Ft.	Bottom Open- ing, In.	Top Open- ing, In.	Depth In.	Wt. Lb.
6	18x22	26x22	22	425
10	22x26	31x26	26	500
17	26x30	40x30	30	625
24	28x36	45x36	32	800
28	30x36	46x36	36	1,025
37	34x40	50x40	39	1,225
49	38x44	55x44	42	1,450
62	40x51	58x51	45	2,150

Many special designs of turn-over or drop-bottom buckets are used for a wide variety of service. They are adapted to overhead or monorail traveling cranes or to telfers or cableways and are used in foundries for transporting sand, cores, small castings or other materials; or in general industrial work in outdoor or indoor service.

Plain Buckets; Baskets; Nets

Buckets, baskets and nets of the plain hand-dump types are also used in material handling operations. They may be constructed of metal, wood, rope, or canvas, and are carried by either a single rigid bail or by two flexible bails usually attached at right angles to each other.

The metal or wooden buckets are used to handle fine loose materials or for concrete; the rope and canvas baskets for handling small packages in loading or unloading vessels.

Skips

The skip generally is used with a derrick or crane for handling brick, stone, or other materials in construction work; or for handling small parts or loose materials in railroad or industrial work. The most common type of skip is rectangular in form, open at one end and at the top. It may be constructed entirely of metal or may be of wood reinforced with iron angles and straps. It is suspended at three points—at the two sides and at the open end—by chains connected, at the top, to a ring by which it is suspended from the hoist hook. A trip or trigger at the open end provides a means for dumping the load when the skip is in the desired position. These skips range upward to 2 cu. yd. in capacity.

Another form of skip consists of a simple rectangular platform having a sling connection at each corner. This type may be used for handling stone, brick, or other similar material, or may be utilized as a form of cinch board for handling packages.

Cinch Boards

Cinch boards are used with a crane or some other type packed in small containers or other forms of packages.

These boards are similar in shape to the rectangular skip and consist of a frame or platform—usually of wood but sometimes of metal—mounted on skids. An eye-bolt with a ring at each corner of the board provides a connection for ropes or slings by means of which the board and the load is raised. After the packages are loaded on the board the rope or sling is brought up over the material, one part of the rope on each side is put over the hoist hook and, as the cinch board with its load is lifted, the rope at both sides tightens over the load, holding it securely in place. The rope slips through the hook sufficiently to give the cinch board a horizontal position while being hoisted or lowered. The board projects beyond the load at each end so that the material itself is protected from injury.

Cinch boards are approximately 3 ft. wide and 6 ft.

long. They have a capacity of about 50 cu. ft. to 60 cu. ft. and about 1 ton to 1½ tons.

Automatic Grapples

Automatic grapples having three or more substantially constructed prongs operated by a power-wheel, as in a power-wheel type of grab-bucket, are used for handling rough materials such as logs, cordwood, railroad ties or large pieces of stone; for pulling stumps or handling rough material in excavation work in a swamp or in woodland, or for handling snags in dredging operations. They may be operated by a derrick, crane, or other machine equipped with the necessary hoisting winch.

Similar automatic grapples or tongs of lighter construction and operated by means of levers and rods are used for handling sugar cane, hay, straw, or similar loose bulk material.

This type of grapple has been widely applied to the handling of sugar cane both at the plantation and at the mill. Grapples for this service are provided with as many as 14 prongs, and may be operated by a single line or may have as many as eight lines. The large sizes are used mostly for handling sugar cane in and out of storage at the mill and have a capacity for handling as much as 3 tons of cane at one time.

Hooks and Tongs

There are numerous types of hooks and lifting tongs which are used with cranes and derricks or other hoisting machines. They are used to handle timber, boxes, barrels, steel plates, block stone, or baled materials. These devices vary in design to suit the service for which they are intended, but generally they consist of two hooks hanging loosely on ropes or chains or are of the rigid type pivoted near the center of the hook shank.

Grab Hooks

Grab hooks are used to handle steel plate, block stone, boxes and barrels, or other material in large pieces or packages. This device consists of two forged steel hooks loosely suspended from single links through which the load chain passes upward to the hoist hook forming a triangular loop. The hooks are placed over the edges of the object to be lifted and as the hoist line is raised the action of the chain loop draws the hooks toward the center, causing them to grip and hold the load.

They are made with chains ranging upward to 20 ft. in length and may have a spread of 6 ft. to 8 ft. They have a lifting capacity upward to 25 tons, varying with the spread of the hooks, the lifting capacity decreasing as the distance of spread increases.

Other designs of grab hooks used especially for handling packages or barrels have two or more single or double-pronged hooks attached at the end of long rigid or flexible links. The upper ends of the links are attached to a ring by which the device is attached to the hoist hook.

Grapple Hooks

Grapple hooks or lifting tongs are used to handle timber, boxes, barrels and baled material. These devices usually have two pointed hooks having curved shanks which are pivoted on a pin through the shanks. The upper ends of the shanks are connected by single links to a ring by which the device is suspended from the hook of the hoisting machine. As the hoisting line is raised the hooks are drawn inward and grip and hold the load.

Tongs of this type, designed especially for handling block stone, sometimes are provided with one pointed hook and

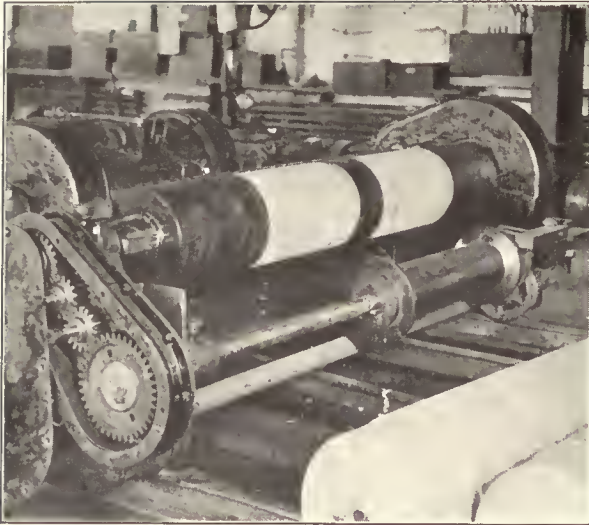

Automatic Mechanical Cable Take-Up

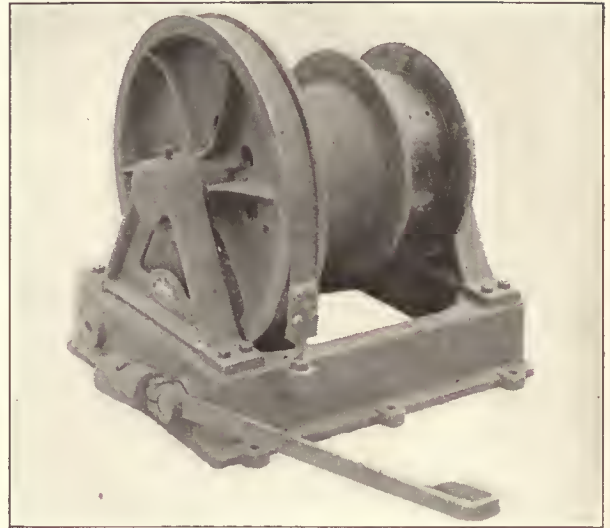

Counterweight Holding-Drum

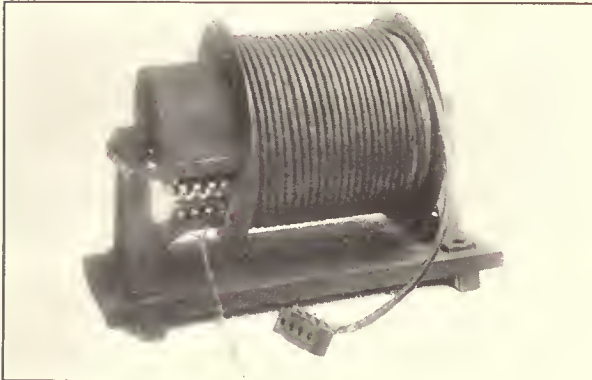

Electrical Cable Take-Up

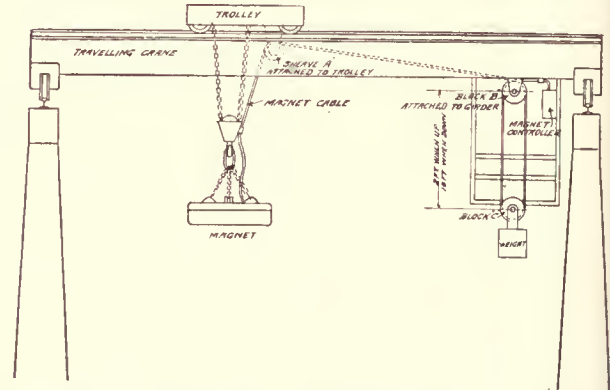

Counterweight Cable Take Up



Slings on Spreader Bars

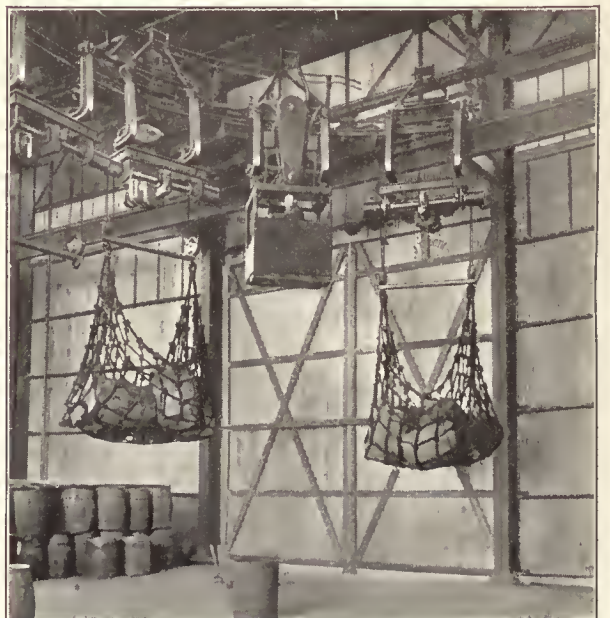

Nets on Spreader Bars

one blunt hook which clamps against the side of the block.

Another type largely used for handling I-beams or similar pieces and for narrow plates or bars is provided with short blunt hooks so designed that they will clamp over the edges of the beam flange or the plate. As with the pointed tongs that grip the load, this device clamps tightly as the load is suspended and releases when the load is at rest and the load line slacked off.

Slings

Slings constructed of chains, wire rope, or manila rope, are used to handle such materials as logs, lumber, bales, boxes or any large objects that cannot easily be handled by other means. The ordinary types of slings may be a single rope or chain of any desired length and provided with hooks, shackles, or thimbles at the ends; or they may consist of two or more lengths of chain, cable, or light bars or rods provided with hooks at one end, and with links or thimbles at the other end by which they may be attached to a top ring or link and suspended from the hoist hook.

One type of sling largely used in handling sugar cane is provided with a self-tightening device which tightens the grip of the slings as the load is raised. An automatic trip permits the release of the self-tightening device when the load is carried to the desired position. Slings of this type are used singly or may be used in multiple on a plain spreader bar.

A trip type of spreader bar is designed especially for use with a crane or derrick in sugar cane service. This device consists of an I-beam or channel equipped with three hooks keyed to a rod suspended from the bar. A trip, operated from the ground or from the operator's platform, releases the free ends of the slings. When the load is dropped the hooks automatically return to the carry position.

Counterweight Drum

A counterweight holding and lowering drum is used when an additional drum is required for use in connection with a winch already installed. It generally is used when it is desired to operate a two-line bucket on a derrick or other hoisting machine having a boom which must be raised or lowered but which is equipped with a winch having only two drums. It may, however, be used as an auxiliary to any hoisting winch having one or more drums. As it is not connected—except by the line—with the hoisting machine, the counterweight drum may be placed near the hoisting winch, so that it is easily accessible to the operator.

This device consists of a two-compartment drum controlled by means of a foot brake of the band type. A light line—called the counterweight line—is wound on the smaller compartment of the drum and leads over sheaves—on the hoisting machine—to a counterweight suspended from a convenient point on the machine or its supports. The bucket line is placed on the larger compartment of the drum in such a way that it will unwind as the counterweight line winds on the smaller drum or will wind on the drum as the operation is reversed and the counterweight line unwinds.

As the bucket is raised by the hoisting or holding line, the counterweight descends, causing the counterweight line to unwind, rotating the drum and winding on the bucket line. When the bucket is in the desired position, the foot brake is applied, stopping the drum, releasing the hoisting line and allowing the bucket to open and dump the load. When the counterweight drum brake is released, the weight

of the buckets rotates the drum and, reversing the operation, lowers the bucket and raises the counterweight.

Lifting Magnets

Electric lifting magnets are used for handling scrap and manufactured metals and sometimes for handling magnetic ores. Their use facilitates the handling of such material and, where electricity is available, they are an economical means of doing such work.

The use of lifting magnets makes it possible to handle large quantities of metals not easily nor safely handled by any other means. It eliminates the use of slings, hooks, and other devices and not only expedites the handling of metal products but prevents many of the accidents which occur when using other methods in such service. They will successfully handle metals under practically any conditions. Cold or heated metals; metals submerged in water or covered with snow; or metals contained in boxes or kegs, may be handled satisfactorily.

When used with a locomotive crane, they give efficient service in foundry yards for handling scrap metals and pig iron, and for loading castings or moving heavy pieces; in railroad yards for handling scrap metals and loading or unloading metal railroad supplies, or for transferring such material in transit; on wharfs for handling metal cargo; or in other similar service where a locomotive crane can be operated.

They are installed on overhead traveling cranes and used in foundries or in steel mills for handling either hot or cold metals, and in storage yards for handling castings and such metal products as rails, pipes, billets and plates.

They may also be used with any other type of hoisting machine having connection with an electric line or with an electric current generating unit—usually installed on the machine itself and operated by a steam or a gas engine.

The Magnet Case

The magnet case should be made of high grade cast steel having high ductility and high magnetic quality. It should have a structural strength sufficient to withstand the shocks caused by dropping the magnet on the material to be lifted, and to absorb the force of the blow caused by magnetic attraction as the material being handled is drawn suddenly to the face of the magnet. It should be so assembled as to eliminate dead air spaces, should provide for the proper radiation of the heat generated by the magnetic current, and be so effectually waterproof as to exclude all moisture.

Current Circuit

Lifting magnets are suitable for operation only on direct current circuits; therefore a converter is necessary where only alternating current is available. They rarely are designed for a stronger current than 220 volts as higher voltages are not desirable for magnetic operation because of the excessive inductive shock when the current is switched on or off. When it is necessary to use a current of higher voltage, magnets designed for 220 volts may be used in series. They are, however, often wound for 110-volt service.

Aside from the strength of the magnetizing current the lifting capacity of a magnet is governed by the area of magnetic contact obtainable and the class of material being handled. A magnet capable of lifting 50,000 lb. of compact material having a large contact area would have a capacity of only 800 lb. to 1,000 lb. when used for handling loose miscellaneous scrap metals.

Lifting magnets are made in a circular form for gen-

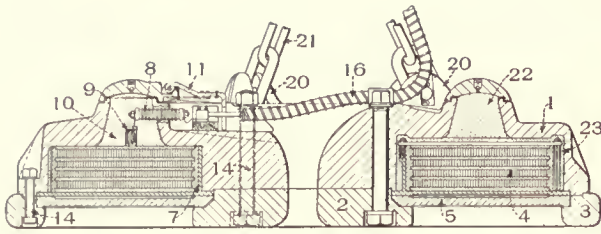

Circular Magnet

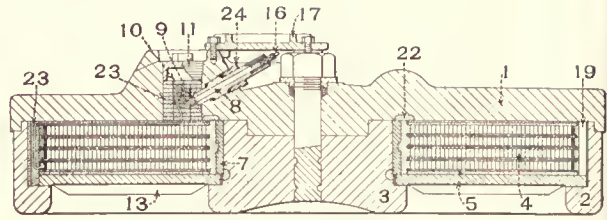

Circular Magnet

List of Parts

- | | | |
|----------------------|----------------------------------|------------------------------------|
| 1 Magnet Case | 8 Coil Terminal Stud | 17 Lead Shield |
| 2 Outer Ring or Pole | 9 Leads from Coil to Stud | 18 Dowel to Prevent Spool Rotation |
| 3 Center Pole | 10 Terminal Cavity | 19 Steel Spacer |
| 4 Magnetizing Coil | 11 Terminal Hood | 20 Suspension Lug |
| 5 Coil Shield | 12 Terminal Protecting Flange | 21 Suspension Chain |
| 6 Coil Top Plate | 13 Coil Protecting Ribs | 22 Sealing Compound |
| 6A Metal Bobbin | 14 Through Bolts | 23 Insulation |
| 7 Coil Spool Core | 15 Eye Bolt to Handle Coil Spool | 24 Packing |

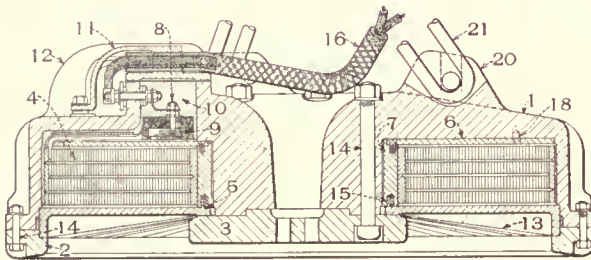

Circular Magnet

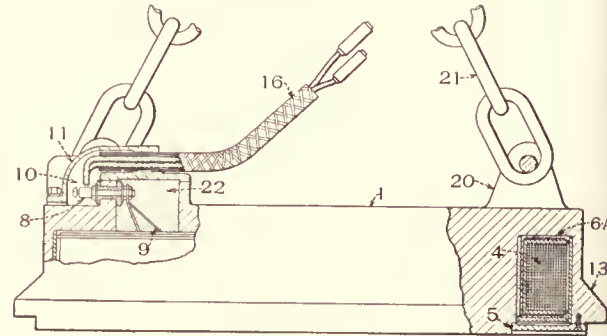

Rectangular Magnet

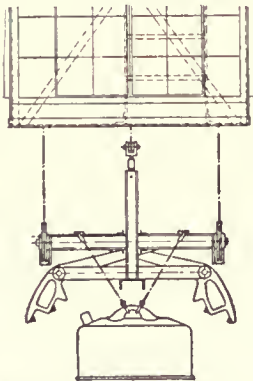

Magnet with Tongs for Handling Ingots

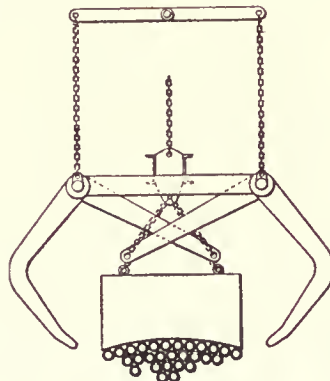

Magnet with Tongs Attachment

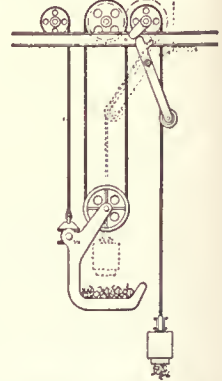
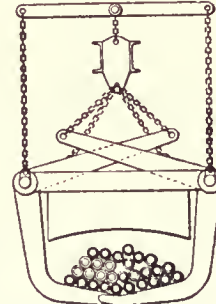

Magnet with Tilting Device

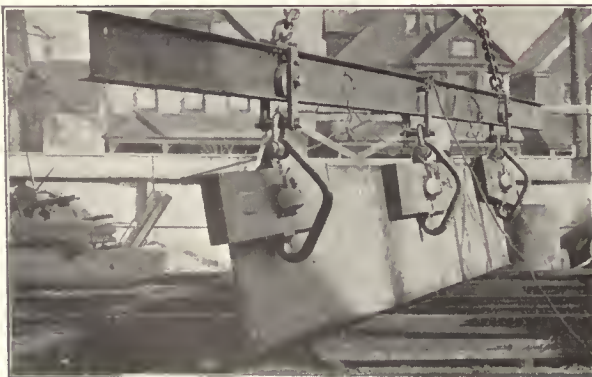

Rectangular Magnet Handling Steel Plate



Rectangular Magnet Handling Pipe

eral service and in a number of different rectangular forms for special service.

Circular Magnets

The circular type of lifting magnet may be used with equal facility in handling large or small pieces of manufactured metals or for handling pig iron or scrap metals. It is used in various lines of work: In foundry service for handling scrap metals and new castings and for raising the heavy metal balls—known as skull-crackers—or other heavy weights used in drop work for breaking up large pieces of scrap metals; in steel plants for handling scrap metals or for manufactured products; in fabrication work for lifting steel parts; in railroad work for loading or unloading scrap or finished metals; or in marine work for metal cargo.

Magnets of this type range in sizes and capacities from a 5 in. diameter having a capacity up to about 400 lb., to a 65 in. diameter having a capacity of 25 tons or 30 tons. The smaller sizes—those under 20 in. in diameter—are adapted only to special work and for handling individual pieces or light castings and finished parts. Magnets 20 in. and over in diameter are suitable for general service, but for such severe service as handling pig iron or for other heavy rough work it is advisable to use a magnet of 36 in. or greater diameter.

The circular magnet has a magnetic coil enclosed in a circular cast steel magnet case having positive and negative poles on the underside so that by simply dropping it, it may be brought into contact with the materials to be handled. The coil is secured within the magnet case and the case is then filled with a sealing compound so that all possibility of moisture within the case is eliminated. The coil is protected on the underside by a steel plate or shield which takes the shocks incident to the use of the magnet. One, or two, terminal boxes are provided and usually are cast on the top of the magnet case. The internal leads extend from the magnetizing coil to the terminal box and the external leads from the terminal box to a connection with the current circuit. An eye-bolt type of suspension is used on small magnets up to about 12 in. in diameter and a three-point chain suspension—attached to lugs cast on the top of the magnet case—is used on the larger sizes. The following table gives data on the use of circular magnets in various classes of service:

CIRCULAR TYPE LIFTING MAGNETS—DIAMETER UNDER 20 INCHES

Diameter Inches	Weight Pounds	D. C. Current (Amperes) at 220 Volts	Use
5	20	0.25	For individual pieces and special classes of work. Will lift up to 400 lb. on flat surface.
7	30	0.38	Same as 5-in. size. Will lift up to 800 lb. on flat surface.
12	110	0.66	Same as 5-in. and 7-in. sizes. Will lift up to 4,000 lb. on flat surface.

DIAMETERS 20 INCHES AND OVER

Diameter in inches.	20	30	40	50	55	60	65
Weight—pounds ...	460	1,400	3,000	4,500	5,450	7,000	7,400
D.C. Current (amperes) at 220 volts	6	13	30	45	49	71	61
Capacity in Pounds							
Billets or slabs....	3,500	15,000	30,000	40,000	42,000	50,000	50,000
Skull-cracker balls.	3,000	10,000	15,000	20,000	20,000	20,000	30,000
Pig iron	{ 200	{ 500	{ 1,200	{ 1,900	{ 1,950	{ 2,500	{ 2,500
	{ to	{ to	{ to	{ to	{ to	{ to	{ to
	{ 250	{ 600	{ 1,300	{ 2,100	{ 2,150	{ 2,900	{ 2,650
Heavy melting scrap	250	600	1,300	2,000	1,900	2,500	2,500
Boiler plate scrap..	250	500	1,100	1,700	1,650	2,300	2,300
Farmers' and junk dealers' scrap ..	{ 75	{ 250	{ 400	{ 600	{ 600	{ 800	{ 800
	{ to	{ to	{ to	{ to	{ to	{ to	{ to
	{ 150	{ 500	{ 900	{ 1,400	{ 1,400	{ 1,800	{ 1,800
Small steel castings and risers	250	900	1,600	2,400	2,450	3,300	3,200

The sizes and capacities given in the above table show a wide variation in the class of service to which circular

magnets are adapted but they may also be used in any other service in any industry where metals of any description are handled in large quantities. There are, however, many materials, such as long flat plates, which may be more readily handled by rectangular magnets.

Rectangular Magnets

Rectangular lifting magnets are designed in several different forms and are preferable to the circular type for certain classes of work. They are particularly adapted to handling long flat pieces, such as steel sheets and plates, bars or billets, and other long materials, such as rails and pipes. They are largely used in steel mills, where they can be used exclusively for this class of work.

As the entire face of the rectangular magnet may generally be brought into contact with the material being handled, it gives a maximum lifting capacity for a given weight of magnet; speeds up the handling of material; and results in economy of current consumption and consequently in operating cost.

The body of a rectangular magnet designed for handling flat pieces usually is a box-shaped steel casting containing a magnetic coil wound on a metal bobbin properly insulated. Flexible leads are carried from the coil to a terminal box on the body. The external leads are protected by a cover plate and by heavy ribs on the magnet body. Detachable connectors are provided for connecting the external leads to the feed cable.

This type of lifting magnet may be used singly for handling comparatively short or rigid pieces or in multiple, mounted on a spreader bar, for handling very long or flexible pieces. It is desirable to use a spreader bar and two or more magnets when extremely long sections are to be lifted, as this arrangement increases the stability of the load and speeds up the operation because less time is required to spot the magnet at the center of the load.

One form of rectangular magnet is designed especially for handling rails and pipes. It has the two poles formed of triangular shaped steel castings secured to a horizontal core, on which the magnetizing coil is wound. It is suspended by means of lugs cast on the upper portion of the pole castings. These pole castings may be of any desired spread and are commonly made of sufficient size to span 10 or 12 or more pipes of 5 in. diameter or 20 or more heavy T-rails nested together. They generally are used in pairs on a spreader bar for handling long material but may be used singly for short material.

Rectangular magnets will not withstand the rough usage to which magnets are subjected in general service and should never be used for handling scrap metals or pig iron or in any such severe service.

They range in sizes upward to 6 ft. or more in length the proportions being approximately as given in the following table:

RECTANGULAR LIFTING MAGNETS

Weight Lb.	Length In.	Width In.	Current Consumption Watts
600.....	24	15¾	860
1,080.....	40	15¾	1,540
1,500.....	54	15¾	2,150
2,200.....	76	15¾	3,100

Safety Devices for Lifting Magnets

It sometimes is desirable to provide a means of preventing the load from falling in the event of failure of the magnetizing current. A device designed to accomplish this has been adapted for use in direct connection with the lifting magnet. It consists of safety tongs, of any desired size, spaced apart by a bar and connected to the magnet by a system of chains and levers. As the magnet

is lowered the tongs automatically open and permit the magnet to pass downward between them. When the load is picked up and the magnet is raised the tongs close in under the magnet. The magnetizing current may then be cut off, the load dropped on the tongs and carried to the desired position.

The operation of the tongs is dependent on the movement of the magnet and the load can not be dropped without lowering the magnet. This slows up the speed with which metals can be handled and therefore it should only be installed where safety demands the use of such a device. It is particularly adapted to the carrying of pipes or other long pieces.

Another similar device designed to carry and drop the load is so arranged that it can be operated independent of the magnet. It consists of wide flat carrying hooks suspended from the crane structure by cables on a series of sheaves and so arranged that the load may be dropped or dumped by tilting the hooks. The magnet is suspended from the crane on the open side of the hooks and may pick up one or several magnet loads and deposit them in the hooks. The load may then be carried to any desired position and dropped without lowering the magnet. This device permits the use of a small magnet on a crane of large capacity, but at the same time by having carrying hooks of sufficient size it insures the full capacity of the crane being utilized.

Magnet Control System

A control system is used in magnet operation to insure complete control of the magnetizing current. By setting up a reverse current in the magnetizing coil, when the current is switched off, it overcomes the magnetism which sometimes causes highly magnetic metals to cling to the magnet, thus slowing up the handling of materials. Such a device increases the speed with which metals can be handled and adds greatly to the efficiency of operation. It also provides a resistance at the off position which absorbs the inductive stresses, thus preventing damage to the magnet insulation.

One controller system in general use is of the magnetic switch type. This system has a master switch of the wiping contact type; a double-pole magnetic contactor or switch panel; and a resistor group. The master switch has marks indicating the "lift," "drop," and "off" positions and should be located at a point accessible to the magnet operator. The magnetic switch panel and the resistor may be installed in any convenient location.

Another type frequently used is a single-unit controller having a switch of the wiping contact type and a resistor group in one self-contained unit. This type of control system performs practically the same functions as the magnetic switch type. It must be installed within easy reach of the magnet operator.

Controllers having the features of these two types should be used with all magnets of the larger capacities but for the smaller sizes of magnets a controller of the drum type may be used.

Magnet Cable Take-Up

A device called a cable take-up is used in magnet operation to eliminate the dangers attending a sagging current conductor cable. This device automatically pays out the cable as the magnet is lowered or reels it in as the magnet is raised. There are several different types of such devices. They are designed to be operated by electric power, by means of springs, or by means of a counterweight suspended from some part of the machine.

The electrically operated cable take-up consists of a motor-driven drum on which the cable is wound, the size of the drum determining the length of cable that can be handled. The driving motor takes current from the same line as the magnet and has only sufficient torque to keep the cable taut. As the magnet is lowered its weight unwinds the cable from the drum and as the magnet is raised the motor operates the take-up and winds up the cable. The current for energizing the magnet is transmitted to the cable through collector rings placed on the extended hub of the drum.

In the spring-operated type of take-up the power is supplied by springs enclosed within the drum. The capacity of this type of take-up also is governed by the size of the drum and it controls the cable in the same way as in the electric type. The tension of the springs may be adjusted by means of a ratchet and pawl on one end of the drum shaft, and a plunger type of lock provides for holding the drum stationary when desired. The electric current is transmitted to the magnet cable through collector rings on the drum shaft in a manner similar to that employed on the electrically operated take-up.

The counterweight cable take-up consists of two upper sheaves—one a single sheave fixed to some part of the hoisting machine, approximately over the magnet, and the other a several-part sheave block also fixed to some part of the hoisting machine—and a several-part lower sheave block suspended beneath the fixed upper sheave block by the conductor cable itself. The capacity of this device is governed by the number of sheaves in the upper and lower sheave blocks, two blocks of five sheaves having a capacity of from 50 ft. to 60 ft. of cable, depending on the travel of the lower sheave block.

The counterweight is attached to the lower sheave block and the conductor cable connected to the current circuit through the controller panel, and then reeved through the sheaves and thence to the magnet. As the magnet is lowered, its weight overcomes the action of the counterweight and causes the cable to draw through the sheaves, raising the free sheaves and the weight and paying out the cable. When the magnet is raised, this operation is reversed—the counterweight being lowered and the cable taken up over the sheaves.

Another type of cable take-up drum is often installed on trolleys designed for use on cranes handling a motor-operated grab bucket or a lifting magnet. This device consists of a small drum mounted on a shaft turning in bearings attached to the trolley truck frame and geared directly to the hoisting drum through a train of gears so that it operates in unison with the hoist, paying out the cable as the hoist is lowered or winding the cable on the drum as the hoist is raised. The conductor cable is attached to collector rings which receive the electric current from the wires on the crane girder and transmits it to the bucket motor or the magnet. These devices are also adapted to handle the cable used in the operation of electric-motor grab-buckets.

Blocks

Sheave blocks or tackle blocks—generally referred to simply as blocks—are an important part of hoisting machinery equipment. They are used on derricks, cranes, hoists, cableways and other types of hoisting machines. These blocks are variously termed single; double—2-sheave; or triple—3-sheave etc.; depending on the number of sheaves or pulley wheels—upward to 7 or 8—contained in the block. They are made without hooks; or are equipped with a plain hook; a two-part or sister-hook; or a shackle, and these devices are arranged to swing on a pin;

to swivel on a pivot; with a combined pin and pivot; or they may hang loosely from an eyebolt secured in the block.

the load is raised 1 foot for each foot of line overhauled. With a two-part line one-half the stress is carried on each part of line, consequently the hoisting capacity is double that of the single line, but to raise the load 1 foot it is

Blocks designed for use with manilla rope generally

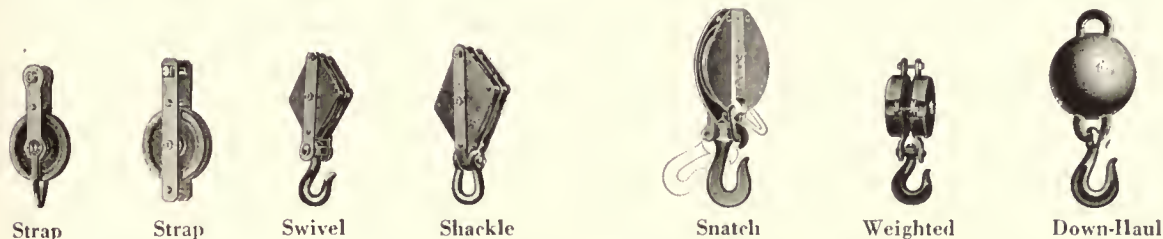

are made of wood and in many different forms. They are used chiefly for ships rigging or for light tackle. When required for use with wire rope, however, it is necessary that they be of more substantial construction and the blocks are then formed of metal—generally of steel plate or forgings or of malleable cast iron. The

necessary to overhaul 2 feet of line. Thus, as the number of parts of line reeved increases, the load capacity and the length of line overhauled also increase, but the speed of the hoisting movement decreases.

The closed type of block is the most commonly used, but for some purposes snatch blocks are desirable. These

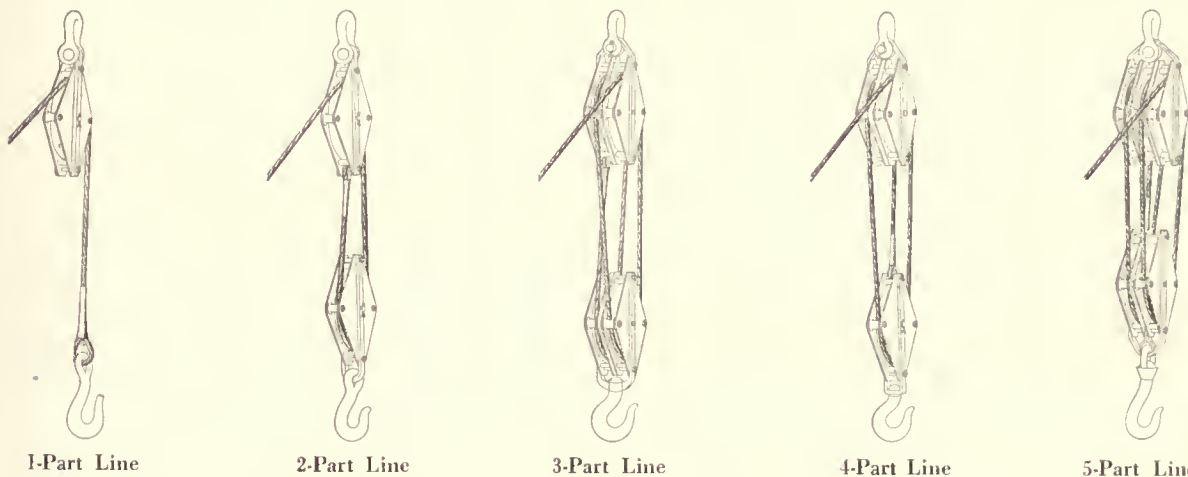

hooks and shackles are forged of soft tough steel while the sheaves or pulley wheels generally are of cast steel.

The load stress or load capacity and the length of line overhauled to raise a load a given distance is directly pro-

portional to the number of parts of line reeved through the block. With a one-part line the full load and consequently the full stress is carried on a single line, while

blocks are provided with a hinged strap or line on one side which may be thrown back and a rope inserted without the necessity of unreeving the entire line from other blocks. By this means a block having a lower or load hook may be placed in the bight of a line and serve as a fall-block; or, a block with a hook at the top may be suspended from a shackle, eyebolt, or other support and serve as a head-block.

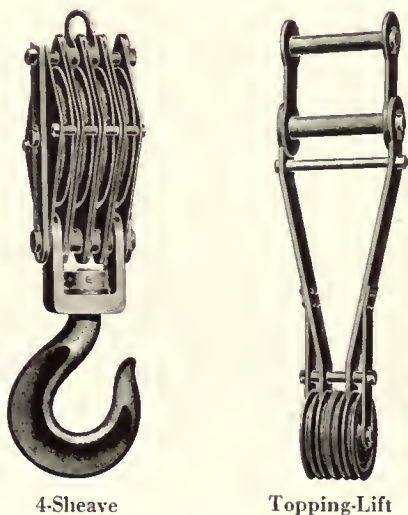

Approximate working loads for wire rope sheave blocks are given in the following tables:

WORKING LOAD FOR PAIR OF BLOCKS

Diameter of Sheave In.	With Loose Hooks		
	Two Single Sheaves Tons	Two Double Sheaves Tons	Two Triple Sheaves Tons
8	3	4	5
10	4	5	6
12	5	6	7
14	6	7	8
16	7	8	10
18	8	10	12
With Shackles			
8	4	5	8
10	6	8	12
12	8	10	15
14	10	12	20
16	12	15	24
18	15	20	28
20	20	25	30
22	25	30	40
24	30	35	50

portional to the number of parts of line reeved through the block. With a one-part line the full load and consequently the full stress is carried on a single line, while

To assist in the downward movement of tackle, particularly when reeved with several parts of line and carrying a

load only on the upward travel, heavy cheek-blocks or weights are sometimes secured to the sides of the blocks. These weights generally are made so that they may be removed when desired.

Fall-line or down-haul balls are also extensively used

to facilitate down-haul movement. These balls range in weight upward to 1,200 pounds and have a capacity upward to 50 tons. They are made with a plain link rope connection or with a hook attached so that a load may be suspended directly from the ball.

Wire Rope

Wire rope is used for both hoisting and haulage purposes on practically all classes of material handling machinery and is also used for guys. The general form of construction consists of a number of wires placed in a symmetrical geometric arrangement and then twisted together, thus forming a strand. A group of strands is then placed around a center or core of hemp—sometimes wire—which forms a cushion or base on which the strands are twisted to form the rope.

The number of wires in each strand, the number of strands composing the rope, and their shape and arrange-

ment are varied to suit the purpose for which the rope is designed.

Iron rope has a tensile strength of about 85,000 lb. per

6 Strands—19 Wires per Strand—1 Hemp Core

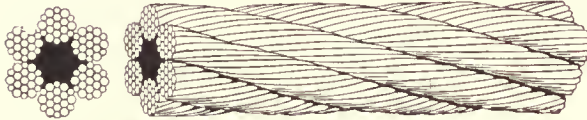

Standard Hoisting Rope—Three-Size Wire

ment are varied to suit the purpose for which the rope is designed.

Material

The material used in the manufacture of wire rope consists of various grades of cast steel or of soft iron.

Cast steel wire made by the crucible open hearth method

6 Strands—19 Wires per Strand—1 Hemp Core

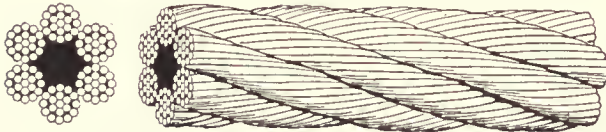

Hoisting Rope—One-Size Wire—Regular Right-Lay

and having a moderately high tensile strength of from 150,000 lb. to 220,000 lb. per sq. in. is extensively used in rope designed for both hoisting and haulage service.

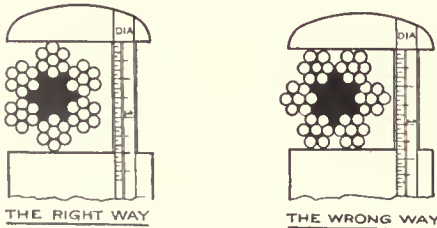

Method of Measuring Wire Rope

Cast steel produced by the open hearth furnace method and having a tensile strength ranging from 200,000 lb. to 280,000 lb. per sq. in. is used in rope required for unusually severe service. This grade of steel is commonly known as plow steel and is used for such service as dragline work where the rope is dragged over stones or rough ground or

in other very heavy service on dredges, power shovels, or other heavy duty machines.

6 Strands—27 Wires per Strand—1 Hemp Core

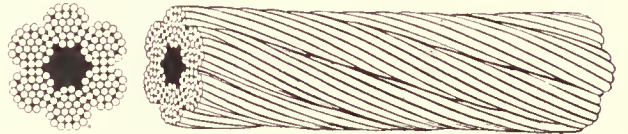

Type H, Flattened Hoisting Rope—Langs' Lay

sq. in. It is more pliable than steel but is used only to a limited extent in comparatively light service, principally on elevators.

Wire rope should be galvanized when it is to be used for such purposes as guys for derricks; or in other stand-

6 Strands—25 Wires per Strand—1 Hemp Core

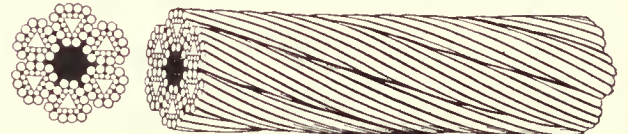

Type B, Flattened Strand Hoisting Rope

ing service where it is exposed to moisture or the weather. This protects the metal which otherwise tends to corrode, but, as the zinc used in the galvanizing process flakes easily, such rope is not very flexible and therefore is not suitable

6 Strands—8 Wires per Strand—1 Hemp Core

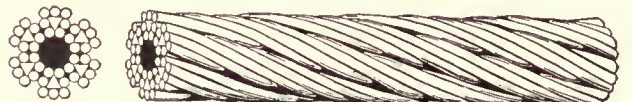

Type D, Flattened Haulage Rope—Langs' Lay

for hoisting service but is adapted for use only where very little bending is encountered.

Rope Strand

Wire rope strands are made either round or flat, the round strand being the most generally used. It is adapted

5 Strands—9 Wires per Strand—1 Hemp Core

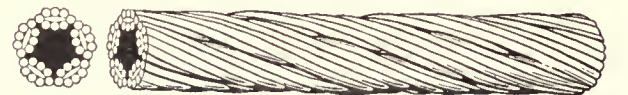

Type C, Flattened Haulage Rope—Langs' Lay

to all classes of service and is used for guys and for haulage or hoisting purposes.

Flattened strand wire rope takes its name from the shape of the strands. In construction the strand is similar to

the round strand except that it is flattened so that a greater number of the outer wires of the rope conform to a circle. From 2 to 6 wires in each strand—depending upon the style of construction—are thus exposed to contact instead of only one wire as in the round strand. This gives a wearing surface much greater than that of the round strand and distributes the wear over a larger area, giving much longer service. The shape of the strands permits them to fit closely together thus allowing more metal to be used in a given diameter and thereby giving greater strength and maximum safety. The smooth surface also prevents excessive wear on rollers, sheaves and drums. Flattened

in the rope are all twisted in the same direction. This type of rope is more easily untwisted than that made with Regular-lay and it is more difficult to splice, but because of the increased contact surface it is especially adapted to resist external wear and the grip action to which it is

5 Strands—28 Wires per Strand—1 Hemp Core

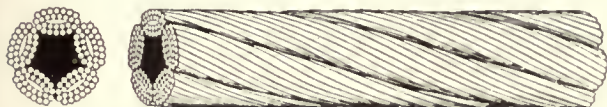

Type A, Flattened Hoisting Rope—Langs' Lay

strand rope also has less tendency to kink than the round strand rope.

For ordinary work the strand is made with 1 wire in the center and this surrounded with a layer of 6 wires, producing a strand suitable for haulage rope; a second layer of 12 wires makes a 19-wire strand for standard hoisting rope; this strand covered by a third layer of 18 wires, making a 37-wire strand, is used in a more flexible type of hoisting rope; and other layers of 24 and 30 wires are added to produce a still more flexible rope of a

5 Strands—11 Wires per Strand—1 Hemp Core



Type E, Flattened Haulage Rope—Langs' Lay

given diameter or are used in ropes of very large diameter in order to keep the size of the individual wires as small as possible. This construction is known as concentric strand. In a strand of uniform diameter the greater the number of wires in the strand, the greater will be the flexibility of the rope.

Rope Lay

Two general methods are employed in assembling or "laying-up" the individual wires and the strands. The most commonly used type is known as Regular-lay and the other as Langs'-lay.

In the Regular-lay, the wires in the strands are twisted

8 Strands—19 Wires per Strand—1 Hemp Core



Extra Flexible Hoisting Type—3-Size Wire

in one direction and the strands in the rope in the opposite direction, being right or left lay according to the direction in which the strands are laid.

In Langs'-lay, the wires in the strands and the strands

6 Strands—37 Wires per Strand—1 Hemp Core



Special Flexible Hoisting Rope—One-Size Wire

subjected in cableway service Langs'-lay is quite generally used in all ropes made with flattened strands.

Haulage Rope

Haulage rope—also called transmission rope—is composed of 6 strands, 7 wires to the strand. This type of rope is used chiefly for haulage in mines, on inclined planes, on tramways, and in yards of manufacturing plants. It is also used for drilling lines and sand lines in well drilling operations. The wires used in haulage rope are nearly twice as large as those used in hoisting rope of

6 Strands—7 Wires per Strand—1 Hemp Core

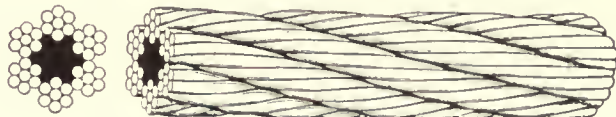

Haulage Rope—One-Size Wire

a corresponding diameter. This feature is particularly desirable in haulage work where the rope is dragged along the ground or over rough rollers and subjected to severe abrasion, as finer wires would more quickly wear through and break.

Being made of coarser and fewer wires than hoisting rope, haulage rope is much less flexible.

Hoisting Rope

Standard hoisting rope is composed of 6 strands of 19 wires each and is made with various slight modifications of the strands and wires:

1. One-size-wire construction—19 wires all of one size.
2. Three-size-wire construction, sometimes called "Warrington" construction—19 wires, the 7 inside wires being

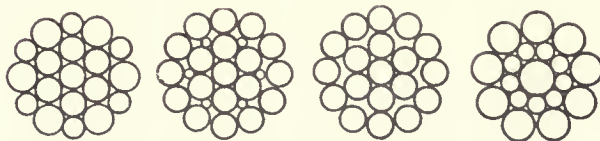

3-sized-wire Construction 1-sized-wire with Fillers 1-sized-wire without Fillers Scale Construction

of uniform diameter and surrounded by 12 wires which are alternately large and small. This combination of wires increases the metallic area and strength by approximately 10 per cent. and the advantages of this construction has led to its general adoption as a standard for hoisting ropes.

3. Scale construction—1 large center wire, an inner layer of 9 small wires and an outer layer of 9 large wires.

This makes a rope which is considerably less flexible than the one-size or three-size strand, but, there being a greater number of wires exposed on the surface of the rope, it offers greater resistance to abrasion.

The wires used in hoisting rope being smaller than those in the 6 x 7 construction used for haulage rope, this type of rope is more flexible and will more readily pass around sheaves and drums of moderate size. The 6 x 19 rope is used more extensively than any other construction. The iron and mild steel grades are commonly used on elevators; while the crucible and plow steel grades are used in mines, quarries, ore docks, coal docks, on cranes,

6 Strands—61 Wires per Strand—1 Hemp Core

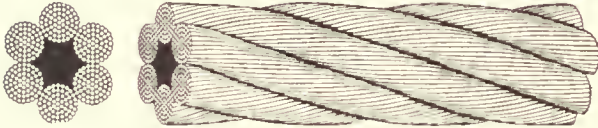

Extra Special Flexible Hoisting Rope

dredges, power shovels, derricks, cableways and other apparatus.

An extra flexible type of hoisting rope is composed of 8 strands, 19 wires to the strand. This construction contains 2 more strands than the standard hoisting rope which adds greatly to the flexibility of the rope and permits its use on sheaves and drums of comparatively small diameter.

A special flexible hoisting rope composed of 6 strands, 37 wires to the strand, is used extensively on cranes and similar machinery where the rope is operated at high speed and where the sheaves and drums are of small diameter. The wires used in this construction are smaller than those in the standard hoisting rope and therefore will not stand as much abrasive wear, but, as more than 50 per cent of the wires—and consequently of the strength—are in the inner layers of the strand they are protected from abrasion.

A still more flexible type of construction is used in ropes of large diameter—2 in. or more. This construction consists of 6 strands having 61 wires to the strand and

6 Strands—37 Wires per Strand—1 Hemp Core

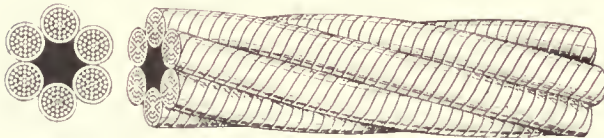

Steel Clad Special Flexible Hoisting Rope

usually having a hemp core. This large number of wires in the strand permits the use of a finer wire and consequently gives a greater flexibility than would be possible in a rope of large diameter if made in the 6 x 19 or 6 x 37 construction. This rope is used in very heavy land service, or for deep sea dredging and salvage work. In the latter case a wire center is generally used.

Steel Clad Rope

Steel clad hoisting rope is used chiefly on dredges, power shovels and dragline excavators, or for other severe service. The construction of this rope is similar to the regular 6-strand rope except that each strand is wound with a flat strip of steel. This steel covering gives additional

wearing service without reducing the flexibility of the rope but does not increase the tensile strength. When the outer flat steel is worn through a complete hoisting rope still

6 Strands—61 Wires per Strand—1 Hemp Core

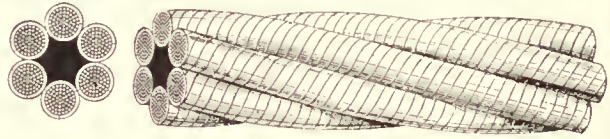

Steel Clad Extra Special Flexible Hoisting Rope

remains with unimpaired strength, the steel strip having served to protect the inner wires from wear. As the strip wears the metal is forced down between the strands of the rope, thus filling the interstices and providing additional wearing surface even after the strip itself has been disintegrated. Ropes of this construction may be used under unusually severe conditions as the additional wearing surface provided by the flat strips materially increases the durability of the rope.

Marlin Clad Rope

Marlin clad wire rope is a type of hoisting rope especially adapted for use on cargo handling gear or other similar hoisting apparatus. It consists of a round-strand rope each strand of which is wound with tarred marlin. The strands are composed of from 7 to 19 wires and from 4 to 6 strands are used to form the rope. The chief func-

5 Strands—19 Wires per Strand—1 Hemp Core

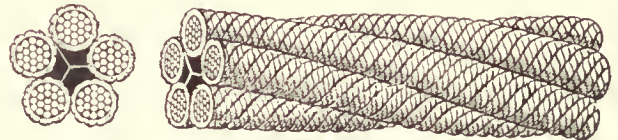

Marlin Clad Hoisting Rope

tion of the marlin is to protect the metal rope from the weather. However, as the marlin is in contact with the hoisting drum and the sheaves it also provides a wearing surface which saves the wire underneath.

Tiller Rope

Tiller rope or hand rope as it is frequently called, is used in hoisting service chiefly on small elevators having a hand rope. The strands used in this type of construction are composed of 6 smaller ropes, each one formed of 6 regular rope strands composed of 7 very fine wires twisted around a small hemp core, thus forming a complete rope in itself. This type of construction produces a very flexible

6 Strands—42 Wires per Strand—7 Hemp Cores

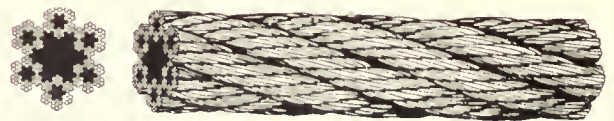

Tiller Rope

rope which may be bent around sheaves of very small diameter, but, because of the fine wire used in the strands, it does not offer much resistance to abrasion.

Non-Spinning Rope

Non-spinning hoisting rope is designed especially for single-line hoisting work on derricks or other hoisting ap-

paratus; or for mine hoisting or other service where the bucket or cage swings free without guides. It consists of an inner rope composed of 6 strands of 7 wires each,

18 Strands—7 Wires per Strand—1 Hemp Core

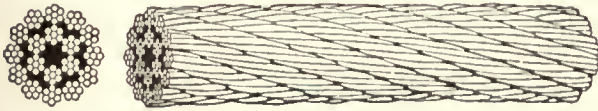

Non-Spinning Hoisting Rope

laid in Lang's left-lay around a hemp core, and these strands then covered with an outer layer composed of 12 strands of 7 wires, each laid in regular right-lay. This arrangement of the strands and the combination of lays overcomes the tendency of the rope to untwist and prevents a free load suspended on the end of a single line from rotating or spinning.

Track Cable

A special form of wire rope construction is employed in making track cable for cableways and tramways. It consists of successive layers of wires instead of the strands

1 Wire 7 Wires 19 Wires 37 Wires

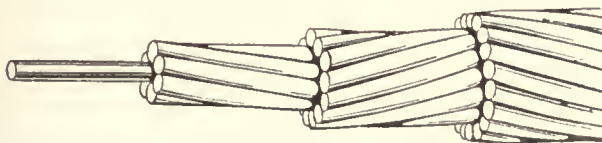

Round-Wire Track Cable

used in the construction of rope designed for haulage or hoisting service. This form of construction is not very flexible, but, as it brings a larger number of the wires to the surface of the rope, it provides a greater wearing surface, thus prolonging the life of both the rope and the cable carrier wheels. Track cables are made with round wire throughout, or with inner layers of round wires, and outer layers of wires formed with an interlocking section called locked-wire or locked-coil.

The most common type of track cable consists of 6 round wires laid around a round wire center and then covered with other round wires in successive layers of 12 and 18 wires. These wires are then twisted together to form the cable which is substantially one large strand composed of 37 wires.

Locked Cable

Locked-coil and locked-wire rope or cable are similar in construction except that the locked-wire cable is composed

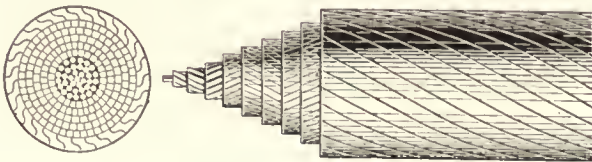

Locked-Wire Track Cable

of a greater number of wires than is used in the locked-coil cable and it therefore is more flexible. The outside layers are formed of interlocking sections which give a very smooth bearing surface. This type of construction also minimizes vibration under stress and

reduces the tendency of the individual wires to crystallize and break. There being no interstices between the wires, a greater amount of metal is used in a given diameter and thus a maximum strength is obtained. Due to its compact construction, the locked design offers great resistance to the crushing tendency of the loads passing over it.

This type of rope cannot be spliced like ordinary wire rope and any joints required must be made with couplings

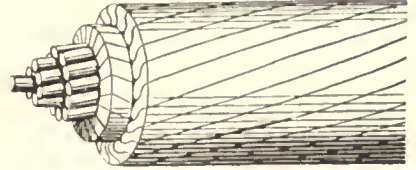
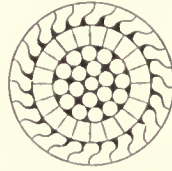

Locked-Coil Track Cable

of sufficiently small diameter to allow the cableway carriers to pass over them.

Flat Rope

Flat rope is used chiefly for hoisting purposes, being especially desirable when a large and long rope is required for hoisting heavy loads out of deep shafts, as it does not spin or twist. It is also used for operating spouts on coal or ore docks and other similar purposes. It is made up of a number of round wire ropes of alternate right and left lay, placed side by side and then sewed together with soft iron or steel wire thus forming a complete flat rope. The sewing wires are much softer than the steel wires composing the strands of the round ropes, and act as a cushion for the strands. This causes them to wear out much faster than the harder wires composing

16 Ropes—4 7-Wire Strands, 1 Hemp Core per Rope

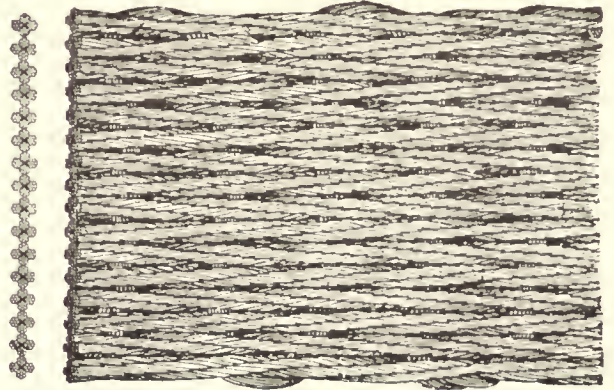

Flat Hoisting Rope

the rope and therefore the flat rope must sometimes be resewed with new wire. Should any of the rope strands become badly worn or damaged, they may be replaced by new strands and the complete flat rope continued in service.

Flat rope winds on itself and requires a reel but little wider than the width of the rope. This feature is of particular advantage where space is limited and the wide, heavy drum that would be required for a large and long round rope could not be installed or would not be desirable for other reasons. Flat rope is made from 2 in. to 7 in. in width; from 1/4 in. to 1/2 in. in thickness; and in lengths varying from 20 ft. to 3,000 ft.

The approximate capacities of wire rope, made of iron and steel of various grades, are given in the tables shown on the following pages.

Diameter in Inches	Iron				Crucible Cast Steel				Extra Strong Crucible Cast Steel				Plow Steel				Extra Strong Plow Steel			
	Approximate Strength in Tons of 2000 Pounds	Proper Working Load in Tons of 2000 Pounds	Diameter of Drum or Sheave in Feet	Approximate Weight per Foot in Pounds	Approximate Strength in Tons of 2000 Pounds	Proper Working Load in Tons of 2000 Pounds	Diameter of Sheave in Feet	Approximate Strength in Tons of 2000 Pounds	Proper Working Load in Tons of 2000 Pounds	Diameter of Sheave in Feet	Approximate Strength in Tons of 2000 Pounds	Proper Working Load in Tons of 2000 Pounds	Diameter of Sheave in Feet	Approximate Strength in Tons of 2000 Pounds	Proper Working Load in Tons of 2000 Pounds	Diameter of Sheave in Feet	Approximate Strength in Tons of 2000 Pounds	Proper Working Load in Tons of 2000 Pounds	Diameter of Sheave in Feet	Approximate Strength in Tons of 2000 Pounds
1 1/2	3.65	6.4	16	3.65	63	12.6	11	73	14.6	11	82	16.4	11	90	18	11	90	18	11	90
1 3/8	3	5.6	15	3	53	10.6	10	63	12.6	10	72	14.4	10	79	16	10	79	16	10	79
1 1/4	2.45	4.6	13	2.45	46	9.2	9	54	10.8	9	60	12	9	67	13	9	67	13	9	67
1 3/8	1.9	3.8	12	1.9	37	8.6	8	43	9.6	8	47	10.8	8	52	10	8	52	10	8	52
1	1.58	3	10.5	1.58	31	7.4	7	35	8.6	7	38	9.4	7	42	8.4	7	42	8.4	7	42
3/4	1.2	2.4	9	1.2	24	6.2	6	28	7.6	6	31	8.2	6	33	6.6	6	33	6.6	6	33
3/8	1.1	1.7	8.8	1.1	18.6	5.6	5	21	6.6	5	23	7.6	5	25	5.5	5	25	5.5	5	25
1/2	1.1	1.5	7.5	1.1	15.4	4.9	4 1/2	16.7	5.6	4 1/2	18	6.6	4 1/2	20	4.4	4 1/2	20	4.4	4 1/2	20
1/2	1.1	1.2	7	1.1	13.4	4.2	4	14.5	4.9	4 1/2	16	5.6	4	17 1/2	4	4	17 1/2	4	4	17 1/2
1/2	1.1	1.2	6	1.1	10	3.6	4	11	4.2	4	12	4.4	4	13	2.6	4	13	2.6	4	13
1/2	1.1	1.2	5.5	1.1	7.7	3.1	3 1/2	8.85	3.6	3 1/2	10	4.4	3 1/2	11	2.2	3 1/2	11	2.2	3 1/2	11
1/2	1.1	1.2	4.5	1.1	5.5	2.6	3	6.25	3.1	3	7	3.6	3	7 1/2	1.5	3	7 1/2	1.5	3	7 1/2
1/2	1.1	1.2	4	1.1	4.6	2.2	2 3/4	5.25	2.6	2 3/4	6	3.1	2 3/4	6 1/2	1.3	2 3/4	6 1/2	1.3	2 3/4	6 1/2
1/2	1.1	1.2	3.5	1.1	3.95	2.2	2 1/4	4.4	2.6	2 1/4	5	2.6	2 1/4	5.5	1.3	2 1/4	5.5	1.3	2 1/4	5.5
1/2	1.1	1.2	3	1.1	2.5	2	1 3/4	2.95	2.2	1 3/4	3.4	2.2	1 3/4	3.4	1.3	1 3/4	3.4	1.3	1 3/4	3.4

Haulage, Transmission, and Standing or Guy Rope 6 Strands—7 Wires per Strand—1 Hemp Core

Diameter in Inches	Crucible Cast Steel				Extra Strong Crucible Cast Steel				Extra Strong Plow Steel			
	TYPE C	TYPE D	TYPE C	TYPE D	TYPE C	TYPE D	TYPE C	TYPE D	TYPE C	TYPE D	TYPE C	TYPE D
1 1/2	63	12.6	3.65	4.00	73	14.6	3.65	4.00	8 1/2	15.8	2.55	2.80
1 3/8	53	10.6	3.10	3.45	63	12.6	3.10	3.45	8	13.6	2.55	2.80
1 1/4	46	9.2	2.55	2.80	54	10.8	2.55	2.80	7 1/2	11.6	2.30	2.55
1 3/8	37	7.4	2.05	2.30	43	8.6	2.05	2.30	6 3/4	9.2	1.94	2.19
1	31	6.2	1.65	1.80	35	7.0	1.65	1.80	5 3/4	7.6	1.58	1.83
3/4	24	4.8	1.24	1.38	28	5.6	1.24	1.38	5	6.0	1.24	1.38
3/8	18.6	3.72	.92	1.00	20	4.4	.92	1.00	4 1/2	5.4	.92	1.00
3/8	13	2.6	.64	.72	14.5	3.1	.64	.72	4	4.2	.64	.72
3/8	7.7	1.54	.40	.45	8.85	1.77	.40	.45	3 1/2	3.1	.40	.45
3/8	4.5	.92	.23	.25	5.25	1.05	.23	.25	2	2.2	.23	.25

Flattened Strand Haulage Rope Type C, 5 Strands—9 Wires per Strand—1 Hemp Core. Type D, 6 Strands—8 Wires per Strand—1 Hemp Core

Diameter in Inches	Crucible Cast Steel				Extra Strong Crucible Cast Steel				Extra Strong Plow Steel			
	TYPE A	TYPE B	TYPE A	TYPE B	TYPE A	TYPE B	TYPE A	TYPE B	TYPE A	TYPE B	TYPE A	TYPE B
2 1/4	133	26.6	8.00	9.20	160	32.0	8.00	9.20	210	42.0	8.00	9.20
2 1/8	106	21.2	6.30	7.25	123	24.6	6.30	7.25	166	33.2	6.30	7.25
1 3/4	85	17.0	4.85	5.60	99	19.8	4.85	5.60	133	26.6	4.85	5.60
1 3/8	72	14.4	4.15	4.75	83	16.6	4.15	4.75	110	22.2	4.15	4.75
1 1/2	64	12.8	3.55	4.00	73	14.6	3.55	4.00	98	19.8	3.55	4.00
1 3/8	56	11.2	3.00	3.45	64	12.8	3.00	3.45	89	18.2	3.00	3.45
1 1/4	47	9.4	2.45	2.80	53	10.6	2.45	2.80	72	14.4	2.45	2.80
1 3/8	38	7.6	2.00	2.30	44	8.8	2.00	2.30	56	11.2	2.00	2.30
1 1/8	30	6.0	1.58	1.80	34	6.8	1.58	1.80	45	9.0	1.58	1.80
3/4	23	4.5	1.20	1.38	26	5.2	1.20	1.38	35	7.0	1.20	1.38
3/4	17.5	3.5	.89	1.00	20.2	4.04	.89	1.00	26.3	5.20	.89	1.00
3/4	12.5	2.5	.62	.72	14.5	3.08	.62	.72	19	3.8	.62	.72
3/4	10	2.2	.50	.58	11.2	2.24	.50	.58	14.5	2.9	.50	.58
3/4	8.4	1.68	.39	.45	9.2	1.84	.39	.45	12.1	2.42	.39	.45

Flattened Strand Hoisting Rope Type A, 5 Strands—28 Wires per Strand—1 Hemp Core. Type B, 6 Strands—25 Wires per Strand—1 Hemp Core

Iron															
Crucible Cast Steel					Plow Steel					Extra Strong Plow Steel					
Diameter in Inches	Circumference in Inches	Approximate Weight per Foot in Pounds	Approximate Strength in Tons of 2000 Pounds	Proper Working Load in Tons of 2000 Pounds	Diameter of Drum or Sheave in Feet (Advised)	Approximate Straining Strength in Tons of 2000 Pounds	Proper Working Load in Tons of 2000 Pounds	Diameter of Drum or Sheave in Feet (Advised)	Diameter of Drum or Sheave in Feet (Advised)	Approximate Strength in Tons of 2000 Pounds	Proper Working Load in Tons of 2000 Pounds	Diameter of Drum or Sheave in Feet (Advised)	Approximate Strength in Tons of 2000 Pounds	Proper Working Load in Tons of 2000 Pounds	Diameter of Drum or Sheave in Feet (Advised)
2 1/4	8 5/8	11.95	111	22.2	17	211	42.2	11	11	275	55	11	315	63	11
2 1/2	7 7/8	9.85	92	18.4	15	170	34	10	10	229	46	10	283	53	10
2 3/4	7 1/8	8	72	14.4	14	133	26.6	9	9	186	37	9	210	42	9
2	6 3/4	6.30	55	11	12	106	21.2	8	8	140	28	8	166	33	8
1 7/8	5 7/8	5.55	50	10	12	96	19	8	8	127	25	8	150	30	8
1 3/4	5 1/2	4.85	44	8.8	11	85	17	7	7	112	22	7	133	27	7
1 1/2	5	4.15	38	7.6	10	72	14.4	6.5	6.5	94	19	6.5	110	22	6 1/2
1 1/4	4 3/4	3.55	33	6.6	9	64	12.8	6	6	82	16	6	98	20	6
1 3/8	4 1/4	3	28	5.6	8.5	56	11.2	5.5	5.5	72	14	5.5	84	17	5 1/2
1 1/8	4	2.45	22.8	4.7	7.5	47	9.4	5	5	58	12	5	69	14	5
1 1/8	3 3/2	2	18.6	3.72	7	38	7.6	4.5	4.5	47	9.4	4.5	56	11	4 1/2
1	3	1.58	14.5	2.90	6	30	6	4	4	38	7.6	4	45	9	4
3/4	2 3/4	1.20	11.8	2.36	5.5	23	4.6	3.5	3.5	29	5.8	3.5	35	7	3 1/2
3/4	2 1/4	.89	8.5	1.70	4.5	17.5	3.5	3	3	23	4.6	3	26.3	5.3	3
5/8	2	.62	6	1.20	4	12.5	2.5	2.5	2.5	15.5	3.1	2.5	19	3.8	2 1/2
1 1/8	1 3/4	.50	4.7	.94	3.5	10	2	2.25	2.25	12.3	2.4	2.25	14.5	2.9	2 1/4
1 1/2	1 1/2	.39	3.9	.78	3	8.4	1.68	2	2	10	2	2	12.1	2.4	2
1 1/4	1 1/4	.30	2.9	.68	2.75	6.5	1.30	1.75	1.75	8	1.6	1.75	9.4	1.9	1 3/4
3/8	1 1/8	.22	2.4	.48	2.25	4.8	.96	1.50	1.50	5.75	1.15	1.50	6.75	1.35	1 1/2
1 1/4	1	.15	1.5	.30	2	3.1	.62	1.25	1.25	3.8	.76	1.25	4.50	.9	1 1/4
1 1/4	3/4	.10	1.1	.22	1.50	2.2	.44	1	1	2.65	.53	1	3.15	.63	1

Standard Hoisting Rope 6 Strands—19 three-size Wires per Strand—1 Hemp Core

Crucible Cast Steel										Plow Steel										Extra Strong Plow Steel									
Diameter in Inches	Circumference in Inches	Approximate Weight per Foot in Pounds	Approximate Strength in Tons of 2000 Pounds	Proper Working Load in Tons of 2000 Pounds	Diameter of Drum or Sheave in Feet (Advised)	Approximate Breaking Stress in Tons of 2000 Pounds	Proper Working Load in Tons of 2000 Pounds	Diameter of Drum or Sheave in Feet (Advised)	Diameter of Drum or Sheave in Feet (Advised)	Approximate Strength in Tons of 2000 Pounds	Proper Working Load in Tons of 2000 Pounds	Diameter of Drum or Sheave in Feet (Advised)	Approximate Strength in Tons of 2000 Pounds	Proper Working Load in Tons of 2000 Pounds	Diameter of Drum or Sheave in Feet (Advised)														
2 1/4	8 5/8	11.95	200	40	233	47	265	53	278	55														
2 1/2	7 7/8	9.85	160	32	187	37	214	43	225	45														
2 3/4	7 1/8	8	125	25	150	30	175	35	184	37														
2	6 3/4	6.30	105	21	117	23	130	26	137	27														
1 7/8	5 7/8	5.55	94	18.8	106	21.2	119	23.8	125	25														
1 3/4	5 1/2	4.85	84	17	95	19	108	22	113	23														
1 1/2	5	4.15	71	14	79	16	90	18	95	19														
1 1/4	4 3/4	3.55	63	12	3.75	71	14	3.75	3.75	80	16	3.75	84	17	3.75														
1 1/2	4 1/4	3	55	11	3.5	61	12	3.5	3.5	68	14	3.5	71	14	3.5														
1 1/4	4	2.45	45	9	3.2	50	10	3.20	3.20	55	11	3.2	58	11	3.20														
1 1/8	3 3/2	2	34	7	2.83	30	8	2.83	2.83	44	9	2.83	46	9.2	2.83														
1	3	1.58	29	6	2.5	32	6.4	2.5	2.5	35	7	2.5	37	7.4	2.50														
3/4	2 3/4	1.20	23	5	2.16	25	5	2.16	2.16	27	5	2.16	29	5.8	2.16														
3/4	2 1/4	.89	17.5	3.5	1.83	19	3.8	1.83	1.83	21	4	1.83	23	4.6	1.83														
5/8	2	.62	11.2	2.2	1.75	12.6	2.5	1.75	1.75	14	3	1.75	16	3.2	1.75														
1 1/8	1 3/4	.50	9.5	1.9	1.5	10.5	2.1	1.5	1.5	11.5	2.3	1.5	12.5	2.5	1.50														
1 1/4	1 1/2	.39	7.25	1.45	1.33	8.25	1.65	1.33	1.33	9.25	1.85	1.33	9.75	1.9	1.33														
1 1/4	1 1/4	.30	5.5	1.1	1.16	6.35	1.27	1.16	1.16	7.2	1.4	1.16	7.50	1.5	1.15														
3/8	1 1/8	.22	4.2	.84	1	4.65	.93	1	1	5.1	1	1	5.30	1.06	1														

Special Flexible Hoisting Rope 6 Strands—37 Wires per Strand—1 Hemp Core

Crucible Cast Steel				Extra Strong Crucible Cast Steel				Plow Steel				Extra Strong Plow Steel			
Diameter in Inches	Circumference in Inches	Approximate Weight per Foot in Pounds	Approximate Strength in Tons of 2000 Pounds	Proper Working Load in Tons of 2000 Pounds	Diameter of Drum or Sheave in Feet Advised	Approximate Strength in Tons of 2000 Pounds	Proper Working Load in Tons of 2000 Pounds	Diameter of Drum or Sheave in Feet Advised	Approximate Strength in Tons of 2000 Pounds	Proper Working Load in Tons of 2000 Pounds	Diameter of Drum or Sheave in Feet Advised	Approximate Strength in Tons of 2000 Pounds	Proper Working Load in Tons of 2000 Pounds	Diameter of Drum or Sheave in Feet Advised	
1 1/2	4 3/4	3.19	58	11.0	3.75	66	13	3.75	74	14.8	3.75	80	16	3.75	
1 3/8	4 1/4	2.70	51	10.2	3.5	57	11	3.5	64	12.8	3.5	68	13	3.5	
1 1/4	4	2.20	42	8.4	3.2	47	9.4	3.2	52	10.4	3.2	56	11	3.2	
1 1/8	3 3/4	1.80	34	6.8	2.83	38	7.6	2.83	43	8.6	2.83	46	9.2	2.83	
1	3	1.42	26	5.2	2.5	29.7	5.9	2.5	33	6.6	2.5	36	7.2	2.5	
3/4	2 3/4	1.08	20	4	2.16	23	4.6	2.16	26	5.2	2.16	28	5.6	2.16	
2 3/4	2 3/4	1.80	15.3	3.06	1.83	17.6	3.5	1.83	20	4	1.83	22	4.4	1.83	
2 1/2	2 1/2	1.56	10.9	2.13	1.75	12.4	2.5	1.75	14	2.8	1.75	15	3	1.75	
2	2	1.18	8.7	1.74	1.5	10.1	2	1.5	11.6	2.32	1.50	12	2.4	1.5	
1 3/4	1 3/4	0.85	7.3	1.46	1.33	8	1.6	1.33	8.7	1.74	1.33	9.5	1.9	1.33	
1 1/2	1 1/2	0.75	6.3	1.24	1.16	6.30	1.26	1.16	6.90	1.74	1.16	7.5	1.9	1.16	
1 1/4	1 1/4	0.68	5.7	1.14	1	5.12	1.02	1	5.12	1.02	1	5.12	1.02	1	
1 1/8	1 1/8	0.61	4.2	0.84	0.83	4.66	0.83	0.83	3.35	0.67	0.83	3.35	0.67	0.83	
1 3/8	1 3/8	0.55	2.75	0.55	0.75	3.05	0.61	0.75	2.25	0.45	0.75	2.25	0.45	0.75	
1 1/8	1 1/8	0.13	1.80	0.36	0.75	2.02	0.40	0.75	2.25	0.45	0.75	2.25	0.45	0.75	

Extra Flexible Hoisting Rope 8 Strands—19 Wires per Strand—1 Hemp Core

Crucible Cast Steel				Plow Steel				Extra Strong Plow Steel					
Diameter of Sheave in Feet Advised	Finished Diameter over Servings in Inches	Diameter of Bare Rope in Inches	Approximate Weight in Pounds	Approximate Strength in Tons of 2000 Pounds	Proper Working Load in Tons of 2000 Pounds	Diameter of Bare Rope in Inches	Approximate Weight in Pounds	Approximate Strength in Tons of 2000 Pounds	Proper Working Load in Tons of 2000 Pounds	Diameter of Sheave in Feet Advised	Approximate Strength in Tons of 2000 Pounds	Proper Working Load in Tons of 2000 Pounds	Diameter of Sheave in Feet Advised
8	2 1/4	2	8.45	106	21.2	2 1/4	8.45	140	28	8	166	33	8
7.5	2	1 7/8	6.70	96	19.2	2	6.70	127	25	7.5	150	30	7.5
7	1 7/8	1 3/4	6.02	85	17.0	1 7/8	6.02	112	22	7	133	27	7
6.5	1 3/4	1 1/2	5.25	72	14.4	1 1/2	5.25	94	19	6.5	110	22	6.5
6	1 1/2	1 1/4	4.62	64	12.8	1 1/4	4.62	82	16	6	98	20	6
5.5	1 1/4	1 1/4	3.95	56	11.2	1 1/4	3.95	72	14	5.5	84	17	5.5
5	1 1/4	1 1/4	3.30	47	9.4	1 1/4	3.30	69	12	5	69	14	5
4.5	1 1/4	1 1/4	2.80	38	7.6	1 1/4	2.80	58	10	4.5	58	11	4.5
4	1 1/4	1 1/4	2.12	30	6.0	1 1/4	2.12	47	9.4	4	45	9	4
3.5	1	1	1.72	23	4.6	1	1.72	38	7.6	3.5	35	7	3.5
3	3/4	3/4	1.30	17.5	3.5	3/4	1.30	29	5.8	3	26.3	5.3	3
2.5	3/4	3/4	1.00	12.5	2.5	3/4	1.00	23	4.6	2.5	19	3.8	2.5
2	3/4	3/4	0.70	8.4	1.68	3/4	0.70	10	2.0	2	12.1	2.4	2

Steel Clad Hoisting Rope 6 Strands—19 Wires per Strand—1 Hemp Core

Crucible Cast Steel				Extra Strong Crucible Cast Steel				Plow Steel				Extra Strong Plow Steel			
Diameter of Bare Rope in Inches	Finished Diameter over Servings in Inches	Diameter of Drum or Sheave in Feet Advised	Approximate Strength in Tons of 2000 Pounds	Proper Working Load in Tons of 2000 Pounds	Diameter of Drum or Sheave in Feet Advised	Approximate Strength in Tons of 2000 Pounds	Proper Working Load in Tons of 2000 Pounds	Diameter of Drum or Sheave in Feet Advised	Approximate Strength in Tons of 2000 Pounds	Proper Working Load in Tons of 2000 Pounds	Diameter of Drum or Sheave in Feet Advised	Approximate Strength in Tons of 2000 Pounds	Proper Working Load in Tons of 2000 Pounds	Diameter of Drum or Sheave in Feet Advised	
2 3/4	2 3/4	8	160	32	8	187	37	8	214	43	8	225	45	8	
2 1/2	2 1/2	7	125	25	7	150	30	7	175	35	7	184	37	7	
2 1/4	2 1/4	6	105	21	6	117	23	6	130	26	6	137	27	6	
2	2	5.25	94	18.8	5.25	106	21.2	5.25	119	23.8	5.25	125	25	5.25	
1 3/4	1 3/4	4.75	84	17	4.75	95	19	4.75	108	22	4.75	113	23	4.75	
1 3/8	1 3/8	4.25	71	14	4.25	79	16	4.25	90	18	4.25	95	19	4.25	
1 1/2	1 1/2	3.75	63	12	3.75	71	14	3.75	80	16	3.75	84	17	3.75	
1 1/4	1 1/4	3.5	55	11	3.5	61	12	3.5	68	14	3.5	71	14	3.5	
1 3/8	1 3/8	3.2	45	9	3.2	50	10	3.2	58	11	3.2	58	11	3.2	
1 1/4	1 1/4	2.83	34	7	2.83	39	8	2.83	46	10	2.83	46	10	2.83	
1 1/8	1 1/8	2.5	29	6	2.5	32	6.4	2.5	44	9	2.5	37	7	2.5	
1	1	2.16	23	5	2.16	25	5	2.16	35	7	2.16	29	5.3	2.16	

Steel Clad Special Flexible Hoisting Rope 6 Strands—37 Wires per Strand—1 Hemp Core

6 Strands—61 Wires per Strand—1 Hemp Core

Crucible Cast Steel					
Diameter in Inches	Circumference in Inches	Approximate Weight per Foot in Pounds	Approximate Strength in Tons of 2000 Pounds	Proper Working Load in Tons of 2000 Pounds	Diameter of Drum or Sheave in Feet Advised
3 1/4	10 1/4	16.60	280	56	11
3	9 1/2	14.20	240	48	10
2 3/4	8 5/8	11.95	200	40	9
2 1/2	7 7/8	9.85	160	32	8
2 1/4	7 1/4	8.00	125	25	7
2	6 1/4	6.30	105	21	6
Extra Strong Crucible Cast Steel					
3 1/4	10 1/4	16.60	315	63	11
3	9 1/2	14.20	275	55	10
2 3/4	8 5/8	11.95	233	47	9
2 1/2	7 7/8	9.85	187	37	8
2 1/4	7 1/4	8.00	150	30	7
2	6 1/4	6.30	117	23	6
Plow Steel					
3 1/4	10 1/4	16.60	350	70	11
3	9 1/2	14.20	310	62	10
2 3/4	8 5/8	11.95	265	53	9
2 1/2	7 7/8	9.85	214	43	8
2 1/4	7 1/4	8.00	175	35	7
2	6 1/4	6.30	130	26	6
Extra Strong Plow Steel					
3 1/4	10 1/4	16.60	370	74	11
3	9 1/2	14.20	325	65	10
2 3/4	8 5/8	11.95	278	56	9
2 1/2	7 7/8	9.85	225	45	8
2 1/4	7 1/4	8.00	184	37	7
2	6 1/4	6.30	137	27	6

Extra Special Flexible Hoisting Rope

6 Strand—61 Wires per Strand—1 Hemp Core

Crucible Cast Steel					
Finished Diameter over Serving in Inches	Diameter of Bare Rope in Inches	Approximate Weight per Foot in Pounds	Approximate Strength in Tons of 2000 Pounds	Proper Working Load in Tons of 2000 Pounds	Diameter of Drum or Sheave in Feet Advised
3 1/4	3	16.80	240	48	10
3	2 3/4	14.35	200	40	9
2 3/4	2 1/2	12.05	160	32	8
2 1/2	2 1/4	9.90	125	25	7
2 1/4	2	8.45	105	21	6
Extra Strong Crucible Cast Steel					
3 1/4	3	16.80	275	55	10
3	2 3/4	14.35	233	47	9
2 3/4	2 1/2	12.05	187	37	8
2 1/2	2 1/4	9.90	150	30	7
2 1/4	2	8.45	117	23	6
Plow Steel					
3 1/4	3	16.80	310	62	10
3	2 3/4	14.35	265	53	9
2 3/4	2 1/2	12.05	214	43	8
2 1/2	2 1/4	9.90	175	35	7
2 1/4	2	8.45	130	26	6
Extra Strong Plow Steel					
3 1/4	3	16.80	325	65	10
3	2 3/4	14.35	278	55	9
2 3/4	2 1/2	12.05	225	45	8
2 1/2	2 1/4	9.90	184	37	7
2 1/4	2	8.45	137	27	6

Steel Clad Extra Special Flexible Hoisting Rope

Crucible Cast Steel						Extra Strong Crucible Cast Steel			Plow Steel		
Diameter in Inches	Approximate Circumference in Inches	Weight per Foot in Pounds	Approximate Breaking Stress in Tons of 2000 Pounds	Proper Working Load in Tons of 2000 Pounds	Diameter of Drum or Sheave in Feet Advised	Approximate Breaking Stress in Tons of 2000 Pounds	Proper Working Load in Tons of 2000 Pounds	Diameter of Drum or Sheave in Feet Advised	Approximate Breaking Stress in Tons of 2000 Pounds	Proper Working Load in Tons of 2000 Pounds	Diameter of Drum or Sheave in Feet Advised
1 3/4	5 1/2	5.50	85.90	17.1	7.00	101.00	20.2	7.00	111.10	22.2	7.00
1 1/2	5	4.90	74.40	14.8	6.50	87.60	17.5	6.50	96.30	19.2	6.60
1 1/4	4 3/4	4.32	63.80	12.7	6.00	75.00	15.0	6.00	82.50	16.5	6.00
1 1/2	4 1/4	3.60	52.00	10.4	5.50	62.40	12.4	5.50	68.60	13.7	5.50
1 1/4	4	2.80	43.80	8.7	5.00	51.60	10.3	5.00	56.80	11.3	5.00
1 1/2	3 3/4	2.34	36.80	7.3	4.50	43.20	8.6	4.50	47.50	9.5	4.50
1	3	1.73	28.00	5.6	4.00	33.00	6.6	4.00	36.30	7.2	4.00
3/4	2 3/4	1.44	22.50	4.5	3.50	26.50	5.3	3.50	31.80	6.3	3.50
1/2	2 1/4	1.02	16.70	3.3	3.00	19.60	3.9	3.00	24.60	4.9	3.00
3/8	2	.70	11.10	2.2	2.50	13.10	2.6	2.50	15.75	3.1	2.50
1/4	1 3/4	.57	9.10	1.8	2.25	10.70	2.1	2.25	12.80	2.5	2.25
1/2	1 1/2	.42	6.90	1.3	2.00	8.10	1.6	2.00	9.75	1.9	2.00
3/8	1 1/4	.31	4.90	.98	1.75	5.80	1.1	1.75	6.85	1.3	1.75
1/4	1 1/8	.25	3.90	.78	1.50	4.60	.92	1.50	5.55	1.1	1.50

Non-Spinning Hoisting Rope 18 Strands—7 Wires per Strand—1 Hemp Core

Iron				
Diameter in Inches	Circumference in Inches	Approximate Weight per Foot	Approximate Strength in Tons of 2000 lbs.	Circumference of Equal Manila Rope
1 3/4	5 1/2	4.85	42	11
1 1/2	5 1/4	4.42	38	10 1/2
1 1/4	5	4.15	35	10
1 1/2	4 3/4	3.55	30	9 1/2
1 1/4	4 1/2	3.24	28	9
1 3/8	4 1/4	3	26	8 1/2
1 1/2	4	2.45	23	8
1 1/4	3 3/4	2.21	19	7 1/2
1 1/2	3 1/2	2	18	6 1/2
1 1/4	3 1/4	1.77	16.1	6
1	3	1.58	14.1	5 3/4
3/4	2 3/4	1.20	11.1	5 1/4
1/2	2 1/2	1.03	9.4	5
3/4	2 1/4	.89	7.8	4 3/4
5/8	2	.62	5.7	4 1/2
3/8	1 3/4	.50	4.46	3 3/4
1/2	1 1/2	.39	3.39	3
3/8	1 1/4	.30	2.35	2 1/2
5/8	1 1/8	.22	1.95	2 1/4
3/8	1	.15	1.42	2

Galvanized Standing or Guy Rope

Crucible Cast Steel				
Diameter in Inches	Circumference in Inches	Approximate Weight per Foot	Approximate Strength in Tons of 2000 lbs.	Circumference of Equal Manila Rope
1 1/4	4	2.45	42	13
1 1/2	3 3/4	2.21	38	12
1 1/4	3 1/2	2	34	11
1 1/2	3 1/4	1.77	31	10
1	3	1.58	28	9
7/8	2 3/4	1.20	22	8 1/2
5/8	2 1/2	1.03	19	8
3/4	2 1/4	.89	16.8	7
5/8	2	.62	11.7	6
3/8	1 3/4	.50	9	5 3/4
3/8	1 1/2	.39	7	4 3/4
1/2	1 1/4	.30	6	4 1/2
3/8	1 1/8	.22	4.2	3 3/4
5/8	1	.15	3.2	3

6 Strands—7 Wires per Strand—1 Hemp Core

Crucible Cast Steel			
Diameter in Inches	Approximate Circumference in Inches	Approximate Weight per Foot in Pounds	Approximate Breaking Stress in Tons of 2000 Pounds
2 1/4	7 1/4	12.50	190
2	6 1/4	10.00	160
1 3/4	5 1/2	7.65	120
1 5/8	5 1/8	6.60	103
1 1/2	4 3/4	5.70	89
1 3/8	4 1/4	4.75	75
1 1/4	4	3.80	62
1 1/8	3 1/2	3.15	50
1	3	2.50	40
7/8	2 3/4	1.88	30
3/4	2 1/4	1.30	22
5/8	2	.90	15.5
1/2	1 3/4	.72	12.5
1/2	1 1/2	.57	10

Locked-Wire Track Cable

Diameter in Inches	No. of Wires in Strand	Weight per 100 Feet in Pounds	Crucible Steel		Plow Steel
			Breaking Stress in Tons of 2000 Pounds	Breaking Stress in Tons of 2000 Pounds	Breaking Stress in Tons of 2000 Pounds
2 1/2	91	1310	285.00	335.00	
2 1/4	91	1036	233.00	266.00	
2 3/8	91	935	204.00	240.00	
2	61	840	185.00	218.00	
1 7/8	61	728	161.00	189.00	
1 3/4	61	659	145.80	171.00	
1 5/8	61	563	124.00	146.00	
1 1/2	37	488	108.40	127.50	
1 3/8	37	401	88.80	105.00	
1 1/4	37	323	71.80	84.60	
1 3/8	37	270	60.00	70.70	
1 1/2	19	220	49.20	58.00	
1 3/8	19	169	37.60	44.40	
1 1/4	19	124	27.60	32.50	
1 1/8	19	86	19.20	22.30	

Round Wire Track Cable

Width and Thickness in Inches	Approximate Weight per Foot in Pounds	Crucible Steel		Plow Steel		
		Approximate Breaking Stress in Tons of 2000 Pounds	Proper Working Load in Tons of 2000 Pounds	Approximate Breaking Stress in Tons of 2000 Pounds	Proper Working Load in Tons of 2000 Pounds	
1/4-inch Thick	1/4 x 2 1/4 x 2 1/2 1/4 x 3	.82 1.06 1.23	17 22 26	3.4 4.4 5.2	20 26.5 31	4.0 5.3 6.2
3/8-inch Thick	3/8 x 2 3/8 x 2 1/2 3/8 x 3 3/8 x 3 1/2 3/8 x 4	1.10 1.35 1.60 1.88 2.15	23 30 36 41 48	4.6 6.0 7.2 8.2 9.6	28 35 43 50 57	5.6 7.0 8.6 10.0 11.4
1/2-inch Thick	1/2 x 2 1/2 x 2 1/2 1/2 x 3 1/2 x 3 1/2 1/2 x 4 1/2 x 4 1/2 1/2 x 5 1/2 x 5 1/2 1/2 x 6	1.30 1.70 1.89 2.30 2.43 2.85 3.10 3.50 3.73	27 36 41 50 54 63 68 77 81	5.4 7.2 8.2 10.0 10.8 12.6 13.6 15.4 16.2	33 43 49 60 65 76 81 92 97	6.6 8.6 9.8 12.0 13.0 15.2 16.2 18.4 19.4
3/4-inch Thick	3/4 x 2 1/2 3/4 x 3 3/4 x 3 1/2 3/4 x 4 3/4 x 4 1/2 3/4 x 5 3/4 x 5 1/2 3/4 x 6 3/4 x 7	2.20 2.50 2.80 3.15 3.55 4.20 4.55 4.90 5.90	45 52 60 69 83 90 98 105 128	9.0 10.4 12.0 13.8 16.6 18.0 21.0 24.0 25.6	54 63 72 82 99 108 118 126 153	10.8 12.6 14.4 16.4 19.8 21.6 23.6 25.2 30.6

Flat Hoisting Rope

Crucible Cast Steel			
Diameter in Inches	Approximate Circumference in Inches	Approximate Weight per Foot in Pounds	Approximate Breaking Stress in Tons of 2000 Pounds
1 5/8	5 1/4	6.30	103
1 1/2	4 3/4	5.30	89
1 3/8	4 1/4	4.40	75
1 1/4	4	3.70	62
1 1/8	3 3/4	3.00	50
1	3	2.35	40
7/8	2 3/4	1.80	30

Locked-Coil Track Cable

6 Strands—42 Wires each—7 Hemp Cores

Diameter in Inches	Circumference in Inches	Approximate Weight per Foot in Pounds	Diameter of Drum or Sheave in Inches Advised	Approximate Breaking Strength	
				Iron Pounds	Crucible Cast Steel Pounds
1	3	1.10	24	22,000	35,000
7/8	2 3/4	.84	21	15,500	26,000
3/4	2 1/4	.62	18	11,000	18,000
5/8	2	.43	15	7,000	13,500
1/2	1 3/4	.35	13 1/2	6,300	11,000
1/2	1 1/2	.28	12	5,800	9,000
3/8	1 1/4	.21	10 1/2	4,000	6,500
3/8	1 1/8	.16	9	3,000	4,800
1/4	1	.11	7 1/2	1,900	3,600
1/4	3/4	.07	6	1,300	2,500
1/8	3/8	.042	5	750	1,350

Filler or Hand Rope

5 Strands—19 Wires per Strand—1 Hemp Core

Crucible Cast Steel						
Diameter in Inches before Serving	Approximate Diameter after Serving with Marlin	Approximate Circumference after Serving with Marlin	Approximate Breaking Strain in Tons of 2000 Lbs.	Allowable Working Strain in Tons of 2000 Lbs.	Minimum Size of Drum or Sheave in Feet	Approximate Weight per Foot in Lbs.
1 3/4	2 1/8	6 5/8	85	17.0	7 1/4	4.88
1 5/8	2	6 1/4	72	14.4	6 1/4	4.19
1 1/2	1 7/8	5 5/8	67	13.4	5 3/4	3.60
1 3/8	1 3/4	5 1/2	56	11.6	5 1/2	3.06
1 1/4	1 5/8	5 1/8	47	9.4	5	2.52
1 1/8	1 1/2	4 3/4	38	7.60	4 1/2	2.07
1	1 3/8	4 1/8	30	6.00	4	1.66
7/8	1 1/4	3 7/8	23	4.60	3 1/2	1.29
3/4	1 1/8	3 3/2	17.5	3.50	3	1.12
5/8	1	3 1/8	12.5	2.50	2 3/4	.80
1/2	7/8	2 5/4	9.0	1.80	1 3/4	.60
1/2	3/4	2 3/8	8.4	1.68	1 1/2	.49
3/8	5/8	2	4.8	0.96	1	.36
1/4	1/2	1 1/2	2.2	0.44	1/2	.21

Extra Strong Crucible Cast Steel

Diameter in Inches before Serving	Approximate Diameter after Serving with Marlin	Approximate Circumference after Serving with Marlin	Approximate Breaking Strain in Tons of 2000 Lbs.	Allowable Working Strain in Tons of 2000 Lbs.	Minimum Size of Drum or Sheave in Feet	Approximate Weight per Foot in Lbs.
1 3/4	2 1/8	6 5/8	98	19.6	7 1/4	4.88
1 5/8	2	6 1/4	83	16.6	6 1/4	4.19
1 1/2	1 7/8	5 5/8	72	14.4	5 3/4	3.60
1 3/8	1 3/4	5 1/2	64	13.0	5 1/2	3.06
1 1/4	1 5/8	5 1/8	53	10.6	5	2.52
1 1/8	1 1/2	4 3/4	43	8.60	4 1/2	2.07
1	1 3/8	4 1/8	31	6.80	4	1.66
7/8	1 1/4	3 7/8	26	5.20	3 1/2	1.29
3/4	1 1/8	3 3/2	20.2	4.04	3	1.12
5/8	1	3 1/8	14.0	2.80	2 3/4	.80
1/2	7/8	2 5/4	10.1	2.02	1 3/4	.60
1/2	3/4	2 3/8	9.2	1.84	1 1/2	.49
3/8	5/8	2	5.30	1.06	1	.36
1/4	1/2	1 1/2	2.43	0.49	1/2	.21

Marlin-Clad Wire Rope

PACKAGE HANDLING CONVEYORS

Arm and Suspended Tray Elevators; Push Bar, Apron
and Belt Elevators and Conveyors; Gravity
Roller Conveyors and Spirals; Spiral
Chutes; Special Conveyors

A Treatise Covering the Construction and Application
of Continuous Elevators and Conveyors
for Handling Packed Materials

By

W. T. SPIVEY

Consulting Engineer; Associate Member, American Society of Mechanical Engineers;
Member, Society of Terminal Engineers



Conveyors and Elevators for Packed Material

CONTINUOUS ELEVATORS AND CONVEYORS for the handling of packed materials fall naturally into the following classes: arm elevators, suspended tray elevators, push-bar elevators and conveyors, apron elevators and conveyors, belt conveyors and elevators, gravity roller conveyors, gravity roller spirals, spiral chutes, haulage, overhead track, pneumatic, wire line carriers and other special elevators and conveyors.

So far as is consistent with clearness, the commonly accepted names have been given to the different types. However, as these names vary so greatly among the many makers and users of this equipment, it has, in several instances, been necessary to arbitrarily select the name which is most descriptive of the character of the machine. In a few cases the different types may seem to overlap each other slightly, as in the case of gravity roller conveyors and gravity roller spirals, but it has been considered best to treat them separately because their application is so distinctly different. In the division covering haulage, overhead track, pneumatic and other special elevators and conveyors, many very different types of machines have been considered together, either because their range of application is limited, or because they are less strictly material handling equipment. A few of these special machines are somewhat related in their design and operation to machines in the other main classes. These have been considered separately largely to make more sharp the distinctive features of the main classes by removing from them the unusual variations found in these more specialized machines.

In the presentation of the various types of these continuous carriers, each type has been considered from the following points of view: general application, specifications, notes on operation, individual industrial applications, mechanical details.

Under general application is discussed the general scope

of use of the type of equipment, with its peculiar advantages and limitations. With the purpose of presenting in one place the complete description of the type, both elevators and conveyors of that type have been considered together. In the individual industrial application paragraphs, however, the elevators and conveyors have been treated separately, since the application of the same mechanical type is often quite different in elevating from what it is in conveying.

The general specifications of each class of equipment are given in as much detail as the widely varying practice of the different manufacturers make it practicable.

The notes on operation cover mainly the ordinary care and attention required in the operation and maintenance of each type of continuous conveying equipment. It has not been considered necessary to include many of the more obvious principles of operation common to the maintenance of all classes of mechanical equipment.

The individual applications, with their illustrations are presented with the two-fold purpose of pointing out, in the various major industries, some of the purposes for which continuous elevators and conveyors have been successfully used, and of indicating the logical available machine for the service. Space does not permit more than a limited number of typical illustrations of each type, and there are, obviously, innumerable other industrial operations in which the

equipment is being used to equally good advantage. In these application paragraphs have been given, where practical, more detailed specifications for the machines as applied to each industry.

The mechanical details section has been separated from the rest of the text with the purpose of simplifying reference by treating the details of elevators and conveyors for both packed and loose material in the most compact and readily available form.

Arm Elevators
Suspended Tray Elevators
Push-Bar Elevators and Conveyors
Apron Elevators and Conveyors
Belt Conveyors and Elevators
Gravity Roller Conveyors
Gravity Roller Spirals
Spiral Chutes
Special Elevators and Conveyors: Haulage; Overhead Track; Special Chain; Carrousel; Sling Type Carriers; Live Roll; Pneumatic; Wire Line Carrier.

Arm Elevators

The arm elevator is the simplest type of continuous motion equipment for the elevating of packages vertically, or at high angles of incline. Properly designed it is adapted to lowering as well, although it is not so automatic in this direction as in elevating. This type of elevator is best adapted to the handling of objects of uniform size—barrels, bales, bags, boxes. With the finger-arm carriers in most common use packages are picked up automatically from the loading fingers or stations at any floor on the up-side and discharged over the top only. The use

of self-dumping or tilting arms, however, permits the load to be discharged at any desired floor. As gravity lowerers, controlled by small motors or mechanical brakes, these elevators have found a fairly wide field of application. With either finger or solid tray arms, loaded manually on the down-side, fragile packages are safely handled.

This flexibility of use has made the arm elevator very efficient in multi-story storage buildings, marine and terminal freight houses, and in many industrial plants. The small floor space required is an important feature in build-

ings in which operating space is limited. Improvements in loading and discharge devices have materially increased the usefulness of such elevators by making possible the automatic loading from other conveyors as well as the discharge to lines of conveyors on the upper floors.

General Specifications

Frame. Wood frames are much used, with channel or other chain guides attached to the timbers. The all-steel frame, however, in which the chain or arms run in guides formed by the structural members, is more generally satisfactory for permanent installations. The frame is usually continuous from bottom to top, although the entire weight is often carried on the top floor. In any case, the vertical members particularly should be thoroughly tied together and braced.

Chain and Arm Guides. In the inclined types of arm elevators, unless the packages are too heavy no top guides are necessary, the tightness of the chain and the weight of the package against the frame being depended upon to prevent the arm from turning back under the load. In vertical, or nearly vertical, elevators, however, the points of attachment of the cantilever arms to the chain should run in guides, except for the lightest packages. With steel frame elevators, these guides are usually formed by the frame members, but in either case they must insure stiff support for the cantilever arms, as well as smooth travel of the load in a straight line. In some of the self-dumping arm elevators, the arm guides are built with such curves as to cause the tripping of the arm.

Arms. The simplest arm is composed of two fingers of iron or steel. Occasionally wood arms are used, with braces under each finger, all connected to form a rigid cantilever unit. For elevating barrels or kegs these fingers should be so shaped as to hold the package securely in place. For boxes, bales, or bags, straight arms are customary, since for such packages the straight arm makes for more perfect discharge. With this type arm slats are often used between the chains to form a back for the arms and prevent the throwing of packages through the chain. Solid tray arms may be of wood, or, for small heavy packages steel angles are often used for handling objects of miscellaneous size. These trays will not pick up the load as will the finger-arm type. These rigid types of arms practically all discharge over the top, although by arranging special trips on the up-side they can be made to discharge certain packages at any floor. Similarly, specially designed arms will lower packages also, either on the down-side or by running the elevator backward. However, for discharging on the up-side the more highly developed self-dumping arm is more efficient. This arm is so designed as to trip at any desired floor. It will also lower packages on the down-side.

Loading. The loading of most arm elevators is semi-automatic, in that they pick up the load from loading fingers at any floor at which these may be set, usually the first. Loading from chutes, barrel skids, gravity or power conveyor is feasible, but, except for the simplest conditions very careful designing of the timing or other loading devices is essential. This applies also to automatic feeders. Certain packages such as cylinders in lowering are loaded automatically by trips operated by the descending arms. However, for lowering the great majority of packages, hand-loading is usual. For down-loading the speed should be low, preferably not over 40 ft. per min. Particularly in handling heavy packages low speeds relieve the machine of much of the shock of pick-up incident to elevators of this type.

Discharge. Discharge of the simpler arm elevators

is usually over the top. For the most effective discharge the top sprocket should be of sufficient size—from 12 in. to 24 in. is usual—to prevent too much “jerk” of the arms as they pass around the top. Unless a conveyor is provided to receive the packages a sloping discharge chute is rather essential. This chute should be carefully fitted to the path of the arms, so that packages such as loose bags will not be caught between the arms and the chute. Unless the elevator is run at the lowest speed that will give the required capacity, barrels and other heavy packages are apt to discharge roughly. Certain specially designed types of arm elevators, particularly those for elevating lumber, are built to carry their load over the top and deposit it at any desired point on the down-side.

With self-dumping arms, however, the load may be discharged at any floor on the up-side, either by so curving the chain guides as to dump the package forward, or by using arms which dump themselves upon striking adjustable trips which are set at the desired floor. In any case, whether in elevating or lowering, the package must leave the elevator promptly so that the following arm will not strike it. This point must be more carefully considered in intermediate floor discharge than in the more positive top discharge.

Drive and Take-up. In this type elevator either worm or spur gears are ordinarily used. The worm gears serve also as a safety brake in case of accidental cut-off of the power. The take-up is almost invariably placed at the bottom of the elevator. When used as lowerers these elevators are sometimes operated without motors, the control being secured by the use of mechanical brakes.

Control and Safety Devices. There is a tendency toward the more extensive use of the control operated from several points, particularly on the multi-story elevators. There is also an increasing use of safety devices such as those which cut off the motor if any packages fail to load or discharge properly, and others for similar purposes. These devices are generally electrical, and are comparatively simple in operation.

Operation

The most important factor in successful operation of the arm elevator is really a point of design. This is that the elevator should be run at as low a speed as will give the required capacity and insure proper discharge. That this would be done in all cases would seem self-evident, but the fact remains that most of these machines run at speeds faster than is either necessary or advisable. Most of them are designed with a speed to serve very rare peak loads and are continually operated at this speed. In top discharge elevators the failure to provide sufficient height above the discharge floor to allow for piling up of bags or packages makes it necessary to watch the discharge too closely. This reduces the economy of the elevator by making the operation less automatic than it would otherwise naturally be. In manual loading considerable time is saved if the men can deposit their loads on the loading station or feeder and not wait for the elevator arms. In the multi-story elevators, in particular, signal bells or speaking tubes between points of dispatch and delivery are useful to promote efficiency in operation.

Where the rigid arm elevator is made portable it should be mounted on rails, unless the floor is unusually smooth, in which case casters or wheels are better. In any case, the spread of the base must be sufficient to insure the stability of the machine, particularly in handling heavy loads or in moving from place to place. The smaller elevators may well be hand-propelled, but the machine that is pro-

pelled by its own power, especially if it is large and heavy. is far more satisfactory.

Storage

Bags—Boxes—Bales—Barrels

In warehouses handling a fairly limited range of packages the arm elevator finds its most economical application. Because of the simple construction and the small floor space required it is often profitable to install several elevators in one building in order entirely to eliminate long hauls on both the receiving and upper floors. Such a system provides the shortest route from the car doors to the storage piles on the floors above. Elevators of this type are frequently installed on receiving platforms, discharging through convenient windows above.

The inclined, double-strand arm elevators are the simplest of the type. Where the incline is sufficient to make the weight of the packages rest partly against the frame in their ascent, chain or arm guides are unnecessary. Timber frames are much used, although steel angles or channels make a stiffer and better construction. In either case



High Discharge Prevents Congestion

a smooth running track for the chain, preferably of steel, is essential. The photograph shows a good top discharge arrangement, with the steel chute fitted as closely to the elevator as the traveling arms will permit. This is particularly important in elevating such loose packages as bags, where there is danger of the package catching in the opening between the chute and the elevator arms. The adequate height of discharge above the floor, as shown, allows many bags to pile up without any danger of blocking the elevator. However, discharge to a table from 1 ft. to 2 ft. high makes easier manual handling of the bags.

Warehousing

Bags—Miscellaneous Commodities

The use of the inclined portable arm elevator, discharging through second or third-story warehouse windows, provides a very direct transfer of commodities from trucks or cars to the storage piles on these upper floors. Much time would be lost in trucking these bags to freight elevators within the building, and then making a similar trip on the storage floors above. While the elevator shown has a fixed height of discharge, these machines are built with adjustable carrier booms, so that the same machine will serve several floor levels. Although this type of elevator is not so versatile with regard to the range of package

it will handle, as is the inclined apron elevator, it occupies less space and may be of somewhat lighter construction.

Equipped with large wheels, as shown, this machine will



Direct Line to Storage Piles

stand moving over cobble stones or other equally rough outdoor pavements. It should be light enough to be easily moved by hand. Instead of the wood base frame, a stiffer and more serviceable base may be made from steel channels to which the upper frame members can be more securely connected. For handling bags, light detachable link chain, with straight arms, forms the most satisfactory carrier. The loading point should be made as low as the clearance of the arms will permit. In the machine pictured, no return track is provided for the chain and arms. Some weight is thus saved but the result is not so good as with return guides.

Sugar

Bags—Barrels—Bales

In the warehousing of sugar, copra, cork, and many similar commodities, the portable bag elevator makes a profitable saving over the old method of gang piling. These machines are mounted either on rails or, where the floor is sufficiently smooth and firm, on large casters, the latter method giving greater freedom of movement about the floor. While they may be self-propelled, they are usually moved from place to place by hand. While elevators of this type are not so flexible in operation as the inclined piler, in that they are not adjustable as to height of discharge and have not the same large capacity, they do, however, occupy less floor space and, for the same maximum discharge height, may be made somewhat lighter.

With this, as with practically all other portable pilers, the problem has been to build a machine light enough to be easily portable, yet sufficiently strong and well braced to withstand the rather hard service to which it is subjected. Light steel frames, thoroughly braced, are best for this purpose. For greater stability these machines may well be built with the four angles forming the tower sloping inward toward the top. Where the piling can be so organized that the storage area can be served from one or two lines of light track, the question of mounting is a fairly simple one.

With this method of vertical piling long portable chutes from the top of the elevator are used to discharge the pack-

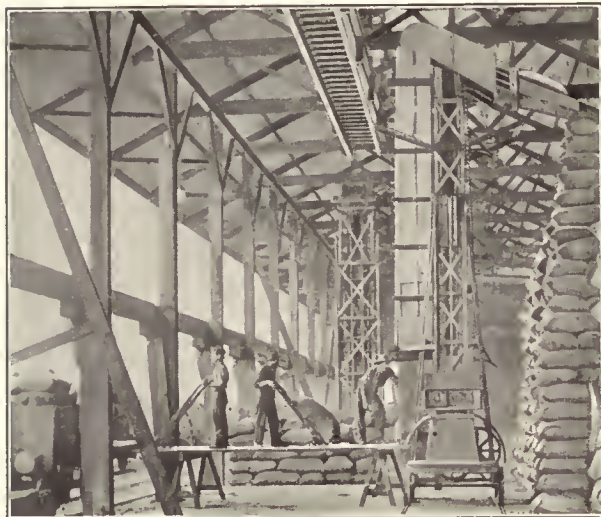

High Piling with Portable Elevator

ages. These chutes are later employed in breaking down the piles.

Terminal Freight Handling

Bags—Barrels—Drums

The simple construction and small space taken up by the standard bag elevator is well illustrated in the photograph. Since these steel frame units are largely shop-assembled they are quickly and easily installed. In long, two-story freight houses or double-deck piers a battery of



For Either Elevating or Lowering

such elevators makes a surprising saving in time and labor by eliminating long hauls and waits for slow moving platform elevators. Because of the vertical position of the elevator, a comparatively small hatch in the upper floor is sufficient opening. With arms of the type shown, packages may be lowered on the opposite side, although in this case neither the loading nor the discharge is so automatic.

The self-dumping arm usually carries its own tripper, which is operated by a lever set at the desired point of discharge. Rigid arms of the more simple types dump

their load when tilted forward by the outward curving of the guides. This simpler method is generally not so positive or satisfactory as the self-tripping arms. For this service steel shapes of such section as to form channel guides for the attachments of the arms to the chain make excellent frames. Both single strands of steel chain, and double-strand detachable malleable chain, are commonly used. Speeds of from 40 ft. to 60 ft. per min. are usual for terminal freight handling service.

Department Stores

Parcels—Boxes—Cartons—Bundles

The principle of the arm elevator applied to lowering has produced an economical machine for the lowering of parcels to the shipping floor, or for other similar transfers, in department stores, mail order, and wholesale supply and distributing houses. While such a lowerer is almost invariably loaded by hand at the various upper floors, it is thoroughly practicable to make the delivery automatic, to belt or other conveyers at the discharge point. Even the most fragile

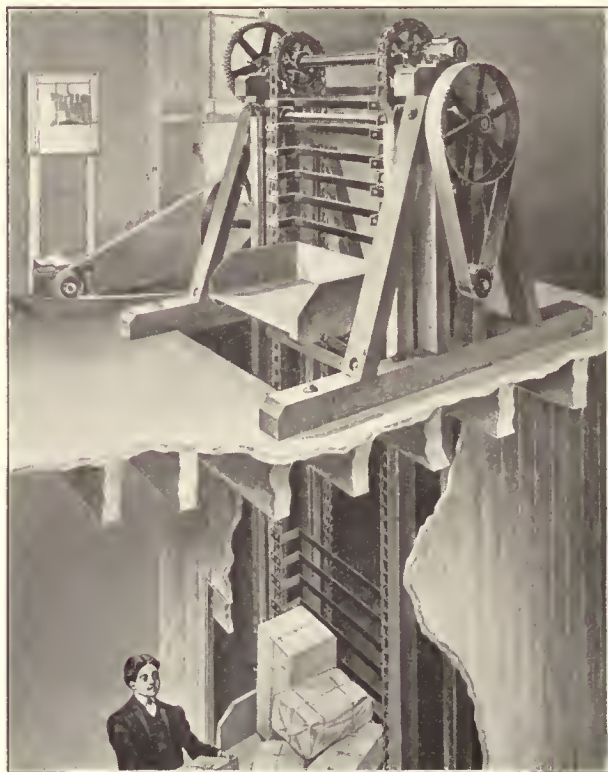

Lowering Packages for Shipment

objects, as well as packages of every size from the smallest department store paper bag to boxes the size of the tray itself, are safely and efficiently handled on such a lowerer. The same machine, running in reverse direction, may be used also as an elevator.

Solid wood trays are usual, largely because the service is light and many of the packages very small. Low speeds of from 30 ft. to 40 ft. per min. are ordinarily ample for the capacity necessary. With such low speeds both loading and discharge are made easier and more efficient. The steel slats between the chain above the tray, as shown, are provided to stop such packages as might otherwise be thrown down the shaft in careless loading. In a lowerer of this type the motor is required more for the purpose of

insuring steady movement than to furnish driving power. At the discharge point—usually the bottom of the lowerer—the tray should dump its load easily into a chute or moving conveyor.

Lumber

Boards—Timbers

The general application of the arm elevator to lumber handling is of comparatively recent development. Portable machines of the type shown are used to pile to heights as great as 40 ft., yet they occupy comparatively small space in the driveway. It becomes profitable by their use to pile lumber much higher—requiring correspondingly less yard space—than with hand piling. The top boards are piled at practically the same cost as the lower ones. These machines are reversible in motion to allow them to serve piles

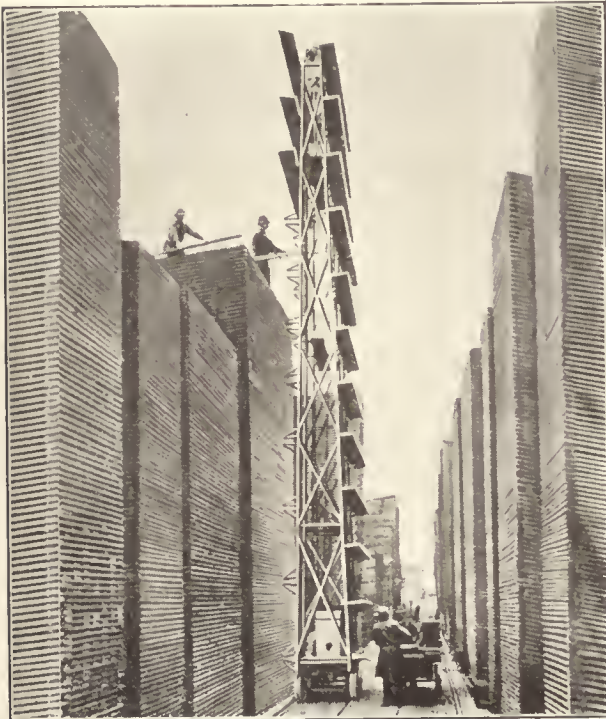

Increasing Storage Capacity in Lumber Yards

at either side in narrow aisles without turning around. Stationary lumber elevators of this type are used mainly for raising lumber to the upper floors of wood-working plants, the boards entering the building sideways through a long slot in the wall at the top of the elevator.

In elevators with the discharge feature of the portable stacker shown, the boards are carried over the top and discharged at any desired point on the down-side, either by hand or by automatic unloading arms. The discharge in the stationary elevators is ordinarily over the top, the boards being carried on steel angle, or similar shelves, attached to two or more chains. If the angle of incline is such that the boards would tend to turn backward top guards should be provided. To insure easy and satisfactory loading and discharge these elevators should be run at rather low speeds, preferably not over 30 ft. per min. The higher portable pilers, because of the small wheel-base in proportion to their height, are generally more satisfactory if mounted on rails. However, if the ground is hard or has a concrete or similarly firm surface, rails are not nec-

essary. Either electric motor or gas engine drive is usual, although wherever the current is available the former is to be preferred.

Construction

Bags

The inclined arm elevator is being used to an increasing extent on construction work for elevating bags of cement, plaster, and other building materials from cars or trucks to storage. On building operations where the receiving



Delivering Cement by Temporary Elevator

platforms are some distance from storage, these machines are frequently built with horizontal runs, serving the double purpose of conveying and elevating. There are few parts in this type elevator which are affected by exposure to the weather, and little protection is required further than the housing of the driving mechanism. The ease with which such machines are erected or taken down makes them peculiarly applicable to moving from one construction job to another.

Because of their rather temporary nature, the frames of these machines are ordinarily built of wood, the chain running on the frame itself or on a steel strip provided for this purpose. Both single and double-strand chain are commonly used in such elevators, with finger arms or individual tray-carriers of sheet steel designed to fit the package to be handled. While usually built in inclined positions to render their construction more simple, the vertical elevator with proper chain guides is equally satisfactory where it is necessary to conserve space. Plain detachable link chain is thoroughly satisfactory, running at speeds of from 40 ft. to 60 ft. per min.

Flour—Grain—Seeds—Feed—Hay

Bags—Bales—Barrels

Recent developments in automatic loading of arm elevators have materially increased their economy of operation. By the use of such loading devices this machine is made a thoroughly automatic unit of conveying systems that eliminates all manual handling from the packing room to the storage pile or the cars. Working as a separate unit

the arm elevator forms a very direct route from receiving platforms to upper storage floors of flour, grain and hay warehouses. From the standpoint of installation this is the



Belt Elevator with Automatic Feed

simplest continuous elevator and occupies the smallest floor space in a warehouse. However, it is more limited as to the range of sizes of packages, as well as in its loading and discharge features, than either the push-bar or the apron elevator.

The illustration shows the use of belt instead of chain as a propelling feature. Such use has been limited to fairly light packages because of the hard pull on the fabric of the belt at the heel of the cantilever arm. This strain is less in the inclined types than in the strictly vertical elevators. Both top and side guards are occasionally used on elevators of this type. The top guards, held in position at the bottom by springs, help to more securely "fix" any bag that has been improperly loaded. Various kinds of loading devices have been developed, each designed to suit a certain type of package. While barrels or kegs will roll onto the arms from skids or power feeders, bags are usually "dumped" by a tripper device which synchronizes with the travel of the arms. For this service speeds of from 40 ft. to 60 ft. per min. are usual.

Chemicals—Oils—Drugs Barrels—Drums—Kegs

The handling of heavy barrels and drums presents a discharge problem which is better solved by self-dumping arms than by the top-discharge type of arm elevator. With the

low speeds at which these heavy-duty machines are run, the barrels are picked up and deposited carefully on the unloading skids above, all with a minimum of rough handling. Equipped with the double arms shown, the elevator lowers packages on the down-side simultaneously with elevating on the up-side. The elevating of empty barrels from cars to cooper shops on upper floors, from which they are later lowered for filling, is a successful example of this two-way handling. In bottling, and other filling plants, the arm elevator offers the simplest and most logical means of taking the barrels to the filling floors.

The self-dumping arm type represents the highest development of the arm elevator. These arms are operated by a tripper which strikes a lever set at the point of discharge. This automatic feature has made a much wider field for the machine, mainly in that it makes it feasible to discharge its load at any floor. The arm should dump in a positive way, throwing its load entirely clear of the arms. This is not so satisfactorily done with loose bags and simi-

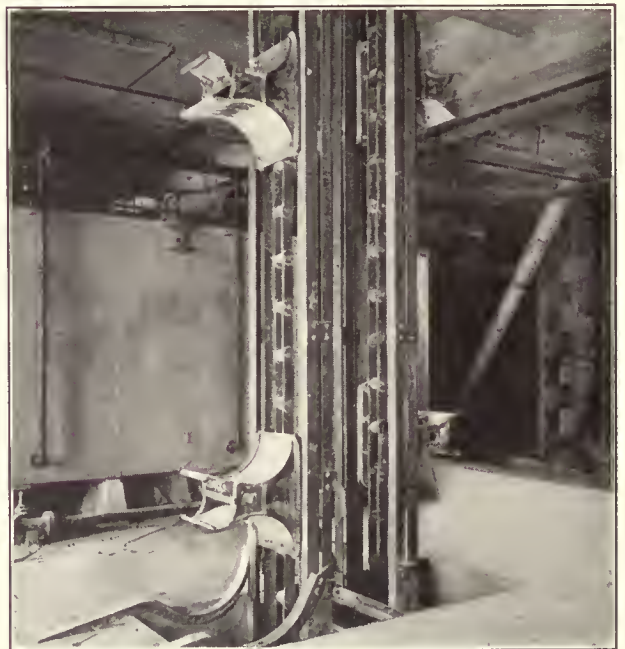

Self-dumping Arms Discharge at Any Floor

lar packages as it is with solid objects. When the arm is propelled by a single strand of chain, as shown, more care must be taken to insure proper guiding of the arm than is necessary with the double strand. The single strand chain, however, is not an objectional feature, when installed, since proper guiding of the arm may be secured by various comparatively simple means, particularly with the steel frames and wide heavy chains used.

Suspended Tray Elevators

The growing demand for automatic, continuous handling of packed materials in manufacturing and storage operations has brought about the present high development of the suspended tray elevator. The chief advantages of this machine lie in its automatic transfer from and to gravity and power conveyors, the manner in which it handles its loads, its usefulness as a lowerer, and the fact that it is well adapted to multi-story buildings.

Because the suspended trays or carriers of this elevator are freely pivoted at their points of attachment to the chain, they maintain their horizontal position in passing over the top, to the discharge stations on the down-side. For this reason the suspended tray elevator is better adapted than either the arm, push-bar, or inclined apron elevators to the handling of packages which must be carried in a level position.

The gentle lifting of the loads from the fingers of the loading stations, the smooth travel of the trays, and the equally careful delivery to the discharge station make it especially satisfactory for fragile packages or for containers whose contents are easily disarranged. While many push-bar and inclined apron elevators handle their loads with practically the same care, they occupy considerably more floor space and are not so well adapted to multi-story buildings as the suspended tray type. The arm elevator occupies about the same floor space but, even with its self-dumping arm and automatic loading features, it will not properly carry and discharge many packages, such as cases of bottles, high cans, barrels on end, and similar objects, for which the suspended tray is well fitted. Nor is it so automatic in its transfer from and to other continuous carriers in conveying and elevating systems.

As a lowerer this machine not only handles its loads with greater care and accuracy than any other vertical, or nearly vertical, lowerer, but it possesses the advantage that lowering can be done on the descending side at the same time that packages are being elevated on the opposite side. In operating as a lowerer only, the weight of the load is depended upon to propel the machine, an automatic brake or governor being used to control the speed. Even for this work, however, it is usually better to equip the machine with at least a small motor, which, in effect, makes it an elevator as well as lowerer. Occasionally the simplest types of lowerers are equipped with foot brakes, in which case the speed is controlled by the operator. However these intermittent lowerers, mainly because of the time required to operate, are seldom applicable to modern industrial or freight handling needs.

As a unit of complete conveying and elevating systems the suspended tray elevator, because of its automatic loading and discharge features, increases the efficiency and broadens the field of continuous handling. Packages of a fragile nature, as well as trays and tote-boxes whose contents would be injured by rough handling, are carried safely and automatically to points not only many floors above or below, but to distant departments in the same or different buildings. The most common position of this elevator in such systems is receiving from, and discharging to, lines of gravity conveyor. In this combination it serves either as a floor-to-floor elevator and lowerer between lines of gravity on the upper and lower floors, or as a booster to provide additional trade for a long line of conveyors on one floor.

Where conveying as well as elevating is to be done, and it is not convenient to have the elevator transfer from or to other conveyor machines of the suspended tray type are sometimes built as a combination elevator and conveyor, a horizontal run being added to the usual vertical section. This horizontal portion is suspended close under the ceiling, or in other out-of-the-way places.

The fact that the suspended tray elevator will return empty containers on one side, at the same time that it is carrying the filled containers on the opposite side, makes it particularly valuable in plants where it is necessary to handle filled and empty boxes or baskets in opposite directions. This two-way capacity has caused this elevator to be extensively applied to the handling of packages in department stores, textile plants, wholesale supply and distribution houses, and many other plants in which gathering boxes, baskets, or tote-boxes are much used. By filling these boxes at storage piles or machines, and placing the entire box with its contents on the elevator, the time of loading and unloading of the individual packages is saved. For the similar purpose of eliminating this loading

and unloading of miscellaneous freight packages, a few machines have been built to carry four-wheel hand trucks, with limited loads. The two-way capacity of this elevator is equally valuable in freight and storage buildings where there is a continuous movement of individual packages in the two directions at the same time. Where the stock or storage rooms are on upper floors, this machine forms the most direct path not only from incoming cars to storage piles, but from storage to shipping platforms in loading out.

Like the arm elevator, the suspended tray elevator is not adaptable to the handling of a very wide range of packages on the one machine, because of the difficulty of providing automatic loading and discharge stations which will fit equally well the different sizes and weights of objects. However, the use of gathering boxes or other containers will frequently overcome this objection, particularly in the handling of the smaller commodities. This efficient handling method is fast increasing with greater knowledge of its possibilities and the better organization of production and storage operations.

A few small portable elevators have been built mainly for piling and stacking. The chief objection to these machines for such purpose has been that, in their present development, they are rather heavy and clumsy and the heights of loading are higher above the floor than with the inclined pilers, requiring more manual lifting of the package.

The suspended tray elevator consists of a series of pivoted suspended trays attached to two strands of endless chain or cable running over top and bottom sprockets or sheaves. Because the trays or cars are freely pivoted at their points of attachment to the chain, the weight of the load, which is always well below these suspension points, holds the tray in a level position as it passes over the head sprockets. As the tray travels upward, its projecting fingers pick up the load, which has been momentarily resting on the loading arms, carry it over the top, and deliver it at the desired floor on the down-side to discharge fingers or stations which intercept the package as the tray passes through. From these fingers the package slides or rolls, or is otherwise removed before the next tray with its load reaches the station. In the more highly developed types of machines lowering is accomplished in a similar manner, all loads passing over the top. In the simple types of gravity lowerers, however, both loading and discharge are done by hand on the down-side.

Suspended tray elevator-lowerers may for convenience be considered as belonging to two general classes; the simple swing-tray machine with solid or specially constructed trays, which are both loaded and unloaded wholly or partly by hand; and the highly developed automatic load and discharge machine. The basic principle of both types is the same, and they merge very closely into one another in their construction.

General Specifications

Frame. For the more simple elevators of this type wood frames are often used. However, for reasons of better bracing and general permanence, the continuous frame of steel angles or channels, forming guides for the chain and trays, gives more satisfactory service. The weight of the loaded elevator is carried by this frame either to the floor or to any one, or all, of the various floors by properly attaching at these points. In any case, care should be taken to guard against mis-alignment due to settling of the building. No elevator is more dependent than this type on the stiffness and permanent alignment of the frame, particularly

when its operation is designed to be completely automatic.

Tray Guides. Many elevators, particularly those of lower height and with balanced trays, have been built and successfully operated without guides for the trays. In most cases, however, the natural tendency of the trays to swing makes the use of guides essential to the travel of the tray in a set path. These guides, whether on wood or steel frames, should be of steel securely and accurately set to insure smooth travel of the chain and tray. This is especially important where the tray enters or leaves the guides in passing over the top and bottom terminals. Where the frame is of steel, the structural members, with simple additions, form very convenient chain and tray guides, making a simple and satisfactory construction.

Trays. The simplest and most generally satisfactory finger tray is the steel or malleable-iron, centrally-hung type, consisting of a center bar with fingers or arms so arranged as to pass through the fingers of the loading and discharge stations. Such a tray may be left free to swing, or it may be so arranged that both the point of suspension and the tray platform itself run in the guides. Various modifications of this balanced type are in use, each designed to carry a different type or shape of package. Where it is desirable to discharge to the side of, or at right angles with, the direction of loading—instead of straight ahead—and for other special conditions, both the corner-hung tray and the cantilever arm are used. These are not so generally satisfactory in operation as the centrally-hung type, although the corner-hung tray has less tendency to swing because of its suspension from offset chains.

The unbalanced cantilever tray does not, in general, travel so smoothly or steadily as either of the other types and requires special guides. Solid wood trays, as well as steel trays of special design, are often used to carry special packages or miscellaneous parcels. These solid or special trays are usually loaded by hand, except where the packages are of uniform size and overhang the bottom of the tray. The points of attachment of the tray to the chains should be secure with any type tray, but should leave the tray so freely pivoted that it will maintain its level position without jerking, particularly in passing over the top terminal.

To insure continuous and uninterrupted traffic in both directions, trays should often be made of double width, one side of the tray being used for elevating and the other for lowering. Thus, when an ascending tray, one side of which is loaded, passes a loading station, there is sufficient space on the tray for loading another package which is to be passed over the top and lowered."

Chain. Both malleable and steel chain of the standard types are common, the size depending entirely upon the weight of the packages to be handled and the height of the elevator. Chains of long pitch are more applicable to elevators with large sprocket wheels than to those in which small sprockets are used. Two strands of chain are invariably used, except in one or two special types of elevators which have been designed for single strands, in which case heavier and stiffer chain should be used. Occasionally a cable takes the place of the chain, a construction, however, which is more common in machines devoted to lowering rather than to elevating. With either cable or chain the attachment of the trays should be thoroughly secure, yet so pivoted that the tray is free to keep its level position. Secure attachment is more difficult with cable than with chain and the operation of the cable in passing over the end sheaves is not so positive as with chain.

Loading Stations. For hand-loading alone, particularly of solid and special trays, the loading stations are often omitted and the packages are placed on the ascending tray

by hand. With the simpler gravity lowerers, which are loaded on the descending side, hand loading is also usual. With finger-trays, however, loading fingers, from which the load is picked up by the tray are usual, and for heavy packages practically essential. In this case the loading is done on the ascending side, whether in elevating or in lowering packages. Unless the trays are extremely closely spaced the loading grid has the advantage of saving the time of waiting for the tray to come within loading reach. All of these loading grids should be so hinged, or otherwise easily adjustable, that all but the one being used may be thrown out of the path of the loaded trays.

Where loading is to be done from gravity, or other conveyor an automatic feeding device should be provided. This should be so timed with the movement of the trays that it will feed the packages from the conveyor to the loading fingers one at a time and just before the tray reaches the station. Such a device must not only be positive in its action, but so simple in design that it is not easily put out of adjustment. Ball bearing rollers on the loading fingers aid such firm packages as boxes in taking their place promptly on the loading station.

Discharge. Although the solid tray is sometimes unloaded by hand, it is more convenient to have it dump its load at the required floor, usually on the down-side. This operation is not so positive, except with certain special packages, as the action of the finger tray, which, in passing through the sloping fingers of the discharge station, leaves its load at the desired floor. From these fingers, which slope outward and are often equipped with ball bearing rollers, the package slides or rolls off before the next tray reaches the station.

Mechanical devices for pushing the load from the station are occasionally used to insure more positive discharge of certain sluggish packages. In either case the discharge must be smooth, yet positive and prompt, in the handling of every package. Frequently power conveyor sections are provided to carry away the discharged load and prevent packages piling up at the discharge point. A common method of discharge in handling such packages as boxes is to gravity conveyor, the discharge fingers being equipped with rollers to insure prompt movement. As in the loading station, the discharge grids should be easily adjustable, preferably hinged, and controlled from convenient points, either locally or from other floors, by means of cables and levers at the points of dispatch.

Drive. Single top and bottom sprockets for each strand of chain are usual, although two top and bottom sprockets for each strand are often used, making a short horizontal run at each terminal. With the latter design much smaller sprockets are required, but these are not adaptable to the heavier chains with long pitch. The head sprockets are usually placed on stud shafts to afford clear passage of the suspended tray between them, although this is not always essential if the sprocket is designed large enough and the height of the tray is not too great to insure proper clearance. Where cable is used in place of chain, sheaves are customary, usually with recesses for lugs on the cable. Such a construction is more common in lowerers than in elevators, and in general is not so satisfactory as chain and sprockets.

Either spur or worm gears, direct connected or belted to the motor are satisfactory for driving. The worm gear forms its own safety brake in case of accidental cut-off of the power, and is well adapted to the slow speeds at which these machines are usually run. The drive is almost invariably from the top, with the bottom sprockets set in adjustable take-ups. Because of the free-running move-

ment of the chain and better balance, in contradistinction to the dragging or rolling effect of the inclined apron or push-bar elevator chains, the power required by the suspended tray elevator is smaller in proportion to its height than with either of these two.

Brakes. Both foot and automatic brakes or governors, preferably the latter, are provided to control the speed on many types of gravity lowerers. With either device the control should be so positive as to keep the speed constant, regardless of the total weight on the trays. Whether such machines are to serve as elevators or not, small motors are desirable to produce more positive action, particularly in handling very light packages. Obviously the addition of the motor increases the usefulness of the lowerer, wherever there is any likelihood of its being used, even occasionally, for elevating.

Speed and Capacity. Chain speeds of from 30 ft. per min. for handling heavy or particularly fragile packages to 70 ft. per min. for the lighter loads are good practice. The capacity depends mainly on the spacing of the trays, which is usually from 5 ft. to 15 ft. apart. With trays spaced at the usual minimum distance of 5 ft. apart, and a chain speed of 50 ft. per min., the capacity of the elevator is 10 packages per minute. The spacing of the trays should not be closer than the practicable speed at which packages can be fed to the elevator, which, with light packages, is about one every five seconds. With such light packages the elevator can usually be loaded faster by hand than by automatic feeder alone.

Safety Devices. An essential feature of each unloading station is some simple type of automatic detector, such as a swinging arm, which will stop the machine if any package fails to leave the discharge station promptly. Such device should preferably be electric, as should any others which may be occasionally desirable at other points on the machine.

Similar electric detectors are often used at loading stations to automatically stop the motor if the package fails to seat itself properly on the tray.

Control. While these elevators are usually equipped to run continuously, it is advisable to provide simple push-button or other control devices by which the elevator may be started or stopped from convenient points on the different floors. A cable running the full height of the machine is frequently used, particularly with gravity lowerers. Speaking tubes, or signal bells increase the efficiency particularly of the higher elevators because of the better co-operation in handling on the various floors.

Operation

While the more highly developed types of suspended tray elevators are wholly automatic in their operation, no one machine will serve as a "carry-all," nor will it properly handle packages of a size or character outside of the range for which it is designed. Disregard of this limitation has probably caused more operating trouble than any other single feature. This is particularly true in storage and freight handling operations, where there is a natural tendency to use the machine for a wide range of miscellaneous packages.

Where it is necessary to handle a widely differing range of packages on the same elevator, the use of containers or gathering boxes will often overcome this limitation, the empty containers being returned on the opposite side of the machine. Another important point in successful operation is proper care of feeding devices where the elevator re-

ceives from other conveyors. These selective loading devices, while not requiring constant attention, should at least have regular care in oiling and adjustment. A similar caution applies to the systematic care of detectors at discharge points, or other safety devices which may be desirable.

The closest co-operation should obtain between the various floors, particularly where such elevators are used simultaneously in both directions. Speaking tubes or signal bells between points of dispatch and discharge simplify the operation, especially in changing the positions of loading and unloading stations. An interesting fact in the history of the operation of these machines is that they have been more universally successful in industrial plants than in storage or warehousing. This is largely accounted for not because they are any less applicable to the latter purpose, but by the fact that in the manufacturing plant the elevator receives more regular mechanical attention in upkeep and adjustment.

Storage—Warehousing

Boxes

The high development of automatic transfer mechanism by which packages, at the loading point, pass automatically from gravity conveyor to the suspended tray elevator, and then from the elevator to lines of gravity conveyor at the discharge point above, has greatly increased the efficiency of continuous conveying and elevating of commodities. By means of the various selective devices in use, the packages are fed one at a time from the conveyor to the loading



Selective Devices Aid in Loading

fingers of the elevator. From these fingers the individual package is picked up by the fingers of the ascending tray as it passes through, is carried over the top and delivered gently to any floor above.

For storage and warehouse service the two-way feature of the suspended tray elevator is particularly valuable in meeting the necessity of elevating and lowering commodities at the same time. With speaking tubes, bells, or other floor to floor signals, freight handling operations in multi-story buildings are not only speeded up, but better organ-

ization results from the elimination of the delays and unnecessary moving about between floors incident to platform lifts.

While the cantilever trays permit the side discharge of loads at the delivery point, they are not otherwise as satisfactory as the more stable centrally-hung trays. The design and adjustment of the selective feeding device in automatic elevators is an important feature of the machine, for no such elevator is any better than its feeder. This device should be so connected with the elevator that its operation is timed to deliver boxes singly to the loading station just before the tray reaches that point. For such packages as will travel on gravity conveyor, rollers on the loading fingers insure the prompt movement of the package to its loading position.

The photograph shows a simple construction of the frame, with the frame angles forming two sides of the guide channel. For very large packages the use of several small terminal sprockets avoids the necessity for the very large single sprocket which would otherwise be required to sufficiently separate the ascending and descending trays.

Wholesale Houses

Miscellaneous Packages

While the automatic loading of miscellaneous packages is more difficult than with objects of uniform size, the automatic discharge of such packages is relatively simple. The short apron conveyor shown simplifies the operation by promptly removing even the smallest or most sluggish packages before the next tray reaches the unloading fingers. With such an arrangement a considerable pile of packages may be allowed to collect without blocking the elevator, and much less regular attention is required at the discharge point. A long sloping chute serves this purpose almost as well as the short conveyor, although it has not the tem-



Handling Miscellaneous Packages

porary storage capacity that a longer gravity or power conveyor would provide.

The use of the gathering box or basket is of decided advantage in wholesale grocery and other supply house service where a wide range of packages is necessarily handled. In receiving incoming goods or in shipping out from storage or stock rooms, if the various small articles are collected in these baskets at the storage piles, and then the basket or box with its contents is placed on the elevator, the time of

loading and unloading the individual packages is eliminated. The empty containers are later returned on the opposite side of the same elevator. The use of these baskets makes it practical to handle the smallest or most irregular packages. Where it is economical to use larger containers than the one shown, it is usually advisable to move the containers about the stockroom floor on low platform trucks.

For this service centrally-hung trays are usual, although where side discharge is desired, or for other special reasons, both the cantilever tray and the corner-hung type are used. Whether used as a feeder or discharge conveyor the short power section shown should be given the proper speed to work best with the speed and spacing of the trays. Such conveyors may be driven either independently or from the elevator. Speeds of from 50 ft. to 70 ft. per min. are usual with a tray spacing of 6 ft. to 12 ft.

Confectionery—Baking—Chocolate

Barrels—Bags—Boxes

In lowering packages the suspended tray type handles its loads more carefully than any other continuous motion lowerer. It may be designed to operate entirely by gravity,

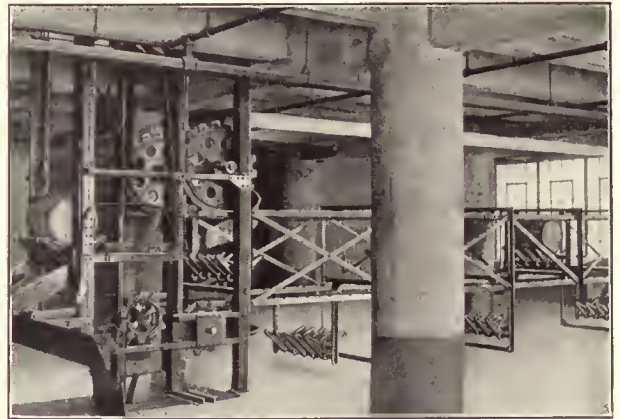

Combination of Conveyor with Elevator

with a mechanical speed governor, or it may be equipped with a motor, in which case it usually serves the double purpose of elevator as well as lowerer. When the motor is used, loading and discharge may both be accomplished automatically, as in the other types of these elevators. The usual method of loading the gravity lowerer, however, is by hand. Some of these machines are intermittent in operation, the weight of the descending load being controlled by a foot brake. Such intermittent machines are far less satisfactory than either the continuous gravity or motor-driven lowerer, and lose much of their economy because of the time required to operate them.

In suspended tray lowerers, particularly those of the gravity type, cables running over top and bottom sheaves are frequently used instead of chains and sprockets. Pockets, or recesses, are provided in the sheaves at intervals, into which the clips supporting the trays fit as they pass over the top. While satisfactory for certain purposes, this cable construction is not so generally efficient as the standard chain and sprocket construction commonly used. Careful attention should be given, in design, to preventing the slip of the cable on the sheave, or of the tray attachments to the cable, particularly with heavy loads. These features are obviously not so positive as with the standard chains. The

motion of the gravity lowerer may be controlled from any floor by a cable running the full height of the machine and connected to the speed governor or brake.

Dairies—Ice Cream

Cans—Cases of Bottles

One of the most interesting and economical applications of the suspended tray elevator is in the elevating of cans of milk from receiving platforms to cold storage rooms on upper floors. Likewise cases of empty bottles are similarly elevated to temporary storage or washing rooms. The level position maintained by the carrying tray makes it particularly adaptable in handling such high and unstable, or easily disarranged, packages. Where space is not available inside the dairy, these elevators are often attached to the outside wall of the building. In such installations the frame of the machine carries the light housing necessary. If desired, the empty cans or cases may be lowered on the opposite side of the same elevator.

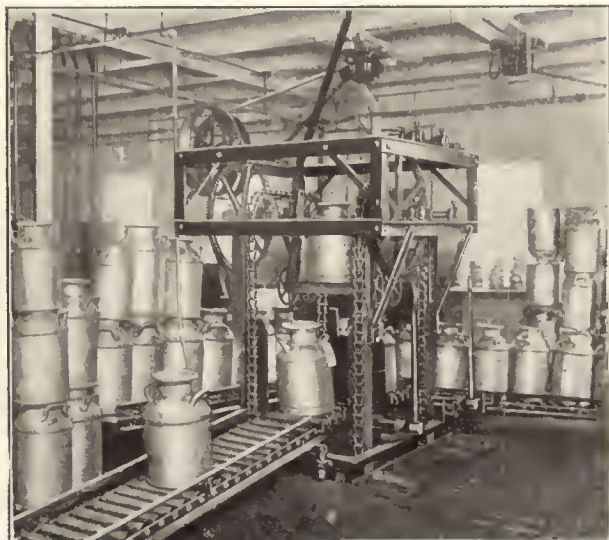

Elevator Discharging to Gravity Roller

Although wholly automatic loading of objects such as cans, with a high center of gravity, is difficult, it may be made thoroughly feasible. However, manual loading is customary for such objects, the load being placed on the loading grid by hand.

Bottling—Soft Drinks

Cases—Trays—Cans

Because of the unusually small floor space occupied by the single strand elevator, as well as its somewhat simpler construction, it is sometimes preferable where light packages only are to be handled. Since it is open on three sides this type elevator is also somewhat easier of access than the double strand type. The use of the cantilever tray makes it feasible to load or discharge packages either directly in front or at the side of the tray. Such an elevator-lowerer is well adapted to the uniform packages of creamery and other bottling plants. Cases or trays of bottles are handled on the suspended tray elevator, whether of double or single strand, with greater care and less disarrangement of the contents than on any other continuous machine.

Since the cantilever arm depends so much for its stability on its connection to the chain, this attachment should be made unusually secure. For similar reasons of stability and strength the chain used on such a single strand elevator



Single-strand Cantilever Tray Type

should be heavier and stiffer than would be necessary for the double strand type. The large roller shown under the tray has a stabilizing effect on the vertical run by bearing against the chain guides. However, as the tray passes over the sprocket this effect is not present, and the eccentric load is thrown on the chain and sprockets. In elevators of this character chain speeds of from 40 ft. to 70 ft. per min. are usual. Steel frames are even more essential than with the double strand type, and the vertical members should obviously be of stiffer section than for the four-corner frame.

Milling—Food Products

Bags

The automatic operation of this elevator makes it fit well into complete elevating and conveying systems for handling bags in the milling and storage of such commodities as grain, flour, sugar, and feeds. The photograph shows the simple arrangement by which the positive transfer of the bags from elevator to conveyor is made at the point of discharge. A somewhat similar, although more difficult, automatic transfer is made from conveyors to the elevator at the loading points. Such a system provides continuous travel of incoming materials between cars on sidings and storage piles on the floors above, eliminating the confusion of trucking and, what is more important, the time of waiting for platform elevators. Similarly as a lowerer, the suspended tray elevator is useful in the outward distribution of the finished commodity to cars or trucks. Properly designed this machine will serve both incoming and outgoing purposes at the same time.

While the tray shown is adapted primarily to the handling of bags or similar packages, it is thoroughly feasible to provide combination trays capable of carrying barrels, boxes, cartons and the various other types of packages

handled in milling. The photograph shows the simplest type of discharge station or grid. As the tray passes through the fingers the bag is intercepted and slides away from the elevator before the next tray reaches the station.

packages, it will be found if they are reasonably light and readily handled, that manual loading and discharge is some-

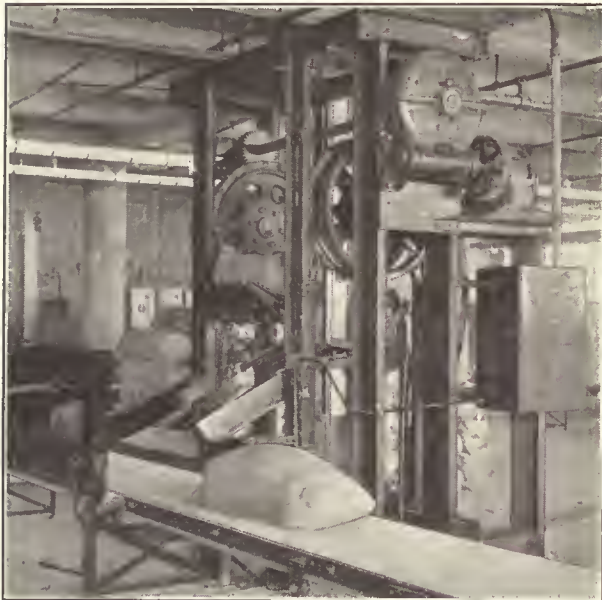

Automatic Transfer to Belt Conveyor

These fingers should be arranged to hinge up, to make clear passage for such loads as are to be carried to floors below. The discharge to the conveyor may be made either straight ahead or at right angles to the elevator. The latter discharge is more difficult, however, except with easily handled packages, such as boxes. The illustration shows a common and satisfactory arrangement of the top or driving terminal, with worm gear drive.

Chemicals—Powder—Drugs

Cans—Barrels—Drums—Carboys

The fact that the trays of this elevator keep their level position in passing over the top sprockets makes the machine adaptable to high packages which cannot be properly handled by any other continuous elevator or lowerer. High cans, barrels on end, and many similar packages, loaded and unloaded sometimes by hand or, more commonly by gravity conveyor, are carried without disarrangement of the contents, or injury to the container itself. One of the most interesting applications is the conveying and elevating of carboys or large bottles, usually in crates. In these industries this machine is also much used for lowering because of the ease with which so many of the containers used must be handled.

With packages of high center of gravity it is particularly important that a well balanced tray should be used, that it should be prevented from swinging in its travel and that its level position should not be disturbed in passing over the top sprockets. Because the high package has a tendency to overturn, the slope of the loading and discharge fingers must obviously be as small as will serve to carry the package into position. Since this results in the package moving onto or away from the elevator slowly, the trays cannot be spaced so closely, nor the speed and capacity be so great, as in elevating more stable loads. With these, and other sluggish

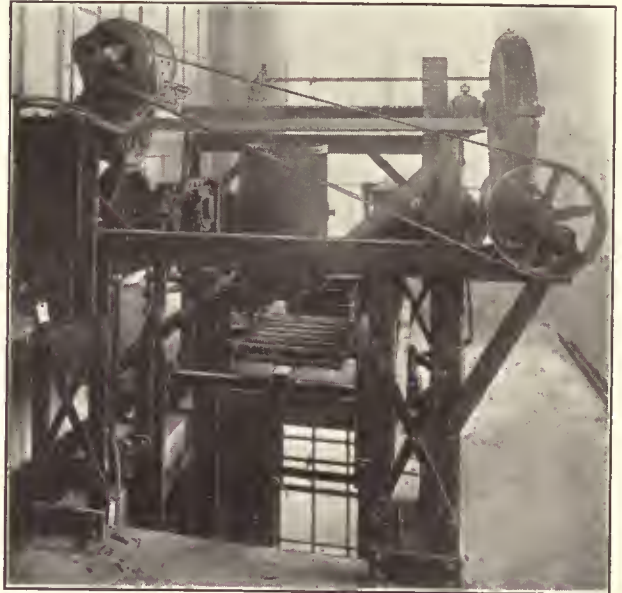

High Cans Are Handled Safely

what faster than automatic operation. For this service chain speeds of from 40 ft. to 50 ft. per min. are usually sufficient, with a tray spacing of from 10 ft. to 15 ft. The photograph shows the use of four small head sprockets, instead of the more common pair of large sprockets.

Bleaching and Washing Plants

Bales—Packing Cases—Tote-Boxes

The necessity of handling heavy bales and packing cases, in textile plants and the small space ordinarily available,

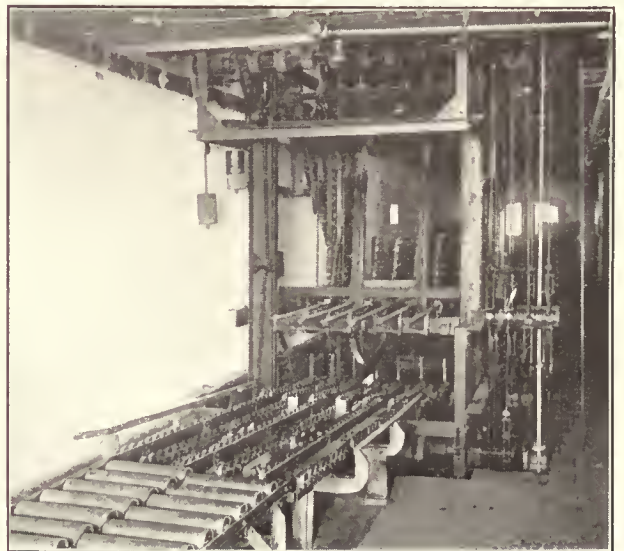

Automatic Feeding from Conveyor

makes the automatic vertical elevator particularly valuable in this industry. Incoming bales of cotton goods, wool, and other materials, as well as outgoing shipping cases, may be

either elevated or lowered on the same machine. While, in such heavy work, these elevators usually operate as individual units, they are frequently combined in systems of gravity and power conveyors, particularly in the receiving or storage of case goods. A maximum of economy results eliminates all manual transfer from and to the other conveyor units. Such a system is equally valuable in the handling of small pieces in tote-boxes or other containers. In this case the empty containers are often returned on the same machine.

The basic principle of all loading devices is a stop so operated as to synchronize with the movement of the ascending tray and to hold all but the one package to be delivered to the loading fingers. In the photograph are shown levers by which the various hinged discharge stations on the floors above or below may be thrown in or out to dispatch packages to the desired floor. For handling the heavier bales and packing cases, slow chain speeds of from 35 ft. to 50 ft. per min. are advisable to relieve the chain and tray of as much as possible of the shock of picking up the loads.

Textiles

Tote-Boxes—Bales—Packing Cases

The photograph shows the top and bottom terminals of two suspended tray elevators which are used for elevating and lowering filled and empty bobbin boxes. The applica-

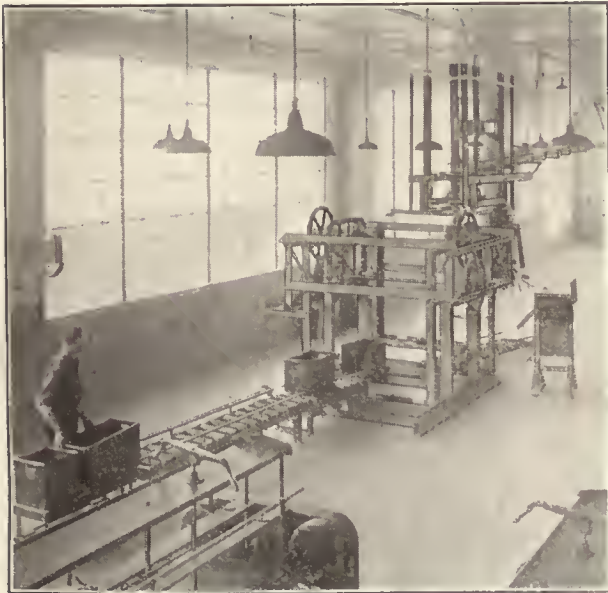

Automatic Loading from Gravity Conveyor

tion of this type elevator to cotton and wool spinning has greatly increased within the past few years because of the successful use of these machines not only in new plants, but in old buildings as well. The small floor space required makes the installation feasible in the most congested plants, and with little disturbance to operation. While the automatic loading and discharge of these elevators makes them extremely economical when working in connection with lines of gravity or belt conveyor on the various floors, they are probably used more in single units than in such extensive systems. The fact that the same elevator will elevate or lower filled baskets of bobbins on one side, and simultaneously return empty containers on the other, increases its

usefulness in departments of the mill where there is necessity of this two-way handling. In other departments similar elevators of heavier construction carry the heaviest bales of cotton, wool, jute and other incoming raw materials, as well as packing cases of finished goods.

Because there is the tendency, with packages following closely behind one another, particularly on gravity conveyor, for more than one package to enter the loading station, it is essential that some selective device be provided to separate the loads and deliver them singly to the loading fingers. The action of this feeder should be positive, yet as simple as possible in its construction. If too sensitive in its adjustment it will require too constant attention. In the elevator shown in the foreground, the top terminal construction is fairly typical of the suspended tray type. In this case most of the load of the entire elevator is carried on the top floor. However, this is not essential. In the background is shown a bottom terminal; suspending it from the ceiling conserves floor space.

Restaurants—Hotels

Trays of Dishes

The necessity for more continuous handling and greater capacity than is possible with the ordinary "dumb waiter," has brought about the efficient use of the suspended tray elevator-lowerer in restaurant and hotel service. Serving the double purpose of elevating and lowering filled and empty trays simultaneously, this machine provides the most direct possible connection between kitchens and dining-room floors in multi-story buildings. The care with which these machines handle such fragile loads as trays of china and glassware is another reason for their successful application to this work. Much confusion as well as time in operating dumb waiters, even though they be power-driven, is eliminated by the continuous motion of the suspended trays. The operation of such machines is practically noiseless, particularly when they are enclosed in the usual shafts.

The corner-hung type tray has given excellent service for this work, because of its smoothness of travel and freedom from any tendency to swing. Where these machines

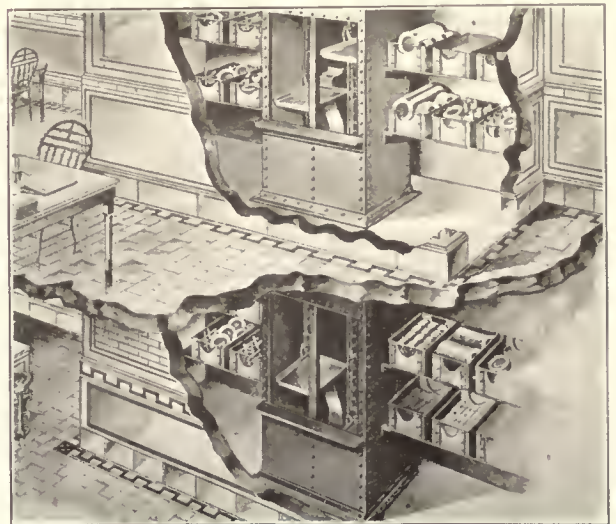

Quick Service Promoted by Elevator

are to be loaded and unloaded by hand, their speed should be very low, preferably not over 40 ft. per min. Even with

speeds as low as 30 ft. per min. the trays may be spaced closely enough to give a very large capacity. Obviously the frames of the machines should be so carefully designed and braced that there can be no chance of misalignment. Because of the very fragile nature of the packages being handled, the adjustment of the various parts should be given regular attention, to insure the smoothest action at all times. Specially designed trays are sometimes used in which automatic unloading is feasible.

Wrapping and Packing to Storage— Boosting

Cartons—Boxes

The use of the suspended tray elevator as a booster, to provide additional head for a gravity conveyor, makes it feasible to handle many packages and containers which

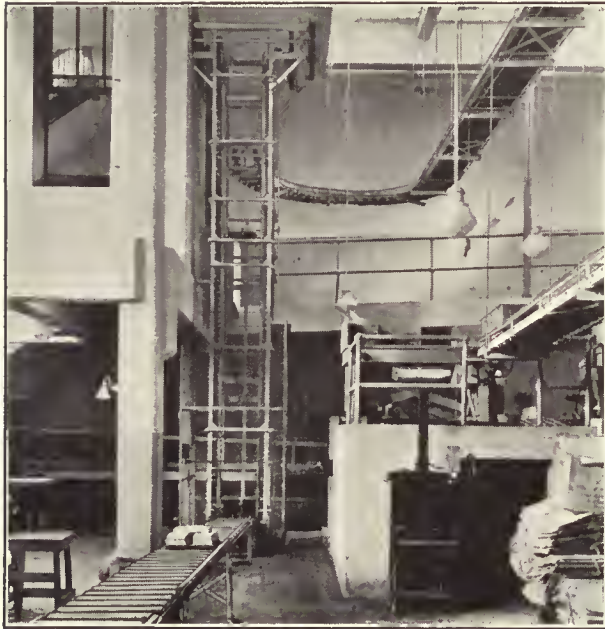

The Elevator Acts as a Booster

could not otherwise be safely handled by this simple, continuous method. The pallets with their load are lifted gently from the gravity conveyor at the bottom, carried smoothly over the top, and removed by the fingers of the discharge station to gravity lines above. Since the pallet is carried in a level position its contents are not disarranged and it is possible to handle the most fragile packages safely. The illustration shows the simple construction and small space required by this vertical elevator. Because of these advantages, these machines are often placed in old elevator shafts, or are even attached to the outside walls of manufacturing and storage buildings.

As a booster the elevator is usually provided with only one loading and one discharge station, the empty pallets or containers being returned by another line of conveyor. The most satisfactory method of discharge is as shown, with the direction of travel of the packages continued the same as in loading. Side discharge at the top is thoroughly practicable, but cantilever, or other special trays are necessary. Where containers with easily disarranged contents are loaded from gravity conveyor care should be taken that the container is delivered smoothly and without shock to the load-

ing fingers. A cushion bumper is often used with excellent results.

Publishing—Paper

Bundles of Papers—Stereotype Plates

The suspended tray principle of continuous elevating and lowering has been carried to a very high point of development in the publishing industry. Many special types of suspended tray elevators are in use in the handling of bundles of papers, all designed to carry the loads with the least disarrangement of the package or injury to the papers. Some of the most successful of these machines in paper handling have been very heavy elevators used for elevating and lowering rolls of paper, often weighing as much as 2,000 lb. The stereotype plate elevator is another publishing house application which demonstrates the flexibility of the freely-suspended tray in handling specially shaped objects.

For handling such special packages it is essential that the trays be designed to suit the package. Discharge stations should be similarly fitted with positive means of removing the load. The small unloading conveyor shown accomplishes this in a simple, direct manner. The corner-hung type of tray illustrated has a stable travel, because of

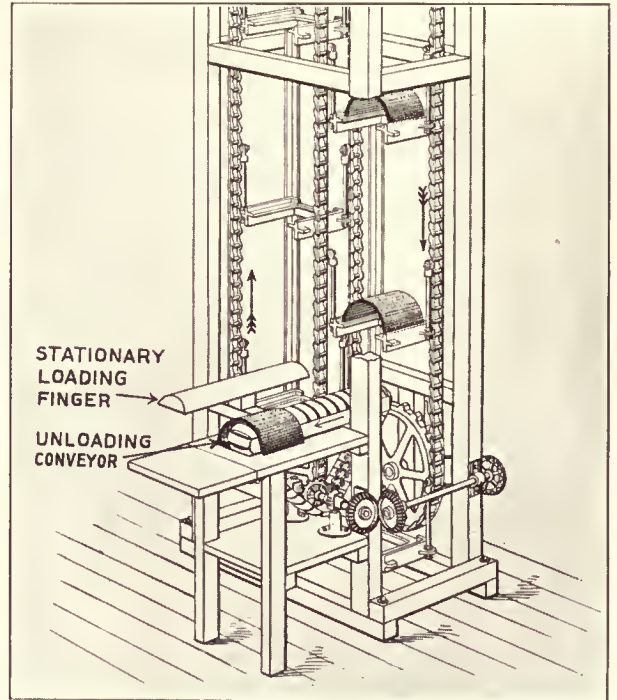

Direct Service Between Plate and Press Room

the offset position of the head sprocket and the chains. Even though the platform of the tray does not run in guides, its diagonal points of suspension prevent it from swinging. Obviously the operation of these specially designed elevators is possible only where the objects to be handled are of uniform size.

Refining—Oils—Greases—Bottling Barrels—Drums—Kegs

The development of the suspended tray type as a combination elevator and conveyor has produced a simple machine for this double purpose. The advantage of keeping

the load on the tray continuously, from the point of dispatch to final destination, makes this a better handling method under some conditions than the more common one of delivering to another conveyor at the top. Such systems have been much used in textile and other industries, as well as in bottling and refining. While modern tendency is toward the use of separate units for the conveying elements of these combination systems, there are many conditions of plant layout where it is more economical to use the one continuous machine.

The fact that the trays of this elevator travel horizontally makes this a useful machine in congested manufacturing plants where offsets from the vertical are necessary to avoid machines or other obstructions on the different floors. The photograph shows the simple transfer from the vertical to the horizontal run, the returning chain, in this case, traveling by a different route. Roller chain is preferable for this service because it provides easier travel of the chain along the horizontal supporting angles. In this corner turn a, through shaft is used between the two sprockets, in place of the stud shafts ordinarily employed, and the sprockets are made large enough to insure the clearance of the lowest point of the tray as it passes over this shaft. The cradle-shaped tray shown makes a very safe carrier for barrels. Speeds of from 40 ft. to 60 ft. per min. are usual.

In the illustration shown the distance between centers of the trays is comparatively long. In spacing the trays the

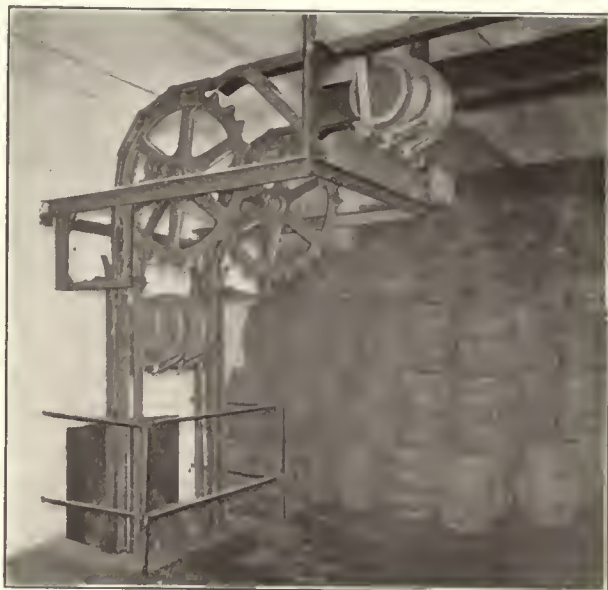

Changing from Vertical to Horizontal Direction

weight of the load to be carried, the section of the material forming the horizontal run and the distance between its supports must all be taken into consideration.

Push-Bar Elevators and Conveyors

One of the earliest types of continuous motion elevators and conveyors consisted of a block of wood attached to a single strand of plain chain running over end sprockets. On this principle of pushing or dragging the package have been developed the various types of push-bar elevators and conveyors, including the modern double-strand roller-chain type, with automatic loading and discharge features.

The chief advantages of this type of equipment lie in its simplicity of operation and low first cost, as well as its ease of automatic loading. While the push-bar is particularly suited to handling a fairly uniform range of packages, practically any object of sufficient solidity and shape to slide on the runway can be successfully and economically handled. It is extensively used in manufacturing processes, and in such industries as bottling, packing, canning, confectionery, textiles, and ice has become almost indispensable. Because of the excessive friction of heavy packages, this equipment is most satisfactory for light service. Where it is necessary to handle heavy objects a runway bed of steel or wood rollers facilitates their travel and reduces the drag on the machine. The push-bar is not well adapted to handling bags, loose bundles, or such unsymmetrical packages. While the same principle is used in each, a clear-cut distinction should be made between the modern highly developed push-bar types and the many simple types of drag elevators and conveyors in common use.

As an elevator the double-strand push-bar type gives the maximum economy of space over any of the other inclined elevators, because the high position of the push-bar above the runway bed permits packages to be elevated at angles as great as 60 deg. or 75 deg. with the horizontal. As a booster for long lines of gravity roller conveyor, this machine has greatly broadened the field of the latter type of equipment. For this purpose it is

often made portable. The automatic load and discharge features add materially to the savings in labor effected by such elevators. Because of the difficulty of loading downward, the push-bar elevator is not well adapted to the lowering of packages, although occasionally used for that purpose.

The simple types of drag elevators are very little used except for handling hay, ice, logs and a few other similar commodities at low inclines.

As a conveyor the push-bar type is readily reversible in direction of travel, thus serving a two-way purpose. Because of the light weight of the moving parts, it is particularly adapted to long distance hauling. This is especially true where the load is not heavy, and the friction developed by the sliding or rolling of the packages on the runway is not excessive. The conveying of ice, empty boxes, baled hay, logs, and pulpwood, is typical of the service to which this conveyor is best fitted. The simple drag conveyor is used more for such conveying than the high type push-bar. It is common in such work to combine conveying and elevating within the one machine.

General Specifications

Frame. In the simpler, drag-type elevators and conveyors wood frames are customary, consisting of well-braced side timbers, to which are attached the cross saddles carrying the runway bed. For the high push-bar types the side frames should preferably be steel trusses, with the top and bottom truss chords. Such steel frames, properly braced, are stiffer and more generally satisfactory, and are usually simpler to erect.

The frames of portable elevators, or boosters, should be unusually well-braced to withstand the twisting and racking of the frame in moving the machine from place

to place. At the same time special care should be taken to make the entire machine as light as is consistent with the loads to be carried. The base frame should be mounted on the best quality ball or roller bearing casters, or wheels, for the efficiency of portable elevators depends to a surprising degree on the ease of movement of these casters or wheels.

Curves or Goose-Necks. For push-bar elevators, curves or goose-necks at bottom and top facilitate loading and discharge. These curves should be of sufficient radius, usually from 4 ft. to 6 ft., to insure smooth travel of the longest packages to be handled.

Runway Bed. For wood frame machines, plain boards, wood strips, or plain or corrugated steel, form satisfactory runways. The drag chain should run in a smooth track below the sliding surface of the runway, with only the cleat, spur or push-bar extending above the surface. For high type push-bar elevators with steel frames, runways of plain or corrugated sheet steel or steel strips are usual, smoothly curved and fitted to the up or down curves, and free from rivet heads or other obstructions to the smooth sliding of packages. For handling heavier packages, steel or wood rollers in the straight part of runway beds decrease somewhat the driving power required by reducing the friction between package and runway. For conveying logs, pulp-wood and similar objects, V-shaped runways with single strands of chain are customary. These runways are often lined with sheet steel.

Chain or Cable. Plain chains of standard or special design are usual for drag-type elevators and conveyors. One strand will serve, although two strands are preferable where flat runways are used. Cable is sometimes used in place of chain, particularly in the handling of logs. For the high push-bar type, however, roller chain is recommended, although plain chain will give good service if the guide tracks are kept well greased. For this type two strands are essential.

Push-Bars. Steel or wood flights, attached to single or double strands of chain and extending high enough above the runway bed properly to drag the package, are satisfactory for drag type elevators or conveyors. High type push-bars, whether fixed or revolving, should run from 3 in. to 8 in. above the runway. In elevators this height depends upon the angle of incline and the height necessary to keep the package firmly against the runway bed. The revolving bar facilitates automatic loading by rolling out from under any package which it has not properly picked up. This is of special advantage in elevators, to insure that each package before starting up the incline has a push-bar squarely behind it. If one chain runs ahead of the other, carrying the push-bars at any appreciable deviation from a right angle to the direction of travel, packages are apt to be forced against the side guards and will not travel or discharge properly. The spacing of the push-bars depends on the speed of chain and the capacity desired, 4 ft. to 6 ft. apart being usual.

Loading and Discharge. Drag elevators and conveyors are usually loaded by hand. Properly designed high-type push-bars, however, because of their selective principle, pick up each package separately. Revolving feed drums and automatic loading devices on elevators also aid in properly transferring the packages from gravity or other conveyor to the elevator. Packages may be semi-automatically loaded at any point on either elevators or conveyors by the use of loading chutes. Discharge points should be so arranged that the packages leave the runway promptly and do not block the moving

push-bars. The usual top-discharge high-type push-bar elevators are often built to discharge through adjustable openings in the runway bed. In such cases the returning push-bars should not run back close under the elevator unless they are spaced far enough apart to amply clear the packages passing through the runway. To avoid possible interference, the chain may be returned overhead.

Drive and Take-Up. Single or double spur gear reductions are usual, belted or direct-connected to the motor. Worm and internal reduction gears and friction drives are occasionally used. Chain take-ups are almost invariably placed at the loading end of the machine. If the machine is fed by gravity conveyor, as is usual, the end of the section of gravity adjoining the loading point should move with the take-up to avoid disturbance of the loading device. Take-ups should be easy of adjustment, but must hold their position when set.

Control. It is often advisable to provide simple electric or other control devices at convenient places to facilitate starting and stopping of the machine.

Stops. Safety stops are occasionally used as brakes on elevators, particularly those of higher angles of incline, to prevent the elevator running backward when the driving power is accidentally cut off.

Capacity. Capacity depends on the spacing of the push-bars and the speed at which the machine is run. With the light packages usually handled, practicable capacities vary from 500 to 1,200 packages per hour, with 60 ft. to 90 ft. per min. chain speeds.

Operation

While the high-type push-bar elevators and conveyors are essentially high capacity machines, often handling over a thousand packages per hour, for the heavier loads they should be run at the lowest speed that will give the required capacity, preferably not over 75 ft. per min. The chain should be kept reasonably tight by setting up the take-ups at regular intervals after the machine is first put into operation. Chain guides must be kept well greased and free from dirt. Where roller chain is used the rollers should be oiled occasionally, as should the rollers in the runway bed if used.

Automatic loading devices are particularly dependent upon being kept in good working order. The same caution applies to the adjustment of intermediate loading and discharge points. Even with properly designed feeding mechanism, over-crowding at the start is to be avoided so far as possible. Where simple swing-arm, or similar control devices are used automatically to stop the machine when packages do not leave the discharge points promptly, these devices should have regular attention. Since these machines are best adapted to limited sizes, weights, and types of packages, care should be taken not to apply them to the handling of miscellaneous freight, unless specially designed for such duty.

Boosters

Miscellaneous Packages

As boosters push-bar elevators greatly extend the scope of usefulness of the gravity conveyor by making possible longer runs through the "boosting" given the packages at any desired point. The short elevators necessary for this work are made so light as to be practically as portable when mounted on casters as the sections of gravity rollers with which they work. The ease with which they automatically receive from, and discharge to, other conveyors

is a big factor in the labor saving they accomplish. Such portable boosters apply mainly in warehousing, storage, car-loading, and similar operations. As truck and car-loaders they save the time of the men who usually do the "passing up" of packages from the end of the conveyor to the man in the car. These machines carry their own motors and are often made adjustable as to height of lift.

While 45 deg. boosters are probably most used, inclines of from 30 deg. to 60 deg. are common. Unless top guards are used to prevent the boxes from rolling backward, 60 deg. to 70 deg. is about the practical limit of incline. Where the packages are of uniform size, however, the

angles, large enough only to provide proper chain runways, form satisfactory frames when thoroughly trussed and cross braced. Light roller chain—with push-bars



Extending Scope of Gravity Conveyor

use of such top guards makes it feasible to elevate at any angle up to the vertical. The chief advantage thus gained is in the saving of space.

Compact single or double reduction drives, with silent chain or belt from the motor, are much used, although the direct connected internal gear reductions are in many respects more satisfactory with portable machines. It is highly important to eliminate excess weight; also every part of the machine should be designed as light as is consistent with reasonable service requirements.

Food Products—Canning—Packing

Cartons—Boxes—Cases

The small amount of floor space required by the push-bar elevator because of the high angle at which it can be operated is a big feature in many industrial buildings. By placing the elevator against a wall or in some unused corner, and feeding to it by hand truck or gravity conveyor practically no storage or working space is lost. This space-saving feature and the fact that the elevator is not limited to short lifts make it applicable to multi-story canning plants. As a hooster, stationary or portable, for a gravity conveyor it is economical in warehousing empty or filled cases, box-shooks, or cans. It is used extensively in elevating packages to be carried over driveways, tracks, or yards to other buildings.

For handling the usual run of light packages, light steel



High Angle Double Elevator

spaced about 4 ft., and with a speed of about 60 ft. per min.—is usual. A capacity of 1,200 cases per hour on a single runway is thoroughly feasible. With fairly uniform packages and high push-bars, it is possible to operate these elevators at angles as high as 70 deg. without a top guard. On the higher elevators high side guards are necessary mainly for reasons of safety.

Paints—Oils—Grease—Chemicals

Boxes—Cartons—Tubs—Cans

The generally uniform nature of the containers used makes the push-bar elevator very applicable to paint, chemical and similar industries. Incoming raw materials



Shipping Room to Cars

in tubs, barrels, cans, etc., as well as box shooks and empty boxes, are handled on push-bar elevators to storage rooms, or from storage to the packers. Similarly, working in combination with power and gravity conveyors, this elevator forms a valuable part of systems of distribution of packed goods from packers to storage or cars. The saving in time and labor accomplished by direct loading from the packing tables to the cars by gravity conveyor is often made possible through the use of push-bar "boosters" to provide the necessary drop to the line of gravity. A common use of the machine is the elevating of merchandise from basement storage to shipping platforms after the goods have been collected at a convenient point by conveyors or trucks.

For transferring from power conveyors to push-bar elevators a short section of gravity conveyor between the two units facilitates the automatic loading of the elevator, by preventing forcing of the packages from the one machine to the other. Similarly, light spring-steel strips placed at the foot of the elevator serve not only to start the package properly up the runway, but also hold back any package that has not been securely picked up by the push-bar. Where such equipment is subjected to the action of chemical acids, or to conditions of extreme moisture, it is often advisable to use chain with special wearing parts.

Textiles

Tote Boxes—Baskets—Cases—Bales

In spinning mills the push-bar elevator solves the problem of returning to the spinning and roving frames boxes or baskets of empty bobbins which were previously lowered on gravity conveyors or chutes. The illustration shows the very small floor space occupied by such an elevator. The automatic feed and discharge, with the selective receiving principle, insures orderly movement of packages up the elevator, even though they are delivered in a

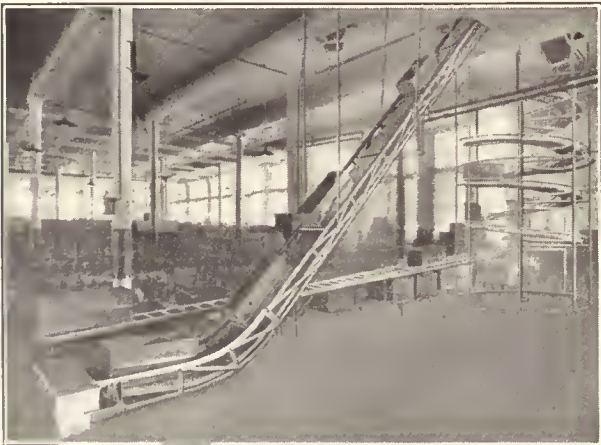

Returning Empty Bobbin Boxes

continuous stream to the foot. These machines are being applied to an increasing extent to the elevation of many other packages in textile mills and finishing plants, such as packing cases, bales of cotton or wool, and bundles, bales or rolls of finished cloth. The ease of installation of these "pre-assembled" machines is an important factor in busy mills.

For the usual textile mill service of handling bobbin boxes and similar packages, light steel frames are usual, supported by hanger rods from the ceiling. Inclines of 45 deg. and 60 deg. are customary. Chain speeds of from 50

ft. to 80 ft. per min. are common, with capacities as high as 1,200 boxes per hour. For elevating bales of jute, wool, or cotton, or for heavy packing cases, heavier construction is necessary, with low chain speeds of from 30 ft. to 40 ft. per min. to provide for the greater strain.

Wood Products

Box Shooks—Boxes

The extensive use of the push-bar elevator for handling box shooks, boxes and similar light packages has been largely due to the simplicity of installation of the light equipment necessary for this work. The ease of spanning roadways, streets, or yards—with a minimum of framework—makes it feasible to use this elevator in places where



Connecting Operations in Different Buildings

the heavier apron types would be impractical, or belt elevators, because of the greater protection necessary, would be much more expensive. Working in combination with gravity or power conveyors, the push-bar elevator is widely used in furniture manufacturing, box-making, and similar wood-working plants, to connect in continuous sequence operations in different departments or buildings.

The simplest method of spanning between supports is to so design the side trusses that the elevator frame will be self-supporting. Knee braces from the supports at each end stiffen the truss and increase the possible span, or, where the span is too long for this, sway rods are often run from above the end supports. For the longer spans, however, it is customary to build light trusses independent of the frame of the elevator.

Wholesale Houses

Miscellaneous Packages

The necessity for saving working and storage space in most wholesale grocery, hardware, mail-order, and similar distribution and supply houses, has made the push-bar elevator particularly useful because of the high angle of incline at which it will successfully operate. Not only is it used economically as a floor-to-floor elevator, but also in multi-story heights as one continuous elevator discharging

at each floor. By using the upper floors to which the elevator runs as storage for the lighter packages best adapted to push-bar elevating, this machine will handle practically all commodities going to these floors. In hardware and similar houses handling bulky or heavy packages, it is successfully applied to short runs and transfer of packages within its scope, although it has not the wide range of usefulness of the apron slat elevator.

Both automatic loading from gravity conveyor and hand-loading are common in this class of service. In either case a section of gravity conveyor, or long sloping discharge table, is advisable at the discharge point to prevent any blocking of the elevator by the piling up of packages not

ages, particularly where any are of approximately cubical shape with a natural tendency to roll back at the higher inclines, the push-bars must be unusually high, often 8 in.



High Angle Saves Storage Space

clearly removed. Because of the miscellaneous shapes, sizes, and weights of packages, an angle of 45 deg. is about the maximum incline advisable. The push-bar should ordinarily run about 4 in. to 8 in. above the runway bed, but if there are small packages to be elevated, care must be taken not to have the bar placed higher than the smallest package to be handled.

Packing to Storage and Shipping

Heavy Cases

The use of extra wide and heavy push-bar elevators for handling heavier packages has been increased in recent years by improvements in design and in the automatic loading and discharge features. Such an elevator may be loaded practically automatically from any intermediate floor by means of adjustable loading plates. Similarly, these elevators are sometimes designed to discharge at intermediate floors through openings in the bed, made by removing or lowering adjustable sections of the runway. However, this method of discharge applies mainly to fairly uniform and regular packages of lighter weight.

Because of the greater wear on the sliding surfaces in elevating heavy packing cases, it is advisable to use either rollers or heavy sliding strips in the runway bed. Likewise, because of the weight of the packages, the entire frame should be specially braced. Heavy-type push-bars and roller chains are usual. In handling the larger pack-

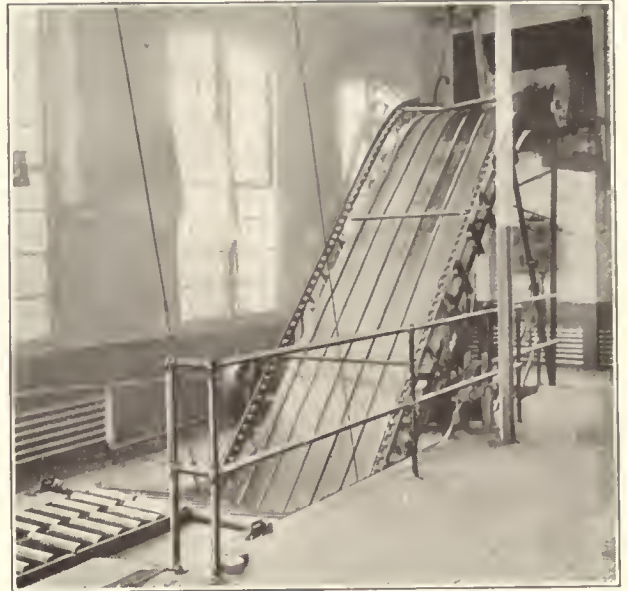

Receiving from Two Floors

to 10 in. above the runway. Slow speeds, of about 30 ft. to 40 ft. per min., are advisable largely because of the shock of loading. Where intermediate floor loading points are used, they must be designed with special care, and with regard to quick adjustment and easy accessibility.

Storage to Shipping

Boxes—Crates—Cartons

The push-bar elevator working in systems with gravity conveyor is particularly useful for elevating packages to

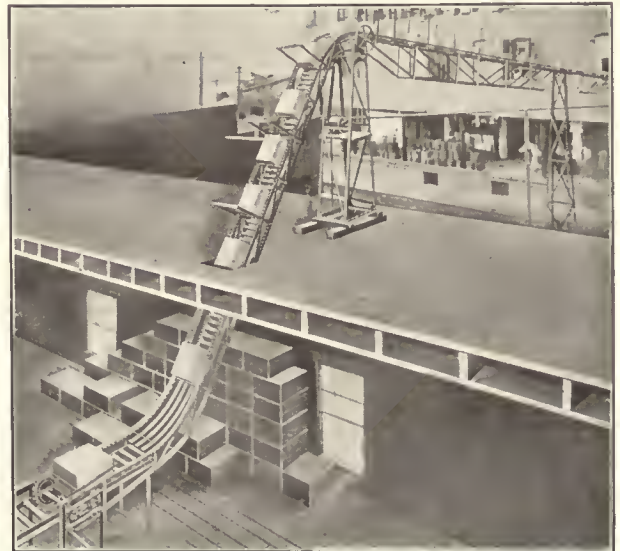

Street Span Eliminated Trucking

a height sufficient to pass over streets, tracks or yards. The greatest economy of operation is secured by such direct handling, and the automatic transfer of packages between the various units of the system eliminates practically

all manual labor between loading and discharge points. The simplicity of installation of such equipment, with the very light supports and trusses required, is surprising and enhances the value of such systems.

In automatic loading from gravity conveyor to the elevator it is important that the push-bar take a position squarely behind each box. Various types of selective devices are used to accomplish this. Spring pieces placed at the foot through which the box passes serve the double purpose of starting the box properly up the center of the elevator runway and, for fairly uniform sizes, they hold back any box that has not been securely caught by the push-bar. Where, as in this case, rollers are used in the bed, steel strips or plates at the up-curve prevent packages from "digging in" between the rollers. For packages of small size, push-bar spacings of about 4 ft., with chain speeds of from 50 ft. to 80 ft. per min. are usual.

General Freight

Barrels—Tubs—Cases—Crates—Boxes

While the push-bar elevator is not so well adapted as the apron elevator to the handling of general freight, it is thoroughly satisfactory for many types of packages handled in this work. One-story elevators are usual for this service, although many of these machines have been installed to serve several floors. For the heavier packages, particularly, rollers in the runway bed reduce somewhat the driving power required, except at the up-curves, where it is necessary to use a sliding surface.

Heavier frames of four or six angles, well trussed, are usual, with wider runways to provide for the more bulky packages. Inclines of 30 deg. or 45 deg. are best, preferably



Roller-runway Increases Scope of This Conveyor

the former if the greater floor space required is available. With this lower angle of incline the push-bar may run closer to the runway bed and thus better handle the smaller packages. Comparatively low chain speeds of from 40 ft. to 50 ft. per min. are best, with the push-bars spaced close enough to give the desired capacity. In general warehouse work such equipment as this is more apt to be neglected than

it is in manufacturing plants, and for this reason it is particularly advisable that some one man be assigned to the regular care of the machine.

Paper Manufacturing Pulpwood

The necessity for stacking pulpwood in high piles over a large area has brought about the development of the portable log stacker. These machines are built on very much the same principle as the chip-stackers in such common use in sawmills. The logs are piled to



High Piling Saves Storage Space

heights as great as 60 ft. in piles of any desired length. By using a modification of this type many commodities in industries other than paper can be handled to excellent advantage. When used for stacking other open storage materials than lumber, the booms of the smaller sizes of stackers are usually made adjustable as to height of discharge to provide for more careful handling than is necessary with pulpwood.

A V-shaped wood trough, preferably steel lined, forms the runway. A single strand of chain running at the bottom of the trough, with pusher attachments at fixed intervals, propels the logs up the incline. These machines are mounted on two rails so located as to preserve proper balance. These elevators are self-propelling. Where the overhang of the cantilever is so great as to cause a tendency to overturn the machine or make it unstable, counterweights are used over the inner rail to balance the cantilever weight. For service in handling pulpwood or similar commodities chain speeds of from 90 ft. to 130 ft. are customary. The fact that the logs can be dropped onto the pile from the highest point of discharge avoids the necessity of making the cantilever frame adjustable, as is necessary in stacking other more fragile packages.

Lumber and Logging Pulpwood—Logs—Timbers

In the handling of logs, pulpwood and lumber this simplest type of drag conveyors finds many uses. With flat-bottom troughs or runways, ice, bales of hay, and many other packages also are handled, although not so satisfactorily with single as with the double strand chain. With other commodities than lumber products it is customary to attach a block of wood to the chain, the latter running in a slot below the runway surface.

These drag conveyors are built with very long centers. They are not usually reversible, although two-way travel is sometimes provided for. The chief advantage of such equipment is its extreme simplicity of design and construction. It can be easily taken down and set up to meet changing layouts. Such a conveyor is used more for temporary service than for permanent installations. Cable carriers are often used for this purpose instead of chain.

For handling logs V-shaped troughs of 2 in. boards are usual, while flat runways are used for ice, hay, and similar packages. The two sides of the V-trough form guards as well as sliding surfaces, keeping the package moving properly. With the usual flat runways side

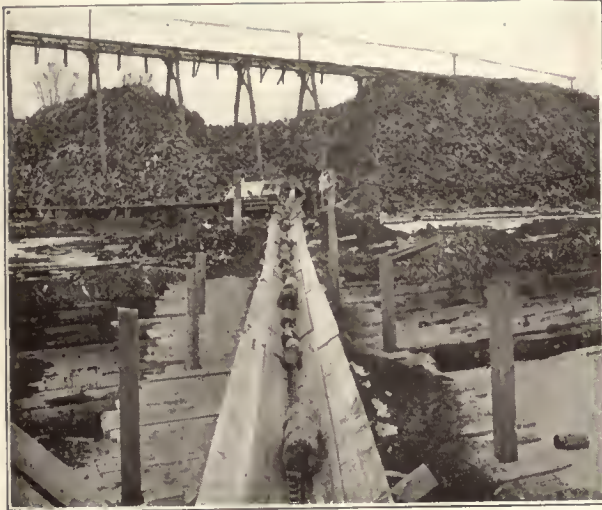

The Drag Is the Simplest Conveyor

guards are essential. In the lumber conveyors plain detachable link chain with lug attachments propel the packages. Where the wood push-bar is used, with the flat runway, particular attention should be given to securing it rigidly to the chain, for in operating a very high strain comes on this point of attachment. With this type conveyor there is a tendency for the push-bar to turn back as well as to twist sideways in driving the package ahead.

Ice Cutting and Manufacture

Ice

The push-bar conveyor has probably been more used for the handling of ice than for any other commodity, largely because it is the type conveyor most adapted to such a light article and one that slides so easily. Because of the simple construction of this conveyor it is less affected by being continuously exposed to the weather than the more highly developed types of carriers. Such a conveyor is extensively used for storing lake ice after cutting, in which service it fills the double purpose of both elevating and conveying the cakes of ice from water level to storage house. This conveyor makes an excellent car loading system both for icing refrigerator cars or loading cars of ice for shipment. Very little driving power is required to operate the conveyor in handling ice.

It is customary for this work to use either wood or steel angle push-bars with plain steel or malleable chain running in an angle track or on steel or wood

strips attached to the timber frame. With push-bars spaced about 4 ft. apart the capacity is very high, even at the fairly low speeds of from 50-ft. to 75 ft. per min. at which such conveyors are usually operated. Inter-

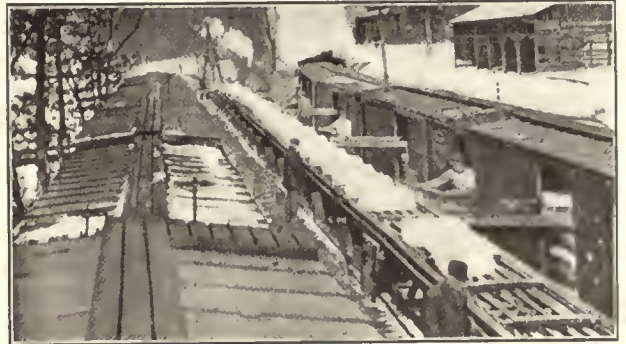

Loading Four Cars at Once

mediate discharge at the various car doors is usually accomplished by manual handling. In the case of ice storage houses, however, the ice is often discharged through openings in the runway formed by hinging down a section of the runway bed. With such a conveyor the chain and push-bars are ordinarily returned overhead to avoid conflict with the cakes of ice discharging through the runway.

Soaps—Greases

Boxes—Cartons—Cases

For handling fairly light packages with surfaces smooth enough to slide easily on the wood or steel runway, the double strand push-bar conveyor forms a simple and satisfactory carrier. For the long runs in which this type of conveyor is so often used it possesses a decided advantage in that the weight of the



Delivering Boxes to Storage

moving parts of the machine is very low. This advantage is quickly overcome, however, by the roller chain and apron type, if the conveyor is put to any duty other than the handling of light packages. By making smooth up-curves this equipment is equally serviceable as a combination conveyor and elevator. Similarly it is reversible in direction of movement, although if used with an elevator section at the higher angles, it is not entirely satisfactory in lowering packages unless specially designed. If the runway beds are

made of rollers, similar to the gravity roller conveyor, much heavier packages may be handled to advantage because of the reduced friction.

Wood runways are usual in this work, although often lined with steel strips or corrugated iron to lessen the sliding friction of the package. Plain detachable chain is most used, although roller chain is preferable, running in steel angle guides or on steel or hardwood strips attached to the frame. The frame is generally of wood construction. In some installations packages are discharged at intermediate points by removing or hinging sections of the runway, arrangement being made to insure the package clearing the returning chain of the conveyor as it discharges through the opening.

Bottling

Cases—Trays—Cartons—Barrels

In bottling plants the push-bar elevator is used extensively and with great success largely because of the uni-

formity of size of packages handled. Receiving and discharging automatically, it is equally useful either as a floor-to-floor elevator or as booster for long lines of gravity conveyor. Filled or empty bottles, whether in packing-cases or open trays, are handled in perfect safety and with a minimum of operating attention. Barrels, kegs, or tubs, travelling on end on gravity or power conveyors, are similarly received by the automatic feeding mechanism and delivered to tables or to other conveyor lines above. Such irregular packages require, in general, lower angles of incline than cases or boxes.

For handling packages of strictly uniform size it is feasible to run the push-bar elevator vertically, with horizontal loading and discharge portions. The top guard forms, with the chain guide angles and runway bed, a vertical shaft in which the package travels. The chief advantage thus gained is in the saving of space. For service in bottling plants plain or corrugated sheet steel runways are usual. The corrugated runways are somewhat stiffer, and produce rather less sliding friction than do flat steel sheets of the same gage.

Apron Elevators and Conveyors

The sturdy construction of this equipment, its high capacity, and the fact that packages of all sizes may be handled on the same apron, make it the most generally useful of all continuous motion carriers. Requiring no operator, and always instantly available, it is particularly adaptable to miscellaneous freight handling in industrial plants, as well as in terminal and marine warehouses and on piers. Because of being largely shop-assembled it is installed with little disturbance to plant operation. Its rugged construction enables the machine to withstand for many years such rough usage as would quickly wreck other types of equipment. It is easily stopped or started from any desired point, and is reversible in direction of motion.

The apron type machine is adaptable not only to the handling of individual packages, but, when properly equipped, will elevate, lower, or convey men and trucks, thus saving the time of unloading and loading the trucks. Such application of the apron elevator or conveyor approaches very closely the function of the various types of truck hauls described in a later section of this book. Similarly the use of large gathering boxes, carried about the storage rooms on low platform trucks and delivered semi-automatically to the conveyor saves the time of handling individual packages. Such a combination method has proved successful in many plants, and has materially increased the usefulness of apron carriers.

As elevators and lowerers these machines are used economically not only as floor-to-floor elevators, but also in multi-story heights as one continuous elevator discharging and loading at each floor. Because of the high operating inclines possible, such equipment requires a surprisingly small floor space. With fairly light packages the incline may be increased almost to the vertical by attaching to the slats cleats or arms of such a height or type as to prevent the package from rolling backward. In fact, with packages of uniform size this machine is often operated in a combination of horizontal and vertical positions. At the higher inclines it becomes practically a rigid arm elevator. In places where it is desirable to lower as well as elevate packages the use of this machine is even more economical, within the limits of incline at which objects may be safely lowered.

With a short horizontal portion at the bottom, joined to

the incline by a smooth curve, the loading of this elevator is made practically automatic for inclines up to 30 deg. to 50 deg.; the higher angles being used only for bags or similar packages which have little tendency to roll back. Such automatic elevators receive from and discharge to either gravity or power conveyors. Automatic feed mechanisms, somewhat on the selective principle of the push-bar elevator feeders, are being developed which promise to make the apron slat elevator with cleats much more self-loading than at present.

As a conveyor, running along the ceiling, or in out-of-the-way places, with down or up curves at convenient points, it takes up very little working space. The facility with which packages will transfer from one conveyor to another, placed at any desired angle to the first, makes it feasible to fit these machines into almost any condition of plant layout. In fact, one of the biggest fields of service of the apron conveyor lies in the direct connecting of successive operations in different departments or buildings, made necessary by plant layout changes and additions. Running level or on inclines, under floors, through walls, or from building to building, the conveyor provides a tie that is far more important to production than the mere labor or time of trucking that is saved. Wherever used in this way it is a production organizer. Working with the various types of continuous motion elevators and lowerers, it serves as a most efficient unit in plant transportation systems. One of the most economical of such combinations consists of conveyor and elevator installed as one continuous machine. The apron type conveyor is especially adapted to outdoor service. It requires very little protection and simple supports, and often carries on its own frame such light housing as is necessary. As such a carrier between buildings the conveyor is particularly valuable in bad weather.

Probably the most interesting of the recent developments in inclined apron elevators and conveyors has been the portable machines for piling or conveying merchandise in warehouses, and for loading and unloading trucks, cars, barges, and ships. Carrying its motor or engine within its frame, it is easily moved to meet the changing operating conditions of such work. The greatest efforts have been made to design machines for this service of sufficient

strength for the work to be done, yet light enough to be easily portable. While these machines are designed to stand hard service, it is evident that if made as heavy as stationary equipment they will not be thoroughly portable, unless self-propelled. Since such machines are usually moved from place to place by hand, adherence to this basic principle of lightness in design has materially increased, in recent years, their field of economic use.

As an elevator or piler one of the big advantages of the apron type machine is that it will pick up loads practically from the floor, saving most of the labor of lifting. Similarly, through the adjustable feature of its carrier, it will deliver to any desired height. This adjustable discharge height is very important in ship, barge, or boat loading, where variations in both tide or deck level are met by raising or lowering the carrier boom.

As a floor-to-floor elevator, elevating through convenient small openings in the upper floor, and as a booster to provide additional grades for gravity conveyors, this machine is very useful. By reversing the direction of travel of the apron it is used in lowering from upper floors, or in breaking down piles of merchandise. Such portable machines are made in practically all sizes and elevating heights, up to 1,000 lb. capacity and 30 ft. to 40 ft. maximum discharge height. They pile at such angles as to operate in narrow aisles and occupy comparatively little space on the floor.

As portable conveyors such equipment is used in sections of convenient length, each section either carrying its own power or driven as a trailer from a power section. The sections, mounted on casters or wheels, as floor or ground conditions demand, are easily set in place or removed as the changing warehousing conditions require. Packages traveling on the conveyor transfer automatically from section to section, making right angles or other turns. Working in systems with portable pilers or boat loader-unloaders, the conveyor carries merchandise from cars or boats to storage piles in a continuous stream and with the minimum of manual handling.

These apron elevators and conveyors fall naturally into two general classes, the standard chain-and-apron type, and the roller carrier type. In the first, and most common type, the slats forming the apron are attached at both ends to plain or roller chain running in a guide and over end sprockets. The apron of the second type, as its name implies, consists of a series of small carriers with end rollers running in guides. Attached to the underside of the carrier is a single or double strand of chain, usually the latter, which runs over end sprockets and propels the carriers with their rollers. These carriers may be of any desired shape or size to fit the packages to be handled, from the plain steel axles, to specially designed carriers approaching a small four-wheeled truck in character. Both of these types are commonly built in portable as well as stationary machines. In any case, whether the carriers are spaced some distance apart, or are so closely spaced as to form practically a continuous apron, the basic principle of the machine is that it supports and carries its load, in contradistinction to the dragging and pulling principle of push-bar or haulage conveyors.

General Specifications

Frame. While many successful apron elevators and conveyors have wood frames with steel and hardwood chain-guides, the modern tendency in design is toward the all-steel frame, with the chain running in the horizontal legs of the side truss angles. The steel frame properly braced is stronger and more durable, and more gen-

erally satisfactory in operation than the wood. It is also cleaner and neater in appearance. A very satisfactory steel frame consists of four angles, forming two side trusses, and thoroughly cross-braced to prevent spreading or twisting of the trusses.

Curves or Goose-Necks. While not essential, curves at the top and bottom of elevators and sometimes at the ends of conveyors are advisable to facilitate loading or discharge, particularly where it is desirable that such transfer should be automatic. Whether in elevators or conveyors the curves should be of sufficient radius, usually 4 ft. to 8 ft., to insure smooth travel of the packages. Up-curves should be provided with top guards over the chain of such design as not to interfere with the travel of packages overhanging the ends of the slats.

Apron or Carrier. For the standard chain and apron carriers the slats should be of straight-grain hardwood, or of steel, usually the former. The selected hardwood slat gives excellent service and has the advantage of being easily replaceable. Straight slats with slightly beveled edges are most common, but for packages of special shape the slats should be designed to fit the object to be handled. These slats should be securely attached to the chain, and their spacing should be close enough to prevent the smallest package from falling between them. Since the attachment of the slat to the chain is the point of greatest strain, this connection should be secure in order to withstand any tendency of the slat to twist and split. In elevators particular attention should be given to preventing any tendency of the slats to turn backward under the weight of ascending packages—even to the extent in some cases of using steel strips attached to each slat and overlapping the slat behind.

In the roller carrier type the carrier should be designed to suit the package. Plain steel axles, spaced from 10 in. to 16 in., running on end rollers, and propelled by two strands of plain detachable chain, are satisfactory for bags, bales, or bundles. For the more difficult packages special cradle trucks on wheels are required. End rollers, whether of cast iron or steel, must be true and free to turn. In determining the proper width of any conveyor it should be remembered that for ordinary service the occasional larger packages may satisfactorily be allowed to overhang the side.

Cleats or Arms. Running on the level, or at the lower angles of incline, the friction of the package on the apron is usually sufficient to insure its proper travel. However, at higher angles or where there is a tendency for the package to slide or roll back, wood or steel cleats, lugs, or arms, of the right height to securely hold the package in place, should be rigidly attached to the slats at the desired intervals. Each of these cleats should be attached to one slat only, but for the higher inclines there will be less tendency to turn backward under the load if the cleat, or a small plate, is extended backward over the edge of the slat behind.

Chain. For the standard chain and apron type carrier, plain detachable link chain is serviceable for lighter duty. However, the use of malleable or steel roller chain requires less driving power and gives greater all-around satisfaction. Malleable roller chain is most common, although steel chain, with hardened wearing surfaces, gives somewhat longer service under abrasive, or heavy wearing conditions. For equipment working under conditions of extreme moisture or in handling chemicals specially designed chains are advisable.

For roller carrier aprons the lighter detachable link chains are satisfactory, since there is usually less wear on them, and less pulling strength is required by the larger end rollers on the carrier. Attachment links should be of

such size and strength as to provide a connection between chain and slat or carrier, not merely strong enough for the static loads, but to withstand the shock and twisting strains of loading.

Side Guards. With elevators, operating at ordinary angles, side guards are seldom necessary, except for special packages which may have a tendency to roll sidewise. At the higher angles of incline, however, guards of steel angles, sheet metal, or wood are often used, mainly as a precaution in case of careless loading, or to insure the safety of men working under or around the elevator. On conveyors, side guards are necessary only for the sake of safety in overhead installations, or for special side-loading purposes. They are, of course, required where it is desired to handle cylindrical, or similar packages on flat aprons. Where heavy loading is to be done at any point it is advisable to attach continuous angles to the side frame, which, extending slightly above the slats or carrier, protects the apron and chain. Such angles, used alone, or with plates extending over a portion of the end of the slat, serve as a rather necessary protection of the slat in handling loose packages like waste paper or rags.

Loading Points. To facilitate the loading of heavy packages onto apron elevators the foot of the elevator should be as close as convenient to the floor. Where possible it is advantageous to set the lower end-shaft below the floor level. In such cases a steel floor plate, with inset rollers, from which very heavy packages are fed onto the elevator, makes for easy loading. Where heavy objects are loaded carelessly, a solid plate or several angles placed close under the slats at the loading point, reduce the shock of loading on the apron. To insure heavy packages starting up the incline bearing squarely against the cleats, it is advisable to use loading fingers placed just above the moving slat. The package, momentarily resting on these fingers, is picked up squarely by the elevator cleats, projecting above the fingers, as they pass through. For elevators fed by gravity or power conveyor, one of the various timing devices or feeders may be provided.

In conveyors much manual lifting can be eliminated and the operation of the conveyor made more satisfactory by having all loading points as close to the floor as possible. Where it is not convenient to have the entire conveyor run along the floor, or even set in the floor, down curves at the end or at desired intermediate points make easier loading. As with elevators, stiff angles or a steel plate set close under the apron at these loading points relieve the apron of much of the strain of loading heavy packages. This applies particularly in storage operations where heavy loads are fed from chutes onto the conveyor.

Discharge Points. It is important that the discharge be so arranged as to insure packages leaving the end of the conveyor or elevator promptly and clearly. A satisfactory arrangement is to provide a long sloping table or section of gravity conveyor to allow for temporary piling up of packages without blocking the machine. It is often desirable to use some simple automatic control device at the end discharge connected with the motor to stop the machine when packages do not properly clear the discharge point. Although apron elevators usually discharge over the top, they may easily be unloaded at any floor. Where the carrier is composed of smooth, rounded-edge slats, boxes and other fairly rigid packages are successfully diverted automatically at any point by adjustable diverters. These are usually made of smooth steel plates or hardwood boards, preferably hinged at one end or sliding up and down on pipe guides. When set in position to divert they should be at such angle with the carrier as to smoothly sweep the

package off to the side. Such diverters may be controlled locally or from the point of dispatch by cables.

Drive and Take-up. Practically any of the standard worm, spur, or internal reduction gear drives are satisfactory, with belt, silent chain, or direct connection to the motor. Single or double reduction spur gears are most common and are generally satisfactory, although for the lowest speeds worm gears or internal reduction gears are more often used. While it is customary to drive apron elevators or conveyors from the delivery end, many of these machines are reversible in direction, and are driven from either end.

Control. The usual method of control is by means of a switch. Where it is desired to stop or start the machine from several points, electric push-button control is better. It is often advisable, in addition, to provide simple automatic safety stops, either electrical or mechanical, particularly on elevators handling men and trucks.

Special Features of Portable Elevators and Conveyors

Elevator Base Frame. The supporting frame is best constructed of steel channels, 4 in. and 5 in. channels being generally used. The base frame must be particularly well braced to withstand the racking incident to moving over rough and irregular floors.

Carrier Frame or Boom. The side trusses of this frame for both conveyors and elevators are most conveniently formed of two steel angles, usually from 1¼ in. by 1¼ in. by 3/16 in. to 2½ in. by 2 in. by 3/16 in. angles, the horizontal legs providing the runway for the chain or rollers. These two side frames should be tied together at frequent intervals by angle struts or a steel plate, or by both. For easy portability, however, particular attention should be paid to making this frame, as well as all other parts of the machine, as light as consistent with the nature of the work to be done.

Elevator Raising Device. The apparatus for raising the boom should be entirely under the frame, to insure clear travel for bulky packages and to facilitate moving the machine through doorways. Except in the smallest machines the boom should preferably be raised by power driven mechanism. This raising frame should be so designed as to insure the stability of the machine with the boom in high position.

Drive and Take-up. In portable apron elevators, because of the adjustable discharge with the motor stationary in the base frame, the carrier is most conveniently driven from the foot end, and the chain may be kept at proper tension by take-ups placed at the top. For both elevators and conveyors the direction of travel of the carrier should be reversible, with proper switches and reducing mechanism to accomplish this. Special attention must be given to eliminating excess weight from the driving mechanism, for if the maximum use is to be made of any manually moved machine it must be as light as is consistent with the strength necessary for the work to be done. Internal spur gears have been satisfactory for this reason. The heavier types of these machines should be self-propelled.

Casters or Wheels. Portable elevators or conveyors usually are mounted on four casters, which are satisfactory when the machine is to be moved over fairly smooth surfaces. The importance of easy portability is so great that the best casters made are none too good. Ball-bearing swivel joints with the best roller bearings in the wheels make excellent casters. Where the machine is to be moved over rough, uneven floors, or used in out-of-door work, wheels of from 12 in. to 30 in. are better, even though not

so flexible in direction of movement. Occasionally it is advisable to mount such elevators on light steel, or other wagons.

Operation

One of the biggest advantages of the apron elevator or conveyor lies in its simplicity of operation. It requires neither operator nor special loading or discharge, and can be started, stopped, or reversed in direction by a push-button or switch. With properly designed equipment and reasonably careful handling, occasional oiling and cleaning of the chain and driving mechanism are about all the attention required. It is not uncommon, however, for machines to be made entirely too light, or otherwise be unsuited to the work to be done. Such mis-applications come about frequently through designing the equipment for average service, and not providing for the unexpected loadings, strains, or rough usage that are certain to occur. With the apron elevator a common trouble comes about through the attempt to handle packages at angles of incline higher than those for which the machine was designed.

To insure proper loading and less wear and tear on the equipment, it should be run at the lowest speed that will give the desired capacity. It is safe to say that most of these machines, as usually installed, run faster than it is practicable to load the machine or handle the discharging packages. With elevators, loading downward from the top requires more attention in angles over about 25 deg. than up-loading, because the packages do not so readily find their proper place against the cleats, with the result that they may slide or roll down the incline. Where, as is frequently the case, heavy packages are rolled or thrown down from storage piles onto the elevator the machine should either be provided with a re-enforced loading point, to provide for this hard service, or be of generally heavier construction than would be necessary for ordinary operation and service.

In conveyors, where heavy packages are to be loaded at points along the side, a particularly good installation, from the operating stand-point, results from placing the top of the slats flush with floor. Unless thoroughly protected, or easily accessible for regular oiling and cleaning, however, such a position does not make for the longest useful life of the conveyor. If not installed in the floor the top of the conveyor should be kept as low as practicable at the loading points, to avoid manual lifting of heavy packages. A down curve at the end often simplifies the loading of such packages at this one point.

With either elevators or conveyors it is important that such a clear discharge be provided that there is no danger of packages piling up or stopping so close as to block the movement of the apron. Where it is not convenient to remove the packages as they discharge, a long sloping table or chute, or a line of gravity conveyor, acting as temporary storage, makes this operation much more efficient. In long conveyors and multi-story elevators it is often advantageous and thoroughly practicable to divert boxes, bales, and similar packages of ordinary rigidity at various intermediate points. Unless the apron is very smooth this is usually not satisfactory for bags and pliable objects.

The successful operation of portable equipment depends so much on the ease of movement from place to place that particular attention should be given to the surface over which it operates. Easy-swivel casters are excellent for fairly smooth floors, but steel wheels are advisable for rough floors or out-of-door work. Probably the biggest operating consideration with portable machines, however, is the question of weight, particularly where the machine is

to be moved from place to place by hand. Because easy portability is so essential to economical operation, many of the best informed operating men are coming to feel that they are willing to sacrifice some of the life of the machine in order to insure its maximum daily use.

With both conveyors and elevators of the apron type, particularly with portable machines, successful operation is far more a matter of knowledge of the many possible applications of the equipment than of its construction or operating details. Wherever such machines are used there should be one man who not only knows thoroughly the mechanical features of the equipment and is responsible for the operating condition at all times, but, far more important, also knows the possibilities of the equipment as applied to his plant. For instance, the warehouse man who knows the almost unlimited uses of a combination piler, truck-loader, and car-loader will get far more service out of the machine than the chance laborer with no knowledge or imagination in applying the machine to his handling problems.

Elevators for Trucks

The big demand for continuous motion inclined hand truck elevators has resulted in the present high development of such machines. In addition to the great capacity and continuous service of these elevators, probably the most important feature is the high degree of safety attained. Accidents are far rarer than in other types of lifts. Capacities as high as 500 to 700 trucks per hour in each direction are not unusual. The elimination of the usual



No Time Lost Waiting for This Elevator

platform elevator operator, and the freedom from waiting and delays are added advantages of this type of elevator. The truck-man may or may not accompany the truck, as is desired. Such a machine forms a stairway as well as elevator. It is naturally limited to from one to three-story handling and to carrying trucks with sides or with loads not easily disarranged by being tilted at the angle of the incline.

For this service aprons of special or multiple strand chain are usual, with dogs or lugs which grip the truck firmly as they carry it up. These lugs are usually placed very close together for the sake of safety in loading and travel. Wood and steel slat aprons with cleats which engage hooks on the truck are also much used. To insure the successful travel of wide trucks the sides of the high guards should be smooth and free from obstructions, and the floor must

fit closely to the moving apron. As usually installed these elevators carry their loads in only one direction, although double runways, for up and down traffic, are often used.

Truck and General Freight Elevators

Miscellaneous Packages

In the handling of hand trucks and men, as well as various heavy freight packages, there is an increasing use of apron elevators in marine and terminal freight handling, and in practically every industry. Improvements in design and positive safety appliances have been responsible for the more frequent adoption of this elevating and lowering method. Such elevators serve not only as truck-hauls, but also for handling gathering boxes or individual packages. Instant and continuous service, with great capacity, make this elevator most economical in operation, within the limits of one to three-story elevating, to which it is best adapted. Because the loads are carried at an angle this machine is most satisfactory in handling trucks with sides, or with loads not easily disarranged.

Broad wood slats, set close together and securely attached to roller chain, form a very satisfactory apron. The cleats on the apron must be made to fit the hooks on the trucks, and be so designed that they have a positive grip on



Direct Service for Loaded Trucks

the truck before starting up the incline. Low cleats, set close together, make a better and safer discharge to the upper floor. The guards should preferably be smooth-faced and solid, and must fit close to the moving apron for reasons of safety. Low speeds of from 20 ft. to 40 ft. per min. are preferable, largely because the low-speed elevator is safer in operation. The protective features used on the common escalator or moving stairway are good examples of the result of careful design in freight elevators of the apron type.

Cotton—Wool—Finishing Mills

Rolls—Bales—Bundles—Cases

As short transfer units between different floors or buildings the apron elevator forms a direct connection between successive operations in different departments of cotton and woolen mills. This use of continuous elevators and conveyors has bridged one of the highest obstacles to making

new process layouts in old buildings. The high angle of incline with resulting small space required, makes it possible to install such machines with a minimum of disturbance to machine layout or operation. Since the elevator is reversible in direction of travel it is doubly useful in un-



Arm Slat Type for High Angle

loading from cars to storage in basement or upper floors and in loading out bales or cases of finished goods. The portable elevator of this type is most economical in making use of the full height of storage rooms, and for the loading of trucks and cars.

For the usual work required of the apron elevator in textile plants—handling heavy bales of incoming raw material or loading out packing cases of finished goods—an apron is recommended, consisting of extra heavy wood slats attached to heavy roller chain. For the protection of the apron at loading points, steel loading fingers, or plates close under the slats, are advisable to relieve the apron of the continuous shock of loading. Where heavy bales are thrown or rolled down from storage piles onto the elevator, as is often the case, the machine must generally be of heavier construction than would be necessary for ordinary operation and service. Care should be taken to provide such a clear discharge that the bales will not pile up or stop so close to the top end as to block the movement of the apron. Where the elevator is to be operated above machines or workmen, angle side guards are essential for the sake of safety.

Linoleum—Carpets

Rolls

A rather extreme type of the inclined apron elevator is shown in the photograph. At the higher angles of incline this machine becomes practically an arm elevator. By using specially shaped carriers the most irregular packages may be handled successfully, but because they are designed for special packages they are naturally less versatile than the "carry-all" slat type elevator. They are often built in combination with horizontal, or conveyor portions; carry loads great distances and with frequent turns; and are readily reversible in the direction of motion.

The prime requisite in elevators of this type is to so design the individual carrier that it will not only carry the

package properly, but that it will receive and discharge its load automatically. Whether propelled by a single or by a double strand of chain, each carrier must be so made that its rollers will track perfectly in passing over the end



Carriers for Special Packages

sprockets, as well as on the straight runs. The use of carrier rollers of the usual size, 3 in. to 5 in., with fairly light detachable chain, produces an elevator requiring less driving power, in general, than the standard roller chain type.

Metal Products—Hardware

Miscellaneous Objects

The adaptability of the apron elevator as a "carry-all" is well illustrated in the photograph. Carrying men and trucks, as well as packages of all sizes, shapes and weights, this elevator combines a maximum of service and safety



A Wide Range of Packages Are Handled

with great capacity. Running at low speeds, or intermittently, it has a temporary storage capacity which is advantageous in loading or unloading cars or motor trucks. Where it is not desirable to elevate the entire hand-truck with its load the economy of this elevator is increased by

using gathering boxes. These are carried about the basement or upper floors on low-wheel platforms, from which they are pushed, when filled, onto the elevator. In this way the manual loading of the individual pieces is avoided.

Heavy wood slats with wood or steel cleats and heavy roller chain form a serviceable apron for this purpose. For convenience in loading it is often advisable to make a short portion of the elevator horizontal at the loading end, although this is not always necessary. Because of the difficulty of unloading heavy packages a convenient push-button or switch control is essential, by which the machine can easily be stopped. It is good practice to use a long sloping discharge plate at the top to insure clear discharge. Where men with hand trucks are carried, particularly at angles over 20 deg., three points require special attention: The speed should be low, preferably not over 30 ft. per min., the cleats must grip the dog on the truck in a positive way, and the connection between the apron and floor at the discharge point must be such as to render the transfer absolutely safe.

Terminal Freight Handling

General Freight

The great variation in sizes, shapes and weights of the packages which can be carried by the apron elevator makes it particularly applicable to the handling of miscellaneous



Direct Service Between Floors

freight. In addition to the continuous handling of packages in either direction, there is the added advantage of carrying men and trucks, provided the equipment is designed for this service and is fitted with proper safety devices and controls. Serving not only the usually two-story freight and storage houses, but much higher buildings as well, this elevator is replacing the slow, intermittent platform elevators in many places where the closest and quickest possible connection between floors is essential. The installation of apron elevator units at different convenient points has resulted in the saving of long truck hauls and time in waiting for slow-moving platform elevators.

A satisfactory apron for this service consists of heavy wood slats with steel angle cleats as low as will securely hold the package or truck. Steel slats, however, are often used. It is customary to use heavy roller chain or detachable chain with large end-rollers on the slats. Largely because of the greater strength and rigidity as well as the neater appearance, the use of steel angle frames is increas-

ing. Where these elevators are to be loaded and unloaded at intermediate floors low speeds of from 30 ft. to 40 ft. per min. are advisable, with special electrical or other control systems for starting and stopping

Marine Freight

Miscellaneous Packages

The most successful and economical uses of inclined apron elevators in marine freight handling have been in floor-to-floor traffic on double deck piers and in loading and unloading boats and barges. In the latter work the adjustable traveling platform, carrying men and trucks as well as freight of all classes, has solved a big marine terminal problem. By the adjustment of the supports the outer end is made to follow the rise and fall of the boat and serves any desired deck level. This continuous connecting link between the boat and the wharf not only saves labor and actual handling costs, but, what is more important, particularly with ocean vessels, cuts down the idle time of the ship itself.

Because this work is unusually heavy, strong and well braced frames are required, particularly for the adjustable ramps. Specially designed chains are usual, with heavy wood slats. Instead of cleats projecting above the apron the slats are often so designed that "cradles" are provided for the truck wheels, holding the truck securely in place. For higher angles more positive carriers are necessary, such



Adjustable Elevators for Men and Trucks

as higher cleats which engage hooks on the truck. The carrier should be reversible in direction of motion, and should preferably be run at slow speeds, of from 30 ft. to 40 ft. per min. Because such equipment usually works under bad operating conditions, it requires regular oiling and cleaning. These elevator ramps are hinged at the inner end, usually on heavy trunnions, while the outer end is supported by chains or cables running over hoisting drums.

General Freight

Miscellaneous Packages

By providing direct connection between floors at the most convenient points the inclined freight elevator eliminates long truck hauls and the delay of waiting for platform elevators. Used not only for elevating or lowering packages but for trucks and men as well, this is a general service machine. It has an enormous hourly capacity in either direction, even running at low speeds. The power consumption is low. Switches or push-buttons at convenient points control the motion of the elevator, and electric or

mechanical control devices provide a maximum of safety.

The illustration shows a good type of extra heavy elevator for handling packages of all sizes and shapes. The high angle cleats, on steel or wood slats, form cradles for even the most irregular objects. If these cleats are provided with a back extension, overlapping but not riveted



A Wide Variety of Packages May Be Handled

to the slat behind, they are somewhat stiffer under heavy loads. Such a construction, with the chain protected by the top angle and the slats set very close together, or overlapping each other, is especially good for handling waste paper and similar packages containing much loose material. The side guards shown are unusually heavy. The loading point is somewhat too high for the easiest up-loading, although advisable if the machine is to be run in the reverse direction to lower packages. An elevator of such size and capacity should preferably be run at a speed of not over 50 ft. per min.

Receiving from Trucks and Cars

Barrels—Drums—Kegs

Changes in operating layouts and plant processes almost invariably create new handling problems, often giving opportunity for the most economical use of elevator-conveyor



Receiving from Truck or Car

systems. With such continuous systems, packages which would otherwise be carried on slow-moving hand trucks

travel directly from motor truck or car to distant storage rooms, or from one department to another in the same or adjacent buildings. In crowded plants the simplicity of installation of these elevators, with the small space required, is of particular advantage.

For out-of-door service timber frames are often used and are satisfactory. Steel strips or angle runways should be provided for the chain. In handling heavy packages extra heavy slats and cleats are essential, and should be designed to fit the shape of the particular packages to be handled. With proper spacing of the cleats barrels are easily loaded automatically from standard barrel skids, as shown. Inclines up to 45 deg. are usual, although with high, well-braced cleats or arms, and with proper chain guides, practically any incline up to the vertical is feasible. Generally barrels or drums are best handled crosswise, as shown, although they are often carried lengthwise or at the lower angles of incline, on end.

Freight Handling

Boxes—Cartons—Crates

The use of the portable piler at the end of lines of portable gravity or power conveyors or as a booster has received an increased impetus with improvements in devices for transferring packages from conveyor to elevator. The up-curve, or gooseneck, at the bottom, with loading fingers, facilitates the loading, although such packages as bags and bales will transfer properly even at angles of 35 deg. to 45 deg. without either gooseneck or special loading device. Various other loading devices have been used successfully with the more difficult packages. A comparison between the shapes of the boxes on the piler illustrated is interesting. Because of their tendency to roll back the lower boxes in the crosswise position will not travel at so high an angle as the upper ones. But if the boxes are placed endwise as should be done for high angles, they will travel at an even higher angle than the upper boxes, because of their greater length.

Where loading fingers are used they should be strong enough and so supported as to relieve the apron of the shock of careless loading. Steel angles or a stiff steel plate

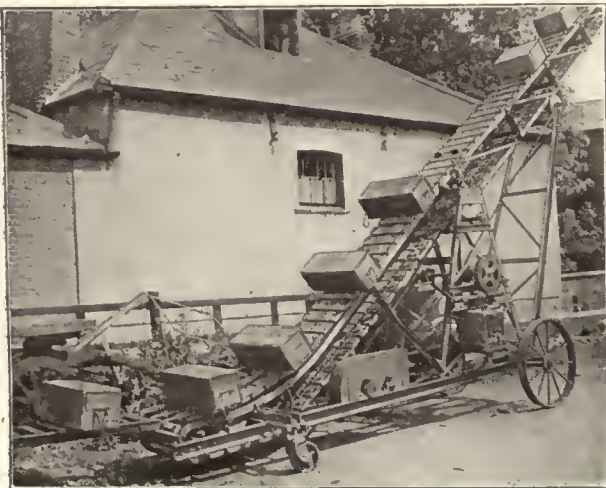

Transferring from Gravity to Piler

placed close under the apron at the loading point will do much to take the strain of loading from the apron. While many such machines in which the apron slats are returned

by sliding on the lower truss angle have given good service, this is not so satisfactory a construction as having the slats attached to end rollers or roller chain. In this case they return by rolling instead of sliding, thus avoiding wear on the slats, and requiring less driving power. A hand crank device for raising and lowering the upper part of the frame, or boom, is satisfactory for the lighter and smaller machines, but power raising devices save much labor and time.

River Freight

Miscellaneous Packages

The wide variation of the water level incident to many river and even tidewater ports has created a demand for elevators of extreme adjustment range. These machines are built both stationary and portable. They carry practically all classes of freight in a continuous stream either in loading or unloading, with capacities as high as 75 tons per hour. The upper ends of these elevators receive from or discharge to cars on adjacent sidings, or to trucks or

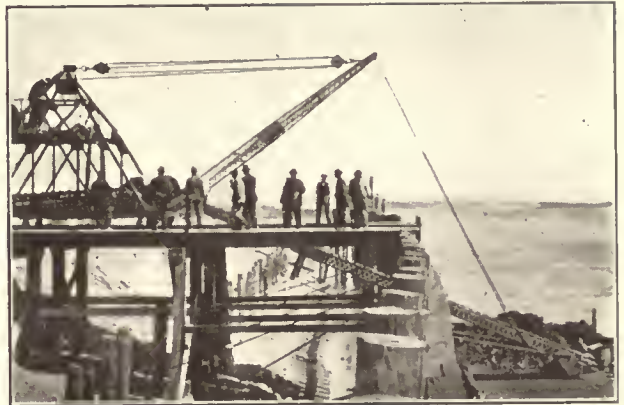

Adjustable to Changing Water Level

conveyors leading to storage. Because of their weight the larger portable machines operate most satisfactorily when mounted on light rails running either parallel or at right angles to the dock. They should be self-propelling. While requiring very little attention in operation, these larger machines should be in charge of one responsible man who is not only a thorough mechanic, but, more important by far, knows the handling possibilities of the machine. Much of the natural economy of these elevators is often lost through lack of training and judgment in their use.

For miscellaneous freight the apron should be made up of a combination of two or more types to suit the main packages to be handled. This has usually been done by providing a double width carrier, with straight and drop axles on one side, and with slats on the other. The adjustable boom should be thoroughly braced and trussed. The connection of the boom to the main frame is naturally a point of high strain. One of the most important points of design is to secure the proper balance with the outer end of boom fully loaded.

Barge and Boat Loaders and Unloaders

Miscellaneous Packages

The portable, adjustable apron elevator is particularly adapted to meet the continually changing levels of tide-water, river, canal and lake barges or boats. The adjustable loading or discharging end follows the rise and fall of the

barge so closely as to eliminate practically all manual lifting. In covered or hold boats or barges the carrier operates through the side or deck hatch, often working in conjunction with a portable conveyor in the boat or on the dock. Whether, in loading or unloading, this machine handles packages of practically any size or weight which can be manually loaded, and with a speed and capacity not equaled by any other means of handling.

For handling bags, bales, or bundles the straight axle type carrier is usual, but for miscellaneous packages either wood slats with cleats, or a combination of slats with straight

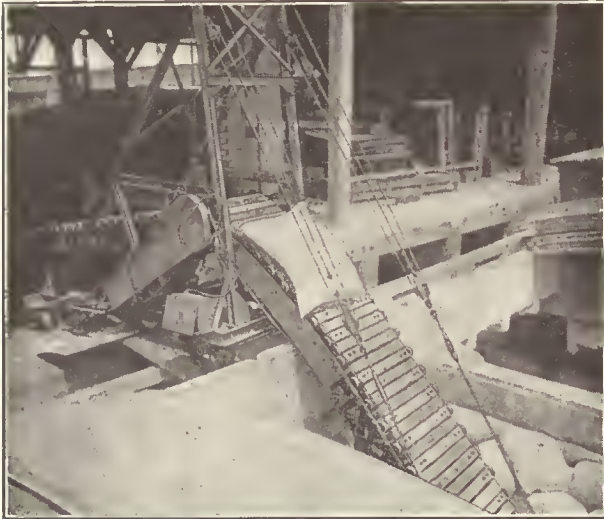

Delivering from Barge to Wharf

and drop axles is better. Speeds of from 50 ft. to 80 ft. per min. are most common, with capacities of as high as $1\frac{1}{2}$ tons per minute. Since the machine is usually moved over rough surfaces, steel wheels of from 12 in. to 18 in. diameter are preferable to casters. Easy portability is secured with the heavier machines by mounting them on flanged wheels running on light rails, placed parallel to the dock wall and flush with the pavement. These heavier machines should be power-propelled. Because it stands out of doors most of the time the entire machine should be kept covered with a tarpaulin when idle. While such equipment requires little attention, much better results are obtained by having some one man responsible for the large machines and thoroughly instructed in their use, particularly in adjustments and changes of position.

Warehousing

Boxes—Cartons—Cases

The application of the high type wood apron slats with end rollers to the portable elevator has produced a carrier particularly suited to handling boxes of miscellaneous size and weight. With proper angle cleats on the slats boxes can be piled at angles as high as 50 deg. Because the carrying surface of the apron is higher than the rollers and frame-angle, packages much wider than the machine are handled almost as easily as the narrower ones. The piler is also useful in breaking down piles, although at the higher inclines there is apt to be a greater difficulty in loading the packages unless the carrier is run at low speeds.

It is preferable that the angle cleats on such a carrier have a back extension over the slat behind, since at the higher piling angles this reduces the tendency of the cleat

to turn backward under the load. The successful operation and the length of useful life of the machine depends in a great measure upon the security of attachment of the apron slats to the chain and to the end rollers. The



High Type Apron for Boxes

loading point of the piler for practically all commodities, except in special cases, should be as near the floor as the proper clearance of apron and cleats in passing around the lower sprockets will permit. This is to avoid manual lifting of heavy packages. In the illustration is shown a convenient place for locating the adjusting cable drum, where the boom is raised or lowered by hand crank. Except on the smaller machines this drum should be power driven from the motor on the machine.

Storage

Piling Miscellaneous Packages

The tremendous amount of space wasted in most warehouses, resulting from the prohibitive cost of manual piling to capacity heights, accounts for the fast increasing use of mechanical pilers and stackers. As long as these machines were heavy and cumbersome their popularity grew slowly, but with the adoption of the policy of making such elevators as light and easily portable as is practicable, came a new vision of their possibilities. Mechanical piling, even in the rare cases where it does not actually eliminate men, so conserves their energies that when one job is finished they are fresh for the next work at hand.

The successful operation of these pilers applies to packages of all reasonable sizes, shapes, and weights, and to every industry handling goods in packed form. Because they are reversible in motion these machines are equally useful in breaking down piles. In handling fragile packages the breakage is far less with mechanical piling than with the hand-to-hand passing of manual stacking. It is not necessary that the piler stand across the aisle in operating, for it is thoroughly efficient, working alongside the pile.

The drop axle shown is best for handling cylindrical packages. The occasional straight axle prevents the package sliding at high angles. This is a very strong construction. Because of the large wheels on the ends of the axles less

driving power is required than with plain or standard roller chain. In general, the actual piling height of the machine should not be quite as high as the desired pile, for it is better to secure the greater portability of the smaller ma-

turning angles and feeding from one conveyor section to another, and from conveyor to piler. As the warehouse is filled, sections of the conveyor are removed to shorten the line. In loading out to cars, or for distribution, the system is equally useful working in reverse direction. The elimination of manual labor by such systems is very great. Where conveyor sections are to be used in connection with the piler, for this service the latter should be provided with sufficient power to drive the section of conveyor adjacent to it. The other sections are driven by separate motors, several trailer sections being driven from one power section. While the various transfer points shown are satisfactory for bags of sugar, such points are a source of operating trouble unless they are properly designed for the particular package or commodity to be handled. Boxes, for instance, can most successfully be turned at the angles by means of gravity conveyor or curves, and the maximum piling angle at which they may be expected to transfer from conveyor to piler is 30 deg. to 40 deg. For the greatest economy of operation of such systems the floors must be reasonably regular and the column spacing not too close. For handling bags and bales the straight axle carrier shown is excellent.

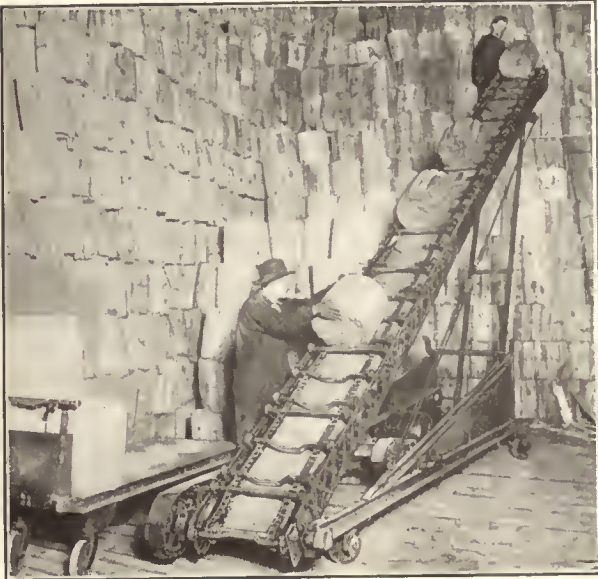

Drop Axle Carrier for Special Packages

chine, having the man on the pile place the last tier. Machines for handling packages up to about 200 lb. in weight may well be propelled from place to place by hand, but the heavier machines for piling over about 20 ft. should be self-propelled. For light machines speeds of from 60 ft. to 100 ft. per min. are usual for carrying a continuous stream of packages.

Sugar

Bags—Bales

A portable piler working at the end of a line of portable sectional conveyors makes a most economical and flexible

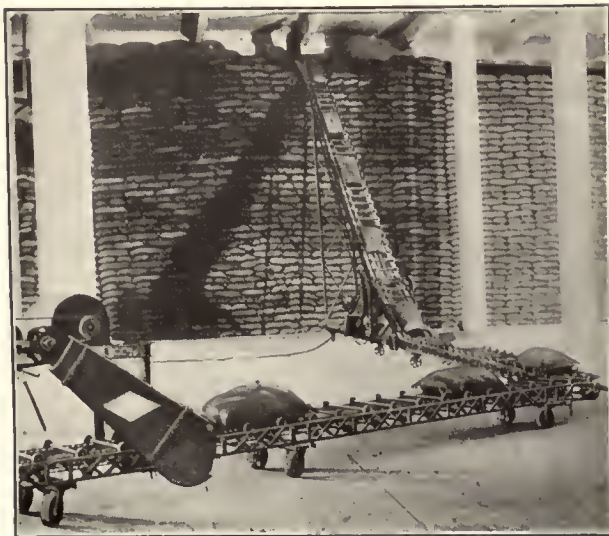

From Receiving Platform to Top of Pile

combination. The packages travel from car, shipside, or receiving platforms, to the top of the piler, automatically

Coffee—Copra—Cork

Bags—Bales

The self-propelling feature of the portable piler has made it feasible to operate machines large enough to pile as high as 40 ft. This has made such larger machines particularly valuable in saving space by the high piling of sugar, coffee, copra, jute, cork, paper and many other similar commodities.



Combination Type Self-propelled Piler

It is not uncommon for packages weighing as much as 600 lb. to 800 lb. to be handled in a continuous stream. The labor and time saved by eliminating the usual string of men used in manual piling is surprisingly great.

The power for propelling as well as for operating these machines, as usually designed, is furnished by an engine on the piler or through a cable attached to convenient electric outlets. The use of the cable naturally limits the distance the machine can travel from one connection. Some progress is being made in the development of storage batteries mounted on the machine to furnish power. The double-boom machine shown will start piling nearer the floor and reach further over the pile than the single-boom

piler. Practically all of these double-boom pilers have been built with the straight axle carrier.

Floor-to-Floor Elevators

Bags—Bundles—Bales

Working through convenient openings in the upper floor, these portable elevators save many long truck hauls and the time of slow movement on platform lifts. The ease with which the machine may be moved from one opening to another and with which the height of the boom may be adjusted, makes it possible for one elevator to serve an entire warehouse floor. The operation of such a machine is particularly economical when the lower end is close to the incoming or outgoing car door, and the packages are elevated or lowered through second floor hatches conveniently located along the side nearest the car siding or truck platform. In a similar way the elevator is often used, even on fairly narrow platforms, with its foot at or near the car door, and the discharge through second or third story windows. These floor-to-floor machines are very useful also for piling on the first floor, with the boom lowered.

The straight axle carrier, with end rollers, is well adapted to the handling of bags, bales, bundles, or any other fairly soft packages which hold their place on the carrier by "gripping" the axles. Boxes and other hard-surface packages will slip on such a carrier unless slats or cleats are provided. The straight axle carrier without slats makes



Saving Long Hauls by Direct Connection

a lighter but very durable machine. The use of a sheet metal plate under the axles stiffens the boom and prevents any possibility of sagging bags catching on the cross-braces below. The construction of side trusses with angles only large enough for the wheels to "track" properly forms a light but very strong carrier frame.

Out-of-Door Piling

Bales—Bags—Boxes

The combination of stability and easy portability of the piler mounted on a standard wagon frame or special steel truck makes it a great labor saver in piling bales of hay,

pulpwood, paper and pulp laps, cotton, and innumerable other such commodities in open storage. It is not uncommon for one machine to eliminate from 6 to 12 men, in addition to making much easier work for the others. By piling high and close to the receiving or shipping siding



A Type of Portable Piler

much ground space and trucking are saved. With such high piles the upper tiers are placed with practically as little labor as the lowest. Such elevators may readily be dismantled and used for inside service on the ordinary duster supports.

The straight axle carrier is best for handling bales and bags, with axle spacing of about 10 in., running at a speed of from 70 ft. to 90 ft. per min., and with a capacity of about a ton per minute. In out-of-door work over large areas gas engine drives are customary, although other forms of engines and motors, where power is available, are used. The supporting truck should have a light steel frame thoroughly braced. Many machines for this service have been made larger than was necessary, with the result that much of the advantage to be gained by portability has been lost.

High piling machines should never be moved over rough ground without having the boom lowered. If left outside regularly they should be covered with tarpaulins for protection from the weather.

Truck Loading

Miscellaneous Packages

The increasing size of motor trucks, with the correspondingly large investment represented—demanding greater speed and economy of loading—has caused the rapid recent developments in portable truck loaders. Either in loading, or operating in the reverse direction in unloading, such a machine is naturally most useful when the truck body is above the level of the ground or loading platform. The fact that on a fairly smooth surface the machine may easily be moved from one truck to another by one man is one of its big advantages. Receiving its load direct from hand trucks or conveyor, the loader saves practically all the labor of lifting. Because it is adjustable as to height of discharge it delivers packages to the different tiers as the truck or car is loaded. A projecting curve is often used at the delivery end, reaching further over into the truck. This machine is particularly useful on docks,

wharves, or in warehouses and industrial plants where loading is done from the ground. When not serving as a loader it is equally useful for the piling of commodities in storage. Because of its compact size it can be moved from floor to floor without much trouble on the average platform elevator.

For handling drums or barrels a carrier of from $\frac{3}{4}$ in. to $1\frac{1}{4}$ in. drop axles, with end rollers running on the horizontal legs of the side-truss angles, makes a rugged

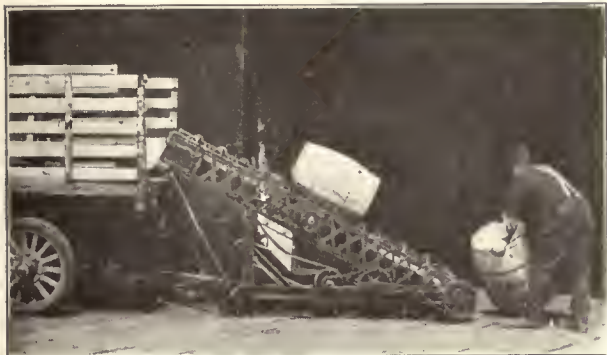

Truck Loading Made Easy

construction and forms a natural cradle for such cylindrical packages. This carrier will also elevate bags, bales, or cases, although not so well as a carrier composed of heavy wood slats with cleats. For heavy cases or drums speeds of from 30 ft. to 50 ft. per min. are usual, with maximum capacities of about one ton per minute. When such a machine is to be moved over rough surfaces out of doors 12 in. to 18 in. wheels at one end are preferable to the usual steel casters. A short section of gravity conveyor on long trucks aids materially in moving cases, boxes, etc., from the discharge end of the conveyor to the front end of the truck. Considerable manual handling can likewise be saved through loading over the side of the truck where it is convenient. For the usual car or truck loading operations a discharge height of 8 ft. is satisfactory and is the usual maximum.

Flour—Feed—Seeds—Grain

Miscellaneous Commodities

As the stationary conveyor has found a wide application through its ability to eliminate long truck hauls, so the portable sectional carrier adapts itself to similar economy in conditions requiring greater flexibility of operation.

These carriers serve the triple purpose of conveying from the barge to wharf shed, from this temporary storage to the cars, or direct from the barge to the cars. Since it is thoroughly practical to make right angle, or other turns, commodities may be conveyed to either end of the shed. The necessity for the derrick at the right may usually be avoided by providing a portable adjustable elevator conveyor which will do piling in the warehouse as well as the car loading shown.

Sections of from 10 ft. to 25 ft. in length are most common for small warehouses with posts. Longer sections are somewhat more efficient where feasible, but are harder to handle in warehouses where the posts are closely spaced. These conveyors are made with both the overhead power frame shown, and with power units under the conveyor. The latter is preferable, except for special conditions. This chain-and-axle type carrier is well adapted for outdoor service. However, when it is not to be used for long periods provision should be made for either moving the machine inside or keeping it covered to protect it from the weather.

Car Loading

Boxes

The illustration shows a very interesting application of the stationary type apron conveyor to car loading. This machine serves both as lowerer and conveyor, in that the boxes are brought from the floor above. They are diverted automatically to portable loading sections of gravity conveyor at any desired car door. Where it is not advisable to obstruct doorways these platform conveyors are suspended from above at a height sufficient to provide passage underneath. One of the most economical installations of such car-loading conveyors consists of a long conveyor, as shown, to which the packages are fed through the windows by short portable sections of gravity conveyor from storage piles inside. While the conveyor is occasionally placed in the floor of the platform at the outer edge, such a position, although it keeps the platform clearer, necessitates more lifting at the car door. Also when installed in the position shown it is an easy matter to increase the operating limits of such a layout by extending the sections of portable gravity conveyor through the cars standing on the track adjacent to the platform into other cars placed on adjoining track.

Although both steel and wood slats are commonly used, if the boxes are metal bound or have other projections such as nail heads, rounded edge steel slats make the diverting of the packages more successful. The diverter should be



Saving the Long Haul

as light and easy of adjustment as the work required will permit. The continuous angle shown, with holes for lock-

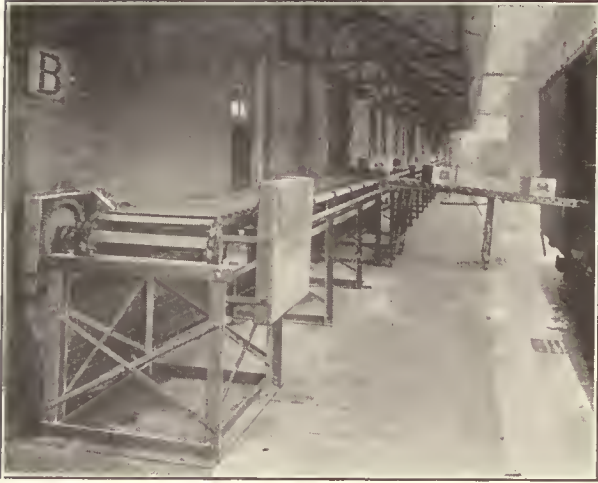

Automatic Discharge to Any Car Door

ing the inner end of the portable gravity section to it, keeps the gravity section in position as the boxes are fed onto it from the apron conveyor. Similarly, the line of steel rollers at the side facilitates the side discharge.

Fertilizers

Bags

As production organizers, apron conveyors have been successfully applied not only to continuous assembly of machines, but also to some of the simplest production operations. The sewing of bags on slowly moving aprons, which



A Work Organizer as Well as a Conveyor

at the same time are carrying the bags to storage, speeds up surprisingly the output per hour. By proper layout of the storage system these same conveyors serve to carry the reserve storage stock to shipping platforms. Portable apron pilers, which elevate the bags from these main conveyors to the temporary storage piles alongside, and later return them in loading out, add materially to the labor saving of such a system.

Wood frames are often used for this service, with steel

strips as chain guides. The tendency, however, is toward steel frames. Wood slats attached to roller chain form a very good apron. Low speeds are customary, the speed being set to suit the time required for each operation. Unless these operations have been very highly organized previously the speed of the conveyor can be set higher than would seem feasible, for the speed of the operation will almost invariably be increased with the use of the conveyor. It is not always convenient to install these conveyors in the floor, but this position is usually most economical, where possible. Such a position allows more freedom of movement about the machines.

Chemicals

Bags

In the warehousing of many commodities, particularly in connection with manufacturing plants, a large part of the tonnage handled can be placed in temporary storage close alongside lines of conveyors. These conveyors later carry it direct to cars or ships. This conserves, to a great extent, the labor of trucking over large areas. Where heavy



Combined Conveyor and Elevator

packages are handled such a conveyor should be kept as near to the floor as possible for ease of loading, and is particularly economical if built in the floor. One of the most economical of layouts consists of a long warehouse, connected at one end with packing room and at the other with shipping platform or wharf, with an apron conveyor running down the center. As combination elevators and conveyors these carriers serve a double purpose, and are not restricted by obstructions or varying elevations in floor levels.

Steel frames of four angles, as shown, with no bracing other than the vertical floor supports are good for this service. Wood slats are usual in this work. If the carrier is to serve the double purpose of both elevator and conveyor, as shown, and if the angle of incline is such that the packages tend to slide or roll back, low cleats of wood or angle iron are advisable. For handling loose bags top chain guards are advisable. If very abrasive material is to be conveyed these top guards are often extended several inches over the end of the slat better to protect the chain. Since it is not to be expected that packages will be loaded in the center of such a conveyor there should be no projection of

frame or other parts which would interfere with the occasional bag which overhangs the apron.

River Freight Miscellaneous Commodities

Many barge and boat loading operations are conducted under such continually changing conditions of water level that it is essential that any equipment used be easily port-

visible. Such a system is equally useful for the reverse operation of unloading from cars to storage or to manufacturing buildings.

An excellent apron for handling miscellaneous packages consists of wood slats securely attached to roller chain running on the horizontal legs of the side truss angles. Slats of approximately 1 in. in thickness are usual, and for portable conveyors are better than the very heavy slats often used. So much of the economy of use of portable



The Solution of a Difficult Problem

able. The sectional power conveyor not only meets this requirement, but provides the most economical method of performing such work as is shown in the photograph. As the water level raises the lower sections are removed. The reversible feature of this equipment makes it equally serviceable in either direction, packages traveling in a steady stream between boats or barges and warehouses or cars at the upper end. More actual labor, however, is conserved in unloading the boats. In such service the saving of the time of the boat is often equally as important as the actual saving of labor.

For this work light sections of from 15 ft. to 30 ft. in length are usual, several trailer sections being driven from one power section. For bags or bales a double strand of light detachable link chain propelling plain steel axles with end rollers forms a very light but sturdy carrier. Light weight is particularly essential for a portable conveyor working under such conditions, for not even the usual casters or wheels are of much advantage. In moving the sections a line of skid boards saves much manual lifting and handling. Permanent supports are better, but since they are seldom practicable, two short timbers bedded in the river bank form a satisfactory platform.

Car Loading Pails—Tubs—Cases

A common use of the portable conveyor is in the transfer of packages from continuous elevators or lowerers to various cars on the siding. With most types of packages this transfer from elevator to conveyor is easily made automatic, the package traveling continuously from the original loading point in basement or upper floor to the car door. Where more than three cars are to be loaded several portable sections placed in succession on the platform are ad-

power conveyors depends on lightness of design and simplicity of set-up that these points are vital to the success of such equipment. While there have been exceptions to



Delivering to Any Car Door

the rule, most of these machines have been heavier than was necessary. The really important idea of "maximum use of the machine" has unfortunately been submerged in a desire to make the equipment as heavy as the stationary type, where weight is a subordinate factor.

Refining Barrels—Cartons—Boxes—Bags

With aprons of special design even the most irregular of packages are handled without side guards. This makes for easier loading or unloading at any point along the con-

veyor. For the same reason it is usually advantageous to keep the carrying surface of such equipment even nearer the floor than shown in the photograph. Where such heavy packages are to be loaded down curves are advisable, as at the end of this conveyor. Similarly, other low loading points are easily provided at desired points along the floor. Passages or other obstructions also are cleared by such curves. If necessary to keep the entire floor clear and if the conveyor cannot conveniently be built into the floor, it is a simple matter to suspend the entire line from the ceiling, with down curves to the various loading points near the floor.

The standard cradle slat shown is usual for barrels or drums. If the conveyor runs up such inclines that the



Down Curves for Easy Loading

package tends to slide back an occasional cleat or straight slat should be used. Special aprons of this type are usually made of wood slats. A steel loading plate, properly placed, makes easier loading. The advantage of the steel frame is rather evident in this installation. Because of the heavy weights of the packages usually handled, low speeds of from 40 ft. to 50 ft. per min. are generally fully sufficient for the required capacity, and the low-speed apron is more satisfactory from an operating standpoint.

Canning and Packing

Cases—Cartons—Boxes—Baskets

The long apron conveyor from packing to storage room, with adjustable diverters or plows to discharge the boxes at any desired point, has a very direct application to the heavy tonnage and short working season of the canning and packing industries. Most of these conveyors serve a double purpose in that they are equally useful in loading and unloading cars and in manufacturing operations. Working in combinations as both conveyor and inclined elevator this machine is in no way limited by variations in floor levels. In fact, in plants where difficult layout conditions exist the apron conveyor not only eliminates long truck hauls and the corresponding back hauls of empty trucks, but avoids much of the confusion and aimless "wandering" so common to plants with successive departments located in different buildings.

Wood slats are usual for general canning plant service. Where packages are to be automatically diverted, as shown, however, steel slats with rounded or overlapping edges

are somewhat more satisfactory because of the sliding of the slats under the package as it is being diverted. This is particularly true where the general run of objects han-



Adjustable Diverter for Side Discharge

dled is of a very heavy or abrasive nature. Similarly, a sheet steel diverter offers less sliding friction to such packages, although the wood diverter is commonly used with satisfaction. The diverter may be hinged at the side or may slide up and down on rods. The latter type is rather more positive and easier of control. Because of the tendency to the slats to twist backward in sliding under the boxes, special care should be taken to have them securely attached to the chain, preferably with two bolts. Plow diverters are usually set at angles of from 20 deg. to 30 deg. with the center line of the conveyor.

Bottling—Dairy Plants

Cases—Trays—Bottles

The photograph shows a very complete system of slat conveyors serving a long line of machines. Not only are the individual pieces handled automatically, but both empty and filled cases and trays are conveyed from point to point

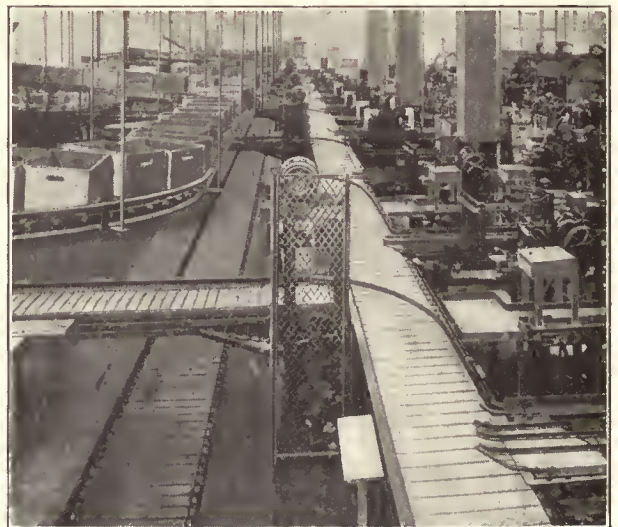

Diverting to Cross Conveyors

with a minimum of labor and confusion. The bottles as they leave the machines are made, by means of curved diverters, to travel smoothly from the main conveyor to side lines at right angles. By placing the main conveyor at a convenient height for the machines and for packing

with the secondary lines either placed in the floor or hung from overhead, there is ample space for each unit. Only such emergency aisles as are necessary for the passage of men and trucks are provided, but with such a system of positive handling there should be no necessity for irregular moving about. Arranged in less elaborate systems, such layouts have been successful in many modern dairy plants.

For diverting bottles from one apron conveyor to another the apron should be of unusually smooth surface with close-fitting slats. It is essential that the curve of the dirter be smooth, and of such shape as to divert the objects onto the cross conveyor with the least friction. A smooth plate connecting the edge of the main conveyor and the apron of the cross conveyor—over the end sprocket—is necessary. For the larger conveyors shown steel slats with roller chain are usual, while steel or malleable slats with single strand detachable chain are satisfactory for the narrower conveyors.

Marine Freight Handling

Heavy Freight

Because of its versatility and its ready adjustment to any water or deck level, the heavy-duty apron conveyor is well adapted to the handling of an extreme range of sizes and weights of packages. The long sections shown serve the double purpose of both elevating or lowering as well as conveying. They are most useful in meeting the conditions

machine that it can be easily handled. These machines approach closely the character of the adjustable ramp elevator conveyor, but are more flexible in that they are



Heavy Duty Portable Ship Loader

portable from place to place on the pier. Working from lower or upper decks of piers, such a conveyor forms the most direct connection between the pier and the changing level of the boat. The handling of both general freight and baggage is thus speeded up with the saving, not only of labor, but of the time of the vessel.

With the usual pier construction the conveyor can best be suspended from a bail attached to the frame at a convenient point with a hoisting cable or chain running through a pulley secured to the pier above. Such conveyors are occasionally handled by the ship's hoist. Frames of four steel angles, forming two thoroughly braced side trusses, and with stiff lateral bracing, are satisfactory. Wood slats with heavy duty roller chain make a good apron. Side guards are advisable, unless there is a possibility of handling packages wider than the conveyor. The large steel wheels at the center, with small casters at the end, as shown, provide a mounting which makes for easy portability.



Rapid Loading from Wharf to Ship

of high rise and fall of water level incident to river and certain tidewater ports.

A combination of flat and concave apron is good for such miscellaneous service. In this way a natural cradle is formed for cylindrical packages. Where there is any possibility of the machine operating at inclines higher than about 15 deg., occasional cleats should be provided to control the packages. Except in the longest and heaviest types of machines a frame of four angles forming two thoroughly braced side trusses is satisfactory. A light steel tower at the wharf provides the necessary support for the overhead raising and lowering mechanism. It is generally convenient to have the outer end of the conveyor rest on the deck of the vessel, thus following the latter in its up and down movement.

Ship Loading

Miscellaneous Freight and Baggage

The heavy type portable apron conveyor is used in ship loading mainly where it is convenient to so support the

Storage

Bags

The development of the automatic transfer of packages from one section to another has been largely responsible

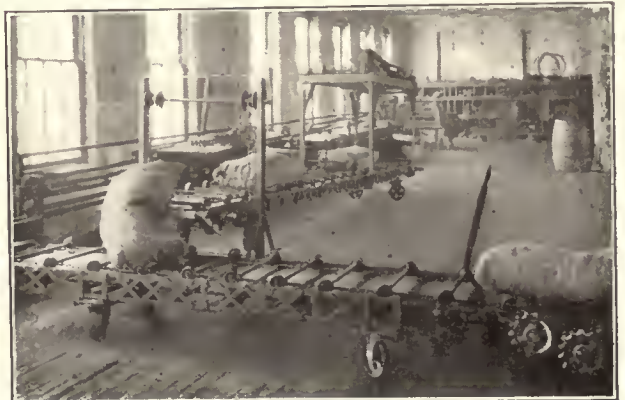

Automatic Right Angle Discharge

for the increasing use of portable conveyors. Where right or other angle turns are necessary adjustable stands for

bags, or bales, or gravity roller curves for boxes, eliminate manual handling at such points. Direct transfer in a straight line from one section to another, or from conveyor to portable elevator, as shown at the right, is even a simpler matter. Such operating improvements as these, with increasing knowledge of how and when to use the equipment, have materially broadened the field of economic application of these sectional carrier systems.

The overhead power frame shown at the far end has been commonly accepted as standard, but this type frame is gradually giving way to the more compact under-slung driving mechanism. Where the motor and reducing gearing is built under the frame the top of the conveyor is clear, and larger packages can be handled. The straight axle carrier shown, with large end rollers and light detachable chain, is best for handling bags, bales, or bundles, largely because it makes for a lighter and more readily portable machine than the apron type. The smooth steel plate under the axles serves the double purpose of tying together the two side trusses and insuring the smoother travel of loosely packed bags.

Textile Plants—Paper Making

Heavy Bales—Packing Cases

The apron conveyor, so built into the floor that the surface of the apron is flush with the floor level, has the double advantage of being easily loaded and of offering a minimum of obstruction to traffic. Men and trucks pass freely across the slow-moving apron at any point. Such



Easy Loading for Heavy Packages

conveyors are particularly economical in long storage buildings where the flow of goods is lengthwise. These conveyors are reversible and handle trucks and large gathering boxes, as well as individual packages, in either direction. By providing direct continuous connection between successive buildings or departments in manufacturing, in receiving raw materials—bales of cotton, wool, paper—or in loading cars from storage or packing rooms, this conveyor conserves manual handling.

A heavy wood apron is advisable for this work with the slats set as close as possible for the sake of safety, as well as to prevent floor refuse from falling between the slats. Hardwood slats with heavy duty roller chain are usual, running in a steel frame. The edge of the floor opening should be smooth and should fit close to the ends of the

slats. Removable floor plates at either side are desirable to make easy access to the conveyor. To guard against the decided tendency to neglect equipment in such a position, there should be a regular schedule of cleaning and oiling.

Metal Products

Continuous Assembly

One of the most successful developments in recent years in the use of apron conveyors has been in the continuous assembly and inspection of machines and other metal prod-



A Production Organizer

ucts. While the larger pieces occasionally require special carriages or aprons, the standard slat conveyor is well adapted to the general run of smaller objects. Its rugged construction permits fairly rough handling, and its continuous platform allows pieces to be moved about as necessary. The slow but certain movement of the work in process on the apron has an organizing influence on production which insures the success of this method, not only in mass production, but in plants of comparatively small output as well. Usually this indirect economic effect of speeding up production is even greater than the actual labor saving of conveying from one operation to another.

A carrier of close-set hardwood slats, securely attached to roller chain running in the side angles forming the frame, is satisfactory. Steel slats are also much used, particularly where the service is apt to be unusually severe. Special attention should be given to designing the equipment so that the height of the carrier surface above the floor is that most convenient for the workmen. This, of course, depends entirely upon the size of the piece in process. Even at the best height it is often necessary that certain men performing certain operations stand higher than the others. Very low speeds are usual on such installations, depending on the time required to perform the individual operation. Convenient control points for starting or stopping the conveyor are advisable, particularly if it is necessary to have intermittent movement. The gear guards shown are excellent examples of this very necessary feature. Wire guards, however, are more commonly used.

Warehousing

The high-type apron of the portable sectional conveyor makes it possible to handle packages much wider than the apron itself. This advantage makes it particularly adaptable to the carrying of miscellaneous freight. With the power and speed reducing mechanism placed under the conveyor,

as shown, no obstruction is offered to even the largest packages. The comparatively light weight of these conveyors, particularly of the trailer sections, and the ease with which one section may be connected to another, make them economical in many places where heavy and unwieldy machinery would never be used. By keeping the height of the apron close to the floor packages are easily loaded or unloaded at any point.

Wood slats with 3 in. end rollers, all propelled by a double strand of light detachable link chain, make a very light but strong apron for this type machine. The power section shown drives, in either direction, from one to four trailer sections by means of short removable drive chains, covered by the guards. The curved section shown has the advantage of having both ends of the same height as the trailer sections, so that it is readily attached to them at either end. By using internal or other reducing gears, much of the mechanism shown is eliminated, resulting in a

simpler and lighter construction. Because easy portability is such an important feature, the best casters made are de-

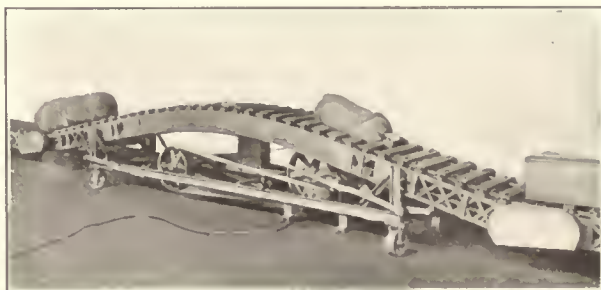

Driving Mechanism Offers No Obstruction to Packages

sirable for mounting of conveyor sections. For service over rough floors larger casters or steel wheels are best.

Belt Conveyors and Elevators

The adaptability of the belt conveyor and elevator to package handling has materially increased with the making of stronger and more lasting belts. To the natural advantages of this carrier have thus been added the capacity for handling, on the better grades of belt, packages of such weight and character as have generally been considered outside the scope of belt conveying.

The smooth and noiseless operation of this equipment, its capacity for carrying packages in opposite directions simultaneously, and the ease with which packages may be diverted from the side at any point, make it adaptable to many plant conditions in which no other conveyor would be satisfactory. It operates more efficiently at high speeds than any other continuous carrier, and has a correspondingly large capacity. The continuous surface of the belt adapts it to packages of even the smallest size and likewise prevents dirt or other foreign matter from falling through. By running the carrying and return belts close together the conveyor may be installed in a small space and be made to pass through small wall openings. This results in a neat appearance.

In department stores, as well as in mail order and wholesale supply houses, the noiseless operation, cleanliness and neat appearance of the belt conveyor are big factors accounting for its extensive use in the dispatching of outgoing goods. In manufacturing plants, where goods in process are handled in trays or tote boxes, the two-way capacity of this conveyor is used to good advantage in returning the empty containers on the return side of the same belt on which the filled containers are carried. The facility with which packages are automatically transferred from one conveyor to another makes this type conveyor particularly adapted to the most difficult production layouts. In plants where fragile products are handled, such as glass and china, the smooth travel of the belt makes it possible to handle packages which could not be carried on any other conveyor. In laundries, baking, confectionery and food plants and specialty manufacturing where there is extensive sorting, wrapping and packing of small pieces the belt conveyor serves as a most efficient work table.

As an elevator the smooth travel of the belt, particularly when designed with supporting rollers set close together, makes it practicable to elevate many packages and at such angles as would not be feasible with other inclined elevators. With the best grades of belt it is practicable to se-

curly attach to the belt cleats or arms of such height and rigidity as to carry fairly heavy packages up inclines almost vertical. The use of the belt elevator has been much extended in recent years through the employment of stronger belts and improvements in automatic loading and control. As a lowerer this machine has a limited but very useful application at inclines up to about 25 deg., particularly in its two-way capacity of returning empty boxes which have previously been elevated on the opposite run of the same belt.

The light weight of the portable belt conveyor has been the chief reason for the tremendous development of these machines within the past few years. The ease of movement from place to place more than offsets the fact that the belt carrier has a shorter useful life than the apron and chain type of carrier. Obviously it is not so well adapted to the handling of heavy and miscellaneous freight as the latter conveyor. However, the range of usefulness and the wearing qualities of the well-constructed belt machine are surprising. As with portable apron conveyors, the efficiency of the sectional belt conveyor or piler depends to an unusual extent upon the intelligent application of the equipment to its purpose. The automatic transfer of packages from one section to another, and from conveyor section to piler, reduces to a minimum the manual handling of commodities between cars, ships, or trucks and storage. These portable machines carry their own motors or engines within their frame, and for this reason are easily moved about to meet changing operating conditions.

As portable pilers or elevators these machines pick up their loads almost from the ground level, thus saving labor in loading. By reason of the adjustable discharge height packages are delivered to any level within the maximum range of the machine. These machines have been built with piling heights as great as 30 ft., although this is rather uncommon. Very good advantage has been taken of this adjustable discharge height in the loading of ships, barges, or boats, where the rise and fall of the vessel is followed by the carrier boom. The direction of travel of the belt is reversible so that the machine is equally useful working in either direction. As floor-to-floor machines discharging through holes in the upper floors, or through convenient windows, these elevators provide a most direct route between cars and upper storage floors of the lower warehouse buildings. Much attention has been paid in designing these

machines to securing compactness, with the result that they will operate in surprisingly small spaces and narrow aisles.

General Specifications

Frame. For heavy duty, belt conveyor-elevator frames of wood or of steel angles are usual. Steel frames are stronger, neater in appearance, and more generally satisfactory than the wood; they are easier of erection and more permanent in alignment than wood frames. Many light duty belt conveyors are built without frames, the idlers being carried on floor stands bolted to the floor.

Curves or Goose Necks. Because of the tension on the belt it tends to pull up and away from the rollers at the up-curves. To prevent this, top guides are advisable. For sharp up-curves, steel or other cross-cleats, riveted to the belt and running under narrow side-guides at the curve, hold the belt down satisfactorily. In addition these cleats serve the double purpose of preventing the sliding of the package on the incline. With very stiff belts and a curve of large radius, the belt may be held down merely by passing the edges of the belt itself under the side guards. Another good method of making an upward curve, or break in direction, of the belt is to pass the belt around three idler pulleys at the start of the incline. Down curves of almost any angle are easily affected, since both top and bottom belts hold to their supporting idlers in curving downward.

Belt. While the choice of belt is largely dependent on the character of the packages to be handled, atmospheric, chemical, or other condition affecting the life, stretch, and general operating efficiency of the belt, are equally important factors. For light duty, plain cotton woven belt gives fair service under dry and otherwise favorable conditions. If such belts are impregnated with a good preservative compound, they are usually more satisfactory. Rubber-covered fabric belts are better for ordinary service, and have less stretch than the woven belts. Stitched canvas belts, impregnated with such gum or other compounds as will not become stiff or crack, are best for all-round service, particularly for long conveyors, damp conditions, or severe service. Balata and other special belts are little used for package conveying, mainly because their higher cost is seldom warranted by the work to be done. For elevators, especially those running at high inclines and with high cleats or arms, belts should be stiffer and stronger than for corresponding conveyor service, because of the tendency of the arm rivets to pull out under the cantilevered load on the arms.

Flexible steel belts have been used to a limited extent in European countries. While requiring larger end drums than the fabric belts, they have the advantage of requiring fewer idlers and less driving power. Because of the very smooth surface of these belts, packages are easily diverted from them.

Idlers or Rollers. Both wood and steel idlers of from 2½ in. to 5 in. diameter are commonly used. If of wood, only straight grain hardwood should be used. Rollers may be of either stud or through shaft construction. The spacing of the idlers varies from 6 in. for the heavier freight service to 48 in., center-to-center, for such light duty as department store parcels. Light belts require closer idler spacing than the heavier and stiffer belts. Return idlers are usually spaced from 4 ft. to 8 ft. centers. Instead of rollers for supporting the belt, smooth slide plates or even boards are occasionally used in the lightest service.

Idler Bearings. For package conveying, straight,

single-roller idlers are almost invariably used, although some conveyors are built with idlers composed of several short rollers on one shaft. Plain pillow block bearings are usual for the heaviest service, although the oil impregnated maple bearing in a cast iron box is satisfactory for even fairly heavy duty. This latter type is commonly known as an oilless bearing, because of the fact that the bearing, when thoroughly impregnated with oil, requires no oiling for long periods. Flanged bearings attached to the side-boards are much used. The self-aligning feature of the more highly developed bearings is advantageous. Ball bearings and other special types are sometimes used. Under dirty or dusty conditions special care should be given to making the bearings dust-proof. Where grease or oil cups are used they should be readily accessible for regular attention.

Side-Guards. High side-guards are seldom necessary, except for handling cylindrical packages, or for the sake of safety in certain overhead installations. They are decidedly objectionable when packages are to be constantly handled on or off the belts at numerous points along the conveyor, as in the operations of wrapping, sorting, or otherwise using the conveyor as a work table. When flanged idler bearings are used, side-guards are conveniently formed by having the supporting wood or steel boards extend several inches above the top belt. Similarly, with the proper arrangement of the idlers, the supporting members of structural steel frames may be built to serve the same purpose. Where branch conveyors discharge at right angles to a trunk conveyor, and the usual 2 in. to 5 in. guards are used, it is advisable to provide baffle plates on the guards opposite these transfer points.

Loading. A solid sheet-steel plate set close under the belt at such loading points as can be predetermined relieves the belt of much of the shock and strain of careless hand loading. Such plates are especially desirable where packages are discharged to the conveyor from other conveyors or from chutes. Where chutes discharge to belts the speed of the package should be somewhere near that of the belt, to avoid any unnecessary dragging effect on the latter. The proper loading heights of belt conveyors should be studied much more carefully than would at first seem necessary. This is particularly important where the conveyor is used as a work table or serves operators or machines alongside.

Discharge. End discharge is usual, and may be made over the actual end drum, or over an intermediate "end" formed by turning the belt sharply down over an idler sufficiently to allow the package to discharge to a table or chute, after which the belt may be returned to its original level. Provision should be made to insure each package leaving the end of the belt properly. Long sloping tables or sections of gravity conveyors are satisfactory for this purpose. End discharge at right angles to other conveyors is common. In this case the discharging belt should be slightly above the other at this point, with a short connecting slide plate. The basic principles of side diverting are that the friction between belt and package be not excessive and the angle of the diverter such that the minimum of dragging results. Angles of from 20 deg. to 30 deg. with the belt, with straight or curved arms, are usual. Many methods of intermediate side diverting are in use, from the simple sweep diverter set in place by hand, to the wholly automatic systems controlled from the point of dispatch. In addition to the many types of sweeps operated by hand, several types of automatic diverter arms are in use for filling "storage stations." Another automatic method is

the selective system in which pins or other devices are set in the container by the dispatcher. Slots or other corresponding devices on the fixed arms at the various diverting points engage the proper pins on the box and divert it to the side.

Drive and Take-Up. Wood, iron or steel drums, plain or lagged as necessary to insure proper friction, are usual for driving belt conveyors or elevators. Where the pull on the belt is excessive a greater tractive effect of the drum on the belt is obtained by increasing the contact arc either with idlers or double drum drives. Standard worm, spur, or internal gear speed reductions are usual. Spur gears are most generally in use. The belt conveyor is thoroughly effective driven from either end, for all ordinary lengths. Plain screw take-ups are most common, running in horizontal guides. They should be easily adjusted to maintain the belt at the proper tension, but must keep their position when set. Where it is desirable to secure a stationary position of the drum at the take-up end, weighted take-ups with vertical movement are preferable. These produce a more even tension on the belt, particularly where there is much expansion or shrinkage of the belt.

Cleats or Arms. Cleats of any kind should be securely riveted to the belt with broad flat head rivets or bolts. In elevators working at the higher angles, and with correspondingly high arms, a thin reinforcing strip on the underside of the belt is often advisable to guard against the pulling out of the rivets or bolts. Such long cantilever arms have a strong tendency to turn back under the load, and cause a high strain at the upper point of connection to the belt.

Speeds. Belt speeds vary from as low as 2 ft. per min. for special manufacturing purposes, to as high as 200 ft. per min., and even higher, for special conditions. The most common speed for general package handling is probably 100 ft. per min. Where belt conveyors are designed to serve operators or machines, and thus act as production organizers, the speed of the belt should be studied with special care in each operation because of the effect on the plant output. The tension of fully loaded belts running at very slow speeds should be more carefully studied than that of the same belt running at the ordinary speed.

Special Features of Portable Elevators and Conveyors

Elevator Base Frames. An excellent base frame is made of 3 in., 4 in., or 5 in. steel channels, strongly braced. Base frames of steel pipe or angles are largely used and are satisfactory. Special attention should be given to making the base frame as short as the overhang of the carrier will allow. Similarly the width should not be greater than necessary to insure stability of the piler with the boom raised. In brief, the entire machine should be as compact as possible because of the prime importance of saving floor space.

Carrier Frame. For either conveyors or elevators four light angles formed into two side trusses and thoroughly cross-braced between the belts, make a very stiff carrier frame. Two channels or angles in place of the two side trusses are also good, but are not so stiff for their weight as the trusses. They afford a simple frame, however, and a somewhat better support for the belt roller bearings.

Elevator Raising Device. The raising mechanism of the carrier boom should preferably be kept wholly under the boom, if the machine is to be moved through ordinary

doors. This position, while not essential, results in a neater and more stable machine. Keeping the top of the carrier clear also makes it possible to more easily handle bulky packages wider than the machine itself. Small hand drums for raising the boom by hand, located on the side of the carrier, are best for piling heights up to about 12 ft. For larger machines the saving in labor of adjusting the boom to suit the varying piling levels warrants the connection of the raising drum with the motor.

Drive and Take-Up. Light weight is such a prime factor in a machine whose economy depends so much on easy portability, that unusual consideration should be given to eliminating every pound of unnecessary weight in the drive. For this reason, direct-connected internal-gear reductions are excellent, although light belt drives are probably more generally used at present. To allow for the adjustment of the boom the belt is most conveniently driven from the foot end, the carrier frame being pivoted in trunnions at this end. The carrier should be readily reversible in direction of motion.

Casters and Wheels. For fairly smooth floors, 8 in. to 12 in. casters are best for machines supported at four points. For rough floors or outdoor work, steel wheels of from 18 in. to 36 in. are much better, with proper fifth wheel provision for turning the machine. While the two-wheel machines frequently used do not pile at such high inclines as the more stable four-wheel type, they are more easily moved and usually somewhat lighter. Since the utility of portable machines depends so greatly upon their being readily moved from one position to another, the importance of providing the highest grade casters with the best ball-bearing swivel joints and wheels with roller bearings is obvious.

Loading. It is highly important that the loading point of portable pilers or truck loaders be kept as close to the ground as the minimum size of the lower end pulley and proper clearance for the cleats or arms will allow. This will be found to save a great amount of manual lifting.

Operation

The belt conveyor-elevator, properly applied and installed, usually requires less attention than any other continuous power carrier. This is particularly true when it is equipped with self-oiling bearings, or ball bearings. With babbitted or other bearings requiring lubrication there should be a definite schedule of attention, rather than the ordinary intermittent attention often given such equipment. Particularly in moist or changing atmospheric conditions it is essential that the belt be maintained at the proper tension by regular adjustment of the take-up, unless the latter is of an equalizing design. Where the conveyor is to be reversed in direction or stopped and started frequently, push-button motor control from convenient points will greatly improve the operating efficiency. In using belt conveyors, especially in handling miscellaneous freight, it should be remembered that the belt conveyor is not such a carry-all as the apron and chain carrier, and only those packages should be handled for which it is designed.

Careless loading has probably caused more wear and tear on package handling belts than any other single feature of their operation. Where rough packages, such as packing cases, are to be loaded, either a loading plate should be placed close under the belt at definite points, or the impact of the package should be taken by loading guards or fingers. Another cause of wear

on the belt arises from diverting from the belt packages of a rough or abrasive character. To reduce this wear to a minimum requires careful study of the proper angle at which the diverter should be set. Where chutes of any type discharge to belt conveyors, not only the speed but also the direction of discharge should be as near as possible that of the belt.

As with portable equipment of the apron and chain type, the operation of sectional belt conveyors and elevators depends far more upon a thorough knowledge of the possibilities of each machine than upon its mechanical features. Even where only one machine is in operation there should be one man intelligently trained in its use. He need not be a mechanic, for the mechanical handling of this equipment is simple. Such a trained man will frequently find even more economical uses for the machine than it was originally designed to fill. In short, by knowing what has been done with these machines under conditions similar to his, his constructive imagination is constantly brought to bear upon the changing handling problems in the plant.

In applying such portable conveyors to old warehousing or manufacturing conditions, it is often found to be worth while to change aisle or storage layouts as well as routes of travel. In those plants in which such equipment has been most successful, practically all of these points of operation have been carefully considered in designing and using the equipment.

Car Loading

Bags—Miscellaneous Packages

The use of belt conveyors for car loading has rapidly advanced with the better organization of this operation. The greatest savings occur when the finished product can be loaded direct from the packer to the car, or from temporary storage along the path of the belt.

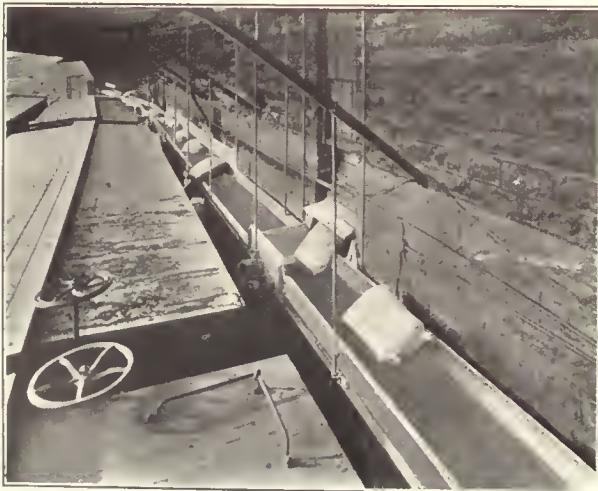

Automatic Discharge from Packer to Any Car

The employment of this arrangement of temporary storage has eliminated one of the greatest obstacles to the successful use of conveyors in the loading of cars. Obviously, however, it is impossible to make use of this system when the product must be stored indefinitely, but a surprisingly large proportion of the output of the average plant may be thus placed temporarily near the conveyor. The necessity of trucking

out over large areas, and the later back haul to the car, is thereby eliminated. The easily reversible travel direction of the belt makes it particularly applicable for serving a long line of cars on a siding.

In such a car-loading system adjustable diverters, controlled usually by the man in the car, discharge the package to light portable chutes leading into the car. In general the greatest economy results from installing the conveyors about as shown. In this way the doors and platform below are kept clear, a minimum of space is taken up, the belt is better protected from the weather, and the elevation is such that the packages will slide to any point in the car. It is particularly important that a belt operating out-of-doors in this way should be impervious to weather conditions and have a minimum of stretch.

Publishing

Bundles of Papers—Books—Magazines

The ease of transfer of packages from one conveyor to another makes it feasible to fit connecting conveyors into almost any plant layout. This transfer, while commonly made at right angles, is thoroughly satisfactory at any angle. A system of this sort frequently met with consists of a number of branch lines which discharge to or receive from one trunk conveyor. Many



Right Angle Transfer from Belt to Belt

ingenious timing devices have been developed to prevent congestion between packages at the entrance of branch lines; however, if the trunk belt is made of sufficient width the necessity for these is avoided. The transfer is in no way limited to being made from one belt to another, and a very common use of this feature is in transferring packages from a gravity conveyor to the belt conveyor.

Where there are fairly large boxes entering a trunk conveyor from many points along the side, a power-driven timing device, to deliver the package to the trunk at the right time, is the most positive and satisfactory arrangement to prevent congestion. Such a device is almost always essential when the delivery is made from a gravity conveyor. When it is advisable to place the take-up end of the delivering conveyor at the delivery point the take-up should be of a vertical, instead of the usual horizontal movement of the end

pulley. The horizontal movement would disturb the proper transfer. A slide plate to fill the opening between the end pulley of the branch conveyor and the belt of the trunk is usually necessary. For better operation the level of the former conveyor should be several inches above that of the trunk conveyor.

Weighing on Conveyors

Miscellaneous Packages

In receiving and shipping raw materials or finished products the practice of weighing each package as it passes over a scale section accomplishes not only a saving in the time of weighing each package, but provides a better record of the weight. Obviously this automatic method is not so accurate as the usual individual weighing operation. However, with belt conveyors, as well as with the roller gravity conveyor in which this method of weighing is so often used, the elimination of the manual handling of each package more than offsets any slight inaccuracy involved. Because of the light weight of the moving belt and the general smoothness of operation, the belt conveyor is



Weighing in Transit

well adapted to automatic weighing. Not only in loading in or out, but in many manufacturing operations this method of weighing eliminates the necessity of the man at the scale and results in better organization of production processes.

Since more accurate records result from a very slow movement of the package over the scale section, the speed of the belt should be as low as will give the required capacity. The scale section should be as free as possible from the fixed sections preceding and following it. Clearly it is essential, for the greatest accuracy, that the packages be dispatched at sufficient intervals to insure each load registering separately in passing over the scale section.

Nitrates—Sugar—Coffee—Grain

Bags—Boxes—Miscellaneous Packages

Mainly because of its light weight and easy portability the use of the belt truck loader or outdoor piler has increased rapidly within the past five years. When equipped with high grade stitched canvas or rubber fabric belts this elevator gives excellent service for handling packages weighing up to 200 lb. or 300 lb. The adjustable feature of the belt boom with discharge at any desired height saves practically all manual lifting by placing the package on the truck or pile at the

proper level. Since the direction of travel of the belt is readily reversible trucks are also unloaded and piles "broken down" with the same machine. This is one of the most versatile of all elevator-conveyors. In addition to serving as both outdoor and indoor piler and truck loader, the same machine, properly equipped

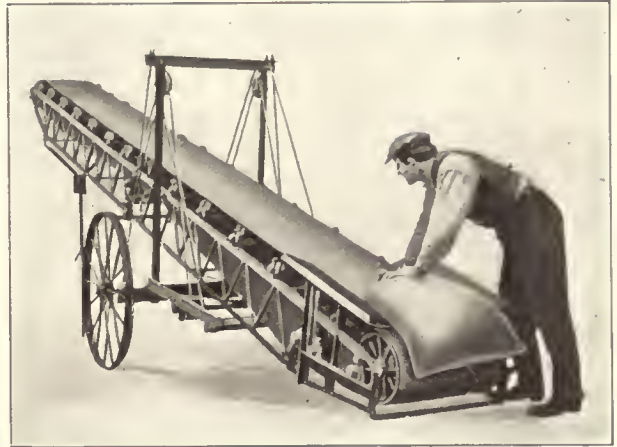

Portable Belt Conveyor with Adjustable Angle

with side-guards or troughing rollers, handles coal, sand, stone, and other loose material with equal satisfaction.

For outdoor service the large wheels shown in the photograph afford easy moving from place to place, and for this reason are better than small wheels or the four casters so often used on indoor pilers. The very compact drive shown has several advantages, probably the most important of which is its light weight. For loading from wagons or four-wheel warehouse trucks the height of the loading point shown is about right. For heavier packages, however, which are to be loaded from the ground, as from two-wheel hand trucks, the height of loading should be as low as the minimum size of the end pulley will permit. If the machine is to pass doorways of ordinary height care should be taken to provide a collapsible raising frame or this frame should be placed under the carrier frame.

Textiles

Boxes—Baskets—Tote-Boxes

There is no industry to which the belt conveyor is more applicable than to the manufacturing departments of textile mills. From picker room to weave room, this conveyor distributes laps, boxes or baskets of bobbins, or textile products in process. One of the most common and economical of its applications is the distribution of bobbins from roving frames to spinning frames on the same or lower floors. The belt conveyors receive the containers filled with bobbins from spiral chutes, and distribute them to the various storage stations near the frames. Later the empty boxes travel back on the return side of the same conveyor and up automatic elevators to the roving rooms above. This two-way capacity of the belt conveyor is equally valuable in the handling of goods in process in finishing plants, and other textile operations. They not only eliminate trucking and confusion, but are of distinct value as organizers of the entire operation of the finishing, as well as spinning operations. The small space

required by the belt conveyor, especially when it is suspended from the ceiling, and its simplicity of installation, make the machine fully as economical in its application to existing plants as in new mills. For this reason the number of individual conveyors installed



Two-way Belts with Diverters

in old mills has been even greater than in the new ones.

Storage stations located at convenient points increase the usefulness of the belt conveyor by reducing the amount of attention required. Switches divert the filled boxes to these stations until the station is full. Succeeding boxes then pass on to the next station, and so on. In this way all the stations are kept filled. The floor porters remove the boxes from the stations and distribute them to the frames, and then return the empties to the lower run of the belt.

Hardware—Stampings—Novelties

Tote-Boxes—Individual Pieces

The ease with which containers filled with small parts may be diverted from one conveyor to another makes the belt conveyor adaptable to the handling of small parts. From the use of selective switching systems results the entirely automatic dispatch from one machine operation to another. This is particularly valuable in congested plants. When their load is discharged the empty containers may be returned either on the return side of the belt or on other conveyors. Such conveying systems are more than carriers—in effect they are production organizers and speed up the output of every operator and machine which they serve.

The simplest switching device for discharging packages to the side at any desired point is the sweep diverter. This "sweep" should be set at such an angle, usually about 20 deg. with the line of travel of the belt, as to divert the package with a minimum of effort or friction on the belt. Obviously the bottom of the package or container should never be so rough as to cause unreasonable wear and tear on the belt. On the principle of this simple diverter many adjustable switching devices have been developed, most of which are operated by hand.

Automatic diverters are of two general classes. In one the entire diverter moves in and out of position. In the other, the selective type, each diverter is fixed in position and is so set as to engage a switching pin set at a certain

point on the tray or tote-box. The dispatcher sets this switching pin at the proper point and height on the box, and the box, when it reaches the diverter set to correspond



Automatic Selective Switching

with it, automatically leaves the belt as the pin engages the diverter arm.

Metal Products

Trays—Tote-Boxes

Gravity roller storage stations set into lines of belt conveyor make the latter more flexible in use by temporarily stopping packages at certain points. With such an arrange-



Gravity Roller Storage Station

ment the operator at each machine has a constant supply of parts at his elbow. When the storage section at one machine is full the trays proceed to pass on to the machines beyond. It is not necessary that separate belt conveyors be used between the various stations. By passing the top run of belt over end idler and under the gravity section at each station one continuous belt can be made to serve the entire line.

Where the packages handled are wider than the carrying belt, temporary storage stations are sometimes made by setting rollers at both sides and slightly above the belt. When the package passes onto these rollers it stops until the succeeding packages push it on. This gives the floor man or operator at each station time to take such articles as he needs from the station. A satisfactory storage station also is formed by diverting the packages to gravity conveyor or chutes at the side. However, this is not quite so positive or direct a method as the first two described. Obviously this system of using storage stations applies only to such packages as are firm and rigid enough to divert in a proper manner or push each other across the station.

Rubber Goods

Small Pieces—Tote-Boxes—Baskets

In recent years, the use of the belt conveyor has been one of the factors resulting in the better production organization of many plants manufacturing rubber specialties. Departments in which machines or operators are served by these continuous carriers are conspicuous for their efficiency and for the absence of the confusion ordinarily incident to the moving about of trucks or porters. The illustration shows a combination conveyor and elevator receiving from a number of machines, and divided into two "lanes" by a middle partition. Single belt conveyors are often divided by a number of such partitions for the better separation and distribution of different classes of products. Each of these "lanes" may be discharged at a different point in order to accommodate the various wrappers or packers.

For such partitions, either wood or sheet steel strips are satisfactory, but in either case care should be taken in supporting them to avoid any possibility of the bottom edge of the strip sagging and cutting the surface of the moving belt. The speed at which the belt should be operated de-

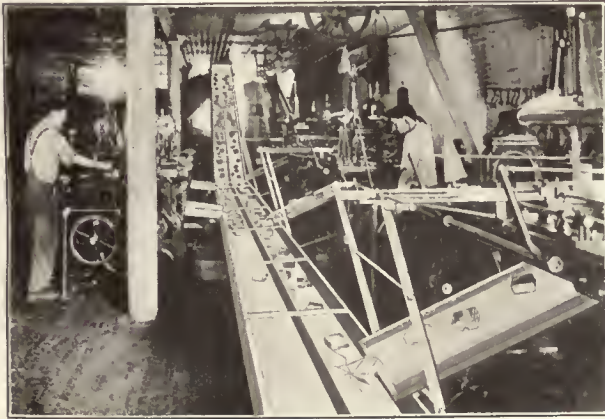

Divided Belts Simplify Distribution

depends on the capacity required, and the rapidity with which the pieces or trays can be handled at the receiving points. Where one continuous belt is used as both conveyor and elevator, in making the up-curve from conveyor to elevator either top guides must be provided at the sides to hold down the top run of belt, or the direction of this top belt should be changed by running it around three idlers placed at the end of the level portion. The maximum incline at which ordinary packages will travel up a belt elevator without cleats is about 20 deg., although where there is

high friction between package and belt incline, as high as 25 deg. to 30 deg. are practicable.

Confectionery

Cartons—Boxes—Bags

No industrial operation lends itself more readily to the economical use of belt conveyors than wrapping and packing of all classes of confectionery and bakery goods and similar commodities. Not only is much of the actual labor and



Moving Work Table Increases Production

time of bringing up the piece goods and carrying away the packages saved, but the entire operation is better organized and a superior grade of work accomplished. Where it is advisable to bring the pieces to the packers in containers, the empty containers may be returned on the lower run of the same belt. The photograph shows an interesting confectionery wrapping system, in which the use of the belt conveyor eliminates the needless moving about and confusion so common to many such departments.

For the handling of such light packages the conveyor may well be very light. However, it is not real economy to use an extremely light belt, because of its continual stretch and generally unsatisfactory operation. Since the continuous movement of the belt so often exerts an important influence in speeding up production, the question of the proper speed at which the conveyor shall work should be studied with more care than would ordinarily seem necessary. Side-guards are usually not necessary, but where it is considered advisable to provide them, they should be kept low, to facilitate the continual handling of packages on and off the conveyor. The proper height of the conveying surface with relation to the operator is a matter for each individual installation, and, as such, is an important factor in the economical and efficient operation of the system.

**Wrapping—Packing—Shipping
Trays**

The two-way service of the belt conveyor in carrying filled containers in one direction and returning the empties on the opposite run of the same belt, makes it more adaptable than any other conveyor to the handling of books, pamphlets, magazines and other publishing plant products. Tray, tote-boxes and baskets, as well as individual pieces, move from one machine to another, or from machines to wrapping rooms with complete elimination of manual labor, even in the return of the empty containers. By this system

the conveyor replaces the intermittent haulage of trucks or porters, and numbers of small articles are continuously handled in lots of convenient size, with a resulting better organization in production. As in the shipping of mail or express orders in wholesale supply and distributing houses, the use of gathering boxes or baskets, handled on these two-way conveyors, is fast increasing with the more general knowledge of the success of this method.

Whether the top or bottom run of the belt is selected for the filled boxes depends on the relative ease of loading and



Two-way Belt Prevents Congestion

unloading. The photograph shows the end discharge of the filled trays from the lower run of the belt to a table of convenient height. To accomplish this discharge a short section of the belt is run under the table. The empty trays, which are much lighter, are more easily lifted to the top run of the belt for returning. With very light packages the discharge is often made to the side by a diverter. Although the conveyor will not be immediately stopped by the blocking of such light packages, this should be avoided mainly because of the wear on the belt.

Refining—Soaps—Oils—Greases

Boxes—Cartons

The portable, sectional belt conveyor is well adapted to such warehousing conditions as shown in the photograph,



Quick Loading of Trucks and Cars

where the floor surface is reasonably smooth and a fairly uniform range of packages is to be handled. In this service

such conveyors not only save long truck hauls and the corresponding back haul of empty trucks, but often make the greater saving of eliminating the idle time of waiting auto trucks. Since these conveyors are reversible in direction of motion, they are equally as useful in receiving, as in loading out, commodities. The adjustable end section increases the efficiency of the machine by delivering the packages to truck, car, or barge at such heights as to avoid practically all the labor of lifting. One of the most effective uses of such readily portable machines is in operating through windows or convenient small openings cut in the walls of buildings. Such a method of handling has been found so economical in some warehouses as to warrant the changing of the aisle layouts to make the conveyor more useful.

Where sectional conveyors are to be moved from aisle to aisle, the sections should not be over 20 ft. long, or if the aisles are narrow, not over 15 ft., or sometimes as short as 10 ft. An economical arrangement results from placing several long, and comparatively inexpensive, trailer sections in each aisle, and providing one short and easily maneuvered power section. This layout necessitates a minimum of changing of the lines. Mechanically, a portable sectional conveyor is extremely simple and requires very little attention, but the importance of having one man in charge of its operation who is thoroughly instructed in its possibilities, cannot be stressed too strongly. With a properly instructed man in charge of its operation new and economical applications of these machines will be developed frequently, thus insuring the maximum utilization of the device.

Ship Loading

Bags—Miscellaneous Light Packages

The portable belt conveyor, largely because of its light weight, has been successfully applied to the loading of ships with such commodities as grain and flour in bags. It is equally useful for handling almost any of the lighter freight

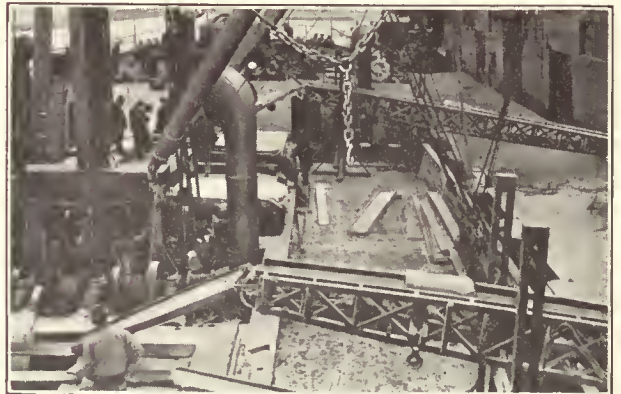

Reducing Ship Turn-Around Period

packages. The ease with which the machine may be moved about the dock from one hatch or ship to another is surprising. Since the angle of incline naturally follows the rise and fall of the ship, the operation of the loader is not affected by the changes in the deck level. Such loaders are fed either from trucks brought up to the dock end or by connecting portable conveyors from cars or storage piles in the pier shed. They may be placed in position on the deck by the ship's boom, or, when equipped with independent base frame and raising device, their carrier booms may be elevated by their own power. Thus equipped they are

used also as pilers on the dock. Where the boat hatches are of the usual size, the operation of these machines, with the chutes running into the ship's hold, does not prevent the simultaneous loading by the ship's hoist of larger packages, through the same hatch.

Since the very nature of the carrying surface of the belt conveyor limits it to fairly light packages, the entire machine should be designed to be of correspondingly light weight. The frames of most of such portable conveyors are made heavier than is advisable for their most efficient use. The controlling consideration in the design of such machines should be that it is better economy to have them light enough to insure their constant use, even at the risk of losing some of the long life which might result from a heavier, clumsier machine. A strong bail with hook should be provided, securely attached to the conveyor frame, for the attachment of the hoist cable, in lifting the section.

Storage—Warehousing
Boxes—Bags—Cartons

The light weight of the belt piler and sectional conveyor has made these machines economical in many storage houses in which heavier, and less portable, machines would not be used to advantage. Special attention has been given in their design to providing for quick "set-up" in any position. While this equipment is obviously not adapted to heavy



Automatic Transfer from Conveyor to Piler

freight, or to packages of rough character, a good grade of belt will give surprisingly long service under average conditions. Pilers of this type occupy comparatively small floor space, particularly when operating at their maximum inclines of from 35 deg.—with cubical boxes—to 60 deg. in handling bags. With high cleats or arms even higher inclines are feasible for reasonably light packages. The transfer of packages from conveyor to piler is automatic at inclines as high as 30 deg. to 45 deg., so that in loading in from cars or trucks no manual handling is required. Both piler and conveyor are reversible in direction of motion. Where the warehouse layout requires right angle or other turns, as from platform to interior aisles, these turns are accomplished automatically.

Either light channel frames, or side trusses built of small angles, form good frames. The trusses afford a somewhat stiffer carrier frame, with the same weight, than the channels. When conveyors and pilers are operated together as shown, they should be securely tied together by adjustable yokes over the end shaft trunnions. The sec-

tions of conveyor are driven from the piler by removable drive chains connecting the adjacent end shafts. Because easy portability is so essential in these machines, to insure their maximum use the best ball or roller bearing casters or wheels should be used. With fairly smooth floors it is not necessary to disconnect the sections in a line, in making small changes in position, since the line of several sections can be more readily shifted as a whole.

Boosters

Miscellaneous Packages

The advantage of the belt conveyor as a booster in a long line of gravity conveyor lies mainly in the simplicity of installation and operation, and in the fact that it receives,

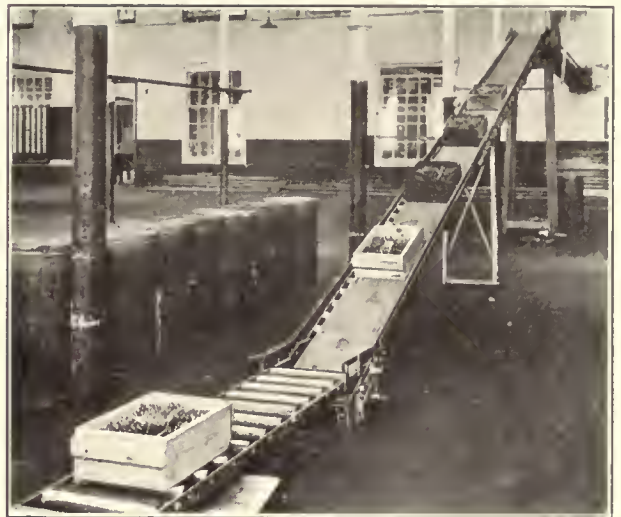

A Belt Section Serves as a Booster

carries, and discharges the most fragile packages noiselessly and with the greatest safety. The picture shows a good arrangement of such a booster. The additional head given to the package by this boosting makes it possible to carry it for long distances on the gravity conveyor. In many cases these machines, in place of being supported by floor supports, are hung by hangers from the ceiling to save working floor space beneath them. Portable boosters, in connection with portable gravity conveyors, are efficient when mounted on smooth-running casters. When thus equipped and designed with adjustable discharge heights, they are readily moved from place to place to fit into the varying conditions of warehousing or other such work.

The maximum incline at which packages may be elevated from one gravity level to another depends on the nature of the package. With the boxes shown this is about 15 deg. when the belt is not provided with cleats, and from 35 deg. to 45 deg. when the cleats are used. With arms of sufficient height even higher inclines are feasible, although the automatic loading of packages from gravity conveyor to belt is more difficult and sometimes uncertain at the higher angles. Surprisingly small motors are required for such belt boosters.

The two steel pieces at the foot, which train the package onto the belt, should be set with wide, easy flares, to prevent the stoppage of any box which may strike them. The speed of the belt should be as nearly the speed of travel of the boxes on the feeding gravity as it is practicable to make it. At inclines of from 15 deg. to the vertical,

smoother travel of the package results if the rollers supporting the belt are placed closer than would be necessary under a horizontal conveyor carrying the same load. Smooth sliding plates are often used instead of rollers for this purpose.

Department Stores

Parcels—Bundles—Boxes

The noiseless operation of the belt conveyor, its cleanliness, its neatness of appearance, and its high capacity for light packages, make this carrier particularly adapted to the department store or mail order house. Receiving from all parts of the building by means of branch and trunk lines leading from chutes to delivery rooms, these systems are practically indispensable in the larger stores. When installed running along close to the ceiling, through automatic doors in fire-walls, they occupy space that would not otherwise be used, and present a neat appearance in keeping with other store fixtures.

In the dispatching room these trunk lines deliver to the sorters; from there the packages are carried by a sorting belt in both directions, using both top and bottom run of belt, to the bins for later delivery. Obviously the amount of time saved and confusion eliminated is very great. Particularly in the first and basement floors, even in the smaller stores, the increasing congestion and demand for quick service is making not only the extensive belt system, but the individual conveyor as well, an essential feature of economical operation of the store.

In such a belt conveyor system the economical location of the various units is a matter requiring the most careful study. Loading points, for example, must be thoroughly

convenient to the wrapping desk, likewise the system should serve the greatest number of salespeople with the smallest number of branch receiving lines. The proper layout in the dispatching or sorting rooms of the larger stores presents the most exacting problem. Similarly, not only the position, but the proper speed of the continuous sorting conveyor has a decided effect on the efficiency of this department.

For department store service very light belts are commonly used, but the better classes of stitched canvas are



The Belt Serves as a Moving Sorting Table

worth their increased cost, even where only the lightest duty is required of them. Side-guards from 2 in. to 5 in. high are advisable wherever the installation is overhead. Motors and drives should be as compact as possible, for the sake of presenting better appearance.

Gravity Roller Conveyors

Gravity, the greatest of nature's latent forces, is available in every modern industrial operation. This free power, ever ready for useful work, has never been more economically used than through the application of gravity roller conveyors to the handling of commodities. The absence of electrical or mechanical power devices, the low first cost, and the flexibility of use of this conveyor, are the chief advantages over other types,—within the limits of its proper application.

From the paper of pins in the order basket of the department store to the heaviest castings of the steel foundry, practically any object may be handled either directly on the rollers or in trays. This wide range of application makes these smooth-running rollers adaptable to almost every industry. Continuous improvement in design and workmanship have made it possible to convey packages at surprisingly low grades, with correspondingly long horizontal runs. The use of short power boosters has extended, even more, the scope of gravity handling.

The standardization of the gravity conveyor in sections of convenient length makes it simple to install, with little interruption to business. For the same reason, when it is necessary at any time to make plant changes, lines of gravity can easily be moved to fit into new positions and to serve new purposes. This sectional make-up is of particular advantage in work requiring portable conveyors, as in freight handling, lumber yards, and similar operations spread over large areas. Because of its simple, compact construction it occupies very small space, whether installed overhead or on the floor. The freedom from electrical or

mechanical power makes it especially desirable for outside work, particularly because of its ready portability.

Analysis of the present status of development and use of the gravity conveyor reveals one big outstanding fact—more of the natural efficiency of this conveyor has been sacrificed through misapplication than in any other type of package handling equipment. In many cases not even ordinary foresight has been used in applying the proper conveyor to the work to be done, and yet nothing more than a reasonable amount of imagination and study of conditions is necessary. As an instance of misapplication, it is not uncommon, because of changes in plant layout and routing, to find lines of gravity conveyor originally designed to handle lumber put to the work of handling boxes, bales, or irregular objects requiring entirely different roller centers, grades and strength. In some such cases the very fact that this sectional conveyor is so easy to move and capable of such varied use has resulted in its being turned to such extreme uses as to make it impossible to operate successfully.

One of the most common causes of adverse prejudice, particularly in portable work, has been the application of much heavier conveyors than was necessary, and with supports of poor design. In warehousing, where there is so much moving of the conveyor, many operating men have wisely installed very light conveyors for definite classes of lighter packages, such as cartons and cases of canned goods, and much stronger and heavier conveyors for the heavier packages, crates and packing boxes. In many cases it is better to install the lighter portable conveyor in the full

knowledge that it will not last so long, but knowing that it will be used far oftener and through its savings pay for its replacement many times over.

General Specifications

Rollers. The rollers should be from 2 in. to 3 in. in diameter, preferably $2\frac{1}{4}$ in. to $2\frac{3}{4}$ in. of steel tubing, hardwood, cast iron, or other serviceable material. Whether of cylindrical, concave or tapered shape, they should be so accurately balanced that they will turn freely. Straight cylindrical rollers are best for standard flat-face package conveying. Concave rollers are well suited to round objects, generally requiring no guard-rail. Tapered rollers are used on curves to produce a banking effect. Wood rollers are not usually recommended for heavy service or continuous outside work. In many cases, however, their light weight in portable duty will offset their shorter life. The strength of the wood rollers may be somewhat increased by a metal ferrule driven onto the ends of the roller. With steel rollers, 14 gage and 16 gage steel tubing, preferably seamless, is satisfactory for ordinary package service, while for heavy duty 12 gage or 10 gage and even 5 gage for very heavy packages, is recommended.

Length of Roller. Whether of single or double roller construction the width of the conveyor should be from 2 in. to 4 in. more than the width of the packages being handled. It is satisfactory, however, for steel, or other sheets, large boxes, or similar well balanced packages to overhang the ends of the rollers if the run is not too long. For portable work there is a decided advantage in using the shortest roller consistent with the nature of the package to be handled, because of the lighter weight of the sections.

Roller Heads. The bearing cups must be so finished as to insure the shaft running in the true center of the roller. These cups should be so securely fixed in the roller by welding, punching, or other means that there can be no chance of their coming loose.

Center to Center. Center to center of rollers should be such that ordinarily smooth packages rest on three rollers at all times. If the surface of the package is rough the spacing should be closer. For unusually heavy and compact packages it is necessary to provide even closer centers, usually 3 in. to 4 in., to carry the weight.

Bearings. Accurately made bearings are necessary in order that the roller will turn easily about its true axis. All wearing parts should be case-hardened, and the balls or rollers should be of first quality steel. It is recommended that the bearings be fixed in such a way that they may be easily removed for cleaning or replacing. The shaft should be of first quality steel, preferably cold-rolled, whether of stud or of through shaft construction. Bearing shafts are usually from $\frac{3}{8}$ in. to $\frac{7}{8}$ in. in diameter for ball bearings, and from $\frac{3}{4}$ in. to $1\frac{1}{2}$ in. for roller bearings.

Frame. A steel frame of such section as to eliminate any appreciable deflection under full load of packages is essential. The sections should be so securely cross-braced under the conveyor and between the rollers as to form a rigid unit. It is important that the holes for the shafts be punched so accurately that the rollers are truly parallel to each other and at right angles to the frame, in the single roller conveyor, and that their tops form one plane throughout the section. In general, 8 ft. or 10 ft. sections are most satisfactory, although the length may be varied to fit local conditions.

End Connections. The end connections must lock the sections one to another so that there will be smooth transition from one section to another. In a portable conveyor

flexibility of use requires that these end connections be as quickly detachable as is consistent with accurate and secure alignment.

Side-Guards. There is little danger of packages running off the sides of a properly constructed conveyor; however, with certain types of packages, particularly in overhead installations and on curves, steel or wood-face guards are recommended. To make easier handling on and off the conveyor the guards should be as low as will safely protect the package. Although the distance between guards should be sufficient to provide ample clearance for the largest package to be handled, the distance from the end of the rollers to the guard should not be great enough to allow the smaller packages to drop into the space between. For certain types of packages, flanges on the roller ends make very satisfactory guards.

Supports. The gravity conveyor is most easily supported from the floor, although it is often hung from the ceiling or secured to wall brackets. Floor supports are of steel angle or pipe section. The portable conveyor should be carried on supports that are easily moved from place to place. For inside work casters or wheels at the foot of the supports are very satisfactory. With either fixed or portable equipment the supports should have as much adjustment as is consistent with rigidity and strength. Usually one support for each 8 ft. or 10 ft. section is sufficient, but where the packages to be handled are so heavy as to cause deflection, two supports to a section are necessary.

Curves. Whether of double roller, differential roller, tapered roller, or straight cylindrical roller construction, curves should be of such radius that the change in direction will not be so abrupt as to cause the package to skid. For the usual run of boxes and similar short packages radii of from 2 ft. 6 in. to 6 ft. to the outer edge of the curve are satisfactory. The advantage of the double, differential, and tapered roller lies in the fact that the outer ends of the rollers travel faster than the inner, which helps the package to make the turn without skidding. For portable work the ends of the curve should be interchangeable.

Switches. Hinged and breeches sections should be made with even greater accuracy than straight sections, particularly as to adjustable end connections and transitions from the straight sections. The control of these adjustable sections may be local, by hand, or from the point of dispatch, by light cables passing over pulleys.

Grades. The proper grades at which the gravity conveyor should operate vary so greatly with the packages being handled and the type of bearings used that only approximate figures can be given. For ball bearings the grades will run from 2 per cent for heavy, smooth-faced, packages to as much as 10 per cent and even greater, for the more irregular objects. A few lines of gravity are in operation at a grade as low as 1.5 per cent. Such low grades are usually found where the rollers are kept turning continuously by the constant movement of packages. For roller bearings grades depend mainly on the type of bearing used, but in general they require greater grades than do ball bearings. More definite grades for the various types of packages are given in the following pages.

Operation

While practically all gravity conveyors are built to stand hard usage the very simplicity of construction causes a tendency to handle this type with less than ordinary care. The canning plant conveyor is a good example of this. The end of the season often finds the conveyor left wet

and dirty, whereas a little time spent in cleaning and oiling at this time would leave it in far better condition for the next season's work. In handling such materials as hollow tile, brick, etc., the sand and grit constantly thrown off will cut the bearings if they are not cleaned out more often than is necessary for the usual service. Probably the hardest service required of the gravity conveyor is where it is subjected to chemical fumes or acids, or to constant dampness. Keeping the bearings well greased is the best preventive of the action of chemicals or moisture on ordinary steel bearings. The useful life of the conveyor can also be prolonged by care in loading. The practice of throwing heavy cases from piles or trucks onto the rollers is to be condemned, but where careless loading is unavoidable, heavier sections, with roller bearings, should be provided at the loading points. The economy of operation of gravity conveyors in any plant is invariably increased by having some one man or gang of men thoroughly trained in the proper assembling, handling and care of sections. On the larger operations rigging gangs save a lot of waiting time of laborers. Even more important, however, is thorough training of employees in the possibilities of gravity application.

As a sorting and distributing system the gravity conveyor can be economically used by placing men at the various transfer or switch points leading to side lines, or by operating these switches from the point of original dispatch. Where certain packages must be handled for which the set grade of the conveyor is too great, the speed may be controlled by placing short thin steel plates over the rollers at convenient points. Such plates should always be used at points where chutes deliver to the gravity at a sharp angle to prevent the packages digging in between the rollers.

Where it is not convenient to set the gravity conveyor on a grade it may often be used to advantage, with regular sized packages, by having it set level on supports—or even on the floor for very heavy packages—and using a power booster or pusher to push the continuous line of packages. Without the use of power, however, this operation of a gravity conveyor set level is not generally economical, except in short runs as in pushing parts from one machine to another in progressive assembly. This caution to set the conveyor on a grade where power is not employed applies particularly to freight handling, where the tendency of many laborers is to set the conveyor practically level and then stand at intervals along the line and push the packages along. The use of short power boosters, either stationary or portable, as aids to gravity operation has been so successful that a careful study of their possibilities will be well repaid.

Metal Products

Rolls of Wire—Tote-Boxes—Parts

There has been a rather general belief that the gravity roller conveyor is not applicable to many iron, steel, and similar metal products. A study of the success of gravity in handling some of the most irregular packages is the best proof of its great range of adaptability. Rolls of wire, stoves, piston rings in tote-boxes, cases of fire-extinguishers, even washing-machines and automobiles are handled economically between machines, departments or buildings. In handling hot steel parts gravity speeds up an otherwise slow operation. Steel-bound trays and tote-boxes carry small parts from one operation to the next as fast as they are finished. Generally it is an installation of

small units here and there rather than the complete system that proves the most economical.

For this service the rollers should be of steel. For the usual industrial service, 14 or 12 gage tubing with extra heavy bearings is satisfactory, but for heavier packages 10 gage to 5 gage tubing with roller bearings is better. Roller widths depend entirely upon the length, width, and



Double Rollers Increase Range of Use

irregularity of the bearing surface of the objects to be carried. The conveyor should be permanently fixed in position so far as is possible, and be placed convenient to the various machines to be served, with the view of avoiding all possible lifting.

Automobiles and Parts—Assembly Machine Parts—Castings—Stampings

Handling machine parts on a roller gravity conveyor from one operation to another saves much of the labor of

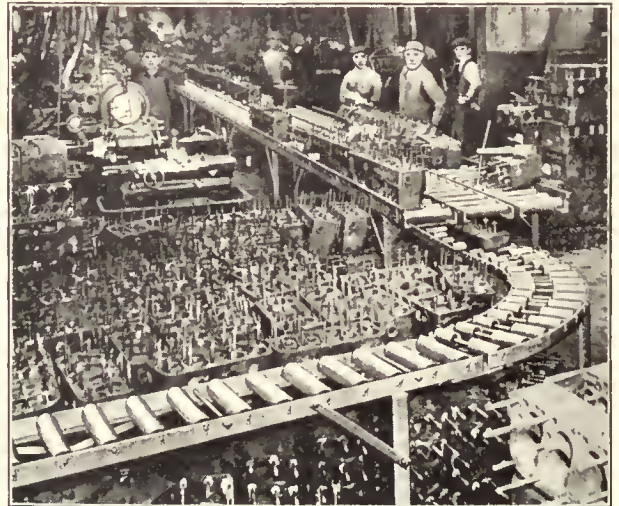

Differential Rollers Aid Assembly

lifting or attaching crane hooks and chains, as well as the loading, moving, and unloading of hand trucks. Smoothfaced castings—carried directly on the rollers—with small and irregular parts on trays, move in an orderly procession from the first operation to the complete as-

sembly of the machine. It is not always the complete system, but more frequently an installation of numerous short lengths between machines, that makes the most economical layout. Where used as process conveyors in this way, the gravity line may be set entirely level, and the package pushed from one machine to another. In connection with haul-chains, moving continuously or intermittently, gravity rollers make a convenient work bench. The almost universal success of machine shop installations—a success based on very careful application and upkeep—bears out the assertion that wherever dissatisfaction with a gravity conveyor occurs it can almost always be traced to improper application, use, or attention.

As machine work is usually heavy duty, larger bearings than the average should be used. The rollers should be of steel, about 16 in. long, and spaced to suit the size and weight of the package, generally 5 in. Ordinarily side-guards are unnecessary and interfere with the handling of parts on and off the conveyor. The heavy weights of the machine parts generally permit the conveyor to be operated on a very slight grade, often as low as 2 per cent, with free-running, ball-bearing conveyor. While such installations need not be permanently fixed in position, caster supports are usually unsatisfactory unless locked to the floor.

Foundries

Pig Iron—Castings—Flasks—Cores

In the foundry yard, portable sections of gravity conveyor are used in moving pigs of iron, lead, copper and similar raw materials from the cars to stock piles, and from storage to manufacturing processes. Lines of gravity conveyor within the foundry speed up the moving of cores, flasks and rough castings. This type of gravity conveyor is heavier than the average, and, as a rule, portable sections should be planned to be moved as little as possible. By careful layout of the conveyor lines this is more easily accomplished than it would seem from a casual consideration.

Rollers should be of steel, from 6 in. to 16 in. long, with centers closely spaced, 3 in. or 4 in. For pigs or other

to collect the dust. Because of the rough and irregular surface of the packages to be handled a greater grade is required than for ordinarily smooth packages.

Structural Steel

Plates—Shapes

The possibility of handling large flat objects much wider than the conveyor rollers considerably broadens the scope of gravity conveying. Sheets of steel and similar materials, such as bars, rails and other sections, travel



Handling Flat Stock on Double Rollers

smoothly on either curved or straight sections from the cars to stock piles, or from storage to the punches, shears, or other machines. In moving these heavy pieces from one operation to another with the least manual labor or time, the gravity conveyor serves a most useful purpose. Its portability makes it economical even in the most congested places.

For such heavy duty the rollers should be of steel, with extra heavy bearings and rollers, preferably 10 gage or 12 gage seamless tubing. For the heavier pieces even 5 gage tubing is none too heavy. For this work roller bearings are often better than ball bearings, particularly at the loading sections, because of their greater strength. Roller lengths of 24 in. to 36 in. are usual for handling such plates, with centers spaced from 6 in. to 12 in., depending on the length of pieces to be handled. While it may occasionally be necessary to use side-guards, these are generally inconvenient. The grades required are small—from 2 per cent to 4 per cent in a ball-bearing conveyor—because of the smoothness and weights of the packages handled. In fact, in many plants the conveyors are installed in a level position and the pieces are pushed from one machine to another. This type of conveyor is heavy, and, while thoroughly portable, it should be fixed in position as far as possible. When portable sections are required, these should be mounted on caster supports which can be locked to the floor.

Lumber and Wood Products

Boards—Lath—Shingles—Timbers

By eliminating trucking from the car to the pile, from the pile to manufacturing processes, and for many other purposes in furniture, box-making and similar industries, the gravity roller conveyor makes a distinct saving in the handling of lumber. Improved details in bearings, with



Steel Rollers Are Used for Handling Rough Material

irregular objects low side-guards are advisable. Grades of from 4 per cent to 8 per cent are usual. With heavy packages of fairly regular shape the guards should be omitted in order to facilitate the handling on and off the conveyor.

Since hard service is usually required of a foundry conveyor, extra heavy bearings are recommended. When the conveyor is used out of doors or where much sand and dust is being thrown off by the packages, care must be taken to keep the bearings well oiled but not to allow oil

quick-set-up supports and end-connections, have made this type of conveyor, particularly because of its portability, very efficient and satisfactory for outside service in lumber yards and on building operations.

Because of its lower first cost and lighter weight the wood roller conveyor is used extensively for lumber. Steel rollers, however, have the advantage of greater strength and wearing qualities where the conveyor is constantly exposed to the weather. The rollers should be from 12 in. to 18 in. in length, depending on the average width of the boards to be carried. A roller spacing of approximately 12 in. is best, although 15 in. or 18 in. is not too great for the longer boards. For handling shingles, lath and other shorter packages, this spacing should not be over 8 in. For heavy timbers extra heavy rollers, frame, and



From Car to Lumber Pile

bearings should be used, especially at the loading section. With the heavier timbers roller bearings are often more satisfactory than ball bearings, because of their greater strength. The supports should be light, strong and easily adjusted for the portable gravity conveyor.

Where the run is more than about 100 ft., or the set-up is likely to be irregular, it is better to use low side-guards. It is seldom practicable to handle lumber on curved sections, although it is thoroughly possible to make slight bends in the line, or to set the entire line on somewhat of a curve. Because of the light weight of the boards a grade of from 4 per cent to 6 per cent is advisable, and for handling irregular boards, laths, or shingles, a greater grade is necessary, depending on the irregularity and weight of the carrying surface of the package.

In moving the portable conveyor from one position to another, a little extra time spent in securing a proper set-up will be well repaid.

When the conveyor is not to be used for long periods in certain seasons, it should be taken indoors for storage.

Brick and Tile

Brick—Hollow Tile

In the unloading of kilns, particularly brick, the gravity roller conveyor eliminates the back-haul of empty wheelbarrows. Because of its sectional make-up it can be rapid-

ly set up and extended as the kiln is unloaded. Brick are handled directly and economically from storage piles to cars in brick yards, or from cars to storage in material yards.

Steel rollers should be used to withstand the constant abrasion of the brick. Since the bricks are usually handled in threes or fours, a roller length of 12 in. or 14 in. is usual. The short length of the brick, with its liability to uneven surface, requires close roller centers, generally 3 in. or 4 in. Because of the light weights to be handled, the bearings may be lighter than in a standard package conveyor. Ordinarily, the bricks are too irregular to run far on gravity without low side-guards, either attached to the side frames or in the form of flanges on the roller ends. Fairly regular shaped brick require grades of from 4 per cent to 6 per cent for ball-bearing gravity, while tiles generally require from 6 per cent to 10 per cent because of their more uneven surface.

Because portability is practically always demanded of a brick conveyor, particular attention should be paid to quick

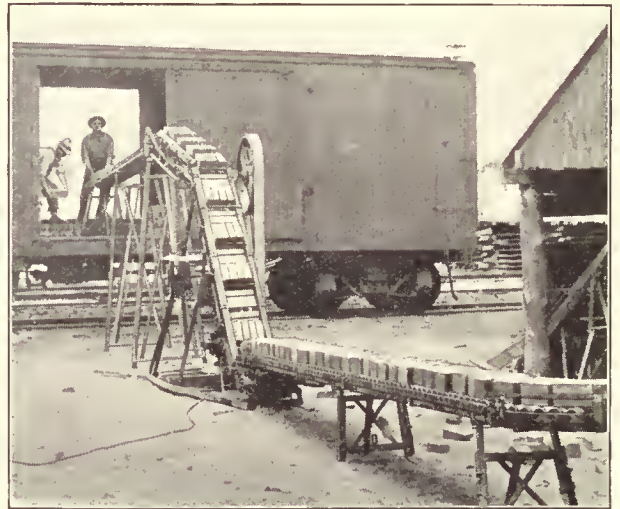

Flanged Rollers and Booster Aid in Loading

set-up end connections and supports. The sections should be as light as is consistent with the service required. In passing over the conveyor the bricks throw considerable sand and dust, and for this reason the ball bearings require special care; in oiling them precautions must be taken not to leave a surplus of oil to attract the dust.

Building Materials

Tile—Bags on Pallets—Lumber

In supply yards and on building sites, the gravity conveyor handles a wide variety of materials—tile, concrete blocks, rolls of building paper, and even bags of cement on pallets. It loads or unloads them from cars or trucks, or conveys materials from storage piles to the workmen. Because it operates in a minimum of space it is useful in conserving valuable storage room and avoiding confusion on congested construction operations. In large concrete operations lines of gravity are used economically for the handling of form lumber from the cars to the piles or to the saws. The use of occasional power boosters makes it possible to use the gravity conveyor over wider areas.

The rollers should be of steel to withstand the constant abrasion of the rough objects handled. They should be

from 12 in. to 18 in. in length and, because of the smaller objects to be handled, such as brick and tile, they should be closely spaced, from 3 in. to 4 in. Low side-guards or flanges on the rollers are advisable to insure satisfactory travel of the more irregular packages. Ready portability is generally an essential for this service; therefore the end connections and supports should be so designed as to be



Roller Gravity Convenient in Construction

quickly set up, and the sections should be as light as is consistent with durability. Because the conveyor is used out of doors and constantly handles packages that throw off considerable sand and dust, especial attention must be paid to the oiling and care of bearings. Fairly regular hollow tile and brick require grades of from 4 per cent to 8 per cent.

Canning and Packing

Baskets of Fruit—Cartons—Boxes—Tubs

In canning and preserving plants the gravity roller conveyors speed up the handling of perishable products and make the most of a short working season. Baskets, boxes and tubs of fruit and vegetables are brought from the trucks or receiving platforms on such conveyors to temporary storage or to the packers and washers. Likewise, empty boxes and box-shooks are conveyed from the cars to storage or to the box-shop, and thence supplied to the packers. From the packing tables, lines of gravity conveyors carry the filled cases to the warehouse or to the labeling machines and shipping room for distribution. In many plants the same lines of portable conveyor are used to serve these various purposes. One of the chief economies is in loading cars quickly from storage, the labeling, nailing and marking on gravity being done while in transit.

For this service wood rollers have the advantage of lightness and portability and are widely used, but where the conveyor must handle boxes with rough projections or metal bindings, or baskets with rough bottoms, or be continually exposed to the weather, steel rollers should be used. A roller length of from 12 in. to 16 in. is usual. Rollers may be spaced from 3 in. to 6 in. center-to-center, the closer spacing being required for baskets or for boxes carried cross-wise of the conveyor. Guard-rails are practically essential for baskets, although generally they are not required for boxes or cartons except on curves or overhead installations. For baskets, grades of from 5 per cent to 10 per cent are generally required because of the more or less rough bottoms of the packages. Because this service requires easy portability, attention should be given to quick set-up supports and connections. Since canning is

a reasonable business, it is necessary to see that the conveyor sections are carefully cleaned and oiled when stored at the end of each season.

Confectioners and Bakers

Bags—Cartons—Caddies—Boxes—Barrels

In bakeries and confectionery plants the gravity conveyor is used to unload sugar, flour and other raw materials in bags, barrels and boxes from the cars to the storage or mixing rooms. The handling of bags is made possible by the use of pallets, and many ingenious methods have been devised for returning the pallets after discharge. In the packing rooms lines of gravity conveyor bring a constant supply of empty boxes or cartons to the packers. Other lines remove the packed boxes to storage, or carry them through the processes of weighing, sealing, and marking to the shipping room and from storage rooms to trucks or cars. Used with spiral chutes, this conveyor forms a most economical gravity system.

For pallets of the usual 4 ft. or 5 ft. length the rollers should be spaced on about 6-in. centers, although 8-in. and even 10-in. centers will serve. Roller lengths of from 16 in. to 24 in. are usual. In general, side-guards are not necessary. For smooth, well-made pallets grades of from

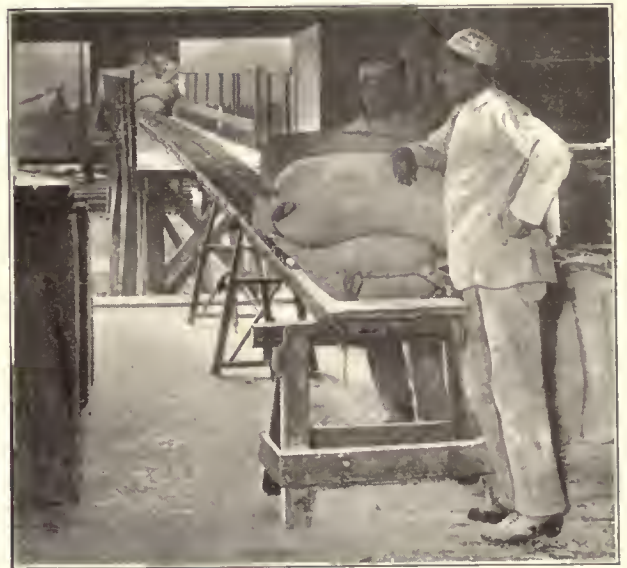

Unloading from Cars to Storage

3 per cent to 5 per cent are sufficient with the ball-bearing conveyor. When convenient, the lines of gravity conveyor should be fixed in position, with hinged or portable sections at the passageways. If dust or moisture are present the rollers should have such occasional cleaning and oiling as is convenient without removing the bearings.

Dairies

Cans—Cases of Bottles

In conveying from street or car platforms to automatic elevators or refrigerator room, and for numerous other such purposes in dairies, ice-cream plants, and similar industries, the gravity conveyor handles milk cans most economically. By passing the cans over a section of gravity conveyor attached to a platform scale the weight of each can may be rapidly recorded in transit. Cases of

bottles or cans, both solid and open bottom, are handled through the processes of packing, washing, filling and shipping.

Close roller centers, from 3 in. to 4 in., are required on account of the height and relatively small base of the can. Roller lengths of 14 in. or 16 in. are recommended to accommodate the largest cans. For this service steel rollers are much better than wood. Because of the shape of the can side-guards are practically essential. These may be omitted at loading and unloading points to facilitate the



Weighing on Gravity Conveyor

handling. For cans, grades of from 5 per cent to 8 per cent are usual, with a ball bearing conveyor.

As far as possible, can conveyors should be kept close to the floor to save labor in lifting the cans. Because of the extensive use of water for purposes of sanitation the bearings require more attention for oiling and cleaning than for the gravity conveyor used under ordinarily dry conditions. Where a scale section is used it must be kept separate from the fixed sections adjoining. Also, to prevent inaccuracy in the operation of the scale, special care must be taken to keep it free from accumulations of foreign matter which would affect the weighing.

Bottling

Cases of Bottles—Boxes—Trays—Cartons

No application of gravity conveyor offers more opportunity for economy than the automatic delivery of empty cases and materials to the packers, and the removal of cases after they are filled. With a carefully planned installation lost motion is reduced to a minimum and this usually congested operation is speeded up. In other departments gravity is used to unload incoming materials to storage, and carry cans, barrels, and cases of bottles between washing, filling, labeling, and other operations. Used with short spiral chutes or power boosters, the gravity roller conveyor performs practically all the package handling operations in many plants.

For the packing-table section the rollers may be of either steel or wood, preferably steel, from 14 in. to 24 in. long. It is best to use closer centers, 3 in. to 5 in. and heavier bearings and supports where the packing is done, and the usual 4-in. to 8-in. centers for the conveying sections. For this service, guards are generally not necessary, except on the outside of curves and for overhead installa-

tions. With ball-bearings, grades of from 3 per cent to 5 per cent are usual for smooth bottom cases. The packing-table section may well be set level, and the filled boxes



Packing on Gravity Conveyor

pushed along to where the inclined conveyor line starts. The conveyor section which delivers the cases to be filled gives the maximum service if it is arranged to deliver in front of the operator, and slightly above the packing-table, thus eliminating unnecessary movements.

Cylindrical Objects

Boilers—Shells—Linoleum—Paper—Shafting

The development of concave rollers has opened many new opportunities for the economical use of the gravity conveyor. Set in continuous lines, convenient to the op-

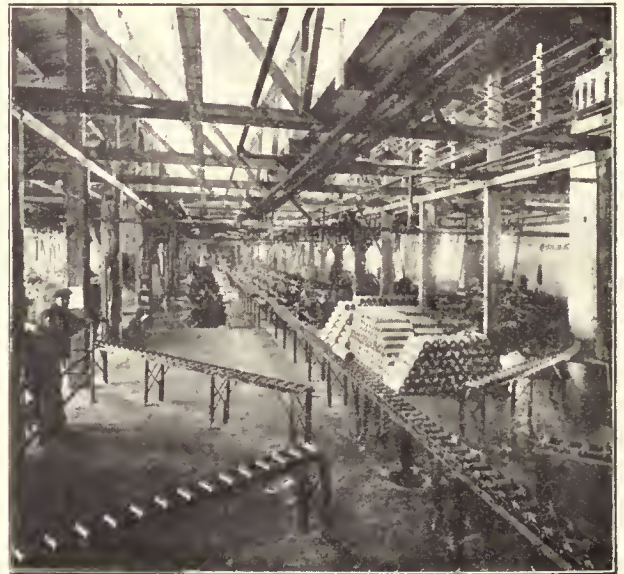

Machine Shop Routing

erator, it is very serviceable in handling heavy cylindrical objects from one machine to another. The concave rollers successfully overcome the tendency of such objects to roll from side to side. While straight rollers can be used with a side guard, in most cases the resulting rubbing of traveling packages on this guard is very objectionable. The guard is unnecessary with the concave rollers and it becomes more

convenient to load and unload the conveyor at any point. The rollers are usually made of cast iron or hard wood. A roller length of 6 in. to 8 in. is recommended for articles up to about 18 in. in diameter. The roller spacing depends upon the length of the packages, from 4-in. to 8-in. centers are usual. Because the objects handled on concave rollers are generally heavy, and the service required much harder than ordinary, extra heavy bearings are advisable. Because of their greater strength, roller bearings are much used for the heaviest service. The concave shape of the rollers requires that curves of small radius be avoided where it is necessary to change the direction of travel. While a slight grade is advantageous, it is not essential, and when set level, the cylinders may be pushed along from one operation to another. Because the concave roller is heavier and naturally more sluggish than the straight roller, the sections should be set on grades of from 1 per cent to 3 per cent greater than for straight roller gravity.

Car Loading

Crates—Cases—Boxes—Cartons

Lines of gravity conveyor running down the loading platforms are solving many problems of loading and unloading cars on limited trackage and within the free time allowed by the railroads. Portable sections, with switches and curves, extending into the cars, convey the packages to the men in any car, and save time, labor and confusion in loading. In general, permanent installations—where convenient, installed over-head—with movable switch sections are most satisfactory for this work.

Steel rollers give much better satisfaction than wood for handling crates, since the crates are frequently rough in character or wire-bound. Because of the open or slat construction of the crate the rollers should be of sufficiently greater length to avoid its overhanging the ends of the rollers. Side guards are the best insurance of this. Crates with cleats, batons, or heavy wire binding must travel in

are not conveniently located, much time may be saved by running portable lines of gravity conveyor direct from the storage piles, through windows, to the cars on the siding.

Truck Loading

Miscellaneous Packages

The rapidly increasing use of large, expensive trucks has increased the use of the gravity conveyor for cutting down the waiting time at the loading platforms. In many



Saving Time of Trucks

plants lines of gravity conveyor are filled with practically a complete truck load of packages before the truck arrives. Then, with a quick set-up portable section in the truck, the loading is done in the shortest possible time. Used as a temporary storage place, in this way, the lines of gravity conveyor will hold a greater volume of packages if several packages are piled on top of each other. The fact that the truck bed and platform are not at the same level really increases the economy of this application over the method of carrying packages, often too heavy for one man, from the warehouse truck to the street truck.

For the great variation in package sizes usual in this work, steel rollers from 14 in. to 18 in. long and placed on about 4-in. centers are best. Ordinarily no guard rail is necessary. If the sections are to be moved, caster supports save much lifting, and are practically essential on the section in the truck. This portable section may well be of lighter construction throughout than the others, to make handling easier, in which case it may easily be handled by one man. Such lines of gravity conveyor are often set up practically level on the warehouse floor, and the entire line of packages pushed onto the truck.



Distribution by Switches

the direction of these cleats. While smooth bottom crates will travel on grades of from 4 per cent to 6 per cent, flimsy, loosely built crates require more fall per foot. Care must be taken that the contents of the crates, by projecting or falling from the packages, do not interfere with the smooth operation of the rollers. Where doorways

Textiles

Pallets—Trays—Baskets—Boxes

In textile mills the use of pallets, trays and tote-boxes has made possible the use of the gravity conveyor to handle bags, bales, rolls of cloth, bundles, bobbins, and many other objects. Although the necessity of returning the carriers to the loading points limits somewhat the range of this

application of gravity conveyor, many ingenious means have been devised to overcome this difficulty. If the trays are light and compact, and the distance not too great, they may be stacked and many of them at a time pushed back by hand on the gravity conveyor.

This method of using the gravity conveyor is mainly applicable to short runs of 10 ft. to 75 ft., and for stationary installations. Where it is convenient, the pallets may be returned on another line of gravity, or power conveyor,

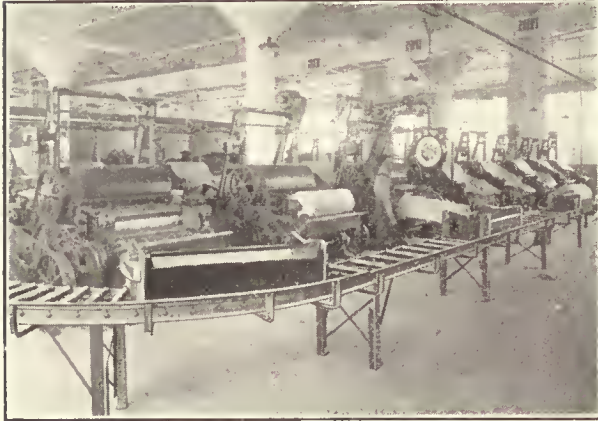

Handling Rolls of Cloth on Pallets

running in the opposite direction, in which case the systems may be more extensive and economical.

Steel rollers are most satisfactory for this work, although if the pallets can be kept smooth on the bottom, and free from nails and projections, wood rollers may well be used. Where long pallets are used roller centers as great as 10 in. will serve. If, as is often the case, however, heavy loads are concentrated on the carrier, 5 in. to 8 in. centers will be required to insure the necessary strength. For pallets with a fairly smooth travel surface, grades of from 3 per cent to 5 per cent are usual.

Glass

Racks—Trays—Cartons—Boxes

Not only in the warehousing of glass products, but in conveying them between the various finishing operations in the processes of manufacture, the gravity conveyor is extensively used to handle glass. Because of the smoothness of operation of this conveyor the most fragile objects, either on trays or loose in boxes, are handled without breakage. The ease of transition from gravity to power conveyors or elevators adds to the effectiveness of gravity handling. In bottle and similar glass plants lines of gravity conveyor carry the packed cartons, boxes, or crates from the packers to storage or shipping rooms. For this purpose overhead distribution systems are probably most effective, with switches at desired points to divert the packages to adjustable chutes leading to cars or storage piles. From the lumber yard or crate shop gravity conveyors, often in connection with short power boosters, are useful in carrying packing materials to the packers.

Steel rollers of from 16 in. to 24 in. in length are best, with a spacing of 6 in. to 8 in., or even 10 in. for the longer racks. For ball bearing conveyors a grade of from 3 per cent to 4 per cent is usual, although for handling flexible paperboard cartons a grade of 6 per cent is none

too great. Well designed racks or special carriers, to fit the particular glass object or operation, are necessary to

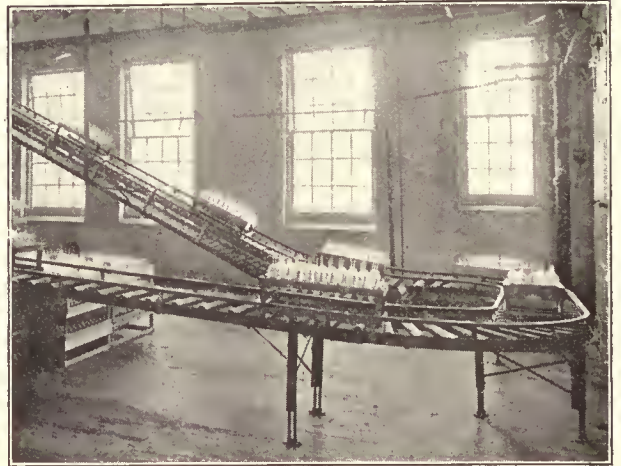

Handling Fragile Objects in Racks

insure the successful and economical operation of roller gravity for glass handling.

Wholesale Houses

Hampers—Baskets—Boxes

The standardization of containers for making up and shipping orders has enabled the roller gravity conveyor to be applied very economically to wholesale and mail order houses. These gathering baskets bring within the scope of gravity conveying practically all of the packages handled. Used alone, or in systems with belt conveyors and spiral chutes, lines of gravity conveyors form a very direct distributing medium. By hanging the sections from the ceiling and lowering the packages to the wrapping and packing tables on straight chutes or short spirals the working floor areas are kept clear. In wholesale dry goods houses incoming cases are conveyed, and even temporarily stored, on lines of gravity conveyors.

For this light service wood rollers are very satisfactory, although steel rollers are to be preferred. Roller lengths of from 16 in. to 18 in. are usual, with centers spaced from 4 in. to 6 in. For either overhead or floor installations light side guards should be used, because of the rather

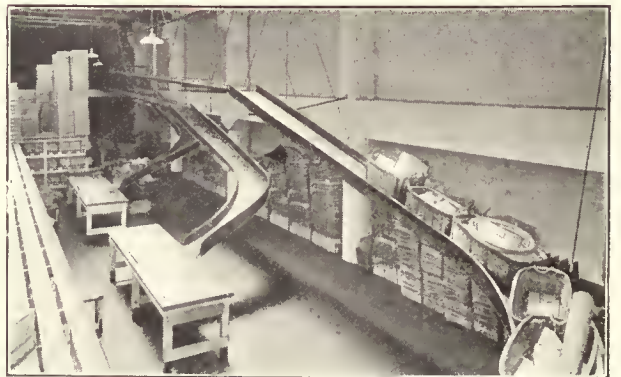

Overhead Distribution Saves Floor Space

irregular travel surface of the containers used. Grades of from 4 per cent to 6 per cent are customary, although 8

per cent or even greater is necessary where the packages are very light.

Freight Handling Miscellaneous Freight

While the miscellaneous character of general freight limits somewhat the use of the gravity conveyor, a very large proportion of warehouse and marine freight is thoroughly adaptable to gravity handling. With the development of light, readily portable sections has come increased knowledge of the possibilities of gravity operation. The greatest



Distribution by Adjustable Curve Sections

economy comes through the use of short runs of from 50 ft. to 150 ft. for loading or unloading cars, ships, barges, or trucks. For the larger operations well trained rigging gangs save the idle time of laborers and insure better use of the equipment. In some warehouses short power boosters are used to extend the usefulness of the gravity conveyor.

Steel rollers are advisable because of the rough work to be done. Roller centers of 5 in. are good, although, if none of the packages are too short to travel smoothly, it is better to use 6 in. because of the resulting lighter weight. For the same purpose of reducing weight, it is well to have the conveyor as narrow and as light in general construction as is consistent with the packages to be handled. Side-guards are generally not necessary, and make handling

awkward. The supports should be light and easily adjustable.

Loading Cars from Storage Boxes—Cartons—Cases

The rapidly increasing use of the gravity conveyor supported from the ceiling and leading from various storage rooms out to lines of cars is the result of careful study



Switches Divert Packages to Cars

of the actual savings possible with such extensive systems. Such a layout combines the use of portable chutes and gravity sections with fixed gravity conveyors. The distributing lines are loaded by means of chutes from the floor above the conveyor. Switches, with either local or remote controls, divert the packages to the proper car. Light portable chutes extending into the cars reduce even further the labor of loading. Such distribution systems have been found especially applicable to the food product industries, such as raisin packing, wholesale tea and coffee houses, and cereal packing to warehouses handling a reasonably uniform range of packages, and to a very great number of manufacturing plants.

For this service steel rollers are usual, with centers of from 4 in. to 6 in., and rollers 16 in. to 24 in. in length for the general run of boxes. Guards should be used on such overhead installations, mainly for reasons of safety of employees. With ball bearing conveyors grades of from 3 per cent to 5 per cent are satisfactory for handling fairly smooth faced packages.

Gravity Roller Spirals

The gravity roller spiral offers an economical means of lowering fragile packages which must be handled with exceptional care. Any package which will travel on a gravity roller conveyor can be lowered directly on the rollers, while the use of pallets, trays, or tote-boxes permits the successful handling of small parts and irregular objects. This makes a roller spiral specially applicable to manufacturing purposes. This type of spiral may be used as temporary storage for even the most fragile packages, since they will start or come to rest easily and evenly on the roller runway. Thus a full load of packages may be allowed to back up on the spiral and as the lowest packages are removed, the load will automatically travel downward without danger of breakage from the impact of one package against an-

other. This feature, by eliminating the loading and unloading of hand trucks, materially decreases the cost of handling between operations.

The conveying capacity of the roller spiral is practically unlimited, depending only on the grade at which the runway is set. For such packages as barrels on end, filled tote-boxes, or trays with easily disarranged contents, the roller runway spiral is more satisfactory than the friction spiral, largely because of its more nearly level grade. While it occupies more space than the friction types, this is often more than offset by the space saved by its greater temporary storage capacity. Another advantage is the absence of wear and tear on packages, such as tote-boxes and containers, which have to be handled a number of times.

Two general types of roller runway spirals are in use, the spiral with center post and the spiral supported solely by angle uprights. In the former type the greater part of the load is carried by a center post or pipe which extends the full height of the spiral. Sometimes a staircase is built around this center post, occupying the space inside the runway. In the spiral supported by angles only, the uprights are placed close to the inner and outer edges of the roller curves forming the runway, and the roller frame is supported on cross angles or saddles rigidly attached to the supports. Like friction spiral chutes, these roller spirals may be built with multiple runways for greater capacity and better distribution of packages. Loading and discharging is easily accomplished at any desired point by means of hinged switches or diverters. The gravity roller spiral on account of its low grade requires full circular openings in the floor, which are more difficult to fireproof than the smaller openings of the friction spiral. In warehousing there has been a limited, but increasing, use of portable roller spirals for the purpose of receiving from overhead distributing conveyors and delivering either to the floor or to intermediate gravity conveyors below.

General Specifications

Rollers. Whether of double roller, differential roller, or single tapered roller construction the rollers should be so accurately balanced about their axes that they will turn with perfect freedom. Steel tubing from $2\frac{1}{4}$ in. to $2\frac{3}{4}$ in. in diameter, preferably seamless, is best for this work, although wood rollers, plain or with metal end ferrules, have been much used.

Roller Length. Roller lengths should be from 4 in. to 8 in. wider than the packages to be handled, so as to eliminate so far as possible the rubbing of the packages against the side guards.

Roller Heads. The bearing cups must be so finished as to insure the shaft running in the true center of the roller. These cups should be so securely fixed in the roller by welding, punching, or other means, that there can be no chance of their coming loose.

Center to center of rollers should be such that ordinarily smooth packages rest on three rollers at all times. If the surface of the package is rough the spacing should be closer. For unusually heavy and compact packages it is necessary to provide even closer centers, usually 3 in. to 4 in., to carry the weight.

Bearings. Accurately made bearings are necessary in order that the roller will turn easily about its true axis. All wearing parts should be case-hardened, and the balls or rollers should be of first quality steel. It is recommended that the bearings be fixed in such a way that they may be easily removed for cleaning or replacing. The shaft should be of first quality steel, preferably cold-rolled, whether of stud or of through shaft construction.

Frame. Because gravity spirals are used so much for temporary storage, in which case they are fully loaded, the frame and supports should be of heavier construction than would be necessary with the straight gravity roller conveyor. Similarly, the spiral must be better braced sidewise. The gravity roller curves making up the spiral must be rigidly connected to each other and to the supporting cross angles, which in turn must be securely bolted or riveted to the upright angles or center post.

Supports. The center post, when used, should be from 3 in. to 5 in. in diameter and of sufficient section to take its full share of the load. If angle uprights only

are used as supports, they must be designed to carry between the outer and inner rings the full weight of the loaded spiral. These are best braced laterally by continuous angle rings around the spiral and outside the uprights, or inside, if the outer side guard is riveted to the supports as a brace.

Side Guards. The standard side guards used on gravity curves are satisfactory, although when used as annular braces for the uprights they may well be heavier.

Grade or Pitch. The proper grade per round depends upon the nature of the travel surface of the package to be handled. The drop per round runs from 24 in. to 42 in., with the usual outside radius of about 4 ft.

Loading and Discharge Points. While the loading is usually done at the start of each runway, packages may be loaded at any point by means of hinged sections. These sections must be carefully fitted and easily adjustable either by hand or by small cables with pulleys. Similarly packages may be discharged at any desired point on the spiral.

Fire Protection. A full housing of sheet steel or similar material, with approved fire-doors, is about the simplest means of fireproofing between floors. The simple fire-door of the friction type spiral chute is hardly applicable to the gravity roller spiral.

Operation

The operation of the gravity roller spiral is extremely simple. For properly designed spirals practically no attention is required further than occasional cleaning and oiling of the bearings. Such little trouble as occurs generally arises through the setting of adjustable loading gates or diverter sections, where these are a part of the equipment. Rather than use these too extensively it is preferable to have double or even triple runways for different packages or leading to different discharge points. As in the gravity roller conveyor, the speed of packages may be slowed up by placing thin sheet steel plates over a few rollers at desired points. The friction of the package, sliding over the steel plate, slows it up the required amount. Wherever possible the spiral should be convenient of access at all points, but particularly at intermediate loading or discharge points. These spirals are used, almost universally, in connection with the gravity roller conveyor, both at top and bottom.

Baking

Cartons—Boxes—Caddies

For the lowering of cartons of crackers, small cakes, and similar baked goods, particularly where special care of the contents is desirable, gravity roller spirals are most useful in multi-story bakery buildings. The case with which this spiral may be loaded by the gravity roller conveyor from packing tables, and discharged to lines of gravity conveyor leading to the shipping or the storage rooms, makes it an important part of many distribution systems. Since the packages may safely back up on the roller runway, less regular attention is necessary at the delivery end. Such a spiral may be installed either within the building or attached to the building outside. The latter location simplifies the fireproofing between floors, although, where weather-proofing is necessary, this rather offsets any such advantage.

For handling such light paperboard cartons a drop per

round of from 24 in. to 38 in. is usual with the customary 4 ft. outside-radius spiral. A 3 in. center post, with four $2\frac{1}{2}$ in. by $2\frac{1}{2}$ in. by $\frac{1}{4}$ in. upright angles or $2\frac{1}{2}$ in. pipes carrying the outside ends of angle saddles of about the same size, forms a good supporting system. Standard curve sections of gravity roller conveyor, rigidly connected to each other and to the supporting frame, make up the runway.



Double Runway with Solid Guard Rails

Side guards of $1\frac{1}{2}$ in. by $1\frac{1}{2}$ in. by $\frac{3}{16}$ in. steel angles serve to protect the package and at the same time form excellent lateral bracing if riveted or bolted to the upright supports. An even stiffer construction is secured by the use of a solid guard-rail, although this is hardly necessary.

Canning and Packing

Boxes—Cartons—Cases

In canning plants and many similar industries the use of roller spirals for distributing boxes of packed goods from overhead conveyors to piles of various heights is increasing with the improved construction of this equipment. While such spirals are usually fixed in position there is an increasing demand for portable equipment of this type. Such portable spirals are moved from place to place to receive packages from various overhead conveyors. At desired points hinged sections of the runway are arranged to swing up and discharge to distributing lines of light portable gravity roller conveyor, supported either from overhead or on the piles themselves. These horizontal gravity lines also are made to feed the boxes back into the spiral in breaking down piles or loading out to trucks or cars.

For this service a drop per round of from 30 in. to 36 in. is usual for a 4 ft. outside radius spiral. If rather flexible cartons are to be handled 42 in. is none too great. The runway width should be from 18 in. to 24 in., with an average center to center of rollers of 4 in. If the spiral is to be portable it should, if possible, be considerably lighter than if built stationary. This may be accomplished by using light rollers, possibly wood, and omitting the center post.

Such a spiral is applicable only where the floor over which it is to be moved is fairly smooth and firm. Special atten-



Distribution by Portable Spiral

tion must be paid to providing the best quality roller bearing casters. Since the spiral must be much better braced than for stationary equipment it is advisable to use eight upright angles instead of four, and rivet not only the guard-rails, but also the supporting angles of the curved runway sections, to these uprights.

Bottling

Cases—Cartons—Trays—Kegs—Carboys

In no industry has the roller spiral found more economical application than in the handling of cases of filled bottles from filling, labeling, and packing operations to storage or distribution in bottling plants. The use of these spirals as lowerers from lines of loaded gravity roller con-

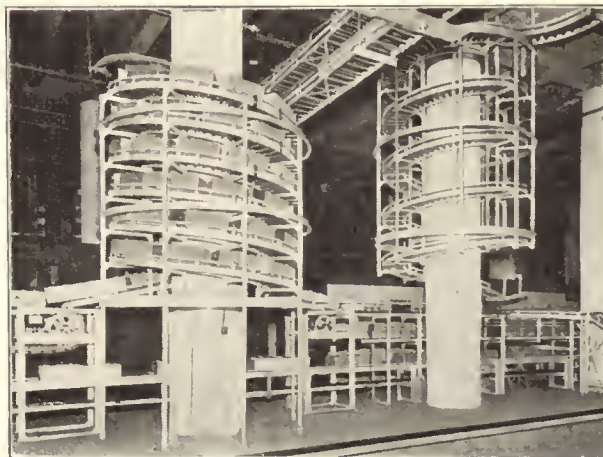

Spiral Located to Conserve Space

veyor suspended close to the ceiling provides extensive storage space with the greatest conservation of space at the

floor. Similarly, where a basement is used for storage, cases of empty bottles are handled from the cars to storage with a minimum of labor, attention, and damage to the contents.

For handling smooth-bottom cases on a spiral of 4 ft. outer radius a drop per round of 36 in. is satisfactory, although most smooth cases weighing 50 lb. or more will travel successfully on a drop per round of 30 in. Runway widths of from 18 in. to 24 in. are usual, with average center to center of rollers of 4 in. to 5 in. Eight sets of $2\frac{1}{2}$ in. by $2\frac{1}{2}$ in. by $\frac{1}{4}$ in. upright angle posts form a good supporting system. These should be braced by the cross saddles under the curves and by outside horizontal rings, or by the side guards, riveted to the uprights.

Chemicals and Drugs

Barrels—Kegs—Drums—Cases—Carboys

Where it is desirable to lower barrels, drums, or similar containers on end, as well as to provide temporary storage



Spiral Provides Temporary Storage

on the conveyor, the roller spiral has little competition in economy of operation. Similarly, in handling carboys, cases of bottles, or other packages adapted to gravity rollers, the roller spiral forms a very flexible link in systems of gravity conveyors. Wholesale and manufacturing drug

houses use this spiral for the handling of loose bottles in boxes, particularly from filling tables to labeling machines and packers—the boxes moving slowly and in practically a continuous stream between the various operations.

For handling ordinary barrels on a spiral of 4 ft. outside radius, a drop per round of 30 in. to 36 in. is usual, depending partly on the height between runway rounds necessary to clear the barrel in an upright position. For the rougher barrels, however, a drop as great as 40 in. is frequently used. Two lines of side guards are necessary because of the height of the barrel, the upper line set farther out than the lower to allow for the bilge of the barrel. Because of the heavy loads handled, either inside angle posts or a heavy center post of from 4 in. to 6 in. diameter are recommended, with four outside angle posts of 3 in. by 3 in. by $\frac{5}{16}$ in. Either the upper guard-rail should be heavy enough to form lateral bracing, or extra annular rings of steel angle—about two between floors—should be used. The center to center of rollers depends entirely upon the size of packages to be handled, although for ordinary barrels centers of from 4 in. to 5 in., average, are usual. For the heavier barrels, concentrated on a few rollers, stronger bearings than for standard package conveying are desirable.

Car Loading

Miscellaneous Packages

Where the general run of packages to be handled is adapted to the gravity roller conveyor the roller spiral is very serviceable in lowering packages from the upper floors of storage houses to cars. At the base of the spiral lines of gravity conveyor carry the packages to the various cars which are being loaded. The temporary storage capacity of this spiral makes it flexible and smooth in operation, requiring little cooperation between loading and discharge points beyond continuous loading at the storage piles and unloading in the cars. Often the spiral is filled with the packages to be loaded before the car is spotted. When this is done direct from the packing table the usual double handling to trucks or piles is avoided.

For handling miscellaneous boxes, crates, or barrels, a drop per round of from 32 in. to 40 in. is best with a spiral of about 4 ft. outside radius. Average roller centers of 5 in. are usual, with runways from 24 in. to 30 in. in width. For spirals running from 50 ft. to 75 ft. in height center posts of 6 in. are advisable to carry the load, with $2\frac{1}{2}$ in. by $2\frac{1}{2}$ in. by $\frac{5}{16}$ in. angle uprights. Because of their heights such spirals require extra bracing and tying to the adjacent walls or floors.

Spiral Chutes

The simplest and most direct means of safely lowering packages from upper floors of buildings is the spiral chute, sometimes called the friction spiral. The principles of gravity and centrifugal force form the basis of spiral design. The package, impelled by the force of gravity, and forced outward by centrifugal action, is retarded in its forward travel either by friction against the outer guard-rail, or because of the lower grade of the runway at the outer edge. Because of this travel control, even the most fragile packages are handled safely.

Three types of spiral chutes are in general use,—the closed center chute, the open center chute and the open

center with post chute. Any of these becomes the housed type when fully enclosed by a housing of sheet steel or other material attached either to the chute or built independently.

In the closed center type the wings which make up the runway trough are attached directly to the center post, which in turn carries most of the load to its base. This construction, especially when reinforced with knee-braces from the post to the outer edge of the runway, forms a strong chute. In this type of chute the center post usually forms the inner guard-rail.

In the open center spiral chute, the runway is sup-

ported from each floor by rods, angles, or other attachments, and an inner guard-rail is used. The chief advantage claimed for this type of chute is better control of the package. Such chutes are occasionally designed for the intermediate floor loading to be done from within the center.

In the open center with post type chute the runway load may be carried entirely by the center post or partly by the post and partly by the floors through which the chute passes.

With spirals of any type one of the most surprising features is the small space required. For single runway chutes the holes in the floor seldom are more than a half circle and the runways wind downward in such way as to permit the use of space close under and around the spiral. Bags, barrels, loose bottles in cases, crates, bundles, bales,—in fact practically all packages which do not require exceptional care,—fall within the scope of spiral lowering. A wide range of objects may be handled over the same spiral, from light paper cartons to heavy cases and barrels. In department stores, wholesale groceries and drug houses, hardware and supply houses, and general warehouses, as well as in practically every industrial plant handling packed materials, the spiral saves the time lost waiting for elevators, and eliminates the needless moving about of employees from floor to floor and much of the confusion of trucking. In manufacturing plants, particularly, it forms a valuable link in material handling systems, automatically receiving from and discharging to conveyors and trucks. Through the use of multiple runway spirals with loading and discharge at convenient points, the proper routing and sorting of a wide range of packages is accomplished. While spiral chutes have been installed practically without exception in fixed positions, there is a growing demand for short portable spirals, to be moved from place to place in lowering between floors, breaking down high piles, loading ships, or for similar operations.

One of the biggest improvements in the economic use of spirals, particularly in miscellaneous storage houses where commodities are handled in small lots, has come about through the growing use of "gathering boxes" or baskets. These large boxes are carried about on low platform trucks until the order or truck is filled. Then, instead of unloading each package separately at the spiral, the entire box is slid off the truck onto the spiral runway, and is received at the bottom by a similar platform truck or a conveyor. By building these gathering boxes in suitable shape, a number of them may be nested and returned to the upper floors at once.

With its almost unlimited capacity, lowering packages in a steady stream, the spiral chute has little competition within its range of application. It is only in lowering packages whose contents are easily disarranged, or where the spiral is to serve as temporary storage for certain fragile packages, that it has not the efficiency of the gravity roller spiral or the mechanical lowerer. Where the types of packages vary too much for satisfactory operation on the same runway it is customary to build two or more runways with different widths about the same post. The smaller runway, with guard-rail closer to the center, provides a steeper grade for the lighter packages.

General Specifications

Runway. The runway may be either a flat or concave bed of galvanized or blue annealed steel, or of cast iron. Where the spiral is subject to dampness the galvanized steel is best. Cast iron runways are preferable for certain

types of articles, particularly those of an abrasive nature. The width of the runway should be sufficient to avoid any possible binding of the largest packages to be handled. The wings of the runway, or trough, must be thoroughly riveted or bolted to each other and to the other parts of the chute in such way as to be free from projecting rivets or other obstructions. Where the general run of packages is light, 16 gage construction is satisfactory, although 14 gage is usual for average packages up to 250 lb. or 300 lb. For heavier duty 12 gage should be used, with extra strong bracing, particularly if the spiral is to be used often as temporary storage for heavy packages.

Grade or Pitch. The proper grade for any spiral depends upon the weight of the package in proportion to its size, and the nature of its sliding surface. The various average grades are given under the specifications for the different types of packages in the following pages.

Guard-Rail. Guard-rails of either galvanized or blue-annealed steel are most satisfactory. In height they should be not less than approximately two-thirds the height of the highest package to be handled. Guard-rails should be about the same gage as the runway, although they may safely be lighter.

For cast-iron runways guard-rails should be not less than 14 and preferably 12 gage sheet steel. The top edge of the guard should be turned or rolled to form a smooth edge, and to stiffen the guard. Where, in extreme cases, it is necessary to prevent any possible marring of the object being lowered by contact with the guard, this may be lined either at the top edge or throughout its entire height with strips or a protective covering.

Supports. The runway may be supported either by a solid post,—of rolled sheet steel or steel pipe,—running through the center, or may be suspended from the various floors. In the center post type practically all the load is carried by the post, in which case the support of the post at the base must be sufficient to carry the weight of the loaded spiral. In this type the runway should be securely attached to the center post by bands, set-screws, or bolts. In the open center with post type chute the load is carried to the post by horizontal and diagonal braces with steel or wood saddles for the runway. In the open center type chute, without post, provision must be made at each floor for the concentrated loads of the hangers or other supports.

Loading Points. Where only light packages are to be loaded no inlet slide or gate is necessary at the intermediate floors, the packages being loaded over the guard-rails. For heavy or unwieldy packages, however, particularly barrels, special slides from the loading floor to the runway are necessary. For ordinary packages where the guard-rail is cut to allow these loading chutes to enter the runway it is best to leave a section of rail from 4 in. to 6 in. high to preserve the continuity of the guard-rail control. Packages pass over this drop from the entering chute to the runway without damage. For the heavier or more fragile packages, however, the loading chutes should enter at the level of the runway, using a hinged or removable section of guard-rail. Another method of intermediate loading is to hinge a 90 deg. section of the chute, raising it to allow packages to pass under. Where there is automatic loading at intermediate floors it should be so controlled as not to collide with packages coming down the runway from above.

Discharge Point. At the bottom of the chute the

discharge is direct, either to table or floor or to conveyors. There should be a vertical dip in the exit slide to deliver the package smoothly. When heavy packages are discharged directly to the floor a steel floor plate should be provided to avoid wear on the floor. If the spiral discharges to a table, this should be designed to control the delivery as much as possible. Such tables are made either of gravity rollers or steel sheets or of wood, and may be either stationary or adjustable so that discharge may be made at convenient angles. For discharging at intermediate floors there should be either a hinged section of the chute, or a hinged or removable section of the guard-rail which may be counterweighted and controlled by a cable. In any case, the package must leave the spiral smoothly. Adjustable diverters, of whatever type, must be arranged for smooth operation and for secure locking into position.

Fire Doors. The opening in the various floors and walls should be so protected by automatic fire doors as not to appreciably affect the insurance rate on the building. These doors may be either hinged or sliding type, with fusible links which will melt at any set temperature and allow the doors to close. When hinged, the fire door may be used to form a diverter, so that when lowered it will discharge packages to the floor at which it is set. Where a chute is completely housed all openings in the housing should be protected by fire doors,—this housing is not necessary, however, to secure a fireproof condition.

Housing. For outdoor installations, or for certain conditions indoors, the spiral should be housed completely. This housing may be of any suitable construction material, although preferably black or galvanized sheet steel either plain or corrugated. In general 22 gage metal is satisfactory. Wherever there is danger of a condensation forming inside the housing this should be built as a separate unit from the guard-rail to prevent condensed water from running down the runway bed. However, where it is practical to have the housing form part of the chute it may serve to form the outer guard-rail, thus securing a less expensive chute. With this construction the housing should be heavier, preferably 16 or 14 gage. Such chutes are applicable mainly to indoor installations.

Painting. All parts other than galvanized should be given one coat of good paint in the shop and another coat on completion of erection. This does not apply to runway bed or inside of guard-rail, which should have a thorough application of graphite, wax, or similar compound if there is any rust present.

Operation

The very simplicity of operation of the spiral chute promotes a tendency to overlook even ordinary attention. Most of the trouble with spirals comes in the operation of loading points, diverters, and other special accessories. Particularly in lowering the more unwieldy packages, such as barrels and extremely heavy cases, the method of loading has much to do with successful operation of the chute. All packages should be loaded straight and near the guard-rail. In using diverters to discharge at the various floors such simple devices as signal bells, speaking tubes, or other methods of communication, speed up the operation and eliminate confusion by securing cooperation between the loading and discharge floors. Automatic loading from, or discharge to, gravity roller or other conveyor is easily accomplished at practically any desired point on the chute. Such points as this should be kept as close to the floor as

possible, to insure better control. If descending packages are not to be removed as lowered, a long discharge table or several sections of gravity conveyor are desirable as temporary storage. If the packages are fragile they should not be allowed to "back up" on the runway on account of the impact of the descending packages against those that have come to rest on the runway. Where the spiral is to be used largely for temporary storage in this way, the grade must be slightly more than where the movement of packages will be continuous, for certain types of packages will not start from rest on the low grade sufficient for continuous travel.

Under certain conditions the spiral runway may become rusted or coated with foreign matter, especially in handling sticky materials. Such condition arises generally from intermittent use of the spiral, and is easily remedied by occasionally sending a man down the chute with steel wool or graphite or wax or similar material.

Experience has proven that it is better to use bolts than rivets in some types of spirals. In such chutes the bolts should be tightened at intervals.

One limitation of the plain runway spiral is in the handling of open top boxes which must be kept practically level to avoid spilling of the contents. This, however, is an unusual condition. When it becomes necessary to make many changes in routing, or to accommodate a great range of packages, extra runways leading to different points make for better operation.

Wherever possible, spirals should be installed in such places as to be readily accessible from all sides for loading and discharge. For the same reason the open spiral is generally more simple of operation control than the fully housed type.

Cotton—Wool—Paper

Heavy Bales—Bags

As the most direct means of lowering heavy bales of cotton, wool, waste, paper, and similar commodities, the spiral chute provides the best known auxiliary to car or

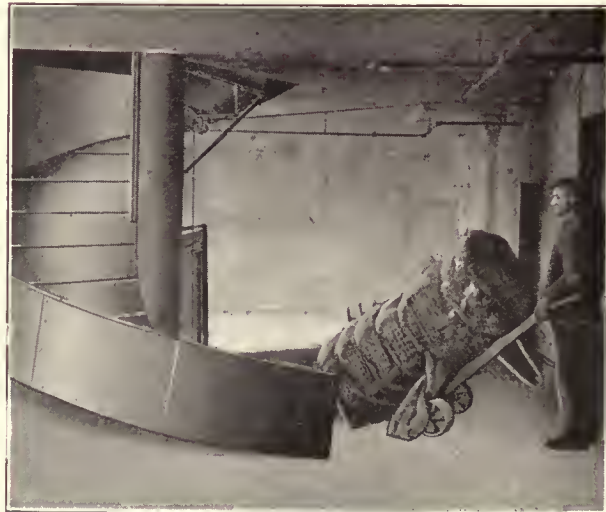

Loading Heavy Bales Through Inlet Gate

truck loading in textile and paper mills or warehouses. To give the utmost economy in handling such heavy bales, the chute should discharge as close to the outgoing truck or car as convenience on the upper floors will permit.

Often, in the larger warehouses, several chutes are installed at convenient points to avoid long haul trucking on the upper floors.

For this service, which is generally intermittent, a galvanized steel runway of 10 or 12 gage steel, preferably the latter, is particularly desirable. The usual widths of runways are from 48 in. to 60 in. Extra strong supports and bracing are essential to resist the impacts of the heavy hales. Grades of from 20 deg. to 23 deg. at the outer guard-rail are best,—the loosely packed wool bags requiring the higher grades. The guard-rail should be 18 in. to 21 in. in height. Loading should be done by inlet slides and loading gates, and, if diverters are used at the intermediate floors, they should be of unusually heavy construction.

Seeds—Feeds—Flour

Bags—Baskets—Cartons—Boxes

In the busy seasons peculiar to seed and feed stores and warehouses, spiral chutes are particularly valuable not only in speeding up the delivery of orders to the customers or shipping floor, but in avoiding loss of time through congestion and confusion. In collecting orders for shipment the spiral can be used advantageously in connection with belt conveyors at top, bottom, or inter-



Saving Space Around Open-Center Spiral

mediate floors. When fairly uniform packages are lowered, the entire length of the chute may be used as temporary storage, and the packages removed only as needed. Where very small and light packages have to be handled, these may be lowered in baskets, and the baskets carried back to the upper floors on platform or continuous motion elevators. However, if a pitch slightly greater than usual is allowed there should be very little need for baskets.

A runway width of about 36 in. is usual, although widths in particular cases vary from 24 in. to 42 in. For this service 14 gage steel is satisfactory, although 16 gage will give good service. For ordinary bagged material grades of from 19 deg. to 23 deg. at the guard-rails are generally best. While guard-rails of 12 in. are satisfactory, 15 in. to 18 in. heights provide for a greater range

of packages. Unless unusually heavy packages are to be lowered the loading may be done over the guard-rail. It is preferable that the chute discharge to a table. Intermediate discharge may be accomplished in flat runway chutes by hinging inward or removing a section of the guard-rail,—allowing the package to leave the chute by centrifugal force.

Wholesale Houses

Miscellaneous Packages

In wholesale dry goods, shoe, groceries, clothing, and similar supply houses, the spiral chute, handling practically every type of package, from the lightest paper carton, to heavy barrels and boxes, expedites the filling of orders and insures their prompt and uniform movement from the various floors to the delivery and shipping departments. Regardless of the generally miscellaneous character of packages it is often feasible to use a gravity conveyor in loading to or discharging from the chute. This materially reduces handling at both ends. Where this is not practical, gathering boxes mounted on low trucks are often used, being moved from pile to pile in collecting the orders. The time usually required to load the contents of the truck at the top of the spiral and reload at the bottom is entirely eliminated by sliding the box with its contents from the truck onto the spiral runway and having it received onto a similar truck at the discharge point. To give the greatest economy in handling, the chute should be located so that it discharges as near the outgoing loading platforms as the conditions existing on the upper floors will permit.

If the spiral is apt to be subjected to conditions of dampness galvanized steel is preferable to blue annealed for this service. Unless packages heavier than 300 lb. are to be handled 14 in. gage steel is satisfactory. Grades of from 18 deg. to 25 deg. at the outer guard-rail are usual.



Open-Center with Post Type

A runway width of 42 in. is of advantage in providing for a wide range of packages, although 36 in. is good practice for the average service. Likewise, an 18 in. guard-rail is preferable, although 12 in. is probably the more usual practice. It is seldom desirable to fully house

such supply house chutes, except as unusual individual conditions may require.

Hardware

Wood Trays—Tools—Fittings—Tote Boxes

The feasibility of handling such extreme shapes of packages as garden tools, wheels, pipe fittings, kegs of nails, tubs, etc., directly on the runway makes the spiral chute very useful as a part of a system of collection and



Double Runway Concave Bed Spiral

distribution between various departments in wholesale or retail hardware houses. While most of the packages are handled directly on the chute, small and irregular objects, which should be handled collectively, are lowered in trays or tote boxes, and the boxes returned by elevators. Often this system of tote boxes is extended to include the use of large gathering boxes or hampers. These are moved about on low trucks or conveyors in collecting the orders, then loaded, box with contents, onto the spiral and received onto similar trucks or conveyors at the discharge point.

Where metal parts or pieces, not packaged, are handled directly on the chute, or the tote boxes are metal bound, a cast iron runway is preferable because it better resists abrasion. If the chute is of steel, a 12 gage runway of galvanized or black steel is recommended for this usually hard service. Widths of runway of 36 in. or 42 in. are usual, unless special conditions demand a greater width. The heavy weight of the general run of packages requires relatively low grades of from 16 deg. to 21 deg. at the guard-rail. Since the tote boxes and packages handled are generally low, the guard need seldom be over 12 in. high. With the usual run of extremely irregular packages incident to the hardware business it is best to avoid special diverters or other accessories so far as is convenient.

Under certain conditions it is sometimes desirable to place the chute adjacent to offices or in other localities in the plant where the noise resulting from the metal parts or boxes running down the chute is sufficient to cause annoyance to employees. Such disturbance, however, can be

largely overcome by providing a housing which is detached from the chute itself.

Department Stores

Parcels—Baskets—Bundles—Boxes—Cartons

By delivering parcels direct from the various floors to the wrapping or delivery rooms, spiral chutes not only eliminate confusion, but save the time of elevators needed for other purposes. In mail order, and similar houses, the spiral lowers hampers into which orders have been collected, to the lower floors for checking and shipping. Working in combination with belt conveyors the spiral has done probably more than any other handling equipment to simplify department store operation.

For this purpose a runway of 16 gage steel will give good service, although 14 gage is better practice. Runway widths of 30 in. to 36 in. are most serviceable. Because the general run of packages to be handled is light, the pitch or drop per round should be greater than for standard package chutes,—preferably 23 deg. to 30 deg. grades at the guard-rail,—to insure the packages traveling satisfactorily. Since the loading points and directions are generally restricted it is often necessary to change the pitch to meet the varying floor heights. As a rule the closed or center post type spiral is best adapted to the limited space available in department stores. A fully housed chute is desirable because of its better appear-



Delivering from Sales to Shipping Floor

ance, although the open type, when placed in a shaft, and with high guard-rail, is thoroughly satisfactory. In using the open type, even though in a closed shaft, the guard-rail must be made higher for a half round or so at the loading points to prevent the throwing of light packages over the guard in loading.

General Warehousing

Miscellaneous Packages

No type of equipment can claim more saving in the time of men, road trucks, or cars on warehouse sidings, than the spiral chute. Probably the greatest saving is made in those houses where it is the custom to load the spiral with practically the entire load of goods before the truck

arrives, thus avoiding double handling by using the spiral as temporary storage. Diverters on the various floors cut out the loss of time through slow moving elevators in transferring goods between floors.

Because of the wide range of packages to be handled, often varying from the lightest paper cartons to the heaviest packing cases, warehouse spirals are probably the hardest of all for which to determine the proper grade. However, grades of from 18 deg. to 25 deg. at the outer guard-rail are usually satisfactory. The runway may be either flat or concave. It should be 12 or 14 gage, and not less than 42 in. (preferably 48 in. to 60 in.) in width to provide for the larger packages. Since very bulky objects are handled, the guard-rail should be not less than 15 in. and preferably 18 in. to 21 in. in height. A housing is usually unnecessary and does not allow as free access to the spiral as the open type. For warehouse duty wherever a wide range of package sizes and weights must be handled, the multiple runway spiral is recommended.

Where blue annealed steel is used and is subjected to dampness either from the packages or the climate, as is particularly true in marine warehouses or piers, occasional

transferred from floor to floor from the first washing of the incoming bottles through the filling, sealing, labeling and packing processes.

Because of the great care necessary in handling such fragile objects the grade of the spiral should be determined with unusual accuracy from the results of previous experience, and should be designed to fit a relatively narrow range of packages. Where it is required to handle several different types of packages a multiple runway spiral is recommended. Runways of 14 gage steel, from 30 in. to 42 in. wide, are customary. A grade of from 16 deg.

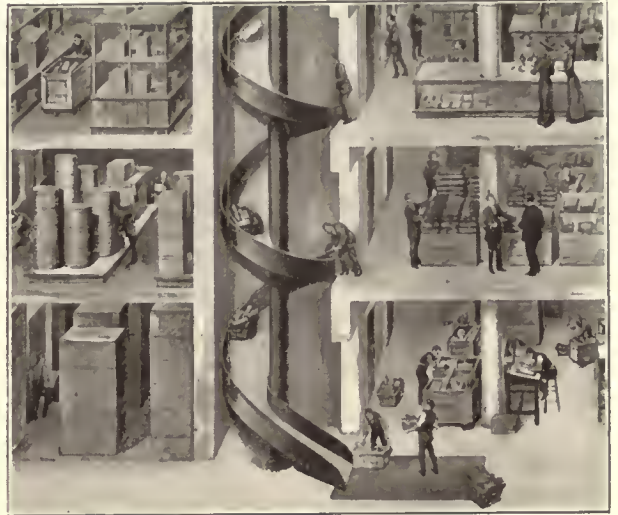

Handling Bottles in Baskets



Loading Over Guard Rail

attention to the runway is necessary because of the formation of rust when the spiral is not in use. This rust may be easily removed by rubbing the runway with steel wool, with powdered wax, or graphite. As a rule warehouse spirals are subjected to more severe usage than in other industries. For this reason when loading gates, diverters and other accessories are necessary, these should be kept in good working order.

Drugs and Chemicals

Bottles in Boxes—Trays—Cartons—Barrels

The handling of fragile packages common to these industries has been one of the hardest tests of the application of the friction runway spiral. Not only are loosely packed bottles of chemicals, drugs, and perfumes in cartons or boxes lowered by a spiral from the packing tables to shipping room or storage, but cases and trays of glassware are

to 21 deg. at the guard-rail is usual. The guard-rail should be 12 in. to 18 in. in height. It is advisable to provide loading gates and inlet slides to make smoother loading at intermediate floors for the more breakable packages. Such spirals should, where practicable, discharge to a gravity roller conveyor. In general the packages should not be allowed to "back up" on the spiral because of the impact of the moving packages striking those which have come to rest. Careful study should be made of the possible effect of leaking acids or other contents on the sliding parts of the chute.

Packing—Canning—Preserving

Cases of Cans—Boxes—Cartons

Short spirals placed at convenient points bring empty cans and cases to the packers and convey packed boxes from the packing tables to marking and shipping rooms, eliminating the time and confusion of horizontal movement. This is particularly desirable in the short season canning industries. Used in combination with gravity conveyors and push bar elevators, the spiral chute forms an essential link in what is probably the most economical system known.

Runway widths of 18 in. to 36 in. are satisfactory for the usual run of packages, 24 in. and 30 in. runways being most commonly used. It is generally good practice to use 14 gage metal, but 16 gage will serve for the lighter duty. Twelve inch guard-rails are satisfactory except for the more bulky containers, when 18 in. is better. Loading should generally be done over the guard-rail. If it is desired to divert packages at intermediate floors, either the runway should be terminated at such points—and started again—or adjustable diverters should be provided. Grades of from 18 deg. to 22 deg. at the outer guard-rail are best,—

the steeper pitch for the paper board carton. In such seasonal service as is usual in canning plants, the spiral will often be found to be sluggish at the first of the season

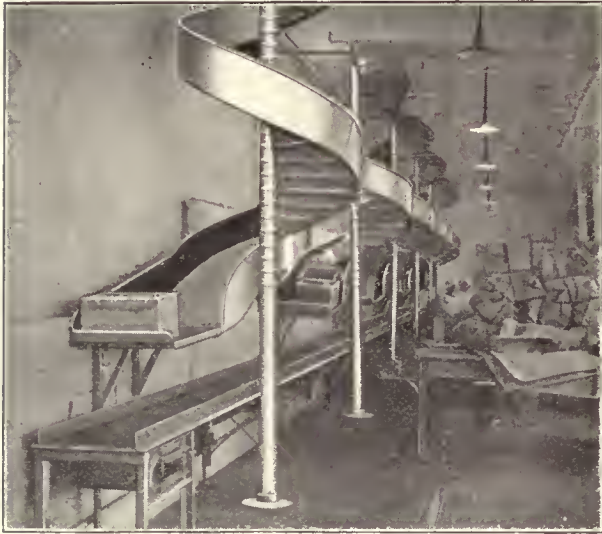

A Bank of Distribution Spirals

because of rust or other accumulations. This is easily overcome by the application of powdered wax, graphite or similar material.

Bottling

Cases of Bottles—Barrels—Cartons—Boxes

The belief that the friction runway spiral is more limited in handling packed cases of bottles or other glassware than the roller runway spiral has been dispelled by innumerable successful installations. These results have been accomplished by careful consideration of proper design and the application of the right spiral to the work to be done. The small space required and the lower cost of installa-



Diverting to Roller Gravity

tion are the chief advantages of the plain runway type, over the gravity roller spiral. Spiral chutes are particularly adaptable to systems of gravity conveyors in the washing, filling, labeling, packing and dispatching of bottled goods.

For handling cases of bottles, runways of 14 gage steel and from 30 in. to 36 in. wide are usual, with 9 in. to 15 in. guard-rails. Intermediate loading and discharge points are to be avoided where practicable, and, if used, the adjustable parts should be very carefully fitted. Grades should be from 16 deg. to 21 deg. For handling such fragile packages the grade should be set to fit the specific objects to be handled, and not to fit various types of packages. If necessary, for instance, to handle metal bound cases of loose bottles on the same spiral with paper board cartons, it is best to have two runway blades with different diameter, and grade, at the outer rail.

Analysis of the manufacturing and storage operations of steel and iron products industries shows a surprising number of spiral chutes handling not only the usually accepted types of packages, but objects of the most irregular shapes and sizes. By using spirals of large radius pieces up to 8 ft. and 10 ft. in length are easily lowered. Stoves and parts, castings, stampings, boilers, tubs, and many other similar metal products, travel between operations or from packing to shipping floors.

Steel and Iron Products

Tote-Boxes—Stampings—Castings—Parts

Runway widths for handling the usual tote boxes are from 30 in. to 42 in. Particularly where the boxes are metal or metal bound, the grades should be from 16 deg. to 20 deg. at the outer guard-rail. While black or galvanized steel of 12 or 14 gage is generally satisfactory, cast iron runways are better for the more abrasive objects. If the noise of the metal boxes or packages traveling down the runway is sufficient to be objectionable, this may be overcome by a housing detached from the chute itself.

Runway widths for handling the usual tote boxes are from 30 in. to 42 in. Particularly where the boxes are metal or metal bound, the grades should be from 16 deg. to 20 deg. at the outer guard-rail. While black or galvanized steel of 12 or 14 gage is generally satisfactory, cast iron runways are better for the more abrasive objects. If the noise of the metal boxes or packages traveling down the runway is sufficient to be objectionable, this may be overcome by a housing detached from the chute itself.

Textiles

Baskets—Rolls of Cloth—Boxes—Bales

In the lowering of boxes or baskets of bobbins from floor to floor, as well as in the handling of bales of cotton, wool, jute, and similar raw materials, spiral chutes have solved some of the biggest problems in textile mills and finishing plants. Instead of dragging the baskets of bobbins down congested aisles from roving frames to elevators, and repeating the trip on the spinning floor, the baskets are dispatched by spiral chutes at convenient points to the floors below. Here they are received on conveyors or trucks which distribute the bobbins to the spinning frames. In handling heavy bales of wool or cotton, the spiral reduces the cost of labor between the receiving room and the bale breakers. Rolls of cloth in process find the spiral the most direct method of travel between operations, and bolts of finished cloth, carpets, and other textiles, are lowered by spiral to the shipping and packing rooms. It is in the textile mill of three or more stories that the economy of the spiral is most evident.

For this service runways of 14 gage metal, from 30 in. to 36 in. wide, with 12 in. to 18 in. guard-rail are usual. For handling baskets a grade of from 18 deg. to 22 deg. is sufficient, but for bolts of cloth 20 deg. to 28 deg. will be required. Hand-loading at the intermediate floors is

best done over the guard-rail, rather than with loading gates or inlet slides. When the spiral is loaded from con-

veyors, however, the guard-rail should be cut down to allow the entrance of the inlet slide. in the same chute with heavy cases or barrels some definite system of signaling should be used to avoid congestion

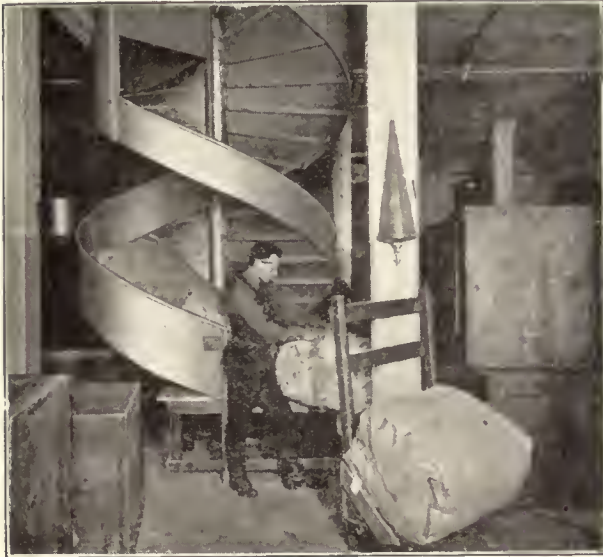

Delivering from Housed Chute to Floor

veyors, however, the guard-rail should be cut down to allow the entrance of the inlet slide.

**Confectionery—Chocolate—Cocoa
Barrels—Crates—Boxes—Cartons—Bags**

The extreme range of packages used in the confectionery industry, from paper cartons of a few ounces in weight, to the steel hooped barrel of 300 lb. to 400 lb., has demanded unusual attention and study in the design and application of spiral chutes to meet these exacting conditions. For the more extreme variations the most successful results have been secured by using a double runway spiral with one runway of less diameter, and consequently steeper grade than the larger one. Working with gravity or power conveyors, in the handling of empty cases to the packers, as well as in the removal of the filled cases to storage or cars, the spiral is proving most economical.

Since the handling of barrels is probably the hardest service required of any type of chute, concave runways of from 14 to 12, or even 10 gage, are generally used. If the weights are not over 500 lb., and the abrasive nature of the package not excessive, 12 gage metal gives excellent service, and for the ordinary weight of barrels 14 gage sheets, well braced, are satisfactory. For the heavier, more abrasive types of barrels cast-iron makes an excellent runway material. For standard barrels, not over 24 in diameter by 36 in. long, runway widths of 36 in. to 42 in. are customary, with a grade of from 16 deg. to 21 deg. at the outer guard-rail. Guard-rails should be not less than 18 in. high, and preferably 21 in. to 24 in. It is better to discharge such heavy packages direct to the floors, rather than to tables. Loading should be done on inlet slides with adjustable loading gates so fitted to the chute that the barrel will be properly started on the way down the chute.

In handling sugar, cocoa, salt, or materials of a sticky nature, especially in leaky containers, it will be necessary at intervals to clean out the spiral with steel wool or brush. Where the smaller paper cartons are to be handled



Delivering from Spiral to Truck

and breakage. In handling the heavier packages special care must be given to the setting of diverters or other adjustable accessories.

**Baking
Cartons—Boxes—Metal Caddies**

In lowering packed cartons, boxes, or caddies from the packers to temporary storage or shipping rooms, spiral



Spiral Delivering to Discharge Table

chutes are applied very economically to cracker, small cake, macaroni, and other similar baking plants. Used with short runs of gravity conveyor, these chutes eliminate the confusion and needless moving from floor to floor common to most bakeries. For lowering barrels, bags, or empty boxes from the car or truck to basement storage, short spirals leading to gravity or power conveyors materially reduce the cost of such handling.

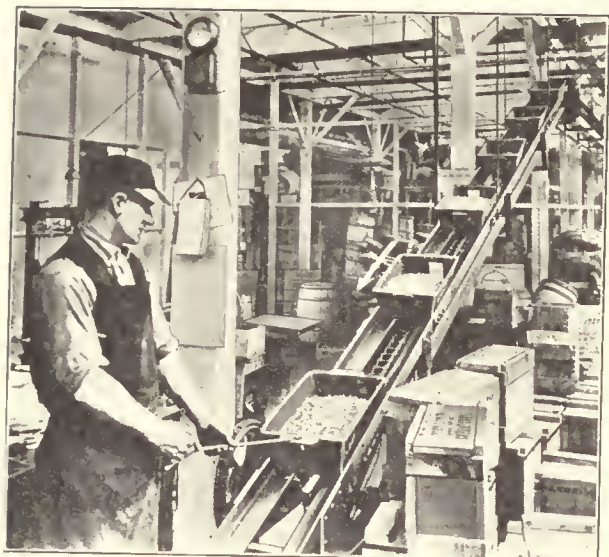

Haulage Conveyor Handling Boxes



Barrel and Sack Elevator-Conveyor

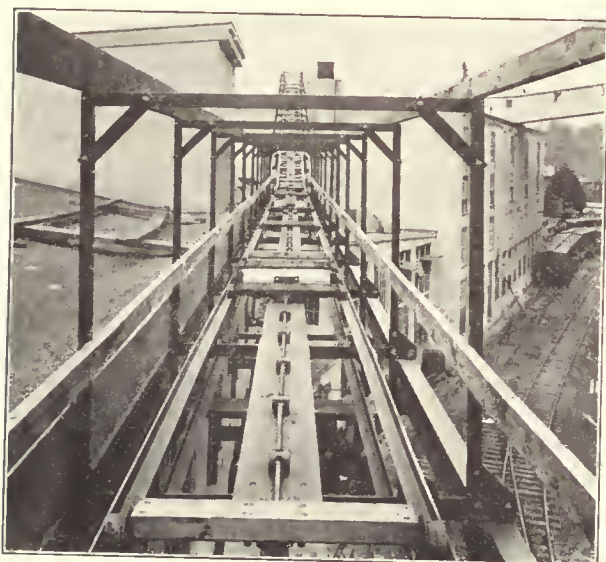

Monobar Conveyor for Boxes

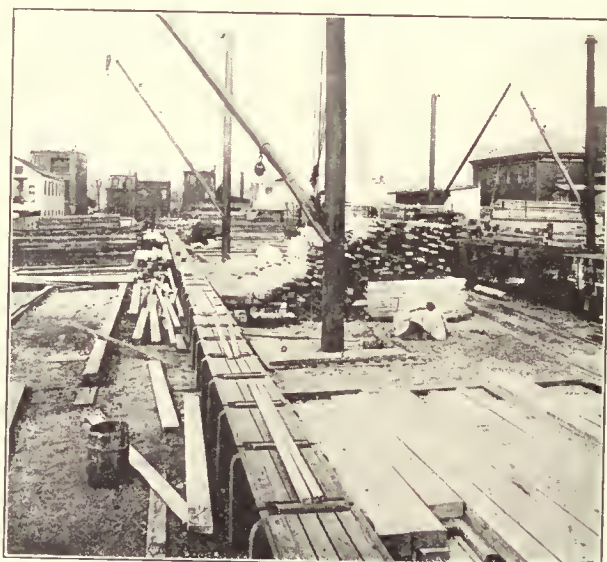

Live Roll Conveyor for Lumber

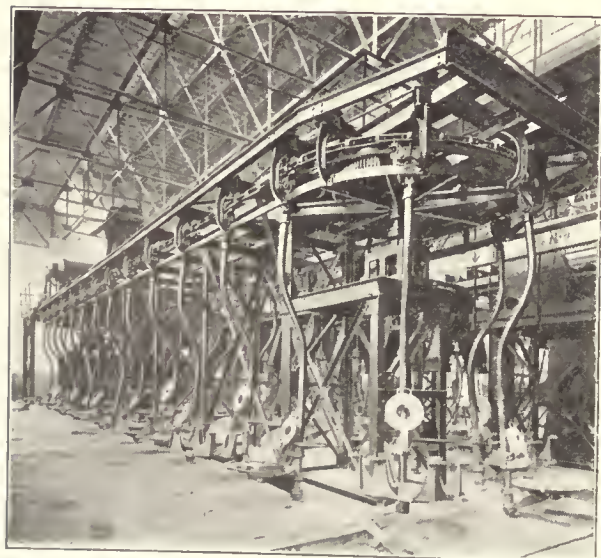

Mold Conveyor for Foundries



Loading Tower and Suspended Spiral

The design of a chute to handle packages with such fragile contents requires particular attention to the type of package to be handled. If possible, a separate runway should be provided for the metal caddies from that used for paper cartons and wood boxes. For bakery service the galvanized steel chute is preferable, particularly where the chute must operate under moist conditions. Runway widths of from 30 in. to 36 in. are usual, with 14 or 16 gage steel. The grade should be from 18 deg. to 25 deg. at the outer guard-rail for paper cartons, while from 16

deg. to 20 deg. is sufficient for the metal caddies, which slide more readily. Guard-rail heights of from 12 in. to 18 in. are customary. Automatic loading from gravity with an inlet slide is best. Loading gates are not necessary with hand loading, because of the light weights handled. While not an essential feature of operation, it is recommended that the spiral discharge to a line of gravity roller conveyor. The packages should not be allowed to "back up" on the spiral runway, so that descending packages will strike those that have come to rest.

Special Elevators and Conveyors

In addition to the general classes of elevators and conveyors described in the preceding pages, there are many machines, including haulage, overhead track, pneumatic, wire line and other conveyors which, while no less standardized, are rather special in their design and application. This does not mean that they must be designed and developed for each installation, for most of the machines considered in this section have been operating successfully for a long time. They are here classed as special machines rather because their range of application is more limited than the standard types previously described.

Some of this equipment, such as wire line and pneumatic carriers, generally known as store service equipment, has been as widely used as any of the package conveyors, but are here treated with less length mainly because they are used almost universally for the carrying of messages, special containers, and the lightest parcels, rather than for general commodity handling. Less space is also given to the other special types of machines, not because they are any the less useful where applicable but because their use is more limited. One of the chief advantages resulting from a special machine of any kind is the fact that such equipment, while naturally more limited in scope, is even more likely to attain the maximum economy, by reason of being fitted more directly to the work to be done.

While the various types of these haulage, overhead track and pneumatic tube machines have been so widely used as to become thoroughly standardized, there remain many special elevators and conveyors whose installation is even more a matter of application than the more generally used types already discussed. This does not mean that the machines themselves are any less highly developed, but that, because they are very specialized in their purpose, more care should be given to their selection to fit any individual need. The prospective purchaser should not consider special equipment as consisting of experiments worked out at his own expense for, as before said, there are very few handling operations for which some machine has not been developed and standardized to do the work more economically than it can be done by hand. Good illustrations of special conveyors which have for this reason been unusually successful in their application are automobile and other manufacturing and assembly conveyors, newspaper elevators and ship loader-unloaders of both the sling and truck-carrying type. Many of these special elevators and conveyors approach very closely in character the standard types of machines described in the preceding pages. For example they are in most cases made up of units very similar to those which enter into the construction of the latter machines. However, they should not be confused with the main classes of machines because of such apparent similarity in design, for their application is decidedly different.

The success of machines applied to specific purposes has brought about a tendency toward more direct application of all types of continuous elevating and conveying machinery. This has resulted in the development of many special machines based on the more commonly known types. In so applying equipment more specifically to the work to be done, some of the carry-all capacity of the general carrier is lost, but this is often far more than offset by the increased efficiency of the special machine.

While most of this equipment has been brought to a sufficiently high point of development to insure proper mechanical operation, special attention should be given to the training of the actual users in the possibilities of each machine. A similar caution applies to maintenance. One of the most important considerations in the operation of any machine designed to fit a definite special purpose is that the machine is used only for the purpose for which it is designed. This applies not only to the commodities handled but to the conditions under which it operates.

Haulage Conveyors and Elevators

While as a conveyor alone, the haulage type has remained quite limited in its use, the installation of ramps and other more direct routes of travel in old buildings, offers many new uses for the elevator-conveyor designed on this principle. The chief advantages of this machine lie in its simplicity of installation and the ease of pick-up and discharge of trucks. By combining a small amount of manual handling of trucks with power haulage a very economical conveying system results.

Boat Unloading

No freight handling operation offers more opportunity for economy than the elevating of trucks from the varying deck levels of side-port steamers. Of the two general machines ordinarily used for this purpose—the heavy slat elevator and the truck-haul—the latter is, as a rule, simpler of installation, operation and maintenance. The pushers attached to the chain at proper intervals grip the truck in fully as positive a manner as the special slats of the former type elevator. With the apron elevator, on which the man rides as well as the truck, trouble is sometimes apt to arise with careless truckers, through the fact that the man must step off at the top of the incline and start pushing the truck. But with the truck-haul, where the trucker walks up the incline, with his truck, there is no break in his travel at the top of the elevator. The outer end of the truck-haul ramp, as was the apron elevator ramp, is supported by cables attached to the pier construction above. By hinging this ramp at the inner end the level of the outer end is made to follow any rise or fall of deck level of the boat.

To insure the smoothest discharge at the top and eliminate the quick jerk incident to turning the chain sharply downward over an end sprocket the chain should be run down gradually into the floor until the pushers pass below the level of the pier floor. In this way the truck is released smoothly. If these pushers are kept close together the pick-up of each truck is accomplished with little shock to the elevator. The speed of the chain should be set to be the same as that of a man walking on the level in trucking ordinary loads. Where these conveyors are driven by motors and reducing gear below the floor, the most effective arrangement for keeping the ramp clear, spe-

overhead conveyors have been successfully built and operated of sufficient strength to carry the entire load of the truck instead of merely propelling it. These truck-hauls become practically mono-rail conveyors. Automatic switchouts or storage stations are provided which avoid the necessity for continuous attention. Such a combination of a small amount of manual trucking with automatic conveying makes available the advantages of continuous handling in warehouses in which individual packages conveyors would not be flexible enough to reach all points of the storage piles.

Where the load of the truck is carried by the floor or on tracks, a very light overhead construction is usually sufficient. However where the loaded truck is suspended, clear of the floor, from the overhead construction, these supports must be much more secure. Low loading platforms from 2 in. to 3 in. above the floor, onto which the trucks are pushed up inclined ramps, make easier loading and unloading.

Overhead Track Conveyors

Overhead track conveyors have a limited but broadening scope of use. The addition of power driven chains, with pushers, to the much used monorail has resulted in a conveyor well adapted to continuous assembly systems particularly where the pieces are light enough to be easily lifted on and off the hooks or other carriers. These conveyors are widely used in metal products, bottling and textile and many other industries in which it is essential that the floor space be kept clear. A type of trolley extensively used in store service work is the wire line carrier so common to dry goods, drugs and other retail stores.

Metal Products

A type of overhead track frequently used in assembly and other processes in the manufacture of metal products of lighter weight is shown in the illustration. This conveyor



Truck Haul

cial attention should be given to providing for regular lubrication and other necessary care. Some of these elevators are provided with overload releases, so that while they will carry any ordinary load, the conveyor will be stopped upon coming in contact with any obstructions.

Textiles and Finishing Plants

Long truck hauls are common between different departments or buildings of textile, shoe and other plants in which it is customary to keep the product on trucks. In such cases truck-haul conveyors, either in the floor or overhead,



Hauling Trucks by Overhead Conveyor

save time and labor in pushing the filled trucks. The two-way capacity of this conveyor makes it particularly valuable in that it will simultaneously return the empty trucks by the return strand of the chain. Such a conveyor is not only simple of installation, but is unusually flexible. Trucks may be handled by hand between the line of travel of the chain and the adjacent storage piles or machines. Such



The Overhead Conveyor Saves Floor Space

consists of a standard or special chain running on a light overhead rail. The fact that these conveyors, like all overhead track systems, will usually travel in a horizontal plane makes them useful for conveying throughout their entire circuit. Running at very low speeds, such a conveyor is excellent for drying pieces which have been painted. By carrying the track back and forth through the open room, or through steam or other drying rooms, the painted piece may be left on the hooks as long as required, the conveyor in this way serving as temporary storage. The fact that this storage is overhead, leaving the floor clear for opera-

tors or machines, is a valuable consideration in many plant layouts. In some cases the entire conveyor line is gradually filled during the day and the pieces left overnight. By providing the driving mechanism with two speeds, such a conveyor may be emptied within a very short time before the painting work starts the next morning. Such overhead track conveyors are frequently used where it is desirable to have two continuous conveyors cross each other. For example, conveyors of this type will frequently be found crossing over a line of gravity or apron conveyor.

A free-running chain, supported from the track above by roller attachments, is most commonly used for this work. These attachments also provide for the fastening of hooks or other hangers below, so that each load is suspended directly from the track and the chain serves only the purpose of tying together and propelling the hangers. Such hangers take practically every form and shape, from the simple hook to the rack into which a number of parts are placed. Their design should be governed mainly by the ease of attaching and removing the load.

Packing House Products

The handling of packing house products from the first process to the final distribution is a service to which the overhead track system is particularly adapted. While most of these overhead tracks are pure monorail systems on which the packages are hand-propelled, or travel by gravity, the use of power-driven chains with pushers makes a big saving over the old method in many cases, except in the very short runs where the packages will run by gravity. Such a power-driven system is valuable not only in propelling the loaded carriers forward, but also in automatically returning the empty carriers on the return run of chain. Where the movement of meat is in too many directions, it is usually not advisable to equip more than the trunk line with power, the individual pieces being pushed by hand from switchouts at convenient points along the trunk to their destination. In this way the combining of a small amount of manual handling with long conveyor runs results in a very economical and flexible layout. In the shipping of



Packing House Conveyors

meat, particularly in warm weather, the great reduction in the time the meat is out of the refrigerator alone warrants the use of continuous power propulsion.

The picture shows a system with unusually heavy overhead supports, laid out to serve a line of freight cars. Switches and cross-overs provide for distribution to branch lines. For this purpose tracks of various cross sections, from the T section to the fully enclosed type, are in use.

The hangers should be carried on free-running roller bearings. Hooks, as well as other types of hangers are commonly used, although the noose type shown is usual for handling frozen meat.

Automobiles

The overhead track conveyor shown illustrates about the simplest type of this class, and one which has been very successfully used. One of the chief advantages of such a conveyor is the space saved with the resulting freedom of floor movement. In manufacturing processes where the conveyor



This Type Is Useful for Painting and Drying

is used to carry pieces between different machines or operations, it acts as a temporary storage system, in that every piece is free to travel around the circuit until finished. The flexibility of this type of conveyor, with the small space required, makes it very efficient in connection with the various assembly conveyors used in this and similar industries.

For the handling of such light loads as shown, very light track and overhead framing is sufficient. In this installation a standard chain attachment equipped with rollers runs in the inclosed steel track which is supported at intervals of about 3 ft. to the timber above. This attachment prevents the objectionable sway so common to many overhead installations not so securely braced. Plain, detachable link chain is usually satisfactory. In order to prevent excessive sag of the chain between the suspension points where the hangers are more than about 4 ft. or 5 ft. apart, it is advisable to provide extra chain hangers with rollers running in the track above. The type of hanger varies according to the type of package handled. The most important point in the design of the hanger is to insure ready attachment or removal of pieces in process.

Special Chain Conveyors

The simplest type of chain conveyor consists usually of two or more strands of chain running in smooth tracks. These conveyors are similar in construction to the push bar conveyor. In most of them, however, the package is supported on the chain itself, whereas with the push bar type the package is pushed or dragged along the track or runway. These conveyors are best adapted to boxes or other firm packages which have no tendency to be caught in the exposed chains. Ordinarily such a conveyor requires more careful loading and is less flexible as to diverting than the apron or belt types. Its chief advantage lies in the simplicity of installation and the light weight of the moving parts. The saving in power which naturally accrues from

the latter feature, is, in most cases, offset by the fact that the sliding friction of the plain chain, commonly used, is greater than that of the roller chains most used with the standard types of push bar and apron conveyors.

For some long and narrow packages a single strand of very wide special chain is sometimes used. However, from two to four strands is the usual arrangement. Since the



A Convenient Type for Handling Boxes

packages generally rest directly on the chain, roller chain is not often used in this type. Because of the plain chain the tracks on which it slides should be kept well greased and free from dirt. Small channels, with flanges turned up, form convenient chain tracks. Frequently special attachment on the chains forming small carriages or pushers are provided for the carrying of objects of special shape. Such an arrangement approaches very closely the character of the roller carriage type used so much in automobile assembly work.

Assembly Conveyors

Double strand chain conveyors of special design have been much used in the assembly of automobiles. These continuously-moving "work benches," running at such speed as to promote the maximum output of each workman, have practically revolutionized the quantity production of pleasure

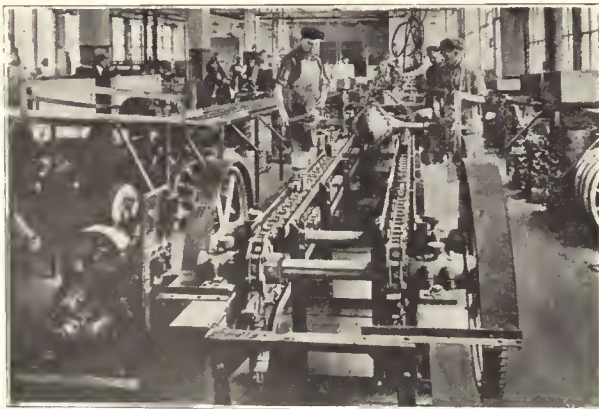

Double Strand Assembly Conveyor

cars, trucks and tractors. The resulting better organization of production is usually an even greater advantage than the

actual saving of labor and time of moving materials. In order to reduce to a minimum the time of attaching small parts, these parts are sometimes placed in racks which are carried on the moving conveyor immediately behind the moving chassis or other unit. Since these racks follow the chassis the parts are always at hand. A high development of this method has been very successful in the quantity production of farm tractors.

The special carriage for the support of the unit or car in process may take any one of many different forms, but must securely hold each piece on which work is being done. A hinged attachment to the chain forms a good support, and one which is readily fastened to or removed from the piece being assembled. The proper height of these moving tables depends on the operation being performed, but is usually from 24 in. to 30 in. above the floor. Where it is difficult to fit the height of the entire conveyor line to all operations, it is advisable to have certain of the operators stand on low platforms. To afford the most economical operation of such an assembly conveyor the parts to be attached to the unit or chassis as it moves forward should be fed to the line of travel with the least possible confusion. Probably the most satisfactory method of doing this is by means of other conveyors or chutes which bring in these parts from machine shops or other storage buildings. Such conveyors should deliver from the side to the line of travel at the point at which they are to be attached.

The continuous assembly of automobiles has become standard in all plants operating on a quantity production



The Finish of the Assembly

basis. The advantage gained lies not only in the actual saving in the labor of moving the different parts—although this is usually appreciable—but also in the organizing effect of the continuous movement of the car and its parts through the entire assembly. The illustration shows a car mounted on a special carriage being moved sidewise in final assembly. Where assembly layout conditions permit it, some space is saved and the special carriage eliminated by having the car carried lengthwise, its wheels being carried directly on two lines of conveyor. The decrease in handling costs, due to progressive assembly with conveyors, has been so pronounced that, in the more modern quantity production plants practically every part moves on some type of conveyor from the time it leaves the foundry or machine shop, through the chassis and body assembly, paint shop, drying ovens, to its final assembly, when the car leaves the conveyor on its own wheels. In such a system the various parts to be assembled are supplied by auxiliary conveyors at the proper point along the main conveyor line as the assembly progresses.

For this service both single and double strands of chain are used to propel the carriages. Carriages or platforms of many different types are used, but all based on a somewhat similar principle. As convenience in working frequently makes it necessary to support the car at some height above the floor, carriages with high standards are often used. To avoid the necessity of providing a pit under the conveyor for the return carriages to travel in, these standards are sometimes made collapsible so that they automatically fold up upon reaching the end of the conveyor and return within a very small space. In other systems these carriages, while propelled by a chain, as shown, are not actually attached to the chain. At the end of the conveyor the tracks carrying the now-empty carriage are tripped, allowing the carriage to disengage from the chain and run back by gravity to the starting point. The most important point of design in all assembly conveyors of this type is to insure smooth travel of the carriage either loaded or empty, particularly where it travels over the end sprockets at the end of the conveyor.

Sling Type Carriers

The sling type carrier affords one of the most economical methods of loading and unloading packages of fairly uniform size, weighing up to about 200 lb. in and out of ships. In loading packages it is comparable in speed and careful handling with the combined belt, or apron, elevator and chute systems. Because of the greater work done in lifting cargo from the hold of the ship it is even more efficient in unloading than in loading. One of the biggest advantages of such a loader is that, while it will not handle the heavier pieces of general cargo, it carries the lighter cargo through the same hatch into which the ship's hoist is handling the heavy loads. Because of the character of the slings, packages are handled with greater care and safety than is possible with the usual hoist method. Obviously, with the continuous stream of packages handled, the capacity is very high. These sling type machines are built in both stationary and portable form, the difference in manner of supporting being the chief variation. Obviously, with fixed support, the machine may well be heavier and carry greater loads than the portable machines.

Portable Type

The advantage of the portable type is that it can be readily moved from one hatch or ship to another. The machine is usually lifted from its detachable carriage into position by the ship's hoist. Then after being "blocked up" and the terminals lowered into operating position, it is ready for service. When the work in any one hatch is completed it is lifted back onto its carriage on the dock, in housed position, and moved by hand to the next hatch or shipside. Because of the greater weight required if the machine were to handle heavy packages, this portable machine is limited to packages of about 200 lb. in weight and of the approximate size of 2 ft. diameter by 6 ft. long.

The frame of this machine is made as light as is consistent with reasonable strength and wear. Because of the necessity of easy moving from place to place, and handling with the ship's derrick, this is particularly important with the portable machine of this type. For average service light steel angles rigidly trussed and cross-braced are used. The cross bars, placed usually at intervals of about 3 ft. 6 in., are generally formed of two pipes, the outer one turning freely on the inner. The slings should be of heavy canvas, specially reinforced where looped over the cross-bars. The length of life of these slings is surprisingly long. In ordinary service this runs from six months to two years, after

which they are easily replaced at a reasonable cost. The two chains should run at a distance apart slightly greater than the longest package to be handled. They are usually pintle or other standard types, the size depending on the service. A chain speed of about 60 ft. per min. is usual, giving a capacity, with slings spaced 3 ft. 6 in. apart, of about 1,000 packages per hour. The portable machines carry their own motors which are arranged to run the chain and slings in either direction. The weight of the average machine is from two to two and one-half tons.

In operation both the end in the hold and that on the dock are supported only by the chains and two light cables which are used to draw up the ends. There is no framing other than the supporting horizontal trusses. Weights sus-

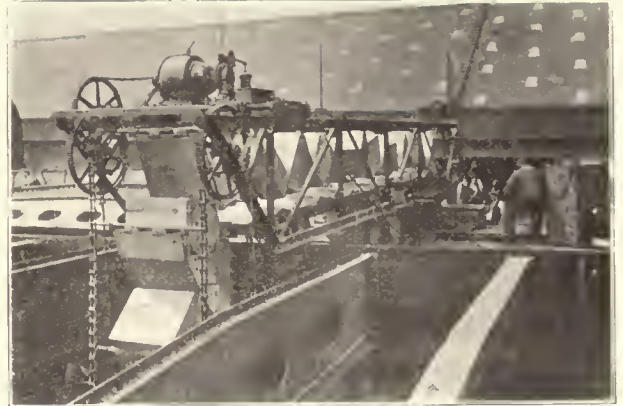

Portable Sling Type Conveyor

ended below each terminal keep the moving chains taut. Loading is most conveniently done from gravity conveyor, the packages being pushed into each empty sling as it passes the loading point. As the load passes over the top, and again to the down side, the package rolls to a new position in the flexible sling, but unless it is entirely too large for the sling, is always held securely. As each package reaches the discharge table, which may be set at any level, it is automatically unloaded to this table from which it is carried by hand, trucks, or, more effectively, by gravity conveyor. The empty sling passes back up the return side to the loading point. To provide for a shorter length of the hanging ends, due to variations in water level or depth of hold, arrangement is made within the frame for the chain and empty slings to pass back and forth over idler sprockets. This machine requires practically no attention in operation, other than occasional moving of these intermediate idler shafts and sprockets, as the ship rises or falls. Two men at the loading point keep the slings loaded. While the discharge is automatic, one or two men should be stationed at this point also to insure the proper routing of the packages away from the machine.

Another interesting variation of the fixed sling type carrier is illustrated. This machine has been applied mainly to the handling of bananas, although it is well adapted to the conveying of many types of packages of fairly uniform size and weight. The stationary tower construction is very satisfactory where it is convenient to do all loading and unloading from one point, or to move the boat in changing from one hatch to another. With the stationary installation it is practicable to provide for conveying the packages further back into the warehouse, or to cars on sidings, than with the portable, self-contained type.

This loader is raised or lowered in the hold of the vessel by means of cables passing over sheaves on the supporting

tower. This method of handling the boom of the machine makes for somewhat quicker manoeuvring into position. However, the fixed position of the supporting structure is a disadvantage in that it cannot be quickly moved from one



Banana Carrier

hatch or ship to another, as is feasible with the portable type. In machines of this type the tower is sometimes mounted on rails laid on the wharf, which gives a limited degree of portability to the machine. Because of the better protection afforded to the running parts of the conveyor so supported, these machines are somewhat more durable than the portable type.

While this carrier is used chiefly for handling bananas, it may be applied as a conveyor for packages fairly uniform in size and weight.

Stationary Type

Where conditions are such that loading and unloading may be done from one point the stationary sling-type loader

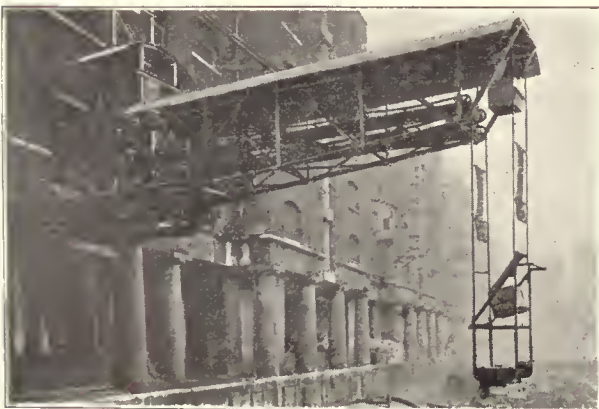

Cantilever Type Sling Conveyor

produces an even greater economy than the portable type. The saving in time of moving from place to place is offset somewhat by the time of moving the boats or barges. However, more satisfactory conveyor connections are possible at

the wharf end of the stationary machine than with the portable one. This is an important consideration in view of the fact that the capacity of this loader is so high as to warrant the fastest available means of feeding to or removing packages from the machine. The photograph shows such a conveyor leading from the end of the machine to the storage piles in the warehouse. The slings discharge automatically to this conveyor.

A very simple supporting structure for such a machine is illustrated. If desirable a loader so supported may be arranged to be raised vertically, providing clear passage of the higher boats when moving into position. In order to avoid moving the boat while being loaded or unloaded, provision is made for the cantilevered frame to swing from side to side as the barge is trimmed. The picture shows very clearly the balance weight hanging from the lower terminal which keeps the terminal end sufficiently stable and the chains taut. While the machine is in operating position, as shown, in order to reach the level of the barge, this terminal end is lowered by letting out a portion of the chain that is now passing back and forth over the idler sprockets in the frame. This flexible feature of the machine is one of its chief advantages for tidewater, or other such varying conditions.

Live Roll Conveyors

The live roll conveyor has been applied chiefly to the handling of fairly long objects with one smooth and firm side such as would be adaptable to gravity roller conveyor.



Live Roll Conveyor

However, it has also found an economical use as a short booster in gravity conveyor systems. Sometimes a very satisfactory conveyor is formed by providing occasional live rollers in a line of gravity conveyor which is set practically level. These live rollers, driven by longitudinal shaft or other means, keep the packages moving. This type of conveyor has been much used in the conveying of lumber, both as an independent carrier, and as an auxiliary for long runs of gravity conveyor. An advantage of this type of conveyor is its adaptability to slight curves, the light driving shaft at the side being provided with flexible joints. In conveying such pieces as boards the rollers may well be set at long distances apart.

Two methods of driving live rolls are most used. In the first and most common one a light shaft is run the full length of a conveyor, along the side, equipped at intervals with bevelled gears. These gears drive similar gears set on the extended shaft of the live roll. The other usual arrangement consists of a light chain which runs along over one end of all the rollers, engaging the teeth of small

sprockets set on the extended shafts of the latter. The rollers are usually $2\frac{1}{2}$ in. to 3 in. in diameter, of steel or wood, preferably the former. Because of the tendency of such packages as are usually handled on this type of conveyor, to slide back the live roll conveyor is seldom used at incline greater than 10 deg.

Wire Line Carriers

From the handling of money, messages, paper and other light objects, the scope of the wire line carrier has been extended to the conveying of merchandise parcels, tools, or even commodities in process of manufacture. The overhead location of the supporting wires makes it possible for them to be run through even the most crowded departments without interfering with the machines or aisles.

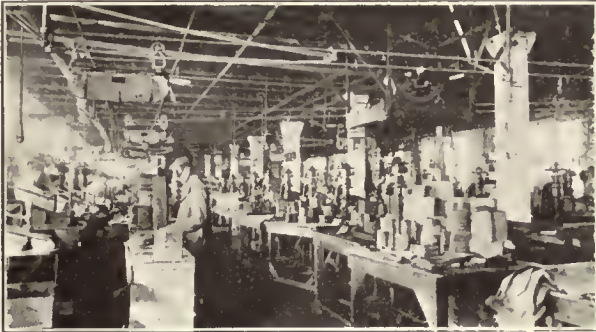

Light Packages Are Distributed Overhead

Similarly, dispatching and receiving stations may be unobtrusively located at almost any point and within easy reach of the floor. While the carrier lines of these conveyors usually radiate from a central desk in a complete system, it is frequently advantageous to install individual lines running between successive operations or machines. In shoe factories, textile mills, machine shops and many other plants, small parts such as bobbins and light tools are carried conveniently and directly by these conveyors.

These parcel conveyors built on the wire line principle are limited, practically, to loads of about 20 lb. The strain on the supporting wires for the heavier loads is high and



Central Station and Wrapping Department

for this reason secure bracing of the standards is essential as is the use of the best quality of wire. Two lines of wire are generally used, the lower as the track and the upper as a strengthening wire. The baskets or other hangers may be pushed by hand, although they are more commonly propelled by springs, operated by the dispatcher.

From 150 ft. to 200 ft. is about the limit of horizontal travel, which is considerably less if sharp up-grades are to be negotiated. Obviously, special care should be taken to make the baskets or other containers no heavier than is necessary to secure a durable container. An arrangement for pulling the basket down to convenient loading heights is advisable, although the carrier which is dispatched direct from the loading point is somewhat simpler.

While the use of wire line carriers has long since been brought to a high point of development in store service, this conveyor is constantly being applied to new work in this field. This has resulted largely from increasing demands for speed in the handling of orders or sales, although improvements in design have had much to do with it. Particularly where it is necessary to send orders or requisitions to other departments or floors and have the parcels returned, this conveyor is efficient in speeding up business. In many crowded stores installations of wire line carriers have created order out of chaos, making possible an organization that would be otherwise impracticable. In retail and other stores where attractive store fixtures are necessary, the neat appearance and noiseless operation of this equipment are factors in its success.

Many special types of cars or baskets are used, each designed to fit the class of packages to be handled. For parcels, the most common carrier is the wire-mesh basket, strongly reinforced and braced to withstand the rather sudden strains incident to the operation of this equipment. The baskets are usually designed to be lowered at their sending points for convenience in loading and unloading. The baskets are usually propelled by hand-operated mechanisms which impart to the car sufficient impulse to carry it to its destination. The return may be by gravity, or by similar hand propulsion, or by a combination of both. Where necessary to turn corners or make bends in the line of travel to accommodate special layout conditions, curves may be installed of any desired radius.

The cash-carrier is a type of wire-line carrier used mainly for the handling of cash, messages, and very small objects, rather than for package or material handling. Propulsion may be by hand or by continuously moving wires or cables.

Pneumatic Tubes

The extension of the scope of pneumatic tubes to the handling of merchandise and fairly heavy packages is a comparatively recent development. From the carrying of cash, messages, and papers, the field of application of this



Pneumatic Package Conveyor

conveyor now includes the handling of mail, and many lighter objects which are contained within a reasonably uniform range of sizes. Even fairly heavy packages have been successfully handled. In manufacturing processes

these tubes provide instant dispatch between successive operations. A very economic application of this carrier, and one which saves much loss of time and unnecessary moving about, is the conveying of small parts between tool room or stock room and machines. The unusual flexibility

of air or vacuum is the propelling force in pneumatic tube systems. The range of distance over which these systems operate depends largely upon the weight of the package and the provision made for supplying the proper pressure. Special blowers for each system are usual, although where compressed air is used for other purposes it may be supplied from the central source.



The Conveyor Co-ordinates Shop and Office

of the pneumatic tube, with its adaptability to the most irregular or crowded layouts, is a distinct advantage in many plants. These carriers may be installed in partitions, furred ceilings, shafts, or other out-of-the-way places. Since they require infrequent attention they need not be so accessible as some other types of carriers.

The size of the traveling containers or individual carriers depends upon the size of the objects to be handled. Each problem is individual in its solution. An essential basis of good design is careful handling of these containers.

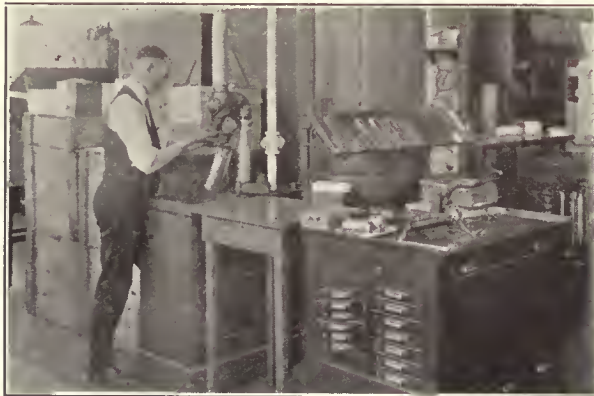

Shop Terminal of Pneumatic Conveyor

To this end, very smooth tubes are necessary, with neatly fitted connections between sections. Similarly careful delivery at the terminals is essential. Neat appearance is important, where the tubes run exposed, in the usual surroundings where this equipment is installed. Compressed

Carrousel Conveyors

A type of special conveyor much used in bottling plants, canning plants and foundries is shown in the accompanying illustrations. The fact that the apron of this machine travels in a horizontal plane throughout its entire circuit and is readily accessible from any point makes it an economical work table. Objects placed on the conveyor will travel continuously until removed, the carrying surface thus acting as a temporary storage platform. In bottling plants these machines make excellent moving work tables in con-



A Carrousel in a Canning Factory

nection with filling and packing operations. In canning plants they have practically revolutionized the peeling, sorting, or picking of fruits. In foundries, flasks and other accessories move in a systematic and orderly manner, between successive operations.

Since the terminals of this conveyor travel in a horizontal rather than in the usual vertical plane, somewhat more care in design of the ends of the conveyor is necessary than with the standard types of slat conveyors. Most of these machines are built on the roller carriage principle, with individual carrier platforms mounted on wheels and propelled by a single strand of plain chain. There is seldom any necessity that they be reversible in motion, but the motion should be smooth. Slow speeds are customary, from 2 ft. to 3 ft. per min. to 30 ft. or 40 ft., depending upon the nature of the work to be done.

LOOSE MATERIAL CONVEYORS

Centrifugal Discharge, Perfect Discharge and Continuous
Bucket Elevators; Gravity Discharge V-Bucket and
Pivoted Bucket Carrier Elevator-Conveyors;
Belt, Apron and Pan, Flight, Screw,
Reciprocating and Current Convey-
ors; Portable Loaders

A Treatise Covering the Construction and Application of
Continuous Elevators and Conveyors
for Handling Loose Materials

By

HENRY J. EDSALL

Engineering Department, Link-Belt Company



Conveyors and Elevators for Loose Material

CONTINUOUS CONVEYORS are usually the most economical means for mechanically loading and unloading loose bulk materials and for moving them short distances. By the term continuous conveyor is meant those types of machines which keep the material moving forward in a constant stream or in separate amounts following each other so closely that this result is approximated.

Continuous machines are more or less automatic in their operation, since it is usually necessary only to feed the material to them, after which the handling and delivery are automatic. The result of the continuous movement is a rapid rate of handling even though the stream of material may be comparatively small and the automatic handling and delivery reduces the labor item to a minimum.

The extensive use of continuous conveyors is a comparatively recent development. As most of the modern loose material conveyors except the screw and the belt conveyors, and the comparatively little used reciprocating flight and reciprocating trough conveyors, depend upon some form of chain or belt to which carriers or pushers are attached, the improvements in chains and fabric belts have been important factors in extending the use of such types of machinery.

The development of modern conveyor chains dates largely from the invention of the detachable link by Wm. D. Ewart in 1873. The Ewart malleable iron chain is well adapted to conveyor work, especially of the lighter character, since wings can be easily cast on certain links for attaching buckets and brackets for attaching flights or pushers, and various other types of attachments for special kinds of work.

The idea of carrying materials on belts dates back many

years but the extensive use of belt conveyors for loose materials resulted from the development of troughing idlers for supporting the belt on the loaded run, and bending up the edges of the belt to prevent the material from working out sideways. Excessive troughing results in injury to the belts and should be avoided.

With the increasing use of chains for conveying purposes, accompanied by a demand for greater durability to meet conditions imposed by larger and heavier machines and in order to satisfactorily handle abrasive materials, detachable link chains have been largely superseded by improved designs having closed protected joints. The best modern chains have case hardened steel bushings and hard steel pins.

Machine Types

Continuous motion equipment for handling loose material may be divided into three groups: elevating only, elevating and conveying; conveying only.

Machines for elevating only are almost without exception of the bucket type, including the so-called centrifugal discharge elevator; the perfect discharge elevator and the continuous bucket elevator.

Machines for both elevating and conveying are also ordinarily of the bucket type either of the gravity discharge V-Bucket or of the pivoted bucket carrier form, and in a few instances are of the screw type.

Machines for conveying only include belt conveyors, apron and pan conveyors, flight conveyors, screw conveyors, reciprocating flight conveyors and reciprocating trough conveyors.

Bucket Elevators: Centrifugal Discharge; Perfect Discharge; Continuous Bucket.

Elevator-Conveyors: Gravity Discharge V-Bucket; Pivoted Bucket Carrier.

Conveyors: Belt; Apron and Pan; Flight; Screw; Reciprocating; Current.

Portable Loaders.

Bucket Elevators

Bucket elevators consist of a series of buckets mounted on and carried by one or two strands of chain or a belt. The buckets may be spaced some distance apart or close together. Their function is to elevate or lower material from one level to another and they may be operated in substantially vertical or inclined positions. In one form or another they are adapted to handling any kind of loose bulk material.

Centrifugal Discharge Elevators

The centrifugal discharge type is the simplest and most used bucket elevator. Three modifications are in general use—single strand chain and bucket, double strand chain and bucket, and belt and bucket.

For all these machines the material to be handled is fed into a boot at the bottom from which it is picked up by the buckets and after being elevated it is discharged by centrifugal force as the buckets pass over the head wheel. Because of the method of discharge which must be made without friction on the bucket and in such a manner as

to insure that the material be thrown forward into the receiving chute it is essential that the diameter of the head wheel and the speed be so proportioned that the centrifugal force just neutralizes the force of gravity. If the speed is too great some of the material will be carried past the chute and if too low some will fall out before the chute is reached. The usual speed of operation of this type of elevator ranges from 150 ft. per min. to 400 ft. per min. dependent on conditions.

Centrifugal discharge elevators of the chain and bucket type are usually installed in as nearly a vertical position as practical to avoid any tendency of the chain and buckets to sag down or sway. They may, however, be inclined to a certain extent without supports providing space is provided underneath for the sag. When, however, this inclination is carried beyond a certain point, it is customary to use idlers at intervals, or slides to support the chain on the ascending run, and, when the inclination is considerable, the descending run is also supported. In such cases, since, on the return run, the buckets are underneath,

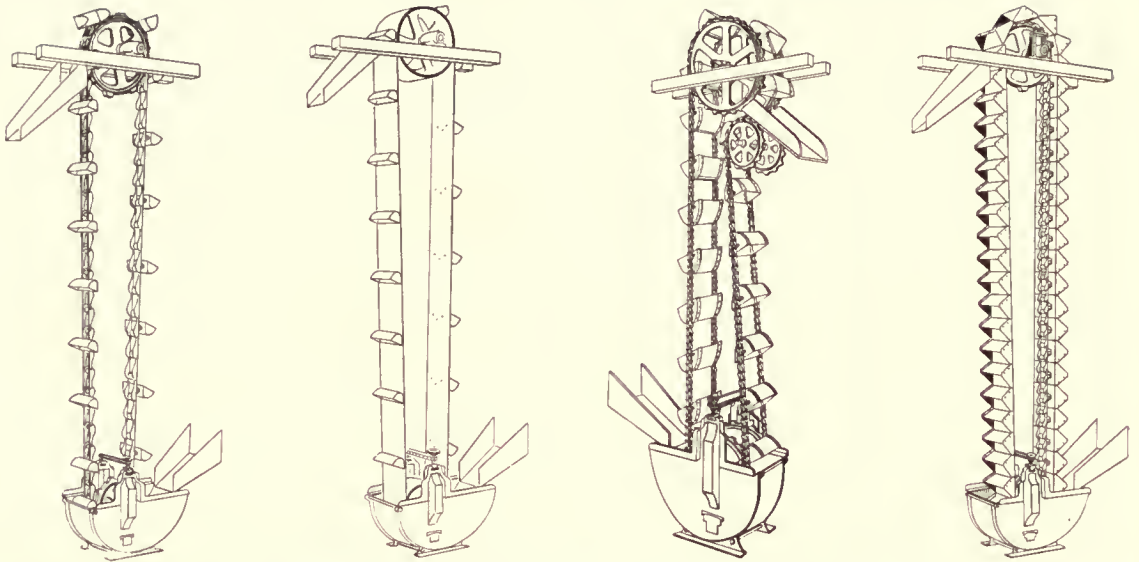

Centrifugal; Perfect Discharge; and Continuous Bucket Elevator

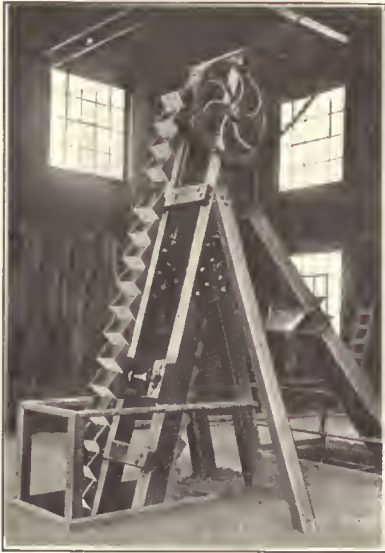

Some Typical Applications of Bucket Elevators

and it is not advisable to slide them, tracks are provided on which the chains slide or supporting idlers are installed at intervals. In some cases bars are bolted to the backs of the buckets, and allowed to extend beyond the buckets at each end, so that the ends of the bars may slide up and down on tracks. Sometimes sliding shoes which are renewable are attached to the ends of the bars to take the wear.

Because of the weight and the increasing tendency to sway when heights are excessive centrifugal discharge chain and bucket elevators are seldom used for heights exceeding 100 ft. Belt elevators, because of their lighter weight, may be employed for heights ranging up to 150 ft. or even more.

Each of the modifications in form of centrifugal discharge elevator has its particular advantage. For moderate heights and buckets of medium length a single strand of wide chain is simpler, less expensive to maintain and thus preferable to two strands of narrow chain. Where long buckets and great heights are required the swaying tendency of the single strand chain makes it advisable to adopt the two strand construction. However, with double strands there is a tendency produced, by unequal wear or stretch, to set up undesirable strain in the chain and the attachments which fasten the buckets to the chains. This can be largely compensated for by attaching the two strands of chain to swivel connections fastened to the ends of the buckets. The belt form is always preferable for extreme heights.

The chain and bucket centrifugal discharge elevators are particularly adapted for handling coarse and fine dry materials, either hot or cold, which are not of too abrasive a character. They are extensively used in power plants for handling coal and ashes, and in fertilizer plants, cement plants, chemical works, coke ovens, etc. In addition, this type of machine is employed for elevating water in connection with irrigation or drainage projects and when fitted with perforated buckets for dewatering purposes in anthracite coal washers and canning plants. When equipped with special wear resisting chains the chain and bucket type is frequently used for handling abrasive materials.

The belt and bucket type is particularly adapted for handling abrasive materials which would cause excessive wear in ordinary chains and, as well, for free flowing materials such as flour, hydrated lime, etc., as the buckets when backed up by belts fill better and do not overflow. It is also used for wet materials such as thin pulp. It should not, however, be used for hot materials which would injure the belt. This type is universally used in grain elevators and flour mills, and is extensively employed in collieries, ore milling plants, chemical plants and various other industries.

Centrifugal machines of either type are not suited for handling sticky material or those containing large lumps. Both types are used for handling small sizes of anthracite and bituminous coal in which the lumps have been broken up by a crusher or other means. As a rule, however, these machines are not used for handling coal when breakage is objectionable and when so used are usually installed in an inclined position, making possible lower operating speeds thus tending to reduce breakage.

Perfect Discharge Elevators

The perfect discharge type of elevator, sometimes called "positive discharge," is always a double strand elevator with the chains attached to the ends of the buckets. By locating a pair of deflecting sprockets at the head end, the

buckets are drawn back and inverted, thus insuring a cleaner discharge than can be obtained with a centrifugal machine. Usually the buckets discharge into a chute located at the head end of the machine and well under the buckets.

This type of elevator is usually run at slower speeds than the centrifugal discharge machines, the speed being usually between 75 ft. and 150 ft. per min. It is suitable for heights ranging up to about 125 ft. and by the use of large buckets high capacities may be obtained. These machines are usually set vertically but are sometimes slightly inclined and may be run vertically for a certain distance and then at an incline, so that the discharge point may be brought nearer to the centre of a bin to which the material is being delivered.

The easy pick-up resulting from the relatively slow speeds at which this type of elevator may be operated and the fact that the material is dropped from the buckets at the discharge point, rather than thrown out, make these machines particularly adapted for handling commercially sized coal and fragile material where it is desirable to keep breakage at a minimum. Because of the fact that the buckets in this type of elevator are completely turned over at the discharge point these machines are also well suited for handling moist clay and other materials which tend to cling to the buckets. They are suitable also for handling bituminous coal and similar relatively soft, free-flowing materials even though they contain large lumps.

Continuous Bucket Elevators

Continuous bucket elevators are made up of a continuous line of buckets attached either to one or two chains or to a belt. The buckets are always triangular in shape and the discharge at the head is accomplished by using the back of each bucket as a chute for the material from the bucket just behind.

Since the discharge at the head does not depend upon the speed, these elevators may be run at almost any speed desired, the usual speeds being from 80 ft. to 150 ft. per min. and, because of the continuous arrangement of the buckets, the capacities are high.

The principal advantage of this type of machine is its capability to receive its load by means of a chute which discharges directly into the buckets. It may, however, pick up its load from a boot as do the other types of bucket elevators.

When loaded from a chute the elevator is usually set at an angle of 15 deg. or more with the vertical, the inclination facilitating the feeding and discharge and also minimizing the likelihood of spill. If spill does occur the waste collects in the boot and is reclaimed by the buckets.

When installed in the inclined position this type of elevator is particularly adapted for crushed stone and gravel, and other similar materials which cannot be picked up from a boot satisfactorily.

In the inclined position it is also extensively used for handling commercial sizes of anthracite coal, coke and other materials where breakage caused by digging from a boot or high speeds of discharge would be serious. Either chain or belt type is satisfactory for this service.

The chain type in either the inclined or vertical position is used successfully for handling hot materials such as coke.

Bituminous coal and similar materials where the lumps are not too large may be satisfactorily picked up from a boot. For this service the elevators may be set vertically or in an inclined position and may be of either the belt or chain form.

Because of the method of discharge this machine is not recommended for handling moist clay or sticky materials.

Other Types of Elevators

Gravity discharge V-bucket machines while occasionally employed as elevators only are more usually installed where material is to be both elevated and conveyed. These machines are described under the head of elevator-conveyors.

Screw or spiral machines are sometimes installed for elevating purposes only, as is also the pan type conveyor when fitted with buckets of sufficient depth. These ma-

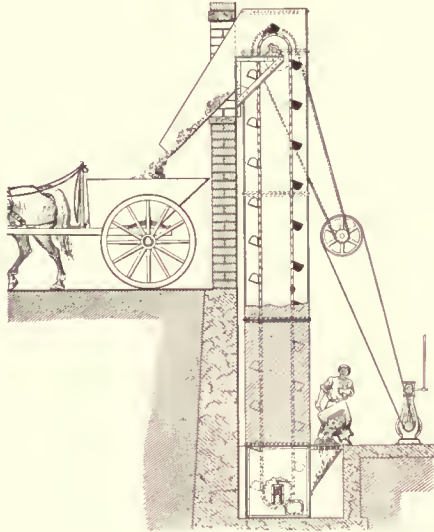

Ash Elevator

chines are, however, essentially conveyors and are described under that section of this book.

General Specifications

Buckets. Malleable iron buckets are usually used for centrifugal and perfect discharge elevators except for light service, and should always be employed where there is danger of corrosive action such as results from handling wet ashes or coal. Manufacturer's standard type "A" buckets are preferable when the elevator is installed in a vertical position; type "B" buckets when moderately inclined; and type "C" buckets when the incline is considerable and the material is of a more or less sticky character.

For light service, such as handling grains or feeds, light sheet steel buckets of the Salem or some similar type are satisfactory.

Sheet steel buckets from $\frac{1}{8}$ in. to $\frac{3}{16}$ in. thick, are usually used for continuous bucket elevators, although malleable iron buckets are also used to a certain extent. For vertical elevators the buckets should be of the high front type; for elevators of a moderate incline of the medium front type, and for elevators of a still greater incline of the low front type. To prevent material dropping in back of the buckets they may be made overlapping. For handling sticky material the corners of the buckets should be well rounded or fillers should be fastened in.

Chains. Chains should be of sufficient width to give ample bearing surface and stability in the joints, even when somewhat worn, and to provide wide attachments to which to bolt the buckets. For centrifugal discharge elevators

of moderate heights and for handling materials not especially abrasive detachable link chain is satisfactory and economical. Malleable iron pintle and combination chains are extensively used but where the material handled is particularly abrasive chains should be of the case-hardened bushed type and provided with hard steel pins. Standard malleable iron roller chains having rollers at each joint are also used for double strand machines. For the heavy duty machines steel strap roller chains are used, the chains having rollers either at the joints or sometimes at the center of the links, the latter construction facilitating renewals.

Belts. The type of the belt to be used on any particular bucket elevator depends largely upon the character of the material to be handled. Rubber belts should be used for wet materials; stitched canvas and solid woven cotton belts should generally be used for dry materials and rubber covered belts in most cases for abrasive materials, whether wet or dry.

For most purposes the belt tension, due to the weight of the belt, the buckets and the load carried, should be limited to 20 lb. per in. per ply, although a tension of 30 lb. per in. per ply has been satisfactorily employed in large grain elevators.

Wheels and Pulleys. Chain sprocket wheels are usually employed at both the head and the foot of the elevator, though in some cases traction wheels are used at the head because of their longer life. Sprocket wheels should be of ample diameter and for severe service or for handling abrasive materials should have chilled rims.

Pulleys for elevators of the belt type should be of large diameter as this increases the durability of the belt.

Bearings and Driving Machinery. Rigid bearing boxes, frequently of the split type, are commonly employed. Bearings are usually babbitted, and grease cups or oil wells, with rings, are provided for lubrication. Take up bearings for maintaining the proper tension of the chains or belt are usually provided at the foot but in some cases are placed at the head.

Elevators are almost universally driven at the head because of the better driving contact at this point. On account of the slow speed of rotation of the head shaft a countershaft is usually connected to the head shaft by spur gearing, and driven by means of a chain or belt.

Boots. Boots are usually provided for centrifugal and perfect discharge elevators into which the material is fed and from which it is picked up by the buckets. Boots are ordinarily made of cast iron side plates and a steel bottom plate, although they are frequently made entirely of steel and sometimes of wood or concrete. In some cases the boot is omitted, the material being picked up from a pile in which it is deposited at the foot of the elevator.

In continuous bucket elevators the material is usually fed directly into the buckets and the boot omitted.

Chutes. The discharge chute at the head is usually made of steel or of wood lined with steel. It must be set at the proper inclination so that the material which is being handled will be discharged freely no matter what condition it may be in, must clear the buckets and be so placed that little if any of the material is carried by.

Feeding chutes for continuous bucket elevators must be so placed as to deliver the material into the buckets with a minimum of spill.

Supports. Supports may be of wood or of structural steel, the former being cheaper in first cost but more apt to get out of place on account of shrinkage and are

subject to rapid deterioration when exposed to the weather.

Casings. Casings, when required, may be built of either wood or steel. Steel casings are usually made in sections with flanges or angles at the joints and corners.

Rivets are less liable to become loose but bolts facilitate the removal of the plates.

Casings should have a door or removable plate at the foot and at the top to provide access for repairs.

Elevator—Conveyors

Where loose material has to be both lifted and transported it may be raised by a bucket elevator and then carried horizontally by some form of a conveyor, although in many instances it is preferable to do both the elevating and the conveying by one machine. Two types of machines are commonly used for such work, the gravity discharge V-bucket and the pivoted bucket carrier. Gravity discharge V-bucket machines are simply one form of bucket elevators when used for elevating purposes and when transporting the buckets act as flights, dragging the material along in a trough. Pivoted bucket carriers act as bucket elevators when elevating and as pan conveyors when transporting.

Gravity Discharge V-Bucket Type

The gravity discharge V-bucket type of machine can be used either for elevating only or for both elevating and conveying. It is necessarily a double strand machine with the chains attached to the ends of the buckets either by means of rigid or swiveling attachments, and not pivoted.

The principal use of this type of machine is in handling coal at retail coal yards, storage points, docks, power plants, gas producer houses, locomotive terminals, etc. It can be used for handling practically all materials when they are to be elevated only, but it is not suitable for handling ashes, sand, stone or any hot or abrasive materials when they have to be conveyed as well as elevated.

Where these machines are used for elevating only, there is usually a boot at the foot to which the material is fed and from which the buckets pick it up as the chains pass around the foot wheels. The buckets are of a "V" or modified "V" shape, and the discharge at the head is accomplished by having the chains turn, at the top of the lift, around knuckle wheels and travel horizontally or on an incline, for a short distance, the material sliding out of the buckets as they change their direction of travel. A section of trough is inserted underneath the buckets at the turn wheels so that the material is received in the trough. The trough can be extended into a chute for discharging into a separate conveyor or a bin.

These elevators are usually run at a slow speed, about 100 ft. per min., and the pick-up and discharge of the material are both gentle, so that little or no breakage is caused when handling such material as anthracite coal. After the buckets are discharged the chains travel around a second pair of wheels and descend vertically, the ascending and descending runs being approximately parallel and quite close together.

Instead of discharging to another conveyor at the top of the lift the chains and buckets may run horizontally for some distance, the buckets acting as flights and dragging their half-spilled loads ahead of them through a suitable trough. The material can be discharged from this horizontal section by means of gates at any desired point in the trough bottom. If the material is to be conveyed first and then lifted, the buckets drag it along a lower run of a trough and at a properly arranged upward turn pick up their loads and elevate them.

The chains and buckets of gravity discharge V-bucket elevator conveyors can be made to follow various paths,

frequently with several turns, and one very common arrangement is to have the chains and buckets follow a rectangular path, the upper horizontal run being a distributing run for delivering coal or other material into a bin or bins and the lower run being underneath the storage space, gates and chutes being arranged to deliver the material back to the lower run when it is to be taken out of the bins. When used in this way a tunnel is usually provided for the lower run and this tunnel is made large enough so that there is ample passageway for a man to walk along the side of the conveyor, so as to operate the gates and have access to the conveyor for oiling or other care needed for it.

General Specifications

Buckets. The buckets are usually of a "V" or modified "V" shape, the lower side on the loaded run having a steep enough angle so that the material will slide out at the discharge point. They are made of sheet steel riveted together at the joints, the larger buckets being sometimes reinforced with steel strips, usually of the half oval shape, along the edges.

Chains. Since gravity discharge V-bucket machines are always double strand the chains need not be very wide.

For elevators only and for the smaller machines where the horizontal run is short, the chains used are the Ewart type, the pintle, the combination, the flat and round steel link, and sometimes the small steel strap.

Where a machine is used for both elevating and conveying and the length of the horizontal run is considerable, some type of roller chain is used so that the rollers of the chain can run along on steel tracks and keep the buckets raised slightly above the bottom of the trough in which the material is conveyed. In this case, the standard malleable roller chains are used a great deal except for the largest machines, where the steel strap roller chains are preferable. For long machines, where the pull in the chains is considerable, the joints of the steel strap chains are usually bushed with case hardened steel bushings, so as to increase the bearing surface in the joints, thereby reducing the bearing pressure and the wear in the joints.

Wheels. Standard sprocket wheels are used in nearly all cases, though traction wheels are sometimes used for some of the corner turn or idler wheels.

Bearings and Driving Machinery. Simple rigid pillow blocks or post boxes are ordinarily used; these frequently being of the angle bearing type.

The drive is located at various points, according to the path of the machine and the length of the horizontal run compared to the vertical run. For a machine with a short horizontal run the drive can be located at the turn shaft at the top of the lift or at the turn shaft at the other end of the horizontal run. Where the horizontal run is quite long it is usually better to locate the drive at the end of the run toward which the chain and buckets are traveling. There is usually a countershaft geared to the drive shaft by means of spur or bevel gears, and this is usually driven by means of a chain or belt drive, or geared,

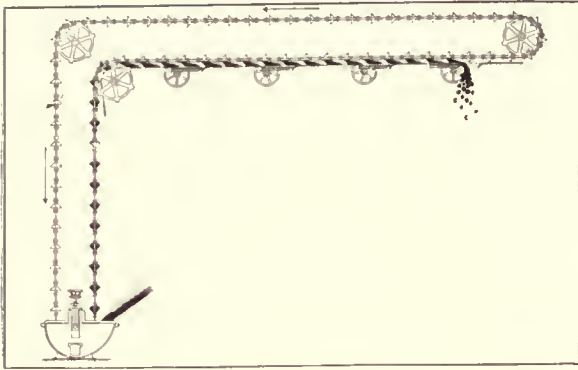

Elevating and Distributing

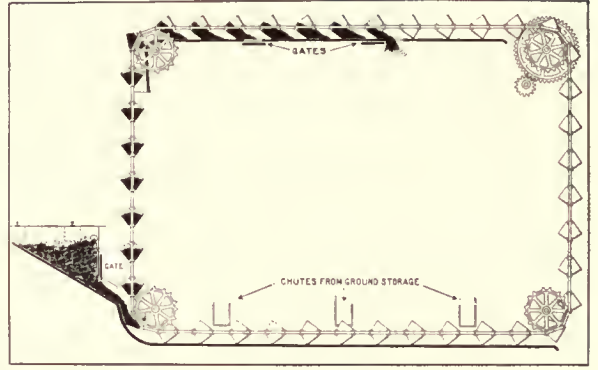

Elevating, Distributing and Reclaiming



Discharge Chutes on Upper Run

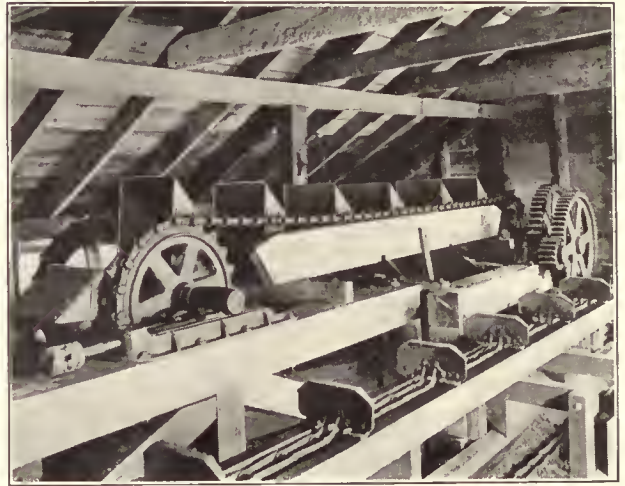

Delivering to Flight Conveyor



Gravity Discharge V-Bucket Elevator-Conveyors

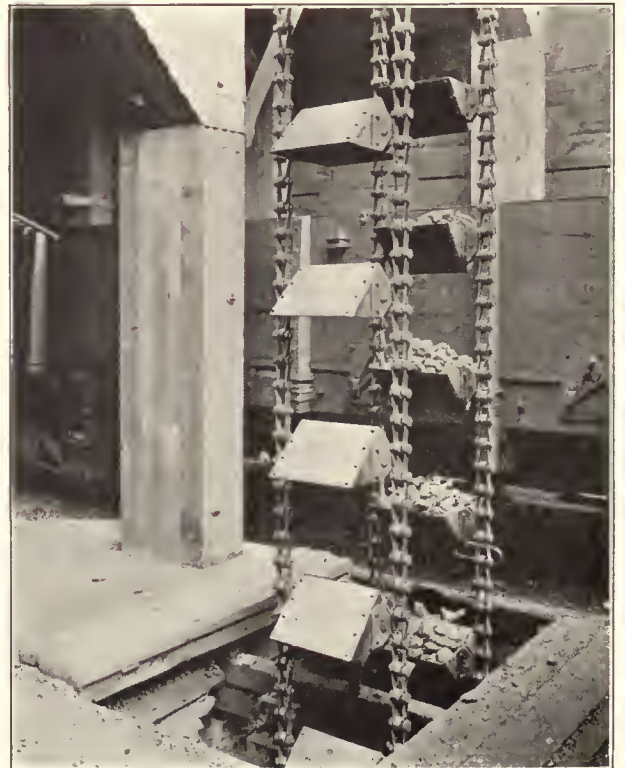

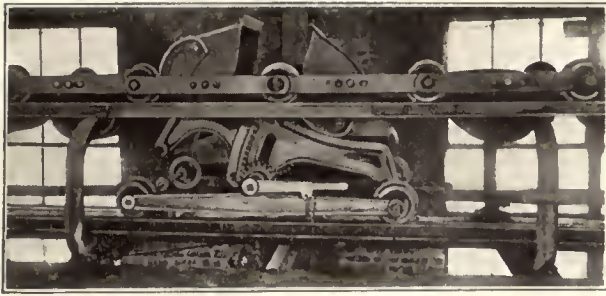

Discharger

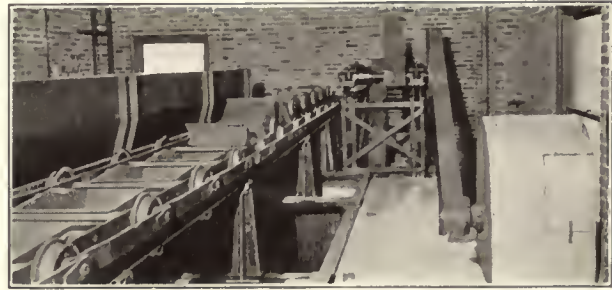

Driving Head

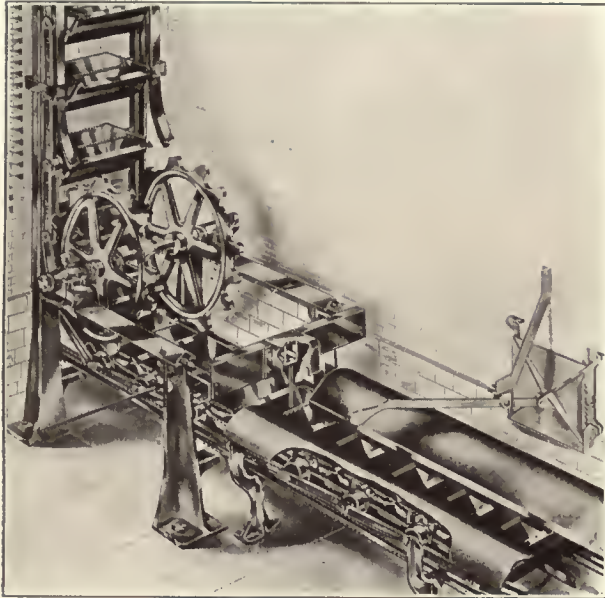

Lower Corner Turn

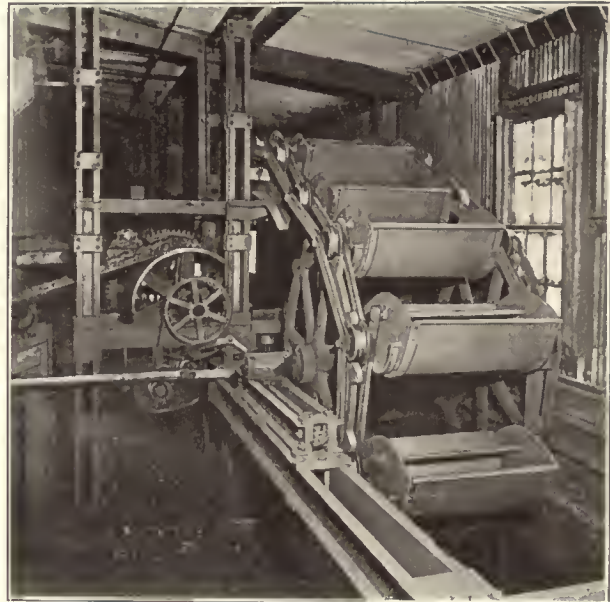

Upper Corner Turn



Pivoted Bucket Carriers



Corner Turn and Feeding Chutes

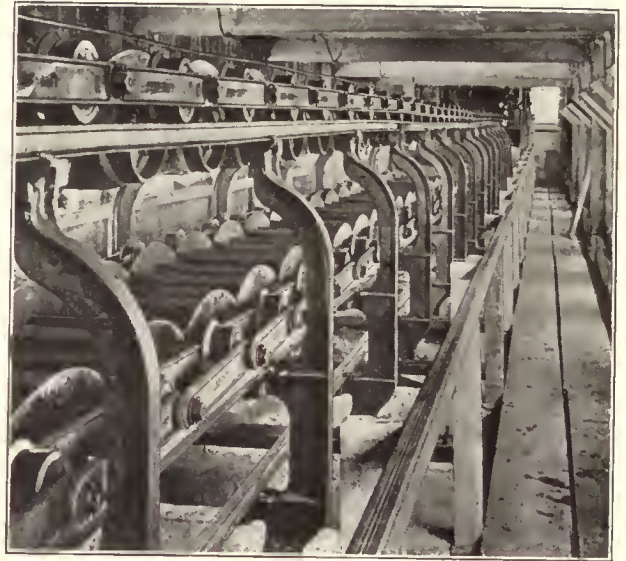

Upper Run and Return



Suspension Arrangement Insures Proper Lap

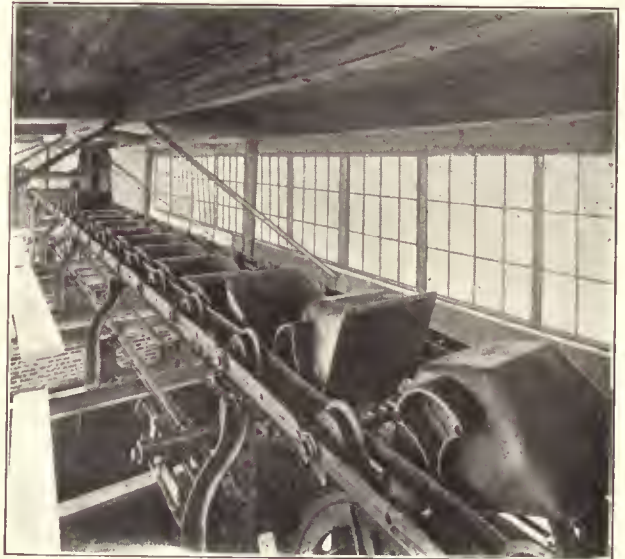

Method of Discharge



Pivoted Bucket Carriers



by means of another pair of spur gears, to a second countershaft or to a motor.

Supports. The supports can be either of wood or steel, as is desired, the material used for these supports being usually determined by the material used for bins or other structures in connection with the machinery.

Pivoted Bucket Carrier

Pivoted bucket carriers consist of a continuous series of buckets pivotally suspended between two long-pitch roller chains which are supported on tracks on the horizontal and inclined runs and between guides on the vertical runs. Because of the flexibility secured in this construction these machines may be made to follow a rectangular or any other desired path and consequently they may be used for elevating vertically or along an incline as well as for conveying in a horizontal direction. They are slow speed machines, usually operated at speeds between 40 ft. and 60 ft. per min., and are capable of being loaded at one or more points and of discharging at a number of points or all along a distributing run. As the load is always carried, rather than pushed along, the power consumption is relatively low.

In the earliest carriers the buckets were hung as closely together as practicable to prevent material falling between them at the feeding point. While the buckets were in actual contact when the machines were first started, the wear and elongation of the chains induced an increasing separation, thereby permitting fine material to sift through. Various types of feeders have been developed for overcoming this difficulty, but the simplest way is to overlap the bucket lips sufficiently to avoid a gap, not only when the machine is first started but even after the chains have become elongated. In the latter case special feeders are not required—the buckets being fed directly from a chute or spout. The use of the overlapping lips, however, introduces the mechanical difficulty of having to have the laps come in the right direction, so that when the loaded buckets turn to ascend they will not interfere with each other and cause tilting and spilling of the loads.

Several methods of reversing the laps so as to have them come in the right direction have been devised, such as tilting the buckets just before they start along the lower horizontal run, or bringing the buckets down sideways on the descending run. Another method of overcoming the difficulty is to suspend the buckets from extensions of the chain links beyond the chain joints. With this method of suspension, the buckets travel on a larger circle than the chains as they pass around the turn-wheels, so that they are automatically separated, and lap correctly.

Pivoted bucket carriers are used for handling coal, ashes, coke, stone, ore, cement, sand and various other materials. They are slow speed machines, usually operating at speeds between 40 and 60 ft. per min. With good size flanged rollers, traveling on standard T-rails on horizontal or inclined runs, and carefully guided between double guides on vertical runs, there is little chance of trouble unless the carrier is seriously neglected, in which case any machine is likely to get out of order. The power required to operate a carrier is small, since the up and down runs balance each other, except for the weight of material in the loaded buckets: with large, well-oiled rollers very little pull is required to move the carrier on the horizontal and inclined runs.

General Specifications

Buckets.—As a rule the buckets are one-piece malleable iron castings, though some of the larger ones are made

with malleable iron ends and steel plate bottoms, or are entirely of steel. In some cases the buckets are suspended from through rods which are attached at their ends to the chains; in other cases there are separate pins on each side of the buckets. The through rod has the advantage of insuring alignment on both sides, since it is possible for separate pins to be out of alignment, thereby preventing the buckets from swinging freely. The cams for engaging with the discharger are cast separately, either of malleable iron or cast iron, and sometimes have chilled faces where they bear against the dischargers; these cams are riveted to the sides of the buckets. The lips of the buckets should have ample overlap, the V-shape overlap having the advantage of not allowing material to rest on it and spill off at the turns.

Chains.—The chains are usually made of malleable iron, in order better to resist the corrosive action of materials such as wet ashes; also to make it easier to form bosses on the links at the chain joints and suspension points so that pins, bushings and suspension rods may be held more securely than with ordinary steel flats of uniform thickness. If the pins or the bushings work loose, the chain deteriorates rapidly and, since the holes in the links become enlarged, the complete chains have to be renewed instead of only the pins and bushings; however, where the material to be handled is not corrosive, and especially with long carriers and large buckets where the pull on the chains is heavy, steel links are often used, these steel links being frequently forged so as to be thicker at the points where the pins and bushings and suspension rods are attached. The chain joints are undoubtedly the most vital points in determining the life of a carrier. The usual chain joints all have case hardened steel bushings keyed to the inside links and the pins are held in the outside links. There is thus no wear on the links themselves, providing the pins and bushings do not get loose in the links; any wear is between the pins and bushings. With the bushed joint the bearing surface depends upon the length of the bushing and the diameter of the pin, whereas if the joint is not bushed the length of the bearing is limited to the thickness of the links; the wear comes on the links themselves, instead of being confined to the pins and bushings—small parts that are comparatively inexpensive to renew. By making the bushings of case hardened steel and the pins of high carbon steel, and by making them both of the proper size so as to keep the bearing pressure low, a remarkably long wearing joint may be obtained, providing it is kept properly oiled.

The rollers are often cast with oil chambers, which are filled through self-closing valves or oilers by means of a syringe; the rollers have felt washers at the center of the bore, through which the oil filters slowly to the bushings, and then passes on through a slot in the bushings to the pin, thereby oiling the outside of the bushing on which the rollers turn, and also the inside of the bushings and the pins. These oil chamber rollers can be made to carry sufficient oil for three or four weeks' supply. To prevent the oil staying in the bottom of the roller when it gets low, there are fins on the inside of the rollers to pick it up and drop it on the felt washer.

Other rollers are provided with an oil duct leading to its center, but have no oil chambers to oil each roller at frequent intervals. In all cases the oil is delivered to the joints at the center, so that it works from the center out and tends to wash any grit or dirt out of the joints rather than into them, and also tends to form oil seals around the outside of the joints thus preventing the entrance of dust or dirt.

Driving Arrangement.—These carriers are usually driven by sprocket wheels at the driving corner. The motor drives a countershaft through a pair of cut spur gears or by silent chain. Further reduction to the main shaft is made through spur gears. The bearings for the several shafts are usually supported on two cast iron side frames, resting on beams and tied together across the top by steel or cast iron members which are used also for motor supports.

Where the driving requirements are heavy the gear on the driving shaft and the pinion meshing with it are duplicated; that is, two pairs of gears are installed, one at each end of the driving shaft. In some cases the sprocket wheels consist of rims and teeth without arms or hubs, the rims being bolted to the driving gears so that the power is transmitted from the driving gear direct to the sprocket, and the driving shaft is relieved of all torsional strain. This makes possible the use of a lighter shaft, and when the sprocket wheel teeth become worn they may be renewed much more easily and economically.

Dischargers.—Dischargers for tilting the buckets are usually of the removable type, equipped with wheels which travel on T-rail tracks. The curved tracks on the discharger which engage with the bucket cams are made of such a shape that the rolling contact tips the buckets over and allows them to regain their normal position with practically no friction or noise. When it is desired to throw the discharger out of service, the curved track is lowered so that it does not engage the bucket cams.

Stationary dischargers are used for discharging material at a fixed point. Several stationary dischargers are sometimes used in place of removable dischargers; any one of these may be set to dump the buckets depending on where it is desired to place the material. In some cases automatic traveling dischargers are used, which travel back and forth automatically by means of power obtained from the carrier, so that the discharge point is being constantly changed, and the material is distributed along the length of the distributing run.

Winches for Moving Dischargers.—The movable dischargers are moved either in one or both directions by small steel cables winding on winches at one end of the distributing run of the carrier. The cable may be single in which case the discharger is moved against the direction of the travel of the buckets by the cable and in the opposite direction by contact with the buckets themselves: where an endless cable is used it may be passed around an idler sheave at the opposite end of the distributing run.

Tracks and Guides.—Standard T-rails are used almost exclusively for the travel of the chain rollers on horizontal and inclined runs, these rails being supported on cast iron chairs; these are bolted usually to steel cross channels on the upper runs and directly to the concrete floor on the lower runs. The T-rails ordinarily weigh not less than 16 lb. per yd.; the cast iron rail chairs should be made amply strong and with wide bases so as to insure proper support and alignment of the rails. Where movable dischargers are used on the distributing runs, the rail chairs are arranged to carry also the T-rails on which the discharger wheels travel.

For guiding the vertical runs of carriers, double T-rails or double steel angles are used, the former being preferable. The chain rollers are confined between these guides, so that there is little chance for the carrier to get out of its intended path of travel. Where casings are used, the rail chairs are bolted to the casing. Where no casing is used the rail chairs are bolted to walks or to steel members forming part of the building construction or to a steel member added for the purpose.

Guards and Casings.—To protect the chains from the material being fed to the buckets, and to direct the material properly into the centers of the buckets, curved steel guards, supported by extensions of the rail chairs are used on feeding runs. These are made of steel sheets, usually No. 10 or thicker, and are bolted or riveted to the tops of the rail chairs on which they rest. The inside edges should come down quite close to the tops of the buckets and the outside edges should be curved over far enough to effectively protect the chains from material.

Vertical ascending runs with loaded buckets are usually enclosed in steel casings made of No. 12 steel plate or heavier, this casing preventing any material which might be jarred or blown from the buckets from falling outside on the floors or on attendants. On descending runs where the buckets come down right side up, it is not necessary to use a casing and the omission makes the carrier visible and more accessible. There should, however, be a guard for a certain distance above the floor to prevent accident to attendants. Casings can be used on descending runs if desired; where the buckets come down sideways casings should always be used to confine material which clings to the empty buckets and which may be jarred loose. These casings are built in a similar manner to standard elevator casings, the corners and joints being made either by angles or by flanging the plates and riveting or bolting them together.

Conveyors

The term "conveyor" is often construed to include all continuous motion material handling machines. As used here, however, it is intended to designate only such machines as are designed primarily for moving materials in a horizontal direction. All of the machines described may, however, be installed at an angle with the horizontal and under exceptional conditions certain of them may be installed for transferring materials vertically.

Belt Conveyors

Belt conveyors consist of a fabric belt, usually rubber covered, which travels along over idlers at intervals, and on which the material is conveyed. The earlier belt conveyors used flat roll idlers, but it was soon recognized that

it was advisable when handling loose material to use a type of idler which would bend up the edges of the belt, or trough it so as to keep the material from creeping over the edges. This troughing of the belts or bending up of the edges was overdone at first; injury resulted from the constant bending back and forth of the belt, as it was troughed and then flattened out again as it passed over the idler pulleys. This excessive amount of troughing was unnecessary, and the fault has been corrected in most modern idlers which bend the belt only sufficiently to retain the material when traveling horizontally or at an incline suitable for this type of conveyor. On the return runs of belt conveyors the belt is supported on flat roll idlers, spaced at intervals of usually about twice that of the idlers on the carrying run.

Belt conveyors are used for many purposes, and since they can be run at quite high rates of speed, high capacities can be obtained from them. Where a properly lubricated and free running idler is used the power required for operation is comparatively small. Consequently these conveyors may be run for long distances with only a moderate amount of power. The fact must not be overlooked, however, that the fabric belts are more or less delicate compared with some other types of conveyors, and they will not, therefore, stand an equal amount of rough usage without serious injury. The material must also be delivered properly to a belt conveyor at the feeding point, or rapid wear is likely to occur. Positive lubrication and free running qualities of the idlers are very important, since with the speeds at which belt conveyors are operated idler pulleys revolve rapidly; if they do not turn freely, the friction and consequent wear on the belt is considerable. With 6 in. idlers and a belt running at 300 ft. per min., the idler pulleys revolve at a rate of almost 200 r. p. m.

Belt conveyors can be used for handling almost any kind of material which is not too wet, sticky or hot, and they are used extensively for handling coal, coke, sand, gravel, ore and grain. They can be operated on inclines up to about 18 deg. or 20 deg., providing the particles of material are not of such shape as to tend to roll back on the belt; with some materials, such as damp sand, the angle can be increased to 25 deg., though an angle as steep as this is rather unusual. Cleats are sometimes added to belt conveyors, especially of the portable type, which make it practical to handle many materials at a greater incline than would otherwise be possible. They can be operated at speeds up to 600 ft. per min., or even more under certain conditions, the ordinary speeds being about 250 ft. to 400 ft. per min.

The capacity of a belt conveyor in tons per hour can be calculated readily from the table given below. The figures given in this table are based on the assumption that the material being handled weighs 100 lb. per cu. ft. and should, of course, be increased or decreased proportionately to the weight of the actual material; for example, if the material handled is bituminous coal which weighs approximately 50 lbs. per cu. ft. the capacity will be only one-half as much as is shown in the table.

CAPACITY IN TONS PER HOUR OF MATERIAL WEIGHING 100 LB. PER CU. FT.

Width of Belt, Inches	Velocity in Feet Per Minute										
	100	150	200	250	300	350	400	450	500	550	600
12	21	32	42	53	63	74	85
14	27	41	55	68	82	96	110
16	37	56	75	93	112	131	150
18	52	81	105	131	162	183	210	236
20	65	97	130	162	195	227	260	292
22	77	116	155	193	232	271	310	348	387
24	95	142	190	237	285	332	380	427	475
30	150	225	300	375	450	525	600	675	750	825	...
36	210	315	420	525	630	735	840	945	1050	1155	...
42	260	390	520	650	780	910	1040	1170	1300	1430	...
48	390	585	780	975	1170	1365	1560	1755	1950	2145	2340
54	550	825	1100	1375	1650	1925	2200	2375	2750	3025	3300

The material may be discharged over the end of the belt, or discharge at intermediate points along the conveyor can be obtained by bending the belt around a reverse pulley device, known as a tripper. The tripper pulleys are so arranged that the belt travels up and around one pulley, then back and around another, the travel around the first pulley having the same effect as if the belt ended at this point, the material being thrown forward into a chute leading to either one or both sides of the conveyor. The trippers are either stationary, or may be mounted on a frame fitted with

truck wheels which travel on a track, so that the tripper can be moved along the conveyor.

These movable trippers are sometimes operated by hand, but usually are moved by power obtained from the belt itself, the tripper pulley shaft being connected by proper driving gearing to one or more of the truck axles. Suitable clutches are provided to throw in the gearing for operating the tripper in either direction. In some cases the clutches are thrown by levers which engage with stops along the line of travel so that the tripper is automatically reversed at the points where the stops are set, thereby keeping the tripper moving back and forth constantly; in this way the material may be discharged uniformly along the path of travel.

In some cases plows or scrapers, set diagonally across the belt, are used for scraping the material off the belt; it is necessary in such cases to use flat roll idlers, at least at the discharge point. This method of discharging material from the belt can be used only with certain kinds of material, since there is danger of wedging pieces of material between the scraper and the belt, resulting in injury to the latter.

Another method of discharging material from a belt conveyor is to use what is known as a shuttle conveyor, the whole conveyor being mounted on a frame fitted with truck wheels and operating on a track. The material is delivered to the conveyor at a central point, and the conveyor is moved back and forth, the direction of the travel of the belt being also reversed when necessary in order to deliver the material along the full length of the distance covered by the conveyor. The length of the conveyor required is only half the amount of the distance to be covered, since it operates over equal distances in both directions.

Specifications

Belts. Rubber covered fabric belts are used more extensively than any other kind for belt conveyors for handling loose material. These rubber belts usually have an extra thickness of rubber from 1/16 in. to 1/4 in. in thickness on the top or carrying side. Specially treated fabric belts without the rubber are also used for conveyors for loose materials.

A belt should be sufficiently flexible to conform to the shape of the idlers by its own weight in order to travel straight and not get out of line. If too stiff it will ride the inclined side of the idlers, run out of line and bear hard against the guide rollers if these are used, thereby injuring the edges. If too flexible it will crease longitudinally in the angle between the idler pulleys with certain types of idlers, thereby tending to start a separation of the plies at these points. It will also tend to flatten out, or lose its troughed form between the idlers. The plies ordinarily used for different widths are as follows:

12 in. and 14 in. wide	3 or 4-ply
16 in., 18 in. and 20 in. wide	4 or 5-ply
22 in., 24 in. and 26 in. wide	5 or 6-ply
28 in. and 30 in. wide	5, 6 or 7-ply
32 in., 34 in. and 36 in. wide	6, 7 or 8-ply
42 in. and 48 in. wide	7, 8 or 9-ply
54 in. and 60 in. wide	8 or 9-ply

The working tension in a belt should not exceed 24 lb. per in. per ply. The extreme outside limit is 36 lb. per in. per ply and this should be used only for temporary installations.

The width of the belt must frequently be determined by the size of the pieces of material handled, rather than by actual carrying capacity in pounds or cubic feet. The

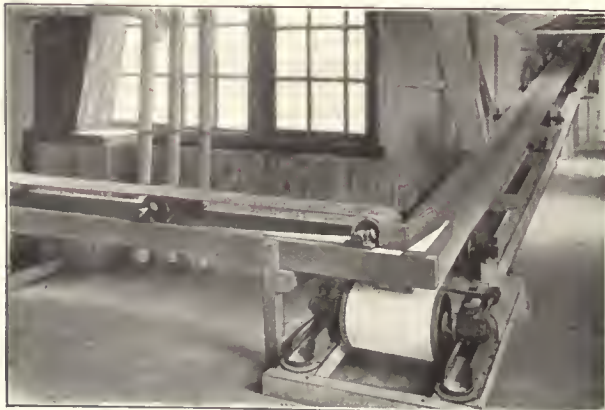
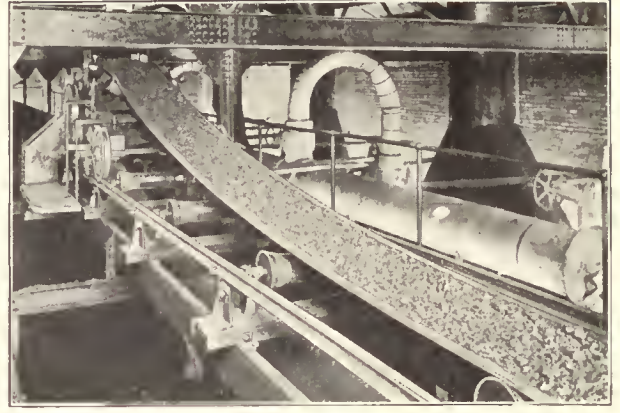
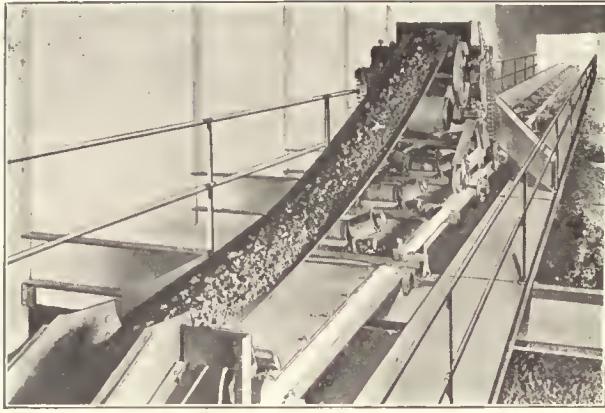

Typical Applications of Belt Conveyors

widths of belt most suitable for maximum sizes of pieces to be handled are as follows:

12 in. belt.....	2 in. pieces
18 in. belt.....	4 in. pieces
24 in. belt.....	8 in. pieces
30 in. belt.....	14 in. pieces
36 in. belt.....	18 in. pieces
48 in. belt.....	24 in. pieces

The life of a belt is affected by the characteristics of the material handled, the average number of hours of operation for a given period, the length of the conveyor, and the grade of belt. Assuming one feed and 1/8 in. good grade cover, a belt on a conveyor 100 ft. long should handle during its life a tonnage equal to 500 times its width squared; a conveyor 200 ft. long should handle twice as much, since the longer the conveyor, the less frequently a certain portion of the belt comes under the feed chute, and the less frequently it is bent around the pulleys.

Idlers. The earliest and simplest idlers were plain cylindrical rolls mounted on a through shaft turning in bearings at each bend. These flat idlers insure the longest possible life to the belt, and are still used more or less for handling loose materials, and universally for return idlers for belt conveyors.

The next step in the development of idlers was to use bell-shaped ends, which bent the belt up at the outer edges or gave it a troughed form to prevent the material from spilling over. From this followed, as a natural step, the combination of a central horizontal section and independent inclined ends or sections to bend up the edges of the belt; for wider belts additional idler pulleys were added, forming the multiple-pulley type of idler used extensively at the present time.

The single-pulley idler with the flared ends has, however, continued in use to a certain extent because of its simplicity and free turning qualities when the shaft is mounted in suitable bearings. With a single-pulley idler of this type, there is a difference in peripheral speeds between the smaller diameter at the center and the larger diameters at the flared ends, which causes a slight rubbing on the underside of the belt as the idler rotates. Experience has proved that this slight rubbing action has very little effect on the life of the belt, since the life is determined by the wear on the top side where the material is carried.

Since the free running qualities of a belt conveyor and therefore the life of the belt and the horsepower required to operate the conveyor depend largely on the free running qualities of the idlers, it is important that these idlers be carefully designed. This means that the lubrication must be effective under all conditions, especially throughout the variations in temperature under which the conveyor is called upon to operate.

Until recently, the usual method of lubrication has been by grease cups, the multiple-pulley idlers having either two grease cups, one at each end of the series of pulleys, or a separate grease cup for each pulley, the grease being forced through a hollow shaft and through openings in the shaft to the inside of the bore of the pulleys. This method of lubrication is effective, providing the grease cups are filled and screwed up at frequent enough intervals, and providing the grease does not solidify to the extent where it fails to reach the bores of the pulleys in cold weather. If for either of these causes the pulleys are not properly lubricated, they are likely to stand still, so that the belt slides over them; if this continues long the belt is likely to be seriously injured or destroyed by the wear on the underside.

Return idlers are usually mounted on a shaft, which turns

in two bearings, one at each end, and the flat roll idlers and flared end idlers are arranged in the same manner. It is a comparatively easy matter to design efficiently lubricated bearings for a shaft to revolve in, the most recent practice being to use bearings with oil reservoirs of the ring oiling or chain oiling type. Ball and roller bearings are also used to a considerable extent for both the multi-roll and uni-roll types of idlers, the roller bearings probably being superior and preferable to the ball bearings because of the better distribution of pressure on the roller bearings, and, therefore, the less likelihood of wear and loosening of the bearings.

Troughing or carrying idlers are usually mounted in cast-iron stands on a plank, resting on two longitudinal stringers, or on a steel channel attached to two longitudinal steel channels or steel I-beams. The bearings for the return idlers are ordinarily attached to the underside of the longitudinal stringers. In some cases unit stands are used, these stands supporting both the carrying and return idlers, and being so arranged that they may be bolted to stringers or to the floor.

Trippers. These consist of a pair of pulleys, either stationary or mounted on a movable frame, and arranged in such a way that the belt goes up and around one pulley, and back with a reverse turn around the other. The effect is the same as if the belt ended at the first pulley, and then went around the second pulley and started over again. The material is thrown forward as the belt passes around the first pulley in the same manner as it would be discharged at the end of a belt conveyor.

With stationary trippers, the pulleys are mounted on a shaft resting in fixed bearings or turning in fixed bearings. Where the tripper is movable, the pulleys are mounted on a shaft turning in bearings resting on a frame of cast iron, steel, or a combination of the two, the frame being mounted on truck wheels, which travel on standard T-rails. With the hand-propelled trippers, there is a crank which turns the shaft that is connected to one of the axles, thus moving the tripper along the track.

With the self-propelled tripper, the shafts on which the tripper pulleys are mounted are connected to the axles, and arranged with proper clutches for throwing in the drive from one pulley or the other, so as to propel the tripper in either direction. With the automatic trippers which travel back and forth constantly when in operation, clutch levers are arranged to be thrown by means of trips at each end of the travel of the tripper.

Pulleys and Driving Machinery. Because of the pull necessary to move a long or heavily loaded belt conveyor, care must be taken to see that the driving pulley is large enough in size, and that the belt gets sufficient wrap around the pulley, and sufficient pressure against the pulley to insure the proper friction for driving. When belt conveyors are subjected to heavy stresses, it is advisable to cover the driving pulley or pulleys with rubber lagging, and it is also frequently necessary to lag pulleys operating in dusty places. When very wet material is handled on a belt conveyor, the driving pulley is usually lagged with wood. To get more contact between the belt and the driving pulley, a snub or idler pulley is ordinarily used to bend the belt up on the underside and thus give it more wrap around the pulley.

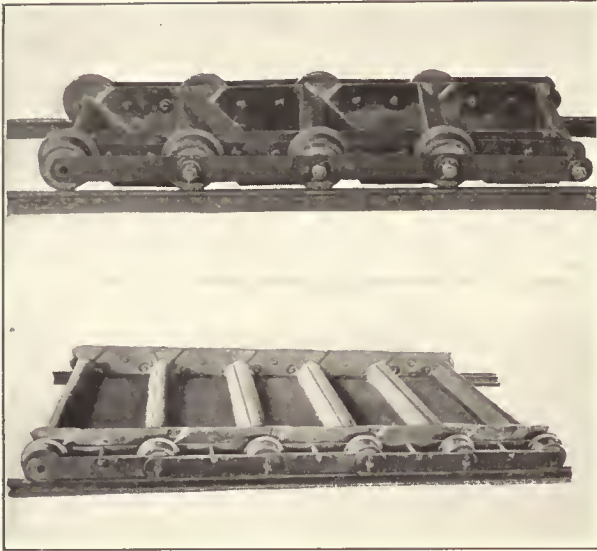

Steel Pan Conveyors

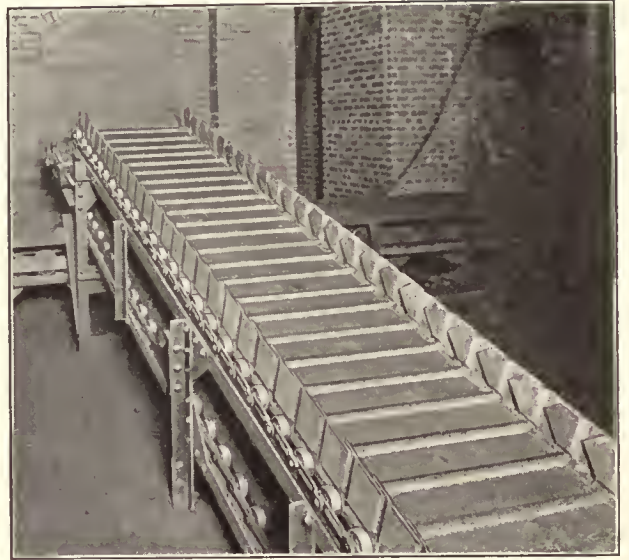

Steel Apron Conveyor

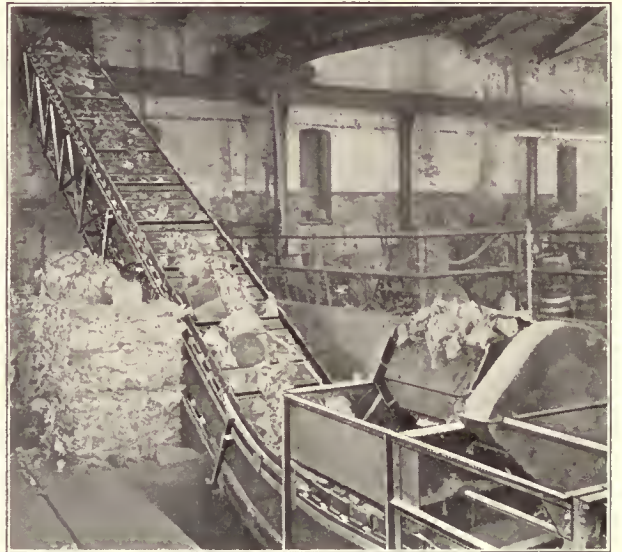

Applications of Apron and Pan Conveyors

For especially heavy duty belt conveyors, other methods are used for holding the belt against the driving pulley and giving a maximum amount of contact, one method being to use a small auxiliary belt, traveling around idlers which hold it close against the outside of the main belt, the auxiliary belt being pulled up against the main belt by the tension imparted to it by means of a movable idler equipped with a counterweight.

The driving shaft of a belt conveyor is usually connected to a motor by spur gearing, silent chain drive or belt drive with an intermediate countershaft in order to get the necessary speed reduction.

Care must be taken that the diameters of all pulleys around which the belt is bent, including foot pulleys and tripper pulleys, are not too small, since the constant bending of the belt around small pulleys when the belt is under stress causes the plies to separate, and results in the destruction of the belt.

Supports. The supporting structure may be either of steel or wood, steel, of course, being more permanent and less likely to get out of shape, but also, as a rule, more expensive. There are usually two main longitudinal stringers, the cross planks or channels for supporting the carrying idlers being attached to the top side, and the return idlers attached to the underside of the stringers. Where unit stands are used for both the carrying and return idlers, they can rest either on a pair of stringers or on a floor.

Housing. Belt conveyors are frequently run exposed to the weather, and if they are properly looked after and well lubricated this does not cause any serious deterioration. If, however, a conveyor is allowed to stand still for a long period, the idler pulleys and other pulleys are likely to become badly corroded, and the belt deteriorates to a certain extent whether it is running or standing idle. In winter time there is also more or less danger of trouble from the belt freezing fast to the idlers or ice forming on it and injuring it when it is started up; this, however, can be overcome by cleaning off the ice and snow and loosening up the conveyor before starting up. When belt conveyors are located inside a building they are not usually enclosed.

Housing when used may be built either of wood or with a wood or steel framework covered with corrugated iron. The footwork for access to the conveyor is sometimes built inside of the housing and sometimes outside of it, doors being provided so that the idlers may be properly lubricated and the conveyor taken care of.

Feeding Chutes. Probably more belts are ruined, or their life shortened, by the way in which the material is delivered to them than from any other cause. Where possible the material should always come onto the belt in the direction in which it is traveling, with as little impact and at as near the speed that the belt is traveling as possible. Where the material handled is both coarse and fine, it is good practice to feed over bars for a short distance so that the fine stuff will be deposited on the belt first, and form a bed to protect the belt from the impact of the coarser material.

Brushes. A revolving brush is sometimes employed near the discharge end of the conveyor to remove fine particles which might otherwise cling to the belt and be carried around over the idlers. The bristles should be stiff and durable but should not be made of wire

except in special cases. Provision should be made for automatic or manual adjustment to insure continued contact of the bristles with the belt regardless of wear.

Apron and Pan Conveyors

Apron conveyors consist usually of one or more chains to which wood or metal slats are attached, so as to form a continuous apron. For handling packages or piece articles the slats are not always continuous, but sometimes have spaces between them, but for handling loose materials they form a continuous apron, so that the material can ride on the apron in the same way that it rides on the belt of a belt conveyor. Instead of having separate chains, the slats and chain links are sometimes lashed together as a unit, in which case the parts are made of malleable iron or some other cast metal.

The slats are made in many forms, from flat steel plates simply butted up close together to the overlapping pans with deep corrugations, very similar to the bucket conveyor types of machines. As a matter of fact it is difficult to draw the line as to where the apron conveyor stops and the bucket conveyor begins, since the bucket conveyors are similar to the apron conveyors, except that the plates are formed into the shape of buckets which will handle loose material horizontally or at a considerable incline. Pan conveyors are also similar to apron conveyors, except that they have pans of considerable width instead of the narrower slats which form the aprons of the apron conveyor.

Aprons made with plain flat plates are seldom used for handling loose materials because of the slight gaps between the plates, which allow the material to leak through; the gaps open up as the slats pass around the sprocket wheels at the terminals, allowing the material to spill through still more. By curving the slats so as to bring the butting edges on the center line of the chains, it is possible to bring the adjacent slats close together, and there is little or no tendency to open up as they pass around the terminal wheels; this type of conveyor is used to a certain extent for loose materials.

The usual method, however, is to make the slats overlapping, the slats having one or both edges curved or beaded; the former is known as the single beaded type, and the latter as the double beaded type. The curve of the beaded part is concentric with the chain joint center, so that when the chains are bent at the joints the beaded parts rotate around these centers. The slats can be either made flat between the beads, or they may be bent down to a shape approaching a bucket, this type of apron conveyor being especially adapted to handling materials on inclines.

The chain or chains are sometimes attached to the undersides of the slats, and the chains or slats slide along on tracks, or are supported on idlers at intervals on both the carrying run and return run. Most modern apron conveyors, however, have roller chains attached to the ends of the slats, and tracks are supplied for the chain rollers to travel on, on both the carrying and return runs.

For moderate lengths and moderate capacities the standard malleable iron chains are used to a considerable extent, but the most usual type of apron conveyor is the one employing steel strap roller chains with good-sized flanged rollers at the chain joints, and with the inside links of the pan made wider, so as to form ends for the slats or pans in order to keep the material from spilling over the edge. The tracks for the travel of the rollers ordinarily are steel flats, steel angles or standard T-rails, resting either on steel or wooden supports.

Stationary steel side plates are frequently added to an apron conveyor, especially where it is to be used as a

feeder, so that a deep bed of material may be carried on the apron. The steel side plates are placed just inside the moving ends of the slats, which they overlap to a certain extent, the ends of the slats keeping the lower layer of material from getting out over the edge, and the stationary steel side plates keeping the upper layers of the material from escaping. For handling coal, ore, sand, gravel, crushed stone and similar materials, the pans are usually made of steel, but for hot or corrosive materials the pans are often made of malleable iron or cast iron.

Pan conveyors usually have rollers for supporting the pans on both the carrying and return runs, but the rollers and the chains are ordinarily separate; the rollers are attached at each side of the pans, or sometimes only on every second or third pan, and a single chain or sometimes a steel cable is attached to the center of the pans underneath, or two strands of chain are attached at the sides of the pans. Roller chains, usually of the steel strap type, are also used to certain extent, these chains being attached at the sides of the pans, so that the rollers can travel on tracks on both runs. In some cases the pans are arranged to dump the material at intermediate points, the discharge being accomplished by depressing the tracks at these points, so that the rollers at one end of the pans follow down the depressed track, thereby tilting the pans at an angle, so that the material is discharged from them. The pans are made of steel, cast iron or malleable iron, according to the material to be handled.

Bucket conveyors, or open top carriers as they are sometimes called, are similar to apron conveyors, except that the plates are formed in the shape of a bucket. The usual type is with a double strand of steel strap chain with flanged rollers at the chain joints, or sometimes in the center of chain links, the chain joints being equipped simply with driving collars to engage with the sprocket wheel teeth. The rollers are not always fitted to each pitch of the chain, but sometimes to every second or third pitch. These bucket conveyors are used extensively for handling various materials, such as coal, ore, sand, crushed stone and gravel and with buckets of the proper shape they can operate on comparatively steep inclines.

General Specifications

Chains.—Various types of chains are used for apron, pan and bucket conveyors, such as the Ewart, pintle, combination, malleable roller, and steel strap roller chains. For heavy service and handling abrasive materials the chain joints are frequently bushed to give greater bearing service and hard wearing faces, which can be renewed without renewing the whole chain.

Slats, Pans and Buckets.—The slats for apron conveyors and pans for pan conveyors are usually made of steel plate and sometimes of cast iron or malleable iron, depending upon the materials to be handled. The buckets of bucket conveyors are usually of steel plate, although they can be made of malleable iron. For light service, steel sheets of $\frac{1}{8}$ in. thickness, or even lighter, are sometimes used, but as a rule the thickness is not less than $\frac{1}{4}$ in., and often it is even thicker than this for the large, heavy duty machines.

Tracks and Supports.—For sliding slats or chains, steel flats or steel angles are ordinarily used. For roller chains with unflanged rollers, the tracks are also of steel flats or steel angles. For the steel strap chains with flanged rollers, or for flanged rollers separate from the chains, T-rails are used to a large extent, though steel flats or steel angles are also used more or less for this type of roller.

The supporting framework can be either of wood or steel, the steel framework being more permanent and less likely to get out of shape.

Terminal Wheels and Driving Machinery.—Standard sprocket wheels are used for the chains to travel around, including the driving wheels for the machine. The driven shaft is usually geared with spur or bevel gears to a countershaft, and there is frequently another geared countershaft in order to obtain the necessary speed reduction from the motor. The connection between the motor or second countershaft can be made by cut spur gearing, silent chain drive or belt drive.

Speeds.—Apron conveyors are ordinarily operated at slow speeds, usually from 50 ft. to 75 ft. per min. Where they are used for feeding materials from a hopper or bin, the opening in the hopper or bin is made large enough so that the material will always flow out as it is taken away by the moving apron, and since this large opening means quite a deep bed of material on the apron, the speed is usually quite slow to avoid feeding the material too rapidly. Apron feeder speeds are usually somewhere between 15 ft. and 30 ft. per min.

Housing or Casing.—These conveyors are ordinarily run open without any housing even when they are exposed to the weather, but they can of course be housed the same as other conveyors, with a housing built of wood, corrugated iron, or other material.

Screw or Spiral Conveyors

Screw conveyors consist of a shaft, usually hollow, on which is wound a spiral blade, the rotation of this spiral blade causing the material to be pushed along in a trough or on a bed of the material itself. As a rule there is a trough made of wood and lined with steel, or constructed entirely of steel. Screw conveyors are ordinarily made in sections, 8 ft. to 12 ft. long, with a short coupling shaft between each two sections, these shafts being supported in bearings. The hollow shafts to which the spiral blades

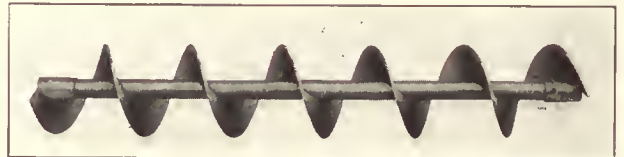

Single Screw

are attached are usually made of steel pipe. The blades are attached to the pipe by bolts, flattened at one end and riveted to the spiral blade, and threaded at the other end and fitted with a nut, the threaded end extending through



Double Screw

the pipe. The pipes are reinforced at the ends of each section by sleeves slipped over them, and the coupling shafts are held by bolts extending through the sleeve and pipe and also through the shaft.

Another type of screw conveyor, known as the Helicoid, has a continuous spiral blade for each section, this blade

when formed into a spiral being thicker at the inner edges and thinner at the outer edges and fitting close around the pipe, to which it is attached only at the ends.

The bearings for supporting the screws are held in

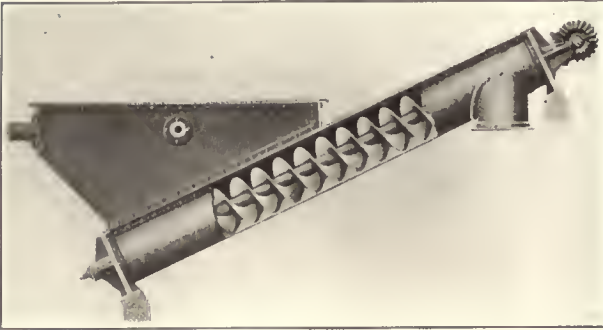

Inclined Screw

hangers attached usually at the upper edges of the trough. These bearings are designed to take up as little room as possible so as not to interfere with the passage of the material past them.

Screw conveyors should be operated with the material coming only about to the center of the shaft or a little less than this, otherwise the material will tend to crowd against the bearings.

In some cases where very heavy materials are to be handled or a steadier feed is desired, screws with a double set of flights are used. For handling abrasive materials



Rotary Cylinder Screw Conveyor

like sand, ashes and certain ores, cast iron screw conveyors are sometimes used. The flights are cast on sleeves, which are in halves and are bolted together over a solid shaft, the shaft usually being square in section where the flights are fitted to it. Cast iron screw conveyors ordinarily have a cast iron trough, though the upper part of it is sometimes made of steel channels.

Instead of a full flight extending all the way out from the hollow shaft, a steel ribbon is sometimes used, this ribbon being supported on bolts which hold it some distance from the shaft. Ribbon conveyors are used for semi-liquid or sticky materials, or where it is desired to mix materials, and where the capacity required is not great.

Other types of screw conveyors are also used for mixing, paddles sometimes being inserted between the flights of the spiral or the outer edges of the spiral flights sometimes being cut out so as to leave gaps; the cut part may be bent over so as to stir the material still more as it is conveyed.

When a conveyor trough is built entirely of steel plates they are usually reinforced with steel angles along the upper edges, and where covers are desired they are ordinarily bolted to these angles. As a rule steel troughs are supported on cast iron saddles, these saddles sometimes being only low saddles for the conveyor to rest on, and sometimes running all the way to the top edge of the troughs and forming the flanges for bolting the sections of the trough together.

Material is discharged from screw conveyors by gates in the bottom of the trough, the same as with flight conveyors. These gates are usually of the sliding type, being operated either by a direct pull handle or having a rack and pinion with hand wheel or chain wheel for operating the pinion shaft.

Screw conveyors are used for handling grains, flour, feeds, fertilizers, cement, crushed coal, sand, gravel, ashes, chips and many other substances which do not contain over one-inch lumps. They are usually installed in a horizontal position but may be inclined at an angle of 20 deg. without noticeable loss of capacity. Inclined conveyors should usually be run at slightly lower speeds than horizontal conveyors to avoid throwing materials over the flights. Screw conveyors may also be operated successfully in a vertical position for handling light materials such as cotton seed, ground cork, etc., which do not cling together.

Another type of spiral conveyor which has been used to a limited extent, consists of a steel cylinder with a spiral blade attached to its inside. When the cylinder revolves, the internal spiral blade causes the material to travel lengthwise of the cylinder. On the outside of the cylinder are rings at intervals which are supported on rollers, the cylinder being made to revolve by a pair of spur gears, the large gear consisting of a ring attached to the cylinder, and the small gear or pinion being mounted on a counter-shaft to which the power is applied. This type of conveyor is used for conveying, cooling or drying certain materials, such as soda, metallic ores, etc.

A table of capacities for screw conveyors is given below:

Size of screw conveyors—Ins.	GRAIN											
	3	4	5	6	7	8	9	10	12	14	16	
Speed, r.p.m.	200	200	190	180	175	175	170	165	165	160	160	
Cu. ft. per hr.	34	72	175	243	352	734	910	1,205	2,180	2,935	5,110	
Bushels per hr.	27	58	140	195	282	586	728	965	1,745	2,350	4,100	

Size of screw conveyors—Ins.	SAND, GRAVEL OR ASHES (Dry, and with no large lumps or stones)											
	3	4	5	6	7	8	9	10	12	14	16	
Speed, r.p.m.	125	125	120	115	110	105	100	95	90	85	80	
Cu. ft. per hr.	20	43	95	126	178	359	421	540	933	1,200	2,000	

Size of screw conveyor	COAL Screenings, or small sized coal, with no lumps larger than 1 in.											
	—Inches	6	7	8	9	10	12	14	16			
Speed, r.p.m.	110	105	100	95	90	85	80	80	80			
Cu. ft. per hr.	269	544	650	838	1,460	1,905	3,220	3,220	3,220			
Tons (2,000 lb.) per hr.	6.7	13.6	16.3	20.9	36.5	47.5	79.0	79.0	79.0			

*Small sizes of screw conveyor not recommended for handling coal.

Size of screw conveyor	CEMENT											
	—Inches	6	7	8	9	10	12	14	16			
Speed, r.p.m.	125	115	110	100	100	90	90	90	85			
Cu. ft. per hr.	167	233	468	541	725	1,210	1,625	2,730	2,730			
Barrels per hr.	42	58	117	135	181	303	408	683	683			

General Specifications

Flights.—The flights for steel screw conveyors are made of steel plates or sheets, the thickness varying according to the size of the conveyor and according to the characteristics of the material to be conveyed. For heavy or abrasive materials the flights should be made thicker to give longer wear. The pipes on which the flights are mounted are also made heavier for the heavy duty con-

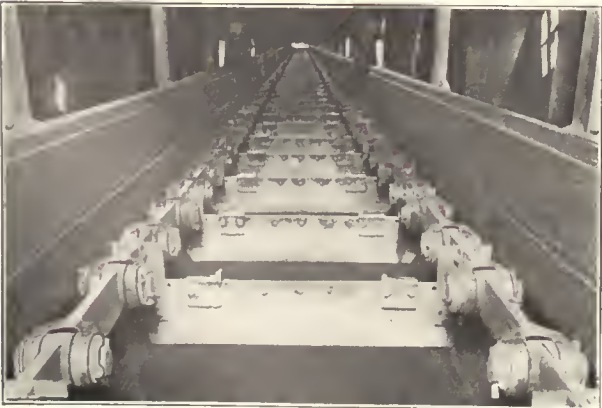
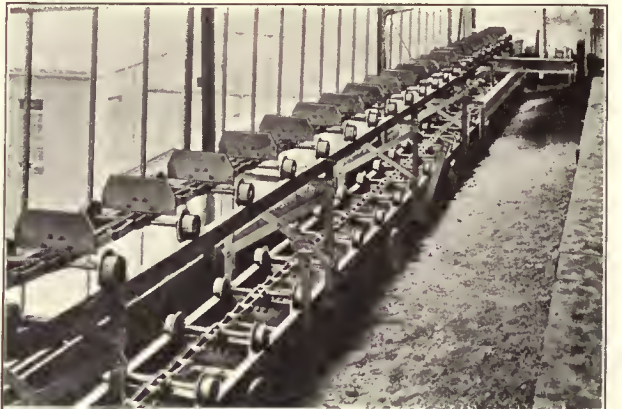
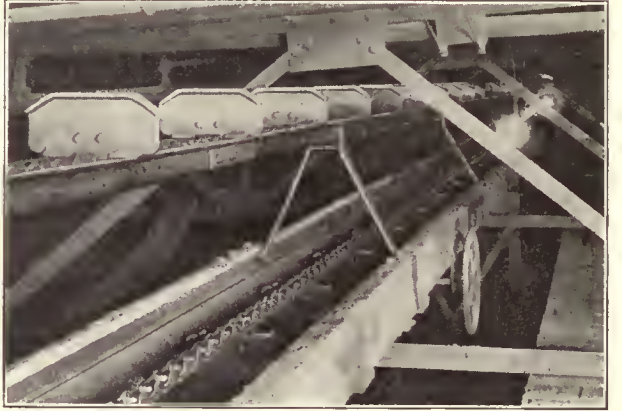
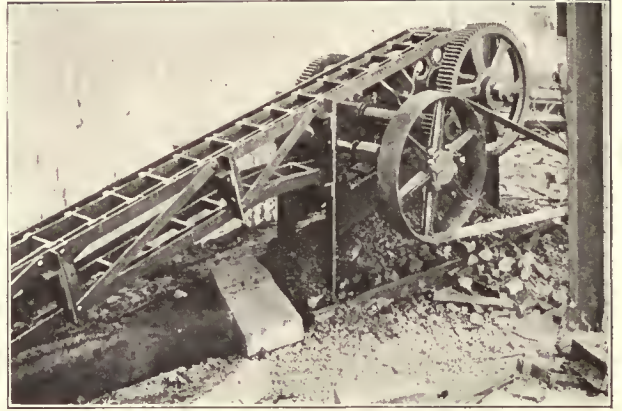

Typical Installations of Flight Conveyors

veyor. The table below gives the various thicknesses of flights commonly used with different sizes of conveyors and the sizes of the pipe on which the flights are mounted.

STEEL SCREW CONVEYOR AS USUALLY MADE AND MOUNTED ON PIPE

Diam., Inches	Inside Diam. of Pipe—Inches	Gage of Steel in Flights	Standard Lengths	
			Feet	Avg. Wt. Lb.
4	1	No. 18	8	25
6	1½	No. 16	10	40
9	1½	No. 14	10	54
10	1½	No. 14	10	60
12	2	No. 12	12	108
16	2	No. 12	12	120
16	3	No. 10	12	186
18	3	No. 10	12	192

HEAVY STEEL SCREW CONVEYOR

Diam., Inches	Inside Diam. of Pipe—Inches	Thickness of Steel Flights—Inches	Standard Lengths	
			Feet	Avg. Wt. Lb.
4	1	No. 10	8	32
4	1	⅞	8	39
4	1	¾	8	43
6	1½	No. 10	10	56
6	1½	⅞	10	64
6	1½	¾	10	85
9	1½	No. 10	10	106
9	1½	⅞	10	66
9	1½	¾	10	82
9	2	No. 10	10	105
9	2	⅞	10	70
9	2	¾	10	86
9	2	⅝	10	110
9	2	⅜	10	134
9	2	⅜	10	157
10	1½	No. 10	10	90
10	1½	⅞	10	114
10	1½	¾	10	134
10	2	No. 10	10	98
10	2	⅞	10	120
10	2	¾	10	143
12	2	No. 10	12	106
12	2	⅞	12	134
12	2	¾	12	165
12	3	⅞	12	165
12	3	¾	12	195
12	3	⅝	12	225
12	3	⅜	12	260
12	3	⅜	12	330
14	2	⅞	12	186
14	2	¾	12	208
14	3	⅞	12	213
14	3	¾	12	233
16	2	⅞	12	222
16	2	¾	12	250
16	3	⅞	12	235
16	3	¾	12	270
16	3	⅝	12	305
16	3	⅜	12	340
16	3	⅜	12	410
18	3	⅞	12	280
18	3	¾	12	320
18	3	⅝	12	360
18	3	⅜	12	400
18	3	⅜	12	480
20	3	⅞	12	330
20	3	¾	12	390
20	3	⅝	12	450

Troughs.—Where wooden boxes are used with steel lining, the lining does not come all the way to the top of the box but forms only a curved lining for the bottom of the box, the upper edge of the steel sheet being attached to the wooden box by nails or screws. There is usually a clearance of from ¼ in. to ½ in. between the flights of the screw and the trough. The steel conveyor boxes ordinarily have steel angles along the upper edges for stiffening and as a rule are equipped with steel plate covers, especially when used to handle dusty materials. The thickness of the steel plates for the steel conveyor troughs and for the lining of the wooden boxes varies according to the size of the conveyor and the material handled.

In many cases wooden boxes or concrete troughs are used without any lining, considerable clearance being provided between the conveyor flights and the sides of the troughs so that the bottom and sides of the trough are really formed by the bed of material itself. In some cases in which a pile of material is to be formed by a screw conveyor, no trough or box is provided, the screw simply pushing the material out on the pile as it is formed. Where cast iron screw conveyors with cast iron troughs are used,

the flights and troughs are made quite heavy, usually not less than ⅛ in. or ½ in. thick.

Bearings and Hangers.—The bearings are usually made of cast iron and are babbitted, the bearing being supported by a cast iron or steel hanger. An oil hole is usually provided down through the hanger, so that oil may be supplied to the babbitted bearings. In some cases where abrasive materials are handled, chilled cast iron bearings are used and no provision is made for oiling.

Box ends made of cast iron are usually provided, these box ends having babbitted bearings for the end shafts; for conveyors of much length a thrust bearing is also provided to take the longitudinal push on the shaft.

Driving Arrangement.—Screw conveyors are driven from a shaft extension at one end on which is mounted the driven wheel, this wheel being usually either a gear wheel or a sprocket wheel for connecting to a countershaft to which power can be applied in any ordinary manner. Where two screw conveyors are connected together at right angles, there are standard right angle drives with short chain drives and a pair of mitre gears with a short countershaft and the necessary castings for supporting the bearings.

Flight and Drag Conveyors

Flight conveyors consist of one or more chains which push the material along in a trough usually made of wood or metal, the pushing being done either by the chain or chains themselves, or by means of flights or pushers attached to the chains, the flights ordinarily being made of wood or metal. Flight conveyors may be installed in either a horizontal or an inclined direction.

The simplest type of these conveyors is known as a drag chain conveyor, where the chain itself does the pushing. With such conveyors a single wide chain is ordinarily used, the chain sliding along in the trough on the carrying run, and the material being pushed along in the trough by the chain. While the chain itself need not be very deep, it will convey quite a deep bed of material, the chain pushing the lower layer of material, and the upper layers riding along on the other moving material. The chain passes around sprocket wheels at the ends, and returns either over idler drums or by sliding back on guides. Sometimes the return run is above the carrying run, and sometimes below it. If the return run is above the carrying run, the material passes through and over the sides of the chain links at the discharge point, whereas if the return run is below the carrying run, the material is discharged over the end wheel, which in such cases is usually made with flanges to keep the material from spilling out sideways. These conveyors are seldom used for discharging material at intermediate points along the length of the conveyor, the discharge usually being only at the end. They are quite extensively used for handling coal, ashes, sawdust and some other materials.

Where flights or pushers are used, the chains are usually made fairly narrow, and either one or two chains are employed. If the flights are not too long, a single chain is sufficient. The flights are bolted to special attachment links on the chain, the attachments being at the center of the flight for a single chain, and out towards the ends or at the ends for double chains. For light materials like sawdust, feed and ensilage, both flights and trough are usually made of wood, the wooden flights sliding on the wooden trough, and returning on wooden slides or over idlers. The carrying run may be either above or below the return run. The material can be discharged either at the end of

the conveyor or at intervals along its length by means of gates or doors in the bottom of the trough, the material falling through the first open gate that it comes to.

One of the commonest forms of flight conveyor for handling coal is a single strand of chain with malleable iron flights bolted to the chain at intervals of usually about 18 in. or 24 in. The flights slide along the trough on the carrying run and push the coal; they slide back on angle iron tracks supported by a light steel frame which rests on the conveyor stringers at the sides of the trough. The malleable iron flights are made with thick edges where they come in contact with the trough and have shoes cast on the opposite edge or steel shoes bolted to the edge, these shoes sliding on the guides or tracks on the return run. The thick edges of the flights where they come in contact with the trough prevent any chatter or screech of the flights as they slide along and increase their life. As a matter of fact, when such a conveyor is loaded with coal, the coal tends to get underneath the flights to a certain extent, so that the flights ride on the coal and frequently do not come much into contact with the trough, except where the conveyor is empty.

The troughs are usually made of steel plates and are supported by wood or steel stringers along each side, the steel stringers usually being of the channel form. Where wooden stringers are used the supports for the return guides are also frequently built of wood, the return tracks themselves being steel flats on wooden stringers. For large capacity, or where the coal contains large lumps, two strands of chain are used, these chains being attached at the end or near the ends of the flights so as to give ample space for the lumps between. Flight conveyors of this type are sometimes built for capacities as high as 1,500 tons per hour, the flights and chains in such cases being entirely buried underneath the mass of coal; the upper part of the mass rides on the lower part which is pushed along by the conveyor.

Instead of allowing the flights to slide on the trough, they are sometimes provided with shoes, usually made of cast iron; these shoes are attached either directly to the flights at each side or to the ends of crossbars which are attached to the flights. Tracks, usually made of steel angles, are arranged at each side for the shoes to slide along on, the track being set at the proper height on the carrying run, so as to keep the flights elevated slightly above the trough. In place of the sliding shoes on each side of the flights, rollers are frequently substituted to obtain rolling friction, thereby reducing the pull necessary to move the conveyor. These rollers are mounted either on separate pins attached to each side of the flights, or to small axles or shafts extending across the tops of the flights. Such machines are usually of the single strand type, since the customary design for a double strand flight conveyor using rollers is to use two strands of roller chain attached to the ends of the flights and provide tracks for the chain to roll on. These conveyors ordinarily use short pitch malleable iron roller chains for moderate capacity and moderate length of conveyor, and steel strap roller chains for the larger machines. They are extensively used for handling run-of-mine soft coal at tipples and preparation plants.

Instead of using a chain or chains for pulling the flights, a steel cable is sometimes substituted. For cable conveyors the flights are usually made round and in two halves which are bolted together in such a way as to clamp tightly over the cable. The troughs are ordinarily made U-shape or V-shape, with a steel plate at the bottom resting on wooden planks: the V-shape trough is usually fitted with a curved steel plate at the bottom. The cable travels around sheave

wheels at the ends, these sheave wheels having gaps at the proper intervals to receive the flights which are attached to the cable. Cable conveyors are used for handling sawdust, shavings, wood blocks and pulp logs, and are frequently employed as retarding conveyors for lowering coal from hillside mines to tipples at a lower level.

General Specifications

Chain.—For drag chain conveyors, either malleable iron or steel chains are used, the pitch of the chain usually being not over 8 in. and the width, as a rule, not over 16 in. These chains are of the pintle type and the barrels of the malleable iron chain ordinarily have flat faces on which they slide on the trough. Sometimes wings are cast on the outside of the links to give greater width for pushing the material and to keep the heads of the pins from coming into contact with sides of the trough, thereby preventing the heads of the pins from being worn away.

For flight conveyors of moderate length and capacity the Ewart chains are used extensively and also the pintle and combination chains. The mono-bar type of chain is an excellent one to use for long flight conveyors because of its great strength and its comparatively light weight. For large capacity, double strand flight conveyors special types of steel chains are used. For the double strand roller flight conveyors, the smaller machines ordinarily employ malleable roller chain and the larger ones steel strap roller chains.

Wheels.—Standard sprocket wheels are used for flight conveyors. Where a conveyor carries on the upper run and discharges over the end, the end wheel is made of the drum type so that the material being conveyed will pass on over the drum at the end of the trough.

Flights.—Where wooden flights are used, they are usually made of a rectangular shape, and thick enough to be amply strong for the work—usually not less than $1\frac{1}{4}$ in. or $1\frac{1}{2}$ in. thick. A close grained wood like maple is best for flights. In some cases the grain of the wood is made to run up and down; that is, at right angles to the trough, instead of parallel to it, thereby giving greater length of life to the flights. This, however, necessitates a crossbar of wood or metal to reinforce the flight lengthwise to keep it from splitting. When the conveyor carries on the upper run, the flights are sometimes notched out so that the chain can set in the notches and not extend beyond the bottom of the flights. This allows the use of a plain bottom board for the trough upon which the flights slide.

Steel and malleable iron flights for conveying coal and similar materials are usually made with the corners beveled off to rest on a trough with sloping sides. The material tends to slide down to the center of the trough, and if one flight becomes overloaded the surplus material can get past it to the next flight. This design also eliminates any possibility of jamming of material between the ends of the flights and the sides of the trough. Malleable iron flights are ordinarily used in preference to steel flights as the steel flights tend to screech and chatter as they move along on the trough, and the thickened edges of the malleable iron flights also give greater wearing surface and longer life.

For suspended and roller flight conveyors where the flights do not touch the trough they are usually made of steel, ordinarily $\frac{1}{8}$ in. or $3/16$ in. in thickness. The flights are also made of steel for double strand roller flight conveyors, the large flights frequently having corrugations or being reinforced with steel angles to prevent distortion.

Troughs.—For handling light materials, such as saw-

dust, feed, etc., the troughs are usually made of wood. For handling most other materials, however, metal lining plates or complete metal troughs are used. For handling coal and similar materials steel plates are used, though cast iron plates are employed where the service is severe. Where drag chain conveyors are used for handling ashes or other gritty materials the troughs are usually made of hard white cast iron plates or sometimes of manganese steel. For an ordinary coal conveyor where the work is quite light, and the conveyor is not out in the open, steel plates $\frac{1}{8}$ in. thick will give several years' service. Where the service is heavy or where the conveyor is exposed to the weather, the trough plates should be not less than $\frac{3}{16}$ in. or $\frac{1}{4}$ in. thick, and for very heavy work they are made even thicker than this.

Bearings and Driving Machinery.—Since the speed of rotation of conveyor shafts is slow and the pull on the chain considerable, simple, rigid types of pillow blocks or post boxes are ordinarily employed, the type known as angle bearings being extensively used. These bearings are usually of the babbitted type, with some simple type of oil well or grease cup. The driven shaft is usually geared with spur or bevel gears to a countershaft, or is driven by a chain drive from a countershaft. When connected to an electric motor there is usually at least one additional countershaft geared to the first countershaft, the connection to the motor being by means of cut spur gears, belt drive or silent chain drive. The bearings for the higher speed countershafts should be equipped with efficient oiling devices.

Guides.—On the return run of drag chain conveyors, the chains may slide on steel or cast iron plates, or travel back over idlers spaced at intervals. For wooden flight conveyors, the wooden flights ordinarily return on wooden slides or boards. For flight conveyors with malleable iron or steel flights, the return guides are usually steel flats or steel angles which rest on wood or steel support. For roller flight conveyors and roller chain flight conveyors, tracks of steel flats or steel angles are used. For cable conveyors the round flights usually return in a V-shape or U-shape trough similar to the trough on the carrying run.

Supports.—The supports may be built either of steel or wood, the steel construction having the advantage of being more rigid and less likely to get out of shape; wooden supports, however, are extensively used and stand well, quite severe service.

Gates.—The gates for discharging the material from a flight conveyor are usually of the sliding plate type, operated either by a lever or with a rack and pinion arrangement. The rack is bolted to the gate plate, and the pinion is mounted on a shaft supported in bearings and has a hand wheel or chain wheel for revolving the shaft and opening or closing the gate.

Housing or Casing.—Flight conveyors are frequently run in the open exposed to the weather; if used quite constantly this does not cause any serious deterioration. When allowed to stand still for long periods the corrosion of the trough plates and other parts may be quite severe. There is also more or less trouble from ice and snow in winter time, it sometimes being necessary to loosen up the flights from the trough and guides before starting up the conveyor.

When the flight conveyors are located in a building they are not usually enclosed. When they are outside and it is desired to house them in, either a wooden structure is used or one with a wood or steel framework covered with cor-

rugated iron. The footwalk for access to the conveyor is sometimes built inside the housing and sometimes outside the housing, and doors provided for convenient access to the conveyor.

Reciprocating Conveyors

Conveyors of this class include two types: reciprocating trough conveyors, sometimes called "grasshopper" conveyors, and reciprocating flight conveyors.

Reciprocating Trough Conveyors

This type of conveyor takes its name of "grasshopper" conveyor from the hopping or jumping movement imparted to the material being conveyed by the movement of the conveying trough up and forward. The conveyor consists principally of a trough, usually of steel and of the proper depth and width for the capacity required and the material to be handled.

In one type the trough is supported on flexible arms at close intervals, these arms being inclined to a certain ex-

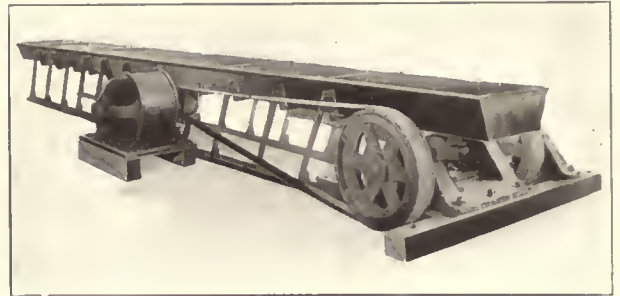

Reciprocating Trough Conveyor.

tent so that the trough moves up as well as forward when a vibrating motion is imparted to it by an eccentric and an eccentric rod. The throw is small and the speed fairly high. The eccentric rod is fitted with springs where it is connected to the trough to absorb the shock. The driving shaft is equipped with fly wheels which makes the operation more uniform. In another type the trough is supported by or suspended from laminated spring legs.

In either type the material may be screened in transit and delivery may be made at the end of the run or at any point through gates in the bottom of the trough. These conveyors may be used for handling sand, cement or most any loose material. They are particularly adapted for handling materials which are more or less sticky, especially raw sugar. In fact it is extensively used for this purpose since it handles the sugar without grinding or crushing the crystals, and is self-cleaning when in operation. The capacity obtainable is large and comparatively little power is required for operation.

Reciprocating Flight Conveyors

Reciprocating flight conveyors consist of a frame usually built of steel, which is made to move back and forth, and underneath which are hung hinged flights or pushers, which, when they move forward, push the material in troughs, and when they move back, lift up and ride over the material. The frame is equipped with rollers or wheels, spaced at comparatively long intervals, these wheels traveling on tracks on each side of the trough. These conveyors have been used principally for handling sand, especially molding sand in foundries. Their suitability for this sort

of work is due principally to the few wearing parts, the rollers and the hinges of the flights being about the only parts besides the driving machinery which receive much

mostly on a bed of the material itself, instead of sliding on the trough. The discharge of the material is accomplished by gates in the bottoms of the trough.

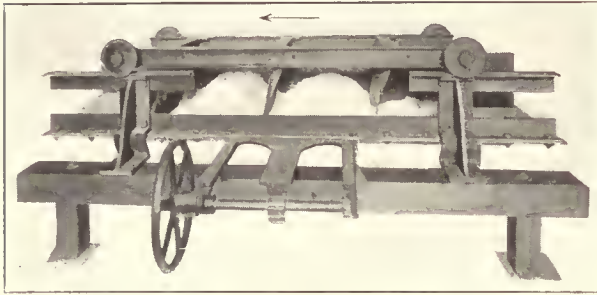

Reciprocating Flight Conveyor—Forward Movement

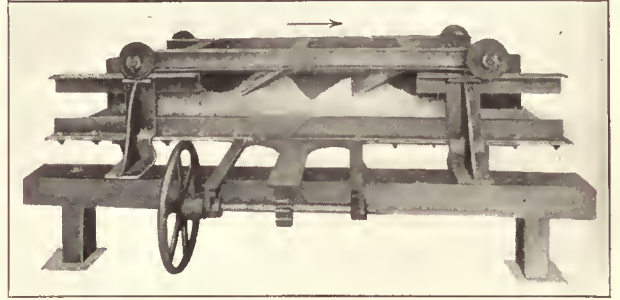

Reciprocating Flight Conveyor—Return Movement

wear, since sufficient clearance can be left between the flights and the trough so that the material slides along

The reciprocating movement is imparted to these conveyors by eccentric rods, or cranks and connecting rods.

Current Conveyors

Under current conveyors might properly be classed pneumatic conveyors, steam jet conveyors, hydraulic conveyors

and systems for pumping liquids. Hydraulic conveyors have been used to a limited extent, mainly for conveying

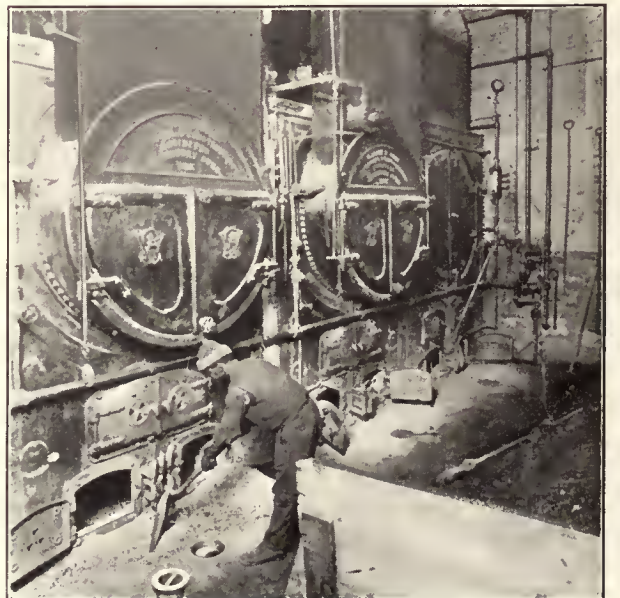
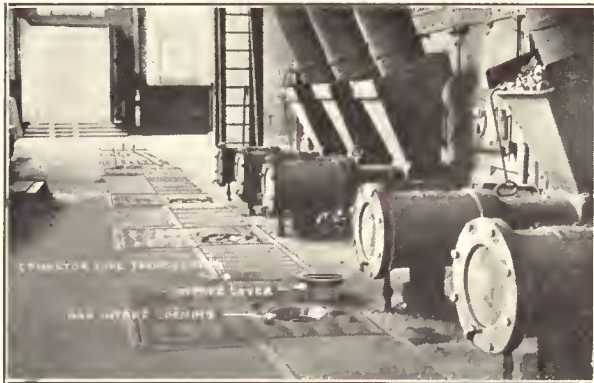

Steam Jet Ash Conveyor Installations

coal, and pumping systems are universally used in conveying water, oil, chemicals and so on. However, only the two first mentioned conveyors will be discussed here.

Steam Jet Conveyors

The steam jet conveyor is essentially a conveyor for ashes. It consists primarily of a line of pipe into which ashes are fed and through which they are carried to a discharge point by the flow of air induced by a steam jet of high velocity. The steam discharge tends to create a vacuum behind it, which in turn creates a current of air through the air intake provided at the end of the suction line.

The ashes are fed into the pipe through opening provided with covers, so that only the one in use needs to be uncovered. They are usually handled dry, and sprayed with water at the discharge point. If sprayed before they are handled they tend to pack in the turns of the pipe line. The ashes can either be discharged into a baffle box, storage bin, car or other receptacle. Since the ashes tend to wear the pipe turns, special fittings are provided with renewable faces or plates made of special wear-resisting metal.

The capacities of these conveyors are limited to the amount of ashes which can be fed to a single opening, the diameter of the opening usually being about 6 in. or 8 in. They cannot be successfully used with a steam pressure lower than 60 lb. per sq. in.

Pneumatic Conveyors

Pneumatic conveyors are air suction conveyors which convey the materials through pipes. The suction is produced by an exhauster or fan which partially exhausts the air from an enclosed tank to which the conveyor pipes are attached. As the air is sucked out of the tank a cur-

rent of air, which has sufficient velocity to float the material to be conveyed, is produced through the pipe line.

The conveyor pipes are provided with self-feeding nozzles usually on the end of a hose. These are moved around in the material to be conveyed and suck it up into the conveyor pipes through which it passes to the suction tank where, under the reduced pressure in the larger area, it drops into the storage space. From here it may be blown to other storage points by utilizing the air blast from the discharge side of the exhauster which is protected by a dust collector.

Pneumatic conveyors are particularly adapted for handling grain, malt, seeds, cotton, or other fine bulk materials which are not sticky or fragile. Fertilizer materials, fillers earth, soda ash, cement, food products, coal, ashes, starch and wood chips may be mentioned as some of the materials handled successfully by this system.

Probably the most common use of pneumatic conveyors is the handling of grain-unloading cars, ships and barges and rehandling in warehouses. One of the illustrations shows clearly the flexibility of the pneumatic system for car unloading. As may be seen the main duct extends the full length of the building and a connection can be made opposite any car. The siding shown in the illustration closely adjoins the building. However, this is not an essential with these systems as the hose lines may easily be extended to reach remote tracks. It should also be noted that the car unloading may be accomplished without the removal of the grain doors.

Another of the illustrations shows the application of the pneumatic conveyor to warehouse service re-handling grain. This system permits one conveyor to serve both the first and second floors without interference with teams or trucking. A third illustration shows a typical installation for handling ashes.



Handling Ashes



Pneumatic Station for Unloading Grain Cars



A Warehouse Application



Pneumatic Conveyor Inside a Car

These systems are equally efficient in the unloading of vessels and admit of easy adjustment for tidal variations. One of the important features of these systems is the

elimination of dust. For this reason pneumatic conveyors are especially desirable for handling material like soda ash, the dust of which is most irritating to human beings.

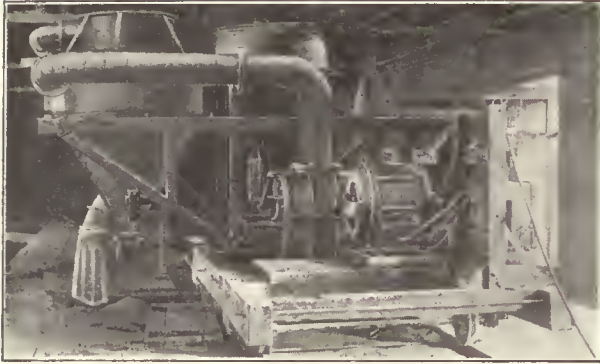

Portable Central Station



Unloading Copra from a Ship

Portable Loaders

A number of years ago certain coal dealers thought that some form of portable elevator for loading coal from ground storage to wagons would be of value to them as a labor saving device. One or two dealers went so far as to build machines of this type, the first machine being rather clumsy and expensive. One of the first of these machines used a vertical gravity discharge elevator, driven by a steam engine receiving steam from a small vertical boiler, the engine and boiler being mounted on the truck with the elevator, and the machine being self-propelled. This machine was used for several years, but was too clumsy and too heavy to be easily handled.

From time to time other dealers figured on using similar machines, but usually discarded the idea because of the expense. Most of these designs were for self-propelled machines. Later on one or two coal dealers purchased the necessary machinery and built home-made centrifugal discharge elevators, set at a considerable incline, and mounted on wooden framework carried by ordinary wagon wheels. These machines were not designed to be self-propelling, and since they were less expensive and were effective for the work, especially in handling run-of-mine soft coal, a demand was created for this design and it was developed still further, steel frames being substituted for the wooden frames and steel agricultural type wheels for the wagon wheels. These machines proved successful and quite a number of them were built. They were equipped with large buckets and since they were fairly heavy, they were not easy to move from one pile to another, but were especially adapted to cases where quite a large amount of one kind of coal was handled, for instance, run-of-mine bituminous coal or small anthracite steam coal.

Where the service required was for handling several different sizes or kinds of sized anthracite coal, it soon developed that lighter machines more easily portable would be more efficient and save a greater amount of labor. To meet this demand lighter machines were developed, the elevators being placed more nearly vertical so as to reduce the length required to elevate the coal to the proper height; since these machines were designed principally for handling sized anthracite coal they were fitted with chutes with interchangeable screens for screening out the under-sized coal as it was delivered to the wagons. The screenings fell into dust hoppers underneath the screen, these dust hoppers being ar-

ranged with a chute and gate so that the screenings could be drawn off into wheelbarrows. Where electricity was available these machines were usually driven by electric motors, though a great number of them were operated by gasoline engines.

From these beginnings the portable loader business has grown to large proportions. The machines have proved to be great labor savers, and have served to largely reduce the idle time of teams and trucks, since the time required for loading a ton of coal by hand shoveling is usually in the neighborhood of 15 minutes, in addition to this when the coal has to be screened this is another operation requiring more labor. With a portable loader the time required for loading a ton of coal is ordinarily from one to three minutes, the screening being accomplished automatically at the same time as the coal is loaded. With labor conditions as they are today, and with the operation of large and expensive trucks, which must be kept moving if they are to pay a good return on the investment, portable loaders have proved a valuable addition to the modern methods of handling coal, sand, gravel, crushed stone, coke, fertilizer and certain other materials.

In the last few years the portable belt conveyors have been added to the portable bucket elevator. These portable belt conveyors, of course, are not able to dig material from piles as the bucket machines do, but they have the advantage of conveying the material some little distance from the loading point, as well as elevating it, and being able to discharge the material at a higher level than is customary with the bucket machines. They are thus frequently better adapted to piling material or for delivering it to cars, trucks or bins where the height of delivery and reach of the bucket machines is inadequate.

They can also be used in combination with a bucket machine, which acts as a digger and delivers the material to the portable belt, which in turn conveys it to the desired point or spreads it over a certain area. The two machines together make a flexible combination, since the portable elevator can, if desired, remain at a fixed point, such for instance as when unloading material from a drop bottom railroad car, and the portable belt conveyor can be moved around so as to spread the material over a large area, the feeding point of the machine being kept always within range of the chute from the portable elevator.

In some cases two or more portable belt conveyors are used together, so as to reach to a greater distance or cover a larger storage area; after a pile of material is partly formed one of the machines is sometimes moved up onto the pile, so that the material which is fed to it from another machine can be piled to a still greater depth. The portable belt conveyors are sometimes fitted with wheels on which they may be moved around, and at other times are simply supported on the ground or on other supports, or hung from an overhead trolley.

The portable bucket elevators might be classified approximately as follows:

1—Light single chain machines with comparatively small buckets for handling prepared sizes of anthracite coal and bituminous slack.

2—Moderate weight, double chain machines, with larger buckets for handling prepared sizes of anthracite coal and bituminous slack, or even run-of-mine bituminous where there are not too many large lumps.

3—Heavy double strand machines, with large buckets, for handling anthracite or bituminous coal and having a capacity of one ton or more per minute.

Where a machine is to be used for handling sand, gravel, coke or other abrasive materials, special types of chains, usually the steel bushed malleable type, are used better to withstand the wearing action of the abrasive material.

The next step is the self-propelled machine, in which the motor or engine is geared to the truck wheels so as to propel the machine by its own power. This is advantageous with the heavy high capacity machines, but the smaller machines are seldom made self-propelling.

Several different types of screens are used with the anthracite loaders, and screens are occasionally used for some other materials. The simplest form is the plain gravity screen, in which the screen plate is set at a sufficient angle so that the coal flows over it by gravity. This type of screen, however, has two disadvantages. It must be set at such an angle that any size coal which is handled over it will always flow by gravity, in whatever condition it may be in, whether wet or dry. With a chute set at this comparatively steep angle, which angle is ordinarily fixed, the coal is apt to flow over the screen rapidly, especially the larger sizes, so that the screening is not efficient, more or less of the under-sized coal passing over the screen instead of going through it. The velocity imparted to the coal in flowing over the steep angle screen tends to cause breakage when the coal strikes against the other coal in the wagon, truck or pile to which it is being delivered. The capacity of a gravity screen is also quite limited, since the coal must be spread out in a thin layer over the screen, if the under-sized coal is to be efficiently removed. The smaller the screen, therefore, or the more rapidly the coal is passed over it the less efficient the screening.

The shaking screen can be set at a lower angle, since the movement of the coal over the screen is not dependent upon gravity, but is helped along by the upward and forward movement of the screen, this movement being similar to that of the reciprocating trough conveyor. With a shaking screen set at a comparatively low angle, the different sizes of coal move over it at approximately the same rate of travel, and since the coal is constantly agitated on the screen, it is spread evenly over it and is rolled over and over so that the screening is efficient. The shaking motion is provided by an eccentric driven by power obtained from the motor or engine.

Rotary screens have also been used to a certain extent on portable elevators, but they have not proved as simple and

efficient as the shaking screen, and since they are necessarily of comparatively small size, their capacity is limited.

Hand-Propelled Type

With hand-propelled portable elevators, the usual method of operation is to move the machine up to the pile so that the buckets dip into the lower edge of it, and then push the material up to the buckets by hand shoveling, the machine being moved from time to time as the pile recedes. The buckets dig up the material from the pile, but after they have removed several bucket loads from one point, the material is out of their reach unless it is pushed over to them. As a matter of fact this feeding the material to the foot of the machine sounds like a more laborious operation than it really is, since the depth of the pile increases as the machine is backed toward the center of it, so that it is more a case of avalanching the material down to the buckets or pushing it down hill towards them than it is actual shoveling of the material.

A number of schemes have been devised in the attempt to eliminate the man required for feeding the material to the foot of a portable loader. The only really efficient method is to make the loader self-propelling, so that it can be moved against the pile by its own power. More efficient feeding is obtained by making the elevator swiveling so that the foot of it can be moved around in an arc of a circle, thereby sweeping over considerable area at each new position of the loader. A great deal of material can thus be loaded before it is necessary to move the machine to a new position, and when it is necessary to move back a wide path will have been cleaned up, thereby allowing easy movement of the machine.

A feeding device at the foot of a portable elevator, even though it may help to clean up a little larger area around the foot of the machine before it is necessary to move, does not as a rule eliminate the man required for helping to feed the material to a hand-propelled machine, and if the machine is self-propelled no feeding device is necessary.

Some of the feeding devices and methods which have been devised are as follows:

1—Small scraper flight conveyor attached to the foot of the elevator, and arranged so that the other end of it can be raised and lowered, and in some cases arranged to swivel around sideways.

2—Mounting the elevator on a sliding platform or guides, so that the elevator can be moved back against the pile by a hand operated gear without moving the whole machine.

3—Blades or paddles mounted on the foot shaft of the elevator which is extended at each side, these paddles being set at such an angle that they tend, as they revolve, to sweep the material over sideways towards the buckets.

4—Arms attached to vertical shafts, one on each side of the foot of the elevator, these vertical shafts being driven by gearing from the elevator foot shaft and cranks, the moving arms push the material in from each side towards the buckets.

5—Circular revolving plates, mounted on vertical shafts, one on each side of the foot of the elevator, these serving to push the material in towards the buckets.

These feeding devices all tend to help feed the material to the foot of the elevator, but they do not, as a rule, entirely eliminate any of the men required for the operation of the machine. Feeding attachments are not required with self-propelled machines equipped with a swiveling device.

Portable Bucket Loaders

Where the loader is to be moved around in places where the headroom is limited, a machine of the collapsible or

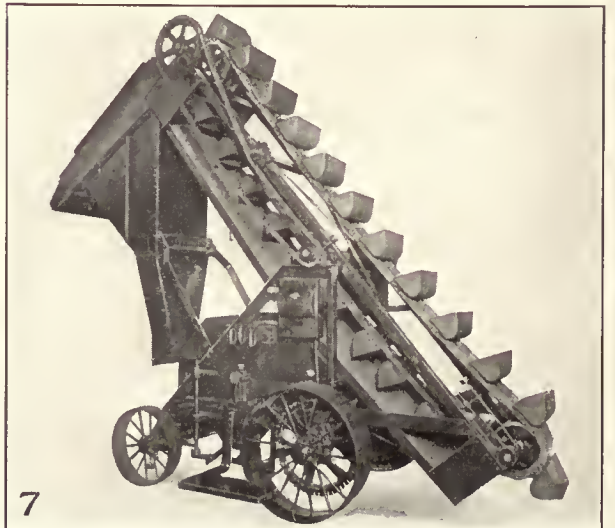
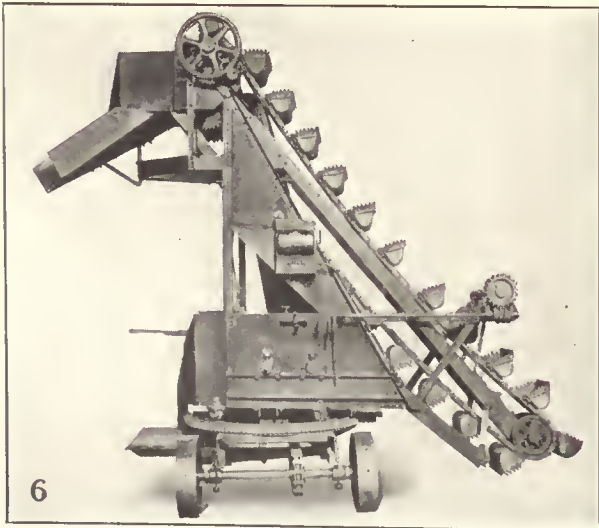
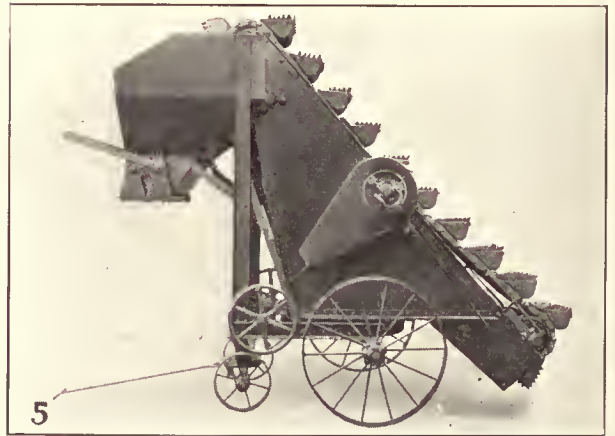
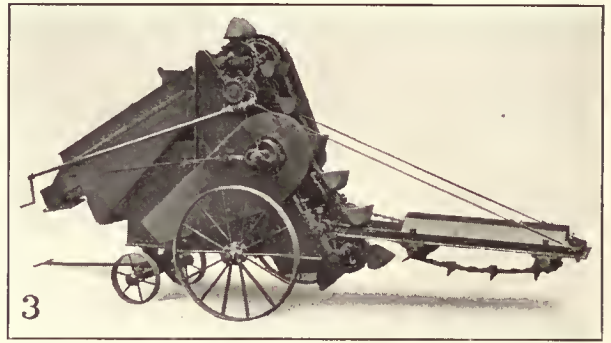
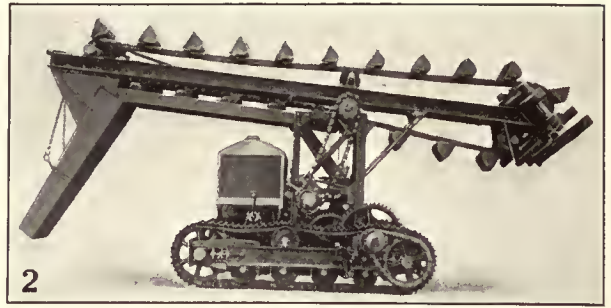
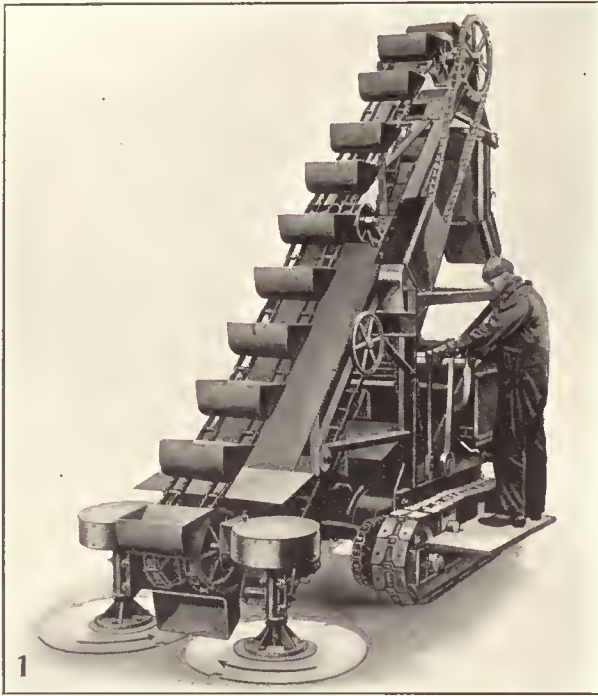

Types of Portable Bucket Loaders: (1) Rotary Disk Feeder; (2) Collapsible Type with Creeper Traction; (3) Bag Loader; (4) Rotary Motion Increases Digging Area; (5) Hand Propelled Fertilizer Loader; (6) Self Propelled Swiveling Loader with Pivoted Chute; (7) Collapsible Type Loader

folding type should be used. The collapsible machines have the elevator frame pivoted, so that the head of the elevator can be lowered when passing under an obstruction, for instance, when moving underneath a trestle or a shed roof. The collapsing movement is usually accomplished by a cable, winding on a drum, the drum being operated by a hand wheel working through a worm gear, the drum is held stationary in any position by the worm wheel.

For bagging coal, special low loaders have been designed with bagging attachments fitted to the end of the screen chutes. These bagging loaders are frequently fitted with the scraper flight conveyor feeder, operated from the front of the machine by the man who is doing the bagging. These feeding conveyors are more useful on the bagging loaders than on any other loaders, since they can be used to control the rate at which the coal is delivered to the bags, the operator lowering the feeder slightly as he fills each bag, and stopping the movement and therefore the feed of the coal when the bag is filled.

Another method of bagging coal, when using a loader, is to use a portable bagging hopper with the loader, this portable bagging hopper having a chute at the lower end fitted with a bagging attachment. The operator uses the loader to fill the hopper, and then bags the coal or a second operator feeds the loader and keeps the hopper filled while the first operator does the bagging.

When loading materials which are hard to dig, such as crushed stone, fertilizer, coke, etc., buckets with teeth or digging prongs are used, these teeth or prongs cutting into the material more effectively than a plain bucket.

Portable loaders are usually driven either by an electric motor or gasoline engine. The great majority of them use electric motors, since they are easy to operate and less likely to need attention. The feed wires for the motors are usually run to a number of convenient points, and sockets for plugs located at these points. The connection between these points and the motor is usually made by a flexible cable, with a plug the end which can be inserted into any one of the sockets.

Specifications for Portable Bucket Elevators

Buckets. The standard type A malleable iron buckets are ordinarily used on portable elevators; in some cases type B malleable iron buckets are used, and on a few machines continuous steel buckets are employed. Various types of digging prongs and teeth are attached to the buckets for handling materials that are difficult to dig. Buckets with reinforced digging edges are used for materials which are apt to cause rapid wear on the cutting edges of the buckets.

Chains. With small buckets for light service, a single strand of chain is used, but most loaders use two strands of chain. For handling coal and other materials which are not abrasive, the chains generally used are the standard detachable type, the combination chains and pintle chains. For abrasive materials the Ley type steel bushed malleable iron chain is ordinarily used.

The chains are usually provided with lugs for attaching direct to the backs of the buckets, though in some cases plates have been attached to the backs of the buckets and the chains have been attached to the ends of these plates so as to keep them entirely away from the buckets. Rollers attached to the ends of the buckets have been used to support the buckets on the up and down runs, these rollers traveling up and down on steel tracks.

Chain Speeds. For handling coal or other material where breakage is objectionable, the chain speed should be kept as low as possible and still give a good clean discharge

of the material from the buckets into the chute. In any case it is better to keep the chain speeds low so as to minimize the jar and vibration of the machine caused by the digging of the material. The chain speeds usually range somewhere between 105 ft. and 135 ft. per min.

Capacity. The coal loaders usually range in capacity from about one-third ton per minute to one ton per minute, the buckets ranging from 12 in. by 6 in. to 18 in. by 8 in., style A. The most used size of loader for handling sized anthracite coal will load at the rate of about one-half ton per minute, this being about as rapid a rate as is practical with the proper screening of the coal. Capacities of machines for other materials are similar in volume, that is from about 13 cu. ft. to 40 cu. ft. per min., the tonnage, of course, depending upon the weight of the material.

Frames. The frames of the machine are usually built of standard structural steel shapes and steel plates. With a collapsible machine the elevator frame is separate from the truck frame, so that it can rotate around the pivot point. In some of the other machines the elevator frame is also separate from the truck frame and is pivoted at the head, so that the clearance between the ground level and the buckets, as they pass around the foot wheel, may be adjusted. There is usually a spill apron underneath the return buckets to catch any material which is not discharged into the chute at the head, and to keep the buckets from sagging too far. The motor or engine and part of the driving machinery is usually enclosed in a box made of steel plates.

Trucks. For the hand-propelled machines, it is a distinct advantage to have the main supporting wheels quite large in diameter, so that they will be easier to move over the rough ground or obstructions. These wheels are, therefore, from 3 ft. to 5 ft. in diameter. The front wheels of the hand-propelled machine are usually not over 2 ft. in diameter, the axle being made swiveling and fitted with a tongue to aid in moving the machine. This tongue is usually removable so that it will not be in the way when the machine is in operation.

The front and rear wheels of the self-propelled machines are usually about the same diameter, since the smaller wheels do not require so much speed reducing gearing as the larger ones. For the heavier machines the treads of these wheels are sometimes as wide as 10 in. in order better to support the weight without cutting into soft ground. The driving wheels are usually fitted with cleats for better traction. The machines are sometimes mounted on track-laying type trucks when used on soft ground, as when digging into a sand bank.

Motors and Engines. The motors and engines usually range from 2 hp. in the small machines up to about 7½ hp. and even 10 hp. in the larger machines. Some of the larger machines with special feeder attachments use motors as large as 20 hp. but this is unusual. The motor or engine is ordinarily located in the lower part of the frame just above the truck wheels. A pair of spur gears with a rawhide pinion is ordinarily used for connecting the motor with the first countershaft. From this countershaft there is generally a chain drive to a second countershaft; in the case of a collapsible machine there is a pivot shaft and from this second countershaft there is another chain drive to the head-shaft of the machine. One of the driving wheels is fitted with a friction clutch, so that the machine can be stopped and started without stopping the engine or motor.

With the self-propelled machines the countershaft next to the motor is connected to the driving wheels by spur gearing and a chain drive, the spur gearing giving one direction of travel and the chain drive the opposite movement, the speed reductions being arranged to give the desired

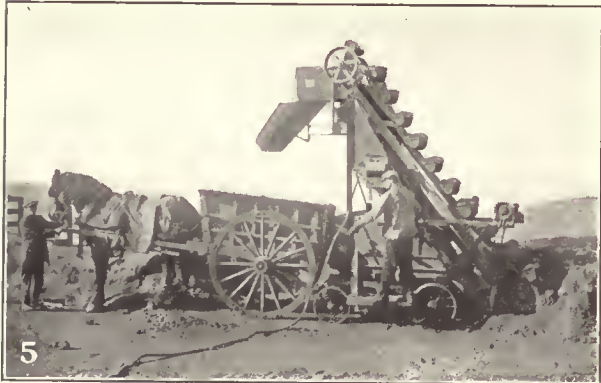
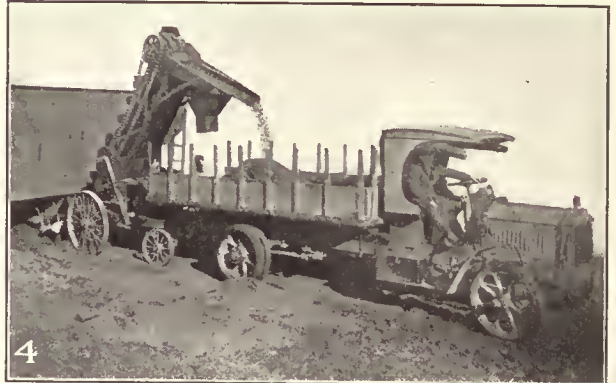

Portable Bucket Loaders: (1) Reclaiming from Storage; (2) Screening and Sizing; (3) Handling Gravel; (4) Car Unloading; (5) Digging and Loading; (6) A Self-Feeder Loading a Truck; (7) Storage to Truck; (8) Radial Type in Construction Work

speeds forward and back. Friction clutches operated by hand levers are used to throw in the gearing for the forward or reverse movements; the best machines are equipped with a differential in the rear axle similar to that in an automobile.

Steering Device. The steering of the machine is usually controlled by a lever or wheel, the front wheels of some of the best machines having steering knuckles similar to standard automobile practice. In the three-wheel machines, the turning of the single wheel is controlled by a worm and worm wheel operated by a hand wheel or capstan.

Speed. The usual traveling speeds for the self-propelled machines are in the neighborhood of 75 ft. per min., though speeds as high as 140 ft. per min. have been used. The backward speed is usually in the neighborhood of 25 ft. per min., though in some cases a much lower speed than this is used, some machines traveling as slow as 4 ft. per min. for working into the pile of material.

Weight. The weight of the portable elevator usually runs between 2,000 lb. and 8,000 lb. though some of the smaller machines are even a little under 2,000 lb. in weight. Light weight, of course, tends to make a machine more portable when it is hand-propelled, but if it is made too light it is apt to be too much subject to vibration, and will not be as good for digging into a pile or as durable as a slightly heavier machine.

General Dimensions. Most portable elevators are used for loading material into wagons or automobile trucks, the height under the chute varying from about 7 ft. to 8 ft. or a little over. The overall height of these machines usually runs from about 11 ft. to 13½ ft. or 14 ft., though some machines are higher than this. It is advisable to keep the machine as low in height as possible, and still have the proper distance underneath the end of the chute, since the machine is less apt to be top-heavy and does not require so much headroom in which to operate. The overall width of the machine is usually from 5 ft. 6 in. to 7 ft., though some of the machines exceed these dimensions. The overall length from the rear of the bucket in the operating position to the front end of the chute is usually somewhere between 11 ft. and 16 ft. or 17 ft. Where feeder attachments are used this overall length is, of course, increased.

Uses of Portable Loaders

Since the handling of coal at coal yards involves the storing and loading to trucks and wagons of a greater amount of material than any other industry, the coal dealers are the principal users of portable loaders. The rapidity with which the portable elevator has come into use in coal yards is the greatest argument in its favor as a labor-saving machine. It is used by coal dealers principally for loading coal from ground storage to wagons and trucks, or sometimes to small cars. It is also used for unloading coal as it is discharged from the bottom doors of railroad cars, and delivering to wagons or trucks, or sometimes direct to storage piles or bins. On account of the short reach of the portable bucket elevator, and because standard machines do not as a rule have a height of more than about 8 ft. underneath the chute, they are not as well adapted to piling coal or delivering to bins as portable belt conveyors with their longer reach and higher delivery point. The portable loader has, however, the advantage over the belt conveyor of being able to dig the coal.

Portable bucket elevators are also used extensively by coal consumers for handling from ground storage piles to wagons, industrial cars or trucks, or for unloading railroad cars. They can also be used to dig the coal and deliver it to a

conveyor system, or to a portable belt conveyor, the combination of portable bucket elevator and portable belt conveyor being an excellent one for both storing and reclaiming coal, the elevator acting as the digger and the belt conveyor as the distributor or loader. Portable elevators are also used for loading coke, sand, gravel, crushed stone, ashes, lime, loose earth, chemicals, fertilizer and various industrial products.

In some cases they are used for digging sand or gravel from banks, this, however, being severe service and requiring a rugged, heavy machine. The ground surface over which the machine has to travel when digging into a bank is apt to be soft and uneven; the standard truck wheels are not well adapted to traveling over this sort of a surface, and the machine is apt to be stalled. The track-laying type of traveler is more suitable for this service and by using the swiveling type of machine a fairly good path can be made by the machine itself as it moves. Because of the likelihood of the avalanching of the material, a machine having the elevator set at a rather low angle of incline is more suitable than one with a steep angle, since it has a longer reach, thereby making it possible to keep the main part of the machine farther away from the bank, and also avoid the necessity of driving the wagons or trucks so close to the bank.

The fertilizer manufacturers have become quite extensive users of portable loaders because of the large amount of material which has to be handled from ground storage. Since some of the fertilizer materials pack quite closely, and are, therefore, hard to dig, special types of machines have been developed for this purpose. The materials are usually delivered to wheelbarrows or low cars and it is possible, without making the height of the machine excessive, to equip it with loading hoppers with gates at the bottom, so that the wheelbarrows or cars can be quickly loaded from these hoppers. The machine can thus keep on working and loading the material to the hopper, without regard to whether there is a car or wheelbarrow in position to be loaded, thereby increasing the rate of handling.

The comparison below of the costs of loading, and the number of trips possible when using hand labor and when using a portable loader, is taken from the catalog of a portable loader manufacturer.

Comparison of cost by hand labor and portable loader to load 5 cu. yd. of broken stone, coke, gravel, sand, coal, etc., into an auto truck:

HAND LABOR	
Two laborers, 45 minutes.....	\$.52½
Loading time of auto truck, 45 minutes at \$25 per day of 10 hours	1.87½
Loading cost by hand.....	\$2.40
Loading cost by machine.....	.45½
Amount saved	\$1.94½

PORTABLE LOADER.	
Two laborers, 8 minutes.....	\$.09
Loading time of auto truck, 8 minutes at \$25 per day of 10 hours32
Power consumed at ½c. per cu. yd.....	.02½
Oil, grease and interest on investment.....	.02
Loading cost by machine.....	\$.45½

Comparison of trips in loading 5 cu. yd. of broken stone, etc., into an auto truck between hand labor and a portable loader:

HAND LABOR	
Time to load truck with two men.....	45 mins.
Running time of truck.....	30 mins.
Round trip	75 mins.
Number of trips in 10-hour day.....	8

PORTABLE LOADER.	
Time to load truck with two men.....	8 mins.
Running time of truck.....	30 mins.
Round trip	38 mins.
Number of trips in 10-hour day.....	16

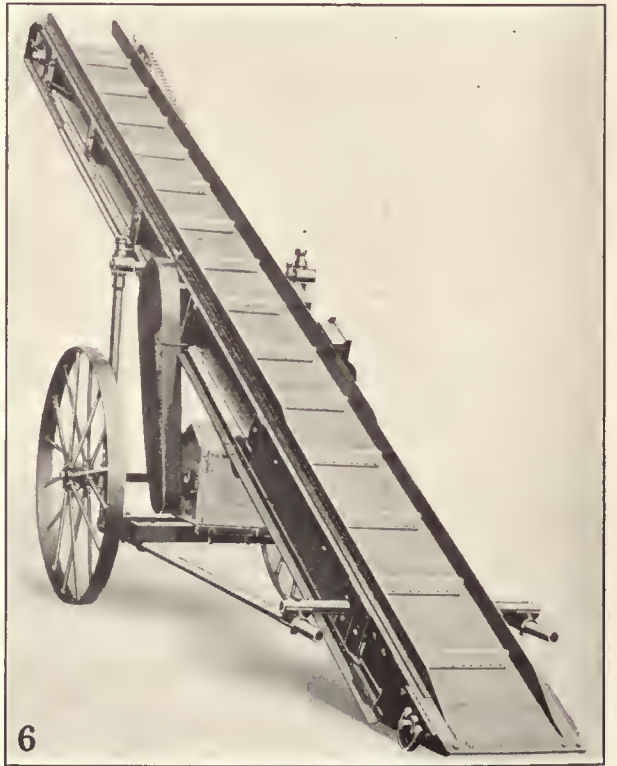
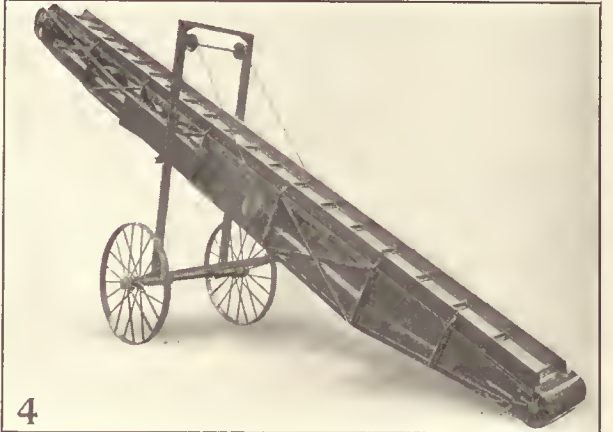
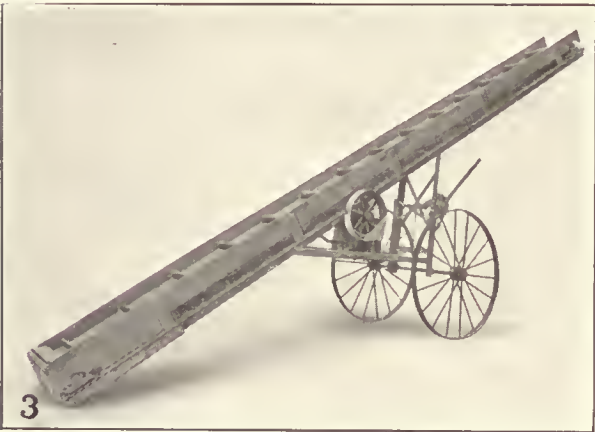
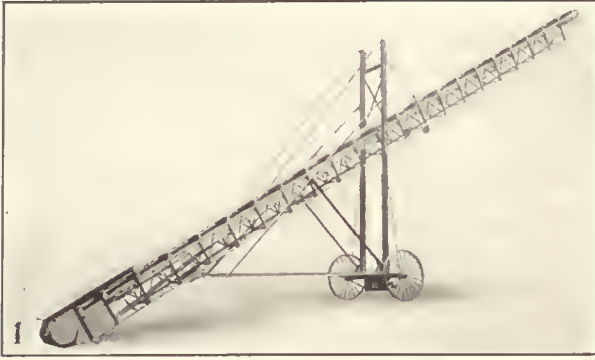

Types of Portable Belt Conveyors: (1) Tronghing Type 60 ft. Span; (2) Self-Propelled Snow Loader; (3) Equipped with Hooks for Attachment to Car or Elevated Track; (4) Hand Wheel Height Adjustment; (5) Equipped with Screening Hopper; (6) Scoop Type

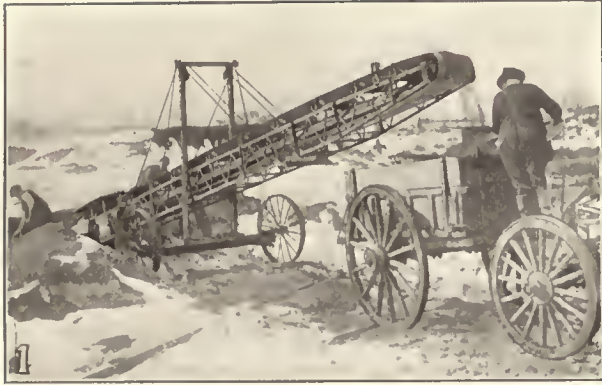

Applications of Portable Belt Conveyors: (1) Truck Loading; (2) Coal Storage; (3) Industrial Car Loading; (4) Gravel Pit; (5) Retail Coal Yard; (6) A Unit in a Conveyor Line; (7) Car Unloading; (8) Handling Lumber

Portable Belt Conveyors

The modern portable belt conveyors are a somewhat later development than the portable elevators, and they also have come into use quite rapidly for storing and reclaiming various materials, especially when unloading from hopper-bottom railroad cars to ground storage piles. They are usually built with small foot pulleys, and, when unloading railroad cars, the foot of the machine can be pushed back far enough underneath the discharge point of the car so that the material will flow out of the car directly on to the foot of the belt.

Portable belt conveyors consist of a woven belt, usually rubber covered, traveling around terminal pulleys at each end, and supported intermediately either by idler pulleys, steel plates, or both. Most of these conveyors use flat belts with cleats riveted to them at intervals, to make it possible to carry material up a steeper incline than would otherwise be possible, and with steel plate side guards to keep the material from spilling out sidewise. In some cases troughing idlers are used on the loaded run, but the troughing or bending of the belt makes the use of cleats on the belt a more difficult problem, and without the cleats the maximum angle of incline possible is limited usually to about 20 deg. to 25 deg., depending upon the material being conveyed.

A portable belt conveyor, which is to be moved on a floor or on the ground, is equipped with two truck wheels at a point somewhere near the center, so that the machine is very nearly balanced.

When it is to be moved the head end is tilted down so as to raise the foot off of the ground, and bring the weight all on the two wheels at the center. It can then be moved around at will. Most machines are equipped with a hoisting arrangement for changing the angle of incline of the machine, so that the different heights can be obtained underneath the discharge point.

Where a machine is to be seldom moved, the wheels are sometimes omitted and it is supported on stationary supports or on the pile of material itself, or it is sometimes hung from a trolley traveling on an overhead rail. While portable belt conveyors are not digging machines, since the foot pulleys are small and the foot end of the belt comes close to the ground, it is easy to push the material over onto the foot of the belt.

Specifications for Portable Belt Conveyors

Belts. Belts used for portable belt conveyors are ordinarily standard rubber covered conveyor belts with an extra thickness of rubber on the carrying side. The widths used are from 12 in. to 24 in. To make the belt capable of carrying material up a steeper angle, cleats are frequently riveted to the carrying side. These cleats are sometimes strips of belt; sometimes pieces of belt are bent in the shape of a U, and riveted to the belt to give cleats of considerable height. In other cases steel angles are used for cleats, one leg of the angle being riveted to the belt. Cleats are ordinarily used only with flat belts, though one or two manufacturers attach them also to troughed belts, the cleats in such cases being made so that only a short section is attached to the belt at the center; the outer edges

of the cleat are raised slightly above the belt to allow for the bending or troughing of the belt.

Pulleys. Standard belt pulleys are used at head and foot, the drive pulley being at the head and the foot pulley being as small as it is feasible to make it.

Idlers and other Belt Supports. Where the loaded run is supported on troughing idlers, these idlers can be either of the uniroll or multiroll type. If no cleats are used the return run of the belt can be supported on return idlers. For flat belts with cleats the belt is usually allowed to extend slightly underneath the edges of the side guards, and is supported on the loaded run principally on angle guides underneath the edges of the belt, the belt sliding on these guides. Rollers are also used at intervals to take part of the weight of the belt and material. As a rule the belt slides back on angle guides which support the edges.

Frame. The frames are built of structural steel shapes and plates, and are made as light as is consistent with strength and rigidity in order to make the machine as portable as possible. A housing for the motor is usually built between the carrying and return runs of belt somewhere near the center of the machine. The foot of the machine is housed in at the sides with steel or cast iron plates, or a combination of the two, to prevent material from getting on the return run of the belt.

Truck Wheels. The truck wheels are usually of the standard agricultural type, and for the adjustable machines a frame is attached to the axle and a hoisting arrangement is fitted to this frame; one type has small steel cables which travel over shaves and wind on small drums which are operated by a hand wheel.

Driving Machinery. These machines are operated either by electric motors or small gasoline engines, the motor or engine and part of the gearing being housed in, as previously described. The motor or engine is usually connected to a countershaft by spur gearing, and chain drives are used to connect up to the head shaft of the machine. The motors or engines vary in horsepower from 1½ hp. for the smaller machines up to 7½ hp., or sometimes even more, for the larger and longer machines.

Belt Widths, Speeds and Capacities. The belt widths ordinarily used are from 12 in. to 24 in. The smaller machines have a capacity of approximately one-half ton of coal a minute, and the large machines as high as two tons of coal per minute, this capacity, of course, depending upon the belt speed used. The belt speeds ordinarily range somewhere between 150 ft. and 250 ft. per min.

Lengths and Weights. The machines most used have a length of about 25 ft., center to center of head and foot pulleys, though they are made in lengths as short as 12 ft. and as long as 60 ft. The weights of the same lengths of machines vary considerably, some machines being made very light with the idea of easy portability, and other machines being made heavier so as to give longer service without racking themselves to pieces. The weights of the 25 ft. machines with 16 in. or 18 in. width belts probably vary as a rule between 2,000 lb. and 3,000 lb. for the complete machine. A 12 ft. machine with a 12 in. belt could be built as light at 750 lb. and a 60 ft. machine with an 18 in. belt, would weigh in the neighborhood of 5,800 lb.

CONVEYING MACHINERY DETAILS

A Treatise Describing and Illustrating the Mechanical
Details of Construction of Continuous Elevators
and Conveyors Used in Handling Both
Packed and Loose Materials

By

P. R. HOOPES

Consulting Engineer; Associate Member, American Society of Mechanical Engineers

Assisted by

W. T. SPIVEY

Consulting Engineer; Associate Member, American Society of Mechanical Engineers;
Member, Society of Terminal Engineers

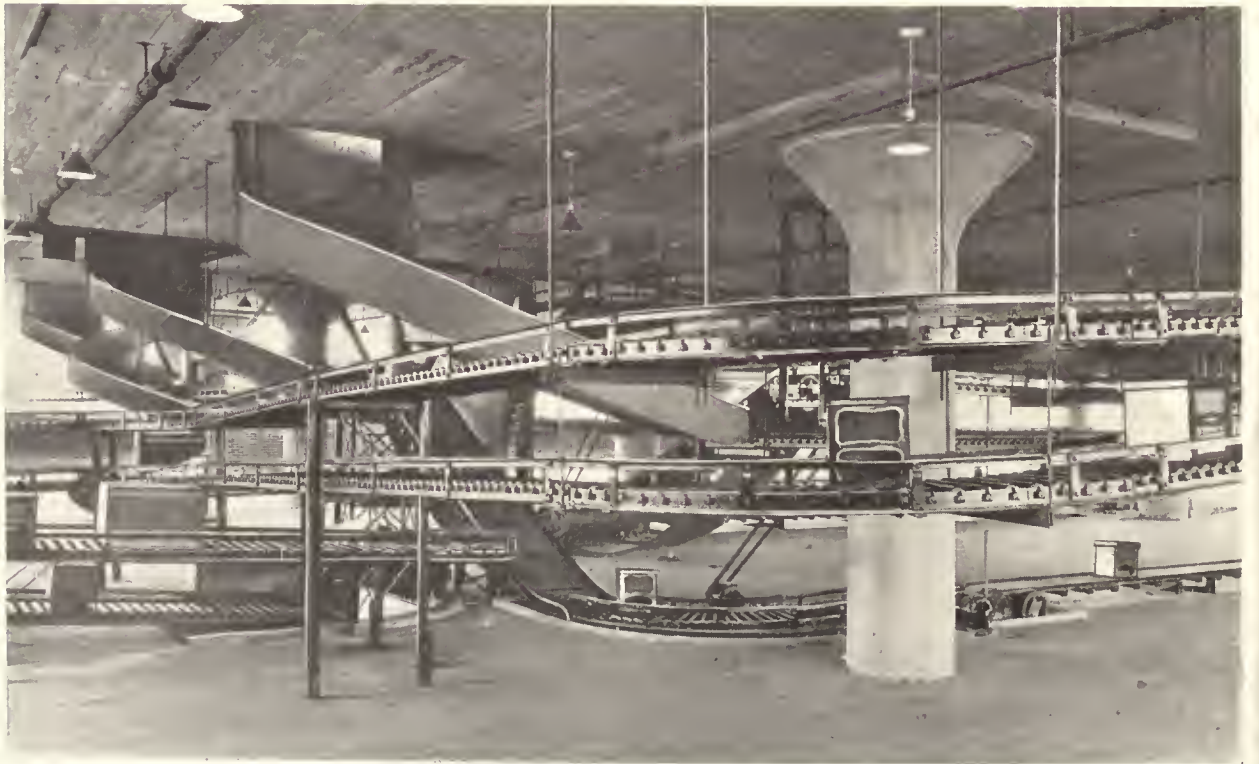

Conveyor Details

CONVEYING MACHINERY is very largely built up of standard detail parts which have been developed exclusively for this purpose. The invention of detachable link chain by W. D. Ewart in 1873 gave tremendous impetus to the use of conveying equipment and created a demand for the auxiliary parts used in connection with chain type conveyors. Similarly the perfection of a satisfactory rubber conveyor belt established this type of equipment and called for the development of belt conveyor idlers, trippers, and the like, to satisfy the growing need for the special parts required to construct these conveyors. With the experience gained on these simpler devices, and a continuous development of new types, the manufacturers have built up an extensive line of standardized parts with which to meet the requirements of the most diversified practice. Today there are available for the designer of conveying machinery dozens of types of chain, each suited to certain specific purposes, thousands of attachment links, innumerable take-ups, driving mechanisms, bearing boxes, buckets, flights, aprons, and many other elements which go to make up modern automatic material handling machinery. In fact, the number of parts is so large as to increase the demand for care in their selection and use, to fit the work to be done.

No attempt is here made to show all details of every type of equipment in successful use, but merely to cover the ground in a general way so as to give to the user of such machinery a view of the most important elements approved by modern practice.

Aprons

An apron is a practically continuous carrying surface made up of wood or steel slats carried by one or two strands of chain and forming in effect a moving table. Aprons are used for the heaviest service, such as ore handling, as well as for comparatively light duty in conveying small packages. A great many different styles and modifications of aprons are in use to meet the various

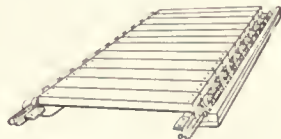

Figs. 1 and 2

conditions of practice, those of wood being particularly adapted to handling packed material or bulky articles, while the steel pan type aprons are especially applicable to heavy loose material, to severe conditions of heat as in lehrs or annealing furnaces, or to other rigorous service where wood is structurally unsuited to the conditions.

Much ingenuity has been displayed in the development of special aprons for unusual uses. Special cleats, arms or cradles are sometimes applied to the slats to adapt them to handling packages of awkward shape, or to prevent the articles carried from sliding or rolling when the apron is used on an inclined conveyor.

For light but reasonably bulky merchandise, rectangular wood or structural steel channels, angles or pressed steel slats are attached to the strands of the chain at intervals (Fig. 1). Hard maple is the wood best suited for use as slats. The slats must be close enough together to insure that the packages will not drop between them nor catch at the point where the chains pass around the sprockets. Aprons with open spacing should not be used when it is desired to discharge the material with sweep diverters at

points along the conveyor, as there is danger of the packages catching in openings between the slats.

A continuous wooden apron (Fig. 2) is made up of slats set close together. This type of construction is very widely employed for handling heavy miscellaneous packages. The slats are usually attached to roller chains which run in steel guides. By running the chain in guides upward or downward curves can be made in the path of the apron, thus adapting it to many purposes where combinations of horizontal and inclined runs are required.

Ordinary packages can be easily diverted, from conveyors with properly designed slats set close together, with an adjustable sweep at any point along the run.

Cleats of wood or metal are commonly used on inclined apron conveyors (Fig. 3). These are absolutely necessary if the angle of incline is sufficiently steep to offer any possibility of the material sliding or rolling backward. The limit of height of these cleats or arms is the tendency to turn backward under the ascending load.

For long heavy duty apron conveyors, wood slats can be fastened to malleable iron or steel chain not fitted with rollers (Fig. 4). In this construction large plain or flanged wheels are fastened at intervals to the ends of the

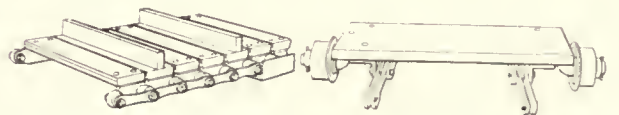

Figs. 3 and 4

slats, the rollers serving to guide and support the apron while the chain merely transmits the driving pull to the load. This arrangement is used very largely on portable conveyors and piling machines of the chain and apron type as it is of lighter construction and requires less power for driving on account of the larger wheels. It is also much

used on stationary installations. This is commonly known as the roller carriage type.

Steel aprons (Fig. 5) are used for handling heavy bulk or packed material and various types of steel slats are available to meet the usual conditions of service. Plain slats, either flat (A) or convex (B) are satisfactory for coarse material which will not drop between them. For moderate duty in handling sized materials, plain overlapping slats are arranged shingle fashion (C), for lehrs the single curve slat (D) is useful, while for fine and coarse material of all kinds a beaded overlapping slat will usually be required. Of the beaded types (E) is probably the most common, while (F) is particularly useful on inclined conveyors handling friable material as it gives a smooth and easy discharge at the end. Modifications of (E) are shown at (G) and (H), the former approaching the bucket conveyor in shape and being useful for steep

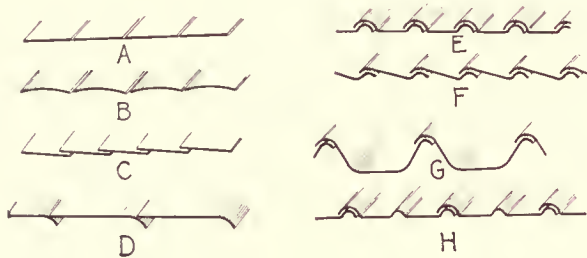
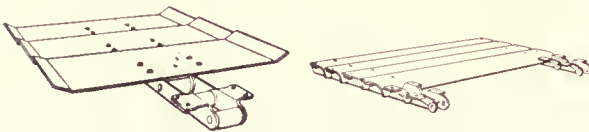

Fig. 5

inclined conveyors handling fine material, while the latter can be applied to horizontal or slightly inclined runs. The beaded types of steel slats are necessarily stiffer than the plain ones, as the beads act as re-enforcements and prevent buckling.

For light duty, narrow plain or overlapping steel slats



Figs. 6 and 7

are carried by a single strand of chain (Fig. 6). The ends of the slats thus supported may be turned up, as shown, to prevent the material from rolling off.

For heavier work and wider slats two strands of chain are required (Fig. 7). These can be located beneath the slats, thus affording a certain amount of protection to the chain and giving a smooth continuous surface to the apron. On the return run, the slats are supported by and rub on steel tracks.

The beaded slats are carried between two strands of



Figs. 8 and 9

roller chain (Fig. 8). For correct action of this type of apron it is necessary that the center of the bead radius be on a line with the center of the chain roller and that the distance between adjacent beads be equal to the pitch of the chain.

Very heavy steel apron conveyors are provided with long and wide beaded slats carried by long pitch steel roller

chain (Fig. 9). To furnish the maximum carrying capacity for loose material, retaining ends are used, but for merchandise these are not required.

For very heavy abrasive material cast steel slats with the chain links cast integral are used. This interesting construction is a comparatively recent development and is applied only for the most extreme service on conveyors and feeders handling ore, hot ingots or the like. Cast iron and malleable iron slats are occasionally used for handling ashes, coke, and like abrasive substances.

Arms

Elevator arms are used for handling barrels, boxes, bags and rolls of all kinds, either vertically or on a steep incline. The arms are carried by one or more strands of chain, preferably two strands, unless side guides are used, from which they overhang in cantilever form, and are supported from below by knee braces. They may be of solid or finger construction so designed as to be loaded by hand or to receive the loads from loading fingers or stations.

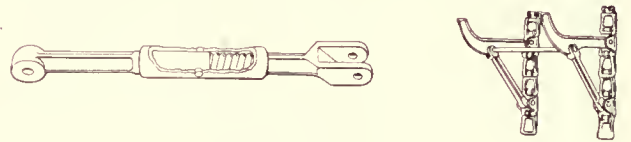

Figs. 10 and 11

The braces are bars pivoted to the chain at one end and to the arm at the other. They are usually made solid, but the spring cushioned brace (Fig. 10) can be used to relieve the sudden shock which comes upon the chain and arms when a load is picked up.

Single rigid arms (Fig. 11) will receive the load only on the upward moving side of the elevator and will discharge only over the head shaft, except that in certain special types of elevators, rigid arms may be arranged to discharge on the "up" side. In rare cases these arms have been used on semi-automatic lowering machines, in which case they are generally loaded by hand.

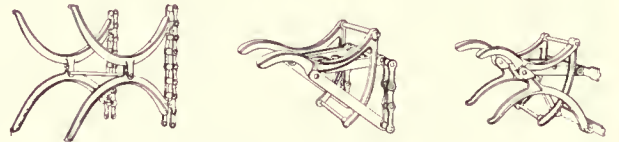

Figs. 12, 13 and 14

Double rigid arms (Fig. 12) will automatically pick up the load at any floor and discharge it at the top, and they can also be loaded by hand on the descending side of the machine and will lower the load and discharge it automatically at any floor below. Arms of this type form their own braces.

Tilting curved arms (Fig. 13) will receive and discharge only when going up. The tilting or self-dumping arms are operated by lugs which engage the ends of the arms, causing them to tilt forward and discharge the load at the desired point in the upward travel.

A combination of tilting and rigid arms (Fig. 14) will receive and discharge certain, easily loaded packages at any point when going either up or down.

Another type of combination tilting and rigid curved arms (Fig. 15) is operated by adjustable cams which tip the arms through a system of links. This design is intended to afford a particularly gentle discharge for barrels and sacks, and like the preceding type, can be

loaded and discharged at any floor. This type is generally carried by a single strand of chain, its rollers running in guides to prevent twisting.

Curved arms with teeth (Fig. 16) are intended to pre-

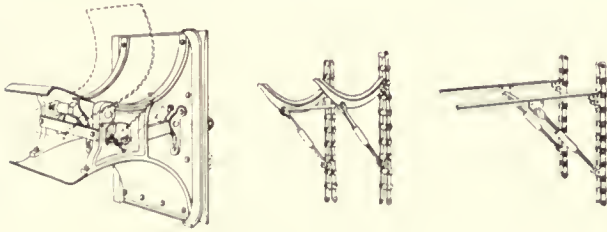

Figs. 15, 16 and 17

vent slipping of the load, but except in rare instances they are of doubtful utility, as the smooth arms are perfectly satisfactory in this respect.

Curved arms are suitable for handling bags, barrels and other substantially cylindrical packages, but straight arms (Fig. 17) should be used for boxes.

Bearing Boxes

Bearing boxes for the driving shafts of conveyors are usually designed to be attached directly to the conveyor frame. They are made in a variety of sizes and types to meet the requirements of practice. Boxes for horizontal shafting may be broadly classed as of two kinds, rigid and self-aligning. The rigid type, being simpler and cheaper, is more commonly used as it is thoroughly satisfactory if the shaft has little tendency to be thrown out of alinement by the twisting of the conveyor framework. If this tendency is pronounced, however, the self-aligning box has decided advantages in that it readily adjusts itself to any reasonable inaccuracies. This occurs particularly in portable or adjustable conveyors.

The principal considerations which affect the design of the bearing boxes are rigidity, ample lubrication, sufficient bearing surface to safely carry the load, accuracy of alinement, and the necessity of taking up wear. Boxes are invariably made of cast iron and are usually lined with babbitt or sometimes, in the case of solid boxes, they are fitted with bronze bushings.

Solid boxes (Fig. 18) are usually provided with renewable bushings which can be replaced when wear makes

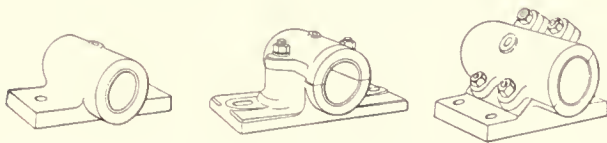

Figs. 18, 19 and 20

this necessary. They are tapped for oil or grease cups and should have the bottom surface of the pad finished true with the bore to insure accurate alinement of the shaft.

Solid boxes having flanged pads at right angles to the bore can be used when called for by structural considerations.

Rigid split boxes (Fig. 19) have the upper half of the bearing removable. This is frequently an advantage in assembling the machinery and allows for some adjustment of the bearing when worn. Split boxes are either lined with babbitt or are finished by boring and reaming. The caps should be insured against shifting either by the use

of dowel pins or by a tongue and groove joint between the box and cap. For light work the cap bolts are sometimes depended upon to hold the cap accurately in place.

Angle boxes (Fig. 20) are split with the removable half at an angle with the base. They are used when the direction of pressure on the shaft is parallel to the base, since when this condition exists the joint of the plain split box would come at the point where the pressure is greatest and would prevent proper lubrication. Structural considerations sometimes call for angle boxes in order to make the cap bolts accessible.

Self-aligning boxes (Fig. 21) automatically adjust themselves to slight inaccuracies of the shaft. They necessarily afford a less rigid bearing than the types previously shown, but are often used on take-ups where allowance must be made for horizontal variations in the alinement of the shaft.

Ball-joint boxes (Fig. 22) are similar in purpose to the self-aligning type, but have greater rigidity, as the bearing

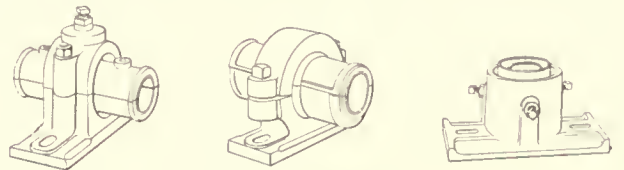

Figs. 21, 22 and 23

box itself can be adjusted to suit the alinement of the shaft and is then securely locked in place by the cap bolts.

Step bearings (Fig. 23) are used to support the lower ends of vertical shafts. Their application to conveying machinery is limited, although conditions occasionally require their use. They are made in two general styles, one a rigid box and the other having a small amount of lateral adjustment which is secured by set screws, this design being the one shown in the illustration. Bearings for the carrying rollers of belt conveyors are described under "idlers."

Belts

Conveyor belts in common use are of two principal types, fabric belts (plain, balata, vegetable or mineral oil impregnated), and rubber belts. Steel belts have been used to a limited extent in Europe but are still in the experimental stage. For handling packages fabric belts are almost universally used although rubber belts are coming more into use every year. The higher grades of fabric belt are also employed for heavy duty in handling bulk material and are giving satisfactory service under conditions which a few years ago would have been considered impossible. Rubber belts, if judged by the yearly loose material tonnage handled on them, are by far the most important conveyor belts in use. Balata is a gum somewhat similar to rubber but does not deteriorate as rapidly as the latter; it is water and acid proof and belts impregnated with it are of value for some classes of conveyor service.

The cheaper grades of woven cotton belting are applicable only to very light duty in package handling. They are not durable, are quickly affected by changes in temperature and humidity and have an excessive amount of stretch. In general, their use is warranted only for temporary installations or when initial cost is the prime consideration. Mineral oil impregnated belts stretch less than the plain cotton belt, are comparatively water-proof and will last longer. If the filler used in these belts is not of good

quality they are likely to be extremely stiff and unmanageable, and will crack badly in use. Vegetable oil impregnation gives a strong flexible belt which is excellent for package handling. All of these belts are built up from layers of fabric sewed together and impregnated under pressure with the required grade of filler. The grade of fabric used and the method of sewing are considerations fully as important as the impregnation material.

Rubber conveyor belts are built up from three to ten plies of cotton duck cemented together with thin layers of a rubber composition called "friction" and they have a vulcanized rubber covering. In addition to being frictioned, the plies of duck are often securely sewed together before the cover is applied. The strength of rubber belting is due entirely to the layers of duck, the friction merely serving to keep the layers from separating, and the cover acting as a surface protection against abrasion and the entrance of moisture. The life of the belt depends upon the tenacity of the friction to resist separation of the plies of duck and upon the resistance of the rubber cover to wear and cracking, as well as upon its adhesion to the fabric base.

The chief cause of wear on rubber belts is the impact of the material as it is delivered to the belt. This is similar to the action of a sand blast on the cover and gradually wears away the rubber surface until the duck is exposed. When this occurs the belt is practically worn out, as the duck offers very little resistance to the abrasive action of the materials.

It is therefore evident that the manner of loading the belt is of the utmost importance. The material should be delivered at as nearly the same velocity as the belt is run and in a direction as nearly parallel to the latter as is practical. A wide stream of material distributes the wear over the greater part of the belt surface, whereas a narrow one localizes it and causes a speedier destruction of the cover. Extended experiments have shown that a rubber belt offers greater resistance to the abrasive action peculiar to belt conveyors than any of the other materials commonly used, it is even superior in this respect to steel.

The number of plies of duck in a conveyor belt is determined by the required tensile strength of the finished belt and by the necessity for sufficient stiffness to prevent sagging between the carrying idlers. An empirical rule is never to stress a rubber belt above 24-lb. per ply per inch width of belt. Better results can be obtained if one-half of this figure is considered to be the maximum allowable stress.

The ordinary rubber conveyor belt has an extra thick cover on its top surface as practically all wear comes on this surface. If the belt is required to handle material on both upper and lower runs of the conveyor, the cover should be of equal thickness on both sides. The thickness of the cover ordinarily ranges from one-sixteenth to three-sixteenths of an inch. When guide rollers are used against the edges of rubber belting an extra thickness of rubber should be used over these edges, for if the cover wears through to the duck at the edge of the belt, the plies of duck will separate and the belt will go to pieces long before the carrying surface has worn out.

When material is fed to the belt in a narrow stream, a re-enforced cover which is thicker at the middle of the belt than at the edges will add to the life of the installation. A patented belt is built up of plies of duck which are stepped in such a way as to give a greater thickness of cover at the middle than at the edges, the latter having more plies of duck and hence being stiffer in the direction

of travel. This construction is claimed to give greater durability, better troughing and less sag between idlers than the ordinary types of belt. A flanged conveyor belt is a special type occasionally used on concentrators and conveyors. It is run flat, the flanged edges preventing the material from falling off. The extreme stretch of the outer edges of the flanges in going over the end pulleys, is quite injurious to the belt.

The diameter of the drums over which the belt is run has an important bearing on the life of the belt. Too small a diameter will subject the belt to serious bending stresses which tend to crack the cover and pull the plies of duck apart. The same thing applies to the angle of the troughing idlers, a high troughed belt having a shorter life than one which is only slightly troughed.

In canning and other similar industries, special light steel, woven or link belts are used in washing, cleaning and picking. These belts have had a very limited application to general conveyor work.

Boots

A boot is used at the lower end of most styles of bucket elevators. It consists of a closed hopper which receives the material and from which it is dug by the buckets as they pass around the foot of the elevator. Boots are made of cast iron, sheet steel or wood. They are

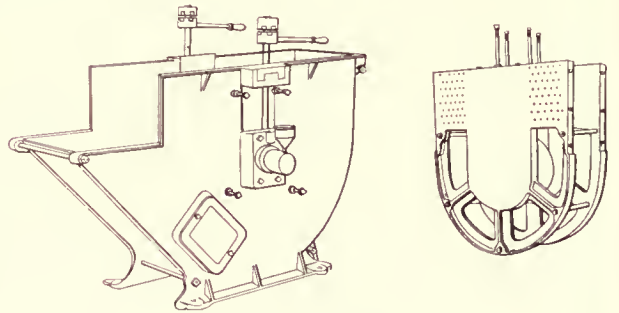

Figs. 24 and 25

fitted with bearings for supporting the foot shaft and usually have a door for cleaning out the interior, a spout for receiving the material and pads by which they can be secured to the floor.

The usual type of boot (Fig. 24) is fitted with take-up bearings protected by sliding plates or housed behind a stationary cover in such a way as to prevent the escape of dust from the boot. Two take-up boxes are required, and while these are often designed for independent adjustment, by cross-connecting the take-up screws with a chain the adjustment of both boxes can be made simultaneously and accurate alignment of the shaft will be maintained at all times.

A boot having rigid bearings for the foot shaft is used on elevators equipped with head take-ups. An elevator thus designed can be driven from the lower end, although this should be avoided if possible.

Sheet steel boots fitted with cast iron take-ups or rigid boxes and braced with structural angles are used for heavy work of all kinds.

A one-piece boot is sometimes used for heavy work in damp places and where perfect dust tightness is required. The body of this boot is made of a single casting, the feeding hopper and clean-out doors being packed with rubber gaskets at the joints and bolted in position.

Wood boots are suitable only for very light work and are less durable and dust proof than the cast iron types.

They have been used chiefly on elevators handling grain products.

When two or more elevators are run in parallel, they can sometimes be equipped with a multiple boot. This is doubtful practice, however, as it is practically impossible to keep all the chains or belts at the proper tension when all must be adjusted from one set of take-ups.

Marine leg boots (Fig. 25) differ radically from the stationary types. They are not enclosed at all, but in operation they are lowered into the hold of a vessel and are buried in the material to be elevated. The material then feeds in automatically by gravity, and as each bucket digs a path through the mass, more material flows in and is caught by the next bucket. These boots are always used on the marine legs employed for unloading grain, sand, coal and similar material, and on certain types of portable coaling machines.

Brushes

A revolving brush (Fig. 26) bearing against, or very close to, the return surface of a belt conveyor forms a useful means of removing fine particles of certain materials which might otherwise cling to the belt and be carried around under the return idlers; its use makes it possible to handle many materials which could not otherwise be carried on a belt. The brush should be run in a direction opposite to that in which the belt travels, should be located as near the head or discharge end of the conveyor as possible, and should be so arranged as to allow for adjustment when the bristles wear. Brushes are driven from the head shaft of the conveyor, and some types are

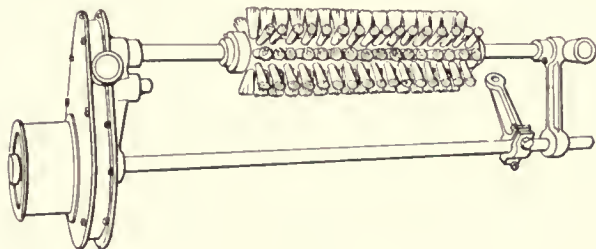

Fig. 26

automatically held in contact with the belt by weights and hence require no attention until completely worn out.

The bristles of the brush should be as stiff and durable as they can be made, but wire should not be used for this purpose, except in special cases, as it will cause serious wear of the belt. Bristles are arranged either in straight rows or spirals, there being no practical difference between the two designs so far as service is concerned.

Buckets

Elevator buckets are made in a great variety of styles in order to adapt them to handling such diversified mate-



Figs. 27, 28 and 29

rials as coal, coke, clay, gravel, cement, chemicals, pulp, etc., and to allow of their use on the different types of elevators. Malleable iron and sheet steel are the materials commonly employed in their construction.

Buckets wear chiefly along the front edge as this usually digs through the material and is subjected to much the same action as the edge of a spade. For this reason many buckets are re-enforced at the lip by an increase in the thickness of the metal for malleable iron buckets and by a renewable wearing strip for sheet steel buckets, although with most materials the wear is so slight that special re-enforcement is unnecessary.

Malleable iron buckets (Figs. 27, 28 and 29) are made with high, medium or low fronts, and known as Manufacturers' Standards, Style A, B and C respectively, the choice in application depending upon the character of the substance handled and the angle of inclination of the elevator. High-front buckets, known as Style A (Fig. 27), are used on vertical elevators and are suitable for handling the majority of dry lump materials. The medium front buckets, known as Style B (Fig. 28), are standard for inclined elevators, while the low front, Style C, buckets (Fig. 29) are used for stick materials. Only experience on the part of the designer can be a guide to the best shape of bucket to specify for handling unusual materials.

A common form of sheet steel bucket is the Salem (Fig. 30). In this the bottom and corners are rounded,

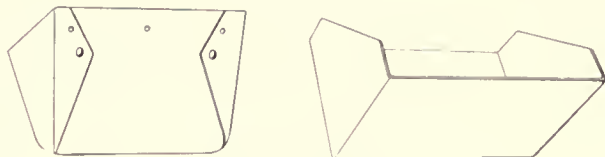

Figs. 30 and 31

the ends of the bucket being folded around the back and riveted. This is one of the most useful types made.

The gravity discharge or V bucket (Fig. 31) used on elevator-conveyors is made either of steel or malleable iron. It is always centrally hung between the chains and is rigidly attached to them or swiveled in the direction of motion of the conveyor.

For belt type bucket elevators the backs of the buckets are sometimes made concave to fit the curvature of the belt drum. As these elevators are not suitable for very heavy work, the buckets are usually made of thin steel and are re-enforced around the top with a band of heavier stock riveted to the body of the bucket. Extra wide

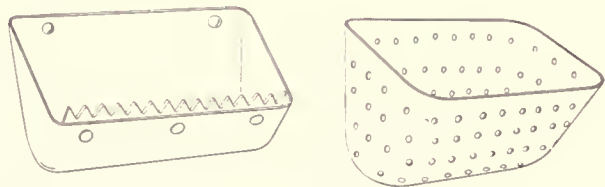

Figs. 32 and 33

buckets of this type may be further stiffened by a central strut connecting the back and front.

Steel buckets with malleable iron ends are sometimes used. They are stiffer than a plain steel bucket of equal weight and are especially applicable to centrally hung elevators. Steel buckets are made with high, medium and low fronts corresponding to the three styles of malleable iron buckets. They, however, do not resist wear and corrosion as well as the malleable iron buckets.

For viscous and sticky material a shelf or low-front bucket is occasionally required, as the more common types

sometimes have a tendency to retain the material and make for poor discharge.

The buckets are fitted with digging teeth (Fig. 32) along the lip to facilitate loading on certain types of elevators, particularly those of the portable variety. These teeth should be made separate from the body of the bucket to permit of replacement when worn.

To allow for drainage of very wet material while it is being elevated, buckets can be made of perforated metal (Fig. 33), or be built up of wire mesh with solid steel ends. These buckets are usually considered special, as they should be designed to suit the special conditions under which they are to operate.

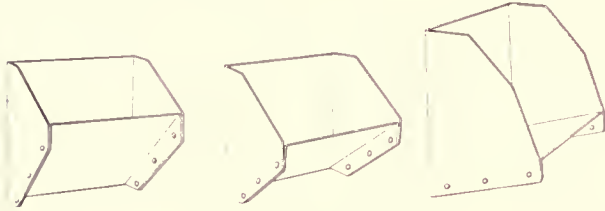

Figs. 34, 35 and 36

Continuous buckets (Figs. 34, 35 and 36) are placed close together, the flanged front of each bucket acting as a discharge chute for the material in the next. To prevent fine material from dropping through between the buckets the latter may be made overlapping. This type of bucket can be loaded directly from a chute. It can thus be arranged to avoid the wear incident to digging through a mass of abrasive material in an elevator boot. They are made with high, medium and low fronts for use at different angles, and for various conditions.

Another type of continuous bucket is carried between two strands of chain, the back of the bucket being on the pitch line of the chain. This bucket forms in effect a continuous steel belt, as adjacent buckets are in actual contact at all times, even when passing around the sprockets.

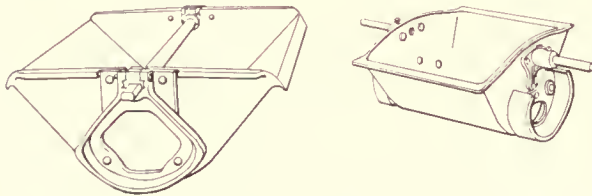

Figs. 37 and 38

Buckets for pivoted carriers (Figs. 37 and 38) are swung between two strands of chain and are fitted with a cam on the sides by means of which they are tipped and discharged. This construction is necessary as the buckets normally hang in a vertical position no matter in what direction the conveyor runs. Pivoted buckets are made of malleable iron or steel and are very largely used in boiler house installations, cement plants and coaling stations. They are undoubtedly the most highly developed and successful buckets on the market in the classes of service for which they are adapted.

Cable Conveyors

A cable conveyor consists of an endless steel cable fitted with cast iron flights which are dragged along a U or V-shaped steel lined trough and thus form a simple and inexpensive type of drag conveyor for logs, refuse, coal, etc. This device is largely used in the logging and paper

industries, and in this class of service it has been successful. It is also used as a retarding conveyer in lowering coal down hillsides from high level mines.

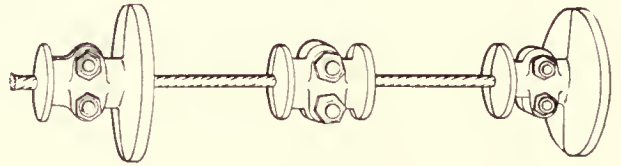
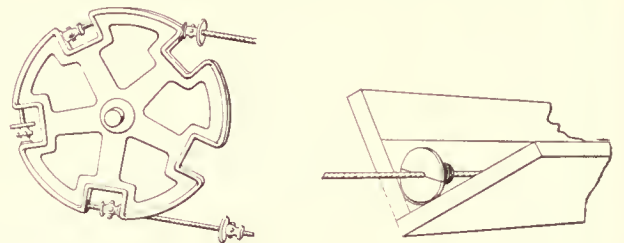

Fig. 39

Flights are circular in shape, split, and bolted over the cable (Fig. 39). When logs are handled, the flights should be spaced according to the length of the pieces carried, intermediate transmission clamps being placed between the flights to give the necessary pitch for meshing with the sprockets.

The driving sprocket (Fig. 40) has a U-shaped groove into which the cable fits, and a series of gaps or pockets pitched so as to mesh properly with the flights. Any displacement of a flight along the cable will cause it to fail to drop into the gap in the wheel, and hence special care must be taken to keep the flights and clamps tightly bolted in their proper places.

Troughs for cable conveyors (Fig. 41) are usually made of wood and are lined with sheet steel. As these con-



Figs. 40 and 41

veyors have a large application to the storage and reclaiming of material, both cable runs are usually fitted with troughs, one for taking the material to storage and the other for returning it.

Carriers

In addition to the standard types of aprons and pans used on horizontal conveyors, there are a number of special carriers which are occasionally fitted to chain type conveyors for supporting the load.

For handling rolls of material such as paper and cloth four wheel trucks (Fig. 42) are attached at intervals to a strand of chain. These trucks serve the same purpose as an apron but are cheaper than the latter and also have

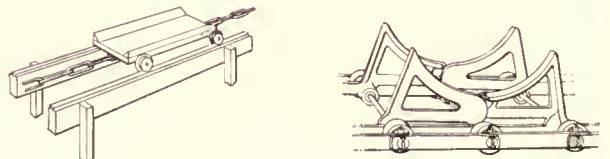

Figs. 42 and 43

the feature which is sometimes desirable of handling a limited number of rolls and delivering them at regular fixed intervals of time.

Barrels are sometimes handled crosswise on a conveyor fitted with cradles (Fig. 43). Such conveyors will operate either on an incline or horizontally.

Another type of carrier (Fig. 44) for cylindrical objects, bags, etc., is made up of concave cross bars fitted with rollers on the ends and carried either by one or two strands of chain.



Figs. 44 and 45

For metal ingots, pig, and similar material a single angle bracket (Fig. 45) carried by two strands of chain will form a useful carrier for elevating vertically and conveying horizontally or on an incline. Combination elevator-conveyors are sometimes equipped with this carrier.

Chains

Conveyor chain has reached a high degree of standardization, due very largely to the efforts of the pioneer concerns manufacturing it. Although in many cases the various makers have developed differences in detail design, they have for the most part maintained the same essential dimensions, so that a given type and size of chain made by one manufacturer will in general be interchangeable with that made by any other. This statement applies to the pitch, width and strength of the chain, but does not of course imply that repair links of one make can be used in connection with another make of chain.

It is not possible to give accurate figures applicable to all conditions for the working strength of conveyor chains. The speed at which the chain is run, the character of the service (whether intermittent or constant, etc.) and the kind of material handled, all exercise an influence on the allowable working strength. The faster the chain runs the greater will be the shock due to engagement of the sprocket teeth with the links, and the oftener these shocks will occur. It is therefore necessary to decrease the chain load to compensate for increased speed. If the chain is subjected to sudden shocks, as for example in picking up heavy loads, a larger factor of safety is required than if the service were constant. Very gritty bulk material that is likely to find its way into the chain joints and cause undue wear also calls for a lower working stress than could be allowed if the material handled were not of such an injurious nature. Likewise, chain used in chemical plants is often affected seriously by chemical action on the working parts.

For maximum durability and reliability of the ordinary types of conveyor chain, it has been found by experiment that the factor of safety to be used in determining the working load should be varied according to the chain speed as follows.

Chain Speed	Working Strength
200 ft. per min.....	Divide ultimate strength by 6
300 ft. per min.....	Divide ultimate strength by 8
400 ft. per min.....	Divide ultimate strength by 10
500 ft. per min.....	Divide ultimate strength by 12
600 ft. per min.....	Divide ultimate strength by 16
700 ft. per min.....	Divide ultimate strength by 20

These figures assume that the load is steady and that the material is not injurious to the chain. For resistance to shock the working loads should be one-half of those indicated above, and for particularly severe conditions of service even greater allowances should be used.

The motion of conveyor chain running on sprockets is never absolutely uniform. The pitch line of the sprocket is really a polygon, so that the chain necessarily moves forward with a jerking or pulsating motion. The shorter

the pitch the less noticeable will be the jerk, while the greater the number of teeth in the sprocket the more nearly will the polygonal shape of the latter approach a circle and the smoother the action of the chain will be when running. For comparatively short pitch chains this non-uniform motion is rarely pronounced enough to be objectionable, but with the long pitch used for extra heavy bucket conveyors and the like, it may become serious.

The bending or articulation of chain links in passing around the sprockets is the chief cause of wear on both the chain and wheel. This bending can take place in either of two ways, one causing internal wear on the joints of the chain without any rubbing between the chain and sprocket, and the second causing wear both internally and externally on the link by a combination of rubbing between the sprocket and link and a simultaneous turning at the joint between the links.

Every correctly designed chain installation should be so arranged that as far as possible all rubbing will be confined to the chain joints and as little friction occur between the sprocket and chain as the layout of the installation will permit. Special attention should be given to having the joints between the links as sturdy and durable as possible. Plenty of bearing surface should be provided, and on the higher grade pin type chains hardened steel pins and bushings should be used.

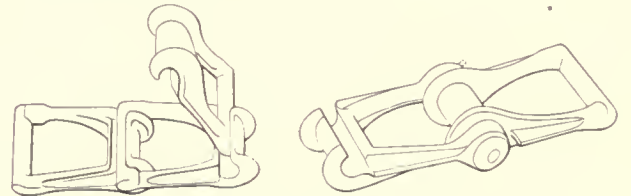

Figs. 46 and 47

Detachable chain (Fig. 46) is very widely used for conveyor and elevator work. It is the simplest and cheapest chain known, and gives excellent service under proper conditions. It is not so well suited to use where abrasive or gritty material is to be handled as some other chains particularly designed for such service. Ordinary detachable chain is made of malleable iron, but if exceptional toughness and resistance to wear are necessary it can be obtained by the use of manganese steel.

If it is necessary to connect this chain around sprockets without slack, there are special coupler links (Fig. 47) made with removable pins which can be used, and it will then be a simple matter to remove or replace the chain by means of the coupling pin connecting these links.

A type of chain similar in principle to the detachable is made of sheet steel and is known as the lock chain. It is used principally on agricultural machinery, but has had some application to light conveyors.

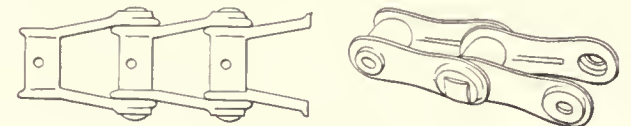

Figs. 48 and 49

Pintle chain (Fig. 48) is made of malleable iron links connected by steel pins. The pins should be prevented from turning in the links and may be riveted over or be held by cotter pins or nuts. This chain is used in place of the detachable when greater strength is required or when gritty conditions preclude the use of the open hook

joint. It is made in sizes to correspond with detachable chain, so that both types are interchangeable on the same sprockets. Pintle chain can be run with either side against the sprockets, and if one side becomes worn, the chain can be reversed and its useful life considerably increased by running it with the other side against the sprockets.

Interlocking pintle chain (Fig. 49) has a comparatively dirt proof joint between the links, as each link telescopes into the adjacent one and protects the pin against the entrance of grit. The pin is riveted in place, or if it is necessary readily to detach the links, it is fastened by a square nut. Both forms are in common use on elevators and conveyors as well as on low speed power transmission equipment.

Saw mill pintle chain is similar to the plain pintle type except that the sides of the links have protruding ribs which give the necessary additional wearing surface to allow for the chain being dragged over floors or in runways.

Malleable iron refuse chain (Fig. 50) is a wide pintle chain having extra webs to allow for sliding easily in troughs, and is used for conveying saw mill refuse, ashes, etc., being in effect a drag chain as the material is dragged along by the wide crossbars of the links. Special attachment links are sometimes used to increase the width and depth of the dragging area.

The Ley bushed chain (Fig. 51) is the most highly developed, durable and accurate malleable iron chain in use. It is more expensive than the simpler conveyor

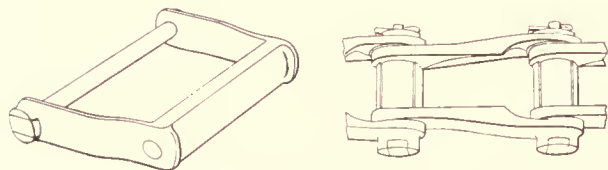

Figs. 50 and 51

chains, but will outwear them and retain its pitch longer. When worn it can be readily put into first class condition by replacing the steel bushings and pins, as all wear, both external and internal, is taken by these parts. The principal feature of this chain, the partly exposed hardened steel bushing which bears against the sprocket teeth, effectively prevents wear on the chain link itself, and at the same time affords a bearing for the connecting pin. The bushing is prevented from turning in the link by a tongue which fits into a groove cut in the bushing, and the pin has a flat head which is held between lugs on the outside of the link. The small end of the pin is also flattened and fits into a rectangular broached hole in the opposite side of the link. This construction gives an extremely rigid support for both the bushing and pin, eliminating the tendency for them to work loose and start wear on the link. Ley bushed chain is often used for power transmission at moderate speeds, but it also has a large application to conveying and elevating gritty material and for heavy duty under severe conditions.

A somewhat stronger type of Ley bushed chain has more metal in the link, the heads being re-enforced with a center web which stiffens the link and reduces the chances of hidden flaws in the casting.

The malleable iron roller chains (Fig. 52) form an important class of strong yet comparatively inexpensive conveyor chains. Their use is not restricted to any one type of equipment, but they are employed on double-strand flight and apron conveyors, bucket elevators and

carriers and wherever the chain is run in a track and is called upon to support the weight of the load as well as to transmit the pull of the driving mechanism. It is sometimes advisable to bush the rollers with steel or bronze

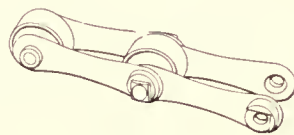

Fig. 52

sleeves, and for certain classes of service under acid conditions, both the bushing and pin are made of acid resisting bronze.

Transfer chain (Figs. 53 and 54) has a limited field of application in handling boxes, lumber, sheet iron and similar material. The load is carried on parallel strands of chain running in channel tracks and rests directly on the broad flat tops of the links. This forms a very cheap and simple horizontal conveyor which can be loaded and



Figs. 53 and 54

unloaded by hand from the sides. Two general types of this chain are in use, one having separate pins to connect the links, and the other being so designed that the pin forms an integral part of the link. The former type can be coupled in place without slack, but the latter requires some looseness in the chain to allow the links to be hooked together.

Combination chain (Fig. 55) is made up of alternate malleable iron or cast steel links and steel side bars. It is a strong and comparatively inexpensive type of chain for use on heavy elevators and conveyors. The steel pins used to connect the links are designed to be held from turning in the side bars, all of the motion occurring between

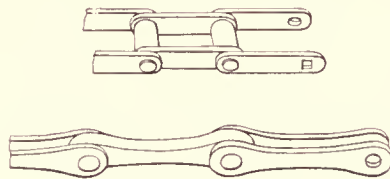

Figs. 55 and 56

the pin and the malleable iron link. Sometimes the hole in the malleable iron link is bushed with bronze and a hardened steel pin is used. This construction is an improvement over the unbushed link as it makes a more durable chain and one which can be readily repaired.

A variation of the combination chain has rollers outside the links. This type is occasionally used for slow moving single and double strand pusher conveyors and is particularly applicable to the progressive assembling of automobiles.

Steel strap chains are used for slow moving and intermittent heavy duty in handling ice on large apron and flight conveyors, and in general wherever excessive service requirements or very long pitches preclude the application of malleable iron types. While having great tensile strength, these chains have not the wearing qualities of

some other varieties, as the pins are apt to wear rapidly unless hardened and prevented from turning, and fitted with hardened bushings.

Plain steel strap chains (Fig. 56) are cheap and simple in construction. They are used particularly in handling ice. The pins are usually riveted over the outer bars and are rarely hardened as the rough service under which they operate does not require this refinement. A similar chain with plain drop forged links is made in a variety of forms for ice handling, long flight conveyors, car hauls, elevators and the like. This chain is particularly adapted to handling heavy intermittent loads at low speeds, and for its weight is one of the strongest types of pin chain obtainable.



Figs. 57 and 58

Roller steel strap chains (Figs. 57 and 58) are particularly useful in combination with long apron conveyors and pivoted carriers. The rollers themselves may be made of steel or, in the cases of flanged rollers, of cast or malleable iron. Hardened bushings are sometimes used to hold the side bars rigidly in line and to afford a durable bearing on which the rollers can revolve. Adjacent links are connected with steel pins either riveted in place or held by cotter pins.

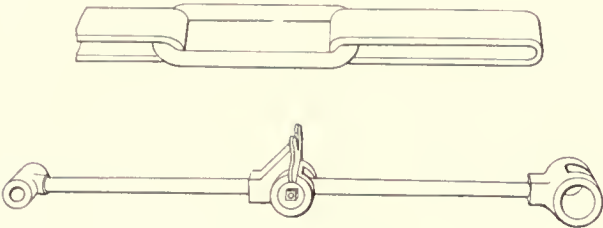

Figs. 59 and 60

Alternate flat and round steel links (Fig. 59) give a form of welded chain which is superior in some respects to plain coil chain which has only a limited use in conveyor service as it has larger wearing surfaces and hence greater durability. Attachments are available in greater variety for this than for coil chain, the flat links affording a more convenient means for supporting attachments and the shape of the chain having a tendency to prevent their twisting out of alignment.

Steel bolts connected by malleable iron knuckle joints (Fig. 60) form a very strong and durable long pitch chain. Its application is necessarily limited, but for certain types of flight conveyors and special carriers it is one of the most satisfactory heavy duty chains in use. There being few joints, no welds and large bearing surfaces, the strength of this chain is greater in comparison to its weight than any other type, while its first cost and upkeep compare favorably with the other high duty chains. Its use is confined almost entirely to long single strand conveyors.

Steel drag chain is used only for drag conveyors handling loose material, such as refuse, sawdust, coal, ashes and crushed stone. The simplest type is made of plain rectangular steel bars, bent up and together. It is not suitable for heavy duty, but successfully handles sawdust, shavings and other light material over comparatively short distances. (See Fig. 61).

Another form of this chain is reinforced with extra steel clips at the riveted joints and will stand up under moderately severe work in handling coal and the like.

The strongest drag chain (Fig. 62) is constructed so as to have almost twice the strength of the ordinary forms. It is used for handling such materials as stone and gravel.

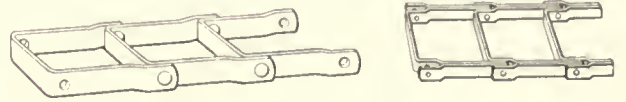

Figs. 61 and 62

The effective width of drag chain is often increased by extensions of various shapes riveted to the sides of the links.

Chain Attachments

A great many kinds of attachment links are available for use in combination with the standard types of conveyor chain. These links are designed to carry the various slats, flights, buckets, arms, etc., which form a part of nearly all chain conveyors. A few examples of the more common attachments will give an indication of what experience has shown to be useful, but the following examples are only suggestive of the hundreds of varieties in common use.

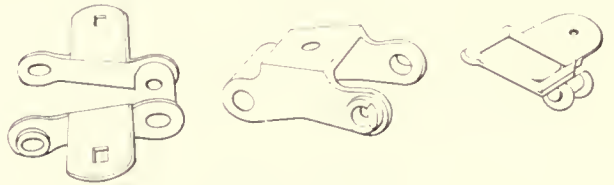

Figs. 63, 64 and 65

For attaching buckets and slats the chain links are provided with pads of various forms (Figs. 63, 64 and 65) through which the fastening bolts or rivets are inserted.

Single strand flight conveyors require attachments adapted to fastening the flight at right angles to the back of the chain (Figs 66 and 67). Double-strand flight and push-bar conveyors are often equipped with swivel attach-



Figs. 66, 67 and 68

ments (Fig. 68) to prevent cramping of the chains when one wears more than the other.

For certain purposes where a small flight is needed it can be cast integral with the chain link (Fig. 69), thus forming a "scraper attachment." In a similar manner



Figs. 69, 70 and 71

attachment links embodying small slats (Fig. 70) are occasionally used for light work. Lugs projecting from the links (Fig. 71) are required for the various types of haulage conveyors and many styles of attachment links are available for this purpose.

Pivot links (Fig. 72) are used on rigid arm elevators to carry the arms and braces. For some types of slat conveyors attachment links are fitted with rollers (Fig. 73) of large diameter, these special links being used at inter-

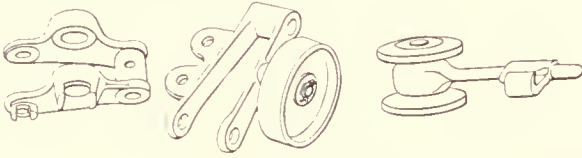

Figs. 72, 73 and 74

vals in the chain to guide and support the apron. For overhead haulage conveyors when the chain is run in a horizontal plane, rollers are placed in the plane of the link (Fig. 74) to allow the latter to be supported on tracks between the sprockets.

Drives

Elevator and conveyor driving mechanisms are made up of various combinations of belts, chains, and worm, spur, bevel and friction gears, the exact arrangement used depending upon the type of conveyor, the speed at which it is run, the power required to operate it and the speed and location of the motor or line shaft from which power is taken.

The general types of drives are as follows: 1. Spur gears (single or multiple reduction). 2. Bevel gears. 3. Belt (single or multiple reduction). 4. Chain (single or multiple reduction). 5. Worm gears. 6. Planetary or internal gear reducers. 7. Friction gears. 8. Combinations of two or more of the above.

Spur gear drives are applicable to practically every type of elevator or conveyor, and are used more often than any other form of drive. The efficiency of these gears is high, they are easy to construct and install, and will give satisfactory service under the most severe conditions. The gears are usually made of cast iron with machine molded or cut teeth, the latter being invariably used on high class

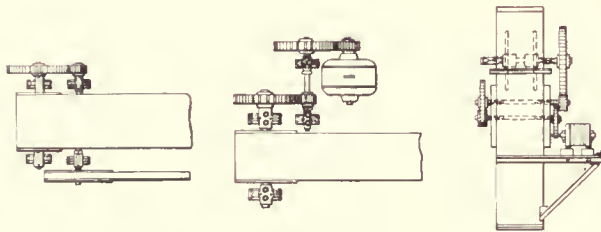

Figs. 75, 76 and 77

construction. Motor pinions, due to their high speed, are frequently made of fibre to reduce the noise of operation.

The single reduction spur gear drive (Fig. 75) is the cheapest and simplest to build. It is used for low reductions especially when the conveyor is operated from a line shaft.

The double reduction gear drive (Fig. 76) has a large field of application to belt and chain type elevators and conveyors. It can be designed to give a reasonably high reduction and is usually required when the motor is direct connected to the conveyor without a belt.

Triple gear reductions (Fig. 77) are used only for very heavy slow moving conveyors and elevators. The characteristics of this type of drive are great strength and high reduction of speed.

To compensate for the pulsating motion of long pitch chains, the driving gear is sometimes made with a wave

pitch line (Fig. 78) and is meshed with an eccentric pinion. This gives a compensating drive that counteracts the variations which would occur in the speed of the chain if circular gears were used. The number of depressions in the gear must equal the number of teeth in the chain sprocket, and the location of these depressions in relation to the teeth of the sprocket must be such that the speed of the latter is reduced at those joints where the chain would naturally accelerate its motion under the influence of a constant speed drive. This device is not common, but is a valuable feature on long pitch pivoted carriers, apron conveyors and the like.

The arrangement of ordinary spur gear drives for belt conveyors is slightly modified when a tandem drive (Fig. 79) is required. This drive is made up of two driven drums geared together so as to run at the same surface speeds, the belt passing around first one drum and then

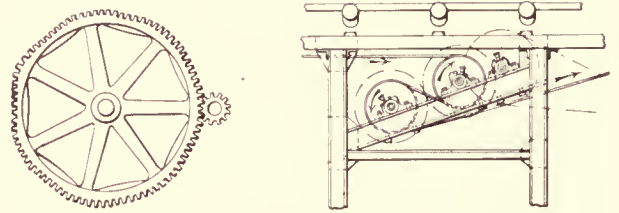

Figs. 78 and 79

the other, giving a very powerful drive for long heavy conveyors.

Bevel gear drives are used on live roller conveyors, carousels, and when a right angle drive is required, as for example when the line shaft from which power is taken is located parallel to the conveyor.

Belt and chain drives for conveying machinery are usually used in combination with one of the gear type reductions. The amount of reduction obtainable with a single belt or chain is not great, but on some portable machines multiple belt and chain drives are used because of their lightness and flexibility.

The worm gear drive (Figs. 80 and 81) is one of the simplest and most satisfactory high reduction drives that can be used for conveyor and elevator work. It is a very efficient device when correctly designed and accurately constructed, but unless the worm and gear are properly proportioned for the work to be done, are rigidly supported—preferably in a dust proof housing—and generously lubricated, trouble will result.

The speed reductions practicably obtainable with a single worm drive vary from about 6 to 1 up to 100 to 1, although it is not usual in conveyor work to go to either of these extremes. For low reductions, say up to 15 to 1,

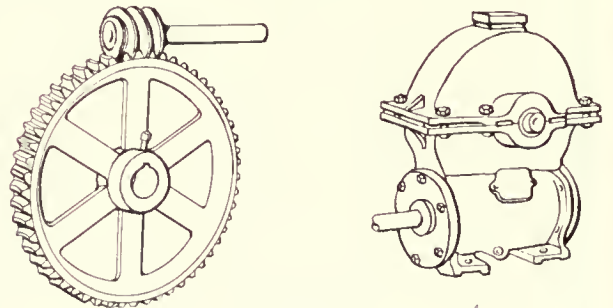

Figs. 80 and 81

spur gears are in general use, while for excessively high reductions, the planetary gear reducer or a combination

of worm and spur gears will usually give better results than a single worm drive.

The worm is generally made of steel and the wheel of either cast iron or phosphor bronze. The teeth must be kept thoroughly lubricated, preferably by running the gears in an oil bath. This calls for an oil tight housing, and also makes it advisable to place the worm below the wheel when possible. Thrust bearings should always be provided for both worm and wheel to take care of the end thrust developed.

The planetary or internal gear reducer (Fig. 82) works

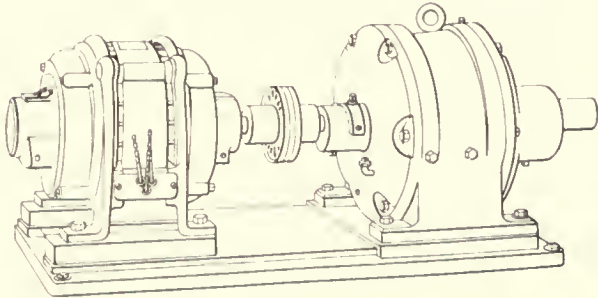

Fig. 82

on the well-known principle of a stationary internal gear meshing, with idler pinions carried by a revolving spider or ring, the pinions in turn engaging a gear carried by the driving shaft concentrically with the internal gear. By compounding two or more of these mechanisms, very large reductions in speed can be obtained. The gearing should be enclosed in an oil-tight housing, the shaft of the reducer being direct connected to the motor shaft by a flexible coupling. Planetary gear reducers are accurately constructed, built of high grade material, and are probably the most efficient, noiseless, and satisfactory drives that can be used on conveying machinery. They take up a minimum of space and are adaptable to almost any conditions of speed and load. Their use in elevator and conveyor drives is fast increasing.

Reducers are sometimes used in combination with worm

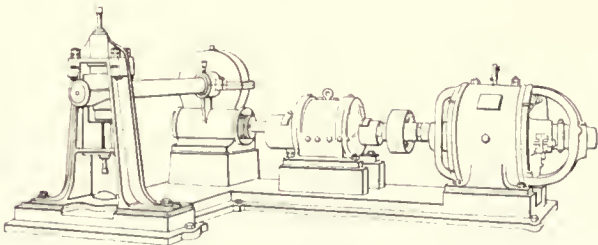

Fig. 83

gears to obtain very high reductions of speed, the arrangement illustrated (Fig. 83) being designed for a reduction of 850 to 1.

Friction gearing is made in both the spur (Fig. 84) and bevel (Fig. 85) types. The driving pinion is usually made of fibre or straw board, and the driven wheel of cast iron, as this combination has a high coefficient of friction and has proved itself fairly satisfactory and durable in service. The driven wheel should never be made of fibre, for if an excessive load causes the gears to slip, the driver revolves under pressure against the stationary driven wheel, and if the latter were made of a soft material, flat spots would be rapidly worn on its face.

Friction gearing has a very limited field of application to conveyor work, as it is not as efficient, reliable or durable as tooth gearing. Although cheaper in first cost,

up-keep and renewals will in the long run make it poor economy to use this type of drive unless the feature of slipping when overloaded is essential to prevent damage

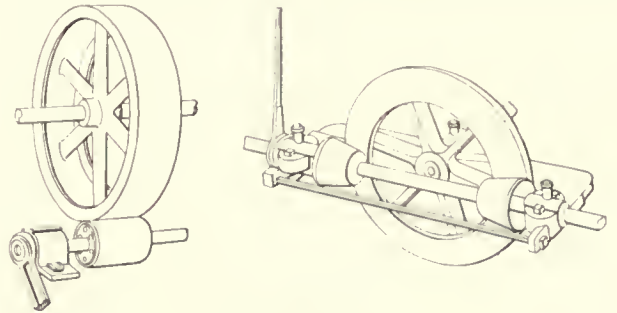

Figs. 84 and 85

to the conveyor, or if it is necessary to frequently start and stop the conveyor without stopping the motor or line shaft from which it is run.

Flights

Conveyor flights of wood are used only for the lighter classes of work. They are usually carried by a single strand of chain and are run in wooden troughs. Fig. 86 shows a flight of this kind suspended below the chain,

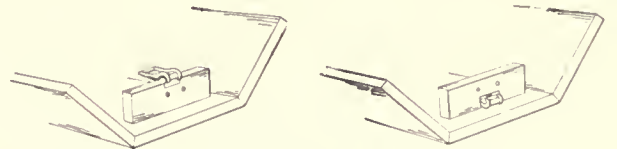

Figs. 86 and 87

while Fig. 87 shows the chain running along the bottom of the trough, the flight being carried above it. The suspended flight has the advantage that its carrying chain is not surrounded by the material being conveyed and is therefore subject to less rapid deterioration than if the chain were covered by the material. The suspended type is, however, applicable only to lower run conveyors, the supported type being required when the material is handled in the upper run.

Steel flights are used for all kinds of service from the lightest to the heaviest. The shape of the flight and the weight of the stock from which it is made depends upon the character of the material handled and the required capacity of the conveyor. Straight flights are common, but the curved types are also used. For extra heavy work malleable iron flights, having greater durability than sheet steel, are often employed.

Single strand suspended flights (Fig. 88) for moderate and heavy duty are fitted with malleable iron wearing shoes which run on tracks along the sides of the con-

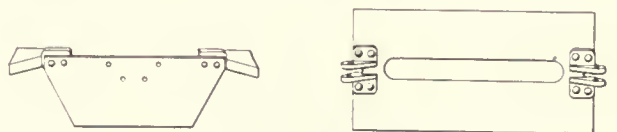

Figs. 88 and 89

veyor trough and serve to support the flight. Instead of shoes, rollers are frequently placed on the sides of the flight to act as supporting and guiding members. These rollers are carried by a steel axle to which the flight is riveted.

Flights for double strand conveyors are sometimes re-

enforced by a steel axle connecting the two chains, or the centrally hung flight (Fig. 89) can be stiffened by an embossed ridge as illustrated, but in many cases the flight itself will be amply stiff to resist buckling without extra reinforcement. These flights may be rigidly attached to the chains, or a hinged joint may be used to allow for unequal stretch of the chains without resultant bending of the flight.

Gravity Roller Conveyor

Wood supports for roller gravity conveyor (Fig. 90) are sometimes used on account of their relatively low cost as compared to steel. A straight grained hard wood should be used in their construction and for outdoor use the wood should be impregnated with a creosote preservative. Legs may be of the straight or of the horse type and

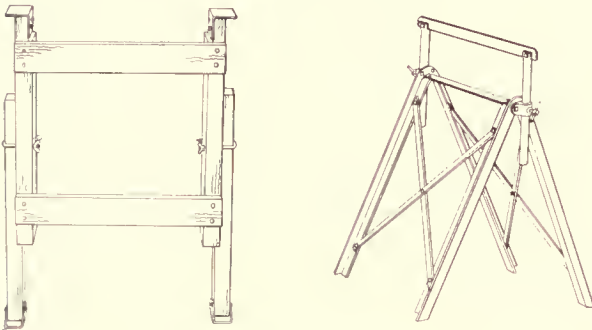

Figs. 90 and 91

either with or without adjustment for height. Common wood horse supports having no adjustment are frequently used although their lack of adjustment is a disadvantage.

Steel supports are made either portable or stationary. The portable supports (Fig. 91) for outdoor use are of the horse type having the height adjustable and the frame as light as is consistent with strength and rigidity. The conveyor sections are simply laid on the top cross bars of these supports.

Stationary indoor supports (Fig. 92) consist of adjustable angle or pipe legs bolted to the conveyor and lagged fast to the floor.

Indoor portable supports (Fig. 93) are usually made in the form of adjustable legs which are bolted to the con-

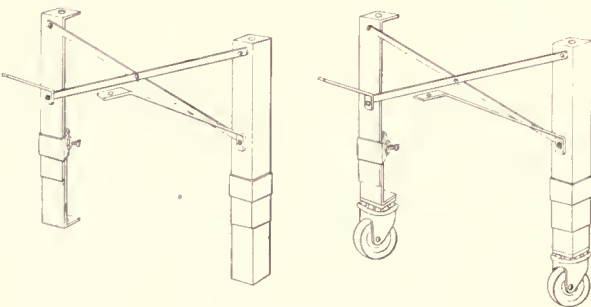

Figs. 92 and 93

veyor sections and fitted with castors. Castors may, however, be omitted on the lighter sections.

For suspending the conveyor from above hanger rods are used. These are threaded on the lower ends and fitted with nuts to true up the line of the conveyor.

The earliest types of bearings for roller gravity conveyor were simple steel shafts turning in holes punched in the side frames (Fig. 94). The large amount of friction and rapid wear attendant upon this construction has caused

it to be discarded in favor of the anti-friction bearings at present almost universally employed.

A modification of the plain bearing (Fig. 95) has case hardened threaded bushings in which the roller shaft



Figs. 94 and 95

turns. This construction allows of the roller being removed from the frame by unscrewing the threaded bushing, and also permits of renewals being made when the bearings become worn. These plain bearings are used only in connection with wood rollers on conveyors intended for light service.

The ring type stud bearing (Fig. 96) is occasionally used on milk and dairy plant conveyors. It is an improvement over the plain shaft bearing but inferior in operating characteristics to the ball bearing types as the frictional resistance is considerable, necessitating a greater pitch to the conveyor in order to handle a given commodity.

The ball bearing stud (Fig. 97) is one of the most satisfactory types of construction, as with it friction is reduced to a minimum, cramping of the bearing due to possible springing of the side frames is eliminated, and weight is kept down. This last is important if the conveyor is to be portable. Stud bearings are used with wood, steel or cast iron rollers. In all cases the ends of the rollers are completely closed, an essential feature if

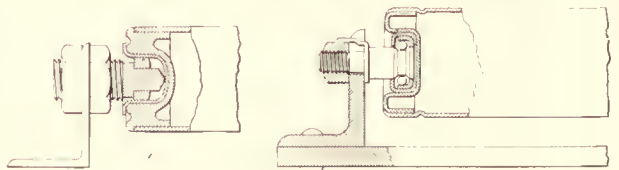

Figs. 96 and 97

liquids of any kind are likely to come in contact with the conveyor. This bearing is therefore standard construction for milk and dairy plants, chemical works, and under all conditions where water can get into the bearings, as in outdoor installations and for handling wet objects.

The through shaft construction with ball bearings (Figs. 98 and 99) gives a thoroughly satisfactory conveyor for boxes, barrels, castings and the like. Being somewhat heavier than the stud type, particularly with the longer and more closely spaced rollers, it is especially adapted to permanent installations. When used under very wet conditions, the liquid often finds access to the interior of the roller and causes trouble from corrosion and the formation of puddles. This type of construction requires that the conveyor have sufficient clearance on one side for the removal of the shaft endwise to allow the roller to be taken out of the frame. This requirement is, however, easily met in the majority of installations.

Rollers are made of straight grained hard wood, steel tubing (preferably seamless) or of cast iron. Standard straight rollers range from 2 in. to 3 in. in diameter, with $2\frac{1}{2}$ in. as the ordinarily accepted standard.

Wood rollers are suitable for many purposes where the service is not heavy, where a light conveyor is required, or when first cost is of prime importance. They are not as durable as steel but when operating conditions call for

their use it has frequently been found desirable to employ them with the full knowledge that replacements will be required after a certain limited period of service. Sometimes steel ferrules or collars are forced over the ends of wood rollers, increasing somewhat the strength of the roller to resist splitting at the bearings and making a more durable surface for carrying the load.

Steel rollers are usually made of seamless tubing having ends of drawn steel or cast iron forced in and held by crimping or spot welding. It is very necessary that these ends be accurately made so that the rollers will revolve about their true centers and be in perfect balance. The usual thickness of the tubing ranges from No. 16 gage

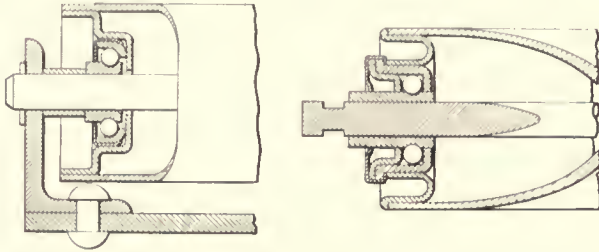

Figs. 98 and 99

to No. 12 gage or heavier, but it is desirable to keep the revolving parts as light in weight as is consistent with strength, stiffness and durability.

Cast iron rollers are not common for general package conveying, but the concave cast iron roller is widely used when cylindrical objects are to be handled. It is cored hollow to decrease weight, and its concave carrying surface forms a cradle for handling such material as pig iron, shells, rolls, logs and the like.

Special small rollers are sometimes used for conveyors handling small objects. They are made in diameters from $\frac{3}{4}$ in. to 2 in. in diameter and are spaced as close together as possible. Similarly, for special purposes, rollers larger than 3 in. diameter have been successfully used.

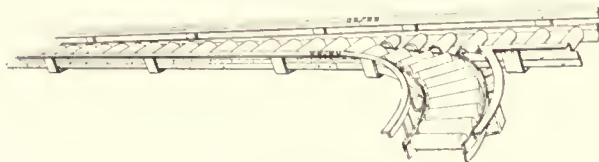

Fig. 100

When two or more lines of gravity conveyor are required to deliver to one main trunk line a converging section (Fig. 100) is used. This is frequently a necessary feature of gravity conveying systems, but there is sometimes danger of the packages jamming at this point if two of them reach the "frog" at the same time.

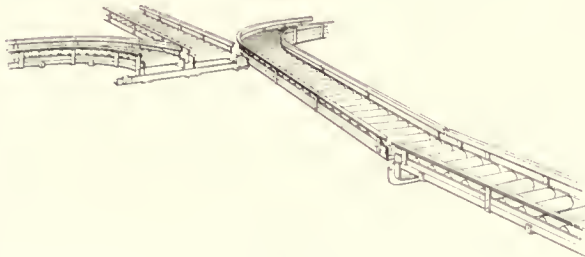

Fig. 101

A gravity switch section (Fig. 101) allows packages to be delivered selectively from a single trunk line to two or

more branch lines. The switch section, being pivoted at one end, can be swung in the horizontal plane to connect



Fig. 102

with any of the branch lines as required. This is a very common and thoroughly satisfactory device.

For turning corners curved-sections are used. They are made to turn through any required angle, $22\frac{1}{2}$ degrees, 45 degrees and 90 degrees being the most common. The radius to the outside of the curve may be made to suit the specific requirements of the layout, from 2 feet 6 inches to 4 feet 6 inches being usual.

Curves fitted with straight rollers are satisfactory for many purposes, particularly where comparatively heavy material is handled. Straight roller curves should usually be fitted with guards on the outside to insure the packages from running off.

Tapered rollers (Fig. 102) give the best results on curves. The amount of taper depends, of course, upon the radius of the curve, being greater for a short radius than for a long one.

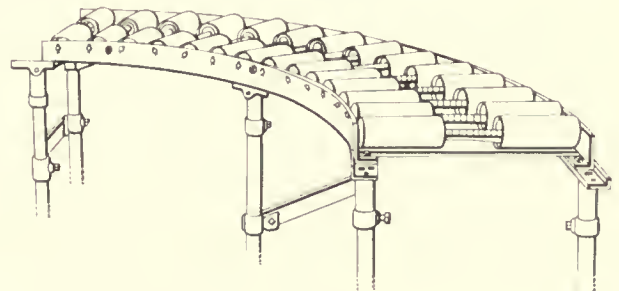

Fig. 103

Double or differential roller curves (Fig. 103), in which the outer rollers move faster than the inner, are much used. They operate in a somewhat more satisfactory man-

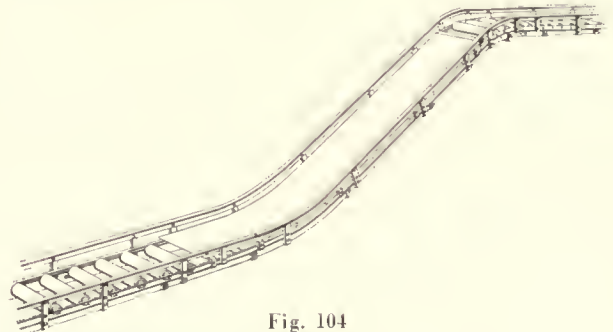

Fig. 104

ner than the straight rollers but do not have the perfect action of properly designed tapered rollers.

Straight steel slides (Fig. 104) are often of value in connection with stationary installations of gravity conveyor. They are used to lower material from an overhead line of conveyor down to the floor or to a table, and sometimes from one floor to another, although for this

latter purpose spiral chutes are usually better. The line of gravity entering the straight chute should be given a slight downward curve, and a reverse curve should be made in the bottom of the steel slide in order to prevent the packages from "digging in" between the rollers as they leave the slide. The slope of the chute depends upon its length and the character of the material to be handled.

By hinging and counterweighting certain sections of a gravity conveyor, aisles can be maintained for trucking, etc. When it is desired to use the passway, the hinged section of the conveyor can be raised, stopping temporarily the flow of packages but allowing a clear passage through the line of the conveyor.

Idlers

Supporting idlers are used under both top and bottom runs of nearly all belt conveyors. Occasionally on very light package conveyors the belt is run in a shallow wood trough, but except for the lightest service this is not good practice as the constant dragging of the belt against the bottom of the trough causes excessive wear on the fabric. The idlers supporting the carrying surface of the belt are spaced close enough together to prevent undue sag when the conveyor is loaded to its capacity. The type of conveyor, the material handled, and the size of the belt must all be considered when determining this spacing. The idlers under the return side are usually spaced at comparatively long intervals since their purpose is merely to support the empty belt and some sag of the latter is not objectionable. Idlers should be wider than the belt which they carry and should turn freely in their bearings. Package conveyor belts are run flat, but the majority of installations handling loose material are equipped with troughing idlers which cause the belt to form a trough from which the material is less likely to spill than from the surface of a flat belt.

Straight idlers for package service may be made of plain hard wood rollers fitted with steel pins which turn in holes drilled in strap iron hangers but this is not good practice. A better bearing is an oilless wood bushing supported from the conveyor framework by a cast iron box. Recently ball bearing idlers have been developed but due

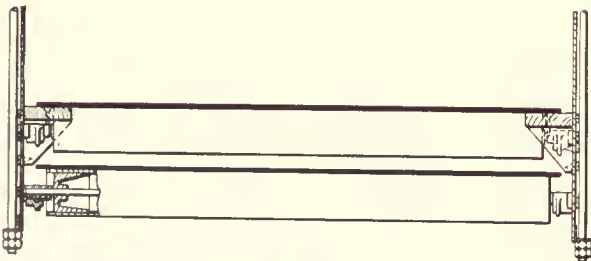

Fig. 105

to their cost they have not as yet been used to any great extent. Babbitted bearings are commonly used and are satisfactory.

Straight idlers for package conveyors are also made of steel tubing with cast iron or pressed steel heads and a through shaft. Self-aligning bearings are desirable as they prevent cramping of the roller. For light duty in department store work the bearings are carried directly on the sheet steel sides of the conveyor run (Fig. 105), these sides serving also as guards to prevent the packages falling off the belt. This type of conveyor is usually hung from the ceiling by rods, vertical adjustment of the con-

veyor as a whole being secured by nuts on the lower ends of the rods.

For heavier service the framework supporting the bearings is a structural steel member (Fig. 106), and, if necessary, special wood or steel guards are used to retain the packages.

A single concave idler (Fig. 107) is sometimes used to



Fig. 106

trough the belt and prevent spilling of the material carried. If this construction is employed, the amount of troughing should be very slight as otherwise the difference in velocity of the high and low points on the idler will be sufficient to cause serious wear on the belt due to slip.

The two roll idler (Fig. 108) allows of deeper trough-

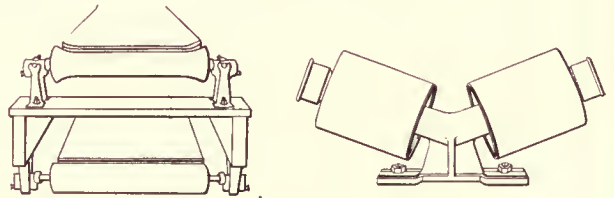

Figs. 107 and 108

ing without injurious belt slip. It is, however, less suitable for heavy work than the three and five roll types, as the belt is not supported at the center where the load is greatest. The belt consequently tends to sag into the space



Figs. 109 and 110

between the rolls and the latter act somewhat as a rotary shear, tending to cut the belt in two.

Three and five roll idlers (Figs. 109 and 110) having the rolls set approximately on an arc of a circle give a very perfect support for the belt and obviate slip. This is the most commonly used construction for equipment handling loose material.

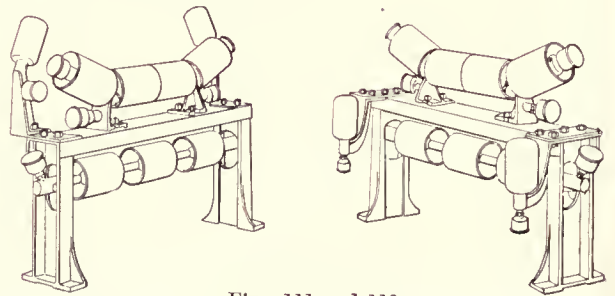

Figs. 111 and 112

Guide rolls are sometimes required to prevent the belt from running out of line as it passes over the idlers. These guide rolls are usually used on the carrying side of the belt (Fig. 111), but are occasionally fitted to the return run (Fig. 112) as well.

The majority of troughing idlers used in the past have been made of cast iron. A comparatively recent development is the steel idler fitted with ball bearings and designed on the unit principle. In this design each roll is carried by a sheet steel bracket. These units can be combined into straight or troughing idlers of any required size, the amount of troughing can be regulated, and a light weight but very strong conveyor is the result of their use.

A few concave wood idlers have been used, mainly on temporary installations.

Pulleys

Belt conveyor pulleys are generally made of cast iron, steel, or wood, the belt being run directly on the bare face of the pulley. Pulleys of this type are made either solid (Fig. 113) or split (Fig. 114) and clamped over the shaft with bolts. In the case of long conveyors it is necessary to have a high tractive force without undue tension on the belt, and for this reason plain cast iron or steel driving pulleys are rarely used for heavy duty, as the coefficient of friction is comparatively low.

Rubber or canvas covered head pulleys are very frequently used for long conveyors. The covering affords a good driving surface since it has a high coefficient of friction and hence decreases the slip of the belt and increases the mechanical efficiency of the conveyor. The cover is attached to the face of the pulley by cementing and riveting with counter-sunk copper rivets.

Pulleys can be lagged with wooden strips in place of rubber or fabric covering. This is a more durable construction and is often used. The wood has a much higher coefficient of friction than iron although it is slightly inferior in this respect to canvas or rubber.

The so-called wood pulley is built up of laminated wood strips glued together, the bore being bushed with an iron sleeve. It is similar in driving qualities to the wood lagged pulley but is less capable of withstanding moisture and extremes of temperature.

The slat-bar pulley is sometimes used on conveyors handling material such as wet clay which would have a tendency to pile up on a solid face pulley.

Paper pulleys (Fig. 113) are built up of layers of a

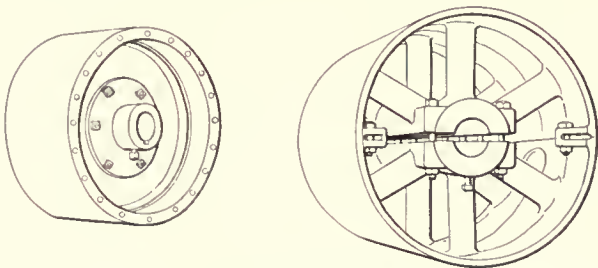

Figs. 113 and 114

special kind of fibre compressed under high pressure and fitted with cast iron hubs. The sheets of fibre are held together with iron flanges and rivets so that the construction throughout is substantial and durable. Experiments have proved that fibre makes one of the best friction surfaces known, and practical experience has fully confirmed this, but nevertheless paper pulleys are not often used on conveyors.

It is sometimes necessary to use dust-proof pulleys in the boots of belt type bucket elevators. These pulleys have round steel plates covering the ends, thus preventing the entrance of the material being handled and cutting down the power required for operating the elevator.

The diameter of the pulley to be used for a given conveyor depends for the driving pulleys mainly on two factors, the traction required and the thickness of the conveyor belt. The diameter must be sufficient to insure that the belt will not slip on the pulley. Naturally, the greater the coefficient of friction of the pulley surface, the smaller the diameter possible. As to the bending of the belt over the end pulleys, a good rule is not to use a pulley of less diameter in inches than three to four times the ply of the belt.

Push Bars

Push bars are used for handling boxes and packages on horizontal and inclined conveyors and elevators. The oldest and simplest push bar was a block of wood fastened to a single or double strand of chain, the chain running in grooves cut in the conveyor runway. This construction is limited to conveyors handling light packages.

For moderate duty two strands of roller chain are con-

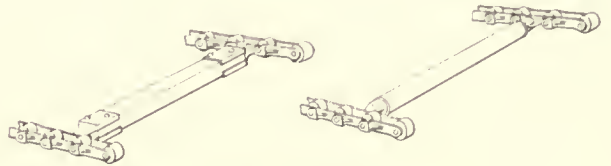

Figs. 115 and 116

nected by a wooden bar (Fig. 115) fastened to the chain by malleable iron swivel attachments. This arrangement is largely used on conveyors handling baled hay and straw and similar light but bulky material. For ordinary boxes of moderate weight a pipe bar (Fig. 116) is used instead of a wood slat, while on the heaviest work a solid steel shaft is necessary. On one type of inclined elevator for handling boxes a roller bar is employed so that if the box is loaded on top of the bar instead of in front of it, the roller will more easily slide out under the box and let the next bar pick it up.

Releases

On some types of power driven conveyors it is necessary to provide safety devices to guard against breakage of the machinery in the event that it is overloaded. The usual method for taking care of dangerous overloads is to use a shear pin which will break and thus prevent a more serious accident to some vital part of the equipment. The shear pin should be placed between the reduction gearing and the conveyor sprockets, and should be so proportioned as to break only when the overload reaches a point above which damage to the chain would result. A pin which is too weak will be a source of constant annoyance and lost time by continually breaking under small overloads

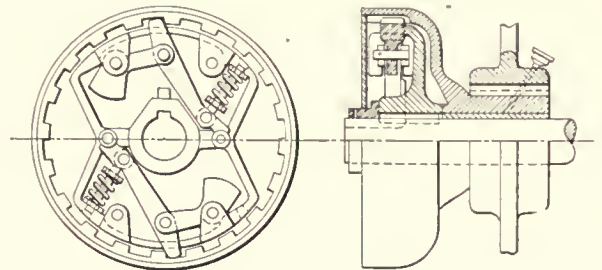

Fig. 117

which in themselves would do no particular harm to the conveyor. To eliminate the time required for replacing

a broken shear pin, several automatic overload releases have been designed.

One type of overload release is shown in Fig. 117. A spider keyed to the shaft has triggers pivotally mounted on links with the ends engaging notches in the rim of a drum and a roller in the hub of the spider. Springs regulated to any desired pressure by adjusting nuts hold the ends of the triggers on the rollers under normal conditions, but when the drive is overstrained, the compression of the springs will permit the ends of the triggers to drop, releasing connections with the rim and allowing the machine to stop immediately.

To place the triggers in driving position again, a collar is provided, having fingers which engage pins in the lower ends of the triggers. By turning this collar by means of a spanner wrench, the triggers will be moved to the original position and the outer ends will at the same time enter the notches in the drum, thus renewing the transmission connection. A cover encloses the entire mechanism, protecting it from dirt.

Screw Conveyors

Screw conveyor troughs are frequently built of wood (Fig. 118), in which case they are of rectangular shape, but where this type of construction is used the trough is lined with a semi-circular sheet steel lining.

Sheet steel troughs are probably the most common. They are built in various sizes, and where too long to be made of a single sheet, are made up in sections and riveted together preferably with a butt joint. This joint may con-

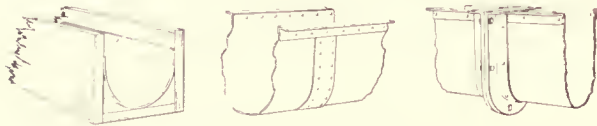

Figs. 118, 119 and 120

sist of a steel plate (Fig. 119) to hold the two parts of the trough together, or cast iron flanges (Fig. 120) may be riveted to the adjacent ends of the troughs and the latter secured by bolting the flanges together.



Figs. 121 and 122

When it is necessary to drain material while it is being transported, a perforated steel trough (Fig. 121) is occasionally found useful.

For very heavy or abrasive work, or under conditions of severe chemical action, cast iron troughs (Fig. 122) are more durable than either wood or sheet steel. These troughs are cast in short sections with flanges on each end, a number of sections being bolted together to form the finished trough.

If material is to be dried during its passage through the trough, a steam or water jacket (Fig. 123) can be used, and as with fine dusty material the top of the trough may be closed in with a dust tight cover. This cover also prevents the throwing out of certain loose material when the speed of the spiral is high.

The ends of screw conveyor troughs are made of cast iron plates which form both an end to the trough and a bearing for the conveyor shaft. When used with steel

troughs these plates (Fig. 124) are flanged and set into the end of the trough, the trough plate being riveted to the flange of the casting. For wood troughs the plate is rectangular in shape, fits into or over the end of the

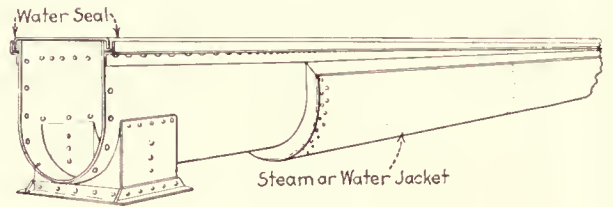
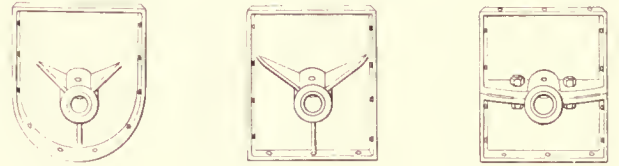

Fig. 123

trough and is held in place by bolts or screws. The most common end plate (Fig. 125) has a solid bearing box made integral with the casting and babbitted or bushed with bronze.



Figs. 124, 125 and 126

A plate split through the bearing (Fig. 126), the two halves being bolted together, is also in common use.

A split and adjustable bearing fitted to the end plate (Fig. 127) gives a convenient means of lining up the screw shaft or removing it from the trough although this construction is not very common.

The plate at the discharge end of some types of screw conveyors (Fig. 128) is often provided with an opening to allow the material to flow out through the end of the trough.

To take up the thrust of the screw a special end thrust bearing (Fig. 129) is frequently used.

Shaft hangers for screw conveyors serve the double purpose of supporting the shaft and bracing the sides of the trough. The hanger itself can be made of steel, or cast iron, and the bearing box may be of chilled iron or lined with babbitt or bronze.

The bearing box of the ordinary cast iron hanger (Fig. 130) is usually split, the lower half being held in place by a long U-bolt which allows it to be easily removed.

When handling hot material the conveyor shaft will expand and contract. This condition calls for some type

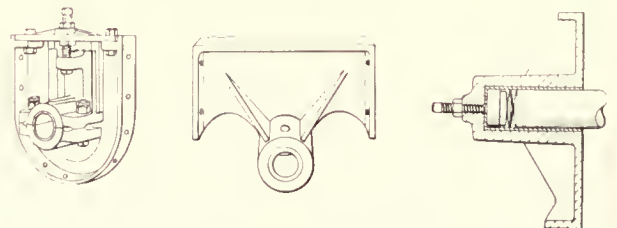

Figs. 127, 128 and 129

of self-adjusting hanger which can automatically adjust its position to that of the shaft. The hinged hanger (Fig. 131) will successfully meet this situation as the bearing box has enough flexibility to follow the variations of the shaft but at the same time prevents it springing out of alinement.

Hangers for square shaft screw conveyors (Fig. 132) have a split cylindrical sleeve with a square hole through it which fits over the shaft and turns with it in the hanger bearing. The sleeve is usually made of chilled iron or bronze and the hanger bearing of cast iron either chilled or babbitted.

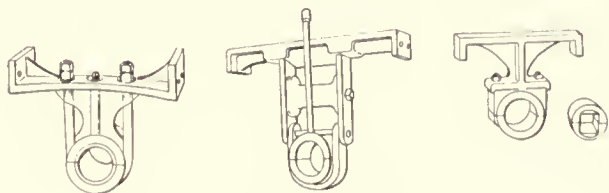

Figs. 130, 131 and 132

Strap iron or steel hangers (Figs. 133, 134 and 135) are used largely on conveyors handling gritty material. They are rarely provided with means for adjusting or lubricating the bearing.

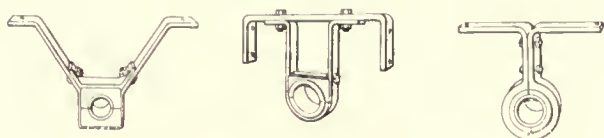

Figs. 133, 134 and 135

Two common types of discharge gates are used with screw conveyors. One consists merely of a plain hand operated slide (Fig. 136) in the bottom of the trough. The rack and pinion slide (Fig. 137) will, however, usually be found more satisfactory as it is more easily opened and closed and is less likely to stick.

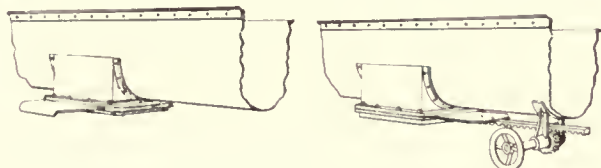

Figs. 136 and 137

The drive for a screw conveyor is usually by direct belt and pulley to a line shaft or an individual motor or through a pair of mitre gears (Fig. 138) located at the receiving end of the trough. When one conveyor discharges into another running at right angles to it, it is usual to drive the second screw from the first, either

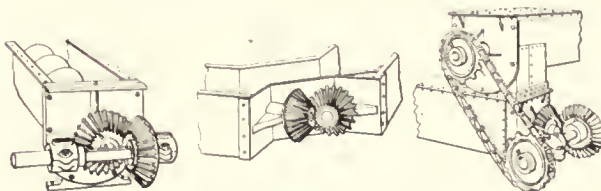

Figs. 138, 139 and 140

directly through a pair of mitre gears (Fig. 139), or by a combination of mitres with chain and sprockets (Fig. 140). Where the latter type of drive is used, the material drops from the first conveyor into the second, giving a perfect transfer with no chance of clogging.

The most common types of flights used on screw conveyors are made of sheet steel formed either in a continuous spiral strip (Fig. 141) or in short spiral sections (Fig. 142) which are riveted together to form the complete screw.

For handling exceptionally heavy loads a double flight (Fig. 143) can often be used to advantage as this type of construction decreases the load carried by each blade and tends to make the flow of material smoother.

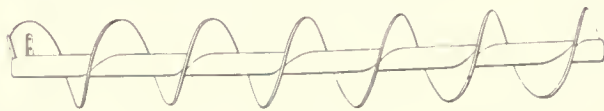

Fig. 141



Fig. 142

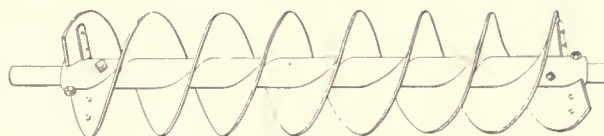

Fig. 143

Screw conveyors are frequently used on material which must be mixed during its progress through the conveyor. For this purpose a great many special types of flights are



Fig. 144



Fig. 145



Fig. 146

used. The simplest mixing flight (Fig. 144) has small paddles fastened to the shaft between the threads of the screw. These afford a gentle stirring action on the material as it is conveyed.

By cutting away portions of the flights (Fig. 145) the flow of material will be interrupted at frequent intervals, by combining the cut flights with paddles (Fig. 146) a

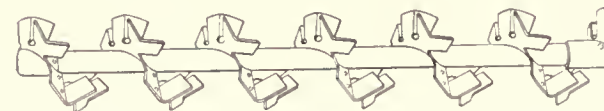

Fig. 147

still greater mixing can be made to take place, while by cutting the flights and folding the cut ends out parallel to the shaft (Fig. 147) a maximum stirring effect can be obtained.

For very heavy material which requires mixing heavy cast iron paddle flights (Fig. 148) may be used.

For light service a ribbon flight (Fig. 149) is sometimes used, and if in addition to the conveying action it is desired to mix the material, a double ribbon (Fig. 150) with

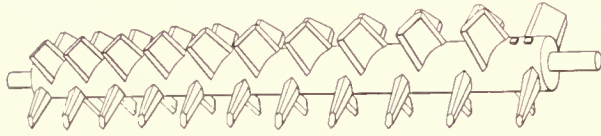

Fig. 148

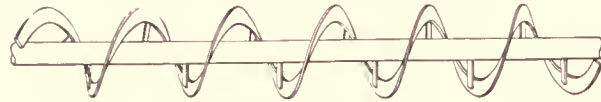

Fig. 149

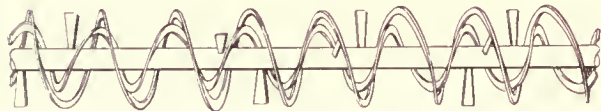
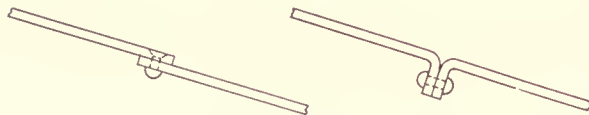

Fig. 150

or without the addition of paddles will accomplish this result. The ribbon conveyor is well adapted to the handling of very loose or sticky materials.

Spiral Chutes

The details of spiral chutes differ considerably, depending upon the type of chute and the practice of the individual manufacturer. In general the runway and guard-rail are made of sheet steel either galvanized or black.



Figs. 151 and 152

Two methods of assembling the runway sheets are commonly employed. In one (Fig. 151) the upper sheet is lapped over the lower one and fastened with countersunk head rivets. In the second type of runway construction (Fig. 152) the sheets are turned down to form flanges, adjacent sheets being bolted or riveted together along these flanges. This construction forms somewhat stiffer supports for the individual wings.

For the usual classes of service the runway is made flat

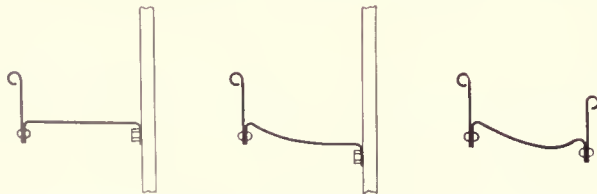

Figs. 153, 154 and 155

on a horizontal radial line (Fig. 153). A package descending such a chute will be forced by centrifugal force against the guardrail, its speed being controlled by the friction on both the runway and guard. The heavier the package, the faster it will tend to move, consequently the more firmly it will be pressed against the guard and the more its speed will be reduced. A light package, being held against the guard with less force, is not subject to as

much friction and will move at approximately the same speed as the heavier one.

When barrels and similar cylindrical objects are to be handled, a concave runway (Fig. 154) forms a satisfactory carrying surface which largely prevents turning and spinning of the article during its descent.

Another type of concave runway (Fig. 155) is commonly used on spirals handling miscellaneous articles. It is designed with the object of handling all classes of commodities at a uniform speed, the principle involved being that very heavy objects which tend to move faster will be thrown outward on the curved runway by centrifugal force to the point where the angle of descent is least and will thus be retarded, while light packages which tend to stick will seek the steeper portion of the chute and descend properly.

Closed-center spiral chutes (Fig. 156) are supported on a center post—preferably a steel pipe—to which the inside edges of the runway wings are attached. For severe ser-

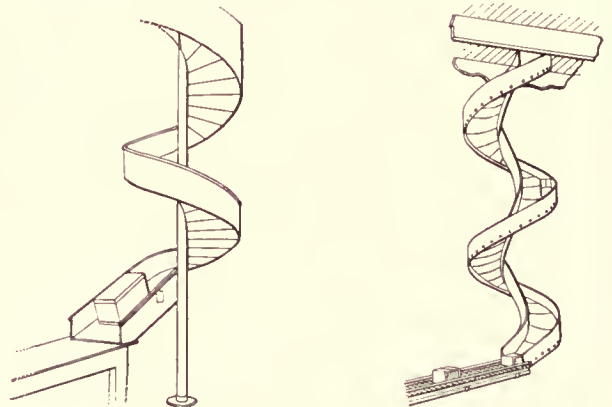

Figs. 156 and 157

vice, structural steel braces can be run from the outside edges of the runway to the center post. The entire weight of the closed-center chute is supported by the post and carried directly on a foundation under the post, no stress

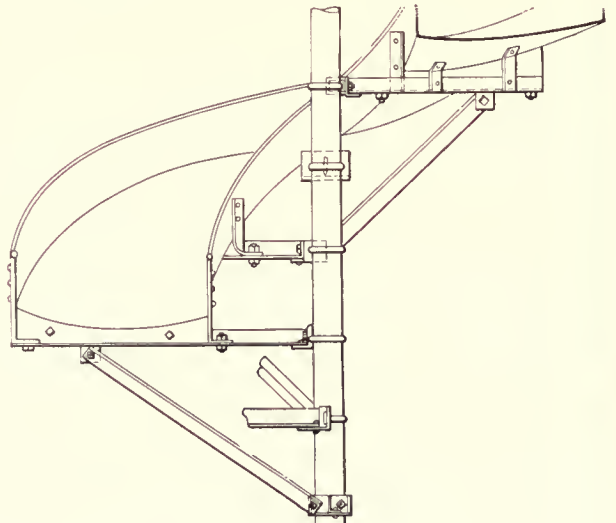

Fig. 158

coming upon the floors of the building. This type of chute occupies a minimum amount of floor space, is reasonable in first cost and can be readily rendered safe from fire hazard due to the floor openings.

Open-center spiral chutes (Fig. 157) are supported by hangers from the ceiling or on structural steel frames. They are also often carried on a central post having long radial steel arms upon which the runway proper is secured. This form (Fig. 158) is generally called an open-center-with-post spiral chute. Open center chutes require a guardrail on each side of the runway. They occupy considerably more floor space than the closed center type of the same capacity, but will accommodate a somewhat larger package for the same width of runway.

Fire doors are required at all openings where a spiral chute passes through floors. These doors should be held open by a fusible link which melts and allows the door to close positively in the event of a fire.

The vertical sliding fire door (Fig. 159) is probably the most common and satisfactory type. It consists of a steel

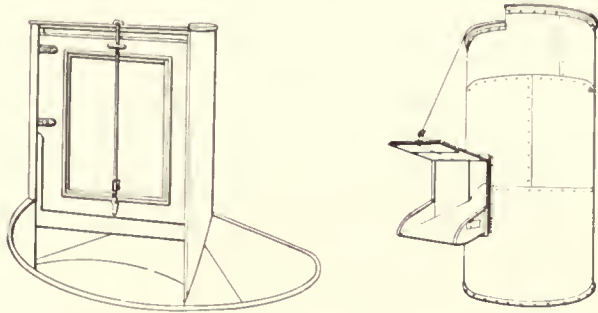

Figs. 159 and 160

panel which is normally supported by a chain and fusible link but is free to slide in vertical steel guides. When this door is closed it fits snugly into the chute and effectively closes off all connection between floors.

On multiple blade spiral chutes it is often found that sufficient clearance is not available between the blades to allow of the application of a vertical sliding fire door. In this case a roller shutter door must be used, as it takes up the least possible amount of space when open and at the same time affords satisfactory fire protection.

Hinged fire doors are used under many conditions. At the top entrance to the chute a hinged door forms a very simple and practical arrangement. When the chute is entirely enclosed in a well or steel housing, the exits and entrances through the housing can conveniently be protected by hinged doors (Fig. 160), although the vertical

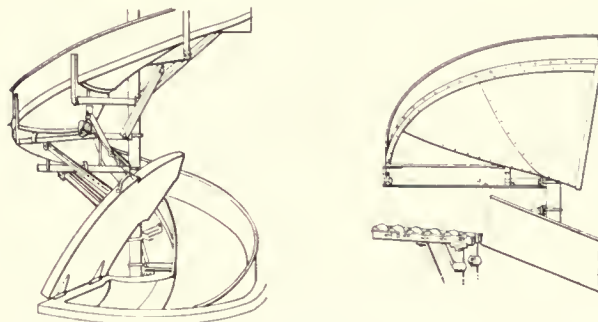

Figs. 161 and 162

sliding door, counterweighted so as to slide easily up and down is also applicable to these conditions. Some types of open center chutes are fitted with hinged fire doors at intermediate floors (Fig. 161). Such doors close down flat against the floor and have a projecting lip which drops into the runway of the chute completely closing the opening.

Loading spiral chutes at intermediate floors may be provided for by hinging a portion of the spiral (Fig. 162) so that it may be lifted to give a free inlet from a gravity roller or other conveyor. Loading at intermediate floors may be accomplished also by means of an inlet slide (Fig. 163) if the packages are heavy, but light packages can be readily

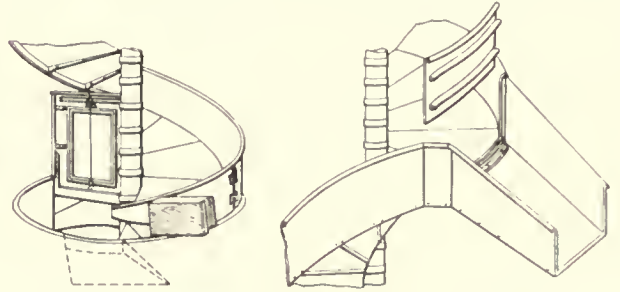

Figs. 163 and 164

loaded over the guardrail. An inlet slide is a short straight chute entering the spiral runway at a tangent to its outside edge. The guardrail of the spiral is either hinged, as shown, or made to lift out at the point where the inlet slide intersects the runway bed. All spirals should be loaded tangentially at the outside guardrail. Attempts have been made to load open center spirals from the inner guard, but this has not proved satisfactory.

Spiral exits (Fig. 164) can be placed at any floor. They often consist of straight chutes intersecting the runway

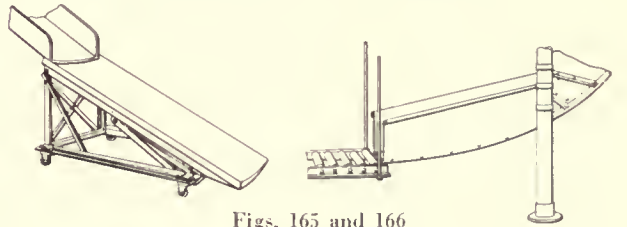

Figs. 165 and 166

on the outer side. By removing a section of the spiral guard at the point where the exit slide meets it, packages descending the chute will be delivered at the desired floor.

Another type of exit slide is a hinged chute which can be dropped into the spiral runway over the guardrail of the latter. This chute should be counterweighted so that when not in use it can be swung up out of the runway and thus allow packages to continue on down the spiral.

The exit chute at the foot of a spiral can be made to deliver to the floor, to a table, or to a conveyor. It is good practice to curve these chutes in the vertical plane so that packages will discharge smoothly. A convenient portable exit chute (Fig. 165) has its outer end adjustable so that packages can be delivered to the floor or to trucks of any height. One of the most common arrangements (Fig. 166) is for the spiral chute to deliver to a gravity roller conveyor.

Sprockets

Sprockets are usually made of cast iron, the teeth being cast to shape and either left rough or smoothed up with an emery wheel. Chill casting the teeth and rim gives a harder wearing surface and a more durable sprocket. For the heaviest duty cast steel is used.

Sprocket wheels are made either solid or are split and the two halves bolted together. The solid sprocket (Fig. 167) is the more commonly used, although the split type can be removed and replaced on the shaft without remov-

ing the latter from its bearings. This feature is not possessed by the solid type, which can only be removed by driving it off the end of the shaft.

As the wear on sprockets comes entirely on the teeth, the latter are frequently made removable. This is good practice when working conditions are so severe that fre-

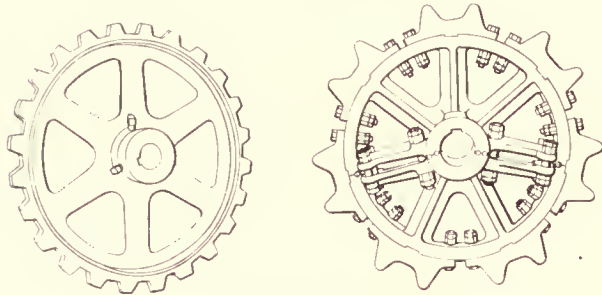

Figs. 167 and 168

quent renewals due to sprocket wear are necessary, as new teeth can be put in place in a fraction of the time required to remove a worn sprocket from its shaft and replace it with a new one. Different methods for holding the removable teeth are in use. They may be tongued

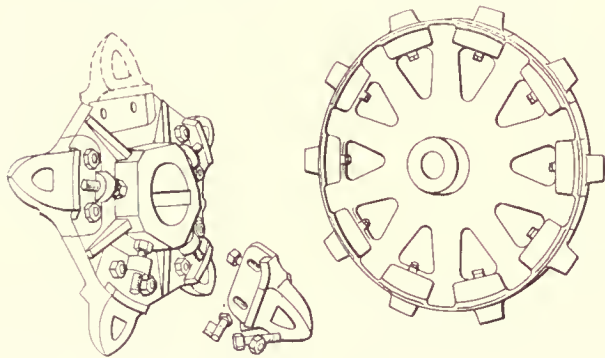

Figs. 169 and 170

and bolted to the rim of a plain wheel (Fig. 168), inset and bolted to the side of the wheel (Fig. 169), or inset and bolted to the face (Fig. 170) in various ways.

Stops

If an inclined or vertical conveyor is operating under load and the driving belt breaks or the power is shut off there is a tendency for the conveyor to reverse its direction of motion and carry its load back to the receiving point. This would do considerable damage both to the conveyor and its load under many conditions, as well as be a source of danger to the operators. Safety stops are

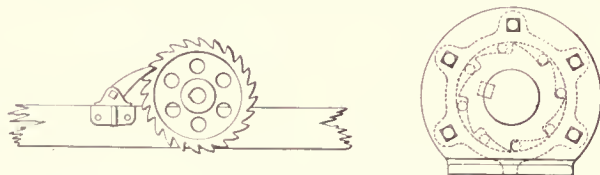

Figs. 171 and 172

therefore sometimes used to prevent such accidents, these stops being either ratchets or automatic brakes applied to some portion of the driving machinery and so arranged as to prevent backward motion of the conveyor.

The simplest stop is the common ratchet wheel and pawl (Fig. 171). Another variety is the roller ratchet

type (Fig. 172) having a ratchet wheel keyed to the driving shaft, steel rollers carried in the teeth of the ratchet, and an outside casing fastened to the conveyor framework. Reversed motion of the shaft wedges the rollers between the wheel and casing, and locks the shaft.

A patented safety stop (Fig. 173), which is used by one manufacturer of conveying machinery, has a split hub which is clamped over the hubs of the driving pinion by four bolts. Compression springs under the bolt heads

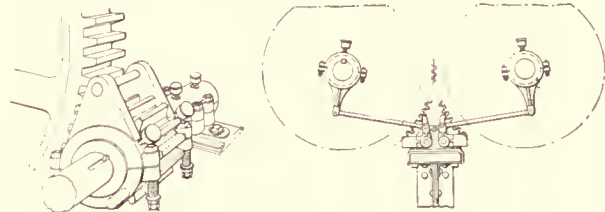

Figs. 173 and 174

furnish sufficient pressure to make the stop tend to revolve with the pinion but allow the latter to turn inside the former if the stop itself is prevented from turning. When the pinion is running forward the stop turns with it until a pin on the hub strikes the conveyor framework and prevents its further motion. If the power goes off and the pinion starts to run backward, friction carries the stop with the entire mechanism which locks the gear and prevents further backward motion. When power is again applied, however, the stop returns to its original position, releasing the gear and allowing the conveyor to continue its forward motion.

Another stop (Fig. 174) which operates on much the same principle as that just described has two friction operated pawls which engage with the teeth of both pinion and gear.

Worm gear driven conveyors rarely require the use of stops as the worm mechanism ordinarily is designed to be self-locking.

It is hardly necessary to add that these safety stops can not be applied to reversible conveyors.

Take-ups

A take-up is a device used on belt and chain conveyors for keeping the chain or belt at the proper tension. Belts will stretch in service, the wear on chain joints will cause the chain to elongate, and it is essential that means be provided for taking up the resulting slack.

The take-up used for all chain type conveyors, elevators, and on the majority of belt conveyors consists of bearing boxes which can be adjusted in guides by means of screws, these boxes forming the bearings for the shaft which carries the idler sprockets or drum. The guides forming a rigid support for the box are designed to attach directly to the conveyor framework, and are accordingly made in a number of styles to meet the requirements of practice.

The so-called "standard take-up" used for medium duty bucket elevators is available in two styles generally designated as "A" and "B," respectively. In style "A" (Fig. 175), the screw advances with the box, while in style "B" (Fig. 176), the box travels along the stationary screw. When the screw moves with the box, it is always necessary to allow enough clearance for manipulating it when in the extreme outward position. A ratcheting handle instead of a hand wheel is often used for turning the screw where space is limited or when the force required for adjusting the box is considerable, as in the case of some bucket elevators with the take-up at the top. When used in con-

junction with a housed-in bucket elevator, the adjustable bearing box (Fig. 177) carries a dust slide which effectively prevents the escape of material from the elevator no matter in what position the box is set. Occasionally the outer end of the box is itself closed as a protection to the bearing.

Floor stand take-ups (Figs. 178 and 179) are used at the head ends of some types of elevators. The supporting frames are arranged to stand directly on the floor, the

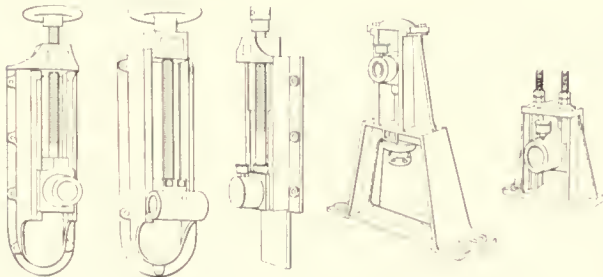

Figs. 175, 176, 177, 178 and 179

adjustment being vertical. The screws may be arranged to be either in tension or compression.

The simple take-up (Fig. 180) has a box guided by a single tongue and groove joint. It is suitable only for use on the lighter types of conveyors.

Either cast iron (Fig. 181) or steel frame take-ups

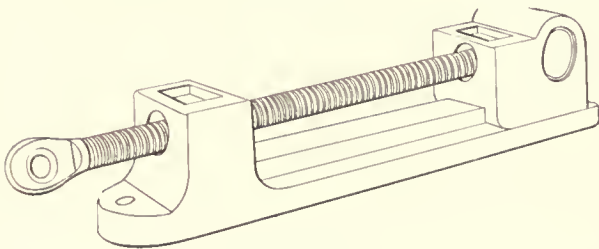

Fig. 180

can be used for heavy duty. In these the box is rigidly supported by an extra wide frame, and the latter is designed so that the stresses are all centralized, and the screw is

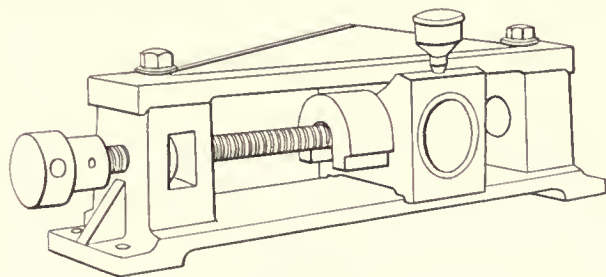

Fig. 181

in direct tension or compression, thus attaining the maximum strength and rigidity. Heavy take-ups are also made in the stationary screw type.

On protected screw take-ups (Fig. 182) the bearing box travels along the screw, the latter turning but not advancing with the box. This allows the supporting frame to act as a cover protecting the screw from dirt and corrosion. The box is usually of the split type, and may be made self-aligning. The seat upon which it rests may be either flat or triangular, the triangular type having certain advantages such as greater strength for equal weight, and less chance for dirt to accumulate on the guide. These take-ups are used principally on out-door equipment.

The double pipe take-up is fitted with a self-aligning bearing carried on pipe frames. For heavier work, steel shafting is used in place of pipe, but this take-up is not

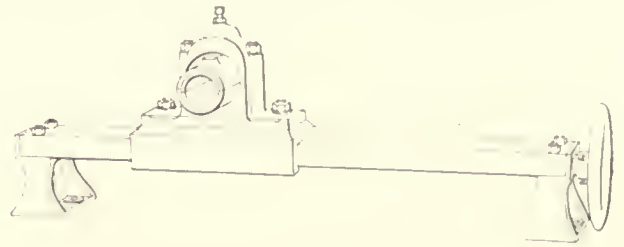

Fig. 182

suitable for very heavy duty as it is not as rigid as those types especially designed for severe service.

When it is desirable to locate the take-up at the driving end of the conveyor, this can often be done, although it is not a very common practice. If the drive is through spur gears, a double bearing head take-up will be required to meet this condition.

A spring take-up (Fig. 183) allows the bearing box to adjust itself within a limited range to variations in tension on the belt or chains. This is a particularly valuable feature in connection with chains of long pitch. Such chains always run with a constantly varying tension if the two sprocket shafts are held in a fixed relation to each other, but the spring take-up will automatically compensate for this variation and make for a smoother running and more lasting installation.

On all the preceding take-ups adjustment is made by hand. As the belt stretches or the chains wear, the operator compensates for the stretch by moving the take-up screws an amount which his judgment indicates as correct. This personal factor can often be eliminated on belt conveyors

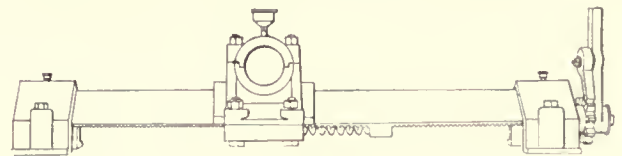

Fig. 183

by the use of a gravity take-up which automatically maintains the proper tension on the belt. Both horizontal and vertical gravity take-ups are in common use. They may be located at any point along the slack side of the belt, but if convenient they should be placed close to the driving end, as at this point the slack in the belt is greatest, and the take-up will consequently be most effective.

Tighteners

A chain tightener is a small sprocket or flanged wheel carried by an adjustable bracket in such a way as to bear against the slack side of a running chain and serve the purpose of a take-up. Tighteners are used principally in connection with transmission chain where the relative position of the driving and driven sprockets is fixed and the ordinary take-up is therefore not applicable.

A swing tightener (Figs. 184 and 185) is the easiest to adjust, as it is necessary merely to loosen the bolt in the slot, swing the tightener up against the chain, and tighten the bolt. Very often these tighteners are not fastened rigidly but are held against the chain by a spring or weight.

The plate tightener (Fig. 186) is fastened by two bolts

passing through elongated holes in the plate. It is less apt to work loose than the swing type.

The fork tightener (Fig. 187) is similar to the plate type except that the stud on which the idler wheel runs

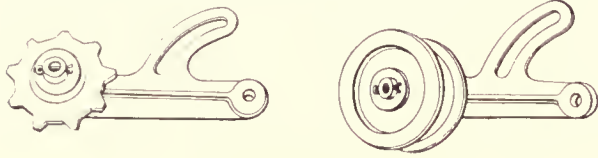

Figs. 184 and 185



Figs. 186 and 187

is not overhung but is supported on both sides of the wheel. This tightener is sometimes used in place of a take-up on very light conveyors, as it is considerably cheaper than the conventional take-ups.

Trays

Trays are used in place of arms for carrying the load on the balanced types of automatic and semi-automatic continuous motion vertical elevators for packed material. They are always carried between two strands of chain and pivoted so as to hang vertically. The load, being centralized between the chains, has little tendency to pull them out of line. Trays can be loaded at any point and the load is carried upright at all times, so that open boxes, crates, etc., and fragile articles such as bottles and tableware can be safely handled.

The simple platform tray (Fig. 188) is useful only on elevators which are manually loaded and unloaded. It is built of wood with steel hangers for light service, or of all steel for heavy duty.

Barrels and drums are handled on curved finger trays

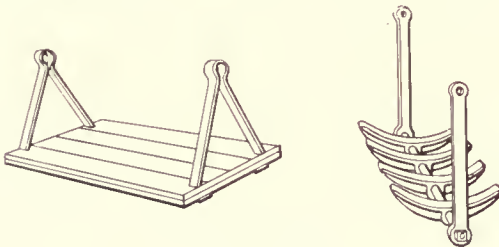

Figs. 188 and 189

(Fig. 189) which allow of automatic loading and discharge. The curved fingers form a cradle which prevents the barrel from rolling off.

Boxes and crates usually require a straight finger tray

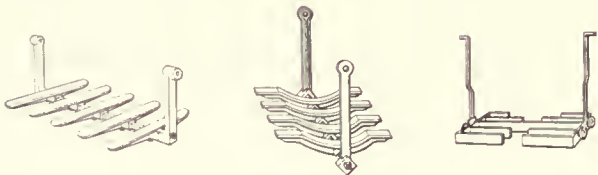

Figs. 190, 191 and 192

(Fig. 190) for successful handling if automatic loading and discharge are necessary.

If both cylindrical and flat packages must be handled on the same elevator, a combination curved and straight finger tray (Fig. 191) can often be used to advantage.

Automatic elevators which receive and discharge to gravity conveyor are fitted with special types of trays (Fig. 192), which are arranged with steel fingers to pass between the rollers of the conveyor. They can be loaded automatically only on the upward moving side. These trays may be center-hung as shown, suspended from diagonal corners, or of the cantilever type.

Troughs

Troughs for flight conveyors are sometimes constructed of wood planking, but modern practice tends to the use of sheet steel as being more serviceable.

Many types of troughs are used for flight conveyors. The thickness of the stock usually varies from No. 12 gage to one-quarter of an inch, the edges of the trough (Figs. 193 and 194) being frequently reinforced with angle, Z-bar or other stiffeners which form a track for the chain or rollers which support the flights. For ease of manufacture and convenience in handling and erecting, steel troughs are made in sections up to eight feet in length, these short sections being spliced together to form the finished trough.

Two methods are in use for making the splice between adjacent sections of the trough. When the lap joint (Fig. 196) is employed, the sections should be set up so that the

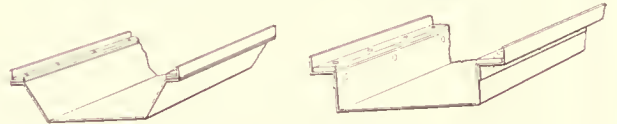

Figs. 193 and 194

direction in which the material moves is as indicated by the arrow. The butt joint (Fig. 195) gives a perfectly smooth inside surface to the trough but involves the use of an extra steel strap which is riveted to each section



Figs. 195 and 196

at the joint and is therefore somewhat more expensive to construct.

To discharge material from the conveyor at intermediate points along the run, it is necessary to provide gates in the bottom of the trough which can be opened or closed as required. Plain hand operated slides and drop doors

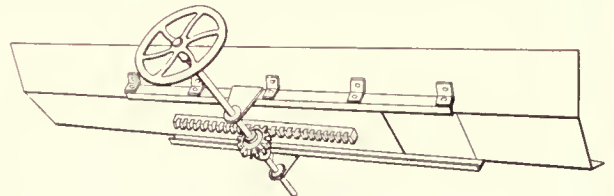

Fig. 197

are sometimes used for this purpose but are usually not as convenient and satisfactory as the rack and pinion gate (Fig. 197) which slides in guides under the trough and is operated by a hand wheel.

Troughs for screw conveyors will be found described under the head of "Screw Conveyors."

ELEVATORS

Hand, Belted, Electric, Hydraulic, Special

A Treatise Covering the Development, Construction and Application of Elevators, Including Discussions of Capacities, Loading and Unloading Time, Speeds, Acceleration, Retardation, Schedules, Location and Layout, Motive Power, Types of Motors, Power Consumption, Winding and Traction Engines, Control, Types of Controllers, Switches, Braking, Auxiliary Devices and Safety Codes for the Construction and Maintenance of Elevator and for Power Transmission Machinery

By

A. A. ADLER

Member, American Society of Mechanical Engineers



Elevators

BEFORE ENTERING INTO A DISCUSSION of the technical features of the elevator it might be well to review its history. A special type of elevator may be proposed for a given duty; expenditure of both energy and capital can often be avoided through a detailed knowledge of history of the development of elevators which may disclose that long ago such a type had been used and found wanting. A study of conditions contemporary with its development may also show why it was discarded.

The first elevator on record was used for passengers and freight in the convent of St. Catherine on Mount Sinai about the middle of the sixth century; it was operated by a capstan. About the middle of the seventeenth century Vela- yer of Paris invented a "flying chair." It was probably operated by means similar to that of the present hand hoists. Perhaps the first plunger machine was installed in the Capuchin church at Vienna some time in the latter part of the eighteenth century.

Important forerunners to the modern elevators started with Sir William Armstrong's hydraulic elevator used in England in 1846. He also employed the separate pump and the pressure tank system. About 1850 he invented the weighted accumulator used at a much later date with high pressure hydraulic installations.

Edoux of Paris in 1867 exhibited the first model of a plunger elevator using counterbalance and details resembling those of standard machines of a few years ago.

In America the industry started about 1850. Among pioneers in this field were Henry Waterman, of New York; George Fox & Company, of Boston, Mass.; William Adams & Company, of Boston, and Mr. Otis Tufts, of Boston, who constructed the first passenger elevator in America. Tufts made steam-driven drum machines and in 1859 invented his vertical screw elevator. Only two of these machines were built, one of which was installed in New York and the other in Philadelphia; they continued in service until about 1875. The principle of the vertical screw elevator was the same as a bolt and nut; the car in this case contained the nut while the vertical screw passed through the center of the car. It was belt-driven by means of bevel gears.

Steam-driven elevators were the standard in the early seventies and some installations were made even as late as 1885. The chief objections were the noise and the pulsations of the pistons which were transmitted through the ropes to the car.

The first important hydraulic installation was made by Cyrus W. Baldwin in the Boreel Building, New York, in 1878. These machines were of the vertical-cylinder type. The success of this installation marked the beginning of the end of the steam-driven elevator. The prevailing type soon after this seems to have been the short vertical-cylinder of Baldwin with a high gear ratio.

Many manufacturers entered the hydraulic elevator field and various interesting types were brought out. Charles R. Otis developed the beam-engine construction of which only few were built and the Whittier Machine Company brought out the horizontal machine. The horizontal-cylinder machines of the "push" and of the "pull" type soon became the standard elevators. They had to be geared in order to permit their use in the high rise buildings which were then (1880) being constructed in fairly large numbers.

Early hydraulic elevators were operated by gravity pressure, having an open tank on the roof. Since the buildings were not very high from 30 lb. to 50 lb. was the usual pressure. When the demand for greater load and higher speed appeared the gravity system had to be abandoned in favor of the pressure tank systems. Here the higher pressure was obtained by pumping water into closed tanks into which a certain amount of air was introduced. The air

acted to relieve the elevator car of the pulsations of the reciprocating steam pumps which formed the standard equipment. An important installation of this kind went into the Mutual Life Building, New York, in 1884.

The further development of the pressure tank, first used by Sir William Armstrong at a much earlier date but reintroduced as the Hinkle system, was in the line of higher pressures up to about 175 lb. This permitted the use of cylinders of smaller diameter since it was necessary to "stack" the elevators in order to economize space. There was

a tendency to return to the gravity system in 1910, for the buildings of that time reached heights sufficient to obtain the pressures required to operate the standard elevator equipment of that period. In very large installations the low-pressure hydraulic systems were at a disadvantage because of the space occupied by the cylinders and piping.

The development in this direction led to the installation of high pressure systems of about 750 lb. working pressure. A large number of plants of this kind were installed; in these the pressure tank was replaced by the weighted accumulator.

The plunger machine was one of the very earliest elevators in the field but it was not until George I. Alden's improvements of details in 1900 that this type became a commercial proposition. Up to very recent times the plunger elevator was a formidable competitor of the ordinary hydraulic machine and for a time threatened to displace it. However, the extreme height of modern buildings made the cost of this type excessive in comparison with electric elevators and its commercial limits have been reached.

While the general forms of the elevator were undergoing development the details were also being improved from time to time. The first elevators used rope control but as speeds increased the difficulty of manipulating a rope at a

Development of the Elevator.

Factors of the Elevator Problem: Capacity; Schedules; Size and Number of Cars; Economics; Location; Power Consumption.

Electric Elevators: Winding Engines; Traction Engines; Belt Drives; Braking; Control; Controllers.

Hydraulic; Pneumatic; Steam-Driven; Hand Power; Portable.

Auxiliary Devices and Details.

Elevator Installations.

Safety Code for Construction, Operation and Maintenance.

speed of 300 ft. per minute gave way to the standing rope control using a wheel, and later the much more satisfactory lever control.

The large capacity and high speed required of the hydraulic elevator made it difficult to operate the main valve and George H. Reynolds introduced the pilot valve and the differential valve. This decreased the effort on the part of the operator and thus made possible the more accurate stops so much needed when the speeds became high.

Safety devices also passed through their period of development. First of these was the Elisha Graves Otis ratchet safety which engaged in a rack made fast to the guides. This was followed by the wedge of Cyrus W. Baldwin which engaged in the sides of the wooden guides which were then used. The function of the safety is to bring the car to a gradual stop and these devices accomplished the result too suddenly. Hence the later development consisted of grips on the steel guides through spring pressure or otherwise.

Among the notable developments for safety was the air cushion of Albert Betteley, later improved by Albert C. Ellithorpe, where the car shaft is enclosed in the lower stories. The air from underneath the car escapes through the space between the car and the shaft at a rate dependent upon the size of this opening. For very high rise elevators this air cushion is expensive to install but it is sometimes used with other types of safety devices as an additional insurance for safety.

Factors of the Elevator Problem

The elevator is used for vertical transportation and consists essentially of a platform moving in a shaft or hoistway provided for that purpose. The power required for operation may be derived from any source.

While there are many points in common between elevators used for passenger and freight transportation the discussion here given relates chiefly to freight elevators. Passenger elevators will be discussed only in so far as it seems necessary to emphasize the general principles which underlie all forms of vertical transportation.

Vertical transportation is frequently compared with horizontal or railway transportation but analysis will show that they have but few elements in common. For example, in elevator practice each car has a separate hoistway; the schedule and round-trip time of an elevator is independent of additional elevators; there are no curves or grades; there is no interference with cross-traffic except in the case of automatic hatch-door elevators; the speeds are fixed by the maximum accelerations and retardations permissible. There are additional differences of lesser importance but the foregoing are the important characteristics of elevator practice. Hence conclusions in railway transportation are not in general applicable to passenger or freight elevators. The problem thus requires separate and independent analysis.

In passenger transportation for office buildings it is usually sufficient to carry people to certain floors. The movements about the floors are matters of individual attention. In manufacturing plants the freight elevator is a part of the general freight transportation scheme. It is not an isolated problem but must be considered in its proper relation to the scheme as a whole. After the elevator service is determined so that it imposes no limitation on the general transportation scheme, the problem narrows down to the proper choice of the elevator.

The electric elevator industry started with the constant current machine of William Baxter, Jr., in 1884. The first successful drum machine of Norton P. Otis, R. C. Smith and Rudolph Eickemeyer was constructed in 1889. Before this time belted elevators using electric motor drive were in use, but these required no electrical control of speed and direction and are therefore not to be considered self-contained units. Frank J. Sprague and C. F. Pratt brought out the screw elevator about 1894; it consisted of a horizontal screw and an ingenious ball-bearing nut. The nut carried the traveling sheaves which enabled this elevator to have gear ratios much the same as the horizontal hydraulic elevators. After an unsuccessful attempt to establish this type of elevator as standard equipment it passed out of existence in a few years. The traction machine appeared in 1903 and at the present time has replaced nearly all other types, whether electrical or mechanical. A further improvement was introduced in 1915 by the use of micro-leveling to enable more accurate landings.

The history of the electric elevator includes much development along the line of elevator control, without which its great success would have been impossible. The direct current motor was the first to be used and its control has reached a high state of development. The alternating current motor was not so successful, particularly in its early stages. However, the latest developments indicate that it is now a commercial proposition and no doubt it will see additional improvements in the future.

One-story buildings require no elevators. Multi-story buildings in general require elevators both for passengers and freight; in fact use of some multi-story buildings is only possible when such elevator service is provided.

If the loads to be carried are light and the buildings not very high there may not be sufficient advantage to warrant the installation of an elevator. Indeed the conveyor and the elevator are competitive, their fields of application overlapping in many instances. Roughly the conveyor may be considered in the continuous transportation class whereas the elevator belongs to the intermittent and variable bulk class. The correct solution of the problem must be determined on the basis of engineering economics. The general plan in such cases is to compute the costs of transportation for competitive schemes, evaluating all the elements so far as it is possible to do so. The problem is usually not difficult, but is tedious. It may happen that the cost of investigating the relative merits involved tips the balance either way.

Where land is expensive it may be and usually is desirable to erect a tall building in preference to a one-story structure of correspondingly greater area. The considerations leading to this decision will not be discussed here. Given the problem of a multi-story structure, there are three important factors to be considered which limit the maximum number of stories.

The first and usually the deciding factor as to the height of the building is the commercial possibilities. If it is simply a housing proposition economic balance is obtained when the cost for the competitive schemes, everything considered, is equal. A forecast into the future may have some influence and if so will wisely be given due consideration. In the case of office buildings in desirable locations the heights have reached many stories and seem still to be on the increase.

A second limit is that dictated by the structural possibilities. As the building grows in height, and therefore in weight, the ground area occupied by the column footings and the building walls increases. When this is followed to the extreme the available area of the lowest floor may become vanishingly small. This limit, therefore, is a commercial consideration.

The third limit and the one directly affecting the handling of material is the transportation problem between floors and between the street level and any one floor. Suppose that the vertical shafts in the diagram represent elevator hoistways and that the horizontal lines represent the floors of a building. For convenience in the analysis let it further be assumed that the building is just deep enough to accommodate the elevator hoistway and that the floor area is made up by increasing the width of the building as shown. Suppose further that elevator 1 can only handle the traffic for the 16th floor, elevator 2 handles the traffic for floors 14 and 15 because of their now smaller area and so on until elevator 5 handles the traffic for floors 2 to 6 inclusive. The addition of the sixth elevator will take up the only remaining area and a limit is therefore attained.

The foregoing, however, are not the only limits since the soil may not warrant the substructure for a high building.

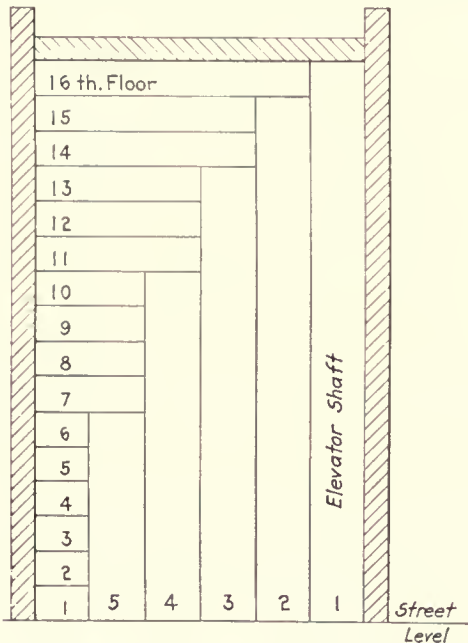

Chart Illustrating Limiting Height of Buildings

Fire-hazard must come in for its share of attention and the human fear of the stability and the stiffness in high winds will have its influence. The complete analysis may, therefore, be exceedingly complicated.

In general, however, the financial considerations impose the first limit; the transportation limitations come next, and the structural considerations last.

Capacity

The two elements entering into the determination of the capacity of an elevator are the quantity transported per trip and the time occupied in making the trip. Under ideal conditions of loading, a car will carry its maximum load and for every delivery new loads will be taken on to replace the loads delivered; this condition to obtain both on

the upward trip as well as the trip in the reverse direction.

The trip load-factor of an elevator may be defined as the ratio of the capacity actually obtained to the capacity obtainable under ideal conditions. This ratio is very low in most installations. But while it is low in manufacturing establishments it is high in warehouses where receiving and shipping are constantly in progress. Good engineering in this case has for its object the raising of this load-factor. There are many elements which are disturbing chiefly in the inability to adjust manufacturing operations to suit conditions best for the elevator. Since in general the object is to market the product of the industry under consideration the engineering problem is to fit the elevator to the work it is intended for.

A broader aspect is obtained by viewing the elevator with relation to its hoisting efficiency. This requires knowledge of the round-trip time. Thus the capacity in any given time, say for an eight-hour day, is the capacity per trip multiplied by the number of trips made in that time. Accordingly, the hoisting efficiency may be defined as the amount of traffic handled, divided by the traffic possible under ideal conditions.

The elements involved in the trip-time are the time required for loading, closing gates, acceleration, running, retarding, level landing, opening gates, and unloading. These elements are now to be considered with reference to their possibilities for decreasing the time required for their proper functioning.

The time required to load the elevator depends upon the convenience of elevator location, facilities for handling, outside interferences and efficiency of handling crews. Each of these items is so general that a discussion might appear vague. However, some of the factors involved will be considered later.

The time required to open and close the doors in freight elevator service is a small item compared with the other items involved. For passenger service it is much more important, particularly for local service where the stops are numerous. To eliminate delays automatic doors of various kinds have been devised. Then selection must be determined on the basis of the reduction in cost made possible by their use.

If a car is to reach a given speed after a given interval of time the acceleration must be so adjusted that this becomes possible. This raises a question as to the factors which limit accelerations, since the greater the acceleration the smaller will be the time required to make a trip. There appear two limits, besides those imposed by the economics involved; these are due to physical and physiological causes.

Suppose a car starts from rest on the up-trip. The pressure which a person standing on the platform exerts will be his weight plus the additional force imposed by the acceleration. From the laws of physics we have the equation:

$$F = M A$$

where F = force in pounds

M = mass of the body, being in general the weight of the body in pounds divided by the acceleration of gravity (32.2 ft. per sec.)

A = acceleration in feet per second.

A simple application of this equation will make matters clearer. Suppose a person to be standing on the ground. His weight exerts a pressure on it and the reaction on the person is such as to cause fatigue in time. In this case

the force F corresponds to weight, the mass M corresponds to $\frac{W}{G}$, or his weight in pounds divided by the acceleration of gravity, while the acceleration A is that due to gravity and is therefore represented by G . Hence substituting this in the equation $F = M A$ there results

$$F = \frac{W G}{G} = W$$

This expressed in words means that the force exerted on the ground is equal to the weight of the person standing.

Consider now the case where the platform of an elevator is accelerated in an upward direction with an acceleration A . The force required to move the person upward has the same line of action as the pull due to gravity and hence these forces may be added to produce this total result. Or stating this mathematically

$$F = W + \frac{W A}{G}$$

where the last term is the term due to acceleration; the greater this value is the greater will be the pressure. The absolute limit in the case of a person standing would be a pressure so great as to crush the body. When dealing with freight the apparent increase in weight, as it might be called, may reach such great values as to cause damage, entirely depending upon the choice of the magnitude of A . The case is exactly similar to that obtained by dropping freight on the ground, only here instead of the acceleration there is a retardation. If a falling body be brought to rest gradually (meaning low values of retardation) it can be done so without causing damage. A simple experiment may be tried to illustrate the effect even though the magnitude may not be appreciated. Suppose a person holds a heavy package while on an elevator platform. If the car is suddenly started the package is apt to fall out of his hands.

For downward accelerations the maximum attainable in ordinary elevator practice is that of a free fall. This can be accomplished by cutting the ropes which support the car. The value of the acceleration is the value of the acceleration of gravity and increases the velocity downward 32.2 ft. per sec. This limiting velocity occurs only in a vacuum. The actual velocity will be less than this because of air friction. If higher accelerations are desired these can be obtained by pulling the car downwards by some external agency. A passenger in a car like this would need to be secured to the car if he were to be subjected to this augmented acceleration.

The physiological limits of acceleration are well within the physical limits and are the guide in all passenger transportation. On the up-trip, accelerations of from 10 ft. to 15 ft. per sec. have been used. A peculiar fact in this connection is that the acceleration alone is not the controlling element but rather the rate at which this acceleration is applied. By starting with a lower and gradually reaching a higher rate, then slowing down to zero acceleration, the riding qualities of an elevator are improved.

On the down-trip accelerations of more than 10 ft. per sec. seem to be limiting values. Even these rates cause nausea with most people and if repeatedly subjected to them will result in seasickness. This is probably due to the fact that the human body is accustomed to downward pressures occasioned by the action of gravity upon us at all times. A sudden downward acceleration is equivalent to a decrease of gravity and we are physically unprepared to ac-

commodate ourselves to the condition without a certain amount of discomfort.

Commercial accelerations in many cases are in the neighborhood of 4 ft. per sec. Where trip time is important higher rates are used and may be found justifiable when all things are considered. An attempt will be made later to investigate this problem.

The car speed is that constant, or nearly constant, speed which follows the acceleration period. For a given distance of travel the time consumed is inversely proportional to the speed. Thus, if a car travels at a speed of 150 ft. per min. and must travel a distance of 75 ft. the time occupied (running time) will be 30 sec. If the car speed is increased to 300 ft. per min. the time will be half or 15 sec.

State laws and municipal ordinances usually fix car speeds only. It would be more rational to fix in addition both the rate of acceleration and the acceleration, as well as the rate of retardation and the retardation itself, since these are the elements which affect the individual. The highest car speed so far attained commercially in passenger service is about 700 ft. per min. Freight elevators are run at much lower speeds, frequently in the neighborhood of 50 ft. per min.

The retardation is much the same as the acceleration in its effect upon the individual. To the physical and the physiological aspects must be added the psychological effect. The uncertainties of getting into motion are greater than those of coming to rest. Hence experiments indicate the feasibility of higher rates of retardation by about 5 ft. per sec. above those for acceleration.

The time occupied to make good landings is more important in freight service than in passenger service. The injury to the car and the sills by the impact of truck wheels when there is a difference of level between car and landing is important enough to deserve consideration. A system known as micro-leveling has been devised to accomplish this automatically.

Briefly, the system consists of the addition of a small electric motor, in addition to the main hoisting motor, which completes automatically the motion of the drum shaft when the machine is in the "micro" zone 8 in. above or below the landing. This motor is geared to the brake frame, which it turns at a slow speed until a level landing is secured. Should the level change due to loading or unloading the micro-drive immediately restores the level without attention from the operator.

If the car is not intended to stop at a particular landing a solenoid controlled by contact points in the shaft renders the micro-drive inoperative. The contact points being secured in the shaft any stretching of the ropes in service does not in any way affect the operation of the drive. No time allowance is required to secure level landings.

The conveniences supplied to make for rapid loading usually apply to unloading. The mutual relationship is appreciated by the designers of this class of apparatus. The topic will be treated in detail later.

Schedules

The study of the influence of acceleration and car speed on the time required to reach any landing is best approached by considering the distance-time curves. Assume that the horizontal lines in the diagram represent the distance in feet above the first floor landing. If the distance between floors is 13 ft. the horizontal line marked 13 represents the second floor landing. Let also the spacing of the vertical lines represent the interval of time in seconds, as shown. Consider the construction of curve 1.

From the laws of falling bodies we have two well known equations as follows:

$$V = AT$$

$$S = \frac{1}{2} AT^2$$

where

- V = velocity measured in feet per second
- A = acceleration measured in feet per second
- T = time measured in seconds
- S = space passed over measured in feet

Curve 1 of the diagram is constructed on the following assumed data: Car speed of 300 ft. per min. (5 ft. per sec.), acceleration of 2 ft. per sec. and a retardation of 2 ft. per sec.

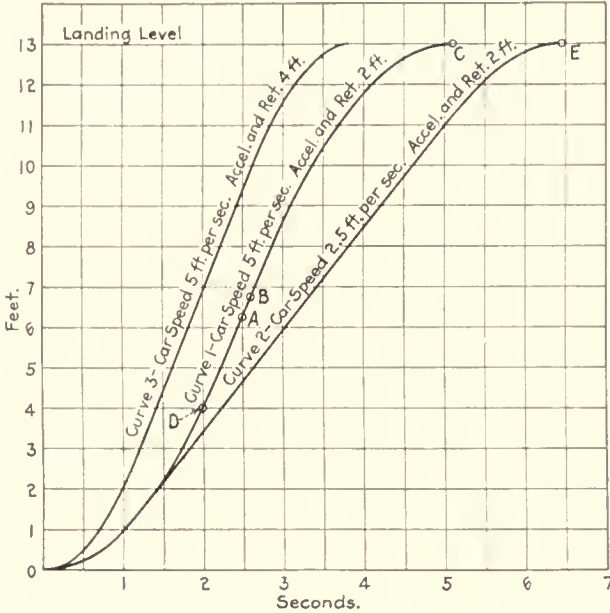

Acceleration-Retardation Curves.

From the equation $V = AT$ the time required to accelerate the car up to 300 ft. per min. is by simple transposition,

$$T = \frac{V}{A} = \frac{5}{2} = 2.5 \text{ sec.}$$

The space passed over with the given acceleration and after a lapse of 2.5 sec. is given by the equation $S = \frac{1}{2} AT^2$ or

$$S = \frac{1}{2} \times 2 \times (2.5)^2 = 6.25 \text{ ft.}$$

Thus point A on curve 1 represents this condition.

A retardation of the same rate as the acceleration given will bring a car running at a speed of 5 ft. per sec. to rest in a space of 6.25 ft. and the time required will be 2.5 sec. In general, the retardation is the reverse of acceleration.

The total space passed over during the acceleration and the retardation periods is accordingly $2 \times 6.25 = 12.5$ ft. Hence since the distance between floors is 13 ft., the space to be traversed by the car running at constant speed (car speed) is $13 - 12.5 = 0.5$ ft. The time required to cover this distance is obtained from another equation of the laws of falling bodies, i.e. $S = VT$

Where the meaning of the symbols is the same as before, the velocity, however, to be held constant,

Consequently for a car speed of 5 ft. per sec., by simple transposition of equation $S = VT$

$$T = \frac{S}{V} = \frac{0.5}{5} = 0.1 \text{ sec.}$$

Thus, the operator must cut off power in one-tenth of a

second (point B on the curve) after the car attains full speed in order to effect an accurate stop under the assumed conditions.

The total time required to bring the car to the second floor is the sum of the times required to accelerate, run and retard, or $2.5 + 0.1 + 2.5 = 5.1$ sec. This is represented by the point C on the curve.

Intermediate points on the acceleration curve are found from the equation $S = \frac{1}{2} AT^2$. Suppose it is desired to find where the car is after two seconds from the start. Hence since $T = 2$,

$$S = \frac{1}{2} \times 2 \times (2)^2 = 4 \text{ ft.}$$

Accordingly D on the curve is located at the point which is the intersection of the vertical line passing through 2 sec. and the horizontal line passing through 4 ft.

For another example, take the case of car speed of 150 ft. per min. (2.5 ft. per sec.), the acceleration and retardation remaining the same as before.

The car is accelerated as before but now, since the car speed is one-half of the previous car speed, the time required to bring the car up to this new velocity is accordingly decreased.

Thus from the equation, $V = AT$ transposing as before

$$T = \frac{V}{A} = \frac{2.5}{5} = 1.25 \text{ sec.}$$

From the equation $S = \frac{1}{2} AT^2$ the space passed over is

$$S = \frac{1}{2} \times 2 \times (1.25)^2 = 1.5625 \text{ ft.}$$

Retardation will also bring the car to a full stop within the same distance and require the same length of time. Hence the space to be passed over by the car at full speed will be

$$S = 13 - (2 \times 1.5625) = 9.875 \text{ ft.}$$

The time required to traverse this distance at a car speed of 2.5 ft. per sec. is again given by the equation $S = VT$ transposed as follows:

$$T = \frac{S}{V} = \frac{9.875}{2.5} = 3.95 \text{ sec.}$$

The time required to complete the cycle will, therefore, be the sum of these or $3.95 + 2 (1.25)$, or 6.45 sec. This corresponds with point E on curve 2.

Curve 3 is based on a car speed of 300 ft. per min. and an acceleration and retardation each of 4 ft. per sec. By similar reasoning the time required to accelerate to a speed of 5 ft. per sec. is 1.25 sec. and the space passed over in this time is 3.125 ft. Retardation will be the same and the car will operate at full speed for $13 - 2 (3.125) = 6.75$ ft. At the given car speed the time required to travel this distance is 1.35 sec. Hence the time from start to stop is $1.25 + 1.35 + 1.25 = 3.85$ sec.

The important conclusions to be drawn are:

- (a) An increase in car speed with fixed acceleration and retardation decreases the trip time.
- (b) An increase in the acceleration or the retardation with fixed car speed decreases the trip time.
- (c) An increase in car speed, acceleration and retardation decreases the trip time, the effect being cumulative.
- (d) Maximum car speed will not be attained between floors unless acceleration and retardation are sufficiently rapid. The latter conclusion is borne out by examining the data from curve 1. The full car speed time is only 0.1 sec. With an acceleration of much less than 2 ft. per sec. it would take a longer

time to reach full speed and the distance passed over would be greater at the end of the accelerating period. Hence if full speed was reached and retardation immediately began the total distance passed over would be greater than 13 ft., the distance between floors.

The round trip time is dependent upon operating conditions. As an example they may be assumed to be as follows:

- Loading time at first floor, 60 seconds.
- Unloading time at second floor, 30 seconds.
- Loading time at third floor, 30 seconds.
- Unloading time at first floor, 30 seconds.
- Opening gates, 2 seconds.
- Closing gates, 3 seconds.
- Car speeds 150 ft. or 300 ft. per minute.
- Acceleration, 2 ft. per second.
- Retardation, 2 ft. per second.

The methods of computing the time required to complete the events has been shown. The results for the problem under consideration are given in the following table:

Nature of Event	Elevator Speed 150 Ft. Per Min.		Elevator Speed 300 Ft. Per Min.	
	Required to Perform Operation	Total Elapsed Time from Start	Required to Perform Operation	Total Elapsed Time from Start
Time in seconds to load at first floor	60.0	60.0	60.0	60.0
To close gate.....	3.0	63.0	3.0	63.0
Accelerate to full speed....	1.25	64.25	2.5	65.5
Run at full speed.....	3.95	68.2	0.1	65.6
Retard for second floor stop	1.25	69.45	2.5	68.1
Open gate second floor stop	2.0	71.45	2.0	70.1
Unload second floor stop..	30.0	101.45	30.0	100.1
Close gate second floor stop	3.0	104.45	3.0	103.1
Accelerate to full speed....	1.25	105.7	2.5	105.6
Run at full speed.....	3.95	109.65	0.1	105.7
Retard for third floor stop.	1.25	110.9	2.5	108.2
Open gate third floor stop..	2.0	112.9	2.0	110.2
Load third floor stop.....	30.0	142.9	30.0	140.2
Close gate third floor stop..	3.0	145.9	3.0	143.2
Accelerate downward to full speed	1.25	147.15	2.5	145.7
Run at full speed.....	9.15	156.3	2.7	148.4
Retard for first floor stop..	1.25	157.55	2.5	150.9
Open gate first floor stop...	2.0	159.55	2.0	152.9
Unload first floor stop.....	30.0	189.55	30.0	182.9

The full line curve on the diagram covers the foregoing data for the 150-ft. elevator plotted to scale. The dotted

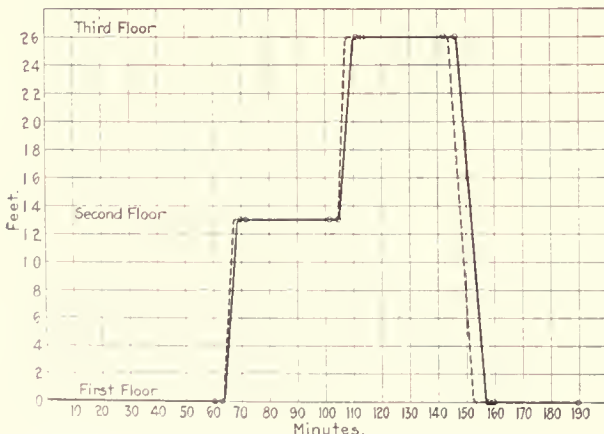

Round Trip Time Curves

line shows the data for the 300-ft. car speed. The important conclusions to be drawn from this particular case are:

- (a) The higher speed shortens the trip by about 3½ per cent.
- (b) The greater part of the time is required to handle the freight.

- (c) The freight handling time is independent of the car speeds, acceleration or retardation.
- (d) High car speeds are less important in freight service than in passenger elevators.

Size and Number of Cars

The important data required to determine the size of elevators are the maximum load to be handled, either in bulk or weight, and the time allowed for its dispatch. Consider the simplest case first; i.e., a single car to take the entire load.

The number of round trips required to handle the given volume of freight in a given time depends upon the round trip time assuming, of course the capacity of the elevator has not yet been determined. The elements entering into this have been considered in a general way in connection with the previous diagram. Assume that by some such analysis the trip time was determined, hence

$$\text{Number of trips} = \frac{\text{given dispatching time}}{\text{round trip time.}}$$

The answer must, of course, be the nearest whole number. If the given dispatching time was liberal any fraction may be disregarded, otherwise the next larger whole number would be selected as correct.

The car capacity is determined from the relation:

$$\text{Car capacity per trip} = \frac{\text{total capacity handled}}{\text{number of trips}}$$

Here the capacity must be considered from the viewpoint of either bulk or weight since, as will be shown later, these may differ widely.

The size of the car is obtained from the relation:

$$\text{Floor area of car} = \frac{\text{capacity per trip}}{\text{carrying capacity}} \text{ per square foot of car space.}$$

Since there is only one car to handle the load, the maximum waiting time equals the round trip time.

Before proceeding with consideration of the case where a number of cars are used to handle the traffic, it might be well to investigate some of the foregoing items in greater detail.

In tall manufacturing buildings where the inter-floor traffic is heavy the round trip time of a single elevator may become so great that the resulting delay and inconvenience would result in serious financial loss. If this is the case the computation of the losses involved is a simple problem in economics although for any given case the actual task of obtaining the detail data may require considerable time. In making elevator schedules much must be left to mere guess. However, some factors can be estimated and it is safer to do so wherever possible and leave for guess only such factors of the traffic problem as cannot be determined beforehand.

It has been suggested that the car capacity per trip depends upon either bulk or weight. A paper box factory manufacturing boxes in finished form offers a condition where the bulk is more important than the weight. The opposite extreme is the case of a foundry making small but heavy castings.

The carrying capacity per square foot of effective car space is dependent upon the method used in loading the car. For example, if trucks are to be used it will be the floor area occupied by the trucks, with a reasonable allowance for getting them on and off the car platform, in addi-

tion to the room required by the operator and the accompanying handling crew if there is such.

In the case of heavy freight it must be determined beforehand whether the material is to be piled or spread over a larger area. In general the nature of the freight will determine this and therefore no rules can be given. If the material is such that it might be stacked the time required to do this must be balanced against the increased cost of a larger platform where haphazard loading is permissible.

If passengers are to be transported with the freight, necessary provisions must be made. Great care should be exercised when heavy loads are placed on a car which also carries passengers. A large car is a temptation for overloading. For this reason, where heavy loading is possible an undersized car might be the safer choice.

The determination of area of car as given previously might not be feasible. It should be compared with the size of the hatchway which the structural layout of the building permits. In the case of steel buildings the distance between column centres varies from 15 ft. to 20 ft. This is determined by principles of economical construction. If the building is planned according to some standard basis of column centres, a change to accommodate the computed size of elevator hoistway may demand additional expenditure. Whether this expense is justified must be determined from standpoint of economics.

If the area of the car is such that it is not subject to structural limitations the form should be selected for convenience of loading and unloading. In general, for passenger service a wide and shallow car is better than a deep and narrow one. Much the same holds true for freight, but the depth should be convenient for the length of the trucks if these are used. The shape of the car is, of course, more important in freight service since passengers can adjust themselves to the standing room available. The choice of proper form appears simple when all the facts in the traffic problem are at hand.

The time which elapses between the signalling of the car and its arrival headed in the required direction is the waiting time. Excessive waiting time is costly and causes inconvenience which has a monetary value. Decreasing the waiting time and round trip time:

- (a) Increases the capacity of elevator.
- (b) Eliminates the idle time of handling crews.
- (c) Decreases the possibility of congestion of traffic.
- (d) Decreases the cost of loading on trucks, particularly if the trucks are on a busy street.
- (e) Decreases losses due to physical or chemical changes in process work; i.e., heating or cooling; drying out or absorbing moisture in cases of hygroscopic products; chemical changes such as contamination through contact with air; changes due to chemical reactions taking place between processes.

(f) Increases rental value of upper stories since these can be more promptly reached.

The inconvenience due to delay presents such phases as:

- (a) General feeling of unreliability of service.
- (b) Impatience in case of passenger traffic, since service is rated as to the waiting time; i.e., less than thirty seconds is first-class service, more than this is considered poor.

A single example of the influence of waiting time in a newspaper printing plant may be cited. There is a certain value attached to getting out an edition of a newspaper in the shortest possible time, particularly in large cities where competition is keen. This means, therefore, that the elevators must not restrict the continuous flow of papers

from the press floor to the shipping room. Failure of the elevator to do its share requires considerable storage space at its entrance due to the resulting congestion. Demoralized service under such conditions is usually much more serious than inadequate service in other processes.

Decrease in the waiting time can be accomplished in two ways, (a) increase the number of cars, (b) decrease the round trip time. Considering the latter case first, the original estimate of the round trip time might have been too liberal. At the stage of the analysis when this estimate was made it might not have been apparent that the number of elevators would become so important. A review of the factors entering into the round trip time might therefore warrant reconsideration. The important elements in the round trip time are the loading and unloading time. This might be decreased by better handling facilities or by improved traffic management. A review of these would be too general to be of value in specific cases. This study must be left with those responsible for the solution of the particular problem.

The permissible waiting time depends upon conditions previously noted. Given this time there results:

$$\text{Number of cars} = \frac{\text{round trip time}}{\text{permissible waiting time}}$$

Or if the choice is to be made on the basis of standard building construction:

$$\text{Number of cars} = \frac{\text{total effective area of a one car installation}}{\text{net area of car in standard hoistway.}}$$

Hence in either of the above cases:

$$\text{Required effective area of cars} = \frac{\text{total effective area of a one car installation}}{\text{number of cars.}}$$

Having determined the area of the car, the shape of the platform remains to be chosen. It was suggested previously that a wide and shallow car is better than one which is narrow and deep. The structural layout of the building may also effect the proper choice.

Economics

Three questions relating to elevator economics that immediately suggest themselves are whether the car size is to be fixed by special needs, whether the emergency use is of prime importance, or whether financial considerations are to be the determining factor.

The special needs exist when the elevator is a part of the transportation system and must be included as a link in that system. Or the car may be of a certain required size to handle manufacturing machinery at the time of installation or in the course of general maintenance of the plant itself. This may be the deciding factor and may call for a car of greater size than that dictated by normal or emergency needs.

The emergency use is the next factor which may fix the size and number of cars. In office building practice for passenger use the common rule is to provide for that number of cars which will handle the entire population in 15 min. When hazardous processes are carried on this time allowance may be too long and must then be adjusted to the special needs.

In case of fire the management of the traffic is important. It must be decided whether this is dependable under emergency conditions. The traffic on the floor where the fire exists should be cared for first followed by the traffic on

the upper floors, leaving that below the fire floor for the last.

The most economical arrangement from the viewpoint of cost is a problem of cost accounting, and may now be considered. Briefly, the cost of operation depends upon the fixed charges and the operating expenses. A broad though somewhat arbitrary analysis views the fixed charges as those which do not depend upon the traffic and the operating expenses as those which in some measure are proportional to the traffic. Of the fixed charges there appear the following factors:

- (a) Interest on the investment, on the actual cost and the cost of obtaining capital, engineering expenses, etc.
- (b) Rental value of space occupied by elevators.
- (c) Depreciation.
- (d) Obsolescence.
- (e) Insurance.
- (f) Taxes.
- (g) Management.
- (h) General overhead.

The operating expenses show as factors

- (a) Cost of power.
- (b) Cost of labor.
- (c) Maintenance.
- (d) Supplies.

The distinction between depreciation, obsolescence and maintenance deserves mention here. Every machine will wear as time goes on. If the repairs are such that the initial efficiency is unimpaired there is no depreciation. Repairs usually maintain a machine in operating condition, but the time may arrive when the cost of repairs reaches a point where it pays to discard the initial machine and replace it with a new one. The time between installation and replacement is known as the life of a machine and accountants usually estimate a certain percentage which should be set aside to refund the original purchase price when the life of a machine is terminated.

Obsolescence in this case is a term used for such classes of machines as become of lesser comparative efficiency because of subsequent improvement in their kind. As an example, suppose a certain type of machine is installed, the operating expense of which is a given sum. After a few years of service a new machine may be marketed which is so much more efficient that it does not pay to continue the use of the old one.

Another aspect of the question is shown by the following illustration. Suppose the case of a manufacturing establishment where all products are made by automatic machinery. If a plant is installed and the product marketed, after a given time a certain profit is made. Assume another manufacturer starting in the same business one year later but using an improved type of machine which reduces the production costs to such an extent as to offset the loss entailed by the deferred beginning. These conditions might mean that the former of the competitors must give up the business entirely. Here the obsolescence in one year is therefore one hundred per cent.

Applied to elevator practice the plunger type elevator costs about three times as much to operate as does the electric elevator for the same service and yet there is not sufficient justification to discard the original equipment and replace it with more modern types. When, however, the useful life of the elevator terminates the owner may choose a machine of the newer type and the problem is automatically settled.

Consider now the elevator with respect to its cost of operation. The elevator service determined from this viewpoint must perhaps be modified for any special or emergency requirements. The problem becomes simplified if each of the several equipments under consideration is investigated as to its total cost of operation including all items involved.

The general plan is to select the types of equipment which seems to fit best the needs of the problem. The cost of operation of the different plans is then determined. This is at best tedious work and the advisability of making such an analysis must be determined beforehand. Then consider the influence of the items which prolong the round trip time. In computing the cost of operation for these it is best to select a particular item and study it, holding the other variables constant so far as it is possible. Any attempt to treat the problem as a whole will result in confusion. Comparisons between various proposed plans can only be made when they may be reasonably well measured by known standards.

Location

Elevators are installed for freight, passenger, or combined freight and passenger service. In general, elevators should not be restricted to freight service, since the temptation to ride is often irresistible.

The normal service of an elevator is not always the determining factor. Plant equipment, maintenance and reconstruction may impose car sizes other than those best suited for the normal service. A large elevator invites overload and it is best to keep its size as small as possible, all factors considered.

The elevator service may be designed for one or more tenants. The simplest case occurs when one tenant occupies the entire building.

A survey of the plant transportation system may disclose the logical location of the elevator. This is to be considered with respect to the receiving of the raw material and the shipping of the finished product. If one elevator is to serve all purposes the just compromise will attach due weight to all the various factors. If the transportation system is sufficiently elaborate, separate elevators may be required each of which serves its specific purpose. In any event it should be possible to outline its duties and from this determine the amount of work that may reasonably be required of it.

If several elevators are used in any transportation system they should be grouped in banks as far as possible. The advantage of this arrangement is the decreased waiting time. When elevators are grouped there should be adequate standing room for passengers, goods, trucks, etc. A particularly poor arrangement is the case where the bank of elevators faces a wall with a narrow aisle as the only access.

Where traffic is heavy it might be found advisable to have elevators arranged to load from one side and discharge from the opposite side. This relieves congestion due to the interference of goods received and delivered. A coordination of design and management may be necessary in cases where the elevator is taxed to its utmost. Continuous service should be the aim in layout. Intermittent service does not permit efficiency in the handling crews.

As a general rule, a normal transportation condition will prevail. But for various reasons departures may occur. The elevator service must accommodate these abnormal conditions even if the service must suffer temporarily. A hope-

less tie-up of one element may demoralize the remainder of the plant.

In buildings housing a number of tenants, as in the case of loft buildings, it is necessary to estimate what character of service the tenants may require. In some localities buildings are devoted to particular purposes, such as printing, light manufacturing, etc. In installations of this kind a comparison with similar buildings suggests the service requirements. Adequate service should be provided, even under abnormal conditions.

Emergency Use

The elevator shaft is both a fire hazard and an agency for the saving of lives and property in case of fire. The fire hazard is due to the necessary communication between floors and the fact that the shaft, acting as a flue, directs the fire toward the hoistway.

The use of the elevator as a means of escape in case of emergency requires that its capacity should be adequate to provide at least for the passenger travel under these conditions. But it might better be large enough to accommodate also such merchandise of extremely high value as is stored in the building.

In city buildings it is assumed that the total population of the building can be moved in 15 minutes. For this reason, if the elevator is to be used as an additional means of escape it should not be located in the vicinity of hazardous processes.

Motive Power

The choice of motive power for an elevator is often subject to local conditions. In buildings where power is generated the choice lies between any of the commercial

Powder plants and cleaning establishments using highly volatile liquids might better eliminate electric power as a source of energy because of the danger of sparking at the contacts throughout the installation. Indeed the safeguards in such cases go so far as to avoid steel guides in the elevator shaft to prevent the sparks that might result when the car safety grips the guides. The steam, steam-hydraulic or the straight hydraulic equipment would be a better choice in such cases.

Gas and gasoline engines are used only in belted elevator equipments. These elevators do not admit of rapid starting and are therefore used only when the engine runs continuously, the starting, stopping and reversing being accomplished by a belt. Belted machines are also driven by line shafting.

Electric power is one of the chief sources of motive power. Its popularity depends upon its many inherent advantageous features. Electric control of elevators permits the use of many safety features not possible with other types of power. The nearest approach to electric power from the viewpoint of safety in ordinary installations is found in the hydraulic elevators.

Layout

Plan A shows an elevator location for a small manufacturing and warehouse building. It is provided with a single combined passenger and freight elevator. In this layout, a large centrally located door gives access to the elevator. The car may be arranged to open on one or two sides away from the building wall. This plan is quite common for buildings having a frontage on the street, as shown. The elevator engine may be located either above the hatchway or in the basement along the wall and near the hatchway.

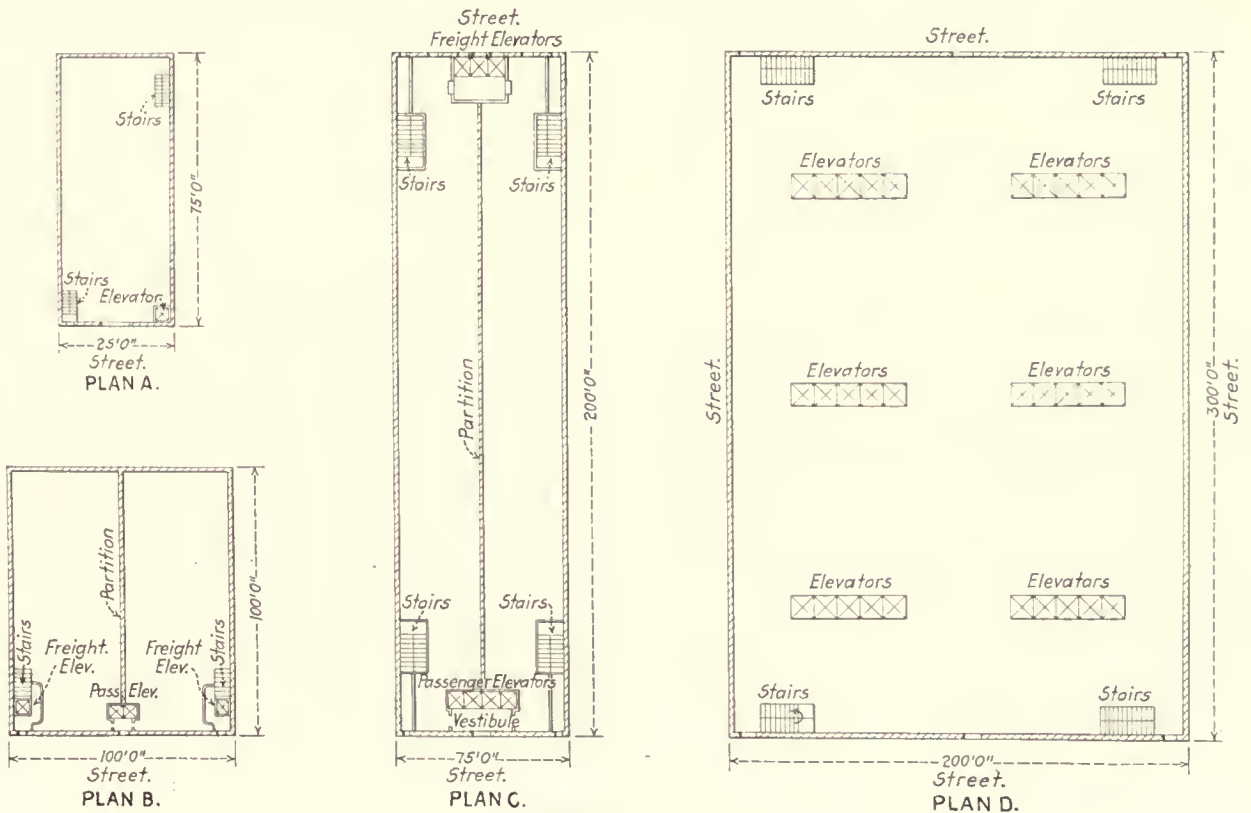

Typical Elevator Locations

types which the market affords. The solution of the problem is one of economics and the lowest cost of transportation between competitive systems must be computed.

A plan suitable for a combined office and manufacturing building is shown in Plan B. Here the floors are divided to accommodate two tenants each. The passenger service

is located convenient to the offices. The freight elevators must be located convenient to the street entrance and well toward the front of the building to prevent the waste of space in a long hallway leading to the elevators. They are accordingly located near the side walls of the building as shown. This arrangement encroaches upon the office space, particularly where the building is narrower than the one shown. Therefore the layout is suitable only when sufficient frontage is available.

Where the building is such that entrance is possible from two streets a separation of passenger and freight elevator service is possible. In plan C is shown an arrangement for excellent passenger service in a class of loft buildings where good office facilities are required. Here the freight elevators open directly to the street and are arranged to receive from and deliver to trucks. If one tenant occupies the floor the partition and vestibule to the freight elevators may be removed, thereby giving additional room.

Plan D is a layout for a large warehouse where the elevator service is a most important factor. Here are shown 30 elevators arranged in banks of five each. This plan lends itself to "central control" of elevators in which operators are not required on each car. It is used in connection with the trailer truck method of transportation. When the trucks are loaded and a train is made up, a central operator is signalled who dispatches a car to that point. When the elevator is loaded and all the gates are closed the destination is announced to the operator by telephone and the car promptly proceeds to the desired floor. The handling crew on this floor take charge of the train on its arrival. Such a layout is desirable where the handling is nearly continuous.

Power Consumption

A complete analysis of the power requirements of an elevator installation is a tedious operation. The hydraulic equipments were treated in detail by Brown* to which the reader is referred.

The electric elevators are not unlike the hydraulic elevator in this respect. However, there is this one difference—after the installation is complete the electric elevator is much easier to subject to test, since the necessary measurements are readily made. The important information needed to estimate the power requirements of elevator installations for purposes of comparison should be obtained before they are built. A general analysis for electric elevators will now be attempted.

The three principal losses are:

- (a) Motor efficiency.
- (b) Gear efficiency.
- (c) Inertia.

The motor efficiency depends somewhat upon whether they are to be used for direct or alternating current. The manufacturers of motors have available efficiency curves for proposed elevator equipment. Such data should give efficiency for all loads, since elevators are rarely subjected to constant load. This will determine the motor efficiency for any load.

The gear efficiency depends upon the type of gear reduction used; i. e., worm drive or herringbone gear. Where the motor is direct-connected to the driving sheave, as in traction elevators, this gear loss is entirely eliminated.

The very important item, particularly in high rise high

speed elevators, is the inertia of the moving masses. These masses must be accelerated at a given rate to bring them up to their proper speed. This energy in the high speed high rise elevators is a considerable part of the total energy required. On stopping this energy is absorbed by the brakes and is dissipated in the form of heat since coasting is not used in elevator practice.

Having a proposed layout of the elevator equipment at hand the pull on the lifting cables is due to the force required to accelerate, hoist the unbalanced load, overcome friction in the guides of both car and counterweight, and the air friction of the car and other moving parts of the system.

The pull on the cables due to the acceleration is the product of the mass and the acceleration of the car. The additional pull due to the load is dependent upon the unbalanced weight and is readily obtainable. The various friction losses must be estimated from tests on previous installations of a similar character. It is fortunate in this connection that windage losses are least at starting and become a maximum at full speed where the acceleration becomes zero. Having these three the total pull on the ropes is equal to their sum. This pull when multiplied by the radius of the driving sheave gives the torque which must be applied to the sheave shaft in order to exert this pull on the cables. If this torque is divided by the efficiency of

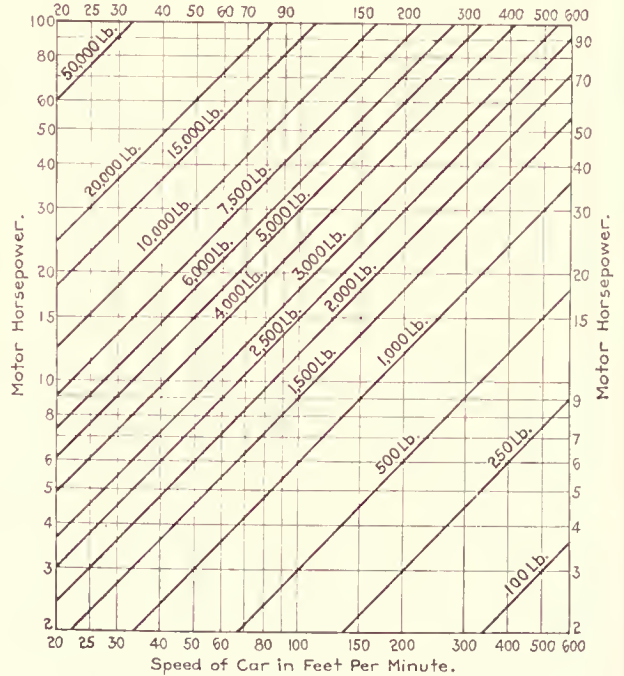

Chart for Determining Horsepower of a Motor

the gear it will give the torque which must be provided by the motor.

The required electrical input to the motor is obtained by dividing the torque at the shaft by the motor efficiency at the given load and speed.

It must be noted that all the foregoing quantities vary with the speed and the complete analysis involves considerable computation. The problem is made still more complicated by the inherent characteristics of the elevator control. The total power input to the motor must be that used in the motor and that lost in the starting resistances and other control apparatus.

*Passenger Elevators, Transaction of the American Society of Civil Engineers, Vol. LIV., Part B, 1905.

Fortunately, however, in comparing several elevators for the same service there are some elements in common and the analysis may be narrowed down to one, or at least a few elements.

When the elevator installation is made the energy of the moving masses may be found by a method described by Lindquist*, which, however, will not be given here.

For an approximate determination of motor sizes on electric elevators the following treatment may be used. The horsepower of the motor depends upon three factors—net weight to be hoisted, speed and efficiency of the elevator. The net weight in general is the weight of the car and the load less the counterbalance. The latter is the sum of the car counterbalance plus the overbalance. It is assumed that the hoisting cables are counterbalanced so that at any point in the shaft the cables are practically in equilibrium.

The losses due to all causes are assumed as 50 per cent. in the chart for determining the horsepower of the motor. To find the proper size motor follow the diagonal line corresponding to the unbalanced load up to the point where it crosses the vertical line corresponding to the required speed. The horizontal line through this intersection will give the

*Transactions of the American Society of Mechanical Engineers, Vol. 37, 1915.

required motor horse power. For example, suppose the net load is 2500 lb. and the car speed is 200 ft. per min., the intersection of these lines occurs at the horizontal line marked 30. Hence the required size of motor is 30 horsepower.

If the efficiency is known to be other than 50 per cent., say, 60 per cent, the required size will be five-sixths of this, or 25 horsepower.

In general the horsepower may be calculated from the equation,

$$\text{H.P.} = \frac{WV}{33000E}$$

H.P. = rated horsepower of the motor.

W = unbalanced load in lb.

V = speed of car in ft. per min.

E = efficiency of the system expressed in decimals
(i. e. 0.50)

As a check, compute the motor required for the previous case.

$$\begin{aligned} \text{H.P.} &= \frac{2500 \times 200}{33000 \times .60} \\ &= 25 \text{ approximately.} \end{aligned}$$

Electric Elevators

A treatise covering electric elevators can probably best be attempted by presenting a discussion covering the units—including motors, drives, controls, breaking, etc., which, combined, have made the elevator in its present high state of development possible.

Motors

The type of motor is either direct current or alternating current depending on local conditions. The voltages on commercial direct current circuits are 110-120 volts, 220-240 volts of 500-600 volts, the latter being common for trolley service. The more common voltage is 220-240 volts.

The alternating current voltages vary about the same as the direct circuit voltages, but the lower voltage (110-120) is not commonly used for elevator service. In addition to the voltage there are additional characteristics of alternating current circuits to be considered, such as frequency and number of phases. Common frequencies are 25 and 60 cycles per second. The phases are either single or polyphase, the latter being two-phase or three-phase. The two-phase current, moreover may be supplied by either three or four-wire circuits.

A desirable characteristic of any motor for direct drive elevator use is low inertia of the armature in the case of direct current machines and of the rotor in alternating current machines. Energy is supplied to the motor by the current taken from the line and is dissipated in the brake in the form of heat and every start or stop is a source of loss. For heavy exacting service, therefore, this loss requires attention. In general, the slow speed and the small diameter rotating elements are desirable features. These characteristics are known to motor manufacturers and have been given due consideration. Where several equipments are offered for the same service this item must be decided by the person responsible for the layout.

Direct current motors should be compound wound with from 10 per cent to 15 per cent of the ampere turns in the field at full load. The strong field thus secured is desirable

since it produces a good starting torque. This compound field is short circuited by the controller after starting the motor and it then continues to operate as a constant speed shunt machine. If elevators are used for speeds over 200 ft. per min. they should be provided with taps into the shunt field so that the field may be weakened, thereby increasing the speed. This is done automatically by the controller. The speed variation by field regulation amounts to from 40 per cent to 60 per cent of the full speed. Additional speed variation is obtained with resistances in series with the armature.

On high speed equipments dynamic braking is provided in addition to the mechanical braking. This is accomplished by either putting a resistor across the armature terminals or by throwing a low resistance field across the armature terminals. In the latter case the dynamic braking is proportional to the speed and therefore to the load, thus giving good stops under all conditions.

If dynamic braking is provided the motor should be able to commutate from 150 per cent to 200 per cent full load current without undue sparking. The shunt field of the motor must also be able to withstand about one-half of the line voltage continuously without excessive heating.

Interpole motors are suitable for elevator service when dynamic braking is provided. Their function is to neutralize the cross-magnetising effect due to the current in the armature. It is the distortion of the field due to the armature current which shifts the plane of commutation. If a field in the interpoles directly proportional to the armature current is provided no distortion of the main magnetic field results and the plane of commutation remains constant for all loads. Since dynamic braking requires the commutation of heavy armature currents this type of motor should be provided in such cases.

For the slow speed motors the solenoid brake is sufficient to bring the car to rest and the expense of the more complicated dynamic brake is not justified.

For alternating current service the induction motor is

most frequently used. For single phase circuits on freight elevators it is sometimes desirable to have the motor run in one direction, using two belts, one open and one crossed to accomplish the reversal of the car. The standard split-phase or repulsion-induction types of motors are unsuitable for elevator service. Service types of self-starting repulsion-induction motors which absolutely insure reversal of the motor when the connections are reversed quickly can be satisfactorily employed.

Special variable speed alternating current motors have recently been developed where the number of poles is changed, thus giving two running speeds. These may be used for elevators running over 200 ft. per min.

Alternating current motors have certain limitations which are not true of direct current machines, chief of which is the inability to get moderate changes in speed without serious changes in the torque. For the ordinary induction motor the speed at no load is nearly that of the synchronous speed corresponding to the frequency of the supply circuit. As the load increases the speed falls off slightly. This drop in speed divided by the synchronous speed expressed as a percentage is known as the "slip." If a motor has a slip of more than 10 per cent it is unsuitable for elevator service.

The two general classes of polyphase induction motors are the slip ring and the squirrel cage types. The slip ring type gives the best results. It starts smoothly because of inserting a variable resistance in the rotor circuit. Thus the heavy inrush of current at starting can be reduced to an amount comparable with the direct current motor. By varying this secondary resistance in the rotor circuit it is possible to maintain nearly constant speed at all loads; hence such motors have operating characteristics closely resembling those of shunt wound direct current motors.

Polyphase squirrel cage motors may be used where sufficient power and line capacity are available. Such motors take from two to three times normal current at starting. Hence they must be limited to sizes below about 15 horsepower. The particular objection to using such large starting currents lies in the fact that they cause a serious drop in the line voltage. If lamps and other motors are connected to the same circuit the lamps will flicker and the motors will momentarily drop in speed during the times of these heavy drafts of current. The starting torque of elevator motors should be at a maximum during the acceleration period. Accordingly the introduction of resistances in series with the squirrel cage motor to limit the starting current are not advisable since this also decreases the starting torque.

Winding Engines

The engines to be described consist essentially of a drum, an electric motor and the mechanical connection between the drum and the motor. Belted connection between motor and drum is considered elsewhere. In what follows attention will be confined to direct driven or at least positively driven equipments (i. e., exact gear ratio maintained between motor and drum).

The drums used for elevator service are made of cast iron and are scored to receive the cables. The form of the scoring is single, double or quadruple depending upon whether one, two or four lifting cables are used. The lifting cables are secured to the drum by means of thimbles and about one turn of cable around the drum. Since when the car descends the counterweights are lifted, and vice

versa, the counterweight cables may use the same grooves as the lifting cables. Thus when one set unwinds from the drum the other cables are being wound.

The mechanical connection between the motor and the drum may be chain, worm and wheel, spur gear, internal spur gear, herringbone gear or suitable combinations. Each form has advantages either mechanical, structural or financial. It is therefore not an easy matter to decide the best form. However, the record of good practice has done much to define the field of certain types.

The chain drive is suitable for the lighter loads. It is used in cases where a positive drive is required and the distance between shafts is too large for gearing. Chains stretch in service and their pitch therefore increases; hence the fit becomes less perfect as time goes on.

Spur gears are used only on the very slow speed equipments. This is mainly due to the noise caused by the backlash in the gears. A modification of the spur gear—the herringbone gear—preserves the rolling action principle of the simple spur gear but the additional smoothness of action and the high efficiency when properly constructed make it a desirable drive.

The worm gear has been a favored drive from the earliest elevators. However, the action is sliding and the necessity of good lubrication for such gears is important. The reason for using gear reductions of any kind on elevator motors is to take advantage of the lower cost of the higher speed motors.

The car speed depends upon the motor speed, gear reduction and the diameter of the drum. Each turn of the drum winds up a length of cable equal to the periphery of the drum; hence the car speed is equal to the peripheral speed of the drum. If the motor speed is known or can be measured and if the gear ratio is known the drum speed is easily determined. This drum speed in revolutions per minute multiplied by the periphery of the drum in feet gives the car speed in feet per minute. Thus, having specified the car speed desired the designer may vary the drum diameter, the gear ratio or the motor speed. As a result the drum type of elevator is special for nearly every installation. The length of the drum is dependent upon the total rise. Each revolution of the drum winds up a length of cable equal to the periphery; the number of turns, therefore, is equal to the total rise of the car divided by the length of cable wound per turn. Finally the length of the drum is equal to the pitch of the scoring multiplied by the number of turns required. An allowance of a full turn at each end is added since the cables usually have a full turn before they lift the load.

Worm Gear Winding Engine

In direct-connected worm driven winding machines the motor is of the direct current multi-polar type. Generally two brakes are provided on the extension of the armature shaft, the one nearest the motor being a solenoid brake, the other a mechanically operated brake. These winding machines are used with elevators having capacities ranging from 1,000 lb. up to 10,000 lb., or considerably larger than the average load on freight elevators. This type of machine is suitable for basement installation. A vibrator sheave may be used to guide the counterweight cables in the shaft and the drum may project into the shaft so that the lifting cables require no sheave to guide them on the winding drum. The machine may be arranged for hand-rop, lever or wheel control.

In the usual arrangement of a basement freight elevator a car of the simple platform type with access from two

sides is used and the lifting and counterweight cables pass over the overhead sheaves to the winding engine and counterweight respectively. The arrangement of counterweights is a matter of layout. As a general rule they are placed where convenient, after the location of car gates has been decided. The type of car illustrated is suitable for speeds not to exceed 50 ft. per min. The loads should not exceed 5,000 lb., but with suitable changes in the design the carrying capacity may be made much higher.

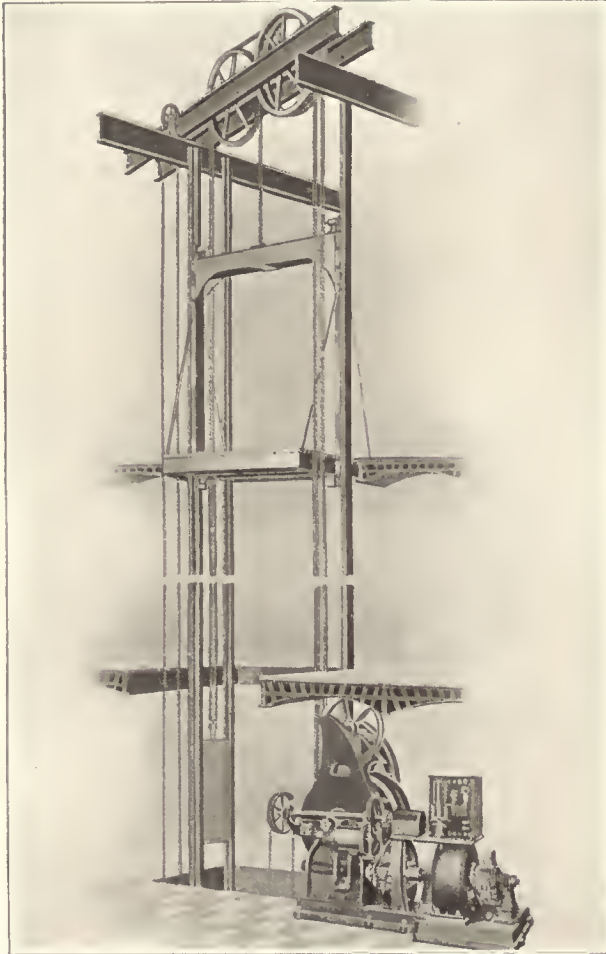

Worm Gear Winding Engine—Basement

For freight service an overhead installation has the particular advantage in that it requires less rope. The inertia of the cables is decreased and therefore also the power consumption. The increased cost of installing overhead may, however, be sufficient to make it advisable to locate the elevator in the basement, even with the disadvantage of increased power consumption. This is particularly true of heavy machines.

Chain Drive Worm Gear

Where loads are unusually heavy and may be operated at low speeds the gear reduction obtained by a single worm and worm wheel may be insufficient. One solution of this problem is the chain driven elevator in which a chain drive is used in addition to the worm and wheel drive. In a typical arrangement which is used when considerable gear reduction is desired and when the installation does not warrant the more expensive internal gear drive or even the herringbone drive the winding end is substantially the same as the ordinary worm drive and the chain sprocket is geared

to the motor pinion adjacent to the drum. The control is obtained by means of a cable actuated by hand-rope, lever or wheel in the car.

Internal Gear Worm Drive

The chain drive engine just described showed a method of acquiring gear reduction in addition to that obtained by the simple worm drive. Another solution of the same problem is offered by the internal geared engine, where the

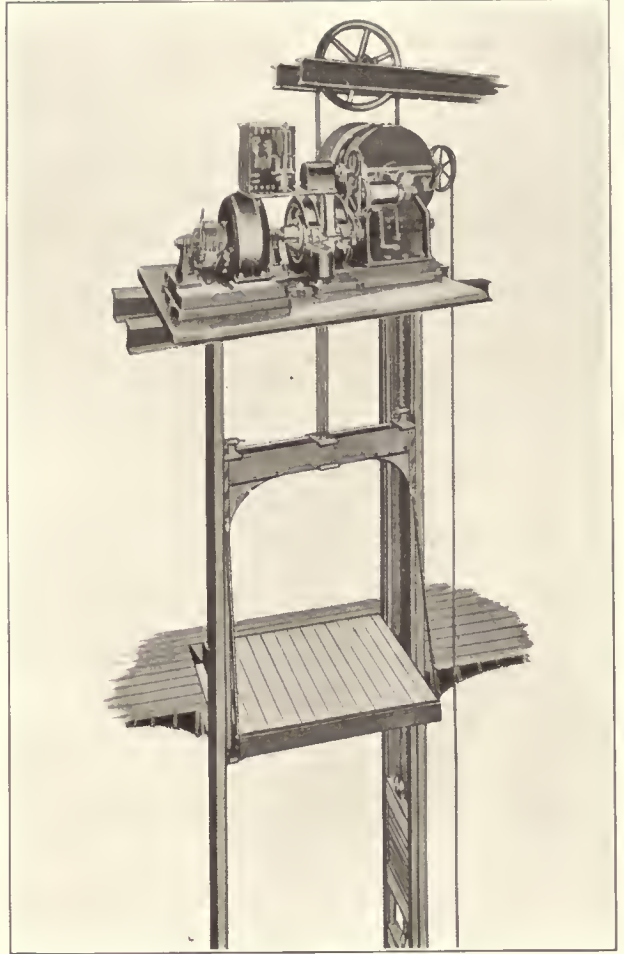

Worm Gear Winding Engine—Overhead Installation

motor drives the worm and worm wheel in the usual way, but the worm wheel shaft carries a pinion which meshes with the internal gear on the winding drum. The elevator is arranged for some form of mechanical control and also provided with a mechanical brake.

Tandem Gear Winding Drum

Where the loads or the speeds are too high for a single worm and worm wheel reduction tandem gear may be used. The motor should be entirely enclosed when used in places where moisture or dust prevail. In such cases a portion of the heat generated by the motor must be dissipated by radiation from the outside surface of the motor. Thus enclosing the motor reduces the capacity seriously; accordingly installations of this kind demand larger motors for the same work. When such installations are under advisement the motor manufacturer should be informed so that a motor will be furnished of such size that the temperature of the interior shall not rise to a point such as to destroy the insulation of the windings.

With the worms cut right and left hand the end thrust which is always present in single cut worms is eliminated. A thrust bearing is always provided on simple worm drives to take up the thrust.

Back Geared Winding Drum

Where a normal elevator service prevails and in addition emergency needs require the lifting of safes, machinery and other heavy loads a back geared type of winding machine may be used. For normal service the motor is connected directly with the worm and operates the same as the ordi-

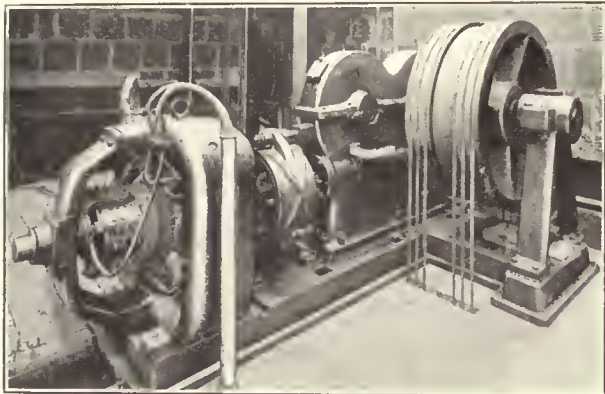

Tandem Gear Traction Elevator Engine

nary worm gear winding machine. If a heavy load is to be hoisted the back gears are thrown into service and the direct drive of the armature shaft and the worm shaft is uncoupled, thus securing a greater gear ratio and the same motor is enabled to lift heavier loads at a corresponding reduction in the speed. A return to normal service is brought about by reconnecting to the original arrangement.

Generally the engine is equipped with a double set of solenoid brakes for the heavy service conditions. Both brakes may be used for normal service, but in that case adjustment for heavy service may give too rapid a rate of retardation for normal service. In this event the pressure between the brake band and the face of the flanges must be decreased.

The back geared elevator described offers a solution in circumstances where the heavy freight service is not sufficiently in demand to warrant the installation of a separate machine for such service. If a single outfit is used the cables should be designed for the heaviest loads it is intended to lift.

Herringbone Gear

The speed reduction of a worm drive is subject to many limitations. For the same distance between shafts spur gears permit greater freedom in establishing suitable gear ratios, but spur gears are noisy and for continued severe service must be cut with extreme accuracy and be maintained thus in service. Even very slight departures from correct tooth forms cause variations in tooth pressure which may reach several times normal tooth pressures. The destructive action under such conditions argues against the use of simple spur gears for elevator service.

The rolling contact of spur gears is an advantage and is preserved in the modification known as the "herringbone" gear. Here the double slope of the teeth eliminates side thrust and the helical disposition of the tooth face insures continuity of tooth action. When well cut these gears are highly efficient but correspondingly expensive.

An important difference in worm drives compared with

herringbone (or spur gears in general) is that in worm drives there is sliding motion while in the herringbone gear the action is principally rolling motion. Worm drives require great care in their lubrication since with the

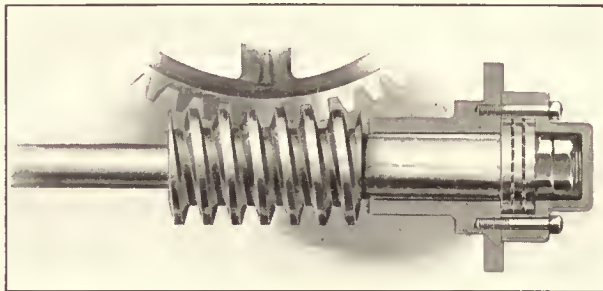

Single Gear and End Thrust

usual thread angles (lead) the load slides a greater distance than it lifts. In herringbone gears were it not for the deformation of the tooth under load and the inaccuracies in gear cutting the action would be that of pure rolling. However, departures of this kind introduce some sliding

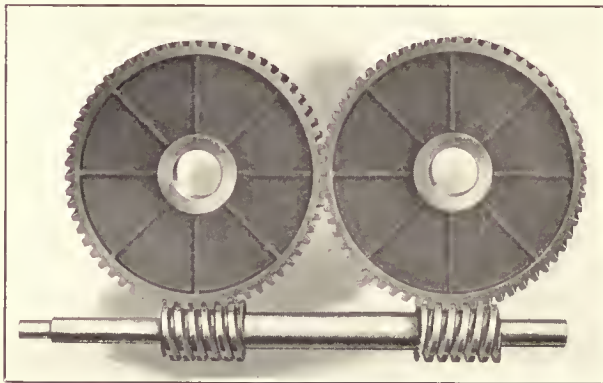

Tandem Gear

and such gears also require lubrication. Nevertheless, imperfect lubrication is less important on herringbone gears than on worm drives.

Electric Traction Engines

The traction elevator, as shown in the illustration, consists essentially of a car, a counterweight and the driving sheave or sheaves, which are usually driven by an electric motor. The cables are made fast to the car and pass over a grooved driving sheave, then down and under an idler sheave, returning in separate grooves over the driving sheave and down to the counterweight. A considerable pressure is produced between the cables and the drive sheave, due to the loads on the ends of the cables (i. e. car and counterweight). The frictional resistance between the drive sheave and the cables must be overcome to lift the car. The underlying mechanical principle of the traction elevator is identical with that in the ordinary belt drive.

For low rise elevators should the car or counterweight "bottom," the cables slacken and reduce the pressure between cables and grooves and thus reduce the traction much the same as a slack belt on a driving pulley. This will in most installations prevent the car or counterweight, whichever happens to be at the top, from running into the overhead beams. On very high rise elevators the effective-

ness of this safety feature decreases since the weight of the cables may be sufficient to produce the necessary traction to bring about the dangerous overtravel.

Traction elevators may be used for any rise with less complication than the winding drum type machine. In the

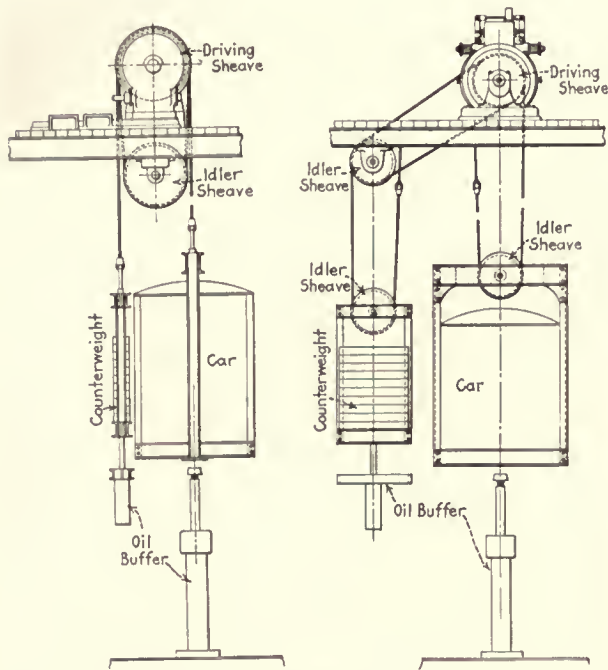

Roping for Traction Engines

case of the winding drum, having given the gear ratio between motor and drum, the car speed is fixed by the diameter of the drum. Doubling the diameter of the drum, other things remaining the same, doubles the car speed. The length of the drum is directly proportional to the rise of the car. Hence in winding drum installations each equipment is more or less special since economical car speeds and rises vary widely. For the traction machine, with any given gear ratio the car speed is also nearly proportional to the diameter of the driving sheave.

Traction elevators may be either gearless or geared. The gearless elevator may be one-to-one (1:1) or two-to-one (2:1) rope geared. The simplest form of the drive is the one-to-one. Where it is desired to save on the cost of the motor the two-to-one permits the use of a motor of twice the speed if the driving sheave and the car speed remain the same. For the same horsepower output the cost decreases with increase in speed of the motor.

The geared machines used either worm or herringbone gears. They use higher speed motors than the gearless and are therefore less expensive. It is intended that the decrease in the initial cost will compensate for the increased cost of operation due to the gears. Whether it does, must be determined by investigation.

One-to-One Gearless Traction Engine

Traction elevators when used for high speed service are usually of the one-to-one ratio. With the same mechanism the car speed may be reduced to one-half this speed by means of a two-to-one ratio.

The particular characteristic of the one-to-one type is that the car is suspended directly from the rope as it leaves the driving sheave. Thus the peripheral speed of

the driving sheave is the same as the speed of the car except for the slight influence of the slip of the cables.

Two-to-One Traction Elevator

A diagrammatic illustration of a two-to-one traction equipment is depicted. Here the cables from the drive sheave pass over a sheave secured to the car and the free ends are fastened to the beams which support the engine overhead. The counterweights are roped in the same way. Under these conditions the car speed is practically one-half of the peripheral speed of the driving sheave.

Spur Geared Traction Engine

Geared machines are used when it is desired to take advantage of the low cost of the high speed motors used with geared equipments. With these the energy stored in the revolving armature is greater than with the slower speed motors and hence the current consumption is greater. Also

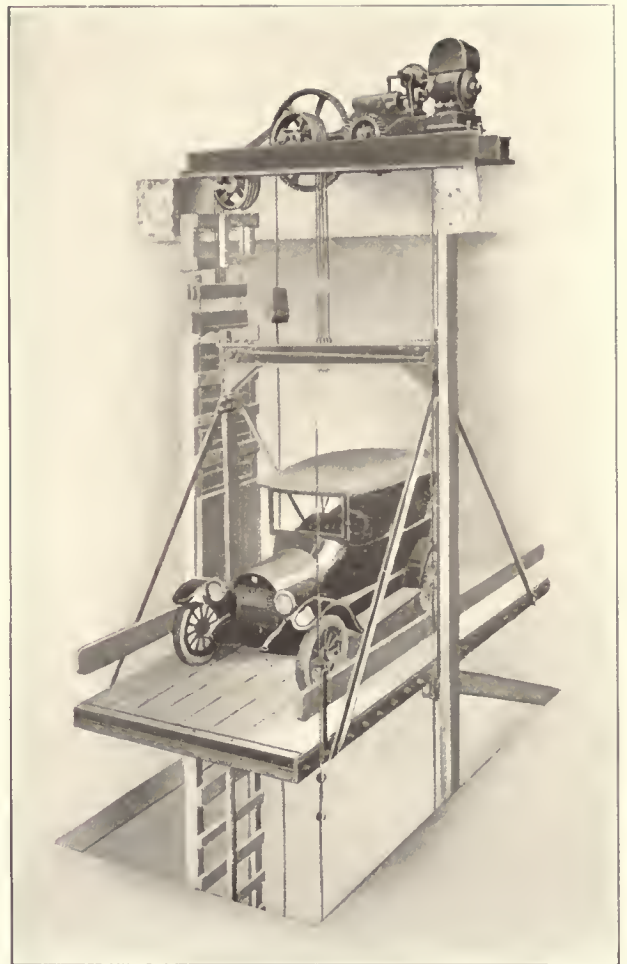

Spur Gear Traction Engine

since more energy is stored in the armature the brakes must be designed to dissipate more of the kinetic energy. Since this dissipation of energy by means of the brakes is accompanied by wear the life of the brakes is shortened in the high speed motor equipment. The simple type of spur geared automobile elevator illustrated is used on slow speed equipments where the noise of the gears is not objectionable.

Worm Geared Traction Engine

For smoother action than that obtainable with spur gears a worm drive may be suitable. This permits a low cost

motor to be used and gives operating speeds from 50 ft. to 150 ft. per min.

Internal Gear Worm Drive Traction Engine

As in drum winding engines the internal gear in addition to the worm drive is used to give greater gear ratios than those obtainable with the simple worm drive. These equipments are used on slow speed elevators for heavy loads.

Where the duty is heavier or the speed is greater than that which is safe practice for single worm gear drives the tandem arrangement offers a solution. The idler sheaves may be placed below or overhead, the latter arrangement being suitable for basement installations. These elevators are used for car speeds as high as 450 ft. per min.

Herringbone Gear Traction Engine

The desirable qualities of herringbone gears have previously been mentioned. The use of the high gear ratio permits the use of high speed motors and yet brings the cost of the elevator installation within commercial limits in cases where gearless outfits might be out of the question.

Belt Drives

Belted elevators are used where the loads are sufficiently heavy to be inconvenient for operation by hand-power but where the greater expense of direct-driven power elevators cannot be justified. They are made for operation with a single or a double belt.

When a single belt is used it is necessary to install a reversible motor so as to enable the car to travel up or down. If power is taken from a line shaft which cannot be reversed the up and down travel of the car may be accomplished by the use of a double belt elevator. Here the belts are arranged so that an open and a crossed belt are used.

In the illustration of a single belt electric elevator depicted the motor and the machine are shown on the ceiling. The motor is started and reversed by means of a hand-

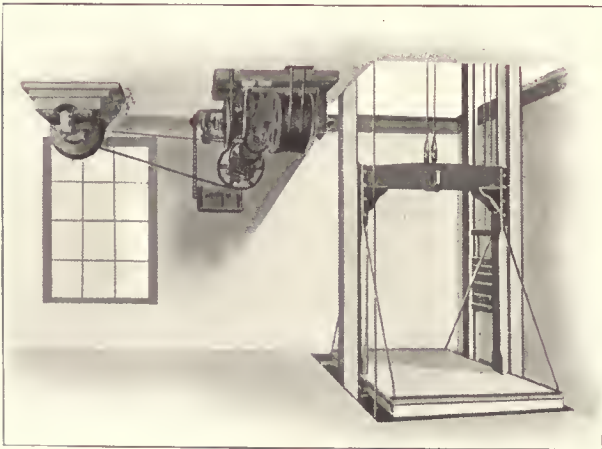

Single Belt Electric Elevator

rope in the shaft, which operates the controller. The motor drives the pulley which is keyed to the worm shaft. A worm and wheel afford additional means of speed reduction to the speed reduction obtained by the difference in the pulley diameters on the motor and on the worm shaft.

The worm wheel is keyed to the shaft on which the drum is keyed. The drum is scored to receive the hoisting and counterweight cables and the helical winding of the ropes on the drum is accomplished without danger of chafing.

The machine shown is equipped with a mechanical brake. There is also a traveling nut device to open the motor circuit when the platform reaches either of the terminal landings. Additional safety features may be added. The one commonly used is the rope-lock described elsewhere. Several of the devices considered under the heading of electric control may be used in connection with these elevators. However, since belted elevators are used for slow speed freight service (less than 100 ft. and usually from 30 ft. to 50 ft. per min.) and in low cost equipments the control refinements are ordinarily reduced to a minimum.

In the floor winding engine of the double belt type described the engine consists of a drum shaft on which are located the winding drum and the worm wheel. The car and counterweight cables are wound on the scored winding drum. The operating rope is secured to the shipper wheel shown in front of the drum. The projecting pins on the shipper wheel engage in forked fingers secured one to each of the two horizontal rods near the base. Turning the shipper wheel permits the operation of only one of the belt shifters.

The worm, brake and three pulleys are located on the worm shaft. The two outer pulleys are loose on the shaft and the centre pulley is keyed to it. On the motor or line shaft is secured a pulley of the same width as that of the three pulleys on the worm shaft. Two belts are used, one open and the other crossed, the width of each being somewhat narrower than the pulleys on which they operate.

In the position of rest the two belts run loosely on the idler (outer) pulleys. If the operator wishes to start the car he pulls the hand-rope, which in turn actuates the shipper wheel on the drum shaft extension. This releases the brake and causes only one of the belt shifters to move so as to slide the belt onto the centre or driving pulley. To stop the car the hand-rope is moved in the opposite direction, the shipper wheel returns to the central position, shifts the belt back to the idler pulley and finally applies the brake. The car will then come to a stop in a time dependent upon the pressure which the brake applies.

The safety features usually included consist of the rope lock, slack cable stop and limitation stop at extreme landings.

Control may be secured by means of rope, lever or wheel. Where hand-rope is used the speed is fixed by the Safety Code at 50 ft. per min.

Braking

The two braking methods commercially used in elevator practice are accomplished by mechanical and by electrical means. On all slow speed elevators the mechanical brake alone is used. For speeds over 100 ft. per min. dynamic braking is used in addition to the mechanical braking. Practice varies considerably in this respect because of the varying conditions of operation. For example, if the service is reasonably constant it does not pay to open the field circuit every time the elevator is brought to a stop. In the ordinary compound wound direct current motor the torque on the shaft is proportional to the field strength and to the armature current. In the building up of the magnetic field the inductance of the field winding limits the current passing through it, which in turn limits the field strength. Thus at starting when the field is weak the armature current must be increased for a given torque. The armature losses vary with the square of the current input for constant resistance in the armature circuit. The point to consider, therefore, is whether the saving in the electric

energy by interrupting the field during the periods of rest compensated for the decreased armature losses due to the smaller starting currents when the field is continuously in circuit.

Mechanical Brakes

The mechanical brakes used in elevator practice are almost invariably of the shoe type. The brakes when normally applied are held by springs or weights and are released mechanically or electrically just preceding the admission of current to the armature of the elevator motor. The general practice is to use a solenoid to release the brakes and a spring to apply them after the solenoid is de-energized, although an electric motor is sometimes employed in place of a solenoid.

In the direct current types of solenoids two styles of winding are available, namely the shunt and the compound. In the shunt wound magnet a single coil is connected across the line to release the brake. In the compound wound there are two coils in the same frame, a shunt and a series coil. The shunt coil is connected across the line, while the series



Brake for Elevator Machine

coil is in series with the armature. After the brake is released by the combined action of the two coils, the series coil is cut out of circuit by the controller, while the shunt coil is left connected across the line to keep the brake released. With the compound winding, greater pull is obtained with the same magnet frame than with the plain shunt winding. The compound winding can only be used where the controller is provided with contacts for cutting the series coil out of circuit when in the full speed position.

When alternating current is used in the solenoid the cores of the magnet must be laminated to decrease the heating due to hysteresis of the iron. It is necessary in alternating current magnets to specify both the voltage and the frequency at which they are to be used. These magnets are shunt wound only.

Alternating current magnets have certain characteristics not found in direct current magnets and their use requires

special precautions. The pull feature of direct current magnets makes them more suitable for brake service than alternating current magnets. With direct current magnets the pull increases as the stroke decreases, thus insuring a greater pull as the brake spring tension increases. With alternating current magnets the pull is practically constant throughout the stroke. This characteristic should be taken into account when designing a brake mechanism for this type.

The best design of brake mechanism is one which utilizes the full pulling power of the solenoid throughout the stroke. Moreover, it is just as important that the magnet selected should not be too large for the brake, as that it should not be too small. If the magnet has considerable excess power there will be a tendency for the plunger to pull in with an excessive hammer blow. This will not only make it noisy in operation, but will unduly strain the magnet and the mechanical transmission system, in addition to requiring a larger amount of power than is necessary.

Particular care should also be exercised in mounting these magnets on the brake mechanism to avoid all side strains on the plunger. Any undue side pull on the plunger will prevent its seating squarely against the plug and will cause a chattering noise in its operation.

The fact that alternating current magnets act much more quickly than direct current magnets causes them to offer considerable inertia when the limit of travel is reached. The moving parts used with these magnets must therefore be light so as to reduce this inertia to a minimum.

Dash pots have been used to dampen the action of the alternating current magnets for brake service, but with generally unsatisfactory results. To overcome this there has been devised a type in which the magnet is immersed in oil contained in a cast iron pot. It is attached to the brake mechanism of a drum winding machine.

The humming noise characteristic of alternating current brake magnets is objectionable and where this annoyance is serious a motor-operated brake is to be preferred. It consists of a shoe brake having an operating lever equipped with a toothed sector. A pinion on the brake motor shaft engages with the sector on the operating lever so that when the brake motor revolves, it releases this brake. The brake is held released as long as power is applied to the elevator motor by the small torque motor although its rotor is stalled. A spring returns the operating lever and applies the brake on interruption of the power.

Dynamic Braking

For high speed cars the energy to be absorbed in the electro-mechanical brake may be so great as to cause excessive heating or it may require a brake mechanism of unduly large proportions. A part of this energy may be dissipated in direct current machines by causing the motor to act as a generator and short-circuiting it through a suitable resistor. This requires that the field should be on all the time and this must therefore be taken into account in the design of the motor itself.

On compound wound motors the field strength is proportional in some degree to the current flowing through the armature and the series field coil. Thus at high speeds the current is dependent upon the speed and the dynamic braking effect is proportional to the speed. This is a desirable characteristic and permits the graduation of the dynamic effect in proportion to the speed and therefore to the load. Hence good stops are possible under all conditions of load.

The controller must be suitably designed to include this

feature. The dynamic brake switch upon closing establishes an armature shunt circuit, thus electrically loading the motor. The switch is closed by a coiled spring and is opened magnetically. It is therefore independent of the power or the counter-electromotive force of the motor for its closing. In case of interruption of the coil circuit either by normal operation or because of accident to the coil or the wiring to the coil, it will close and establish the dynamic braking circuit. Because of the load thrown upon the motor, commutation should be provided for from 150 per cent to 200 per cent of the normal current required by the machine. The higher values occur at the higher speeds since then the energy in the moving elevator system is greatest. It has been shown that interpole motors are satisfactory for dynamic brake service.

Control of Electric Elevators

Elevator control requires a mechanism to start and stop the car and sometimes to control the speed within limits fixed by the characteristics of the controller. The type of controller depends upon the particular service requirements and will be considered later. The two general types of control are accomplished mechanically or electrically.

Mechanical Control

With mechanical control the elevator is belt driven or direct connected. The belted elevator may be operated by a single or a double belt. In the single belt type it is necessary to use a reversible motor to permit the car to move up or down. With the double belt the motor need rotate in but one direction since the use of an open and a crossed belt performs the reversal of the direction of the car. Where a double belt is used a belt shifting mechanism is, of course, required.

On direct connected equipments mechanical control may use either a mechanical or an electro-mechanical brake. If a mechanical brake is used it is necessary to provide the control with means to release the brake before current is turned into the motor so as to relieve it of the unnecessary load imposed when the brake is set. Where an electro-mechanical brake is used the current releases the brake either by means of a motor or more commonly by means of a solenoid.

The control from the car is accomplished by means of a cable which may be actuated by either hand-rope, lever or wheel. The hand-rope is limited to slow speed cars. The Code of Safety Standards permits the use of a direct hand-operated rope, cable or rod for freight elevators not to exceed 100 ft. per min. Speeds higher than this are not controlled reliably by such means.

Lever or wheel control is permitted by this code for speeds up to 150 ft. per min. except on hydraulic elevators. Where the hand-rope is found undesirable the electric control is used in preference to the lever or the wheel mechanism.

Types of Electrical Control

Electrical control is used principally on direct-connected machines. Its use on belted machines introduces a complication which is not justifiable when the more reliable standard devices are considered. The various types of control are car switch, push-button, dual control and central control.

Car Switch Control

Car switch control is used where an attendant is employed to operate the elevator. This places the movement

of the car entirely in the hands of the operator. It is used both for passenger and for freight service, particularly if the car speeds are high.

The equipment consists of a switch or controller located in the car and a number of auxiliary devices which are described in another place, a controller located in the machine room, and the necessary electrical cables to establish the circuits.

Push-Button Control

Push-button control of elevators permits of automatic operation by means of push-buttons in the car and at the landings, thus dispensing with the services of a regular operator. This kind of control on passenger elevators, freight elevators and dumb waiters is desirable where the demand for service does not warrant the expense of an operator. The condition is found in such places as private homes, small family hotels, or apartment buildings and other small semi-public buildings.

A more complete description of the service and the equipment used in connection with push-button elevators will be given later.

Dual Control

Dual control is a combination of car switch and push-button control. It is desirable in places where it is necessary to use an operator for the busy traffic and dispense with his services when the traffic becomes infrequent. These conditions are found in such buildings as small hotels, clubs, apartments or office buildings.

When the operator leaves the car and it is desired to continue operation as a push-button elevator, a throw-over switch is shifted. The car then operates in a manner similar to the push-button elevator.

Central Control

The important characteristic of central control is the fact that several cars are directed by a single operator from some central point. It is used in such places as warehouses where many elevators are installed in banks. Here the elevator is signalled and dispatched to the point desired. The car is loaded and another signal is given the central operator who dispatches the car to its destination after the gates have been properly closed. Upon arrival the unloading crew takes charge and removes the material, when the gates are closed and the "central" is signalled indicating that the car is ready for another trip.

Additional Control Features

Aside from the control features subject to the will of the operator all classes of electric elevators have one or more automatic devices used to control acceleration, speed, retardation, etc. The list which follows is more complete than required for ordinary freight service. High speed passenger services includes greater refinements and more of the features are required for it. They include:

- (a) Slow-down at terminal landings independent of the operator to permit good stops.
- (b) Automatic return of the car switch to the "off" position when released by the operator.
- (c) Automatic stop switch on car for stops at terminal landings in case the operator tries to overrun the landing.
- (d) Final cut-out limit switches in hoistway operating independent of the automatic stop switch.
- (e) Slack cable switch on car or counterweight to prevent unwinding of the cable when either reaches the lower landing limit.
- (f) Switch operated by centrifugal governor to stop

the car automatically in case of overspeed; the first switch shuts off power and applies the dynamic brake effect on the armature of the driving motor and the mechanical brake on the brake pulley; the second switch applies a light retarding force on the car safety when equipped with an electro-mechanical safety.

(g) The safety switch in the car and under the control of the operator performs the same function as the two switches operated by the governor.

(h) Regulation of the shunt field by a centrifugal governor to maintain constant full speed with variable loads.

(i) Oil buffers stopping the fully loaded car when descending at 50 per cent excess speed.

(j) Reverse phase relay on alternating current circuits to stop the motor in case of power failure of one or more phases.

Electric Elevator Auxiliary Devices

In addition to the controls already described there are numerous auxiliary devices in common use. These include, the reversing switch, car switch, stack cable switch, door safety switch and other switches which are described below.

Reversing Switch

One type of reversing switch used on semi-magnetic controllers has a wheel or lever attached to the projecting shaft and is operated from the car by means of a rope, lever or wheel. When the drum reverse switch is thrown into the running position it closes the control circuit and magnetic line contactor. This releases the brake and starts the motor with full voltage on the shunt field and all the starting resistance in the armature circuit. The motor automatically accelerates to full speed by the gradual cutting out of the starting resistance. In addition the short-circuiting of the series field is accomplished by means of magnetic contactors on a controller which must be used in connection with it.

The rate of acceleration is dependent upon the motor load. The lighter the load the less time it takes to accelerate to full speed. For the sake of comfort the rate of acceleration should therefore be adjusted to meet the condition of light load if passengers are to be carried on the car.

When the drum is thrown to the "off" position the main line contactor opens before the contacts on the drum reverse the switch. Thus no arcing occurs on the main contacts. In the "off" position the controller disconnects the motor and the brake magnet from both sides of the line.

The switch may be located in any place convenient to the shipper rope, either on the wall, machine or on the controller itself.

Machine Limit Switch for Drum Winding Machines

Car switch controlled drum type elevators are usually equipped with a machine limit switch. This is geared to the winding machine to provide means for automatically stopping at the top and bottom landings. These limit switches open the control circuit of the magnet switches on the controllers. If the controller is equipped with a slow-down feature at terminal landings the machine limit switch will do this automatically.

If a traveling-nut mechanism is provided on the elevator machine the rotating cam type of limit switch may be used. This type of switch has single pole contacts for the slow-down feature at terminal landings and double-pole contacts for stopping the elevator. The switch is so arranged that when the traveling nut of the winding machine engages a yoke at the positions corresponding to the top and bottom landings, its shaft is rotated so as

to open the proper contacts. As the car moves away from these extreme landings the traveling nut backs off and releases the yoke. A weight and chain centering device returns the limit switch to the normal operating position. The cams for the final stops are keyed to the shaft since these are fixed limits, while the slow-down contact cams are left adjustable.

Traveling Cam Limit Switch

If a traveling-nut mechanism is not supplied with the elevator engine the traveling-nut type limit switch may be used. This device combines the functions of the ordinary traveling-nut mechanism and a machine limit switch. In application it is geared directly to the shaft of the winding drum. It is equipped with two double-pole snap switches for each limit of elevator travel. The threaded operating shaft carries a traveling nut which moves from one end of the shaft to the other for the full travel of the elevator from bottom to top landings. The nut engages with cams which operate the switches at the limits of travel. The four double-pole switches are adjustable on their supporting rods and are to be positively locked after adjustment so as to maintain their proper position in use.

Machine Limit Switch for Traction Elevators

A characteristic peculiar to winding machines is that a given number of revolutions of the drum corresponds to a fixed position of the car in the shaft. Limit switches actuated by the drum with a given gear ratio may be used instead of hatchway switches.

For traction machines, because of the slip of the cables over the driving sheave, there is no fixed relation of the car position and the number of rotations of the sheave. Hence limit switches geared to the motor are useless. The limit switches for automatic slow-down and final cut out must be located in the hoistway. These are attached to the car and operated by a cam in the hoistway and perform the same function as the limit switches previously described.

Hatchway Limit Switch

Like the machine limit switch this also must be located in the hatchway for similar reasons. It is operated by a cam on the car and may also be used for any type of electric elevator.

Car Switch

The elevator car switch is used with all full magnetic type controllers where an operator is employed. Where necessary the switch is provided for three speeds in each direction, slow-down, normal and high speed. The slow-down speed is required in order to permit good stops.

It also permits "inching" towards a landing in case of poor stops.

Where a relay is provided on the controller for overload protection, a maintaining coil for this relay is energized when the car switch is in the running position by means of contacts provided for the purpose. After an overload occurs, it is impossible to operate the elevator without first returning the car switch to the "off" position which resets the overload relay.

The construction used varies with the manufacturer. One type of car which is mounted on a pedestal convenient to the operator. It is so constructed that each of the speeds is positively selected by the operator. A "dead man's handle" or spring return is included so that in case the operator removes his hand the lever will return to the "off" position and immediately bring the car to rest. This feature is of value in cases of illness or accident

to the operator when a panic might ensue should the car continue on its journey. However, should the car proceed the other limit switches usual in elevator practice would act. Though these may not be apparent to the passenger, in the stress of such emergency they would bring the car to rest at the top or bottom landing. When once at rest the accidental starting of the elevator from any cause is impossible for it is necessary to release a spring latch before the handle can be moved.

Car Safety Switch

A car safety switch is used in connection with the car switch described. It is mounted near the operator for his convenience. The switch is single pole and is connected with the control circuit on the side of opposite polarity to the car switch so as to provide a safety stop regardless of any possible combination of grounds in the control cables. Any ground serious enough to interfere with the operation of both the car switch and the safety switch will render the elevator control equipment itself inoperative.

The switch has an "on" and "off" position so that in case the operator is momentarily away from the car, tampering with the car switch by passengers will not cause it to start.

Slack Cable Switch

There is the possibility of the cables slackening due to the car or the counterweight becoming caught in the guides. Under these circumstances the unwinding of the cables by the motor would continue thus permitting the sudden drop of the counterweight or car should the hindrance give way. This may induce a considerable stress in the cables which may overstain them and perhaps break them. Slack cables may also result from excessive swaying which may cause the cables to jump their sheaves. To guard against these possibilities a slack cable switch is located in the machine room so that a small amount of slack will trip the main contactor thus automatically opening the control circuit and bringing the car to rest.

The switch is a double-pole quick-break switch, purposely designed so that it will not reset when the cables again are subjected to tension. This requires someone to inspect the mechanism, correct the trouble, and if in satisfactory condition to reset the switch after which normal operation may be resumed. It may be used in connection with the semi-magnetic or full magnetic type of controllers.

Door Safety Switches

Premature starting of the car while the door is open, and open hatchways, cause many of the accidents that occur in elevator operation. To overcome these, many types of door interlocks and door switches have been devised. Certain door safety switches are designed to govern the control circuit only, and therefore the controller must be equipped with a magnetic main switch. When a door or gate is opened the circuit to the main magnetic switch coil is interrupted, thus preventing the power lines from establishing connection to the motor until the door is closed.

The switches are single-pole, enclosed to prevent tampering, and are arranged so as to close the circuit when the door is shut. The switches close the circuit only after the door latch engages so that the elevator cannot be operated until the door is both closed and latched.

Where the shipper rope lever or hand-wheel control is used the conditions differ from the foregoing and some modifications are necessary. In all these types a rope is usually attached to the reversing mechanism. With some equipments the reversing switch controls a magnetic main

switch on the controller. Door safety switches may then be installed to interrupt the coil circuit to the main line switch. With this arrangement, however, if the voltage fails while the control rope or lever is in the "on" position, the return of voltage will automatically start the elevator and the unexpected start may cause an accident. If the elevator is stopped by opening a door and the shipper mechanism is left in the "on" position the closing of the door will start the elevator and may also cause an accident.

To eliminate these possibilities, a relay and a shipper-bar interlock may be added to the equipment. This arrangement makes it necessary to return the operating cable to the "off" position in order to again start after voltage failure, or after stopping by the opening of a door.

The relay is a small magnetic switch which can be mounted on the panel with the magnetic main switch. The shipper-bar interlock consists of a switch and a cam, operated by the same mechanism that throws the reversing switch. The cam is arranged to engage the door switch only when the reversing switch is in the "off" position so that the control circuit is only closed in this position. In case of the return of voltage after failure, or in case a door is closed with the operating mechanism in the running position, the elevator will not start. When the operating mechanism is thrown to the "off" position, normal conditions are restored and the elevator will start when the operating mechanism is again thrown into the running position.

Phase Failure and Phase Reversal Relay Switch

On polyphase alternating current installations the failure of one phase may burn out the motor because of the overload thrown on the remaining phase or phases, in the case of two or three-phase circuits, respectively. The reversal of a phase will reverse the motor and may cause the car to overtravel into the head beams above or into the pit. To eliminate these dangers a special device is required. The functions such a device should perform are:

(a) To open the control circuit if the voltage falls appreciably below normal and keep it open until the voltage returns to nearly normal.

(b) To open the main magnet switch in case of open circuit in one of the supply lines, provided the motor is under appreciable load. For example, at light motor loads the remaining phase may be able to carry the load but due to excessive current in this phase overheating may result. Thus the relay should not operate until the load increases an appreciable amount so that the reliability of the elevator service is not unduly impaired. If under these conditions the motor is shut down it should not start until the line circuits are properly restored.

(c) To stop the motor immediately on reversal of any phase.

One device consists of a small squirrel cage motor carrying two arms on its shaft. These arms are normally held in contact with stationary figures by the motor torque against the pressure of a spring. Upon phase failure or phase reversal the torque of the motor fails or reverses so that the spring opens the contact and thus interrupts the control circuit.

Controllers

The function of a controller is to regulate the driving mechanism so as to cause each element to function in the right order and at the proper time. It is necessarily automatic in its operation to avoid the possible error or abuse were its functions dependent upon the will or judg-

ment of an operator. Controllers are used for direct or for alternating current motors and their particular characteristics will be described.

Direct Current Semi-Magnetic Controller

This type of controller is used in connection with rope, lever or wheel control and is therefore limited by the Safety Code to speeds of 100 ft. per min. for the rope control and 150 ft. per min. for lever or wheel control using a shipper rope.

The minimum equipment for this class of control requires a reversing switch, which is actuated by the shipper rope, and the automatic starting panel to govern the movement of the elevator. The special features to be included in the controller proper should be low voltage release, time limit acceleration to regulate the rate of acceleration, motor reversal to occur only with all resistance in circuit, cut-out for series field when the motor is under headway, and a field discharge resistor if dynamic braking is not provided.

Additional accessories that may be used with this equipment are hatchway limit, slack cable, car safety, door safety and emergency door cut-out switches. The equipment may also include a solenoid brake and a dynamic brake.

The low-voltage release is required when the voltage drops considerably below normal, or fails altogether. Under these circumstances, should the voltage be again applied while all resistance is cut out of the circuit, the car would start with a jerk and the heavy inrush of current would blow the fuses and otherwise tend to injure the motor.

A shunt field discharge resistor should be provided on all motors larger than $7\frac{1}{2}$ horsepower, or on smaller sizes if the voltage is 500 or over. This is necessary since the sudden opening of the field is accompanied by a high voltage or "kick" which may be so high as to puncture the insulation.

This type of control is suitable for slow speed passenger or general freight service. If the equipment is used with a winding drum type elevator the traveling nut on the elevator machine should be arranged to throw the drum reversing switch to the "off" position at the normal limits of travel. When the traction type elevator is used, buttons on the shipper rope may be used to center the drum reversing sheave.

If a brake is used which consumes not more than 350 watts, hatchway limit switches may be used instead of the more expensive traveling nut device. All installations should include two hatchway type limit switches in addition to normal stop limits to prevent dangerous overtravel of the elevator.

Direct Current Full Magnetic Controller

This type of controller is used for car switch or push-button control. It is self-contained, but additional control features may be used in connection with it. Where the speed is greater than 100 ft. per min. dynamic braking is advisable and moreover if good stops are desirable the automatic slow-down feature should be added. The slow-down speed is about 30 per cent of the full running speed. Where slow-down is used dynamic braking should also be used. As in the controller above described no field discharge resistor is required where dynamic braking is used.

For push-button control a floor selector should be used if there are more than two landings. There should also be provided two hatchway limit switches for terminal stops

and two for emergency overtravel protection. If slow-down is desired two additional slow-down switches should be used.

A complete equipment for car switch control will include car, machine limit, hatchway limit, slack cable, car safety, door safety, and door emergency cut-out switches. The equipment may also require a solenoid brake in addition to the dynamic brake previously mentioned. One five-wire and one two-wire car control cable should be supplied if slow-down is desired. Otherwise, a three-wire cable may be used. These figures include no reserve of control cables.

For push-button control the full equipment will require push-button, hatchway limit, slack cable, door safety, door emergency, cut-out switches and a floor selector if there are more than two landings. A solenoid brake should be used and, if desirable, a dynamic brake, particularly if the speed exceeds 100 ft. per min. A non-interference feature should also be included if the calling may be from more than one station.

A controller which is suitable for single speed elevator motor for passenger and freight service and car speeds not to exceed 175 ft. per min., or dumb waiter service not to exceed 300 ft. per min., consists of four reversing contactors, a three-prong field and brake relay, an accelerating movement, a try-out switch to operate the car from the controller, and control fuses. The accelerating movement is solenoid-operated with an oil dashpot to control the rate of acceleration of the car. A low voltage protection is also included. A shunt field discharge resistor must be used unless dynamic braking is provided in the controller.

For high speed elevator service the controllers differ from the preceding by the addition of contactors to increase the resistance in the field circuit. The car switch is then arranged to give three speeds, slow-down, normal and high. Normal speed is then about 50 per cent of high speed, and the slow-down speed is about 30 per cent of the normal speed. The conditions which make such high speeds desirable in passenger service seldom obtain in freight elevator practice.

Controllers for Alternating Current Circuits

There are two types of motors used on alternating current circuits, namely the squirrel cage and the slip-ring motors. Their controllers must have different characteristics.

Semi-Magnetic Controllers for Squirrel Cage Motors

The ordinary squirrel cage motor running at a single speed and not over 15 horsepower may be connected directly to the line without starting resistance in the circuit. The limitation suggested is due to the high starting currents (two to three times full load current). The objection to this type is due to the drop in voltage of the circuit and the dimming of lights that may be on the same circuit. A simple reversing switch may be used for this service.

A better arrangement is obtained by using a magnetic contactor in addition to the reversing switch. An illustration of a type of controller for this use is given. The particular advantage of having a separate contactor is to relieve the reversing switch of the arcing when the motor circuit is opened.

The operation of the reversing switch may be by hand-rope, lever or wheel in the car. The auxiliary devices that may be used in connection with it are, phase failure

and phase reversal relay switch, overload relay, hatchway limit, slack cable, car safety and door safety switches. If an electro-mechanical brake is used, a single phase brake magnet should be included.

The controller should have a low voltage release to prevent automatic starting of the elevator upon resumption of current after failure, without first centering the shipper mechanism and then moving to the running position. The overload relay when used with low voltage protection may be arranged so that by returning the reversing switch to the "off" position the overload relay will be automatically reset.

If the equipment is used with a winding drum machine the traveling nut on the elevator machine should be arranged to throw the reversing switch to the "off" position at the normal limits of travel. When traction type elevator machines are used, buttons on the shipper rope can be used to center the reversing switch.

If a magnet brake is installed, hatchway limit switches can be used in place of the more expensive traveling nut device.

Semi-Magnetic Controller for Slip-Ring Alternating Current Motor

In one type of slip-ring motor controller suitable for slow speed passenger and freight service which may be operated from the car may be by means of a hand rope, lever or wheel; the magnetic accelerating switches are energized by means of a pilot relay which is equipped with an air dashpot. The resistor should be cut out of all phases simultaneously, so that the rotor is balanced during the entire starting period.

The traveling nut provided on the elevator machine should be arranged to throw the reversing switch to the "off" position at the limits of travel. Hatchway limit switches may be used in place of the more expensive traveling nut device provided that a solenoid brake is used. Overtravel hatchway limit switches should be used to guard against phase reversal.

Suitable accessories may consist of phase failure and phase reversal relay, overload relay, hatchway limit, slack cable, car safety, door safety and door emergency cut-out switches.

Alternating Current Full Magnetic Car Switch Controller for Squirrel Cage Motors

For car switch control, overload protection can be provided on the control panel by adding an overload relay and a magnetic interlocking relay. This arrangement provides an interlock between the overload relay and the car switch so that it is merely necessary to return the car switch to the "off" position to reset the overload relay after an overload has occurred. A five-wire and two-wire control cable are necessary if no reserve is desired in the control cable.

This type of controller is used for a single speed, high torque, squirrel cage induction motor having an inrush of not over three times normal full load current when thrown directly across the line. It is suitable for a speed not to exceed 125 ft. per min. It may also be used for dumb waiter service where the speed of operation is not to exceed 150 ft. per min.

A try-out switch and fuses should also be provided. The inclusion of this apparatus enables testing being done from the control panel.

The accessories which may be used in this type of control are phase failure and phase reversal relay, elevator car, machine limit, hatchway limit, slack cable, car safety,

door safety, door emergency, cut-out switches. An electro-mechanical brake should also be provided.

Alternating Current Full Magnetic Push-Button Controller for Squirrel Cage Motors

In addition to the controlling devices previously described, push-button elevators require a push-button switch in place of the car switch, a non-interference relay and a floor selector. The non-interference device is to be used to permit the passenger time to enter or leave car before it may be called to some other station. A time relay of this sort is therefore desirable.

For a two-landing equipment no floor selector is required. In this case two hatchway-type limit switches for terminal stops and two for emergency overtravel protection are required.

For a three-landing equipment a floor selector is required on passenger and freight service. In this case two hatchway limit switches are necessary to provide for emergency overtravel protection. For dumb waiter service no floor selector is required provided a relay is installed for the middle landing control, together with five hatchway-type limit switches, one for the middle landing stop, two for the terminal stops and two for emergency overtravel protection.

In any four or more landing equipment a floor selector must be used for all classes of service. The speed for push-button control should not exceed 125 ft. per min.

Alternating Current Full Magnetic Car Switch Controller for Slip-Ring Motors

One type of controller suitable for speeds not to exceed 200 ft. per min. consists of a double-pole magnetic main line contactor, two double-pole reversing contactors and three or four double-pole accelerating contactors giving four or five steps of acceleration. The accelerating contactors are operated by a time limit accelerating relay so as to permit smooth starting irrespective of the load on the car. A dashpot is used on the timing relay and is adjusted to cut out the resistor connected in the rotor circuit in the required time to insure smooth starting. When once adjusted the resistance will always be cut out in the same length of time. A try-out switch should also be included to permit control from the panel for testing purposes.

Overload protection should be provided on the control panel. This is obtained by adding a time limit overload relay and a magnetic interlocking relay. This arrangement provides an interlock between the overload relay necessary to return the car switch to the "off" position to reset the overload relay after an overload.

The low voltage protection which should also be included prevents automatic starting of the elevator upon return of current unless the car switch is returned to the "off" position and then moved to the operating position. The accessories to be used with this type of controller, in addition to those previously noted, consist of phase failure and phase reversal relay, elevator car, machine limit, hatchway limit, slack cable, car safety, door safety and door emergency cut-out switches. The necessary equipment for a solenoid brake must be added.

If higher speeds than 250 ft. per min. are desired a two-speed motor should be used and it should be provided with slow-down feature.

Alternating Current Full Magnetic Push-Button Controller for Slip-Ring Motors

The push-button control is much the same as that pre-

viously described except that a push-button is substituted for the car switch, a non-interference relay is to be used and a floor selector if there are more than two landings. When used for push-button service elevator speeds ob-

tained by the use of single speed motors should not be made to exceed 125 ft. per min. Speeds higher than this should use a two-speed motor and a slow-down feature should be provided.

Hydraulic Elevators

One of the earliest forms of elevator used was the direct-acting plunger type. It was used for the highest speed passenger service but the great cost of installation and the high maintenance cost caused its gradual withdrawal from the market for this service. Its use in short lift freight service still exists and for this service it possesses a number of advantages. Plunger elevators are simple in principle and permit easy inspection of working parts. They require little skill for their successful operation. The water pressure may be obtained from the street mains, overhead tanks, or from pressure tanks supplied by pumps using any form of motive power.

In the usual arrangement of a plunger machine, as shown in the illustration, a cylinder which is closed at its lower end is sunk into the ground. The upper end has a stuffing-box through which passes a plunger which is secured to the car. Thus the travel of the platform is the same as that of the plunger.

The operation of the elevator is as follows: Pressure water is introduced just below the stuffing-box. When this pressure is acting on the under side of the plunger it will lift a load which is proportional to the area of the plunger

some cases to support not only the total weight of the car and its load but also a part of the weight of the plunger.

Vertical Piston Engines

Where the conditions are such that headroom is more readily available than floor space the vertical cylinder engine offers certain advantages. One form of elevator thus driven is illustrated and consists of a cylinder closed on the under side. The two piston rods pass through two stuffing-boxes in the upper head of the cylinder. The piston rods are secured by a suitable yoke and frame to the traveling sheaves about the cylinder. The upper and lower ends of the cylinder are connected by a circulating pipe the function of which will be shown. A suitable valve, which is operated by a shipper sheave, controls the flow of water to and from the cylinder. The valve is operated by a cable which is secured to the shipper sheave and obtains its motion from a hand-rope lever or wheel mechanism in the car, subject to the will of the operator.

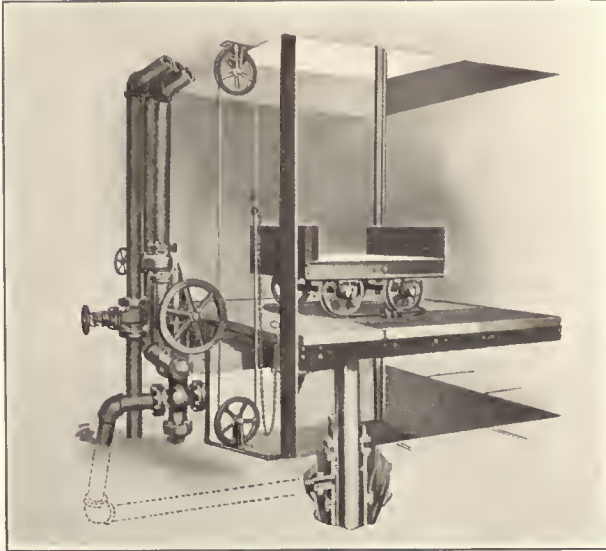

Hydraulic Plunger Freight Elevator

and the water pressure. The descent of the platform is accomplished by exhausting the water from the cylinder. A suitable valve, which is under the control of the operator, permits the pressure water to flow into the cylinder when the car is to be raised or to exhaust the water when the car is to be lowered.

For very short lifts plunger elevators require no hoisting cables since the platform is supported from underneath. For higher lifts the car and its load introduce an objectionable lack of balance in the extreme limit of travel and a serious difference in the work done in the up and down travel. For this reason a counter-balance is introduced in

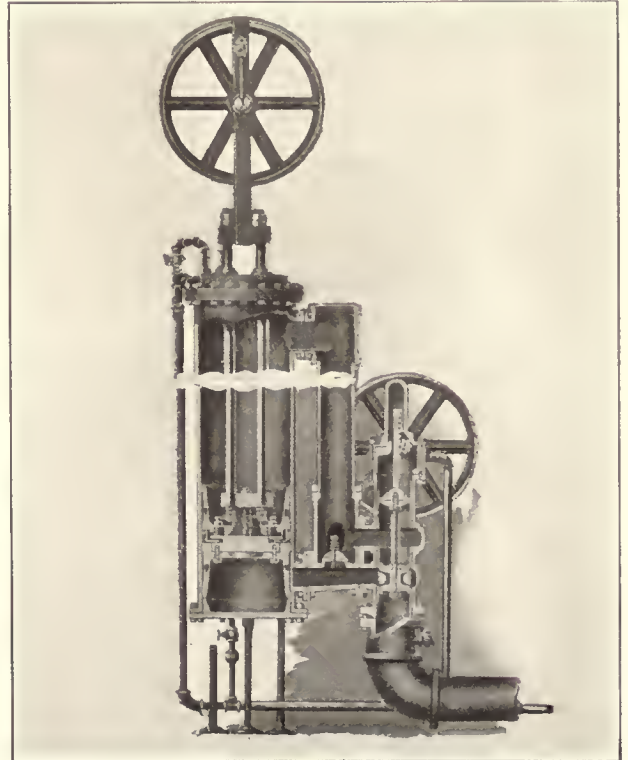

Vertical Hydraulic Elevator Engine

The travel of the car with respect to the piston travel may be any desired ratio. This is accomplished by a principle substantially the same as a block-and-fall. The cylinder may be made a convenient length. For a two-to-one gear, i. e., a car travel of two feet to one foot of piston travel, the roping is arranged as follows: One end of the rope is secured to an overhead beam which supports

the overhead sheave. It then passes under the travelling sheave shown in the frame connected to the piston rods and up the elevator shaft to the overhead sheave which properly directs the cable plumb over the centre of the car. The ratio of travel may be varied by changing the number of sheaves, in which case the stationary sheaves need not be located on the overhead beams but may be secured at a suitable point in the hatchway.

The pressure water is delivered to the cylinder by connecting either to a tee on the upper end of the circulating pipe or to a tee located on the circulating pipe near the operating valve. In the latter case the upper tee is either replaced by an elbow or is plugged. With the elevator at rest, if the shipper sheave is turned so that the valve is moved down, the upper end of the cylinder is in communication with the lower end. The pressures are then equalized and the weight of the car and its load will cause the car to descend, at the same time pulling up the piston. If the valve is brought to the central position the communication between the cylinder ends is cut off and the elevator will come to rest.

To cause the elevator to ascend the valve is moved up, thus permitting the lower end of the cylinder to be put in communication with the discharge pipe shown below. The pressure water on the top of the piston will thus force it down and the car will ascend.

Suppose the circulating pipe were omitted and the pressure water introduced above the piston. When the piston is in the upper part of the cylinder the total force urging it downward would be due to the hydraulic pressure acting on the area of the piston. When the piston is in the lower part of the cylinder the hydraulic pressure is augmented by the additional weight of the column of water above it. This causes a serious unbalancing of the lifting force. Suppose now that the piston is at its lowest point and the circulating pipe is introduced as shown. When the piston rises a suction is produced and water will follow the piston to a height determined by the barometric pressure which under ordinary circumstances is about 34 ft. With this arrangement when the piston is above, the column of water underneath will exert a suction depending upon the height of the column and vary from a maximum at the top to zero at the bottom. Likewise the weight of water above the piston is small when the piston is at the top and reaches a maximum when at the bottom. This reverses the conditions due to the suction. The compensating influence of the circulating pipe is thus established.

For high rise installations the cylinder is made about 30 ft. long and the gear of the elevator is chosen to suit. This will leave the circulating pipe undisturbed. Where the cylinder is made longer than the height of the column of water sustained by the atmospheric pressure the cylinder is provided with a "goose neck." This device consists of using the discharge pipe which connects to the under side of the cylinder and carrying it vertically to a height such that the return bend at the upper end of the pipe is about 30 ft. below the top of the cylinder. Thus the actual height of the column of liquid in the cylinder above the discharge pipe is no more than can be sustained by the atmospheric pressure.

Circulating pipes are not ordinarily used on high pressure systems since the variation of the effect of the column of water in comparison with the working pressure is too small to cause any serious unbalancing.

Horizontal Piston Engines

The horizontal machine consists of a cylinder and a piston much the same as the vertical cylinder machine described.

The piston is secured to traveling sheaves which move away from the cylinder when lifting the car. Stationary sheaves are secured to the head end of the cylinder as shown in the illustration. When the pressure water is introduced

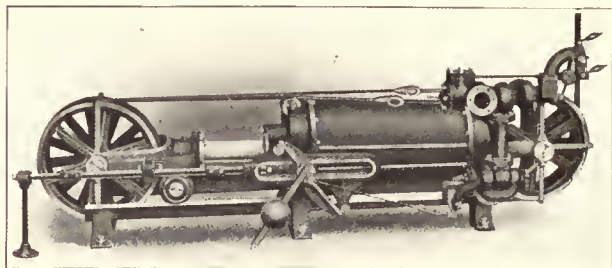

Horizontal Hydraulic Elevator Engine

into the cylinder the sheaves are forced apart. Thus when the sheaves are the minimum distance apart the car is at the lowest position in the shaft and will rise when water is forced into the cylinder. The car descends by gravity and exhausts the water from the cylinder. The admission or exhaust is accomplished by means of a suitable valve.

Another type of horizontal machine used extensively is the "pulling" type. Here the piston rod is in tension and the sheaves are pulled apart when lifting the load.

The various hydraulic elevators described are usually equipped with a pilot valve which controls the main valve. This became necessary early in the development of such elevators because the operation of the main valve from the car became a physical impossibility. Accurate and smooth stops were difficult to obtain particularly at the high speeds.

Typical Hydraulic Installation

A complete installation of a hydraulic vertical cylinder installation is illustrated. Steam is supplied to the pump through a pipe in which a valve is actuated by a pressure

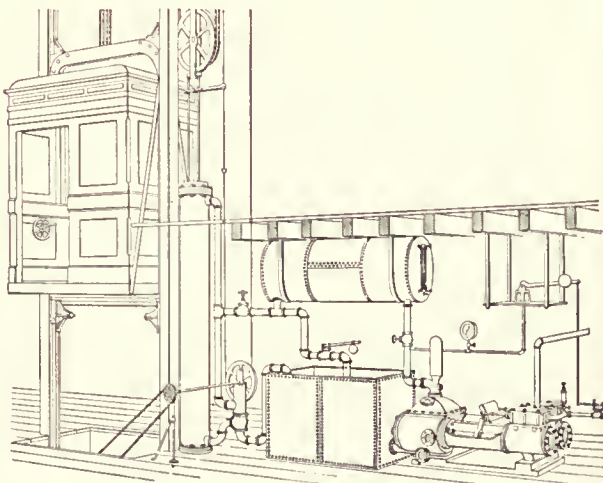

General Arrangement of an Hydraulic Elevator

regulator. When the pressure drops below normal the valve is opened and admits steam to the pump. It shuts off again when the pressure rises to a predetermined amount. The discharge from the pump is pumped into the pressure tank, which is partly filled with air to act as a cushion. The air supply is kept at about one-third of the volume of the tank and is supplied to the tank through the water pump by simply admitting air at its suction side.

The operation of the elevator has been outlined in connection with the vertical cylinder machine previously described and need not be repeated here.

The exhaust from the cylinder is returned into the discharge tank from which it is drawn into the pump, as the occasion requires. A relief valve is inserted in the supply pipe to prevent excessive pressure due to careless operation of the elevator or in case of failure of the pressure regulator to cut off steam supply when the pressure is up to normal and the elevator is not in service.

Pumps

Ordinarily the pumps used in the smaller hydraulic elevator installations are double-acting duplex. For higher economy the compound cylinders are used in place of the single cylinders. On the very large installations high duty pumping engines are used since in these the steam is used expansively. Their much greater cost prevents their extended use in the smaller installations. Where electricity or other motive power is used triplex single-acting pumps are common.

If the hydraulic pressure in the street mains is sufficiently high and reasonably constant, the pumping plant may be dispensed with unless the cost of water is excessive. This is an economic problem and must be solved for each particular case.

Pressure Tanks

Pressure tanks in elevator installations may be located as shown in the typical installation. Open tanks located on the roof of the building may be used if the height is such as to give sufficient hydro-static pressure to operate the elevator. Sometimes the pressure tank is located high in the building, thus subjecting the tanks to a lower pressure but yet maintaining the desired pressure at the elevator cylinder.

Accumulators

For low pressure service (i. e., between 100 lb. and 150 lb. per sq. in.) pressure tanks or open tanks on the roof are used. For high pressures (such as 750 lb. per sq. in.) the reserve pressure water is usually stored in weighted accumulators.

The plunger elevator is a good example of a hydraulic accumulator. If the platform is loaded to the degree required to maintain a predetermined pressure, in the ordinary operation of the accumulator, water will be stored when the pumps supply water at a pressure in excess of the accumulator pressure and the accumulator will furnish water at the desired pressure when the pumps fail in the supply pressure. As a general rule the water storage capacity of accumulators is very small and they are used to relieve peak loads on the pumping plant.

Steam-Hydraulic Elevators

In the ordinary hydraulic elevator the pressure water is obtained by some form of pump. The use of pumps may be avoided by applying steam pressure directly on the water. Interposing a blanket of air, thus separating the steam from the water, as shown in the illustration, prevents excessive condensation that would result from direct contact of the steam and the water. As shown, the water for operating the elevator is at the bottom of the pressure tank and the steam for operating is introduced above. The air, being heavier than the steam, will remain next to the water. The steam is introduced so as to prevent agitation of the air; the air blanket is thus used as a piston in forcing the water into the cylinder of the elevator mechanism.

The steam inlet and the water outlet may be operated simultaneously by a rope control. By means of a ball check valve the water level remains constant and permits the requisite amount of air to enter to provide the proper air piston.

Pneumatic Elevators

The use of air as a working medium in the cylinders of pneumatic elevators is found desirable where compressed air must be used for other purposes. Such elevators are ordinarily used for short lifts in freight handling. The usual types are the rope and the direct acting. In the

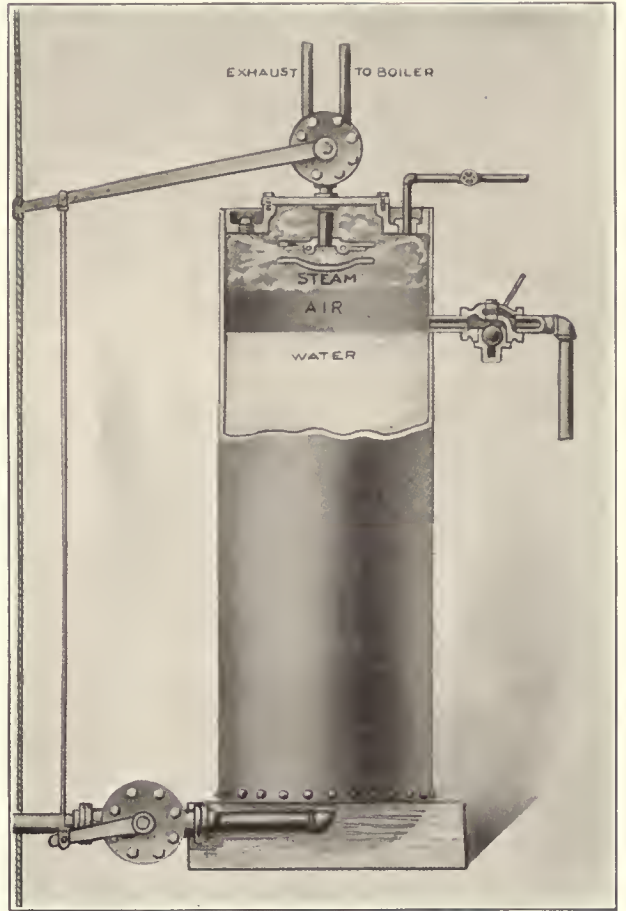

Steam-Hydraulic Elevator Water Cylinder

rope type elevator compressed air is introduced at the top of the cylinder and forces the piston down hence raising the platform by rope gearing. Where headroom is of no consequence a direct-acting elevator is less costly of installation.

Steam-Driven Elevators

The steam-driven passenger elevator is practically obsolete. Few of those constructed in the early days remain in service. The steam-driven traction type is still to be had though installations of this kind are rare.

Steam driven equipments are used frequently in building construction. The engine consists usually of a vertical boiler with two simple engines having cranks set at right angles. As a rule the drum is not scored to receive the cables such as is common practice in drum winding engines but the rope is permitted to wind on itself. The operator determines the position of the platform by a tell-tale fas-

tened to the rope. The lifting cables raise the entire load, as counterweights are not used. The car descends by

gravity while the speed is held in check by a brake controlled by the operator.

Hand-Power Elevators

The use of hand-power elevators is limited to installations where the demand for elevator service is infrequent and where the expense of power-driven machines is not warranted. These elevators require little space, may be installed at low cost and require but little attention either for maintenance or operation.

Sidewalk Elevators

The chief use of basement or sidewalk elevators is to carry merchandise up and down for hotels, apartment houses, stores and light manufacturing establishments. A much used type is illustrated which consists of a wheel with a crank handle attached; this is geared by a series of wheels to a shaft below which carries the winding drums on which the lifting cables wind. The cables, two in number, pass over sheaves—one of which is placed near the top—and thence down to the underside of the platform. The speed reduction must be such as to permit one man to lift the maximum load which may be placed on the platform.

The brake may be secured to the post with the brake shoe resting on the upper side of the wheel. The function

Where it is impossible to put the hand-wheel or crank on the guide post, it may be offset. This type should not be used if the type previously described can be installed, for should the chain fail the platform is free to fall unchecked.

Hand-power elevators of the types described are suitable where the work is light and service infrequent. Their initial cost is small and the cost of operation and maintenance is low. If the service becomes frequent it may warrant the installation of one of the types which are described later.

Counterweights are not used on sidewalk lifts. The load is raised by virtue of the power expended; descent of the elevator is entirely by gravity.

Freight Elevators

Hand-power freight elevators are used when the service is such that the power elevator is economically undesirable. It is cheap compared with the power elevator yet superior to the ordinary hoist. In one type which is illustrated as representative of this style of elevator the overhead shaft carries the winding drums and is geared to the pull-wheel. The counterweight cable also winds on the drum. The

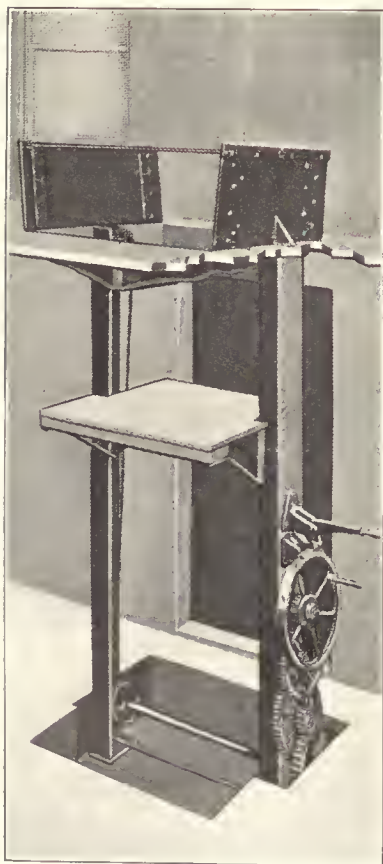

Basement Elevator

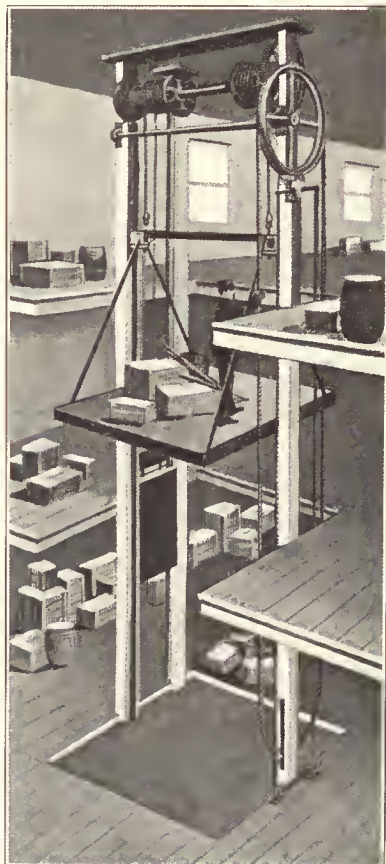

Hand Power Elevator



Carriage Elevator

of this brake is to control the speed on the down trip; this must be kept in check since the car gains velocity as it descends due to the acceleration and might crash into the pit.

counterweight guide is usually enclosed to prevent anyone from being struck by the counterweight. The operator is required to lift only the difference in the weights between the load on the platform and that in the counterweight and

in addition overcome the friction set up in the mechanism.

The car is equipped with a safety device which grips the guides in case the lifting cables break. A brake is also attached to the pull-wheel, which is operated by a rope. This is made necessary since the gearing will not sustain the load in any position and therefore the descending speed of the car must be under control at all times. The power

is furnished through a hand rope and the lifting is done by means of steel cables.

Another style of car, the particular advantage of which lies in the fact that the lower floor is not mutilated by pit construction, is also illustrated. This is accomplished by beveling the edges of the car platform so as to permit wheeling onto the platform.

Portable Elevators

Where goods must be stored on the floor economy of space requires that it be piled as high as possible. The limiting heights to which such goods may be piled depends upon the permissible load per square foot of floor space and the ability of the goods at the bottom of the pile to sustain the pressure of the goods above it. The piling of the goods to the ceiling is accomplished in one of two ways—stepping and vertical piling. In the stepping method the steps are made a convenient height for handling the goods manually. The objection to this method of storage is the inefficient use of the space required by the steps. Vertical piling is accomplished by the portable elevators to be described. In this case the goods are piled to occupy all the space except such as is needed for aisles, passage, etc.

The portable elevators may be used for piling cases, bales, barrels, etc., unloading trucks, elevating machinery for

Portable elevators, as used in piling machines, consist of uprights which act also as guides for the elevating platform on which the goods are placed for hoisting. The platform is elevated by some suitable mechanism. The elevator has wheels for moving it from place to place but is provided with legs when in operation so as to avoid the possibility of its moving when loading or unloading. Means must also be provided for securing the load in any position should the operator cease for any reason to furnish lifting force.

The construction of the platform depends upon the use to which it is to be put. For soft packages such as bags, or for rolling containers such as barrels or drums, the flat platform is used. Roller platforms are used for compact containers such as cases or bales. The rollers are usually so arranged that they may roll from front to rear of the platform or may be removed from their sockets and be



Motor Operated



Hand Operated

erecting or repair purposes, elevating liquids to permit siphoning or pouring, elevating to platforms or balconies or between floors. The last case is a direct substitute for the freight elevator and is used when a fixed elevator would not be justified.

placed so as to roll from side to side depending upon the requirements.

As far as motive power is concerned the elevators may be operated by hand or by a motor of some kind. Where high lifts are necessary a motor drive may be found de-

sirable. In general, the frequency of use and the cost of handling will determine whether it is best to use hand or motor drive.

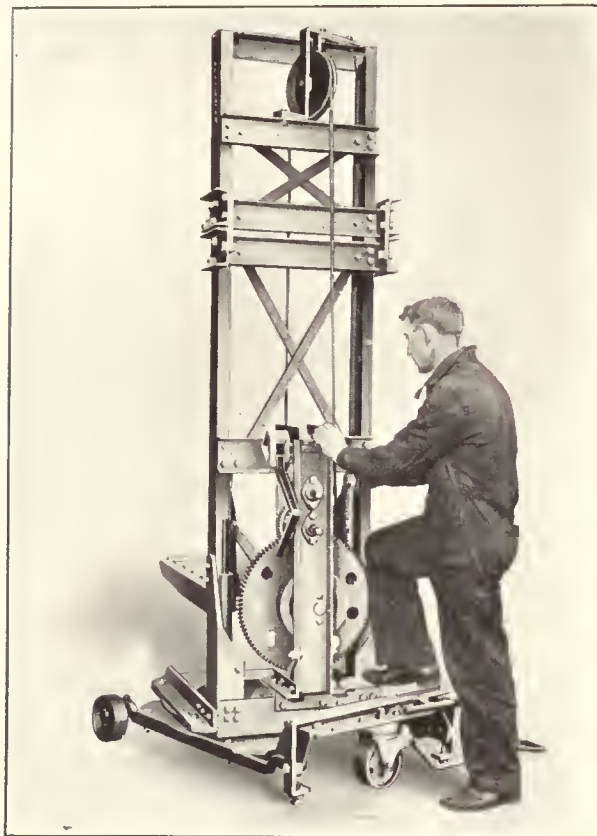

Revolving Type Portable Elevator

For low rises where the elevator need not be transported under beams or low doorways, the guides may be in one piece. For high rises they are usually hinged so that they may be folded, thus reducing the headroom required for

moving the machines from place to place and increasing materially the usefulness of the device.

The apparatus as a whole is made either revolving or non-



Handling Rolls of Paper

revolving. The revolving type is used where it is required to load from one position and discharge in any direction. Where these requirements do not exist the non-revolving type will answer.

Elevator Details

Much importance should be attached to the safe operation of elevators. Strictly speaking any device which controls or prevents elevator service from departing from normal operation is a safety device. However, usage limits the name to such devices placed on the car or counterweight as to prevent either of them from falling or from attaining excessive speed.

Early devices designed to prevent the car from falling were of the "broken rope" type, the arrangement being such that if the hoisting rope remained in tension the safety was inoperative. A breakage of the rope immediately brought the car to a stop in a manner depending upon the type of safety used. One of the early devices consisted of a pawl with ratchet teeth secured to the guides. The breaking of the rope permitted the pawl to engage the teeth and thus suddenly stop the car.

Another arrangement consisted of planer teeth which gripped the guides and grooved or planed as the car descended. Though this arrangement required a longer time to stop the car, the stop was still too abrupt. Since most freight elevators, either in normal or in emergency service,

act as passenger elevators, safeties should be designed for gradual stops so that the retardations produced are not so high as to be dangerous to life and limb.

A common type safety, which is illustrated, consists of a

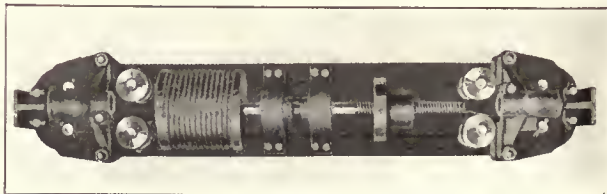

Safety Clamps

scored drum having a hub provided with right and left hand screw threads which engage with two screws. A rotation of the drum in the proper direction pushes the screws outward, thus thrusting wedges between a pair of clamp levers and forcing the jaws against the guides. The great pressure thus produced brings the car to rest. One

end of the rope is secured to the drum and the other to the governor which is placed overhead.

Improvements in this method consist of graduating the pressure by springs so that the retarding force is limited to that which will produce retardations well within that which the human body can endure with comfort.

Cables

Hoisting ropes for elevator service consist usually of 19 wires twisted together into a strand, a set of these strands being twisted about a hemp centre. The materials used are iron or steel. For drum winding engines the iron wire is suitable since it is more pliable and will absorb considerable impact without producing undue stresses in the rope. It cannot be subjected to much abrasion such as in traction service.

Steel rope is stronger than iron rope for a given diameter and is used where the strength is more important than ductility or where the abrasion would cause speedy destruction of the rope. The common practice is to use soft steel for these ropes although for heavy loads stronger steels are sometimes desirable.

In traction drive elevators two forms of grooves are used, the U and the V. Where the U-groove is used an idler is required to give the necessary "traction" to the rope. In the V-groove the wedging action of the groove on the rope produces a greater friction for the same tension in the rope. Experience to be gained in the future

will show whether the greater wear of cables is occasioned by the distortion of the rope in the V-grooves or by the increased bending of the ropes in the case of the U-grooves with the addition of an idler sheave.

For hand ropes or dumb-waiter hoisting ropes, where the rope must pass over small diameter sheaves, "tiller-ropes" are used. They are composed of 252 wires and are made up of a hemp core around which are twisted 6 ropes each of which consists of 6 strands of 7 wires each wound about its own hemp centre.

Signals

The refinements to be introduced in freight elevator service depend upon the frequency of service and the need for decreased waiting time. For the simplest cases the signals consist of push-buttons on each floor with an annunciator in the car. Where greater refinement is required two push-buttons are used for "up" or "down" calls. The annunciator in this case is provided with a double row of "drops" or lights for the information of the operator. Where elevators are in groups one push-button signals all elevators.

An arrangement for informing the passenger as to the location of the car consists of a dial on which are marked the floors of the building. A pointer rotated by suitable mechanism indicates the floor at which the car is located, and if moving in which direction the car is going.

A more elaborate system is outlined in the description of the army base installation.

Elevator Installations

The elevator installations described here are examples of the possibilities of the elevators as applied to material handling. The first layout described covers an application where large quantities of materials are handled in small units requiring a large number of elevators to supply the frequent service demanded. In the second instance the conditions require large capacity in a single unit.

Warehouse Installation

The army base located at Brooklyn, N. Y., has an excellent example of modern freight handling. Of the two buildings known as *A* and *B*, warehouse *A* is 200 ft. x 980 ft. in plan, and nine stories high with a gross floor area of 1,765,000 sq. ft. and a storage capacity of 144,000 tons.

Warehouse *B* is 306 ft. x 980 ft. in plan with eight stories and basement and has a gross floor area of 2,130,000 sq. ft. and a storage capacity of 180,000 tons.

An important link in the transportation system is the freight elevators. These are grouped and are operated from a central station. The horizontal movement of the freight in and about the warehouses is accomplished by the trailer and truck method.

The elevators are laid out in three groups in warehouse *A* and three twin groups on either side of a central court in warehouse *B*. The elevators are designed for a speed of 150 ft. per min. and an average running time of about 1 min. for the round trip. To allow for delays in loading and unloading, opening and closing of doors, and dispatching, it was assumed that each elevator would make ten trips per hour and move four truck loads or 30 tons of freight per hour.

Since the maximum requirements of warehouse *A* were assumed as 796 tons per hour this would require 27 elevators without allowance for breakdown. Actually 30 elevators were installed in this building. In warehouse *B* the require-

ments were figured at 1,250 tons per hour and thus 42 elevators were required. No spare equipment was included in this building. Thus the floor area served by the elevators provided one elevator for each 59,900 sq. ft. in warehouse *A* and one for each 50,500 sq. ft. in warehouse *B*.

To provide for lifting four trailers at once each car has a floor area of 9 ft. x 7 ft. with a capacity of 10,000 lb.

Doors at either end of the elevators are automatically operated by a chain extending from top to bottom of the



Trailers Leaving the Elevators

hatchway and back. The doors open when the elevator reaches the desired floor and are closed by pushing a button. An interlocking switch is provided to prevent the elevator from leaving the floor until the door is closed. The doors open and close quickly and are checked near the limits of travel to prevent slamming. They are evenly counterbalanced and move by means of a friction clutch. It requires little force to open and close the doors and should a person be caught under the door it will stop readily without danger of serious harm to the individual. Due to the limited story height the doors open into the hatchway

after traveling a vertical distance of 18 in. This avoids the destructive action of the truck wheels on bi-parted doors where the truck must pass over the edge of the lower half of the door. There are two doors for each elevator on opposite sides so that loading is done on one side and unloading from the other side.

To permit the trucks to ride smoothly from the car to the floor the micro-leveling device, previously described, is included in the elevator equipment. This has made practicable the application of push-button control in this installation.

The third floor is the main operating floor. Here is located the central dispatcher's desk opposite each elevator group. On this desk are two buttons for each of the other floors, one to dispatch the car to that floor and the other to call the car from that floor. An interlocking switch pre-

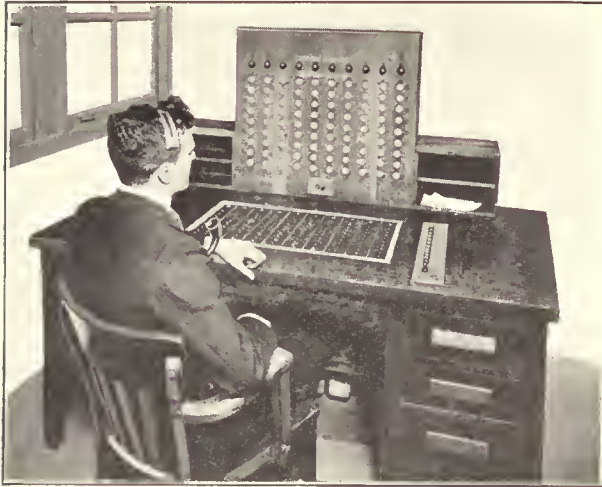

The Dispatcher Controls Ten Elevators

vents the car from being called from the floor unless the elevator doors are closed at that floor. On each floor is a dispatch button to send the car to the main operating floor. Each elevator in addition is also equipped with a car switch to permit operation with an attendant on the car. All the elevators in a group are operated by a single operator thus dispensing with the cost of individual operators.

The operator is in telephonic communication with each floor and with the director of traffic. By means of signal lights on his dispatch board he has before him the position of all elevators in his group. It is possible to receive information by the telephone concerning the state of loading and the requirements for the load in his particular group of elevators.

Portable elevators are also used for tiering purposes throughout the warehouses.

Coal Shipping Plant

From the viewpoint of magnitude, the coal handling equipment of the Virginian Railway Company at Sewell's Point, Virginia, merits consideration. The new equipment consists of a tandem car dumper, transfer cars, and a transfer car elevator.

The cars from the mines have their contents dumped into special 120-ton transfer cars. These are then run onto the car elevator and are raised to the top of the loading pockets on the pier where their contents are dumped. The coal is then discharged as needed into ships lying alongside the pier. After the transfer car is emptied it runs to

the end of the pier and is there switched to a return track located at the centre of the pier, from which it runs down a grade to the yard level. It is then switched back to the loading track which passes in front of the car dumper. By

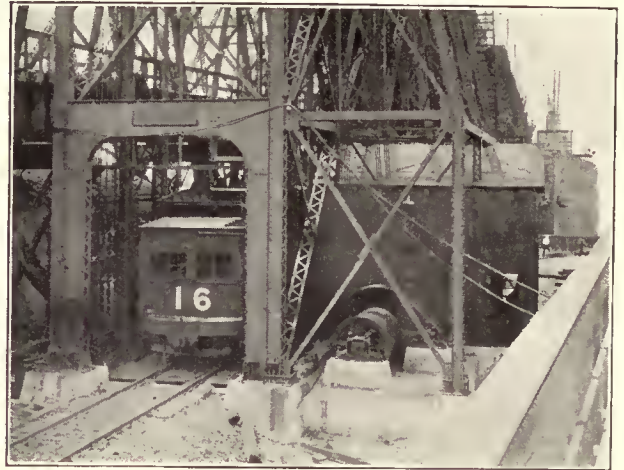

Ground Level View

this means four million tons of coal are handled over this pier each year.

When the transfer car receives its load from the car dumper it is switched onto the elevator and is lifted 67 ft. to the elevation of the top of the pier. The elevator consists of a steel framework carrying sheaves for the



End Elevation

hoisting ropes and forming a vertical guide for the lifting platform which it encloses. The lifting platform carries

the rails for the transfer car and also a section of overhead trolley wire which is energized only at the upper and lower limits of travel.

The counterbalance consists of heavy cast iron weights, so adjusted as to require practically the same pull on the lifting cables for up and down travel, thus equalizing the load on both trips and requiring a smaller motor than that which would be required if the car descended by gravity.

The machinery for operating the platform consists of two large drums geared to an intermediate shaft by cut gears. This shaft is geared to two motors by cut herringbone reductions. Each motor has a continuous rating of 450 h. p.; the motors are of open type, compound wound for a direct current of 550 volts.

The motors and intermediate reductions are mounted on a continuous bed plate anchored to a concrete foundation. A solenoid-operated brake is attached to the armature shaft of each motor, so arranged as to set as the current is cut from the motor.

The gearing of the elevator is proportioned to produce a complete cycle in two minutes. There are three separate rope systems used in the operation of the lifting platform; one leading from the drums directly to the platform; the

second from the drums to the counterweight, and the third from the counterweight to the platform. This is the common practice in drum machines. There are twelve 1½ in. diameter ropes leading to each of the drums and twelve 1¾ in. ropes between the platform and the counterweights.

Connecting the frame of the elevator to the pier is a hinged run-off girder introduced to insure perfect alignment of the rails on the platform and the pier. This girder is hinged to the pier in such a manner as to permit of a vertical movement of the free end amounting to about two feet. The free end of the girder normally rests on brackets on the elevator frame from which it is lifted by projecting lugs on the platform as it comes to the position of its upper limit. This upper limit of travel is accurately controlled by an electric limit switch geared to the hoisting mechanism. Power is supplied to the trolley wires in this position. The transfer car passes from the elevator, over the hinged runoff girder, and discharges its coal into the proper pocket on the pier.

The empty car then returns down the inclined track in the centre of the pier structure, to the loading track in front of the car dumper, taking its regular turn in the operation of the system.

A Code of Safety Standards

For the Construction, Operation and Maintenance of Elevators and Dumbwaiters*

a This code of safety standards is intended as a guide for the construction, maintenance and operation of elevators, dumbwaiters, escalators† and their hoistways except as stated in the following paragraph.

b This code does not apply to belt, bucket, scoop, roller or similar inclined or vertical freight conveyors, tiering or piling machines, skip hoists, wharf ramps or apparatus in kindred classes, amusement devices, stage lifts or lift bridges, elevators of capacity exceeding 10,000 lb. and platform area exceeding 150 sq. ft. when suspended by cables near each corner of the hoistway or at any additional positions (such as are used to handle loaded drays, automobiles, electric or steam railroad cars), nor to elevators used only for handling building materials and mechanics during the building construction.

c The code recognizes the deteriorating influence of wear, rough usage, and the atmosphere under which elevator apparatus, particularly door locks, interlocks and electric contacts, are required to operate. In the design and installation of such apparatus, due regard must be given to these conditions and to the construction upon which they are mounted.

Definitions

In these regulations the following terms shall be understood as here defined.

Elevator. An elevator is a hoisting and lowering mechanism equipped with a car which moves in guides in a substantially vertical direction.

NOTE: Dumbwaiters, endless belts, conveyors, chains, buckets, etc., used for the purpose of conveying and elevating materials, and tiering or piling machines operating within one story are not included in the term "Elevator."

Elevators are divided into two classes as follows: (1) Passenger Elevators; (2) Freight Elevators.

Passenger Elevator. A passenger elevator is an elevator on which passengers, including employees other than

those specified in the definition of freight elevator, are permitted to ride.

NOTE: This definition does not apply to elevators for carrying passengers in public or private conveyances where the passengers are not permitted to alight from the conveyance while on the elevator.

Freight Elevator. A freight elevator is an elevator used for carrying freight, on which only the operator and the persons necessary for loading and unloading are permitted to ride.

Power Elevator. A power elevator is an elevator in which the motion of the car is obtained by applying energy other than by hand or gravity.

Hand Elevator. A hand elevator is an elevator which is operated by hand and which has no other power attached.

Gravity Elevator. A gravity elevator is an elevator which is used only for the lowering of freight by gravity.

Dumbwaiter. A dumbwaiter is a hoisting and lowering mechanism equipped with a car, the floor area of which does not exceed 9 sq. ft., whose compartment height does not exceed 4 ft., the capacity of which does not exceed 500 lb. and which is used exclusively for carrying small packages and freight.

Escalator. An escalator is a moving inclined continuous stairway or runway used for raising or lowering passengers.

Electric Elevator. An electric elevator is an elevator in which the motion of the car is obtained by an electric motor directly applied to the elevator machinery.

Steam Elevator. A steam elevator is an elevator in which the motion of the car is obtained by a steam engine directly applied to the elevator machinery.

Double-Belted Elevator. A double-belted elevator is an elevator in which the machine is connected to an independent source of power, such as shafting, by two belts or similar means and in which the direction of motion is changed without reversal of the prime mover.

Hydraulic Elevator. A hydraulic elevator is an ele-

*Prepared by the American Society of Mechanical Engineers.
†Escalators are not treated here; therefore that part of the code is omitted.

vator in which the motion of the car is obtained by liquid under pressure.

Plunger Elevator. A plunger elevator is a hydraulic elevator having a ram or plunger directly attached to the under side of the car platform.

Automatic Button-Control Elevator. An automatic button-control elevator is an elevator the operation of which is controlled by buttons in such manner that all landing stops are automatic.

Platform Elevator. A platform elevator is an elevator without a car sling, the platform of which is suspended or supported at one or more points at or below the platform level.

NOTE: A platform elevator within the building line, having a travel exceeding 15 ft., shall conform to the requirements for either passenger or freight elevators, depending upon the use to which it is put.

Sidewalk Elevator. A sidewalk elevator is a freight elevator of the platform type, the hatch opening of which is located either partially or wholly outside the building line.

NOTE: Sidewalk elevators having a travel exceeding 30 ft. shall conform to the requirements of power freight elevators.

Elevator Machine. An elevator machine is the machinery and its equipment used in raising and lowering the elevator car.

Winding Drum Machine. A winding drum machine is an elevator machine in which the cables are fastened to, and wind on, a drum.

Traction Machine. A traction machine is an elevator machine in which the motion of the car is obtained by means of traction between the driving drum, sheave or sheaves and the hoisting cables.

Hoistway. A hoistway is any shaftway, hatchway, well hole or other vertical opening or space, in which the elevator or dumbwaiter travels. The hoistway may or may not be enclosed.

Travel. The travel of an elevator or dumbwaiter is the vertical distance from the lowest to the highest landing.

Overtravel. Overtravel at the *top* of the hoistway is the distance available for the car to travel above the top terminal landing until the car is stopped by automatic means independent of the manual car control.

Overtravel at the *bottom* of the hoistway is the distance available for the car platform to travel below the lower terminal landing without any part of the car construction being obstructed, except by the bumpers or buffers installed in the pit. The movement of the car necessary to fully compress the bumpers or buffers may be included in the overtravel at the bottom.

Clearance. Clearance at the top of the hoistway is the vertical distance between the lowest point of the superstructure and the highest point of the car enclosure or cross head when the car is at the limit of the overtravel at the top. Clearance at the bottom of the hoistway is the vertical distance between the floor of the pit and the lowest point on the understructure of the car sling, exclusive of the safeties, guide brackets, or shoes, when the car is resting on the bumpers or buffers fully compressed.

Landing. A landing is that portion of a floor, balcony or platform immediately in front of the landing doors, used to receive and discharge passengers or freight.

Hoistway Door or Gate. A hoistway door or gate is the door or gate in the enclosure of the elevator hoistway at any landing.

Elevator-Car Door or Gate. An elevator-car door or gate is the door or gate in the elevator car.

Full-Automatic Door or Gate. A full-automatic door

or gate is one which is opened and closed automatically, directly or indirectly, by the motion of the car.

Semi-Automatic Door or Gate. A semi-automatic door or gate is one which is manually opened and is closed directly or indirectly by the motion of the car.

Independently Operated Door or Gate. An independently operated door or gate is one which is opened and closed manually or by power from a source in no way derived from the motion of the car.

Elevator Car. An elevator car is the load-carrying unit, including platform, its supporting and guiding frame, and enclosure.

Car Sling. A car sling is the frame consisting of the cross-head to which the hoisting cables and guide shoes are usually attached, the car posts or stiles and the under cross-member which supports the car sills, platform and guide shoes.

Suspension Frame. A suspension frame is the structure (including the car sling, if any) to which the hoisting cables are usually attached and which support the car floor and sill.

Hoistway-Door Interlock. A hoistway-door interlock is a device the purpose of which is:

- 1 To prevent the movement of the car:
 - a Unless only that hoistway door, opposite which the car is standing, is closed and locked (Door Unit System); or
 - b Unless all hoistway doors are closed and locked (Hoistway Unit System).

NOTE: The interlock shall not prevent the movement of the car when the emergency release hereinafter described is in temporary use or when the car is being moved by a slow-speed car-leveling device.

- 2 To prevent the opening of a hoistway door from the landing side:
 - a Unless the car is standing at rest at that landing, and
 - b Unless the car is coasting past the landing with its car control mechanism in the STOP position.

A hoistway door or gate shall be considered closed and locked when within 4 in. of full closure, if at this position and any other up to full closure, the door or gate cannot be opened from the landing side more than 4 in.

Interlocks may permit the starting of the elevator when the door is within 4 in. or less of full closure, provided that the door can again be opened up to 4 in. from full closure from any position within this range except that of full closure.

Hoistway-Door Electric Contact. A hoistway-door electric contact is an electrical device the purpose of which is:

- 1 To prevent the movement of the car:
 - a Unless only that hoistway door opposite which the car is standing is within 2 in. of the fully closed position (Door Unit System); or
 - b Unless all hoistway doors are within 2 in. of the fully closed position.

NOTE: The contact shall not prevent the movement of the car when the emergency release hereinafter described is in temporary use or when the car is being moved by a slow-speed car-leveling device.

Car-Gate Electric Contact. A car-gate electric contact is an electrical device the purpose of which is to prevent the normal operation of the car,—except by the use of a car-leveling device,—unless the car gate is in the closed position.

Emergency Release. An emergency release is a device the purpose of which is to make inoperative electric contacts or hoistway-door interlocks.

Car-Leveling Device. A car-leveling device is a mechanism the purpose of which is to move the car automatically toward the landing level from either direction and to maintain the car platform at the landing level during loading or unloading. A leveling device, however, may also be used for the emergency operation of the car.

Hoistway Construction for Passenger and Freight Elevators

Section 10 Hoistway Construction

Rule 100 Fire-Resisting Hoistways

a Except for elevators in private residences, passenger elevators shall be installed in fire-resisting hoistways conforming to the requirements of the Building Code of the National Board of Fire Underwriters, unless state laws or municipal ordinances require a hoistway the fire-resisting qualities of which are greater than specified in the above-mentioned Code.

NOTE: Experience has demonstrated the value of the elevator as a life-saving device in case of fire. A simple form of fire-resisting construction (cement plaster on metal lath) will usually resist a fire for a greater length of time than the elevator can be used as an exit from a burning building. Fire-resisting hoistways are therefore recommended for all elevators.

b All landing openings in a fire-resisting hoistway shall be provided with fire-resisting doors which comply with the code, or with the laws or ordinances mentioned in Rule 100a, in so far as there is no conflict with Rule 120a, of this Code.

Rule 101 Non-Fire-Resisting Hoistways

a For enclosure required for non-fire-resisting hoistways, see Rule 111.

Rule 102 Clearance on the Sides of the Hoistways

a Hoistways for power elevators, except as stated in Rule 102c, shall have a clearance of not less than three-fourths inch between the sides of the cars and the hoistway enclosures, and not less than one inch clearance between cars and their counterweights.

b The clearance between the car platform and the landing thresholds shall be not less than three-fourths inch nor more than one and one-half inches.

c The clearance between a hoistway enclosure and an open side of the car platform shall be not more than 4 in., except as set forth in Rule 111c.

NOTE: Paragraphs a, b and c do not limit the clearance between the hoistway enclosure and the car, counterweights or platform of sidewalk elevators having a travel of not more than 30 ft., hand elevators or dumb waiters.

d If two or more cars are operated in the same hoistway, the clearance between cars shall be not less than 2 in.

e If "filling in" be necessary to comply with the foregoing requirements, the "filling" shall conform to the requirements of Rule 111d for hoistway enclosures.

Rule 103 Hoistway Windows, Skylights and Penthouses

a Windows in the hoistway wall of a power freight elevator shall be provided with vertical bars or grating having clearance as specified in Rule 102c, if the car has an entrance toward this wall. The upper surface of the recess formed by the vertical bars shall be beveled on the under side as specified for projections in Rule 111f.

b Windows in the hoistway below the seventh floor above the street shall be fitted on the outside with verti-

cal metal bars not less than five-eighths inch in diameter and spaced not more than 10 in. apart.

NOTE: This is the usual method of indicating on the exterior of the building the location of an elevator hoistway, and serves to warn firemen attempting to enter the building or placing ladders against such windows.

c Unless there is a solid platform, having openings only for the cables, under the machine or sheaves, fire-resisting hoistways which extend through the roof shall have a skylight in the top or one or more windows in the side-walls near the top of the hoistway.

The total glass area of these skylights or windows shall be in each case (1) not less than one-half the area of the hoistway, (2) not less than 3 sq. ft., if the area of the hoistway is 3 sq. ft. or more; and (3) the full area of the hoistway if the latter is less than 3 sq. ft.

The glass shall be plain glass which in a skylight shall have a protective netting securely supported over it at least 6 in. from the skylight. The netting shall have a mesh not greater than one inch and shall be made of wire not less than No. 12 Stl. W. gage (0.1055 in. diam.)

NOTE: The purpose of the skylights and windows in addition to providing natural light is to provide a vent for smoke and hot gases in case of fire; consequently the glass must be plain glass, not wired glass, so as to break readily, or the skylight and windows may be arranged to open automatically to the required area upon the fusing of fusible links inside the hoistway near the top, in which case wired glass may be used.

d Adequate permanent provision for artificial light (electric light, if available) shall be made in all penthouses.

The lamp (or the penthouse lighting switch, if electric light is used) shall be within easy reach of the entrance to the penthouse.

It is recommended that the elevator service switch and the penthouse lighting switch be located at the right of the entrance to the penthouse and that both these switches be enclosed.

e Safe and convenient access to the penthouse shall be provided and all penthouse doors shall be provided with suitable locks. If the penthouse is used as an emergency exit, these locks shall permit the doors to be opened from the inside without a key.

f Penthouses shall be so constructed that there shall be a minimum headroom of 6 ft. above the floor upon which the elevator hoisting machine is supported.

Rule 104 Pits, Overtravel and Clearances

a A pit shall be provided at the bottom of every power elevator hoistway, except for platform elevators serving only two adjacent floors.

b The minimum clearance and overtravel at the top and the bottom of power-elevator hoistways shall be those given in Table 1, except that the pit for power sidewalk elevators shall be not less than 2 ft. deep.

No overtravel shall be required at the bottom of the hoistway of platform elevators serving only two adjacent floors.

c The floor of the pit shall be approximately level. Sufficient slope shall be allowed for drainage but no recess shall be allowed under the car sling.

NOTE: The requirements of this paragraph may be waived if old foundation footings are encountered in a new installation and it is inadvisable to remove the footing entirely. The hazard due to an uneven pit, however, should be recognized and all possible precautions taken to minimize this hazard.

d The movement necessary to compress the bumpers may be included in the overtravel at the bottom.

e A minimum overtravel of 18 in. shall be provided at the top for hand elevators. No overtravel shall be required at the bottom for hand elevators.

TABLE I. OVERTRAVEL AND CLEARANCE FOR ELEVATORS

Speed ft. per min.		Overtravel at top, ft.	Clearance at the top, ft.	Overtravel at bottom, ft.	Clearance at bottom, ft.
Up to and including					
For Hydraulic Plunger Elevators					
Above 0	50	2½	2	1	2
50	150	3	2	1½	2
150	300	5	2	2½	2
300	500	7	2	3½	2
For Power Elevators of Other Types					
0	150	3	2	1½	2
150	350	4	2	2½	2
350	500	5	2	3½	2
500	600	5½	2	4½	2
600	800	6	2	5½	2

TABLE II. OVERTRAVEL FOR POWER DUMBWAITERS

Speed, ft. per min.		Overtravel at top and bottom
Above 0	Up to and including 100	9 in.
100	200	1 ft. 6 in.
200	500	2 ft. 6 in.

f No overtravel or clearance shall be required for hand dumbwaiters.

g The minimum overtravel at the top and the bottom of power-dumbwaiter hoistways shall be as given in Table II, except that no overtravel shall be required at the top for "undercounter" dumbwaiters.

Rule 105 Machine Supports, Loads on Supports, and Factors of Safety

a All machinery and sheaves shall be so supported and anchored as to effectually prevent any part becoming loose or displaced. The supporting beams shall be either of steel, sound timber or reinforced concrete. It shall not be necessary, however, to install beams under machinery anchored directly either to independent foundations, to the floor of the machine room or to the platform if such foundation, floor or platform is strong enough to meet the requirements for beams.

b In computing loads on overhead supports, due allowance must be made for the additional stress imposed by the acceleration and retardation (32.2 ft. per sec. per sec.) of the moving parts.

c No elevator machinery, except the idler or deflecting sheaves with their guards and frames and devices for limiting or retarding the car travel and their accessories, shall be hung underneath the supporting beams at the top of the hoistway. Dumbwaiters, however, are exempted from this rule.

d The factor of safety based on the ultimate strength of the material and the loads assumed in Rule 105b shall be not less than the following:

For steel.....	6
For timber.....	10
For reinforced concrete.....	8

Rule 106 Platforms Under Machinery

a A flooring of iron, steel, wood or reinforced concrete, capable of sustaining a load of 50 lb. per sq. ft., shall be provided at the top of the hoistway immediately below the sheaves or at the machine beams. This rule does not apply to (1) the hoistways of elevators operating through automatic hatch covers, (2) to sidewalk elevators outside the building line, nor (3) to dumbwaiters.

If an iron grating is used the mesh shall be not larger than one and one-half in. Any grating with mesh larger than one inch shall be covered by an additional screen of not larger than three-eighths inch mesh. This screen shall be securely fastened in place.

b If the grating members are laid flat, they shall be supported by battens spaced not more than 3 ft. apart. If the grating members are placed on edge, there shall

be thimbles between each two members strung on metal rods running through the members. The rods shall be riveted at their ends and spaced not more than 3 ft. apart. Equivalent construction may be provided.

c Wood platforms in fire-resisting hoistways, unless protected by a fire-resisting covering, shall be not less than 3 in. in thickness.

d The platform shall extend not less than 2 ft. beyond the general contour of the sheaves or machines, and to the entrance of the hoistway at or above the level of the platform.

e If the platform does not entirely cover the hoistway, the open or exposed sides shall be provided with a standard handrail and toe-board, or with a screened railing not less than 42 in. high. (See Rule 110a.)

f Deflecting sheaves extending below the machine level shall be provided with cradles, which comply with the requirements for Class B guards referred to in Rule 110.

Rule 107 Stops for Counterweights

a For winding drum machines there shall be a permanent, substantial beam or bar at the top of the counterweight guides and beneath the counterweight sheaves to prevent the counterweights from being drawn into the sheaves. This does not apply to dumbwaiter-counterweight guides.

Rule 108 Pipes and Wiring

a The electrical conductors installed in or under an elevator or counterweight hoistway except the flexible cables connecting the car with the fixed wiring, shall be encased in metal conduits or shall be armored cables.

No pipes, except those used to furnish or to control power, light, heat or signals for the elevator or hoistway shall be installed in or under any elevator or counterweight hoistway.

No electrical conduits or cables, except such as are used to furnish or control power, light, heat or signals for the elevator or hoistways, shall have an opening, terminal, outlet or junction within the hoistway.

Pipes, conduits and armored cables shall be securely fastened to the hoistway to prevent their becoming displaced by accidents on or to the elevator.

b No part of any electric circuit having a nominal voltage rating in excess of 750 volts shall be used on any car-control system. Circuits of higher nominal voltage rating may, however, be used in machine rooms or pent-houses for the operation of motors, provided that all control and signal wiring is thoroughly insulated from the power circuit and all machine frames and metal hand ropes are thoroughly grounded.

c All live parts of electrical apparatus in elevator hoistways shall be protected against accidental contact of current-carrying parts by suitable metal enclosing coverings. These coverings shall be thoroughly grounded. All wiring shall comply with the requirements of the National Electrical Safety Code, and with the National Electric (Fire) Code.

Rule 109 Thoroughfare Under Hoistways

a No thoroughfare shall be permitted across the hatch cover of a hoistway whether inside or outside of a building, except over the hatch cover at the top landing of a platform or sidewalk elevator.

b A hatch cover of the vertical lifting type for a platform elevator shall not be used as a thoroughfare nor for storage or a similar purpose unless there is a space of 2 ft. above the hatch cover when at the top of its travel.

c A hatch cover of the swinging type for a sidewalk elevator shall not be arranged to open against the building nor shall it be used as a thoroughfare unless when vertically opened there is a space of 18 in. between the covers and any obstruction in the direction of opening.

d There shall be no thoroughfare under the hoistway of any elevator, dumbwaiter or counterweight unless all of the following conditions exist:

- 1 The elevator car and counterweights shall be provided with bumpers or buffers capable of stopping the car or counterweight when descending at rated speed with rated load.
- 2 The car and counterweights shall be provided with safety devices conforming to the requirements for such devices. (See Rules 304 and 403.)
- 3 There shall be a floor under the hoistway, sufficiently strong to withstand without injury the impact of the car or counterweight descending at rated load and speed (governor tripping speed where governor is used).

Section II Hoistways Guards and Screens

Rule 110 Standard Guards

a The standard railings, toe-boards, guards for cables and machinery, etc., mentioned in this Code shall conform to the requirements of the A.S.M.E. Code of Safety Standards for Power Transmission Machinery.*

Rule 111 Hoistway Enclosures

a Where fireproof construction is not required, hoistways shall be enclosed to a height not less than 6 ft. from each floor on all sides not used for loading or unloading, except that the hoistways of dumbwaiters serving more than two floors shall be enclosed from floor to ceiling. (See Rule 111g.)

b Where an elevator is located adjacent to a stairway, that portion of the hoistway adjoining the stairway shall be enclosed to a height of not less than 6 ft. above each stair tread.

c The hoistways of passenger and freight elevators shall be enclosed from floor to ceiling on the sides used for loading or unloading, except

- (1) Platform elevators within a building having a travel not exceeding 15 ft.
- (2) Sidewalk elevators having a travel not exceeding 30 ft.
- (3) Elevators operating through automatic hatch covers
- (4) Elevator cars having gates provided with car gate electric contacts.

(See Rule 102c.)

The enclosure shall be not more than 4 in. from the edge of the car platform.

d Enclosures shall be building walls, solid or latticed partitions, grille work, metal grating, expanded metal, or wood.

Where wire grille work is used, the wire shall be not less than No. 13 Std. W. Gage (0.0915 in. diam.), and the mesh shall be not greater than two inches.

Where expanded metal is used, the thickness shall be not less than No. 13 U. S. Gage (0.094 in. diam.).

Wood slats shall be not less than one-half inch thick.

The spacing between vertical bars or slats shall be not greater than one inch, except where used as "filling" material required in Rule 102. In this case the spacing between vertical bars or slats shall be not greater than 4 in.

*This code is included and will be found following the Elevator Code.

e When any of the following conditions exist, openings shall be covered with a netting of square mesh not greater than one-half inch and of wire not smaller than No. 20 Std. W. Gage (0.0348 in. diam.):

- (1) The clearance between the enclosure and any part of the car, counterweight or any sliding landing door is less than one inch.
- (2) The enclosure is grille or openwork having openings which will pass a 1½-in. diameter ball.
- (3) The openings in the enclosure are within reach of a person standing on a landing, stairway, floor or car platform.

f Projections extending inward one inch or more from the general surface of the hoistway, and which are opposite a car entrance shall be beveled on the under side at an angle of not less than 60 deg. from the horizontal or shall be guarded with metal plates or by wood faced with metal of not less than No. 16 U. S. Gage (0.0625 in.). These plates or guards shall be firmly and permanently fastened to the hoistway walls.

g Recesses, other than windows, in the general surface of the hoistway for a power freight elevator, which are opposite a car opening, shall be filled in flush with the general surface of the hoistway to comply with the requirements of Rule 111d.

The upper surface of a recess formed by vertical bars shall be beveled on the under side as specified for projections in Rule 111f.

For windows see Rule 103a.

h Hoistways for freight elevators having hatch covers as set forth in Rule 112 will be accepted in lieu of the enclosure herein required provided that in addition to such hatch covers the hoistway shall be guarded on all sides not used for loading and unloading, by a standard railing and toe-board as described in Rule 110. Such railing shall be placed not less than 12 in. from the general line of the hoistway. See Rule 111a.

i The hoistway enclosure adjacent to a landing opening shall be of sufficient strength to support in true alignment the landing doors and gates with their operating mechanism and interlocks.

Rule 112 Protection of Hatch Openings

a Automatic hatch covers shall be capable of sustaining a load of 50 lb. per sq. ft. when closed. The hatch covers of sidewalk elevators shall, when closed, be capable of sustaining a live load of 300 lb. per sq. ft. The dimensions of sidewalk openings shall not exceed 5 ft. at right angles to the curb, and 7 ft. parallel to the curb, unless state laws or local ordinances permit otherwise.

b Wood hatch covers shall be metal clad on their under side and ledges, except at the top landing of sidewalk elevators.

c Hinged hatch covers shall not be permitted if the elevator cars have a clear platform area of more than 50 sq. ft. Hinges of hatch covers shall be of sufficient strength and be securely fastened to withstand the service of normal operation.

d No means shall be provided for fastening hatch covers open, except for sidewalk elevators. The hoistway of sidewalk elevators having hatch covers arranged to remain open, when the elevator is not at the sidewalk landing, shall be guarded on the exposed side or sides by a gate or bar.

Rule 113 Counterweight Runway Enclosures

a Runways for counterweights located outside of the elevator hoistway and for elevators operating through auto-

matic hatch covers shall be enclosed throughout their height, except if located outside of building. In this case the runway shall be enclosed to a height of at least 7 ft. from the ground.

b Counterweight runways located in the elevator hoistway shall be enclosed from a point 12 in. above the floor of the pit to a point at least 7 ft. above the floor of the pit except where compensating chains or cables which practically compensate for the weight of the hoisting cables are used. In this case counterweight enclosures shall be prohibited on the side facing the elevator.

c Access shall be provided for inspection, maintenance and repair of all counterweights and cables. Where swinging doors provide access, they shall be equipped with spring hinges to close the doors.

Rule 114 Cable Enclosures

a Where cables pass through floors outside the hoistway enclosures, such cables shall be guarded to a height of at least 6 ft. from each floor with a standard power-transmission guard. (See Rule 110.). The floor openings shall be not greater than necessary for the free passage of the cables.

Rule 115 Gate Counterweight Enclosures

a Gate or door counterweights shall run in metal guides from which they cannot become dislodged or shall be "boxed in." The bottoms of the boxes or the guides shall be so constructed as to retain the counterweights if the counterweight rope breaks.

Rule 116 Hoistway Door Interlock

a The functioning of a hoistway door interlock, to prevent the movement of the car, shall not be dependent on the action of springs in tension, nor upon the closing of an electric circuit.

b The failure of this interlock to perform the locking function shall prevent the starting of the car from the landing.

c The force or forces used to perform any interlocking function to prevent the movement of the car shall be such that even without lubrication the intended functioning of the interlock shall be completely performed.

Rule 117 Electric Contact

a The functioning of an electric contact, to prevent the movement of the car, shall not be dependent upon the action of springs in tension nor upon the closing of an electric circuit.

b The force or forces employed to open the contact shall be such that even without lubrication of the mechanism the intended functioning of the electric contact shall be completely performed.

Rule 118 Emergency Release

a The emergency release shall be in the car, plainly visible to the occupants of the car and reasonably, but not easily, accessible to the operator.

b To operate the car under emergency conditions it shall be necessary for the operator to hold the emergency release in the emergency position. The emergency release shall be so constructed and installed that it cannot be readily tampered with or "plugged" in the emergency position.

c Rods, connections and wiring used in the operation of the emergency release, that are accessible from the

car, shall be enclosed to prevent being tampered with readily.

Section 12 Landings

Rule 120 Hoistway Doors for Passenger Elevators

a No automatic fire door, the functioning of which is dependent on the action of heat, shall lock any landing opening in the hoistway of any passenger elevator nor any exit leading from any hoistway landing door to the outside of the building.

b Landing openings in passenger-elevator hoistways shall be protected by sliding doors, combination sliding and swinging doors, or by swinging doors. See Rule 100b.

c The distance between the inside of the inner panel of any landing door and the edge of the landing threshold opposite the car opening, shall be not more than 4 in. No hardware, except that required for interlocking devices, shall project into the hoistway beyond the line of the landing threshold. The lower edge of the interlocking devices shall be beveled as required for projections in Rule 111f.

d Hoistway door interlocks which conform to Rule 116 shall be used on the hoistway doors of power passenger elevators.

e Provision shall be made to render the car operative independent of the position of the landing doors, in case of fire, panic, or other emergency, by means of an emergency release conforming to Rule 118.

f Hoistway doors for hand passenger elevators shall be equipped with interlocks, unless (1) hoistway gates which close when the car leaves the landing are installed in addition to the hoistway doors, or (2) each hoistway door is made in two parts, one above the other, the lower part being not less than 30 in. above the floor and arranged to be opened only after the upper part has been opened.

g Hoistway doors shall be arranged to be opened by hand from the hoistway side, except when locked "out of service." Neither the main exit doors nor the doors at the lower terminal landing shall be locked "out of service" while the elevator is in operation.

h If the entire control is located on the car, the hoistway doors shall be so arranged that they cannot be opened from the landing side, except by a key or a special mechanism. If the control is not located entirely on the car, the hoistway doors shall be so arranged that unless the car is at the landing, the doors cannot be opened from the landing side except by a key or a special mechanism.

i Provision shall be made for opening at least one landing door, preferably the ground floor-door, from the landing side by means of a key or a special mechanism.

j Landing doors for passenger elevators shall be so arranged that it is not necessary to reach back of any panel, jamb or sash to operate them.

Rule 121 Hoistway Doors and Gates for Freight Elevators

a Landing openings in freight-elevator hoistways, except for one-story sidewalk elevators, shall be equipped with doors or gates having resistance to fire equal to that specified in Rule 100a.

Landing openings in the outside wall of a building shall be equipped with doors complying with the fire-resisting requirements for doors in such walls.

b Hoistway doors or gates shall withstand a force of 75 lb. applied perpendicularly to the door or gate at any point without permanent deformation and without being sprung from their guides.

c Hoistway gates made of grille, lattice or other open-work shall reject a ball 2 in. in diameter.

d Gates shall extend from the landing threshold to a height of at least 66 in. when closed, unless lack of head room makes gates of this height impracticable.

In this case the gates shall be not less than 42 in. high, and—except for elevators operating through automatic hatch covers—shall be set back at least 12 in. from the landing threshold or the car shall be provided on landing sides with warning chains suspended from the car platform.

Warning chains shall be not less than 3 ft. long and spaced not more than 6 in. apart. They shall be made of wire not smaller than No. 7 StL W. Gage (0.177 in. diam.), and shall be fastened to wood sills or cleats with one-inch staples.

Where lack of head room prohibits a standard gate at the lowest landing, the bottom rail of the gate may be placed not more than 18 in. above the floor.

e Collapsible gates are not recommended but if used shall be so made and guarded as to prevent accidents due to shear.

f The hoistway doors or gates for freight elevators shall be provided with interlocks or electric contacts and locks except when semi- or full automatic gates or doors are used. Interlocks and electric contacts shall conform to the requirements of Rules 116 and 117, respectively.

g Provision shall be made to render the car operative independent of the position of the landing doors, in case of fire, panic or other emergency, by means of an emergency release conforming to the requirements of Rule 118.

h Terminal landing openings and intermediate landing openings of elevators for carrying automobiles and trucks, in the hoistways of elevators operating at a speed not in excess of 75 ft. per min. may be provided with full automatic doors or gates.

i Hoistway doors or gates closed by gravity and not by direct motion of the car shall be permitted only if the car speed does not exceed 75 ft. per min.

j Semi-automatic gates or doors shall be provided with a locking device which will prevent the normal opening of the gate or door unless the car floor is at or near the landing.

Rule 122 Doors at Dumbwaiter Landings

a Landing openings in dumbwaiter hoistways, except at the upper terminal landing of "under-counter" dumbwaiters serving only two adjacent floors shall be equipped with doors or gates, unless the bottom of the openings is not less than 30 in. above floor level.

b The upper terminal landing opening of "under-counter" dumbwaiters serving more than two adjacent stories shall be provided with means to guard persons from falling down the hoistway.

c Landing doors of power dumbwaiters serving two adjacent floors may be counterweighted to remain open if the bottom of the door is not less than 18 in. above the floor.

d Landing openings for "button control" dumbwaiters serving more than two landings shall be protected with gates or doors equipped with electric contacts which prevent the operation of the machine while any hoistway gate or door is open.

e Landing doors of dumbwaiters, if the bottom of the openings is less than 30 in. above the landing floor and the door opening is large enough to be mistaken for a door to a room, shall be in two parts, one above the other, the lower part being not less than 30 in. high above the floor, arranged

to be opened only after the upper part has been opened, except where gates which close when the car leaves the landing are installed in addition to the landing doors.

f Landing openings of power dumbwaiters serving three or more floors shall be provided with doors or gates, the fire-resisting qualities of which are equal to those specified in Rule 100a.

Rule 123 Landing Floors for Passenger and Freight Elevators

a Smooth metal plates, except such metal as is necessary for supports, shall not be used for the landings of passenger elevators and are not recommended for freight elevators.

b If there is a railroad track upon any elevator landing, the tops of the rails shall be flush with the floor for a distance of 6 ft. from the threshold.

Rule 124 Lighting at Landings

a When the car is in service at the landing, the landing edges of the threshold and car platform shall be plainly visible. The minimum allowable illumination on car floor and landing threshold shall be 0.75 foot-candle.

Section 13 Machine Rooms

Rule 130 Machine-Room Location

a Elevator machine rooms shall be provided with ample illumination.

b Power elevator machines shall be surrounded by substantial grille work or other enclosure unless located in machine, engine or pump rooms in charge of an attendant or secured against unauthorized access.

Rule 131 Access to Machinery

a Safe and convenient access shall be provided to elevator machinery. This access shall be exterior to and independent of the hoistway or car. If the parts are located on or over a platform at the top of the hoistway, access shall be above the level of the platform, if practicable.

b Exposed gears, belts and other moving parts of elevator machinery shall be guarded in accordance with the standards referred to in Rule 110.

Power Freight Elevators

Section 30 Car Construction and Safeties for Power Freight Elevators

Rule 300 Car Construction

a Power freight-elevator car enclosures shall not deflect more than one-fourth of an inch if subjected to a force of 75 lb. applied at any point perpendicularly to the car enclosure. The car enclosure shall be secured to the car floor and frame in such a manner that it cannot work loose or become displaced in ordinary service.

b Power freight-elevator cars shall have steel frames designed with a factor of safety of at least six based on the rated load uniformly distributed. Elevators of the plunger type which are not provided with counterweights need not comply with the requirements of this paragraph.

Elevators for carrying automobiles shall have car platforms of sufficient strength to support safely 70 per cent of the live load concentrated equally at any two points 56 in. apart on a line parallel with the entrance sill of the car.

c Except for cable anchorages no cast iron in tension shall be used for a suspension member of any car frame.

d Power sidewalk elevators shall be provided with either flat metal tops or arched bows of sufficient strength to

open the hatch cover, or be provided with some device that will stop the car before a person riding on it could be injured, if the hatch cover should fail to open.

e If there is a railroad track on the elevator car, the tops of the rails shall be flush with the car platform.

f Elevator cars shall be lighted at all times when in use. Electric light shall be used if current is available. The intensity of illumination shall be not less than 0.75 foot-candle at the edge of the car platform.

g No glass shall be used in elevator cars except to cover certificates and appliances necessary for the operation of the car. No piece of glass shall exceed one square foot in area.

Rule 301 Car Compartments

a No power freight-elevator car except mine hoists and special elevators upon which no persons are permitted to ride, shall have more than one compartment.

Rule 302 Car Enclosures

a Cars for power freight elevators other than platform elevators shall be enclosed at sides except the openings necessary for loading and unloading, to a height of at least 6 ft., or to the crosshead if the crosshead is lower.

b The car enclosure either "openwork" or solid may be of metal or wood.

If of "openwork" it shall reject a ball 2 in. in diameter. If the openings are larger than one-half inch square they shall be covered to a height of at least 6 ft. from the car floor with wire netting of not more than one-half inch square mesh and of wire not smaller than No. 20 Stl. W. Gage (0.0384 in. diam.), where the clearance to any part of the hoistway structure or the counterweight is less than 5 in.

c If the car enclosure is cut away at the front to provide access to the shipper rope, the enclosure shall be cut low enough to prevent injury to the operator's hand.

d Power freight-elevator cars—except for (1) elevators operating through automatic hatch covers, (2) sidewalk elevators, (3) platform elevators, (4) elevators having automatic closing gates extending to the floor on all landings above the lowest landing, (5) elevators with landing doors which open only from the hoistway side except by

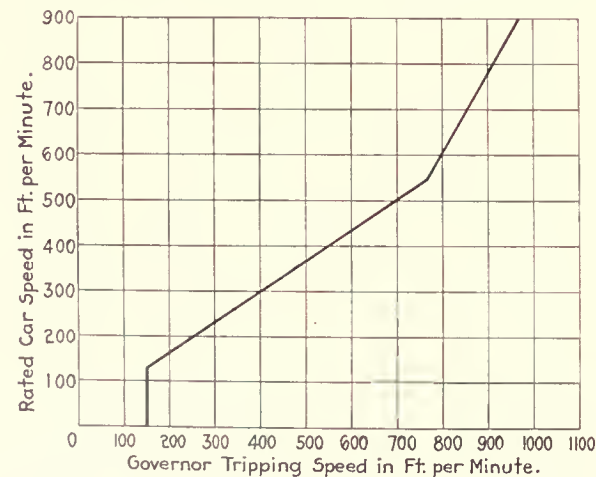

Curve 1—Governor Tripping Speed for a Given Car Speed

a key and which are kept closed unless the car is at the landing—shall be equipped with solid-top covers of wire grille work having a mesh that will reject a ball 1½ in. in diameter and of wire not less than No. 10 Stl. W. Gage (0.135 in. diam.) or its equivalent. The top or cover shall

be sufficiently strong to sustain a load of 150 lb. applied to any point.

e Car gates or doors for freight elevators when closed shall fill the openings they guard, except that they need not be more than 6 ft. high.

f Elevators operating in hoistways outside the building which are guarded only at the ground landing, shall be protected on the exposed side or sides either by independently operated bars or gates equipped with electric contacts, or by semi-automatic bars or gates.

Rule 303 Cars Counterbalancing One Another

a Power freight-elevator cars shall not be arranged to counterbalance one another if persons are permitted to ride on them, or to step on them for the purpose of loading or unloading unless hoistway gates or doors are provided which are equipped with door interlocks or electric contacts.

Rule 304 Car Safeties and Speed Governors

a Freight elevators suspended by cables shall be provided with a "safety" attached to the underside of the car frame and capable of stopping and sustaining the car.

The "safety" shall be so constructed that if applied it cannot decrease its retarding force until the car has stopped and that no decrease in the tension of the governor cable or motion of the car or counterweight in the descending direction shall release the "safety."

b The speed governor shall be "set" to cause the application of the "safety" if the speed of the descending car exceeds the normal speed by an amount given in Curve 1. No "car safety" shall be permitted for stopping an ascending car. If a "safety" is used to stop an ascending car, the "safety" shall be applied to the counterweight.

c For elevators having a speed in excess of 100 ft. per min. the "safety" shall be operated by a speed governor that the retardation of the car shall never exceed 64.4 ft. per sec. per sec.

d The governor shall be located where it cannot be struck by the car in case of overtravel.

e The motor and brake-control circuit shall be opened before at the time the governor trips.

f The governor cable shall be of iron, steel or phosphor bronze. The cable shall not be less than three-eighths inch in diameter.

g The arc of contact of the governor rope and its driving sheaves shall, in conjunction with a tension frame, provide sufficient traction to cause proper operation of the governor.

h Elevators having drum machines except those having a travel of not more than 15 ft., shall be provided with a "slack cable" device which will cut off the power and stop the elevator machine if the car is obstructed in its descent.

i No "car safety" which depends on the completion or maintenance of an electric circuit for the application of the "safety" shall be used. "Car safeties" shall be applied mechanically.

j The gripping surfaces of car or counterweight "safeties" shall not be used to guide the car or counterweights.

k A pawl and ratchet shall not be considered a sufficient safety device.

l The car and counterweights shall respectively be brought to rest on the bumpers before the counterweights or car pass their limits of overtravel at the top of the hoistway.

Rule 305 Car Safety Tests

a A rated capacity test shall be made of every new elevator before the elevator is placed in regular service.

b Every installation of a "safety" designed to sustain the car shall be tested with the rated load on the car.

c The application of the "safety" by a speed governor shall be obtained by causing the car to descend at the governor tripping speed corresponding to the normal speed of the car as indicated in Curve 1.

Rule 306 Capacity and Loading

a A metal plate shall be provided by the elevator manufacturer which shall be fastened in a conspicuous place in the elevator car and shall bear the following information in not less than one-fourth-inch letters and figures, stamped in, or etched or raised on the surface of the plate:

- 1 The capacity of the elevator in pounds
- 2 The normal rated speed at which the elevator is designed to operate.
- 3 The cable data required in Rule 330b.

The capacity of the elevator shall be indicated in a conspicuous place in the elevator car by the word CAPACITY, followed by figures giving the rated capacity in pounds, in figures and letters not less than one inch in size.

b No freight elevator shall be used for carrying safes or other concentrated loads greater than the rated capacity of the elevator, unless the elevator is provided with a "safe-hoisting" attachment, designed for the "safe-lift" load. The car platform, car slings, sheaves, shafts and cables shall be designed for the "safe-lift" load with a factor of safety of not less than five. The car "safeties" for this type of elevator need not be designed to hold the "safe-lift" load.

Section 31 Counterweights, Bumpers and Guides for Power Freight Elevators

Rule 310 Counterweights

a Counterweights shall run in guides.
 b If two counterweights run in the same guides, the car counterweights shall be above the machine counterweights and there shall be a clearance of 8 in. between the counterweights.
 c If an independent car counterweight is used, it shall not be of sufficient weight to cause slackening in any of the cables during acceleration or retardation of the car.

d Counterweight sections, whether or not carried in frames, shall be secured by at least two tie rods passing through holes in all the sections. The tie rods shall have lock nuts at each end. The lock nuts shall be secured by cotter pins.

Rule 311 Car and Counterweight Bumpers or Buffers

a Car bumpers or buffers shall be installed in the pits under power freight elevators.

b Solid bumpers may be used with elevators having a speed of 50 ft. per min. or less.

Spring bumpers or their equivalent shall be used with elevators having a speed greater than 50 ft. per min., and not exceeding 250 ft. per min.

Oil buffers or their equivalent shall be used with elevators having a speed greater than 250 ft. per min.

Bumpers and buffers shall stop the car when descending at governor tripping speed with its rated load or, in the case of plunger elevators, at the maximum allowable operating speed without exceeding the operating limits of the bumpers and buffers. The bumpers and buffers shall be so designed that with one person in the car the bumper or buffer shall cause a retardation of the car of not more than 64.4 ft. per sec. per sec. (See Curve 1.)

c Bumpers or buffers shall be located symmetrically with reference to the center of the car.

d Adequate provision in the design of plunger elevators shall be made if the bumpers are required to stop the plunger as well as the car.

e Counterweight bumpers or buffers similar to those required for cars in Rule 311b shall be installed under the counterweights of freight elevators.

Rule 312 Guide Rails

a Guide rails for both the car and the counterweights of all elevators shall be of steel except for elevators having a travel of not more than 100 ft. and operating at a speed not in excess of 100 ft. per min.

It is recommended, however, that steel guide rails be used for all power freight-elevator installations.

Guide rails particularly where in contact with the guide shoes when the car is at the landing shall be securely fastened with iron or steel brackets (or their equivalent) of such strength, design and spacing that the guide rails and their fastenings shall not deflect more than one-fourth inch under normal operation.

They shall withstand the application of the "safety" when stopping a fully loaded car or the counterweight. The guiding surface of the guide rails for elevators requiring "safeties" shall be finished smooth and the joints shall be tongued and grooved or doweled.

Guide rails and their fastenings shall be secured in position by through bolts of not less than the following sizes:

6½ and 7½-lb. rails.....	½-in. bolts
14-lb. rails.....	¾-in. bolts
30-lb. rails.....	¾-in. bolts

The guide rails shall be "bottomed" on suitable supports and extended at the top to prevent guide shoes from running off in case the overtravel is exceeded.

Cast iron shall not be used for guide rails.

Where the use of steel rails would present an accident hazard, as in chemical or explosive factories, wood guide rails may be used for any rise or car speed.

b The weight of steel guide rails shall be not less than as given in Table VI.

TABLE VI. WEIGHT PER LINEAL FOOT OF EACH GUIDE RAIL IN POUNDS

Total Weight of Car and Load, and Total Weight of Counterweights, Lb.		Weight of Each Car Guide Rail, Lb.	Weight of Each Counterweight Guide Rail, Lb.	
			With Guide-Rail Safeties	Without Guide-Rail Safeties
Above 0	Up to and Including 4,000	7½	1 to 1 Roping 6½	2 to 1 Roping 6½
4,000	15,000	14	7½	7½
15,000	40,000	30	30	14

d The size of wood guide rails, where permitted, shall be not less than given in Table VII.

TABLE VII. SIZE OF WOOD GUIDE RAILS

Maple Guide Rails		Yellow Pine Guide Rails		Size of Each Guide Strip in Inches
Above	Up to and Including	Above	Up to and Including	
0	5,000	0	3,500	2 × 5½
5,000	8,000	3,500	5,500	2½ × 3
8,000	10,000	5,500	6,500	3 × 6
10,000	14,000	6,500	9,000	4 × 5½
.....	9,000	23,000	5 × 7
.....	23,000	35,000	6 × 8

Section 32 Machines and Machine Safeties for Power Freight Elevators

Rule 320 Machines and Machinery

a Drums and leading sheaves shall be of cast iron or steel, and shall have finished grooves. Grooves shall be not more than one-sixteenth inch larger than the cables.

b The factors of safety based on the static loads (the

loads specified in Rule 306a, plus the weight of the car, cables, counterweights, etc.), to be used in the design of hoisting machines shall be:

8 for wrought iron or wrought steel

10 for cast iron, cast steel or other materials.

c Set-screw fastenings shall not be used in lieu of keys or pins.

d Worm gears having cast-iron teeth shall not be used to drive power freight-elevator drums or sheaves.

e Winding drum and traction machines for freight elevators shall be equipped with brakes which are applied automatically by springs or gravity when the control is at the "stop" position. Electric freight-elevator machines shall be equipped with electrically released brakes.

Except when the rated load will not, within the limits of travel, accelerate the car speed above 150 per cent of normal speed, the brakes shall not be released until power has been applied to the motor.

f The action of the brake magnet shall not be retarded by any motor field discharge or counter voltage or by any single ground or short-circuit.

Rule 321 Hydraulic Machines

a Hydraulic-elevator machines whether of the vertical or horizontal type shall be so constructed that the piston will be stopped before the car can be drawn into the overhead work. Stops of ample strength shall be provided to bring the piston to rest, when under full pressure, without causing damage to the cylinder or cylinder head.

b The traveling sheaves for vertical hydraulic elevators shall be guided. The guide rails and guide shoes shall be of metal.

c The side frames of traveling sheaves for vertical hydraulic elevators shall be either of structural or forged steel.

The construction commonly known as the "U-strap connection" shall not be used between the piston rods and traveling sheaves.

d Where more than one piston rod is used on the vertical pulling type, an equalizing crosshead shall be provided for attaching the rods to the traveling sheave frame, to insure an equal distribution of load on each rod.

When more than one piston-rod is used, equalizing or cup washers shall be used under the piston-rod nuts to insure a true bearing.

e Cylinders of hydraulic-elevator machines shall be provided with means of releasing air or other gas.

f Piston rods of tension-type hydraulic elevators shall have a factor of safety of not less than eight, based on the sectional area at the root of the thread. A true bearing shall be maintained under the nuts at both ends of the piston rod to prevent any eccentric loading on the rods.

g Pressure tanks shall be designed so that the proportion of the air or other gas to the liquid therein will prevent the probability of the entrance of air or other gas into the elevator cylinder.

h Hydraulic elevators shall be provided with an independent automatic means for gradually stopping the car at the upper and lower terminal landings independently of the operator.

If the speed of the elevator does not exceed 150 ft. per min., the means employed may operate in combination with the car-control mechanism and the main operating valve.

If the speed of the elevator exceeds 150 ft. per min., an automatic stop valve shall be provided for this purpose.

This valve shall be independent of the main operating valve and preferably in the piping between the main operating valve and the cylinder.

Automatic stop valves for elevators shall be packed with cup leathers, or other means shall be used to prevent sticking of the valve stems.

i Every pump connected to the pressure tank of a hydraulic freight elevator shall be equipped with a relief valve so installed that it cannot be shut off. The relief valve shall be of sufficient size and so set as to pass the full capacity of the pump at full speed without exceeding the safe working pressure of the pump or tank. Two or more relief valves may be used to obtain the capacity. The relief valves shall be piped to discharge into the discharge tank or the pump suction.

j Elevator pumps, unless equipped with pressure regulators which control the motive power, shall be equipped with automatic by-passes.

k Pressure tanks shall be made and tested in accordance with the A.S.M.E. Boiler Code requirements for hydraulic pressure vessels.

l Each pressure tank shall be provided with a water-gage glass having brass fittings and valves, attached directly to the tank and so located as to show the level of the water when the tank is more than half filled.

Every pressure tank shall have a pressure gage which correctly indicates pressure to at least $1\frac{1}{2}$ times the normal working pressure allowed in the tank. This gage shall be connected to the tank by a brass or other non-corrodible pipe in such a manner that the gage cannot be shut off from the tank except by a cock with a "T" or lever handle (the "T" or lever set in line with the direction of the flow). The cock shall be in the pipe near the gage.

The tank shall be provided with a one-quarter inch pipe-size valved connection for attaching an inspector's gage when the tank is in service. This is for testing the accuracy of the pressure gage.

m Pressure tanks that may be subjected to vacuum shall be provided with one or more vacuum valves to prevent collapse of the tanks.

Vacuum valves shall have openings of sufficient size to prevent the collapse of the tank if a vacuum occurs. If necessary more than one vacuum valve may be used to obtain sufficient capacity.

n Pressure tanks shall be so located and supported that inspection may be made of the entire exterior.

o Discharge tanks open to atmosphere shall be so designed that when completely filled the factor of safety shall be not less than four based on the ultimate strength of the material. Discharge tanks shall be covered to prevent the entrance of foreign material and provided with a suitable vent to the atmosphere.

p Hydraulic elevators operated from a pressure tank where the fluid pressure is obtained by directly admitting steam or air to the tank shall comply with all the rules covering hydraulic elevators.

Rule 322 Belted Machines

a Belt or chain-driven freight-elevator machines shall be operated at a car speed not in excess of 60 ft. per min.

b If the machine is not driven by a separate motor, means, such as tight and loose pulleys or clutches shall be provided for throwing the power "off" a belt-driven machine.

c Elevator belts within 7 ft. of the floor except when

located within machine enclosures shall be guarded in accordance with the standards mentioned in Rule 110.

Rule 323 Machine Safeties and Terminal Stops

a Power freight elevators shall be provided at each end of the hoistway with at least two independent means exclusive of the manually-operated car control (car switches, push buttons, hand rope or lever devices, etc.) to automatically stop the car within the limits of overtravel.

Suitable bumpers or buffers will be considered one of the independent means required by this rule for elevators having traction machines.

Stop balls securely fastened to the shipper ropes may be considered one of the independent means of stopping required by this rule.

For sidewalk elevators having drum machines and for double-belted elevators, if one or more speeds slower than normal speed are used the slow-down device shall not be considered one of the independent means of stopping required by this rule.

b Electric elevators operated by polyphase alternating-current motors shall be provided with relays of the potential type which will prevent starting the motor if—

- (1) The phase rotation is in the wrong direction or
- (2) There is a failure in any phase.

Rule 324 Control

a No freight elevator having a speed greater than 100 ft. per min. shall be controlled by a direct hand-operated rope, cable or rod.

b No freight elevator, except hydraulic elevators, having a speed greater than 150 ft. per min. shall be controlled by a rope or cable operated by a wheel or lever mechanism.

c No shipper rope shall be accessible from the outside of a building, if the elevator hoistway is in or adjacent to the building.

d Overhead tension weights for shipper ropes shall be secured by chains or cables attached to the weights and to a suitable anchorage.

e Guards, which will keep the ropes from leaving the sheaves, shall be installed unless means are used to maintain the shipper ropes in proper tension.

f Power freight elevators operated by means of a direct-operated hand rope—except sidewalk elevators—shall be provided with a centering device which will insure the operating mechanism being placed in the stop position when it is desired to stop the car.

g The handle of the “car switch” located on the car of “car switch”-controlled elevators—except those having “button control”—shall be arranged to return to the “stop” position and lock there automatically when the hand of the operator is removed. The push buttons of button-control elevators shall be arranged to return to the “open” position when the hand of the operator is removed.

h No part of any electric circuit having a nominal voltage rating in excess of 750 volts shall be used as any part of a power freight-elevator control system.

i “Car-switch”-controlled elevators shall have an emergency switch adjacent to the control apparatus on the car to cut off the source of power. This emergency switch shall be located within easy reach of the operator.

In button-controlled elevators the stop button on the car may be used as the emergency switch if it is a red button marked “STOP.”

j The breaking of a circuit to stop an automatic button-

control elevator shall not depend solely on the operation of a spring or springs nor upon the completion of an electric circuit.

k A manually-operated disconnecting switch shall be installed in the main line of electrically controlled elevator machines. This switch shall be located adjacent to and visible from the elevator machine. No provision shall be made to close this disconnecting switch from any other part of the building.

l The frames of electric-elevator machines shall be grounded. Shipper ropes shall be grounded if insulated from the machines.

m Electric “slack cable” switches shall be enclosed.

n No control system shall be used which depends on the completion or maintenance of an electric circuit for the interruption of the power, for the application of electro-mechanical brakes, for the operation of “safeties,” nor for the closing of a contactor by an emergency stop button, except that this paragraph does not apply to dynamic braking and speed-control devices.

o In elevators having “car switch” or hand-lever control, the lever shall be so arranged that the movement of the lever toward the opening (which the operator usually faces) will cause the car to descend and a movement of the lever away from the opening will cause the car to ascend.

p Power freight elevators controlled by shipper ropes, except

- (1) sidewalk elevators
- (2) elevators equipped with an emergency switch
- (3) elevators equipped with interlocks or electric contacts

shall be equipped with shipper rope locks for holding the car at any landing.

q No circuit breaker operated automatically by a fire-alarm system shall cut off either the power or the control from a power freight elevator.

r Automatic button-control elevators shall conform to the following requirements:

- 1 If the car has started for a given landing it shall be impossible to give an impulse from any landing to send the car in the reverse direction until the car has reached the destination corresponding to the first impulse. The car may, however, be stopped at any intermediate landing to take on or discharge attendants or freight going in the original direction.
- 2 If the car has been stopped to take on or discharge attendants or freight and is to continue in the direction determined by the first impulse, the closing of the car gate may be sufficient to start the car.
- 3 It shall not be possible to start the car under normal operation unless every hoistway door is closed and locked in the closed position. (Hoistway Unit System.)

Rule 325 Limits of Speed, Acceleration and Retardation

a No platform elevator shall have a speed greater than 30 ft. per min.

b The speed of elevators operating through automatic hatch covers shall not exceed 50 ft. per min.

c Except automatic button-control elevators and elevators controlled exclusively by an authorized person, no

power freight elevators shall have a speed not in excess of 100 ft. per min.

d Under normal operation, no power freight elevator shall be accelerated or retarded at a rate greater than 10 ft. per sec. per sec., unless the normal speed exceeds 800 ft. per min. In this case an acceleration or retardation of 14 ft. per sec. per sec. is allowable.

Rule 326 Limits of Travel for Freight (Sidewalk) Elevators

a No sidewalk elevator having a travel greater than 30 ft. shall be installed unless it complies with the regulations for power freight elevators.

Section 33 Cables and Signal Systems for Power Freight Elevators

Rule 330 Hoisting Cables

a Car and counterweight cables for power freight elevators shall be of iron or steel without covering except that marline-covered cables are permitted where liability to excessive corrosion or other hazard exists. Hoisting chains may be used only for power platform and sidewalk elevators.

b Where drum machines are used, the capacity plate required in Rule 306a shall bear the following information:

CABLE SPECIFICATIONS

Cable	Number	Diameter in Inches	Rated Ultimate Strength in Pounds
Hoisting
Car counterweight.....
Machine counterweight..

Where traction machines are used, the capacity plate required in Rule 306a shall bear the following information:

CABLE SPECIFICATIONS

	Number	Diameter in Inches	Rated Ultimate Strength in Pounds
Hoisting cables.....

Where hydraulic machines are used, the capacity plate required in Rule 306a shall bear the following information

CABLE SPECIFICATIONS

Cable	Number	Diameter in Inches	Rated Ultimate Strength in Pounds
Hoisting
Car counterweight.....

In addition a metal tag shall be attached to the cable fastenings. On this tag shall be stated the diameter, ultimate strength and material of the cables, and the date of the cable installation.

c Where the ultimate strength and material of the cables are not known, the loads shall be limited to the loads for iron cables of the same diameter.

d The factor of safety for car and counterweight cables for power freight elevators shall be not less than the values given in Curve 2, corresponding to the speed of the car.

e The diameter of the cables shall be determined by using the factor of safety found in Rule 330d, together with the ultimate strength of the cable. The computed load on the cable shall be the weight of the car plus its rated load. See Rule 306.

f All cables anchored to a winding drum shall have not less than one complete turn of cable around the winding drum when the car or counterweight has reached the extreme limit of its travel.

g The diameter of a sheave or winding drum for a car or counterweight cable shall be not less than 38 times the diameter of the cable with which it is used except for sidewalk elevators.

h No car or counterweight cable shall be lengthened or repaired by splicing.

i The drum ends of car or counterweight cables shall be secured by clamps on the inside of the drums or by one

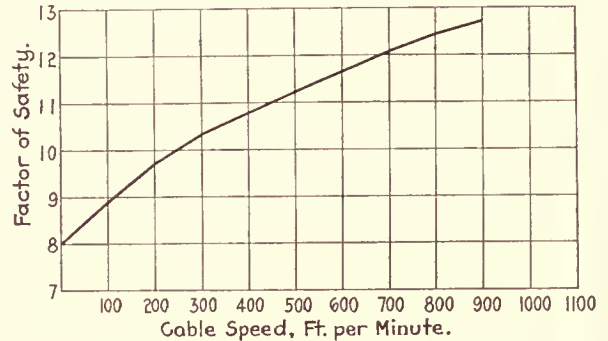

Curve 2—Factors of Safety for Hoisting Cables for Traction Machine Freight Elevators. (Drum Machine Freight Elevators May Use Factors of Safety of 80 Per Cent Given in This Curve)

of the methods specified in the following paragraphs for fastening cables to cars or counterweights.

j The car and counterweight ends of cables shall be fastened by spliced eyes, return loop, or by individual tapered babbitted sockets. Such fastenings are not required for compensating counterweight cables of plunger elevators.

Method of Splicing Cables. If the spliced eye is used a metal thimble shall be placed within the eye and the splice made with not less than the following number of tucks: first strand, two tucks; second strand, three tucks; third strand, four tucks; remainder of strands, five tucks. The eye shall be drawn tightly around the thimble, the strands drawn tightly after each tuck and the tucks smoothly laid. After the last tuck is made each strand shall be cut off not closer than one-fourth inch from the tuck and beaten down flush. The splice may be left bare or served with marline.

Method of Making Return Loops. When the two ends of one continuous cable are both secured to the winding drum, to the car or to the counterweight a return loop, without cutting the cable, may be made at the counterweight or car. To form such loop the cable shall be passed around a metal thimble closely fitting the cable. Immediately above the thimble a "Higganum clamp" shall be placed on the doubled cable and securely bolted to prevent slipping of either leg of the cable through the clamp should the opposite leg be entirely released.

Method of Socketing Cables. If a babbitted socket is used the length of the socket shall be not less than four times the diameter of the cable. The hole at the small end shall be as given in Table VIII.

The small end of the socket shall be free from cutting edges.

The hole at the large end of the socket shall be not less than three times the diameter of the cable. The socket shall be drop-forged steel, steel casting or formed in a substantial block of cast iron. The socket shall be of such strength that the cable will break before the socket is perceptibly deformed.

Before cutting the cable shall served with wire at the end of the length to be used. After cutting the cable shall be served with wire at a distance from end of the cable equal to the length of the socket plus $2\frac{1}{2}$ times the diameter of the cable.

Note—Large cables should be served for several inches to prevent unwrapping.

The socket shall be slipped over the cable, and the serving at the end of the cable removed. The fiber core shall be re-

TABLE VIII. RELATION OF CABLE TO SMALL DIAMETER OF SOCKET

Nominal Diameter of Cable in Inches	Diameter of Small End of Cable Socket
$\frac{1}{4}$ to $\frac{1}{2}$ inclusive	$\frac{1}{8}$ in. larger than cable diameter
$\frac{3}{4}$ to $1\frac{1}{4}$ inclusive	$\frac{3}{16}$ in. larger than cable diameter
$1\frac{1}{2}$ to $1\frac{3}{4}$ inclusive	$\frac{1}{4}$ in. larger than cable diameter

moved to the remaining serving and the wires separated and thoroughly cleaned.

The wires shall be "turned in" toward the center of the cable for a distance not less than $2\frac{1}{2}$ times the diameter of the cable.

The wires shall be sprinkled with powdered rosin or dipped in a suitable fluxing solution and the socket shall be put in place.

The socket and cable shall be warmed and poured full of melted babbitt or spelter metal. Care shall be taken not to heat the metal more than necessary to make it flow.

k Whichever method is used for fastening the cable, the fastening shall be capable of sustaining a load of not less than 80 per cent of the ultimate strength of the undisturbed portion of the cable.

Rule 331 Cable Equalizers

a Equalizers shall be provided at car and counterweight ends of hoisting cables for traction elevators having only two cables. Equalizers shall be provided for elevators having winding drums, if the cables wind in grooves on drums scored right and left hand. It is recommended that where practicable, equalizers shall be used if several hoisting cables are attached to a car or a counterweight.

It is recommended that for traction elevators, the equalizers shall consist of compression springs located between the crosshead and the cable anchorages.

Rule 332 Signal Systems

a The hoistway of every power freight elevator, except automatic button-control elevators, shall be provided with a signal system by means of which signals can be given from any landing whenever the elevator is desired at that landing.

b Automatic button-control elevators shall be provided with an audible emergency signal that is operated from the car.

Part IV Hand Elevators and Hand Invalid Lifts

Section 40 . Car Construction and Safeties

Rule 400 Car Construction

a Hand invalid lifts, hospital elevators and elevators operating outside the building—except sidewalk elevators—shall have cars enclosed on the top and sides not used for entrance. The enclosure shall not deflect more than one-fourth inch if subjected to a force of 75 lb. applied at any point perpendicular to the car enclosure. The car enclosure shall be secured to the car platform or frame in

such a manner that it cannot work loose or become displaced in ordinary service.

b Car frames shall be of metal or sound seasoned wood designed with a factor of safety of not less than six based on the rated load uniformly distributed. If of wood the frame members shall be bolted and braced to give the required strength.

c No glass shall be used in elevator cars except to cover certificates, etc. No piece of glass shall exceed one square foot in area.

b Elevators operating in hoistways outside the building which are guarded only at the ground landing shall be protected on the exposed side or sides either by independently operated gates or bars interlocked with the car control, or by semi-automatic gates or bars.

Rule 401 Car Compartments

a No hand elevator car upon which persons are permitted to ride shall have more than one compartment.

Rule 402 Cars Counterbalancing One Another

a Hand elevator cars shall not be arranged to counterbalance one another if persons are permitted to ride on them, or to step on them for the purpose of loading or unloading unless hoistway gates or doors are provided which are equipped with interlocks or electric contacts and doorlocks.

Rule 403 "Car Safeties" and Speed Retarders

a Hand elevators suspended by cables, chains or ropes and having a travel of more than 15 ft. shall be provided with a "safety" attached to the under side of the car frame capable of stopping and sustaining the car.

b The "car safety" shall be applied mechanically.

c No "car safety" shall be permitted for stopping an ascending car.

d A "speed retarder" may be used to apply the brake if the car speed becomes excessive in either direction.

Hand elevators having a travel of more than 30 ft. shall be equipped with a "speed retarder" which operates automatically if the car descends at excessive speed.

Note—For hand brake see Rule 420.

e The "speed retarder" shall be located where it cannot be struck by the car in case of overtravel.

Rule 404 Capacity and Loading

a The minimum carrying capacity of hand invalid lifts and hospital elevators shall be 35 lb. per sq. ft. of platform area inside of the car enclosure.

b A metal plate shall be provided by the elevator manufacturer which shall be fastened in a conspicuous place in the elevator car and shall bear the following information, in not less than one-fourth inch letters or figures. These letters or figures shall be stamped in, etched, or raised on the surface of the plate.

- 1 The capacity of the elevator in pounds
- 2 The maximum number of passengers to be carried based on 150 lb. per person
- 3 The suspension data required in Rule 421b.

c A rated-capacity test shall be made of every new elevator before the elevator is placed in regular service.

Section 41 Counterweights, Bumpers and Guides

Rule 410 Counterweights

- a Counterweights shall run in guides.
- b Counterweight sections of hospital elevators and in-

valid lifts whether or not carried in frames shall be secured by at least two tie rods passing through holes in the sections. The tie rods shall have lock nuts at each end. The lock nuts shall be secured by cotter pins.

Rule 411 Car and Counterweight Bumpers

a Car bumpers of the spring type or their equivalent shall be installed in the pit of hand invalid lifts and hospital elevators.

b Bumpers shall stop the car when descending with its rated load.

c Bumpers shall be located symmetrically with reference to the center of the car.

d Counterweight bumpers similar to those required for cars shall be installed under the counterweights if the space below the counterweight runway is used for any purpose.

Rule 412 Guide Rails

a Guide rails for both car and counterweights shall be of steel, wrought iron, or straight-grained, seasoned wood free from knots, shakes, dry rot or other imperfections. Guide rails, particularly where in contact with the guide shoe when the car is at the landing, shall be securely fastened with through bolts of such strength, design and spacing that the guide rails and their fastenings shall not deflect more than one-fourth inch under normal operation. Guide rails shall withstand the application of the "safety" when stopping a fully loaded car or the counterweight. The guiding surfaces of the guide rails for elevators requiring "safeties" shall be finished smooth. The guide rails shall be "bottomed" on suitable supports and extended at the top to prevent guide shoes from running off in case the overtravel is exceeded.

Section 42 Machines and Suspension Members

Rule 420 Machines and Machinery

a Hand elevators shall be equipped with a hand brake that operates in either direction. When the brake has been applied it shall remain locked in the "on" position until released.

b The factors of safety based on the static loads to be used in the design of all parts of hoisting machines shall be not less than five for wrought iron or wrought steel and eight for cast iron or other materials.

c The sheaves or idlers of hand invalid lifts and hospital elevators shall not be suspended in stirrups from the under side of the supporting beams. Cast iron shall not be used for stirrups of sheaves or idlers.

d No hand elevator machine shall be equipped with any means or attachment for applying any other power unless such elevator is permanently and completely converted into a power elevator complying with requirements of this code for power elevators.

e Power shall not be applied to hand elevators by means of rope grip attachments or clutch mechanisms.

Rule 421 Hoisting Cables, Ropes and Chains

a The capacity plate required in Rule 404b shall bear the following information:

SUSPENSION SPECIFICATIONS

Suspension Member	Material	Number	Nominal Size	Rated Ultimate Strength in Pounds
Hoisting
Counterweight

b In addition a metal tag shall be attached to the suspension fastenings stating the size, rated ultimate strength

and material of the suspension and the date of its installation.

c The factor of safety used in determining the size of the suspension member shall be five based on the weight of the car and its rated load.

d Suspension members shall be so adjusted that either the car shall rest upon its bumpers or the counterweight upon the floor of the pit before the counterweight or the car strikes any part of the over hoistway construction.

e Suspension members secured to a winding drum shall have not less than one complete turn of the suspension member around the winding drum when the car or counterweight has reached the extreme limit of its travel.

Part V Dumbwaiters

Limits of Application of This Code

The requirements for dumbwaiter hoistways are given in Part I of this Code. Hand dumbwaiters are required to conform only to Rules 500, 501, 502 and 503. Power dumbwaiters shall comply with all the requirements of Part V of this Code.

Section 50 Dumbwaiter Construction

Rule 500 Car Construction

a Dumbwaiter cars shall be of such strength and stiffness that they will not deform appreciably if the load falls or leans against the sides of the car.

b Cars shall be made of wood or metal and of "solid" construction.

Cars for power dumbwaiters shall be reinforced with metal from the bottom of the car to the point of suspension.

Metal cars shall be of metal sections rigidly riveted or welded together.

Cars may be provided with hinged or removable shelves.

c Dumbwaiter cars, machines, and hoisting ropes or cables shall sustain the loads given in the table following:— The motive power need not be sufficient to raise the structural capacity load.

Horizontal Dimensions in Inches	Structural Capacity in Pounds
24 × 24	100
24 × 30	150
30 × 30	300
36 × 36	500

Rule 501 Dumbwaiter Machines

a Dumbwaiter machines shall be securely fastened to their supports. The factors of safety—based upon the ultimate strength of the material and the static load, i.e., the loading specified in Rule 500c, plus the weight of the car, cables, counterweights, etc., used in the design of dumbwaiter machines—shall be not less than

- 6 for steel, and
- 9 for cast iron or other materials.

b Sheaves or idlers shall not be suspended in cast-iron stirrups from the under side of the supporting beam.

Rule 502 Guide Rails

a Guide rails shall be rigidly secured to the hoistway and the joints either tongued and grooved, doweled or fitted with splice plates.

b One set of guides may be used for both the car and the counterweights.

c Hand dumbwaiters having a capacity of not more than 20 lb. and their counterweights shall have guides of wood,

metal, metal and wood bolted together, metal tubes or spring steel wires maintained in tension by turnbuckles.

d Dumbwaiters having a capacity of more than 20 lb. and a speed not in excess of 100 ft. per min. shall have guide rails of metal, wood, or metal and wood bolted together.

e Power dumbwaiters having a speed more than 100 ft. per min. shall have steel guide rails weighing not less than 6 lb. per ft.

Rule 503 Counterweights

a Counterweights of dumbwaiters having a capacity exceeding 100 lb. or having a speed exceeding 100 ft. per min. shall have their counterweight sections secured by at least two tie rods passing through holes in all sections, unless suitable counterweight frames or boxes are provided. The tie rods shall have lock nuts at each end. The lock nuts shall be secured by cotter pins.

Rule 504 Hoisting Cables

a Power dumbwaiters shall be provided with one or more iron or steel hoisting cables. Where cables are ex-

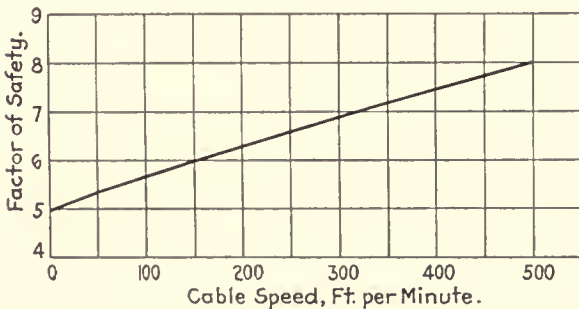

Curve 3—Factors of Safety for Hoisting Cables for Dumbwaiters

posed to corrosion, they may be covered with marline or other equivalent protective covering.

b The minimum factor of safety of car or counterweight cable shall be not less than the values given in Curve 4, corresponding to the rated speed of the car.

c The diameter of the cables shall be determined by using the factor of safety found in Rule 504b and the rated ultimate strength of the cable. The computed load on the cable shall be the weight of the car plus its rated load.

d No car or counterweight hoisting cable of power dumbwaiters shall be lengthened or repaired by splicing.

e The drum end of the car and counterweight cables shall be secured by clamps inside the drums.

f All cables secured to a winding drum shall have not less than one complete turn of cable around the winding drum when the car or counterweight has reached the extreme limit of its travel.

Section 51 Power Dumbwaiter, Speed Control and Safeties

Rule 510 Speed and Control

a No belt dumbwaiter shall have a speed greater than 50 ft. per min.

b No power dumbwaiter controlled by a direct hand-operated shipper rope shall have a speed greater than 50 ft. per min.

c The speed of power dumbwaiters other than those mentioned in Rules 510a and 510b shall not exceed:

- 1 One hundred feet per minute if the travel is less than 30 ft.
- 2 One hundred and fifty feet per minute if the travel is 30 ft. or more and less than 50 ft.
- 3 Two hundred and fifty feet per minute if the travel is 50 ft. or more and less than 100 ft.
- 4 Four hundred feet per minute if the travel is 100 ft. or more.
- 5 Five hundred feet per minute if the travel is in excess of 100 ft. without intermediate landing, and the dumbwaiter is button-controlled and provided with a "slow-down" device.

d Guards which will keep the ropes on the sheaves shall be installed unless means are used to maintain the hand ropes in proper tension.

Rule 511 Terminal Stops

a Power dumbwaiters shall be equipped with brakes which are automatically applied when the power is cut off.

b Power dumbwaiters shall be provided at each terminal with independent means of manual operation to automatically stop the car within the limits of overtravel.

c Power dumbwaiters having a travel of more than 30 ft. and a capacity of more than 100 lb. and operated by winding drum machines shall be provided with a "slack cable" device which will cut off the power and stop the car if the car is obstructed in its descent.

Rule 512 Car Safety Tests

a Where "safeties" are required by Rule 109, these "safeties" shall be tested at the rated load and speed of the dumbwaiter.

Part VII Operating Rules

Section 70 Rules for Inspection and Maintenance

Rule 700 Responsibility

a It shall be the duty of the owner of the property upon which an elevator is or may be installed to specify in any lease which he may execute, the party responsible for the care and maintenance of the elevator.

b It shall then become the duty of the designated party to make periodic inspections and maintain in proper working order all parts of any elevator installations.

Rule 701 Inspection

a The following is the schedule of inspections recommended:

Hoistway door and car gate interlocks, contacts, control apparatus, car and counterweight cables, "safeties," guide rails and elevator machines shall in passenger-elevator installations be inspected quarterly and in freight-elevator installations shall be inspected semi-annually.

Plunger shoes, by-passes and piston rods of hydraulic elevators shall be inspected at least once in three years.

Inspection shall be made by a competent person. A certificate of inspection shall be posted in the car stating the name of the inspector and the date of inspection.

Rule 702 Maintenance

a Cables, guides and all parts of machinery shall be kept

well lubricated. The oil in bearings and gear casings shall be renewed every six months.

The use of a lubricant containing graphite or other opaque substance shall not be permitted on elevator cables.

b Pressure and discharge tanks of hydraulic elevators shall be thoroughly cleaned at least once every three years.

c Pressure tanks of hydraulic elevators shall be tested with hydrostatic pressure 50 per cent in excess of the maximum working pressure at least once every three years.

Rule 703 Care of Installation

a Elevator hoistways and pits shall be kept clean. No rubbish shall be allowed to accumulate therein nor shall any part be used for storage.

b No explosives or highly inflammable substance shall be stored under or near any elevator hoistway.

c No material not a permanent part of the elevator equipment shall be permitted on the top or cover of an elevator car.

d No wire or current-carrying device shall be substituted for the proper fuse or circuit breakers in an elevator circuit.

e Freight elevators shall have signs posted on the car and at each landing prohibiting unauthorized persons from riding on the elevator car.

f No hand elevator shall be used for carrying safes or other concentrated loads of weight greater than the normal rated capacity of the elevator.

g The water level in the tank of a hydraulic elevator should usually be maintained at about two-thirds of the capacity of the tank.

h Operators shall be so clothed as to offer no undue hazard to themselves or the occupants of the car.

Section 71 Qualifications and Duties of Operators

Rule 710 Qualifications of Operators

a Operators shall be not less than 18 years of age.

b Operators shall be free from serious physical or mental defects and shall be selected with consideration for their ability to perform their duties in a careful and competent manner.

Rule 711 Training of Operators

a One week's training under the direction of a competent operator shall be required before a new (inexperienced) operator is placed in charge of a passenger elevator.

b Two days' training under the direction of a competent operator shall be required before a new (inexperienced) operator is placed in charge of a freight elevator.

c Operators not having previous experience in handling passenger elevators shall not be placed in charge of cars operating at a speed in excess of 600 ft. per min. until properly trained for this service.

Note—Where licensed operators are required the elevator may, in case of emergency, be operated by a competent unlicensed person.

Rule 712 Instructions to Operators

a Always open the main switch of an electric elevator or lock the control mechanism of a hydraulic, steam or belted elevator before cleaning or oiling any part of your machine or regulator and before leaving your work.

b Be sure the control mechanism is in the "stop" position before closing the main switch.

c Make a trial inspection trip each morning before carrying any passengers.

d Report any defects promptly to the person in charge.

e Do not attempt to make any repairs unless instructed to do so.

f Carry no passengers or freight while inspections, repairs or adjustments are in progress and operate the car only in response to directions from the inspector or person in charge. Do not move the car when anyone is in the pit or on top of the car except as they may direct.

g See that the "locking bars" and "safe-hoisting" attachments are in place before a safe or other heavy concentrated load is moved on or off the car platform.

Do not attempt to raise the car more than a few inches until the "locking bars" have been withdrawn.

h Do not ride in the elevator nor allow others to ride while a safe or other heavy object in excess of the rated capacity of the elevator is being carried.

i Hoistway doors or gates shall always be closed and locked before the car is started. The car shall be brought to a stop at the landing level before the hoistway door is opened.

j Keep car gates, if any, closed while running, and where no car gates are provided keep passengers away from the open edge of the car platform.

k Limit the number of passengers to the capacity of the car and do not permit crowding.

l Do not reverse the control while passing a landing on receipt of a stop signal. Continue the trip and respond to the signal on the next trip.

m Move control mechanism to the "stop" position on approaching the terminal landings. Do not depend on the limit switches in the ordinary operation of the car.

n If the power goes "off" while the car is in motion, move the control mechanism to the "stop" position and wait for the return of the power.

o If the car refuses to stop do not attempt to jump off. The car will be stopped by the application of the safeties if it attains excessive speed of descent or by the hoistway limit switches at either end of its travel.

p If the car should stop suddenly, and the machine drum or sheaves are plainly visible, move the control in the "up" direction just enough to start the machine slowly. Watch the cable closely and see that it winds in its proper grooves.

If the machine grooves or sheaves are not visible, call for the engineer in charge and operate the machine at his direction.

q If the car will not start return the control to the "stop" position and look for the following causes:

- 1 Open circuit in main fuses.
- 2 Open circuit in control-circuit fuses.
- 3 Controlling device not properly functioning.
- 4 Automatic switch contacts, slack-cable switch, limit switches, door contacts, etc., being open.
- 5 Lack of lubrication in bearings or thrusts.

If this inspection shows no defects, remove part of the load.

r Lock the control mechanism of hydraulic, steam or

belted machine in the "stop" position and open the auxiliary control switch of an electric elevator before allowing any freight to be loaded or unloaded.

s Be sure to familiarize yourself with the emergency devices, understand their function and know how to operate them.

t Never leave the car in the ordinary course of operation nor leave the control mechanism unprotected. When

going off duty for any reason even for a few minutes be sure that the power is disconnected or that the control mechanism is locked and the hoistway doors closed. When service is suspended for any reason during the ordinary operating hours display a "NOT RUNNING" sign at each landing.

u Be sure you are familiar with these rules and keep a copy on your person or in the car at all times.

A Code of Safety Standards for Power-Transmission Machinery*

Rules and Requirements for the Protection of Industrial Workers from Hazards Commonly Presented by Mechanical Equipment Used for Transmitting and Distributing Power from the Prime Movers to the Various Power-Utilizing Machines, Tools and Devices

Note—The use of properly designed, constructed and installed individual motor-driven equipment with electrical power distribution not only eliminates many of the hazards demanding this Code, but also gives an uninterrupted distribution of natural and artificial light, and a greater flexibility and range of speeds than is possible with mechanical power-distributing systems.

The following specifications describe standard guards for all power-transmission equipment hereinafter mentioned, and apply to all main shafting, jack shafting, drive shafting and countershafting, and their belts and other attachments up to but not including belts actually driving machines.†

2 Class A Guards. If the clearance between the

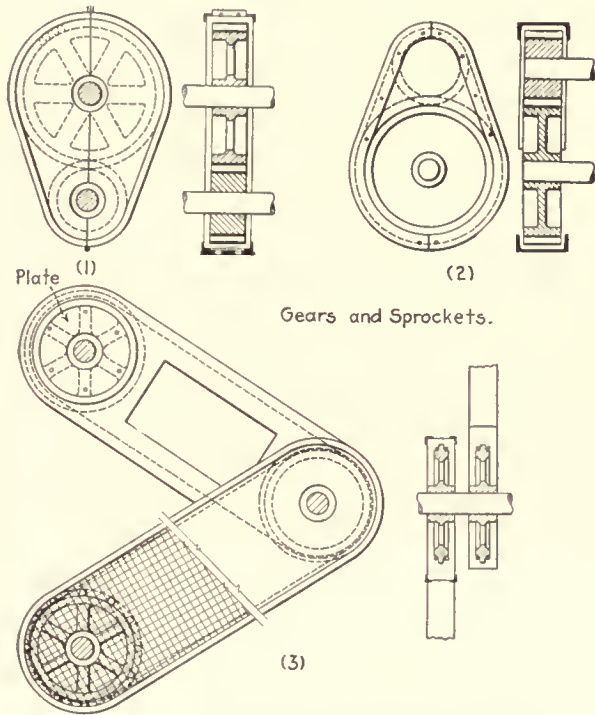

Figs. 1 to 3—Guards for Gears and Sprockets

guard and the guarded part is less than 5 in., a metal guarding material that will not admit objects larger than one-half inch in diameter, strong enough to withstand loads to which it may be subjected, durable

*Compiled and presented by Carl M. Hansen and Rufus W. Hicks, under the direction and with the approval of the Committee on Health and Safety, National Association of Manufacturers. Submitted by the Sub-Committee on Protection of Industrial Workers for the consideration of the American Society of Mechanical Engineers.

†Belts actually driving machines will be considered "machine belts," and therefore a subject for machine codes.

enough to withstand ordinary wear and tear, substantially fabricated and erected, and free from sharp points and edges.

3 Class B Guards. If the clearance between the guard and the guarded part is 5 in. or more, a metal guarding material that will not admit objects larger than 2 in. in diameter, strong enough to withstand loads to which it may be subjected, durable enough to withstand ordinary wear and tear, substantially fabricated and erected, and free from sharp points and edges.

4 Handrails. If the clearance between the guard and the guarded part is 15 in. or more (measured horizontally from extreme parts within 6 ft. of floor), a handrail 42 in. in height with at least one intermediate rail, supported at least every 8 ft., of substantial and rigid construction and erection, with no sharp points or edges.

5 If constructed of pipe, the rails and posts shall be at least equal in strength to 1¼-in. standard-weight pipe.

6 If constructed of structural metal, the rails and posts shall be at least equal in strength to two by two by one-fourth (2 x 2 x ¼) in. angles.

7 If constructed of wood, the top rail shall be 2 in. by 4 in., the center rail not less than 1 in. by 4 in., and the posts 4 in. by 4 in., all straight-grained lumber dressed on four sides, or other construction of equal strength.

8 Toe Boards. When power-transmission equipment extends through floors or into pits, Class A and B guards shall extend to the floors or toe boards 6 in. in height shall be provided around the floor opening in addition to standard handrails. (See Figs. 6, 7, 11, 14, 30, 31, 34, 48.)

9 Sanitary Bases. Class A and B guards, for power-transmission equipment not extending through floors, shall enclose all exposed sides to 2 in. below the bottom of the lowest moving part when the clearance between that part and the floor is less than 8 in.; or when the clearance between the lowest moving part and the floor is 8 in. or more, the guards shall be closed on the bottom, or extended on all exposed sides down to 6 in. above the floor. (See Figs. 15, 26, 36-40, 42, 43, 49-54.)

10 Gears and Sprockets. All power-driven gears and sprockets shall be completely enclosed on exposed sides with standard guards as specified in Class A or B,

except in cases where the design and operation of the parts to be guarded make a complete enclosure clearly impractical; in which case the face of the gears or sprockets shall be covered with a band guard surrounding all exposed teeth, with flanges on both sides extending inward beyond the roots of the teeth, and there shall be a continuous smooth web cast or fitted between the hubs and rims of the gears or sprockets. (See Figs. 1, 2, 3.)

11 Vertical and Inclined Belts, Ropes, Chains. All vertical and inclined belts, ropes and chains used for transmitting or distributing power (except belts trav-

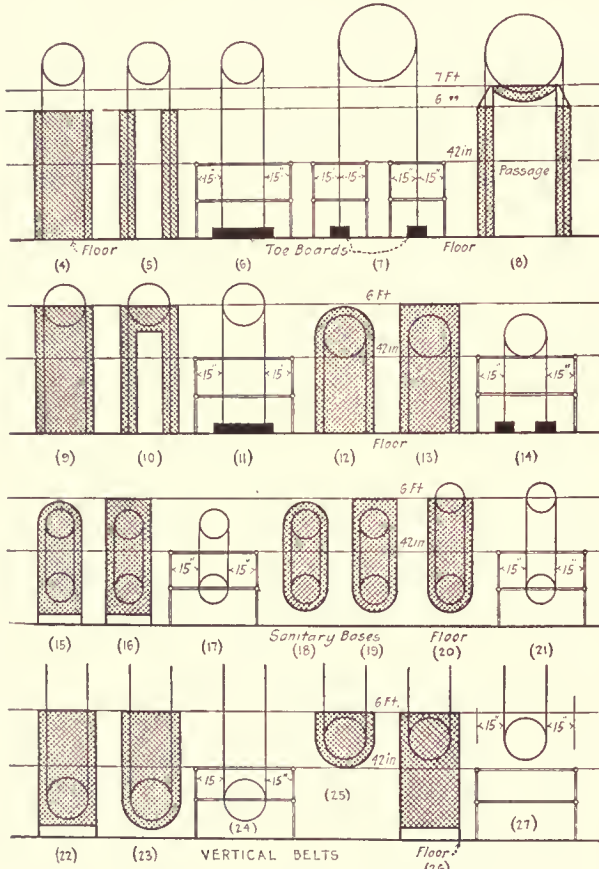

Figs. 4 to 27—Guards for Vertical Belts

eling less than 120 feet per minute, or transmitting so little power that accidental contact therewith could cause no accident) shall be provided with standard guards as specified in Class A or B, 6 ft. high on exposed sides, or on exposed side and top, or with a standard handrail on exposed sides. (See Figs. 4 to 46, inclusive.)

12 Horizontal Belts, Ropes, Chains. All horizontal belts, ropes and chains used for transmitting or distributing power (except belts traveling less than 120 ft. per min., or transmitting so little power that accidental contact therewith could cause no accident) shall be guarded as follows:

13 Low Belts. If the upper part of the belt is lower than 6 ft. above the floor or working platform, it shall be provided with standard guards specified in Class A or B, 6 ft. high on exposed sides, or on exposed sides and top, or with a standard handrail on exposed sides. (See Figs. 47-50.)

14 Medium Belts. If the upper part of the belt is higher than 6 ft. above the floor or working platform and the lower part of the belt is lower than 6 ft. above the floor or working platform, it shall be provided with standard guards as specified in Class A or B, 6 ft. high on exposed sides, or with a standard handrail on exposed sides. (See Figs. 51-58.)

15 High Belts. If the lower part of the belt is higher than 6 ft. above the floor or working platform and lower than 7 ft. above the floor, it shall be provided with standard guards as specified in Class A or B, on exposed sides and bottom, or with standard handrail on exposed sides. (See Figs. 59, 60.)

16 Belts Over Driveways. Where a horizontal belt is located over a driveway or passageway the highest floor of any wagon or truck passing beneath the belt shall be considered a working platform.

17 Belt Fasteners. All belts not provided with guards as specified in Class A or B and within 7 ft. of the floor or working platform shall be free from metal lacings and metal fasteners.

18 Belt Shifters. Belt shifters shall be provided for

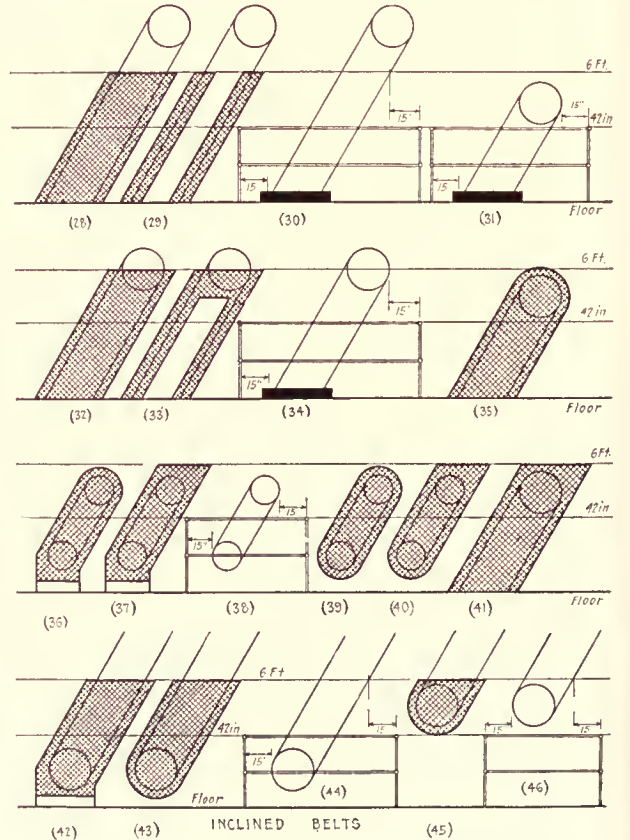

Figs. 28 to 46—Guards for Inclined Belts

all tight- and loose-pulley belts, and shall be so designed and constructed that ordinary vibrations or accidental contact will not alter the set position, and shall have a controlling handle conveniently located. (See Figs. 61-63.)

19 Pulleys. Pulleys belted from above or from the side in such a way as to allow passage beneath the pulley, and within 7 ft. of the floor or working platform and not completely enclosed by standard belt guards or handrails, shall be guarded to the top of the pulley or

to a height of 7 ft. above the floor or working platform on exposed sides and beneath by guards as specified in Class A or B, or be enclosed on exposed sides by standard handrails. (See Figs. 64-67).

20 Bearing Clearance. The clearance on shafting between pulleys and bearings or between pulleys and

ings and clamp couplings shall be cylindrical and concentric with the shafting and with no parts or attachments projecting beyond the largest periphery of the coupling or its projecting flanges. (See Figs. 74, 75.)

26 Flexible Couplings. Flexible and universal couplings shall be completely enclosed in standard stationary guards as specified in Class A or B, or in smooth concentric revolving guards of solid construction.

27 Clamp Couplings which are of irregular shape or unknown strength are prohibited on revolving shafting.

28 Collars. Assembled collars shall be smooth cylindrical and concentric with shafting, with no projecting parts or attachments. (See Figs. 76, 77.)

29 Set Screws. All set screws in revolving parts not enclosed by standard guards as specified in Class A or B shall be flush with or countersunk below the

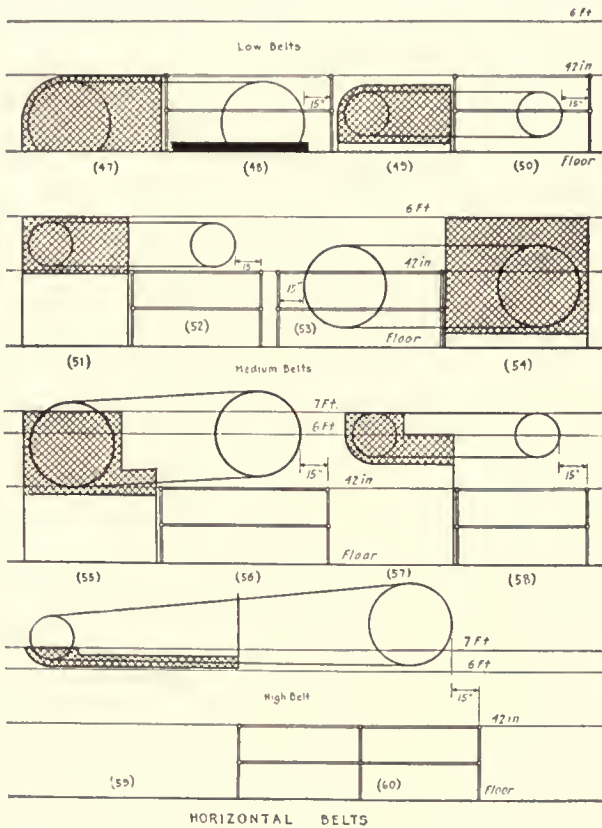

Figs. 47 to 60—Guards for Horizontal Belts

fixed objects shall be not less than 36 in. and wider than the belt, or the pulleys shall be guarded on the near side with stationary guards as specified in Class A or B, and all revolving objects in the clearance shall be smooth, cylindrical and concentric with shafting. No guards shall be required when a runway is installed. (See Figs. 68-73.)

21 Belt Clearance. The clearance on shafting between pulleys and pulleys, collars, couplings or other revolving attachments shall be wider than the widest belt used, or the pulleys shall have flanges or guards to prevent the belt from dropping into the clearance. (See Figs. 68-73.)

22 Abandoned Pulleys. Pulleys without belts shall be guarded as though belted, or removed from revolving shafts.

23 Clutches. Friction clutches, jaw clutches and compression clutches within 7 ft. of the floor or working platform or within 36 in. of a bearing shall have their operating mechanism completely enclosed in stationary guards as specified in Class A or B, or in smooth, concentric revolving guards of solid construction with no projecting parts or attachments.

24 Couplings. All couplings within 7 ft. of the floor or working platform or within 36 in. of a bearing shall be guarded as follows:

25 Rigid Couplings. Sleeve couplings, flange coup-

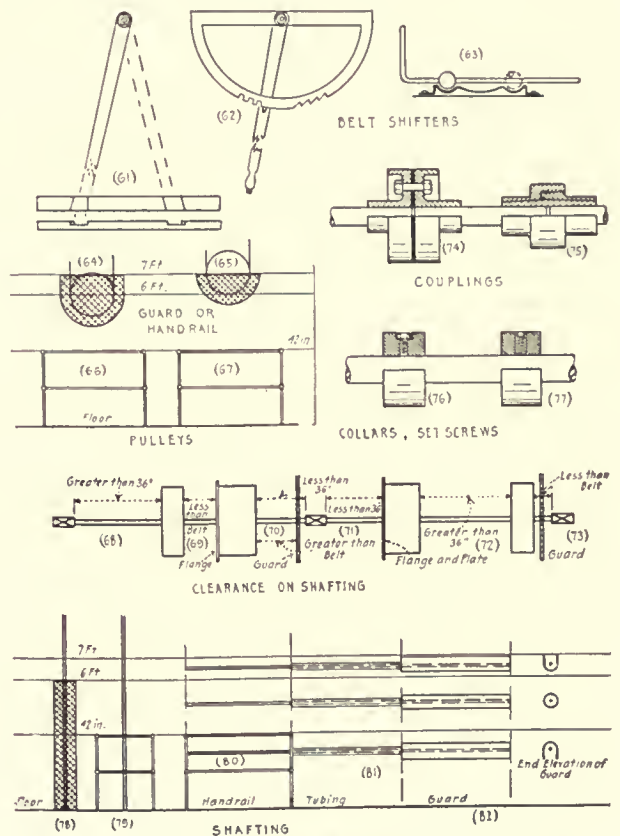

Figs. 61 to 82—Guards for Miscellaneous Equipment

periphery of the part retaining the set screws. (See Figs. 76, 77.)

30 Keys. All keys or keyways in revolving shafting not enclosed by standard guards as specified in Class A or B shall be made flush with the end and periphery of the shaft or enclosed by smooth, cylindrical concentric guards.

31 Vertical Shafting. Vertical shafting with or without collars, couplings, clutches, pulleys, or other attachments shall be enclosed on exposed sides with standard guards as specified in Class A or B to a height of 6 ft. above the floor or working platform, or with a standard handrail. (See Figs. 78, 79.)

32. Horizontal Shafting. Horizontal shafting with or without collars, couplings, clutches, pulleys, or other attachments, including dead ends, within 7 ft. of the floor or working platform, shall be enclosed on all exposed sides with standard guards as specified in Class A or B or with standard handrail, or with freely revolving tubing. (See Figs. 80-82.)

33 Shafting Over Driveways. Where horizontal shafting is located over driveways or passageways, the highest floor of a wagon or truck passing beneath the shafting shall be considered a working platform.

34 Emergency Stop Stations. A station or stations shall be provided in each room, section, or department to stop quickly all power-transmission equipment therein. Such station or stations shall be properly marked and easily accessible and provided with means for locking in "stop" position.

35 Bearings. Where possible, bearings shall be of a self-oiling type with reservoir capacities for at least 24 hours' running or shall have other methods of oiling which do not bring the oiler in the danger zone, and shall have necessary drip cups and pans securely fastened in position.

36 Lubrication. Oiling which brings the oiler in a danger zone shall be done only by an authorized person, and while the machinery is not in motion.

37 Oiler's Clothes. The oiler must not wear loose or flowing clothing.

38 Oiler's Lock. The oiler shall be provided with a lock and key or with a key to the locks at the emergency stop stations, and with a warning sign to display at the stations when at work on machinery controlled by that station. He shall be required to lock the station in a "stop" position and display the sign before going to work, and unlock and remove the sign when the work is completed and all men have left dangerous places.

39 Starting Signals. Ample notice should be given by means of an effective alarm or signal in all departments before power-transmission equipment is started. An effective signal system should be required in all plants where machinery is in group drive, and fixed rules should be established for the use of these signals.

40 Inspection. All power-transmission equipment should be carefully inspected at frequent and regular intervals by foremen or authorized inspectors, and defective equipment should be reported for repair and records kept of inspections.

41 Repairs and Adjustments. Repairs and adjustments to power-transmission equipment or guards therefor shall be made only when the power is cut off from that equipment, and guards shall be replaced in protective position before the power is cut on.

42 Removing Guards. Guards installed in accordance with this Code shall not be removed or rendered ineffective except for repairs spoken of in Par. 41.

TRACKLESS TRANSPORTATION

Hand Trucks, Storage Battery and Gasoline Engine
Trucks, Storage Battery and Gasoline
Engine Tractors, Trailers,
Accessories

and

Motor Trucks, Truck-Tractors,
Tractors and Trailers

A Treatise Covering the Construction and Application of
the Trackless Devices Used in the
Handling of Materials

By

FLOYD T. SMITH

Power and Mining Department, General Electric Co., Schenectady, N. Y.
Member, American Society of Mechanical Engineers; Member, Society of Terminal
Engineers; Associate Member, American Institute of Electrical Engineers

Assisted by

STEPHEN G. THOMPSON

Chief Transportation Engineer, The White Co., Cleveland, O.
Member, American Society of Mechanical Engineers;
Member, Society of Automotive Engineers



Industrial Trucks, Tractors and Trailers

INDUSTRIAL TRANSPORTATION DEVICES, as considered here, may be said to embrace three distinct classes of apparatus: (1) the simple forms of hand trucks, carts and wheelbarrows; (2) the various modifications of power driven trucks as distinguished from tractors, and (3) tractors and trailers. Both power driven trucks and tractors are manufactured in two general types, i. e., storage battery and gasoline engine propelled. Before deciding upon the proper types of trucks, tractors or trailers applicable for any particular interplant transportation system; whether the problem should be solved by hand trucks, by power driven trucks, by tractors and trailers; whether storage battery or gasoline engine propelled machines are most suitable; or whether a combination of the various systems is required, a general survey of existing conditions should be made.

Inside the plant it is important to know, for instance, the construction of the floors; whether they are of sufficient carrying capacity to support the weight of a loaded machine, the grades, length of hauls, working time, class and volume of material to be transported, facilities for loading and unloading, width of aisles, and the dimensions of doorways and other passages through which the machine may have to travel. If the machine has to carry material up and down on the elevator, note the capacity of the elevator, the size of opening, the size and position of the doors at the various floors, whether the source of electrical energy is direct current or alternating, what wiring is necessary to install the charging apparatus, and also if help is available for operating the charging apparatus. Special attention should be given to insurance and to existing fire rules if the use of power machines with gasoline engines is contemplated.

Outside the plant it is important to know the character of the roadways; whether they are dirt, hard filled or concrete. Also the length of hauls, the extent of working periods, the class of material to be moved, railroad tracks or other obstructions which must be passed over, all must be all taken into consideration.

Hand Trucks

For short movements of general parcel freight, or forms of material that come under this class, hand trucks cannot be dispensed with. The manually operated hand truck, in many varied sizes and shapes, has an important place in industrial life, and is one of the principal forms of equipment used in material handling. In any haulage problem, the several types of hand trucks are applicable and are recommended for certain classes of material and for short haul distances; they may also be used in connection with the power truck.

The many types and the ingenious attachments and designs greatly aid and make easier the movement by hand of commodities over short distances. Man power is enhanced when heavier loads are placed on trucks that can be pushed or pulled. In this way heavier loads may be moved longer distances, with more ease.

While the hand truck is efficient, and in many places indispensable, it is limited in its capacity and scope by man power. A man with a hand truck maintains a speed of less than 2 m. per hour with a load varying from 250 lb. to 700 lb. The practical field of operation covers a radius of from 50 ft. to 150 ft. When movements are longer than 150 ft. to 200 ft. other machines should be introduced to relieve the hand trucks from the burden and waste of longer hauls. In many instances, however, the aisle space, floor support, construction of floors and general weight of material to be moved do not permit the use of a power truck and for such installations one of the several types of hand trucks is applicable.

Efforts are being directed toward the substitution of mechanical means to dispense with the hand truck but there are many peculiar shaped parcels which can best be moved by such trucks. For movements of all parcels over distances of 50 ft. or less, no other method is sufficiently flexible to warrant displacing the hand truck. Therefore, it should be retained and be used in conjunction with machines which will handle material economically over longer distances, and when the material to be

transported is exceptionally heavy.

Box Type

This type is convenient and useful for moving large and heavy bales, cases, boxes and machinery. It is of low, strong and rugged construction with a hardwood or metal rectangular frame and with four or six small wheels. The

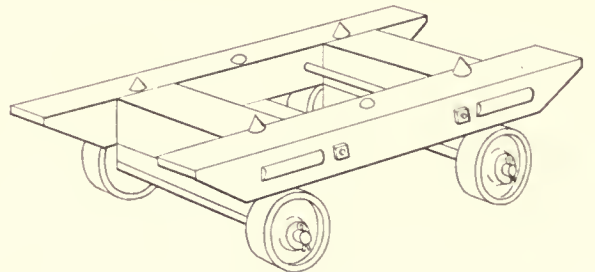

Box Truck

center wheels are so placed that the load may be balanced in turning. Steel points in the frame prevent the load from sliding. The bevel or rounded ends permit the heavy pieces to be loaded onto the truck with but little effort.

- Hand Trucks: Box; Baggage; Single Handle; Barrow; Push Cart; Large Wheel Cart; Stevedore; Platform; Lift.**
- Storage Battery Trucks: Platform; Low Platform; Elevating Platform; Baggage; Crane; Dump Body; Tying.**
- Gasoline Engine Trucks: Cargo; Stake Body; Dump Body.**
- Storage Battery Tractors: Three Wheel; Four Wheel; Center Control.**
- Gasoline Engine Tractors: Three Wheel; Four Wheel; Track-laying.**
- Trailers: Four Wheel Steer; Caster; Fifth Wheel; Balanced; Baggage; Low Platform; Dump Body; Box.**

Different forms of construction make this type applicable for many uses. The frame may be furnished with four rollers for moving case goods of moderate weight over irregular surfaces, as aboard ship. A form with a triangular frame is manufactured and is used for handling barrels in an upright position, for carrying boxes or stoves through narrow aisles, and, when furnished with double swivel casters, for moving pianos. The frame may be of metal construction and hinged at the center so that the ends drop down to the floor forming three points of contact, thus preventing the truck from moving during loading.

The dolley is a modification of the box truck; it has a flat faced metal roller in the center of the frame.

Baggage or Express Type

This type has been adopted as standard for handling baggage and express by many leading railroad and express companies. It is strongly constructed of hardwood with four metal or wooden wheels and a fifth wheel in front which permits easy turning. The platform is about 35 inches high and is furnished with either fixed or removable end stakes. Another form uses sloping ends which permit somewhat larger loads being carried, which are bulky in form but light in weight.

This type may also be furnished with side rails, beveled inward, or with an iron band extending slightly above the platform, which prevents milk cans or similar loads from

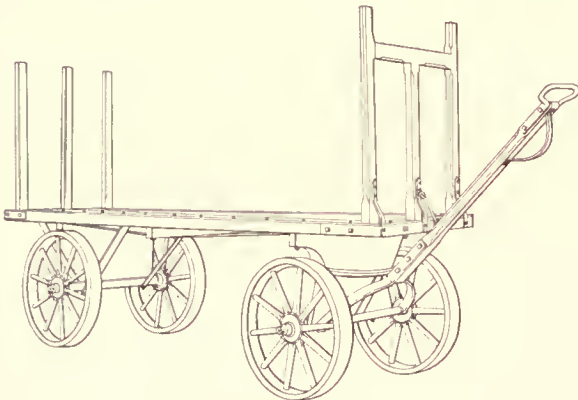

Baggage or Express Truck

sliding off. In a smaller and lighter size it is very serviceable for use at small, outlying stations where the traffic is comparatively light.

Single Handle Type

This type is handy and convenient for private residences, country stores and many other places where with it one

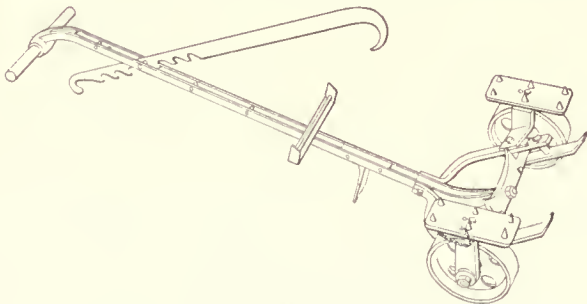

Single Hand Truck

man can economically handle ash cans, boxes, trunks and all sizes of barrels, casks, kegs and bulky packages. It is

built with two small wheels, a single handle and steel points to hold the load in position. It may be furnished with a metal package grip having a horizontal and vertical adjustment to assist in pulling over the load and holding it while it is being moved. This package grip is a hook which slides down and engages the chime of the barrel or slips over the outer edge of the bale or package. A truck with a metal frame is manufactured for heavy work; it may have a special crate resting on the wheel guards. A modification of this type is, the very low frame, three-wheel, metal cask truck for handling heavy casks, barrels and kegs when it is necessary to carry them in an upright position.

Barrow

The barrow, in many forms and modifications, is used for transporting loose or bulk material short distances. The common form of barrow is built with a tubular metal or

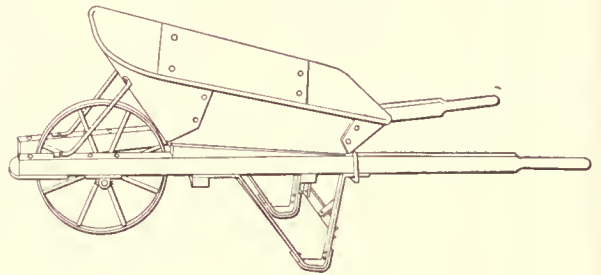

Barrow

wooden frame, having either straight or curved handles, and also one or two small front wheels of varying sizes and with two legs for supports, or with wheels under the supports. It is built with open sides or with a tray. The trays may be wood or metal, of varying sizes and of different types of construction. If of wood the sides may vary in height and may or may not be removable. The metal trays may be of riveted construction or they may be pressed from a single sheet. The barrow is used in mills, factories, construction work, and at docks and piers. Many modifications are available but each particular design is best adapted for handling one of the many classes of material. One distinct form is used extensively in handling baggage and mail bags; it has two large center wheels and ends that slope to the center.

Push Cart or Delivery Cart

The push cart is a strong, durable, heavy service cart. It has a rectangular, wooden body with two large wheels

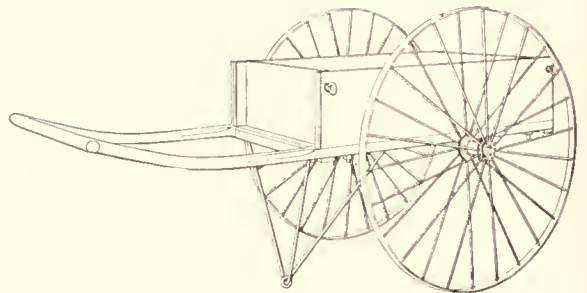

Push or Delivery Cart

and is often furnished with a third wheel in front, the latter being of advantage in crossing street gutters and rough places.

The delivery cart is similar to the push cart except that

it is of lighter construction and is generally built with a metal body and with either metal or wooden wheels. Either type is easily handled and is applicable for light delivery service and for transporting merchandise which makes large dimensional loads of medium weight. It is used by painters, carpenters, bill posters and masons, and when furnished with a removable cover is useful for carrying tools for telephone, telegraph, electric, gas and water companies.

Large Wheel Cart

This type is used in construction work for carrying concrete, in packing houses and for carrying coal and coke. It has a metal body, or tray, of either semi-circular or rectangular construction, and with an angle iron or tubular frame construction. The wheels may be supported on the side of the tray or on an under-slung axle. Either construction permits the tray with its load to be tilted, and on some types to be inverted. The inside of the tray is clear from obstruction, permitting quick and clean discharge when the body is tilted, or inverted, and making it especially useful for laying sidewalks, floors, and in other places where the load can be dumped quickly.

A slight modification has a long nose to the tray, enabling the load to be dumped into forms or molds without spilling. Another modification is the street cleaner's cart, the frame of which is formed to support and carry a metal barrel

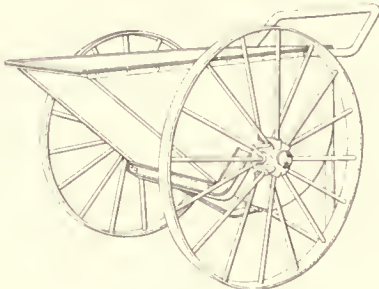

Large Wheel Cart

held in a vertical position. The ladle cart is another modification, similar in form to the street cleaner's cart except that it is of much heavier and stronger construction.

Stevadore Type

This type is still considered a necessity in many places for short moves of all classes of material, or in connection with the placing in position of loads for longer hauls. It has a platform, two handles and two wheels. Slight modifications in construction make this type adaptable for handling certain special classes of commodities, such as cotton

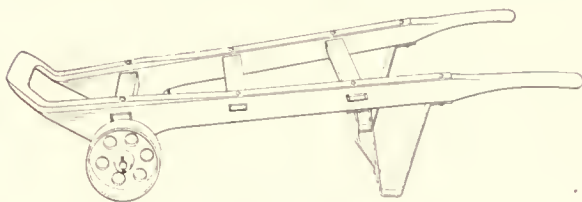

Stevadore Truck

bales, barrels or bags. Many modifications are available for a large number of special applications. One has two large wheels and one small wheel. The operator raises or lowers the load about a leverage point near the floor and readily pushes or pulls the load which is carried on the three wheels. In spite of its adaptability, this type is

being superseded gradually by mechanically operated power trucks of many designs.

Platform Type

This type is used in many places where short and infrequent hauls and the necessary standing and waiting time

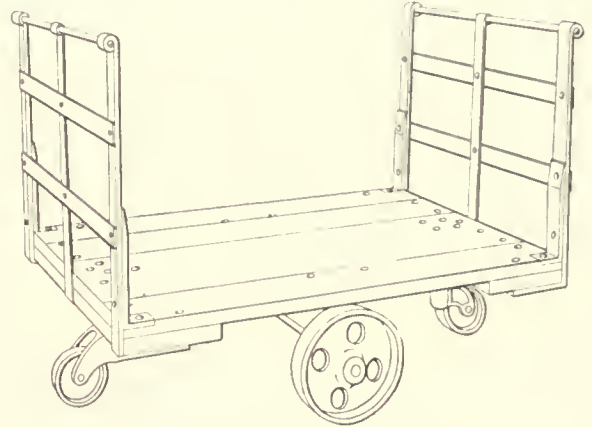

Platform Truck with End Racks

preclude the use of a tractor or a power truck. The following general forms are available: Stake trucks, with end stakes or side stakes and with four stakes or six stakes; bar handle trucks; end rack trucks; trucks with three sides closed; trucks with four sides closed; multiple deck trucks.

They are similar in construction to the larger trailer truck described in detail under trailers. They are, however, generally of lighter construction and are manufactured with numerous modifications which make them adaptable for a wide range of service. They are furnished with wheels of various sizes, and with platform bodies of many sizes and different heights from the floor, each one of which is best adapted for a certain movement, and for a particular kind of commodity.

These types are not used in a trailing train and are not furnished with connectors. Ease of operation is enhanced by ball bearing wheels whereby the operator, with little effort, is able to haul or push a comparatively heavy load, once it has been placed on the truck.

A modification of this type is an all-metal truck with drop sides or end. It is used as a charging cart for moving coal and may be taken to any part of the plant for loading, placed in any position for charging, and obviates the use of floor rails.

Lift Type

It has been proven repeatedly by tests that the old-fashioned method of trucking with fixed platform trucks wastes 75 per cent of the operator's time. This is true for the reason that these trucks require prompt loading and unloading to keep them in service.

The basic idea of the use of either the hand or electric elevating truck is the economic practice of keeping material on a large number of detached skids or platforms from the time that it enters the plant in a raw or unfinished condition and through the various processes of machining and finishing and then into the shipping or storage rooms. The material so loaded, rather than piled on the floor, saves extra handling and makes possible a quick change of location and releases the truck for other work while the platforms are being loaded or unloaded. Incoming stock, finished and unfinished stock in the process of manufacture, in shipping or storage rooms, in warehouses or terminals,

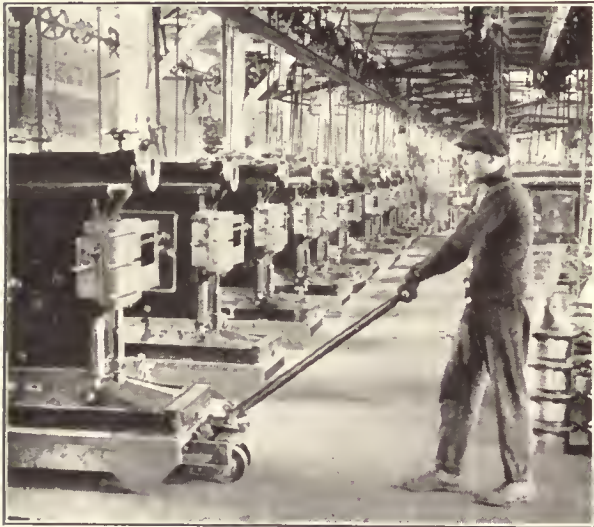
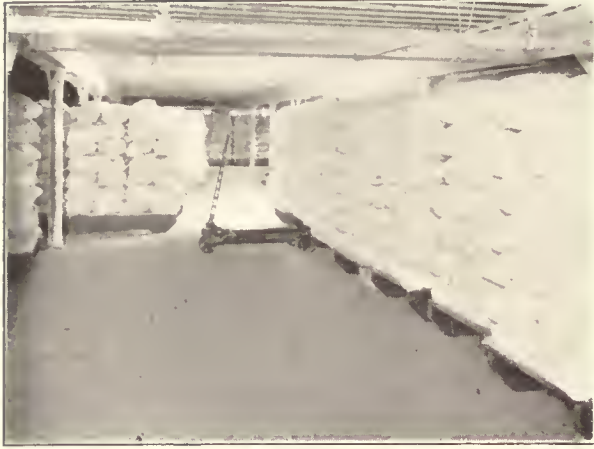

The Illustrations Indicate the Adaptability of the Hand Lift Truck

can be placed on and remain on platforms and be shifted from place to place with a minimum of handling.

When the truck is rolled under a loaded skid and the handle is thrust downward, the lifting bars raise the skid and the load from the floor. When elevated, the supporting bars assume a fixed position and remain rigidly locked together until released by the operator. In descending, a powerful hydraulic check eases the heaviest load smoothly

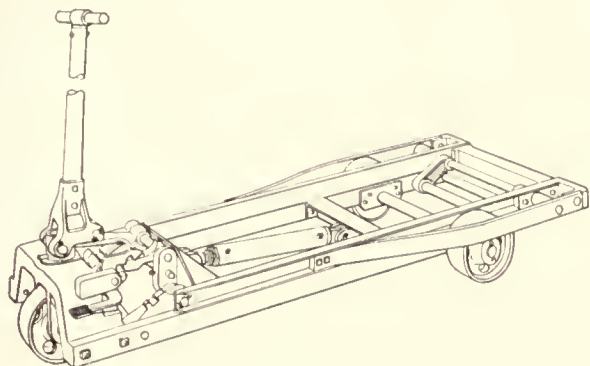

Lift Truck

and evenly to the floor. The truck is then pulled out from under the skid and is ready for another load.

For many installations, where the length of haul and congested floors are limiting features, this type of truck with skid platforms serves the purposes of the many times more expensive power truck. Or this type may be used in the sense of a "switching" engine, or be used to "jockey" into place or position, loaded or empty platforms for a trailing load with a tractor. The trucks for this service are furnished with suitable connectors.

Modifications of this type are available and one form uses either a flat platform or a platform with a steel or

wooden tray, or with a box extension. The platform is equipped with two rear wheels, permanently attached, and a single front leg for a support.

A second unit is the handle for hand operation or the trailer hitch for operation as a trailer with a tractor. Either of these attachments has a wheel and is also provided with a tongue which engages the front leg. Only the front end of the truck requires elevating and this is done by a downward movement of the handle or trailer hitch.

Another modification of this type is the form into which is built an accurate beam scale. With this attachment the lift type truck not only transfers and stores raw material or merchandise with speed and labor saving economy but completely eliminates the necessity of transferring loads to separate scales for weighing. Material loaded on skid platforms can be accurately weighed while resting on the truck and the gross, net and tare weights quickly determined. When transferring material the loaded platform is supported on a special set of side bars so that there is no strain on the scale mechanism.

The hand lift truck is used for inter-departmental movements only. For long hauls, the power truck is used for moving the platforms.

Wheels for Hand Trucks

The stevedore type, the single handle type and the platform type hand trucks are sometimes furnished with rubber tires or cushion tired wheels and are satisfactory for special service. This feature is not recommended for general service because of the added cost of operation caused by the rapid wear usually resulting from the condition of roadways and floors, which makes frequent repairs to the rubber tires necessary. However, the rubber tired wheels are used where material is to be moved over good floors and where quiet operation is essential, as in carpet mills, large wholesale houses, restaurants, hotels or department stores, arsenals, post offices and public buildings.

Power Trucks and Tractors

Power driven trucks and tractors were practically unknown until recent years. Now they are in daily service in industrial plants and in marine and railroad terminals. In every case where goods of any kind are being transported over considerable distances within the premises of railroad and steamship terminals, factories and warehouses, power trucks and tractors may be used to a decided advantage. They make transportation quicker and better, and in many places they have been pronounced indispensable because of the great economies effected. If freight or merchandise in sufficient quantities has to be moved as short a distance as 50 ft. an industrial power truck or tractor will handle it profitably. Over longer distances a truck or tractor and trailers will do the work of from 8 to 10 men.

Tractors and trucks wend their way down narrow aisles, turn sharp corners, climb ramps, and perform a wide variety of tasks with efficiency and ease in hundreds of plants where the owners once thought their successful operation absolutely impossible. The industrial power truck and tractor is limited in performance by the characteristics of the particular service and also, to a large extent, by the fact that these trucks and tractors, with the exception of the track laying type, are designed for indoor or interplant service and consequently for short hauls about plants, warehouses or terminals.

Aside from the savings in cost of moving material the question of labor is an important one. The power truck or tractor is simple in operation. A woman, boy, or ordinary

laborer, can be taught to operate one of these machines in a short time, and will become proficient in a few days. The operator of a power machine is able to work longer with less physical strain than the operator of a hand truck and is, consequently, more dependable.

The power machine is flexible. It may be run readily into crowded places, narrow aisles, on and off elevators, on all roads that are fairly smooth and level, into box cars, and into the holds of coastwise ships. It is not dependent upon rails unless so designed. It is rugged and reliable and built to stand more or less abuse in the hands of inefficient and careless help.

The power truck, in most types, will handle all classes of commodities in loads that do not exceed 4,000 lb. It carries a load equivalent to that moved by 8 to 12 men, carrying it from 5 to 7 times faster than a man moves it by hand truck. The tractor pulls a trailing load up to 10 tons maximum at a speed up to $5\frac{1}{2}$ mi. an hour. The power truck or tractor must be kept busy to show the best results. They lose money for the owners when they are not moving. A power truck or tractor occupies little more space than a man with a hand truck and may be operated anywhere a man with a hand truck can work. They will go many places he cannot go, and without the assistance of helpers.

Dependent upon the commodity carried, the distance traveled and the loading and unloading methods used, tractors and trailers will handle material at a less cost

per ton than the power truck but they lack the extreme individual flexibility found in the latter. The lower cost is due to the fact that an operator and a helper can handle a tractor with a train of from 4 to 12 trailers, each carrying from $\frac{1}{2}$ to $1\frac{1}{2}$ tons or an average total of 8 tons or 4 tons per man. The power truck while capable, in many cases, of handling heavy loads, will probably not average a ton and a half per truck and an operator is required for each truck, and often a helper as well.

Maintenance is less on tractors and trailers, as the number of power machines to be maintained is less for a given tonnage than if power trucks are used. Trailer maintenance of course has to be included but it is a small item as compared with power trucks.

The use of power trucks or tractors reduces the damage and breakage to material, produces more ambitious and willing workers, saves the equivalent wages of from 6 to 15 men, and they will pay for themselves in from 3 to 9 months, depending on the use, care and operation.

Characteristics

Power trucks and tractors are manufactured in two types; i. e., storage battery type and gasoline engine type. Roughly speaking the most economical distance per haul to operate an electric power truck is about 1,000 ft. to 1,200 ft. and the most economical distance per haul for a tractor is from 1,200 ft. to 2,000 ft. The gasoline engine type of truck or tractor may be operated economically over slightly longer distances.

The storage battery type is cheaper in operation than the gasoline engine type; it has fewer small parts requiring adjustment and to be repaired, and its operator is more fully protected from mishaps. The gasoline engine type, however, is cheaper in first cost than the storage battery type and is not limited to the capacity of a battery, while, on the other hand, it must always be well supplied with gasoline, water and oil. No expensive charging equipment is required. Its speed is considerably higher, which is an important advantage for installations where the average run is of considerable length. The noise and smell and the poisonous fumes of the exhaust of the gasoline engine type sometimes prove objectionable in indoor service and fire rules preclude its use in some warehouses and buildings. Either type has sufficient speed variation to permit high speed when returning light and low speed for heavy duty hauling.

Tractors are usually manufactured with a worm drive while the chain or spur gear drive is generally used in power truck construction. The chain drive is more efficient, especially at slow speeds, and is recommended where heavy grades are to be encountered. The worm and spur gear drives require less attention, are more quiet in operation, and for general application are more dependable.

In either type all parts are accessible for care, attention, adjustment and lubrication. All electrical parts in the electric types are fully protected against grounds, short circuits, and other electrical and mechanical defects.

Safety devices are essential in the electric types and special care has been used in the design of these machines to make them "fool proof" in operation and safe in the hands of the novice. This is attained, mainly, by interlocking the braking and controller systems so that the machine is only capable of movement if the initial sequence of action is correctly taken by the driver. The instant the driver leaves the machine the current is shut off from the motor and the brakes are applied automatically. The machine cannot be started while the operator is standing on the ground. The electrical equipment is fused so that

it cannot be damaged no matter how quickly the current is turned on or shut off. The current is automatically shut off if the operator's hand is removed from the starting lever.

The engine of the gasoline engine type is of the four-cylinder, four-cylinder, improved type, either horizontal or vertical. The motor for the storage battery type is enclosed, series wound with a high starting torque, low current consumption and a large overload capacity for emergency. The motor is designed to give the best results with the lowest possible drag on the batteries.

The gasoline engine has characteristics such that the torque remains practically constant with a wide variation in speed. A transmission is employed to deliver greater torque at lower truck or tractor speeds. The torque in the electric motor increases with a decrease in speed, automatically giving greater pulling power at lower speeds.

Batteries and Battery Charging

The batteries used in the electric types may be either the lead or the alkaline type, both of which are in common use. The general characteristics of the two types are similar, but they differ widely in specific points. Each type of battery has its advocates who contend that it has superior characteristics for the tractor or power truck service.

Direct current is used for charging. If direct current is the source of supply, it is furnished at the right voltage, either through a battery charging resistor or by a two-unit balancer set. If the source of supply is alternating current the mercury arc rectifier, motor generator set or rotary converter may be used to convert the alternating current to direct current. The charging station should be so located that a truck or tractor will never have to travel more than 1,000 ft. or 1,500 ft. from the center of the area in which it operates to the place where it is to be charged. It is recommended that two sets of batteries be used for continuity of service.

Application

Three systems are available for transporting material by power trucks or tractors:

First: Trucks which carry loads on their own platforms.

Second: (a) Self-loading and unloading with the elevating platform and tiering trucks; the use of live platforms or dead platforms or skids eliminates hand loading and unloading. (b) Semi-loading or unloading with the crane type and dump body type trucks.

Third: The tractor-trailer system. The material handled by this system is loaded on trailers hauled by tractors.

Storage Battery Trucks

The storage battery truck is a self-propelled machine that carries its load. Generally this type has a rated capacity of about two tons. It has a chassis, three or four wheels and a power equipment consisting of a motor and a storage battery. It is manually operated by the driver who usually stands facing the load. Different forms have been developed whereby the steering is accomplished by all four wheels in order to increase the ease of operation in congested aisles; driving by all four wheels so as to attain maximum adhesion, and the development of many other forms of construction that assist greatly in quick and efficient moving of material.

Except for the time required for watering and the charging of the storage battery, the truck is always ready for service and no work within reason is too severe.

This truck is used for transporting all kinds of general parcel freight, such as bags, boxes, bales and barrels. It is also utilized for transporting loose materials, such as metal parts, castings and bulk materials, which are usually

handled in special containers. These trucks are used to move material from one department to another in industrial plants, or between common carriers and warehouses on piers, or in railroad terminals where flexibility of equipment is desired which is not possible with industrial railroads or cranes that are confined to given paths of travel.

Platform Type

The platform type, where freight and material is carried on the platform of the truck, is built in various sizes with

A modification of this type which may be used either as a load carrying truck or with skid platform trucks is available. This form is equipped with four elevating jacks, one in each corner of the truck platform, all of which are operated by one motor. The jacks raise or lower the loaded or empty skid platforms and permit quick unloading and consequently a proportionately greater amount of operating or running time for which larger batteries are provided. The batteries are mounted under the platform, thus forming a much larger loading surface than is usual.

GENERAL SPECIFICATIONS FOR STORAGE BATTERY TRUCKS
Types

	Platform	Low platform	Elevating platform	Baggage	Crane	Jump body	Tiering
Carrying capacity.....	2,000 lb. to 4,000 lb.	4,000 lb.	4,000 lb. to 5,000 lb.	4,000 lb.	1,000 lb. to 3,000 lb.	12 cu. ft. to 40 cu. ft.	2,000 lb. to 4,000 lb.
Overall length.....	80 in. to 140 in.	82 in. to 137 in.	91 in. to 110 in.	170 in. to 206 in.	101 in. to 156 in.	109 in. to 122 in.
Overall width.....	28 in. to 40 in.	36 in. to 41 in.	25 in. to 55 in.	37 in. to 60 in.	38 in. to 51 in.	36 in. to 41 in.
Size of platform.....	10 sq. ft. to 40 sq. ft.	12 sq. ft. to 26 sq. ft.	8 sq. ft. to 10 sq. ft.	28 sq. ft. to 48 sq. ft.	10 sq. ft. to 12 sq. ft.
Wheel base.....	36 in. to 83 in.	51 in. to 78 in.	44 in. to 55 in.	72 in. to 116 in.	36 in. to 83 in.	36 in. to 83 in.	56 in. to 62 in.
Wheel tread.....	20 in. to 48 in.	Front—16 in. to 32 in. Rear—24 in. to 34 in.	Front—8 in. to 18 in. Rear—18 in. to 32 in.	32 in. to 48 in.	20 in. to 48 in.	20 in. to 48 in.	Front—18 in. to 20 in. Rear—27 in. to 32 in.
Weight with battery.....	1,700 lb. to 3,400 lb.	1,300 lb. to 3,200 lb.	2,150 lb. to 2,750 lb.	3,100 lb. to 3,600 lb.	2,600 lb. to 4,200 lb.	2,000 lb. to 3,400 lb.	3,100 lb. to 3,300 lb.
Lift of platform.....	3½ in. to 4½ in. lowered	31 in. to 96 in.
Height of platform.....	18 in. to 26 in.	9 in. to 17 in.	10 in. to 17 in.	24 in. to 33 in.	9 in. to 26 in.	9 in. to 26 in.	10 in. to 11 in. lowered
Turning radius—
Inside edge.....	72 in. to 120 in.	30 in. to 42 in.	42 in.	72 in. to 120 in.	30 in. to 120 in.	42 in. to 54 in.
Outside edge.....	144 in. to 204 in.	84 in. to 96 in.	96 in.	144 in. to 204 in.	84 in. to 204 in.	92 in.
Motor.....	Heavy duty, totally enclosed, series wound. An additional motor is usually furnished with the crane type and sometimes for the elevating platform and tiering types.			Circuit breaker.....Integral part of controller, quick make and break, single or dual contact operated by brake pedal, current off when brake is on, current on when brake is released.			
Drive.....	One, two or four wheel.			Speeds.....Two to four in either direction.			
Speed (on level).....	.88 ft. to 700 ft. per min.; 1 mi. to 8 mi. per hr.			Brake.....Internal expanding or external contracting on the jack or motor shaft or on each rear or driving wheels.			
Frame.....	I-beam, channel or angle, with or without coil or leaf spring suspension.			Axles.....Two or four, depending on model. Front or rear or both full floating.			
Steer.....	Two or four wheel with steering wheel or lever operating vertically or horizontally; also semi-irreversible.			Wheels.....Spoke or solid cast iron or steel.			
Transmission.....	Spur gear, chain drive, worm drive, motor in the wheel.			Bearings.....Roller or ball.			
Control.....	Series parallel; connection of battery cells and motor field coils or straight resistance.			Batteries.....Alkaline or lead.			
Controller.....	Drum type enclosed; positive neutral stop operates automatic circuit breaker connected to brake pedal.			Warning signals.....Mechanical or electrical bell or horn.			
				Tires.....Solid pressed-on rubber or fabric.			

a maximum capacity of 4,000 lb. The platform is usually from 20 in. to 24 in. above the ground. This type carries its load just as an automobile carries its load and

The drive consists of a motor for each wheel of the same size as the motor which operates the jacks. It is equipped with wheels of sufficient diameter to permit its use on city streets or between building, as well as indoors.

Low Platform Type

The low platform type is built in various sizes for carrying material and has a platform placed about 11 in. to 17 in. above the ground. This type is best adapted for

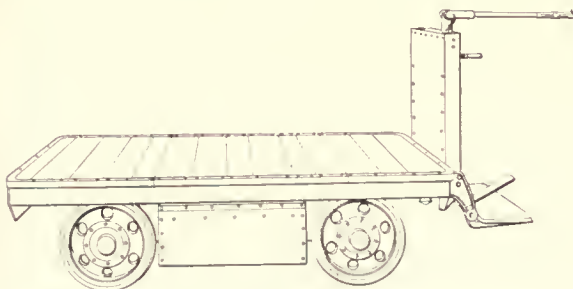

Platform Truck

works to the best advantage with packages that can be readily hauled by one or two men. Such trucks are especially adapted to work where they must be driven, loaded and unloaded by the same man, or wherever material is to be moved to scattered locations in such small quantities that it would not pay to have gangs of men to load and unload it.

The platform or load carrying truck serves best where hauling is restricted to narrow aisles; to loading platforms; on concrete strips in the foundry, forge, mill or across the yard; and where the destination is near thickly set machines; on a congested warehouse floor, or on docks for short hauls and "across the dock" service, and where the speed is of greater importance than the tonnage.

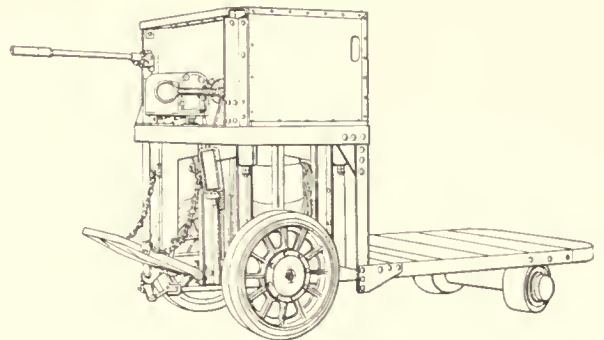

Low Platform Truck

carrying heavy packages and pieces weighing from 150 lb. to 200 lb., such as barrels, bales, castings, heavy crates, etc. The greater the weight of the separate pieces to be loaded, the lower the platform should be. It has been repeatedly demonstrated that after piling is carried to a certain height, it is false economy to require lifts that

waste men's energy. As a rule packages and pieces weighing 150 lb. to 200 lb. can seldom be lifted higher than the knee, 75 lb. to 100 lb. waist high, and 25 lb. to 35 lb. shoulder high. It is interesting to note that these heights are being decreased year by year because of labor conditions.

A modification of this type is used for handling heavy rolls of paper and cloth. This form uses a special mechanism mounted on the frame of the low platform truck consisting of a sheet metal quadrant, two clamps, and a revolving frame. The quadrant is in front of the truck and very near the floor. The manipulation of this mechanism, as well as the operation of the truck, is in the control of the operator who stands on the truck and rides with it. When being used, the roll, which lies on the floor, is easily rolled into the quadrant and two arms or clamps, one at each end, securely hold it. The roll can then be upended into a vertical plane, but at an angle from the perpendicular so that the center of gravity of the roll is over the truck frame, in which position it is carried.

Elevating Platform Type

The elevating platform type is similar to the low platform type, but has a movable platform which can be raised or lowered by a separate electric motor. The truck platforms are built in various sizes and are from 10¼ in. to 17 in. above the ground when in the lowered position. They have a lift of from 3½ in. to 4½ in.

This type has the advantage over the other types of power trucks in being able to work more continuously. Standing time and extra handling are eliminated if the

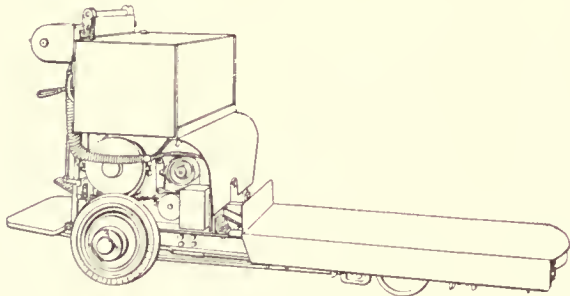

Elevating Platform Truck

load is of such nature that it can be carried on wooden or metal skid platforms. The low end of the truck runs under the loaded or empty skid platforms and electrically elevates it. The truck then moves to the desired location.

This type of truck is recommended where the volume of material to be moved and the length of haul precludes the use of the hand lift truck. Where commodities in warehouses and terminals are placed on skid platforms, either for temporary or permanent storage, and are ready to be moved quickly to other locations this type of truck serves to advantage. It is recommended for operation in industries where the material may be handled through the course of manufacture from one process of finishing to another, on various forms of skid platforms.

Tiering Type

The tiering type has many applications over a wide range and is similar to the elevating platform type. The lifting and driving devices are separate and both can be operated at the same time when desired, a feature which greatly facilitates the ease and speed at which this machine may be operated. It has the added feature of lifting or tiering the load from one inch to six or more feet, and is adapted to loading boxes, barrels and bales onto large auto truck bodies

and into freight cars. It is used to advantage for tiering large rolls of paper and for putting heavy dies or stock in machines. It is recommended for use with skid platforms for hauling material, or for placing or piling the loaded or empty platforms for storage.

This type may be used with a skid platform, having a side or end dump body, for removing dirt, coal, ashes or

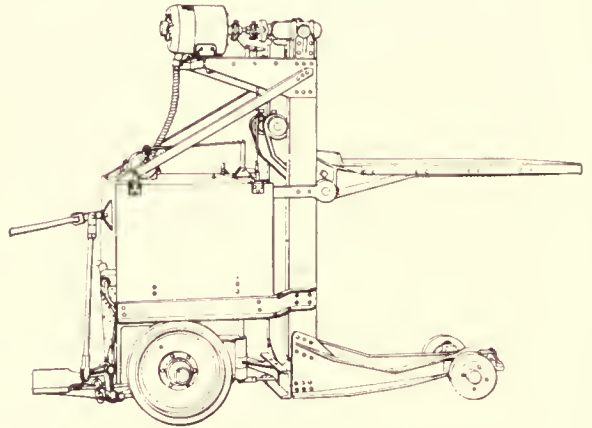

Tiering Truck

scrap material by elevating the load and dumping it into an auto truck or car.

A useful accessory to this type is a platform with rollers. This is permanently fastened to the arms that are elevated and permits heavy loads to be easily pushed on or off when it is in an elevated or lowered position.

A modification of the tiering type is basically a load carrying truck, having on it a piling or tiering machine. For high piling a second modification consists essentially of a load carrying truck on which is mounted a hoist which raises and lowers a platform between two vertical uprights.

Baggage Type

The baggage type is built with a straight or drop frame, similar to the load carrying truck or a combination of the load carrying and low platform models. Some are equipped with high rack bodies for holding in position bags, trunks

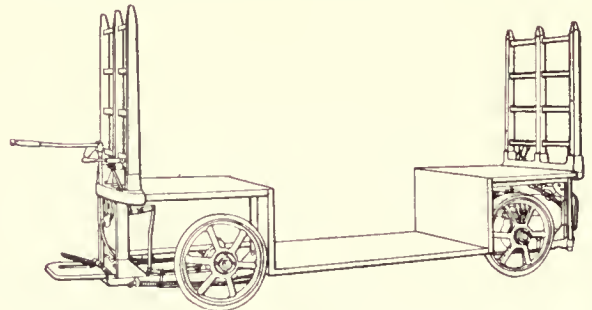

Baggage Truck

and mail pouches. These are essentially railroad terminal machines and are especially recommended for this service. The drop frame is designed for use in the terminals where the tracks are depressed.

Crane Type

The crane type is especially adapted to handling heavy weights in localities where the truck must move but short distances. This type is equipped with either an electrically or hand operated crane of 1,000 lb. to 3,000 lb. capacity, mounted permanently or temporarily on the load carrying

or low platform models. The compensating boom is equipped with a swivel base so that it will swing 90 deg. each way. The load is carried on the hook or is lifted

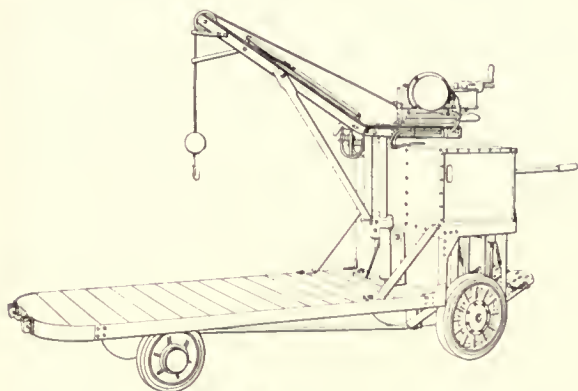

Crane Truck

by the crane to or from the truck platform and is carried thereon.

A modification of this type equipped with a magnet attached to the hook on the crane is useful for lifting castings and scrap iron and steel. Other modifications of this type are available, having a larger boom of stronger construction for heavier loads.

Dump Body Type

The dump body type is used for hauling coal, ashes, sand, fertilizer, cement and loose material. It is built in various sizes and shapes for capacities ranging from 12 cu. ft. to 40 cu. ft., and for either side or end dump. Either style may be unloaded without the operator dismounting. The

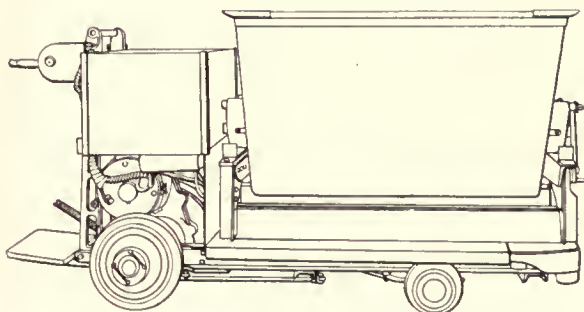

Dump Body Truck

frames and bodies are either permanently fastened to the truck chassis or are bolted to the platform so they may be removed, if desired, and the truck used for other purposes. This type is sometimes furnished with narrow gage trucks fitted with flange wheels for use on a narrow gage track.

Gasoline Engine Trucks

A power truck that has somewhat higher speed than the storage battery type can be used advantageously in many places. This is possible with a gasoline engine drive. Trucks of this type are designed with a capacity of 2,500 lb. in the three-wheel type and 3,000 lb. capacity in the four-wheel type, and operate at speeds varying from 1/2 mi. to 12 mi. an hour. The driver's seat in the three-wheel type is mounted over the engine and the load is carried in front of the driver and immediately over the two front wheels. The truck is steered by the single rear wheel which is somewhat smaller in diameter than the two front wheels. In the four-wheel type of 3,000 lb. capacity the

platform is at the rear of the driver's seat and the engine is of the horizontal type. In either the three-wheel or the four-wheel types the control is exceptionally flexible and the comparatively short wheelbase makes possible a small turning radius.

In either the three- or four-wheel form the gasoline

GENERAL SPECIFICATIONS FOR GASOLINE ENGINE TRUCKS

	Types		
	Cargo type	Dump body type	Stake body type
Carrying capacity...	2,500 lb.	27 cu. ft. dry 18 cu. ft. wet	2,500 lb. to 3,000 lb.
Overall length.....	128 in.	139 in.	124 in. to 159 in.
Overall width.....	46 in.	50 in.	43 in.
Area of platform...	27 sq. ft.	27 sq. ft.	16 sq. ft. to 24 sq. ft.
Wheel base.....	78 in.	78 in.	78 in. to 81 in.
Wheel tread.....	35 1/2 in. to 40 in.	50 in.	36 in. to 40 in.
Weight	2,500 lb.	2,450 lb.	2,500 lb.
Lighting—starting and ignition.....	Complete lighting, starting and ignition system or magneto for ignition and lighting only.		
Drive	Heavy roller double side chains, internal gear or chain from jack shaft to rear wheel.		
Speed—on level....	1 mi. to 12 mi. per hr.		
Frame	I-beam, channel or angle, with or without spring support at either or both ends.		
Steer	Screw and nut type, or knuckle and rod. Wood or metal wheel with throttle control.		
Type of transmis- sion	Selective type; two or three forward and one reverse.		
Motor	Four cylinder; four cycle; horizontal.		
Brake	Foot brake and hand brake direct connected to rear wheels; positive contracting on transmis- sion; or internal expanding.		
Clutch	Single plate or dry plate multiple disc or cone, or multiple steel disc in oil.		
Axles	Chrome nickel or vanadium steel, round or I- beam section.		
Bearings	Roller or ball.		
Wheels	Cast steel or cast iron disc.		
Tires	Solid rubber pressed on.		
Fuel	Distillate, gasoline and distillate or gasoline.		
Warning signals....	Mechanical horn.		

engine truck is applicable in many places where the load carrying storage battery truck could be used. It is especially adapted for short hauls, for interplant service, and for out-of-door service. It might be considered applicable to hauls that would extend slightly beyond the practical hauling distance of the storage battery type. It is furnished in three types.

Cargo Type

This type is manufactured with either the three or four-wheel form of construction. It may have either a flat platform, or a box type body, or a container mounted on the platform of the chassis. It is used for moving goods in

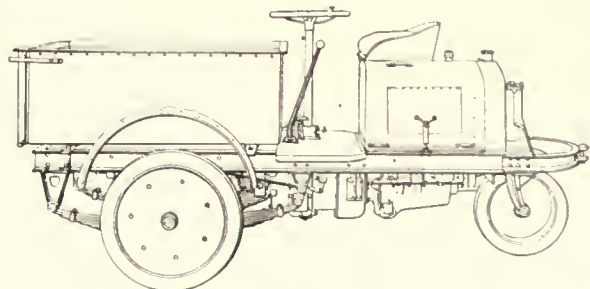

Cargo Type Truck

small boxes, including parts such as small castings. It is useful where raw stocks are hauled to machines, or finished materials to stock or shipping rooms.

Platform Type

In this type, which is of the three-wheel construction, the material is ordinarily held within end and side stakes, which

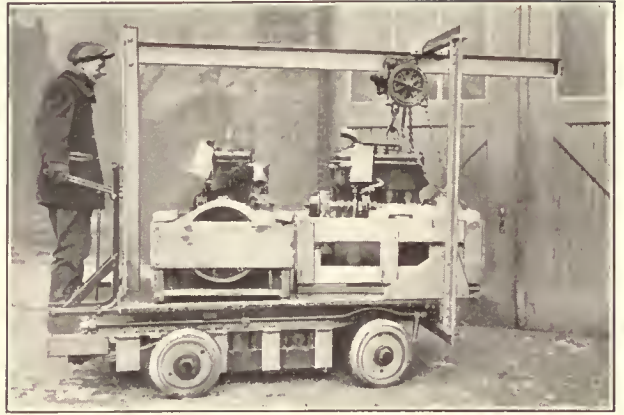

The Illustrations Indicate the Wide Range of Application of Power Trucks

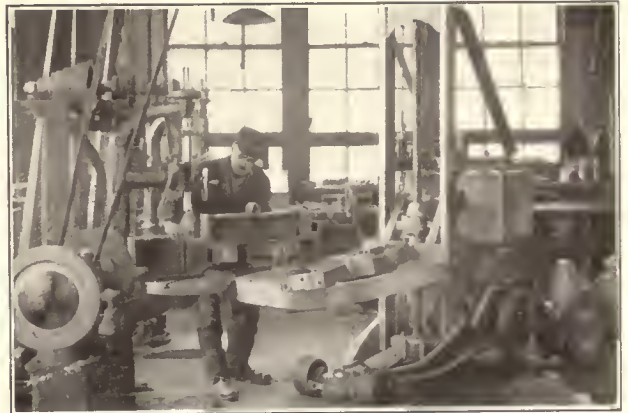

The Illustrations Indicate the Wide Range of Application of Power Trucks

are mounted either temporarily or permanently. With the stakes in position, this type is recommended for hauling crates, large castings, boxes and bags. With the end

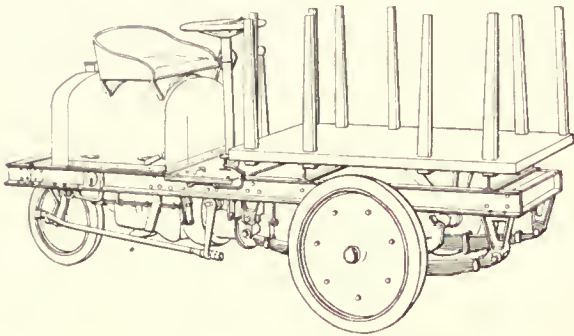

Platform Truck with Stakes

stakes removed the truck has a clear platform and is applicable for carrying long material, such as lumber, steel rods, steel pipes and sheet metals.

Dump Body Type

This type, with the three-wheel construction, has a chassis on which is mounted a body arranged for end dump. It is used for hauling bulk material and for the quick handling of dry and wet materials, such as sand, ashes, concrete, fertilizer, chips and sweepings. It is adapted for paving, road building and general contract work. It will readily spot its load and dump it nearly flat.

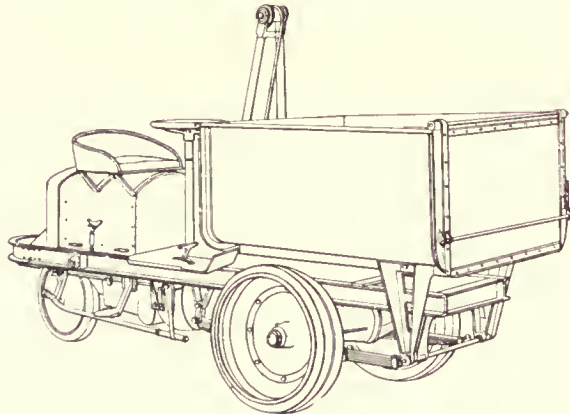

Dump Body Truck

This type may be unloaded without the operator dismounting, or he may dismount and slowly dump the body by a hand-operated hoist. The body is built in capacities of 1 cu. yd. of dry or 18 cu. ft. of wet material.

Storage Battery Tractors

A storage battery tractor is a self-contained power unit which has proven to be one of the most economical forms of transfer units for use where heavy tractive effort is required and where large tonnage is to be transferred on a single trip. It carries no load, but pushes or pulls its load on trailer trucks. The number of trailers one tractor can keep in operation depends on working conditions, such as length of haul, nature of material and weight of the load on each trailer.

The machines, to give best results, must be kept moving and the waiting loss may be partially eliminated by the use of a larger number of trailers. Such a tractor may be used to move material from the pier to the head house,

from one department to another, or for other long hauls. Under normal conditions, one tractor can keep three sets or "fleets" of trailers occupied, one loading, one under way and one unloading.

In the use of tractors and trailers, it is only second in importance to assurance that the proper tractor is provided, that the trailer best suited for the work in hand is used. Home-made trailers often answer all requirements and the use of hand trucks as trailers may be justified by circumstances. Care should be taken, however, to make sure that the advantages to be derived from their use are real and not imaginary.

Power or tractive effort of any tractor depends directly upon the weight on the drive wheels and the ability of the motor to turn them under that weight. The tractor can

GENERAL SPECIFICATIONS FOR STORAGE BATTERY TRACTORS

Capacity—drawbar pull	Types		
	Three wheel	Four wheel	Center control
Normal	600 lb. to 1,500 lb.	250 lb. to 1,500 lb.	300 lb. to 1,500 lb.
Ultimate	1,600 lb. to 2,000 lb.	1,000 lb. to 2,500 lb.	1,200 lb. to 2,500 lb.
Overall length	68 in. to 72 in.	60 in. to 88 in.	71 in. to 87 in.
Overall width	36 in. to 41 in.	34 in. to 48 in.	36 in. to 41 in.
Wheel base	30 in. to 44 in.	21½ in. to 44 in.	30 in. to 49 in.
Wheel tread	27 in. to 33 in.	21½ in. to 40 in.	27 in. to 34 in.
Weight with battery	2,200 lb. to 2,400 lb.	2,200 lb. to 4,400 lb.	2,300 lb. to 4,400 lb.
Turning radius, outside edge	57 in. to 65 in.	67 in. to 129 in.	61 in.
		two wheel steer	four wheel steer
Drive	Two-wheel	Two or four wheel	Four wheel
		Chain or worm drive	Chain or worm drive
Transmission	Worm drive		
Motor	Heavy duty totally enclosed series wound.		
Speed—no load	500 ft. to 700 ft. per min., 5½ mi. to 7½ mi. per hr.		
Frame	I-beam, channel or angle, with or without coil or leaf spring suspension.		
Steer	Front wheel or two or four wheel, with wheel or lever operating horizontally or vertically.		
Control	Series parallel connection of battery cells and motor field coils or straight resistance.		
Controller	Drum type enclosed. Positive neutral stop operates automatic circuit breaker connected to brake pedal.		
Circuit breaker	Integral part of controller, quick make and break. Single or dual contact operated by brake pedal. Current off when brake is on, current on when brake is released.		
Speeds	Three or four forward and reverse.		
Brake	Internal expanding or external contracting on jack or motor shaft or on each rear or driving wheel.		
Axles	One, two or four, depending on model, front or rear or both full floating.		
Wheels	Spoke or solid cast iron or steel.		
Bearings	Roller or ball.		
Batteries	Alkaline or lead.		
Warning signals	Mechanical or electric bell or horn.		
Tires	Solid pressed on rubber or fabric.		

draw a heavier tonnage than a carrier type truck of equal battery capacity. It has sufficient tractive effort to haul trailer loads of 7,000 lb. to 20,000 lb., maintaining a speed or 3 mi. to 4 mi. an hour.

Tractors are employed principally to fulfill the following conditions:

- (a) Where loads exceed two tons. (Steel and iron products.)
- (b) Where material is more than eight feet in length. (Lumber, automobile frames, etc.)
- (c) Where especially constructed or expensive hand trucks are already installed to suit the commodities which are to be transferred.
- (d) Where goods must be sorted in small unit loads, and can be collected at one spot, then coupled in trains to be delivered to a single point or distributed.
- (e) Wherever loading or unloading gangs can be employed.
- (f) Where an industrial rail system with expensive

cars cannot be abandoned; the tractor for this installation to run either on the rails or on the floor or roadway.

Three types of storage battery tractors are available.

Three-Wheel Type

This type is best suited for railroad and marine terminals, or in other places where the trailing load, even though the usual number of trailers is in operation, is a comparatively light one. It is designed as a general purpose tractor

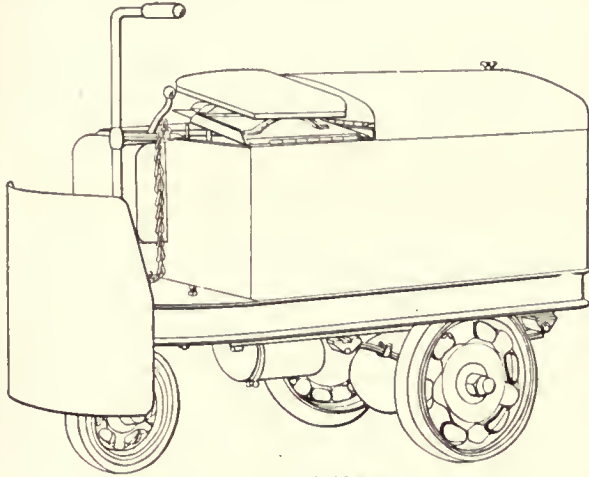

Three-Wheel Tractor

to meet average hauling conditions, but is especially adapted to places where it must work in narrow aisles, or in difficult alcoves and must run through small doorways.

It is primarily a machine for indoor service. It is sturdy in construction and turns in very close quarters—the steering being by the front wheel only.

A modification of this type is the tractor with a twin wheel in front. This arrangement consists of two wheels on a single short axle with springs, the whole being suspended in a bracket to steer as a single wheel.

Four-Wheel Type

This type is designed to meet the demand for a heavy duty tractor and is especially recommended for service in manufacturing plants and industries and in other installa-

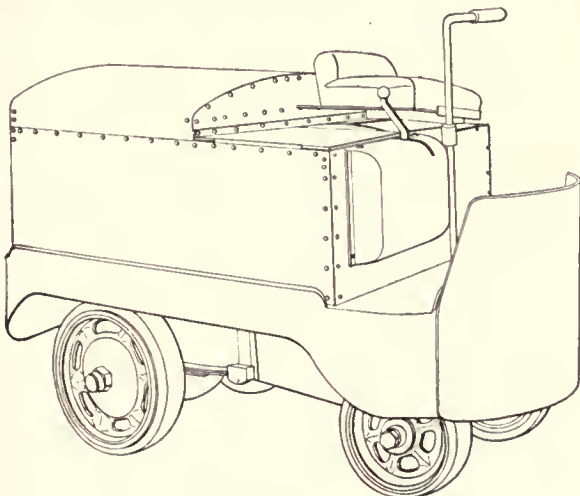

Four-Wheel Tractor

tions where the haulage is of a heavy character. It is more stable than the three-wheel type and is, primarily,

a machine for outdoor service. A heavy stable machine is, of course, necessary to prevent mishaps on uneven roadways, and where there are holes and ruts in the road.

This tractor carries approximately 30 per cent to 50 per cent larger batteries than the three-wheel type.

This type may use either the two or four-wheel steer, the two or four-wheel drive, and may have either chain or worm drive.

There is practically no difference in the space required to maneuver this tractor with the four-wheel steer and that required for the three-wheel type. It is seldom necessary, however, in actual practice to turn completely around when working, since dead end aisles are objectionable for many reasons.

This type is sometimes furnished with narrow gage trucks fitted with flange wheels for use on a narrow gage track.

Center Control Type

This type drives and steers with all four wheels and operates with equal power and speed in either direction.

The four-wheel drive gives maximum power for hauling heavy loads up grades or over rough and slippery floors, moreover, distributing the tractive effort over the four wheels increases considerably the life of the tires.

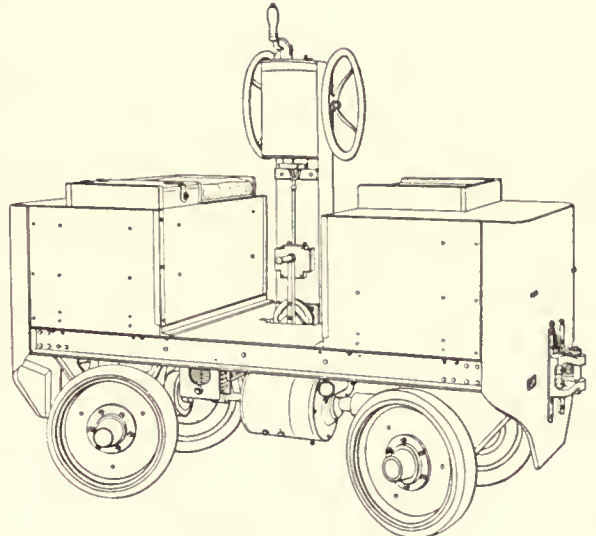

Center Control Tractor

The four-wheel steer permits better operation in narrow aisles, in freight cars and on loading platforms.

The control eliminates the necessity for turning around and backing up when coupling onto a trailer. This applies particularly in cramped quarters and is often a valuable time saving feature.

This type, like the four-wheel type, has heavy battery capacity.

Gasoline Engine Tractors

These tractors serve the same general purposes as the storage battery type tractors. This type, however, is not recommended for service where it is required to start a long train of heavily loaded trailers, as the weight of the tractor might not give the required traction and failure of the driver to operate the transmission in the proper manner might not give the desired torque for starting. Aside from this, the several types, with the exception of the track-laying type, are employed to fulfill the same general conditions as outlined for the storage battery tractors. Some designs, with special attachments, are applicable for

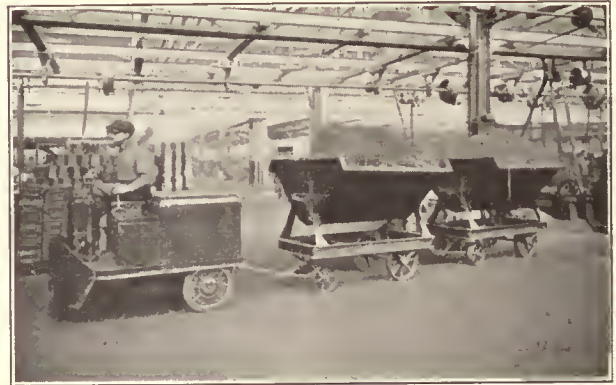

Typical Applications of Storage Battery Tractors

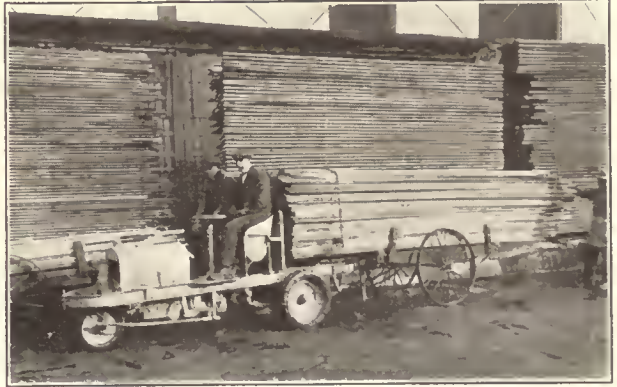
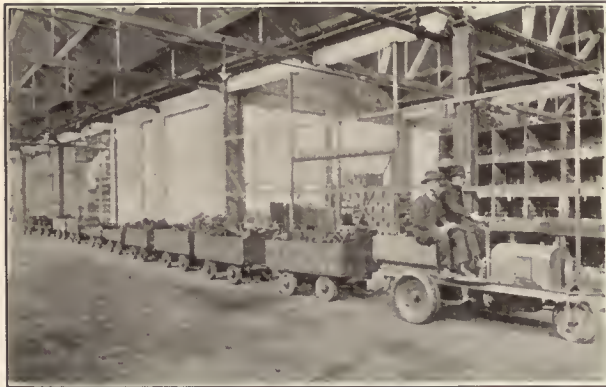
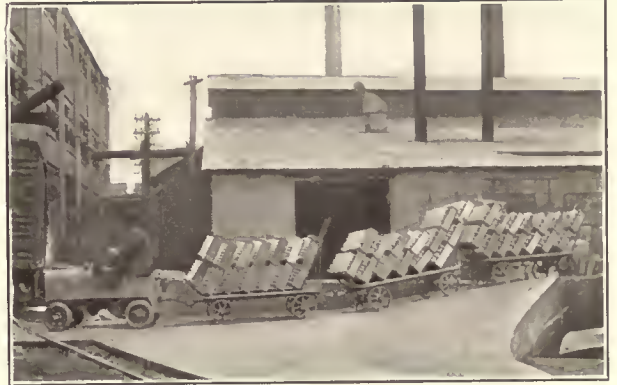

Typical Applications of Gasoline Engine Tractors

service in saw mills and lumber yards. The track-laying type is primarily applicable for outdoor service and with its particular construction can travel over good roads without injuring the surface and, as its tracks conform to the

GENERAL SPECIFICATIONS FOR GASOLINE ENGINE TRACTORS: WHEEL TYPES

	3-wheel type	4-wheel type
Drawbar pull	Motor torque and drive ratios furnish a drawbar pull ability approximately three times the tractive ability of the tires.	Motor torque and drive ratios furnish a drawbar pull ability approximately three times the tractive ability of the tires.
Overall length	126 in.	82 in. to 156 in.
Overall width	46 in.	43 in. to 56 in.
Turning radius, outside edge	96 in.	96 in. to 135 in.
Wheel base	78 in.	40 in. to 84 in.
Wheel tread	40 in.	36 in. to 47 in.
Weight	2,450 lb.	1,475 lb. to 5,400 lb.
Lighting—starting and ignition	Complete lighting, starting and ignition system or magneto for ignition and lighting only.	
Drive	Heavy roller double side chains, internal gear or chain from jack shaft to rear wheel.	
Speed—on level	1 mi. to 15 mi. per hour.	
Frame	I-beam, channel or angle, with or without spring support at either or both ends.	
Steer	Screw and nut type, or knuckle and rod. Wood or metal wheel with throttle control.	
Transmission	Selective type; two or three forward and one reverse.	
Motor	Four cylinder; four cycle; horizontal.	
Brake	Foot brake and hand brake direct connected to rear wheels; positive contracting on transmission or internal expanding.	
Clutch	Single plate or dry plate multiple disc or cone, or multiple steel disc in oil.	
Axles	Chrome nickel or vanadium steel, round or I-beam section.	
Bearings	Roller or ball.	
Wheels	Cast steel or cast iron disc.	
Tires	Solid rubber pressed on.	
Fuel	Distillate, gasoline and distillate or gasoline.	
Warning signals	Mechanical horn.	

GENERAL SPECIFICATIONS FOR GASOLINE ENGINE TRACTORS: TRACKLAYING TYPE

Drawbar pull	Rated 12 hp. at the coupling.
Overall length	96 in.
Overall width	50 in.
Traction surface	90 sq. in.
Turning radius	72 in.
Tread	10 3/4 in.
Weight	3,300 lb.
Speed	1/2 mi. per hour.
Frame	Two side frames built up of plate and angle iron.
Steer	Obtained by a planetary set on either side of the differential.
Drive	Through bevel gear and pinion; first reduction to spur gear differential, then to spur gear pinion, then to internal gear in rear wheel.
Motor	Four cylinder, four cycle, horizontal.
Fuel	Gasoline, kerosene or distillate.
Transmission	Sliding gear; one forward and one reverse speed.
Brake	Hand wheel operated brake on planetaries through gear set and screw-operated brake band ends.
Clutch	Single disc—enclosed in flywheel, foot pedal operation.
Bearings	Roller, plain, thrust or ball.

unevenness of the ground, it can travel over roads the condition of which would be a very serious handicap to other types of tractors.

Three principal types of gasoline engine tractors are available.

Three-Wheel Type

This tractor is adapted to comparatively light service and for outdoor service. A typical example is hauling one or more trailers between buildings in industrial plants or about lumber yards. It is used for hauling the many forms of trailers with various kinds of material in the process of manufacture or between loading and unloading points. The three-wheel type is similar in construction to the gasoline engine cargo type truck except the chassis is reversed and the tractor is operated with a single steering wheel ahead. This model is built with a box in which a fixed ballast load is carried for traction.

A modification of this type used in connection with a trailer or dolley which is coupled to the tractor by a towing hook and chain is useful for hauling lumber or similar

material. It is fitted with a bolster attachment that carries one end of the load which is securely clamped down

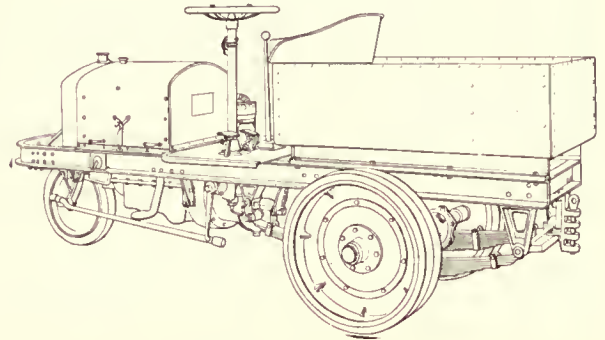

Three-Wheel Tractor

to the bolster to prevent it from slipping or moving from position.

Four-Wheel Type

This type is lighter in weight and has a shorter wheelbase than the three-wheel type. The latter feature makes possible a shorter turning radius and permits easy handling in close quarters. The driver's seat is over the rear axle and is so placed that the trailer may be coupled or uncoupled readily and quickly without the driver leaving his seat. This type also carries a ballast load for increased traction.

Another form of this type which is a heavier machine with a longer wheelbase, is used for the general application of hauling material on trailers. In one style the driver's seat is over the rear axle while in another style it is centrally located. The latter form may be used particularly for hauling lumber on a trailer or dolley which is coupled to the tractor by a towing hook and chain. For this service, it may be fitted with the same bolster at-

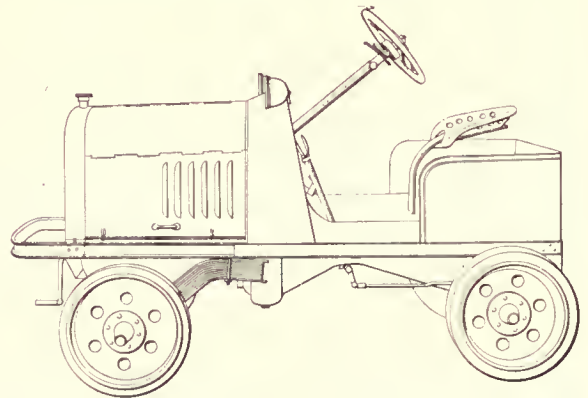

Four-Wheel Tractor

tachment and the same method of holding the load followed as is used with the three-wheel type.

The heavier machine in either style is often used to haul or push about a plant one or more trailers loaded with material the weight of which would be within the capacity of the load carrying truck but of such unwieldy nature that it must be carried on a trailer. Such material would include heavy steel bars and large parts of machinery.

Track-laying Type

This tractor is used for interplant haulage for short runs. It is particularly recommended for outdoor haulage

over rough roads and is seldom used inside of buildings. It is specially adapted for installations in lumber yards, for road construction and in several branches of municipal work. It may be used as an auxiliary to the small industrial railroads which are found in the yards of many factories.

While it is not as flexible as the storage battery type it is not comparable to it, inasmuch as it has a very different field of operation. It is recommended for a straight haul to one point of destination, and for heavy work, such as hauling several wagons or trailers heavily loaded with bulk material (sand, ashes, etc.) The wide range of uses to which it is adapted is due to its many unique features. It has a track laying type of construction and carries and lays down and picks up its own tracks. This tractor develops approximately 12 hp. to 15 hp. at the coupling and with the added feature of 600 sq. in. to 800 sq. in. of traction or ground contact, gives this type great pulling force. The speed is comparatively slow being limited to 3½ mi. to 5½ mi. per hr. Its small size enables it to pass through ordinary factory doors for picking up loads to be drawn to other buildings. It can pass through narrow

aisles and other places where a larger machine cannot travel. It may be turned around in a 12 ft. circle and can negotiate practically a right angle turn.

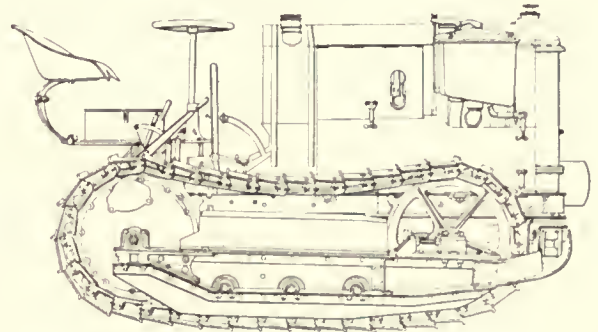

Track-Laying Tractor

The application of this type of tractor in larger sizes for much heavier and more severe service and for longer hauls is covered under the section of this cyclopedia devoted to auto trucks and tractors.

Trailers

Trailers are a development of the four-wheel platform hand trucks, but are built stronger and with greater capacities than the hand trucks. There are many different forms of construction; wheels of various sizes and types are used. The platforms are of hard wood often fully protected with sheet metal, depending upon the type of trailer and the class of service. The trailers are equipped with special couplers as an aid in trailing and to reduce the outward or inward creep when turning corners. Trailers may be used as hand trucks under certain conditions.

It will be found in many places that aside from the saving shown in labor, time and money, by the use of trailers in trailer trains with a tractor, the handling of the material can be reduced to a minimum. This is made possible by providing a sufficient number of trailers so that material may be kept on them until it is required elsewhere.

The accompanying table shows the four most used types, and the adaptability of each type to the various kinds of work. The importance of using the proper trailer for the

A more detailed description of the various types of trailers follows:

Four-Wheel Steer Type

This type serves best where accurate trailing is a prime requisite. It is particularly efficient in industrial plants where the aisles are narrow because of its accurate trailing in long trains, and when making extremely sharp turns. It is also well adapted to warehouse and freight depot haulage.

When furnished with a reversible coupler, time is saved because the tractor can be coupled to either end. This is often a decided advantage.

Capacity—6,000 lb.

Caster Type

This type is recommended for use at docks, wharves, and freight terminals and in industrial plants. It gives good service where accurate trailing is not the primary consideration. It handles in trains better than the fifth-wheel

Types of Trailers Recommended for	Various Classes of Work				
	Class of Work	1st Choice	2nd Choice	3d Choice	4th Choice
Accurate trailing	4-wheel steer	Caster	5th-wheel	Balanced	
Reversible trailers	4-wheel steer	Balanced			
Heavy power hauling. Good for rough runways. (9 tons to 12 tons on two or three trailers)	5th-wheel	4-wheel steer	Balanced		
Heavy or light power hauling. Good runways. (9 tons to 12 tons on four or more trailers)	4-wheel steer	Caster	5th-wheel		
Heavy power hauling. Rough runways and dirt floors. (9 tons to 12 tons on four or more trailers)	4-wheel steer	5th-wheel	5th-wheel	Balanced	
Light power hauling; dirt floors	Caster	5th-wheel	Balanced		
Power hauling in conjunction with considerable hand haulage	Caster trucks	Balanced trucks	5th-wheel trucks		
Hand haulage, light loads, good runways	5th-wheel trucks				
Hand haulage, heavy loads on dirt floors					

work in hand has already been brought out in the discussion of tractors. The success of a tractor-trailer system often depends on the type of trailer used.

Trailers will creep, depending on the radius of the turns, the weight of the loads and the condition of the runways. Assuming 7 ft. runways placed at right angles—four-wheel steer trailers give practically perfect trailing; caster trailers will creep from 3 in. to 4 in. each; fifth-wheel trailers creep from 7 in. to 10 in. each, and balanced trailers with cross chain connections will creep outward 7 to 10 in. each. On turns of longer radius the creep will decrease.

or balanced types. If used on rough ground the small wheels which must necessarily be used make hauling difficult; it can, therefore, only be used on smooth floors. This type is designed with platforms of many different sizes and with varied heights from the floor. Some forms have side and end stake pockets and are provided with steel pipe end racks, or hardwood end or side racks.

Capacity—5,000 lb.

Fifth-Wheel Type

The fifth-wheel trailer is recommended for hauling heavy loads over rough ground, where there is sufficient

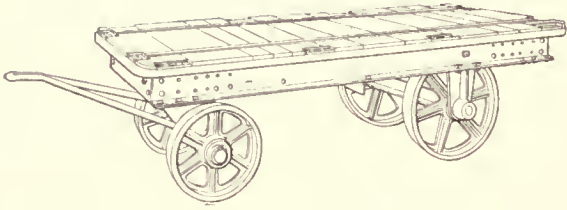

Fifth-Wheel Trailer

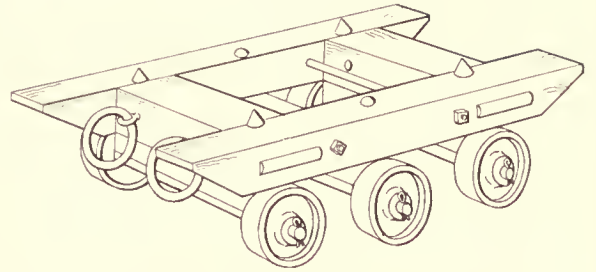

Box Trailer

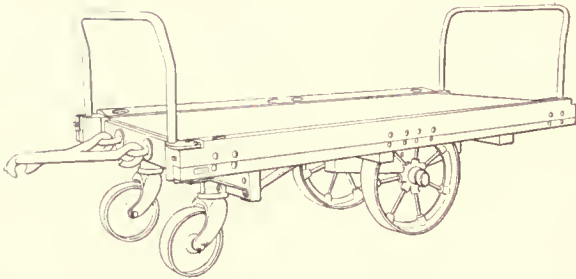

Caster Trailer

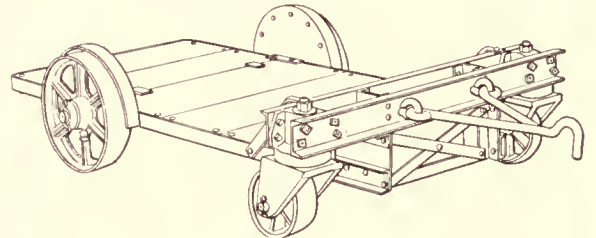

Low Platform Trailer

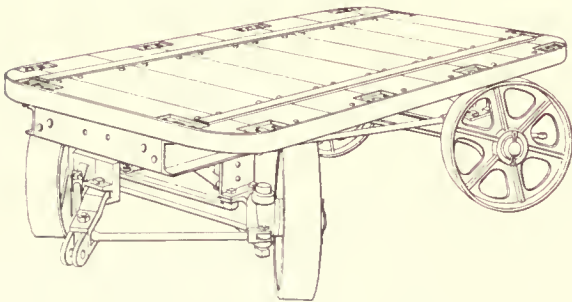

Four-Wheel Steer Trailer

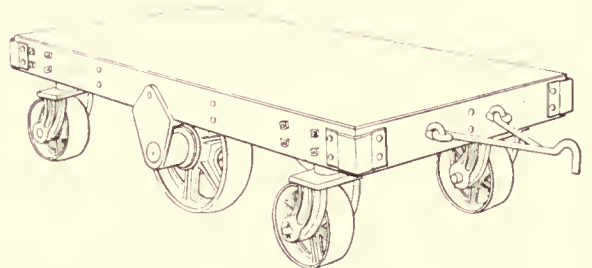

Balanced Trailer

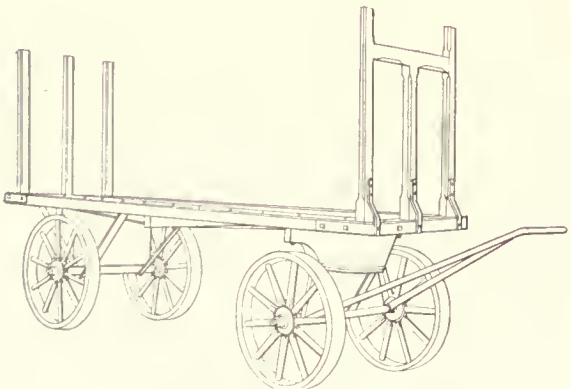

Baggage or Express Trailer

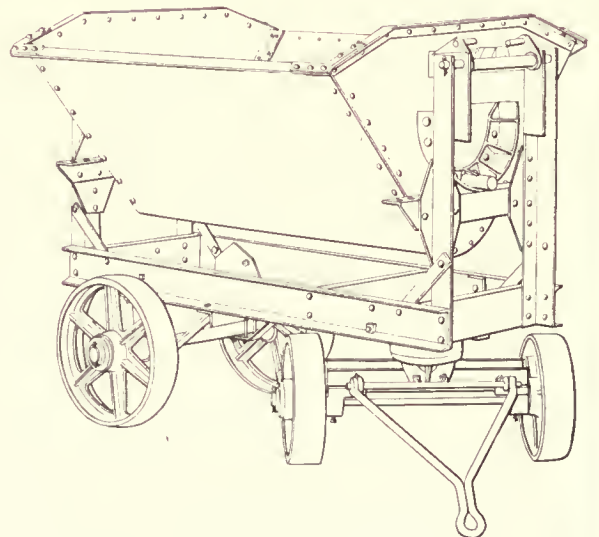

Dump Body Trailer

hand trucking to be a factor in planning the haulage system; they should be hauled in short trains.

Capacity—10,000 lb.

Balanced Type

This type is particularly adapted to general factory work where considerable hand trucking is done. As the load is balanced on the two large central wheels, a minimum amount of effort is required to swing it to its center, or to push it. It is recommended for heavy loads if smooth runways are provided; it may be used to the best advantage when handled one at a time. This type should not be hauled in long trains because of the excessive side swing; this, however, can be reduced by using cross chain connections.

Capacity—8,000 lb.

Baggage or Express Type

This type is adapted for use at freight and express stations. It is furnished with fifth-wheel steer and with a high platform from 20 inches to 35 inches from the ground; the wheels vary from 18 inches to 28 inches in diameter. Hardwood racks, which are temporarily or permanently fastened at each end, aid greatly in carrying loads that must be piled high since many of the packages are bulky rather than heavy.

Side rails slanting outward from the edge of the platform may also be furnished to prevent milk cans and similar loads from sliding off.

Low Platform Type

The frame on this type is underslung to give extremely low loading heights and is necessarily furnished with two wheels of a small diameter. This type therefore is recommended for short hauls and on smooth floors and roadways.

Capacity—5,000 lb.

The cotton trailer is a modification of this type. This trailer consists of a narrow frame, of light but strong and rigid construction, without a platform and long enough to carry three bales side by side. The four wheels are of the same size and the frame is a convenient height from

the floor—low enough when the trailer is placed near the bales to permit them being readily tipped over on it.

Dump Body Type

This type of trailer is similar in construction to the fifth-wheel or caster type but is of strong and rugged construction for heavy service. It is equipped with about a one cubic yard capacity V-dump body, for hauling bulk or loose material.

Box Type

This type is used to move heavy loads, such as boxed pianos, crated machinery, large and heavy cases, or heavy castings, and in other places where it is an advantage to be required to lift the load only high enough to place the truck under it. It has the center wheels so placed that the load may be balanced in turning; it also has steel points in the frame to prevent the load from slipping. This type acts as a roller except that the roller is in the form of wheels fastened to a frame.

A modification of the box type is the dolly, which has a heavy flat faced metal roller in the center of a rectangular metal or wooden frame.

The timber dolly has a much larger frame and is used for longer hauls. The frame of this type is built in many forms, is higher from the ground and is fitted with two large wheels.

Wheels for Trailers

Many of the above mentioned types of trailers are sometimes furnished with rubber tires or cushion tired wheels for special service. This is not recommended for general service owing to the added expense of operation caused by the rapid wear usually resulting from the condition of the roadway and floors. Rubber tired wheels for trailers that operate in places not fully protected from the weather are likely to give considerable trouble in wet or damp weather when the floors or roadways become more or less slippery. However, the rubber tired wheels may be used to advantage where material is moved over good floors and where quiet operation is essential, as in carpet mills, large wholesale houses, department stores, post offices and public buildings.

Platforms, Containers and Accessories

In connection with the movement of materials from one point to another as different manufacturing operations are performed and through inspecting, assembling, storing and packing processes, various types of boxes, barrels, platforms, racks, bins, shelving and other containers are employed. Formerly these devices were invariably of wood and usually home made affairs, but with the increasing tendency to specialization a number of important manufacturing companies now devote their whole facilities to the making of such accessories. Steel has very generally replaced wood for containers although it is still commonly used for platforms, and a large number of highly perfected designs of all these devices are now available from which a choice can be made to meet the widely different requirements which exist in various plants.

Skid Platforms

The development of the skid platform has followed naturally the perfection of the hand lift and the elevating platform and tiering types of power driven industrial trucks and has increased greatly the range of application of these

trucks. In fact the successful results obtained in many places where such trucks are used has frequently depended as much upon the proper design and application of the platforms to the local requirements as upon the selection of the trucks themselves.

By the use of a sufficient number of properly designed platforms, material is kept off the floors, aisles are kept clear, a smaller amount of floor space is required, the amount of handling and the possibility of damage are lessened, material in the process of manufacture is ready at all times to be moved instantly without waiting for laborers to load the truck and without loss of time by the truck and its operator while waiting for loading. In fact many of the items entering into manufacturing costs can be reduced by their use. Skid platforms are not only valuable in handling material while in process of manufacture and when it is to be used immediately upon delivery, but have also proven particularly economical in handling material to storage when the entire load is to be held for a considerable period. In this case the use of platforms, which are quite inexpensive, saves labor cost which is ever increasing.

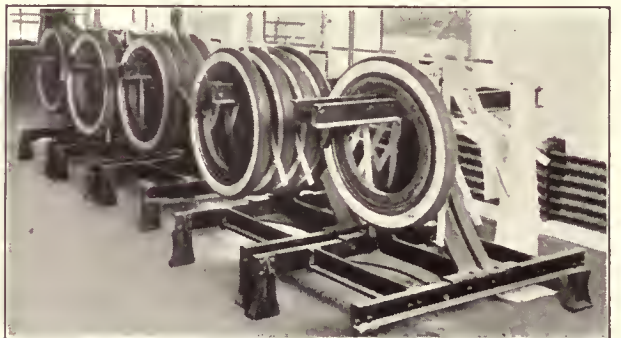
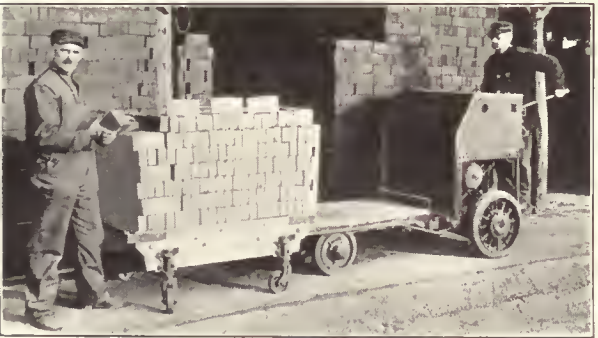
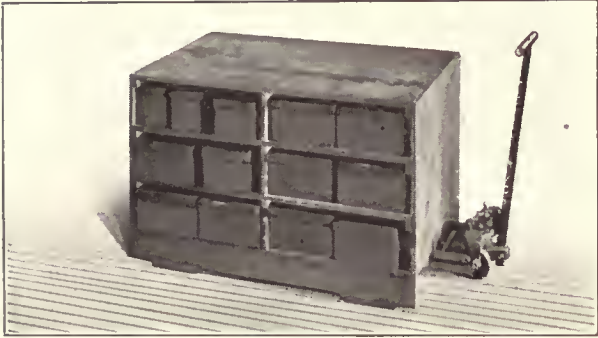
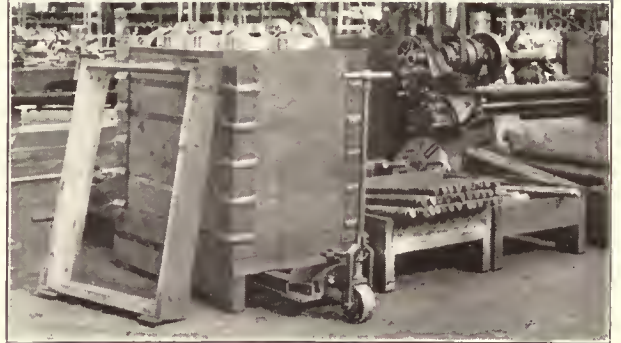
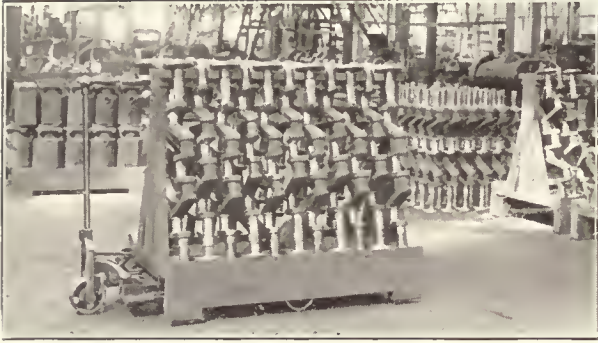

Typical Forms of Skid Platforms

In the basic forms the skids consist of a plain platform of wood or steel with four legs of a proper height to suit the style of truck. Standard lengths of legs are 6½ in., 7½ in., 9½ in., and 10½ in., which range covers practically all of the trucks in common use. The legs may be of wood but greater durability is obtained by the use of pressed steel, structural steel or cast legs. The platform is usually of wood although sheet steel is sometimes preferable, as when hot materials are to be handled. In another form the platform and legs are formed of pressed steel in one piece. For foundry use both legs and platform are often made of cast iron. Platforms are ordinarily from 24 in. to 48 in. wide and from 30 in. to 72 in. length and in some instances even longer.

Plain platforms meet all of the requirements in many places. In wood working, printing, paper box, metal manufacturing, leather and other industries they are used for handling flat pieces of wood, paper, sheet metal, flat bars and leather; in warehouses and various manufacturing industries for bags and sack goods; in wholesale houses and other places for boxes, packages and cases and also for the handling of large pieces such as machines, stoves, engines, radiators, automobile bodies and pianos.

The usefulness of platforms can be greatly extended by the addition of fixed boxes which by the use of built up sides can be made of any desired depth, or by the use of removable sides or ends can be readily unloaded; by the addition of stakes which permit objects to be piled to a considerable height without rolling off; by the use of pins or posts for holding a large number of pieces which have a hole in the center, such as gears, pulleys, hand wheels and phonograph discs; by racks of various kinds for holding rolls on arbors, cores in foundries, boxes of parts in machine shops, crank axles and automobile tires; by cradles for large rolls as well as by various other attachments to meet local conditions. In some places it has been found convenient to mount dump bodies or ladles on platforms or even portable cranes, derricks or sections of gravity conveyors so that they can be quickly moved to points where they are needed. Even fragile articles such as green tile, crockery, glassware and cases of bottles may be handled satisfactorily on the platforms if the truck bodies are equipped with spring frames.

One of the most commonly used platforms is simply a strongly constructed wooden flooring supported by two uprights or skids securely fastened to it. The uprights or skids do not always touch the floor the full length but frequently are cut back part of the way so that the platform rests on the floor at four places. The length and breadth of the platform should be of such dimensions as recommended for the particular hand or power trucks with which it is to be used. The distance between the supports and the height of the supports should be sufficient to provide plenty of clearance to permit the truck to be easily placed in position between them and under the top. A small chamfer on the inside vertical edge of the uprights is sometimes used to further assist the quick placing of the truck. The proper heights of the platforms from the floor permits them to be used interchangeably with either power or hand truck which is often a very great advantage.

Staples are often driven in the bottom of the skids or legs which strengthens them and also prevents the platforms from wearing on the bottom. In some cases four small malleable iron shoes are bolted to the lower part of the upright that rests on the floor. These shoes take the wear and greatly increase the life of the platform. The

platforms are often covered with light gage sheet steel if the material handled is of such nature as to wear rapidly or injure the tops of the platforms.

Where platforms undergo hard usage or are used in hot places or for moving material detrimental to wooden construction, there is often real economy in using steel frame platforms. This construction eliminates repair costs and therefore proves more satisfactory and economical. Usually the frame is made of angle iron thoroughly braced and riveted or bolted while the legs have broad feet to preserve the floors. In another form the angle iron may be of smaller section but using more pieces in the construction and one piece is bent to a V form for each of the feet. Either of these frames are used without tops for many applications but metal or wooden tops or one of the many special forms can readily be bolted to them. Another type which contains great strength and lightness is a plain or corrugated pressed steel platform of one piece with ends bent to form the sides or skids. The cast iron platform is another form used in many foundries as they are easily made and possess considerable strength.

A steel rack type platform which may be constructed in many different heights and with shelves is used in some foundries for drying and handling cores. The cores are placed on the metal racks direct from the moulding bench and are not handled again until they come out of the oven. This eliminates damage from rehandling and enables a maximum number of cores to be baked at one time. The rack type platform is also used in bakeries, japanning works and for handling hot forgings or long steel material in ovens as well as for dipping and quenching.

In another modification, a rack platform fitted with V forms is used for holding short round material, castings, tubes, bar stock, crank shafts and heavy spindles and which it is not desirable to pile on flat platforms. Rack type platforms are also very often used for moving tote boxes, light parts such as bicycle fenders, wheel fenders and rolls of cloth or rubber or other material in cases where it is possible to run a bar or pipe through the center of the roll.

The saddle type platform is constructed with a steel or wooden saddle fastened to the platform. This type is used for large round bar stock and for heavy pieces. The pole type is used for moving collars, pulleys, rings, tubes, gears and castings. The platform with stakes is used for holding short lengths of lumber and strip material which must be supported at the sides. Supports can easily be fastened to the platform to handle such loads. The table type is in common use for assembling machines when parts from stock are placed on the lower shelves after which the table is moved to the assembly room, to the testing floor, and on to painting and shipping room.

In the sectional type platform the height of the box is adjustable and can be readily changed using whatever number of sections are necessary. This type is often used for various quantities of small machine parts. Often the sections are provided with hinges in the four corners so that the boxes are collapsible. This feature is very convenient where there is occasion to transport empty boxes for they can be folded and a large number piled on a platform. In some industries like soap manufacturing a circulation of air is desirable through the material. In such cases the box sections are usually made of slats or crating. The pipe frame sectional platform is often used with a bin or box shaped container held between the four uprights. The ends of the pipe uprights have a ball and socket type construction so that one platform can be assembled on another,

the ball in the bottom of the uprights of one platform resting in the socket in the top of the uprights of the other.

Live Platforms

If wheels are put under any of the numerous forms of skid platforms they then become live platforms in the sense that they can be moved, pushed or pulled, either empty or loaded, without being lifted, by a hand or a power truck. The added flexibility obtained by the addition of wheels is

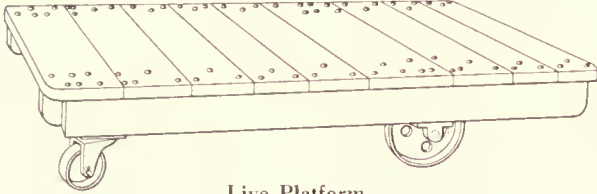

Live Platform

often of material value. Live platforms can be pushed by hand from one machine to another and can be turned so as to be in just the right position for a hand lift or elevating platform power truck to pick them up and transfer them to another department or some distant point.

For greater ease in turning live platforms should be equipped with caster wheels in front and with larger rigid wheels in the rear. Live platforms are not suitable for trailers and should not be hauled by tractors.

Shop Boxes

Shop boxes, commonly called tote-boxes, are extensively used in machine shops, forge shops, foundries, press rooms and many other metal working and industrial plants for handling small parts in the course of manufacture from one operation to another. These containers were formerly made of wood, usually reinforced by steel strips, but are now almost universally made of sheet steel. They are obtainable in many shapes and sizes, two of the most commonly used types being shown in the accompanying illustration.

Taper side boxes have an advantage in that when empty a number of them can be nested together and returned to be filled again. The most commonly used sizes are from 16 in. to 22 in. long and from 10 in. to 12 in. wide at the top and about 6 in. deep.

Straight side boxes are frequently provided with corner

filling pieces, stacking rails or other devices which makes it possible to stack such loaded boxes six to ten high for transportation on skid platforms or on industrial trucks. Such boxes are usually from 16 in. to 24 in. long, 10 in. to 12 in. wide and from 5 in. to 6 in. deep.

Shop boxes should be reinforced around the top by the metal being folded back, or by a strip of angle or band iron. Handles are frequently made of sheet metal folded to a shape convenient to the hand and electric welded to the ends of the box. A $\frac{3}{4}$ in. or 1 in. hole is usually provided in the center of the handle so that the box may be pulled around on the floor by means of a hook. Special boxes may be provided with round forged rigid handles, with draw pull or with drop handles. For severe service shop boxes are frequently provided with reinforcements on the bottom which serve as runners.

Shop boxes may be provided with ladle holders on the end, with holders for an inventory card on the inside, or

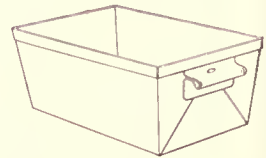
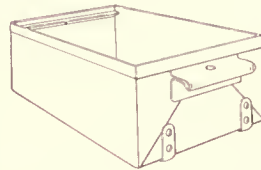

Shop Boxes

with pockets for holding slugs or shot so that the weight can be adjusted to an exact amount for greater ease in weighing the contents or obtaining the number of pieces from the weight.

Small steel shelf and bench boxes, for keeping together small parts, are almost indispensable on the assembler's bench and in many other places in the factory. These boxes are often constructed with fixed or removable partitions, or with compartments that are adjustable. A lining of wood, fiber or straw-board is sometimes advisable for protection to delicate instruments.

Many other forms of boxes, pans, and trays are also extensively used in the handling of different materials in manufacturing plants.

Steel racks for holding shop boxes and parts together with shelving and bins also are employed extensively in store rooms, tool rooms and shops.

Typical Methods of Moving Material

Material must be mobile at all times to save floor space, increase productive capacity and keep a brief check on the commodity in transit through the factory or in a warehouse.

It is possible to install a system employing power trucks, or tractors and trailers, whereby the material in course of manufacture in an industrial plant, or in the course of transit at marine or railroad terminals, is kept on wheels or platforms and is ready to be moved quickly and with a minimum amount of handling.

Several systems for the movement of material, making use of the elevating platform power truck with skid platforms and the tractor with its trailing load, are described on the following pages:

Movement of Material with Storage Battery Trucks

Following is a brief description of the operation of the industrial truck and the method of moving material by it.

It is assumed that the weight and class of commodity and factory layout are as follows:

The material to be moved is finished paper products. It is of one class, packed in pasteboard containers of uniform size. A container in which this material has been packed weighs approximately 50 lb. The floors of the packing room, stock room and the platform adjacent to the railroad are all on the same level. The platform outside the building is adjacent to three railroad cars. The movement of material is from the packing room to the stock room for storage, or to the railroad car for shipment.

It must first be decided which type of industrial truck is best adapted for this particular service. The quantity of material to be moved would not keep gangs of men busy, loading or unloading. The system of keeping the stock on trailers would tie up expensive equipment. For these reasons, the tractor-trailer system is not recommended.

The use of the load carrying straight platform type

truck would require the load to be lifted to the platform of the truck, then lifted again when unloaded in the stock department. If it is required to be moved from this position to the railroad car it is again lifted to the platform of the truck and then unloaded in the freight car. This extra handling entails expense and labor which may be saved if a different method is adopted.

The weight of the loads is such as to permit them to be moved readily by an elevating hand truck but the length of haul, approximately 75 ft., is beyond the economical limit for operating this type of truck. Therefore the elevating platform power truck and a number of skid platforms are recommended.

The material that enters the factory in unfinished condition passes through the various processes of manufacture and then, in a pasteboard container, passes over a gravity conveyor, from the finishing floors above to a table. Here it is finally sealed and weighed and made ready for stock or shipment.

Several wooden skid platforms are provided on which the containers, after being weighed and sealed, may be

elevating platform truck and skid platforms, is outlined in the diagram.

The Trailing Load

The tractor-trailer train works to the best advantage where two or three "trailer fleets," consisting of one or more trailers, are used. While the tractor is moving one fleet, a second fleet is being loaded and a third is being unloaded. In this way the loaded or empty trailers are always ready for transfer and very little time is lost other than that required for unhooking or hooking the load and making up a train.

Three places where the tractor-trailer system has proven especially well adapted are marine terminals, railroad terminals and large industrial plants. The substitution of this type of mechanical for a manual means for handling material at such places has accomplished two highly desirable results. First, it has eliminated congestion, and second, it has saved time for the truckman who often had to wait in line for hours at a time at an unloading point of a railroad or transfer terminal. The workman in an

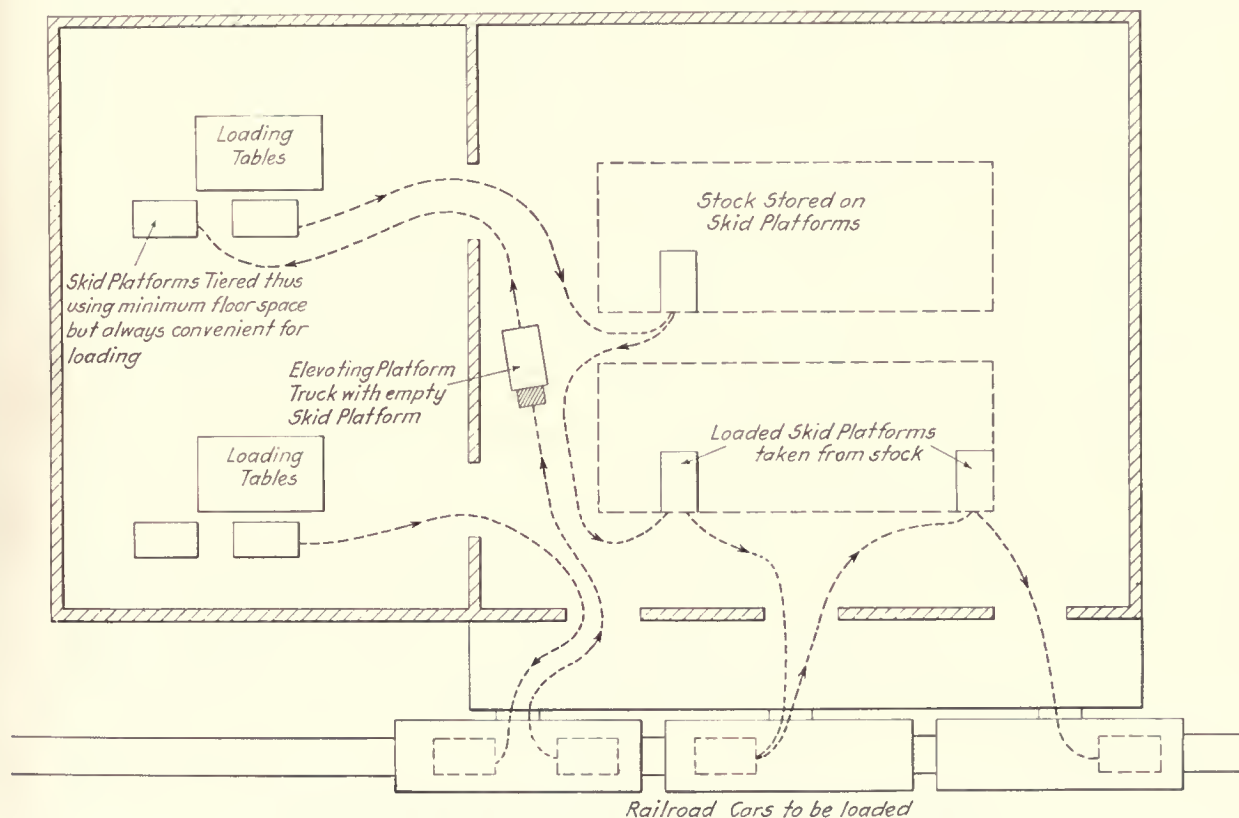

Typical Elevating Platform Truck Operation in an Industrial Plant

piled. Each platform is loaded with an average of about 48 of these boxes—an average load of 2,000 lb. When the skid platform is thus loaded the power truck lifts the load and platform and carries it to the stock room or directly to the railroad car. If it is placed in the stock room the material is ready to be moved again without rehandling. If it is moved directly to the car the skid platform may be placed at a convenient point in the car so as to be readily unloaded by the workmen. The empty platforms are returned by the power truck to the same loading platform or to a similar table in the packing room, where they are left to be loaded and the truck is again available for moving the loaded platforms. The movement of the material, using an

industrial plant was seriously handicapped in his work by the delay in the delivery of material to his machine, because of the slow and inefficient method of handling by the old trucking system.

It is the manner in which tractors and trailers are used, rather than the equipment itself, that has much to do with the great savings which have been secured. For instance, at a terminal where a successful tractor-trailer installation has been made, two requirements are necessary. In the first place the shape and height of the unloading platform and the yards where the trailing trains are formed have much to do with the successful operation. In the second place, the manner in which the trailers are disposed of is

highly important—that is, the method of making up trailing trains and despatching them, and the proper “spotting” so that there are always some trailers in such a position that they can be loaded or unloaded with a minimum of labor.

Railroad Marine Terminal

At a marine terminal the layout and operation would be about as follows:

The floor is raised on the street side, and at the front of the building, forming a platform the same height as the platform on the large trucks and wagons on the street. The trailers are backed up to the other side of the plat-

made up into trains of from three to six or more trailers. After a full train has been made up, the electric tractor draws it out through one of the four gates in the partition dividing the waterside of the head-house from the inside end of the slip and up a ramp onto the platform on the car-float between the two lines of six cars each.

As the tractor runs down the car-float platform it drops off the trailers as it passes the doors of the cars into which the goods they carry are to be loaded. Each trailer is pushed inside of the freight car by stowers who unload it and pack the freight into the car. The empty trailer is then pushed back on the platform and later is picked up by the tractor on a return trip and is carried back to its

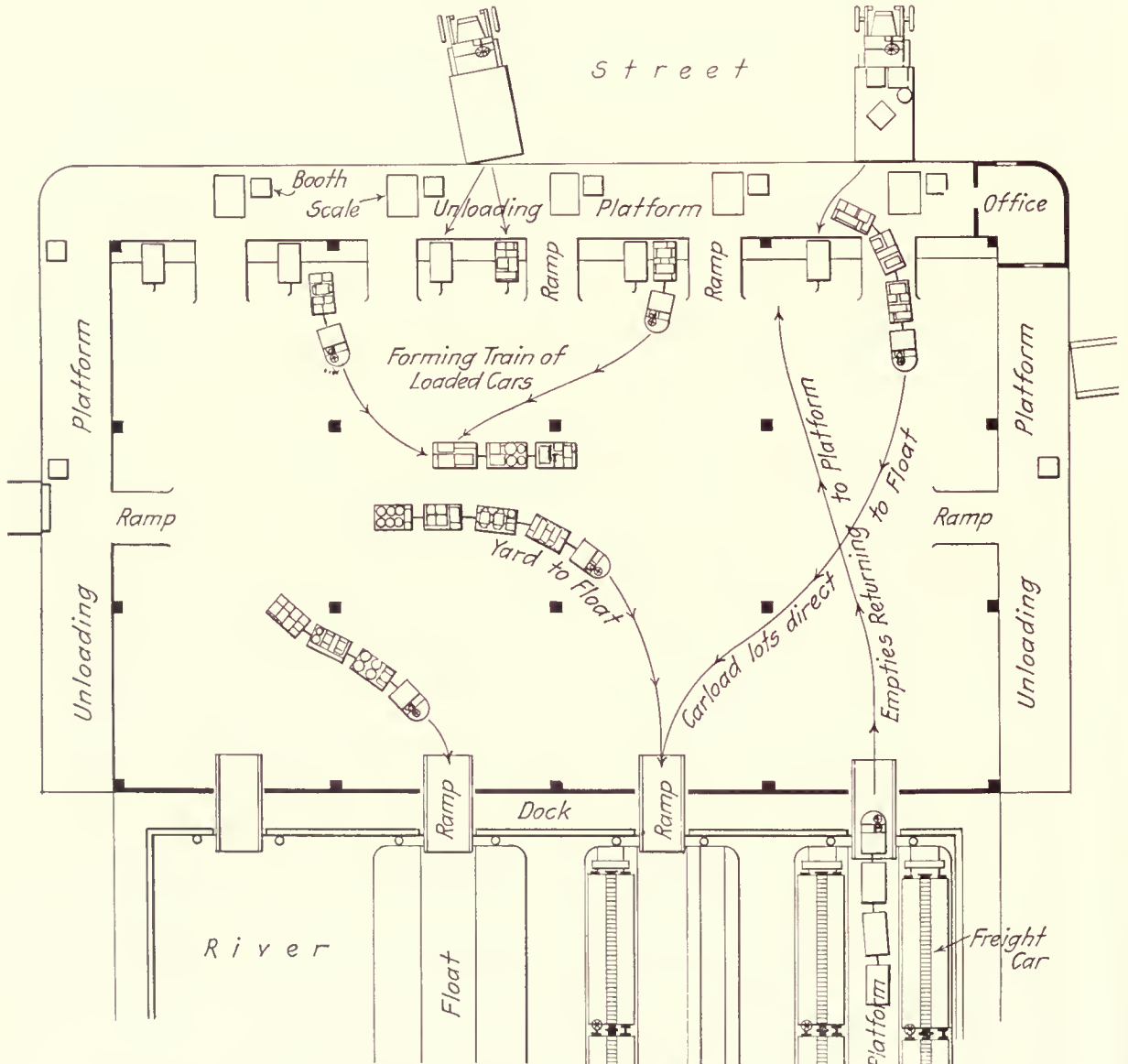

Typical Tractor Operation in a Railroad Marine Terminal

form and each trailer is marked with a car destination or number; this arrangement makes unloading easier and faster. The freight is taken from the wagons or large trucks, is weighed on the platform and is then placed on a trailer marked for the proper freight car.

After the trailers have been fully loaded, they are drawn from the edge of the platform by a tractor acting as a “spotter” and down into the flat yard where they are later

first position against the unloading platform under its proper number.

If the freight is in full wagon lots going directly to the cars for carload shipments, the goods are unloaded directly from the wagon or motor truck onto trailers which have been pulled up the ramps onto the platform, where they may be loaded at one operation. After they have been loaded, they are taken over the automatic floor scales and

weighed, after which they are handled in the same manner as the l. c. l. shipments.

Railroad Terminal

The layout and operation of a tractor-trailer system at a railroad terminal would be somewhat as follows:

The two large platforms are joined at the center and

The average tractor train consists of eight trailers with an average load of four tons. The number of trailers per train, however, is increased somewhat for a straight run or in a train consisting of light trailers only. Each train is operated by a motorman and a man who couples or uncouples. Two men load the trailer in the car and it is then pushed from the car to the platform, and each package

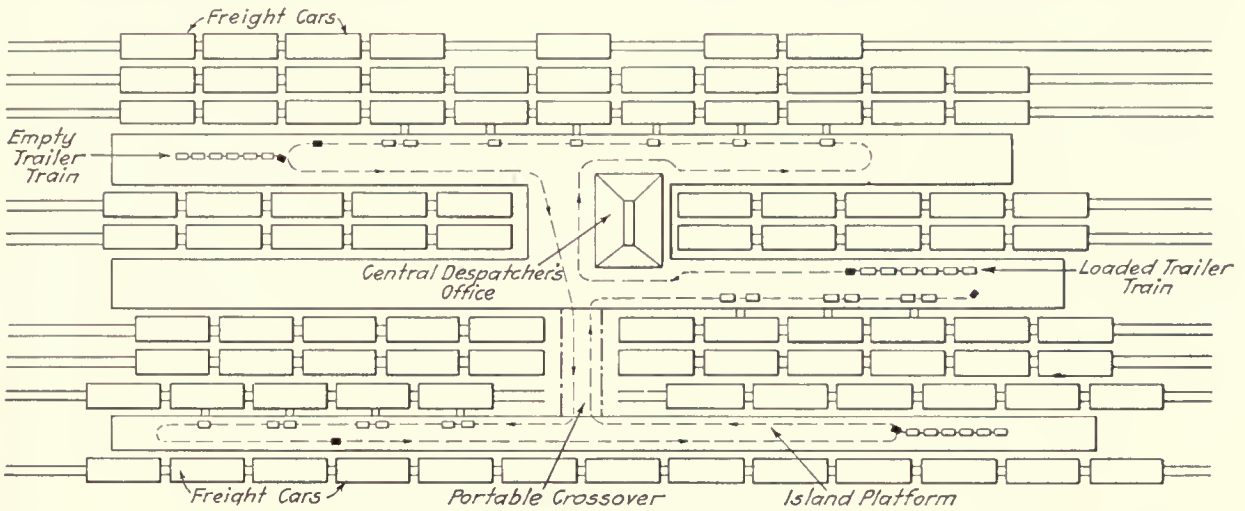

Typical Tractor Operation in a Railroad Transfer Terminal

the dispatcher's office is located at this point. Between these platforms are double railroad tracks and at the outside several tracks, and possibly an island platform, the latter connected to the larger center platform with a portable crossover. The loaded or empty railroad cars are all spotted with the doors in line so far as possible, thus making it possible for the tractor or trailers to pass from one car to another.

is marked or inspected by a checker; or the loaded trailer is pushed into the cars and unloaded, then pushed to the platform to be picked up by the tractor on one of its return trips. Each section of the platform, or island platform, is connected by telephone at convenient points with the central dispatcher's office. If a loaded trailer train is ready, or if there is a congestion of empty trailers, the dispatcher in that particular section telephones a central dispatcher for a tractor. The tractor with its motorman and man who couples or hooks on is immediately sent to that section and they make up either a train of loaded trailers or a train of empty trailers, and go at once to that part of the platform designated by the central dispatcher.

In the case of a loaded trailer train one or more of the loaded trailers are detached at the proper car door when passing.

Industrial Plant

At a large industrial plant, or in a large packing house or stockyard, where material can be regularly scheduled, the tractor-trailer system may be used to advantage. Wherever such an installation is used in an industrial plant the factory is divided into sections with a dispatcher's office in each section. The dispatcher orders enough trailers accumulated at the proper time, and a tractor to do the hauling. As a result of such foresighted scheduling, the

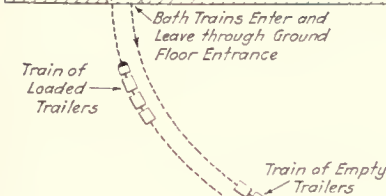
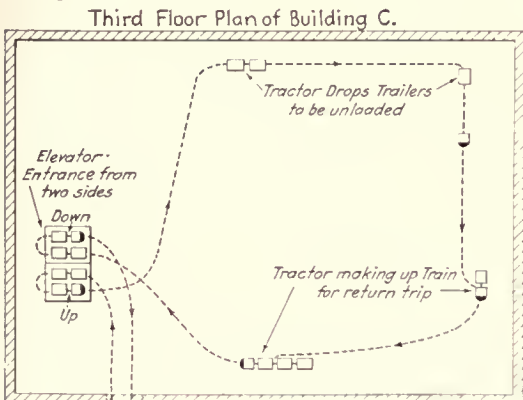

Typical Tractor Operation in an Industrial Plant

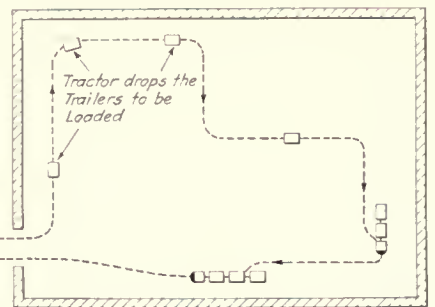

Ground Floor Plan of Building A.

material does not get side-tracked, or shipped to the wrong department, and empty trailers are always on hand to be loaded. The dispatcher thinks and plans ahead. The movement of material is anticipated as much as possible and all arrangements are made, such as empties on hand for loading properly, notifying the department to which the shipment is consigned, and laying out the proper routing for the material to be moved.

One tractor runs between two or more buildings, with probably three or four trailers, pulling the loaded trailers onto an elevator and riding with the trailers up to one of the floors above, stopping at the proper floor and going with the trailing load to the proper department. If the material on the trailer is so routed one trailer may be left in each of several departments.

The tractor then starts on the return trip and picks up the empty trailers waiting in some other department on the same floor, or on the floors above or below. The tractor with its train returns on the elevator to the ground floor, crosses the yard to the building where the loading has been done, leaves the empty trailers at the proper locations, picks up a train of loaded trailers for another trip.

Quite often one tractor runs between two buildings, simply leaving a train of loaded or empty trailers conveniently inside the building. Another tractor inside the building does the spotting and places the trailers in the required locations.

The operation of the tractor-trailer system in a large packing house or stockyard is almost continuous. A dispatcher is not required, there is practically no waiting time, and the operator and his motorman very soon become familiar with the correct routing and the trailing load is taken quickly to its destination. Some of the trailers are dropped at one place and some at another, or a complete train of trailers, unchanged, is taken to its destination. The returning tractor with a trailing load of empty trailers goes directly to the loading platform where a train of loaded trailers is always ready for another trip.

Generally the quantity of material to be moved is such that the operator and his motorman must make the trip on schedule time, and to the proper loading or unloading platform, at the proper time; otherwise time will be lost waiting for the loaded trailers to be moved and replaced by empty trailers impairing the efficiency of the system.

Factors Determining the Choice of Tractors

When a tractor trailer installation is contemplated great care should be taken that a tractor is selected which is capable of developing sufficient tractive effort satisfactorily to haul the trailing load and travel at the required speed. This is largely a matter of battery capacity and the selection of the proper size motor or engine.

The term tractive effort is used to designate the force in pounds which is exerted at the tires of the tractor. The term drawbar pull is employed to signify the effort in pounds at the coupling between the tractor and trailers.

A tractor performs in accordance with known physical laws, mechanical and electrical. When certain elements

size and capacity of the battery and the size of motor or gasoline engine.

Storage Battery Tractor

How to calculate the performance and determine the proper size of tractor can be shown best by assuming a typical problem and following each step through to a conclusion.

The material, as may be seen in the accompanying diagram, is received in carload lots at a car platform and must be moved to the scale (a distance of 350 ft.) to be weighed, and then to the warehouse (a distance of 400 ft.) for stor-

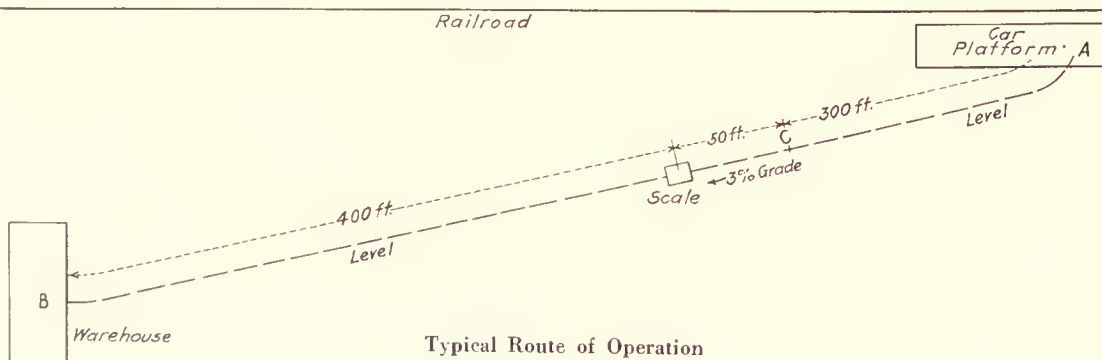

of a material movement problem are known, the work which may be expected of a tractor can be calculated to a certainty. These elements are:

- (a) Weight of the train to be hauled.
- (b) Character of the surfaces over which the train must move.
- (c) Grades which will be encountered.
- (d) Speed at which the train must travel in order to move a given amount of material in a given time.

The weight of the train to be hauled and the character of the surface determine the tractive effort necessary. The grades which must be overcome determine the maximum demand on the tractor. The speed necessary to move a given quantity of material in a given time determines the

age. A grade of 3 per cent 50 ft. long is encountered between the car platform and the scale.

The material is received in such shape that 3,600 lb. can be placed on one trailer. The trailer to use for this movement would be the standard caster type warehouse trailer, having a platform 3 ft. wide by 6 ft. long. Four of these trailers may be handled conveniently in a single train so a train of four loaded trailers is assumed. These trailers will weigh about 400 lb. each and will have a pay load of 3,600 lb. each. The weight of the train would be:

Four trailers, dead load 400 lb. each.....	1,600
Four trailers, pay load 3,600 lb. each	14,400
Total weight of train.....	16,000

The unloading platform, scale and storehouse are all connected by good, smooth, concrete, runways.

All the elements of the problem have been stated and it is now possible to find the size and speed of the tractor and the quantity of material that can be moved over the given route in a given time—say an eight-hour day.

The first point to settle is the tractive effort necessary to move the train, or, in other words, the pull or push the tractor must exert to overcome the tractive resistance between the wheels and the surface of the runway in order to move the train.

the ratio of the distance the tractor is raised to the distance traveled; in other words, the ratio of the ordinate of a right-angled triangle to the hypotenuse. The tractive effort of 20 lb. per ton of load is required for each percent of plus grade. The load must include not only the weight of train, but the weight of the tractor as well; thus a plus 1 per cent grade will require 20 lb. tractive effort per ton, while a minus 1 per cent grade is equivalent to delivering a tractive effort of 20 lb. to the tractor.

TRACTIVE RESISTANCE OF VARIOUS SURFACES.

Type of Road Surface	Resistance (Lb. per Ton)
Brick, smooth.....	30 to 50
Concrete	28 to 40
Poor concrete	45 to 65
Granite blocks.....	50 to 60
Wood blocks.....	30 to 50
Gravel road, good condition.....	75 to 85
Clay	200 to 400
Wood planking	35 to 50
Wood planking, sticky surface.....	50 to 60

	Pounds
Tractive effort, on level, tractor only, 40 x 1.....	40
Tractive effort, on level, trailer load, 40 x 8.....	320
Tractive effort to pull tractor up 3 per cent plus grade, 3 x 20 x 1.....	60
Tractive effort to pull trailer load up a 3 per cent plus grade, 3 x 20 x 8.....	480
Total tractive effort on 3 per cent plus grade.....	900
Drawbar pull on 3 per cent plus grade.....	800

From the foregoing it is evident that the tractive effort required on a level is 360 lb., and in addition it requires 540 lb. for grade work, making the total required tractive effort 900 lb.

Manufacturers of industrial tractors will furnish characteristic performance curves of their machines upon request. The curves here given are typical of a good stand-

From the table of tractive resistance it may be seen that the resistance offered by a concrete road to a load being

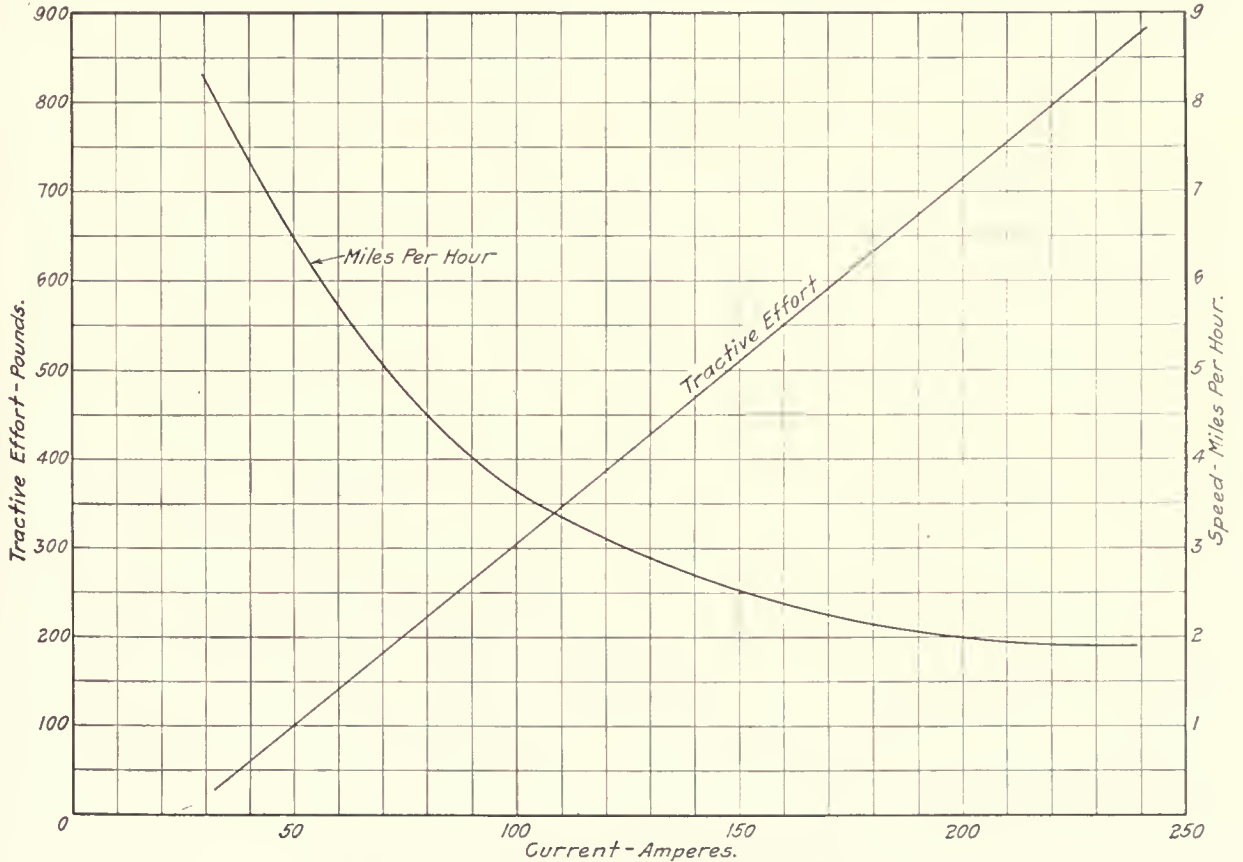

Characteristic Storage Battery Tractor Performance Curve

moved over it on wheels is 40 lb. to the ton. Therefore the tractive effort necessary to move the tractor and train, assuming that the tractor will weigh 2,000 lb., would be 1 multiplied by 40 (tractor) plus 8 multiplied by 40 (trailers and load), or a total of 360 lb. The tractor and empty trailers would require 72 lb. tractive effort.

In order to determine the maximum demand on the tractor the 3 per cent grade which must be overcome between the car platform and the scale must be taken into consideration. Grades are expressed in percentages, being

ard electric tractor. The tractor best suited for the work intended is found by consulting the characteristic performance curves. From the same curves the speed and current consumption may be determined. To use the curve, first determine the tractive effort required, and plot it on the "tractive effort" line. A perpendicular from this point to the base will indicate the current consumption. The speed per hour may be read on the scale to the right opposite to the point of intersection of the perpendicular and "miles per hour" line.

The actual horse power required at the motor terminals on a tractor can be expressed as follows:

$$\frac{T \times F \times S}{33,000 \times E \times E'}$$

where: T = Tons total weight (includes power machine, live load and trailers, if used).

F = Tractive resistance.

S = Speed in ft. per min.

E = Mechanical efficiency from motor pinion to wheel treads.

E' = Efficiency of motor (0.75 to 0.88 at full load).

The range of value F, which varies greatly, depending on the size of wheels, condition of the tires, type of tractor and trailer bearings, construction of trailers, maintenance of lubrication, may be secured from the table showing tractive resistance of various surfaces. The horse-power requirements will, of course, vary from day to day on the same tractor, operating on the same surface.

Value E depends on the design of the power machine and the lubrication. On a single reduction worm gear drive designed for fairly high speed it may reach 0.9 when the vehicle is in the best condition, but 0.7 to 0.8 is undoubtedly nearer the average and still lower values will often apply. If grades are encountered the product of T x F must be increased by 20 lb. per ton for each per cent of grade to determine the horse power required when on the grade.

Time and Energy Required Per Trip

From the tables and the diagram of characteristic performance it is evident that with the tractive effort as already determined, the tractor will require the following energy and will run at the speeds indicated in the accompanying tabulation:

Operation	Lb. Tractive Effort	Amp.	M.P.H. Speed
(a) Car to C (on level).....	360	114	3.1
(b) From C to scale (on grade).....	900	246	1.9
(c) Scale to B (on level).....	360	114	3.1
(d) From B to car.....	72	44	6.8

From the following diagram the speed in miles per hour can be reduced to feet per minute or feet per second, which is often desired in calculating the time required for a trip.

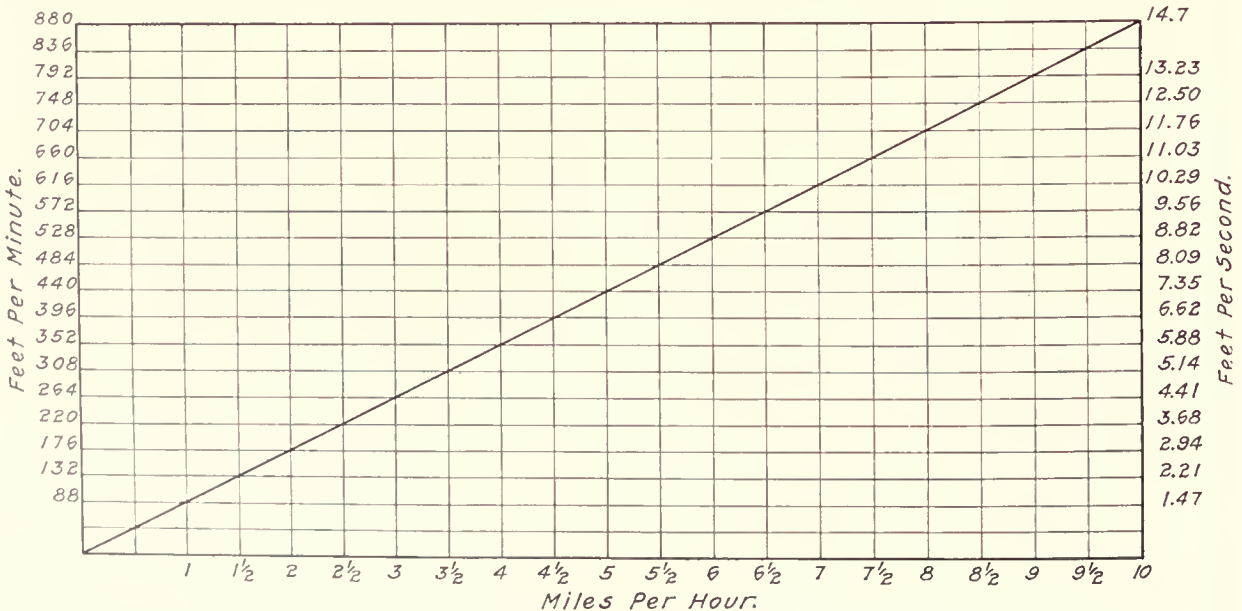

Curve of Equivalent Speeds

In calculating the time per trip it may be assumed that the acceleration will require five seconds per start.

Operation	Minutes
(a) Car to C, 300 ft. at 273 ft. per min.....	1.1
(b) On grade, 50 ft. at 168 ft. per min.....	.3
(c) Scale to B, 400 ft. at 273 ft. per min.....	1.46
(d) From B to car, 750 ft. at 600 ft. per min.....	1.25
(e) Acceleration, 5 sec. per start—3 starts.....	.25
(f) Four hitches.....	3.00

Time per round trip..... 7.36

During acceleration the extra energy required may be assumed to be 0.2 ampere minutes per ton per start.

In this particular problem there are three starts—one at the car, one at the scale and one at the warehouse,

$$3 \times 0.2 \times 8 = 4.8 \text{ (amp. min.)}$$

Hauling Capacity of Tractor

Assuming an eight-hour day, or 480 min., and 7.36 min. per round trip, the tractor could actually make 65 round trips, if operated continuously. From actual experience it is found that unforeseen delays will reduce this at least 25 per cent. The probable number of round trips per day may be taken as 46. Forty-six trips at 7.2 tons per trip is equivalent to a capacity of 330 tons per day.

Current Required

Ampere-hours required per day for 46 round trips:

	Amp. Min.
(a) Car to C, 1.1 min. at 114 amp.....	125
(b) On grade, 0.3 min. at 246 amp.....	74
(c) Scale to B, 1.46 min. at 114 amp.....	166
(d) From B to car, 1.25 min. at 44 amp.....	55
(e) Acceleration	4.8

Total ampere minutes for round trip..... 425

425 divided by 60 equals 7.1 amp. hr. per round trip. For 46 trips: 7.1 x 46 equals 325 amp. hr. per day (approximately).

In the preceding calculations no account has been taken of the effect of the descending grade on the return trip, but the decrease in tractive effort and speed and the increase in current due to hauling the load up the ascending grade have been considered.

Battery Equipment

The figures used for alkaline batteries and for one type of lead battery are given for illustrative purposes only.

The ampere-hours required is approximately 325 and tables in handbooks indicate that an Edison A-8 cell bat-

tery has a capacity of 300 amp. hr. and that the nearest lead-cell battery is one with 21 plates having a capacity of 315 amp. hr.

Assuming continuous operation, the actual running time of the tractor, or the time consuming energy, is 4.36 minutes

$$4.36 \times 46$$

per trip. $\frac{\quad}{60} =$ approximately 3.35 hours per day.

$$60$$

This is well within the limits of these batteries.

Energy Required and Cost for Charging Alkaline Batteries

From an instruction book for this type of battery, the following data may be obtained. An alkaline A-8 battery has a capacity of 300 amp. hr. It has a 5-hour discharge rate of 60 amp. with a voltage varying from 1.24 to 0.9 per cell, depending upon the amount of current furnished.

The normal charging rate is 60 amp. for seven hours with a charging voltage of 1.58 to 1.82 per cell, or an average of about 1.68.

The amount of energy required, or the kilowatt-hour input to the battery, will be the number of cells to be charged, times the charging voltage, times the ampere rate, times the charging time, divided by 1,000. Assuming a battery of 30 cells, an efficiency of 80 per cent for the charging source and a cost of 3 cents per kw. hr. for power, the cost of one complete charge will be

$$\frac{30 \times 1.68 \times 60 \times 7 \times .03}{1000 \times .80} = \$0.80$$

Energy Required and Cost for Charging Lead Batteries

The method of calculation to determine the energy required and the cost of charging lead batteries is somewhat different from that used for the alkaline type battery. The lead battery will give an ampere per hour efficiency of 85 per cent, which includes the current required for the equalizing charges, and it will give a voltage efficiency of 85 per cent.

The normal capacity of the battery is 315 amp. hr. This divided by .85, the amp. hr. efficiency, gives 384 amp. hr. on charge.

The average voltage on normal discharge is 1.96 volts per cell. This, times the number of cells, assuming a battery of 18 cells, divided by the voltage efficiency, gives the voltage required of charge as

$$\frac{18 \times 1.96}{85} = 41.5$$

The voltage required for charging, times the ampere-hours required for charge, divided by 1,000 will give kilowatt-hours input to the battery. Assuming an efficiency of 80 per cent for the charging source and a cost of 3 cents per kw. hr. for power, the cost of one complete charge may be computed in the same manner as that used for the alkaline battery.

It is assumed for both type of batteries that they have been practically discharged and a complete charge is necessary. It is also assumed that the constant current system of charging is used.

Gasoline Engine Tractor

In determining the size of a gasoline engine tractor, first determine the maximum grade to be negotiated and the trailing load necessary to move the product in the required

time. Multiply the grade per cent by 20 and add the factor for the type of road as shown in the table of tractive resistance of various roadways. Multiply the sum thus obtained by the total weight of the tractor, the trailers and the live load. Multiply this result by the feet per minute it is desired to move the load and divide by 33,000, which will give the horse power delivered to the tires. The same result may be obtained by multiplying by miles per hour instead of feet per minute and dividing by 375.

The horse power required at the tires to move one ton up various grades at various speeds over various types of roads may be readily obtained from the preceding tabulations. Knowing the amount of the load to be moved, the grade, the type of road, and the required horse power to move one ton, the total horse power may readily be determined.

The engine horse power required may be found by dividing the result thus obtained by the driving efficiency which may vary from 60 per cent to 70 per cent on other than direct drive, or perhaps 75 per cent to 85 per cent on direct drive.

In arriving at the horse power in this manner we must not lose sight of the fact that this horse power must be delivered by the engine at the speed fixed by the tractor wheel diameter and effective gear ratio; that is, the gear box ratio multiplied by the gear axle ratio. The revolutions per minute of wheels at different rates of tractor speeds is determined by the following equation:

$$R = \frac{336 \times S}{D}$$

in which R = rev. per min. of wheels, S = tractor speed in miles per hour, D = wheel diameter in inches. For convenience a table giving the revolutions per minute for wheels of various diameters for different tractor speeds given in miles per hour and feet per minute, is shown. Any of these values of revolutions per minute multiplied by the total gear ratio gives the required speed of the engine for the tractor speed selected.

REVOLUTIONS PER MINUTE OF TRACTOR WHEELS						
Miles per Hour	Feet per Minute	Wheel Diameter in Inches				
		10	16	20	24	28
4	352	134	84	67	56	48
5	440	168	105	84	70	60
6	528	202	126	101	84	72
7	616	235	147	118	98	84
8	704	269	168	135	112	96
9	792	303	189	152	126	109
10	880	336	216	168	140	120

The calculations may show that the engine required is larger than any size available, in which case it is necessary to use two tractors rather than one.

The controlling features of design, however, determine also to a very large extent the size of the engine used, generally a much larger size engine is furnished than the calculations indicate in order to compensate for starting conditions.

It is advisable also to consider not only the power requirements in negotiating the grades, but also the ability of the tractor in drawing its trailers over the level portions of the route to be traversed. For example, it is assumed that a level portion of a route is 400 ft. in length and a 50-ft. grade of 10 per cent must be negotiated. Assuming that there are three or four different tractors, each having different characteristics regarding the size and speed of the engine, but each having sufficient power to climb the grade, then that one of the tractors which shows

the best average speed from end to end of the route, including the grade, would have marked economic advantages over the slower ones.

Cost of Operation of Tractors

It has been shown how to calculate the size of tractor required, the amount of material that can be moved, and the cost of charging the batteries. In order to find the cost per ton for moving the material the total cost of operating the system must be found and the result divided by the tons of material moved.

It is not practicable, because of the many variables, to estimate the cost of operation which would be applicable to many installations with widely differing conditions. For instance, in a manufacturing plant the average weight of the trailing load would greatly exceed that of an installation at a marine or railroad terminal where the trailing load might consist of material from less than carload lots and consequently, although bulky, not as heavy a load is carried on an equal number of trailers as would be expected in an industrial plant. Thus the length of haul and weight and size of commodity would affect to a large extent the total tonnage handled per day and therefore the cost per ton handled.

The cost of operation should include what might be termed fixed charges and operating charges on the tractor, trailers and also the charging equipment, if the latter is required.

For a specific installation for which it is desired to estimate the operating cost, and where data are available from actual records which would leave no doubt as to the amount for each item, the total of the following items will give the cost of operation covering a period of one year of approximately 300 working days. This total, divided by the total tonnage hauled during that time will give the cost per ton.

The following method of determining the cost of operation applies specifically to a storage battery or gasoline engine tractor with trailers, but it is also applicable to a power truck:

COST OF OPERATING TRACTOR

Operating Charges	}	Labor
		Supervision
		Driver's wages
		Supplies
		Oil and grease
		Solution and water
		Tires
		If electric
		Energy—Total KW. hrs. for a year at the prevailing rate
		If gasoline
Gasoline—Total number of gallons used during a year at the prevailing price per gal.		
Maintenance	}	General repairs
		Daily repairs
		Insurance approximately \$40 per \$1,000.
Fixed Charges....	}	Interest at 6 per cent on investment
		Depreciation—15 per cent covering a six-year period
		Garage rental

COST OF OPERATING CHARGING EQUIPMENT

Operating Charges	}	Labor
		Operator's wages
		Supplies
		Oil and grease
		Maintenance
Maintenance	}	General repairs
		Daily repairs
		Insurance approximately \$40 per \$1,000.
Fixed Charges....	}	Interest at 6 per cent on investment
		Depreciation—15 per cent covering a six-year period

COST OF OPERATING TRAILER

Operating Charges	}	Supplies
		Oil and grease
		Maintenance
		General repairs
Maintenance	}	Daily repairs
		Insurance approximately \$40 per \$1,000.
		Interest at 6 per cent on investment
Fixed Charges....	}	Depreciation—20 per cent covering a four-year period
		Garage rental

Motor Trucks, Tractors and Trailers

THE PURPOSE OF THIS SECTION is to describe and illustrate material-handling devices which are designed to carry and haul freight and loose bulk material and are fitted to run on streets and highways without a track. The information given embraces a general description of motor trucks, tractors and trailers, sets forth the principal elements of design and construction of these automotive units, and defines the principles governing their application.

To avoid repetition the common principles of design and construction are presented under the general classification described, and in many cases the illustrations are used to show general characteristics rather than specific design. Consequently, no particular significance should be attached to any seeming preponderance of data or completeness of description in a particular instance beyond the value of the facts presented.

The section is arranged in three major divisions which describe in turn the design and construction of automotive equipment; the principles of selection and factors governing performance; and general application in various lines. It is further subdivided under the different types of equipment discussed—that is, motor trucks, tractors and trailers—these latter divisions being separated according to the principal units which make up the equipment considered, such as motors, axles, transmissions, etc.

The two major divisions of the science of automotive engineering are treated, by this arrangement, according to their respective fields, that branch of the science appertaining to design and construction being separated from the branch which deals only with the principles of application.

With such modifications as are necessary to adapt the machine to the specific work for which it is designed, certain general principles of design and construction apply to practically all of the automotive equipment considered in this section. Consequently only the major parts of motor trucks are described in the general text, the special features being explained in the text covering the apparatus to which they apply.

Motor trucks may be broadly classified under three types according to the nature of the power which propels them, i. e. "gasoline," "electric" and "steam." The gasoline truck derives its power from the explosion of gaseous mixtures in the combustion chambers of a motor.

In the electric machine the power is derived from a storage battery—conveniently placed according to the design and size of the truck—which is connected by wires through a controller to an electric motor. The power from the electric motor is transmitted to the driving wheels through shafts and gears or chains and sprockets, as in the gasoline truck. However, in the electric truck the motor is a variable speed machine and the speed can be controlled by the voltage of the storage battery supplying the electric current. Consequently the clutch and the transmission which are necessary in the gasoline machine, are, of course, omitted in the electric machine in which the motor is

in direct permanent connection with the driving axle.

Power from the motor is regulated by a controller, usually consisting of a revolving cylinder operated by a hand lever, which is conveniently placed beside the driver's seat. Metal contact points mounted on this cylinder are so arranged that by revolving the cylinder the storage battery and motor field circuits may be connected according to the power requirements and speed of the machine.

The steam truck derives its power through the expansion of live steam in the cylinders of a steam engine. This type has been practically superseded by gasoline and electric vehicles, particularly in the United States. Consequently only gasoline and electric vehicles are considered here.

General Specifications

The general principles of design of gasoline and electric trucks are similar in that each consists of a steel chassis mounted upon four wheels with suitable axles, springs and steering apparatus—the whole supporting the body and the major power plant, driving mechanism, and accessory equipment required for the operation of the vehicle. The general principles of chassis construction entail no specific features of engineering

beyond those necessary for the load carrying functions of the machine, the proper distribution of weight and the requirements of assembly. Therefore only the major units which supply and transmit the power for moving the vehicle are presented in detail.

Frames

Chassis frames are constructed with side members of pressed steel (sometimes heat-treated) or rolled steel, depending upon the size of the unit, and the design of the manufacturer. Cross members are placed at convenient intervals for the proper support of the various parts and for rigidity and strength. Hot rivets are generally used in assembling the chassis frames and for attaching those parts which are permanently fixed. In some of the larger models gusset plates are added at the angles formed by the side and cross members of the frame. These gusset plates may be either riveted on, electric welded, or both. The depth of the frame members depends upon the size of the truck and the engineering practices of the manufacturer.

Wheels

Wheels may be either of wood or cast steel depending upon the size of the truck and the policies of the manufacturer. Cast steel wheels have not, as yet, been generally adapted to sizes of less than two tons capacity.

Front Axles

Front axles are usually drop forgings of carbon steel and I-beam construction although tubular axles are used in some cases. They are made in either the "straight" or "dropped" type, so named according to the general shape of

Motor Trucks: Classification; Details of Construction; Specifications; Selection; Factors of Performance; Application.
Truck-Tractors and Tractors: Types; Determination of Loadings.
Trailers: Four-wheel; Two-wheel; Semi-Trailers; Pole and Pipe Trailers.

the axle bed. Straight axles are alined without change of contour, whereas dropped axles have a distinct bend or drop in the center, or are curved downward throughout their entire length in the form of a sweeping arc. With the dropped form the spring pads may be lowered to secure a better alinement of the engine and driving shafts and lower the center of gravity. They also permit the use

standard Elliott type is generally used on motor truck axles, and the inverted Elliott is found in industrial trucks and some tractors.

Rear Axles

Rear axles (see also Final Drive) are of two principal types, i. e. "dead axles" and "live axles," the latter being

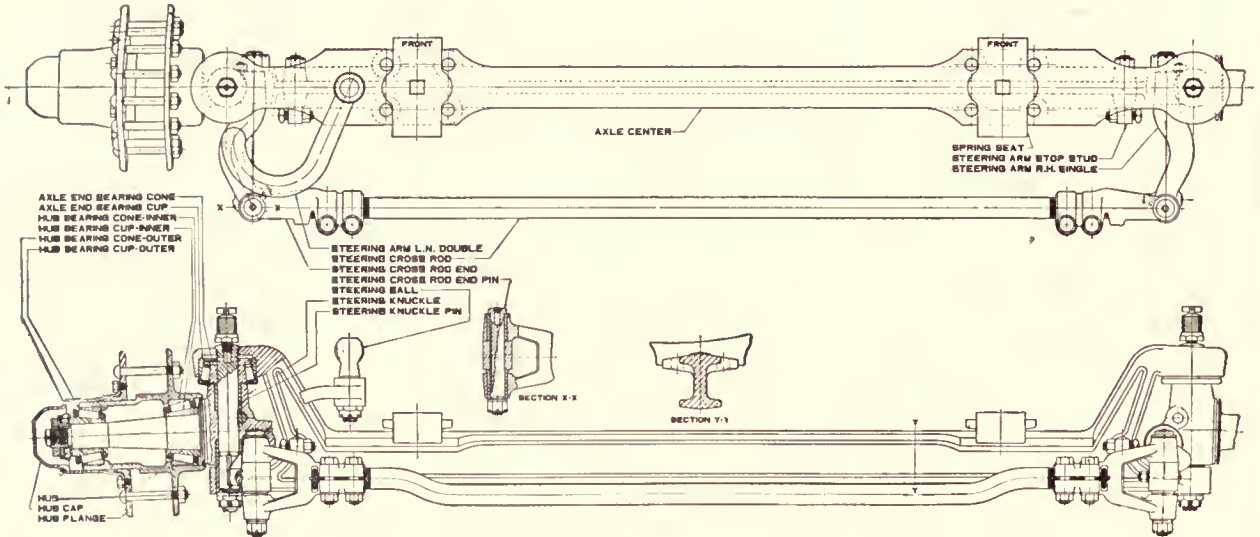

Fig. 1—Straight Type Front Axle

of large diameter wheels without increasing the height of the chassis frame above the ground.

Front axles are assembled as complete units with steering knuckles, wheel spindles, bearings and steering rods attached. Steering knuckles are designed in two types named from their designers, "Elliott" and "Lemoine." A modification of each type is found in the "Inverted Elliott" and "Inverted Lemoine" forms, which are used to some extent in passenger car design. The distinctive

produced in various modifications as described, that is Plain Live, Semi-Floating, Three-Quarter-Floating and Full-Floating axles.

Dead Axles

Dead axles are those which have no moving parts and serve merely as load carrying members, the wheels being turned by some connection outside the axle proper. The axle used on horse-driven vehicles illustrates the "dead"

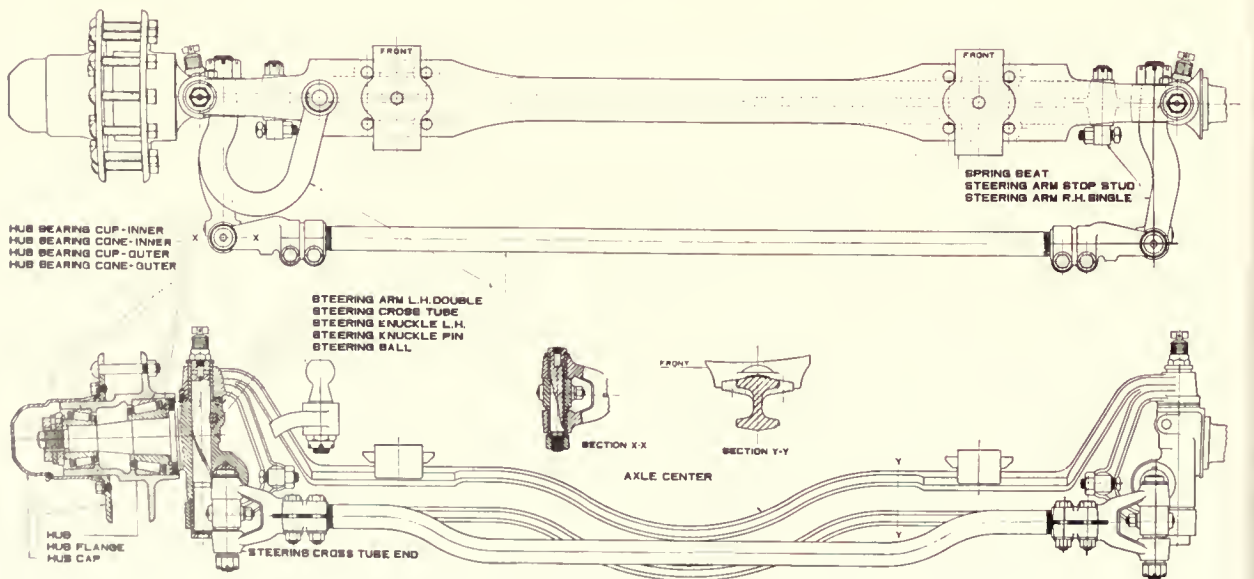

Fig. 2—Drop Type Front Axle

characteristics of design of each of these types are shown in the illustration of types of steering knuckles. The

axle in its simplest form. All "dead axles" are the floating type (Fig. 4), the wheels being free to turn inde-

pendently of each other. The dead axle (A) carries the load and the wheel (W) is turned by a chain on the sprocket (S) or may have a gear attached to it.

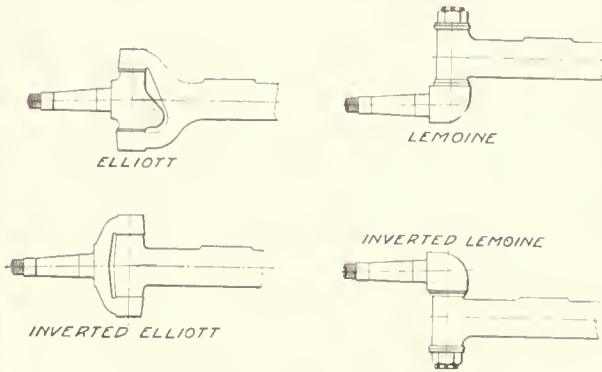

Fig. 3—Types of Steering Knuckles

This gear may be driven by either an internal or external pinion in a countershaft or be attached to the dead axle—

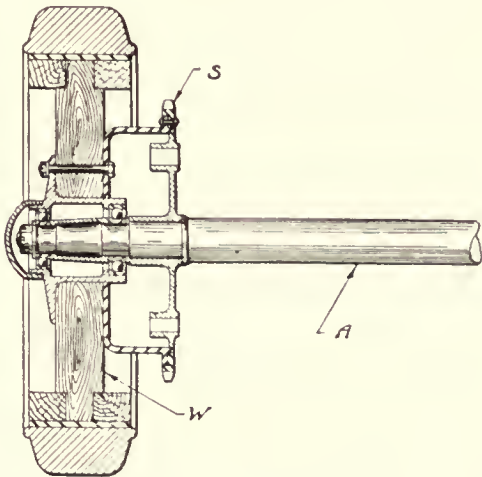

Fig. 4—Simple Form of Dead Axle

thus we have the conventional gear axle as an illustration of this construction.

Live Axles

Live axles are those which not only carry the load but also transmit the power. They consist of two distinct main parts, first, the housing which encloses the driving axles and working parts and supports the springs, and second, the live or floating sections of the axle. These latter are merely the jackshaft or side axles that transmit the power from the gears in the center of the axle to the road wheels.

Plain Live Axles

Plain live axles have shafts supported directly in bearings at the center and at the ends, these shafts being directly keyed to the road wheels. This type of axle (Fig. 5) is the simplest form and is now little used. In it the power is transmitted through conventional bevel or worm gear or other reduction to a differential (D) and thence to the wheels (W) through shafts (S). The shafts are carried by bearings (B) at their inner ends and by bearings (C) at their outer ends. Since these bearings are directly on this shaft, the weight of the differential,

etc., and the thrust of the gears comes on the shafts. Furthermore the wheel hub being attached to the end of the shaft, while the wheel bearing is on the shaft and

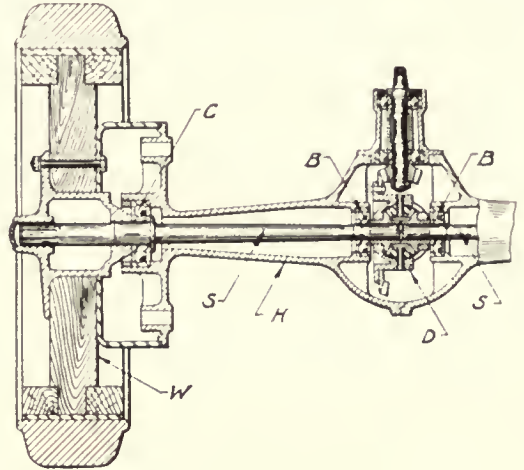

Fig. 5—Plain Live Axle

in the end of the housing, the load and wheel thrusts are taken directly by the shafts.

Semi-Floating Axles

The semi-floating axles (Fig. 6) are the same as the live axle except that the inner ends of the shafts are relieved from all thrust load and simply transmit the turning force. This is accomplished by mounting the bearings at the inner ends of the shafts on the ends of the differential hubs (D), instead of on the driving shafts.

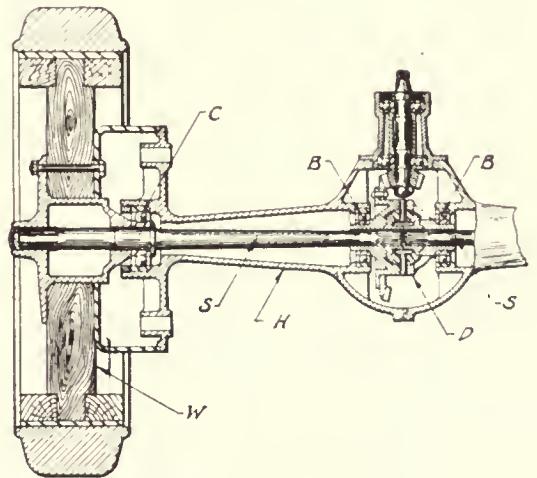

Fig. 6—Semi-Floating Axle

Thus the inner ends or halves of the driving shafts may be said to be free or floating where attached to the differential and hence "semi-floating."

Three-Quarter-Floating Axles

In the three-quarter-floating axles (Fig. 7), the inner ends of shafts (S) are secured in the differential (D) and the bearings are mounted on the hubs of the differentials, as in the semi-floating type. The wheel bearings are removed from the shafts, however, and mounted on tubes which are extensions of the housing (H). The wheel hubs are mounted on the outside of the bearings, the entire weight being carried by the wheel bearings and tubes instead of on the axle shaft. While it might appear that the outer ends of the shafts were thus made free from all

loads, except turning the wheels, and consequently that this is a full-floating axle, such is not the case, as but one bearing is used in each wheel. A single bearing is so short relative to the diameter of the wheel that it cannot hold the wheel in line against the side thrusts which result from operation. Therefore, the shaft is called upon to resist a

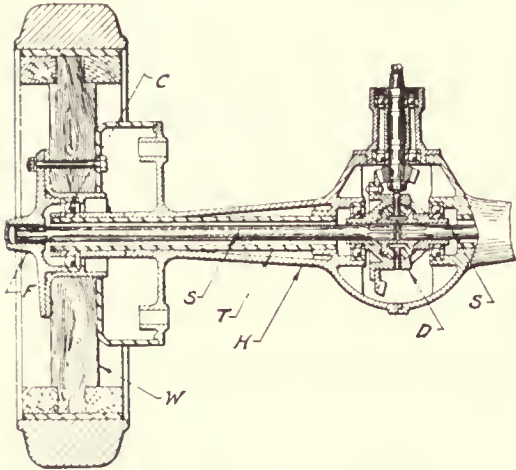

Fig. 7—Three-Quarters-Floating Axle

part of these thrusts, and as it is rigidly connected to the wheel by a flange, it must be strong enough to resist those side thrusts which tend to bend it.

Full-Floating Axle

The full-floating axle (Fig. 8) is formed by adding a second bearing to both wheel hubs of the three-quarter floating axle. The two bearings in each hub are spaced

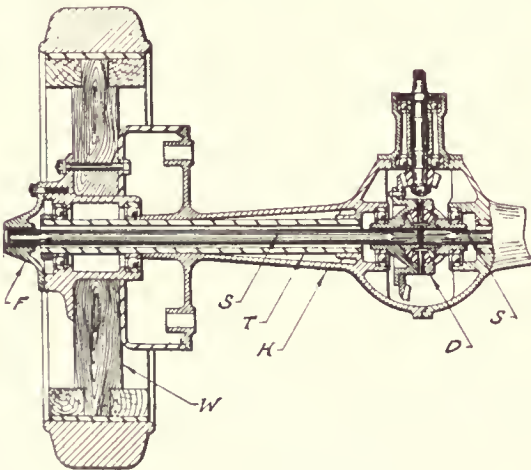

Fig. 8—Full-Floating Axle

far enough apart to take the side thrusts and leave the shafts free from bending stresses. It will be readily seen that the shafts are really free from all stresses except twisting at both ends, and hence "full-floating."

Final Drive

The conventional two-wheel rear drive is used in practically all makes of trucks, the only exception to this rule being found in the product of a few manufacturers who use the four-wheel drive. Consequently, as the two-wheel drive appears to be standard practice, only the various modifications of this type are presented.

Two-wheel drive rear axles are made in six general types, commercially known as Bevel (Fig. 6) for trucks up to and including one ton rated capacity; Chain Drive (Fig. 7), Internal Gear (Fig. 8), Worm Drive (Fig. 9), Double Reduction Gear (Fig. 10 and Fig. 11), Double Reduction Internal Gear generally for trucks of greater than one ton capacity (Fig. 12). These types are briefly described to show general characteristics of design rather than details of construction. From the descriptions, it is apparent that the various types may differ in details of design. For example, some may use ball bearings only, some roller bearings, and some a combination of the two. Also the axle shaft mountings may be "live," "semi-floating," "three-quarter-floating" or "full-floating" according to the engineering detail and other factors. The design may be further altered by the arrangement and types of brakes which are used.

Bevel Gear Axles

Within its limitations of gear reduction and ground clearance the bevel gear drive is supreme for motor trucks. It is simple in construction and highly efficient. Its legitimate field is being extended by the continued development of the spiral bevel pinion and special tooth forms, making possible greater gear reduction and higher torque within the same limitations of housing diameter or ground clearance. The requirements as to gear reduction are also being modified by the use of pneumatic tires, with increased speed capacity. However, increased speed capacity does not imply a lower maximum torque, as tire changes usually increase the wheel diameter, requiring an increased torque. The greatest bevel gear axle reduction in commercial use at the present time seems to be 6 to 1, and there are a number of examples of both worm and internal gear axles having reductions of less than that ratio, beginning at about 5.25 to 1. This seems to rule out the bevel gear for trucks exceeding one ton in rated capacity.

One type of bevel gear axle is of the semi-floating type with ball bearings throughout. The differential housing is ample to allow changes in gear reduction to be easily made, giving a range from 3.13 to 1 to 5.33 to 1. Service brakes are operated by a pedal, contracting on drums on the rear wheels. Emergency brakes are operated by hand lever, expanding on drums on the rear wheels. Another bevel gear type of rear axle is a full-floating axle with taper roller bearings throughout. The general design of this axle conforms to the principles of bevel gear axle construction.

A modification which is used only on electric trucks is a construction in which the motor and jack shaft assembly is three-point suspended. The motor is hung from a reinforced channel section. The jack shaft is mounted at its outboard ends in combination hangers. The motor drives the jack shaft through a bevel gear and pinion reduction, the bevel pinion being mounted directly on a prolongation of the forward end of the armature shaft. A double reduction is given by the bevel pinion and gear and the side chains.

Internal Gear Axle

The design of the internal gear type of axle varies somewhat in mechanical details according to type of manufacture and the size. The load carrying member may be a straight round bar or an I-beam construction. The driving mechanism is usually in front or back of the axle, but on one type it is placed above the wheel centers. The wheel bearings are usually of the flexible roller and double row ball type. The internal gear is mounted on the cast wheel

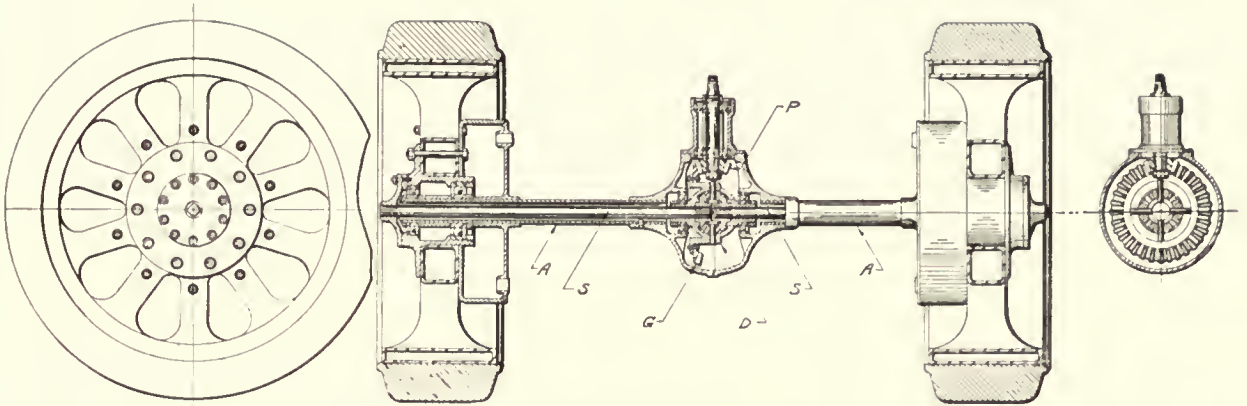

Fig. 9—Bevel Gear Drive

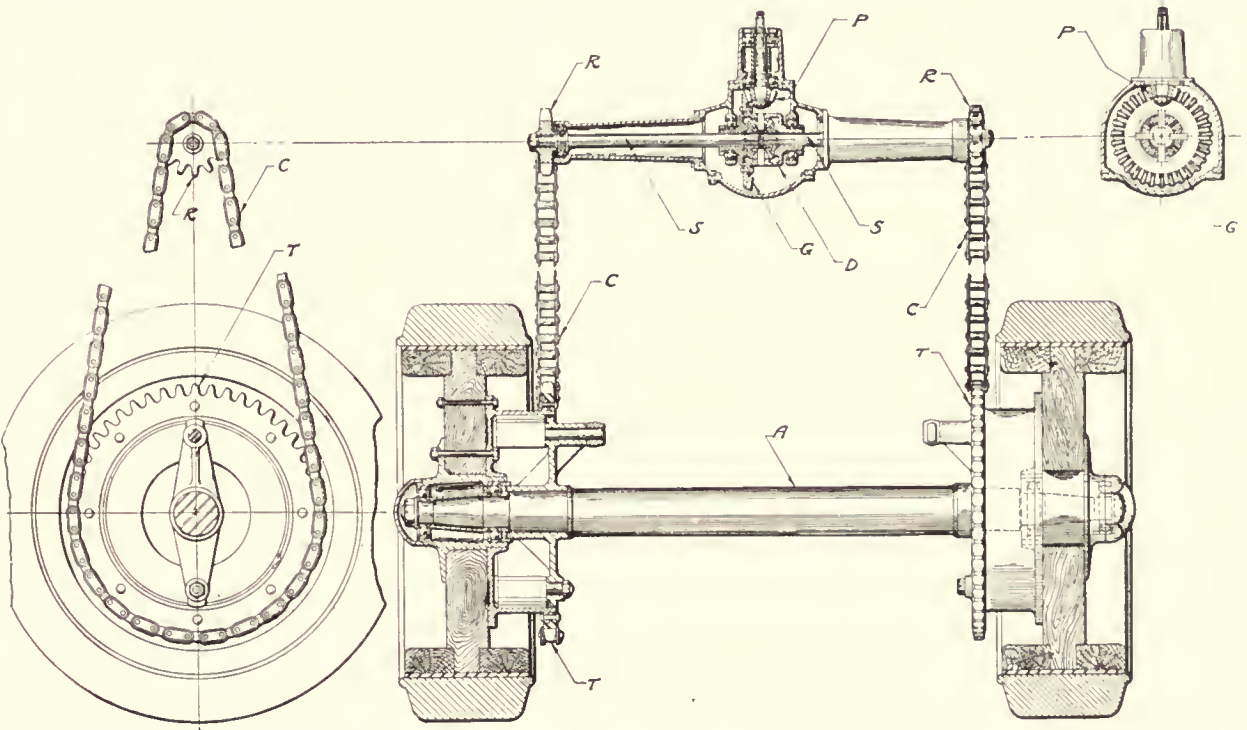

Fig. 10—Chain Drive

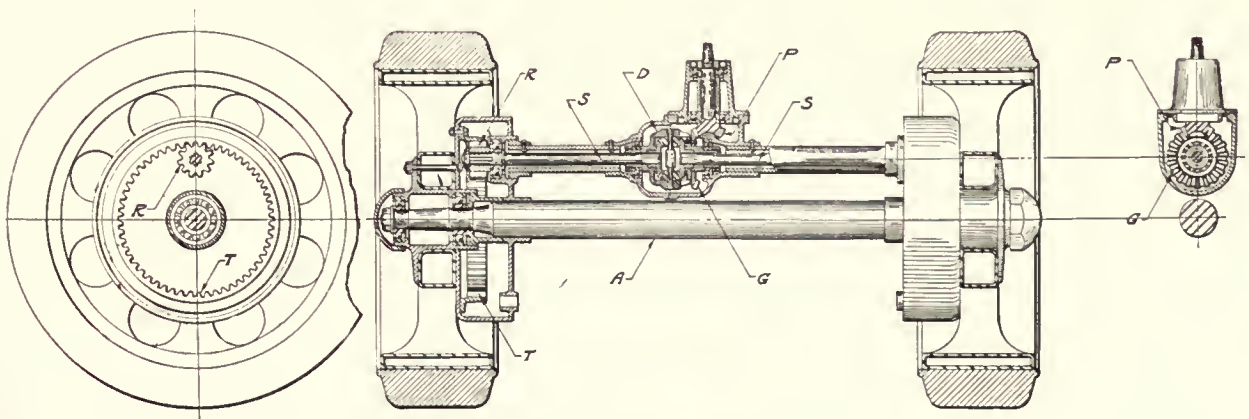

Fig. 11—Internal Gear Drive

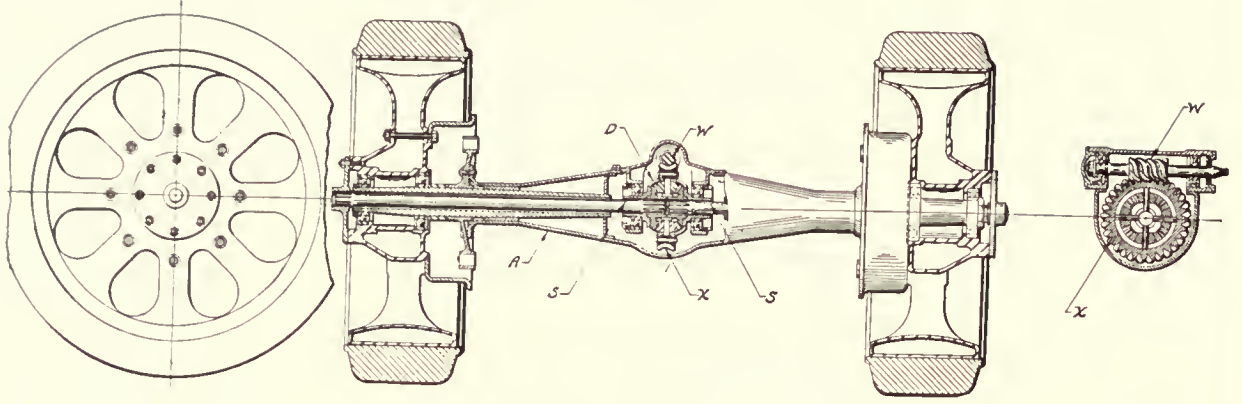

Fig. 12—Worm Drive

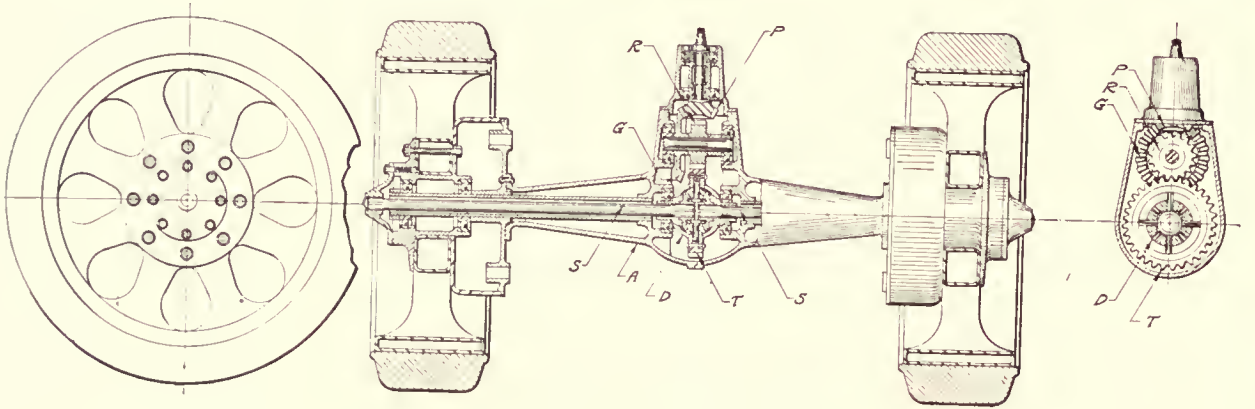

Fig. 13—Double Reduction Gear, Bevel and Spur

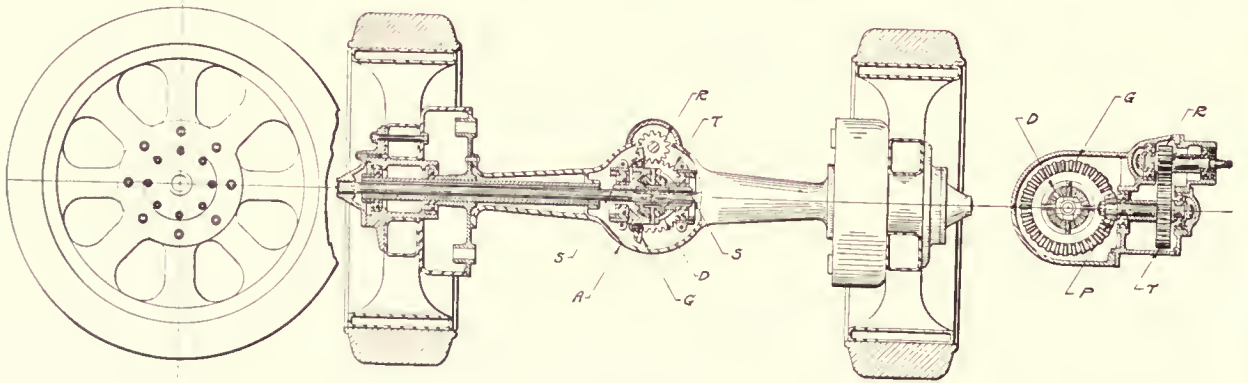

Fig. 14—Double Reduction Gear, Spur and Bevel

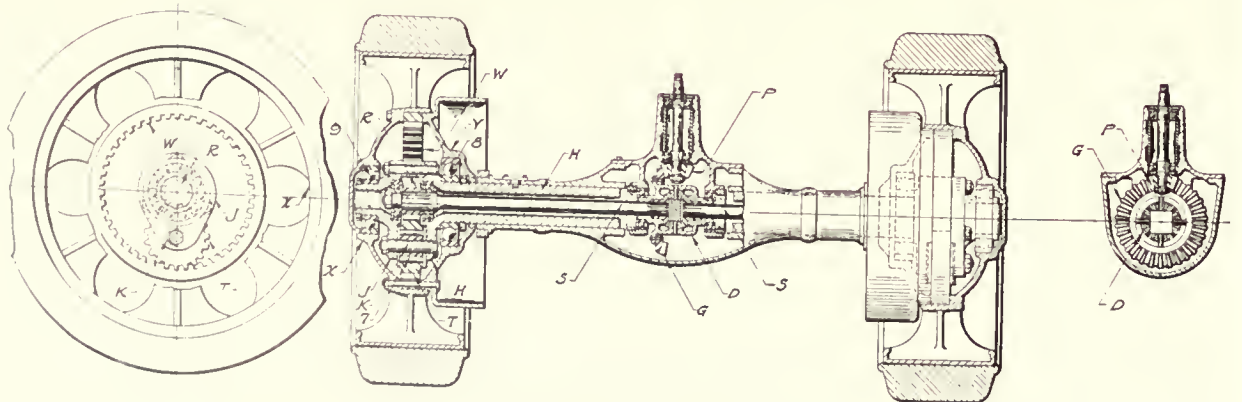

Fig. 15—Double Reduction Internal Gear

hubs in a manner to insure good support and alinement, or enclosed in the brake drum, or in a separate housing. The brakes are internal and external, generally on drums outside the internal gear. On one type the brakes resemble multiple disk clutches in general structure having outer and inner drums with suitable splines to engage alternative disks respectively.

In one type of internal gear axle the differential housing is mounted in spherical seats and extends from one spring seat to another, and is attached to the rest of the axle at its two ends. This promotes accessibility and tends to keep the pinion in line with the internal gear, should the axle be deflected under load.

For another type the housing is rigidly supported at one end and flexibly attached at the other which provides a certain amount of flexibility. Another type uses a housing for the drive shaft and differential that is rotatively mounted with respect to the axle, the torque displacement being controlled by coiled springs which cushion the drive.

A modification which is used only on electric trucks is a construction in which the motor and gear reduction are enclosed in the axle housing. The straight line gear reduction transmission is a feature of this type of axle, and uses but two gears of nearly the same diameter which provides a reduction of 16:1 between the high speed motor and the driving wheels. The housing, which is the load carrying member of the axle, is a strong, sturdy casting provided with a large removable cover which enables the entire motor and transmission to be taken out of the housing without unloading the truck. Both brakes are of the expanding type. In a modification of this form the motor and differential are mounted in the housing, but the gear reduction, consisting of driving pinion, two idler gears and a rim gear, is mounted inside the wheel.

Another modification which is used only on electric trucks is a construction with a gear transmission having an electric motor in each driving wheel. The motor armature has a pinion on either end, one pinion pulling up on one side of the wheel, the other pulling down at the opposite side, and both working at the periphery. An evener device permits of a compensating movement and divides the force equally between the two pinions regardless of any unequal wear or adjustment.

Another modification which is used only on electric trucks is a construction without a differential gear. Each wheel is driven by a motor, and is carried in a casing which forms part of the axle. The gears, spindle, wheel and all parts of the driving unit are set in a fixed relation to each other. The two-motor drive permits a series parallel control which results in considerable less waste of current when accelerating, and also eliminates a large part of the resistance necessary where a single motor drive is used. The two-motor equipment also permits a system of control that provides efficient operation at low speed.

Worm Gear Axles

The general construction of these axles, as built in sizes from $\frac{3}{4}$ to 5 tons capacity, is a semi-floating or full-floating axle with overhead, straight or other type of worm.

The housing is generally of one piece extending from wheel to wheel and of rectangular section at the ends; it is sometimes furnished on the outside with heavy ribs to give rigidity and strength.

The shaft is enlarged at the inner ends to provide for the splines which enter the differential. On some forms it is also enlarged at the bearing to provide for heavy stresses at this point.

The driving mechanism is carried as a completely assembled, self-contained unit in a carrier attached to the housing, and is easily removable for examination or change of gears.

The worm, worm wheel and differential are mounted on ball bearings. The worm and shaft are constructed so that the rear bearing takes the thrust.

On all types of worm gear axles the construction provides methods to keep the driving mechanism and moving parts well lubricated, but one type is constructed in which particular attention is given to this detail.

Double Reduction Internal Gear Axles

This is a full-floating type of axle, with a train of gears in the hub case of the wheel, the whole driving mechanism being entirely encased and running in oil. By the arrangement of the driving mechanism the first reduction occurs through the bevel gear and drive pinion in the center of the rear axle. Thence the power is carried by a live axle of the floating type through the center of the housing to a gear at the wheel end of the live axle. This gear, in turn, meshes with a second gear (carried on the housing of the live axle, but inside the hub case of the rear wheel), and this second gear, in turn, meshes with a ring gear attached to the wheel inside of the hub case.

With this method of applying power to the wheel, a second reduction occurs between these three gears in the hub case, very similar to the reduction which takes place between the sprocket wheels of a chain drive.

The axle housing is a casting, extending from wheel to wheel and serving as the load-carrying member.

The service brake is of the contracting type, operated by foot pedal and acting on drums on the drive shaft.

In another form of double reduction internal gear axle the driving power is transmitted at the center in the conventional manner by a bevel drive pinion and gear, which are mounted as a self-contained unit with the differential assembly. The torque is farther transmitted by the drive shafts through the center of the load-carrying member to a spur pinion in the center of the wheel. This pinion floats between the two "idler" or intermediate gears, which are held in place on substantial roller bearings between two arms, projecting diametrically opposite from the yokes, with their center line parallel to the ground. The idler gears in turn drive the internal gears which are pressed in and bolted solidly to the wheel hub.

The axle housing is a casting extending to the inner wheel bearings and serving as a load-carrying member. It contains the bevel drive gears and differential, at the center (concentric with the wheels), which are mounted in a removable differential carrier.

A further modification of this type of axle provides a planetary gear reduction at the wheel hub. The drive shaft and housing are concentric with the wheel, and a differential with a bevel gear reduction is provided at the center of the axle. The drive shaft extends through to the extreme end of the axle, as in a full-floating bevel gear axle, but carries a driving pinion on its end.

The wheel bearings are on a sleeve surrounding the axle tube, which is provided with a mounting flange for the internal gear ring which is placed at the outer side of the wheel hub.

Double Reduction Gear Axle

A double reduction (spur, bevel) semi-floating type axle is constructed with a skew spur pinion located near the

top of the axle which drives a skew gear below it, these two comprising the first reduction. The two shafts are supported on annular bearings, arranged to take the end thrust involved in any skew gearing. The final reduction is by a bevel gear, secured to the differential case, and a pinion, the latter being mounted on the shaft which carries the larger skew gear.

The entire reduction train is enclosed in a casting which forms the center of the axle. When the two castings which form the outer ends of the axle are bolted to the center casting, these three castings form the load-carrying member to which the springs are attached.

From the differential, steel drive shafts transmit the driving effort to the rear wheels.

Two sets of brakes are provided on the wheels. The service brakes are of the external contracting band type. Emergency brakes are of the internal expanding shoe type.

In another type the axle is full-floating type and the first reduction is made by bevel gears and the second by spur gears, the spur ring being mounted on the differential.

The load-carrying member is a housing of the double banjo type with the wheel spindles and spring saddles integral. The yoke in the center of the axle housing is set at an angle of 45 deg. instead of vertical or horizontal. This increases the road clearance and by the arrangement of the gear train produces a straight line drive. The gear reduction is assembled as a separate unit in a housing bolted to the rear axle. Transmission and rear wheel brakes are provided but contrary to ordinary practice the transmission brake is the emergency brake and the rear wheel brakes are the service brakes.

Transmissions

The transmission, or change speed gear provides the means for adapting the power of the motor to the requirements of the service. Gasoline motors differ from steam engines or electric motors in that they do not start from a standstill with full torque but develop full torque only when running at a speed of maximum output, or a speed of maximum economy. In motor vehicle operation it is desirable to apply the power in such a way that the motor will run at a speed near its point of highest economy. This is accomplished by the transmission, which is an arrangement of gears designed on the principle that when two shafts, or other rotating machine parts, are connected together in driving relation, the torque of the two bear to each other the inverse ratio of their respective speeds. By providing suitable gear reductions in the transmission, the engine power can be multiplied as required and economic engine speed maintained.

Transmissions are made in two principal types, named, according to the general character of design, "planetary" and "sliding" change gears. In the planetary type the gears are arranged to revolve around a common center, as well as to rotate upon their axes, simulating the motion of the planets around the sun. In the sliding type, the gears are mounted on parallel shafts and brought into the desired arrangement either by shifting the position of the gears on the shaft, by sliding them in or out of mesh, or by operating sliding jaw-clutches mounted on the shaft, which engage the gears as desired.

Planetary Transmission

The planetary type of transmission is used principally in light-weight, low-priced trucks, and gives but two forward

speeds. Its principles of operation may be explained as follows:

The driving shaft may be either an extension of the crank shaft or connected to it. On the shaft is mounted the driving pinion which meshes with two or more planetary pinions, they in turn meshing with the internal gear. The planetary pinions are of equal size and are evenly distributed over the circumference of the pinion. The internal gear is mounted on a bearing on the driving shaft. The planetary pinions are mounted upon shafts attached to the pinion carrier which has a bearing on the driving shaft and which may be a disc, spider or drum. It will be seen in the illustration that the driving pinion will drive the internal gear through the planetary pinions. If the internal gear is held stationary by a brake, the planetary pinions will roll on it and carry the pinion carrier around in a clockwise direction; that is, in the same direction

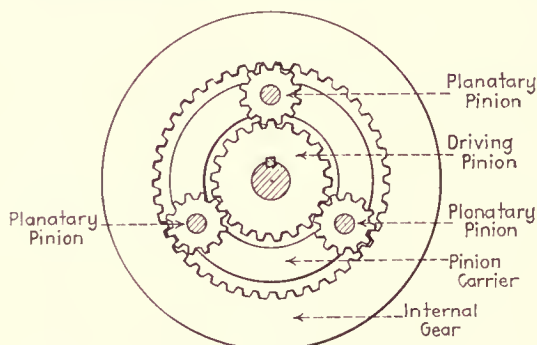

Fig. 16—Planetary Gearing

in which the driving shaft is revolving, but at a lower speed. With the pinion carrier in driving connection with the driven shaft, the vehicle will then move forward on low speed.

Reverse gear is obtained by holding the pinion carrier from revolving, releasing the internal gear and connecting it to the driven shaft. The driving pinion will then transmit power through the planetary pinions causing the internal gear to revolve in the opposite direction.

For high speed forward the driven shaft is directly connected to the driving shaft by a friction clutch forming part of the planetary gear set and the whole gear unit may revolve.

Sliding Transmission

Sliding type transmissions are practically all of the "selective" type, that is, the gear desired may be selected at will, it being unnecessary to pass through intermediate steps as in the early "progressive" form.

In the sliding type transmissions, speed gear changes are made either by sliding the gears on the main drive shaft, or engaging them with sliding jaw clutches by a gear shift lever conveniently placed, usually in the center of the truck just forward of the driver's seat. Two assemblies are manufactured, the unit power plant type and the amidship type with either three or four forward speeds as standard design.

The unit power plant type transmission with sliding jaw clutch is designed to be incorporated as a part of the engine assembly unit in a gear case which forms a part of the bell housing directly behind the engine.

The amidship type transmission with sliding gears is designed as a complete unit assembly and is usually placed under the floor boards in front of the driver's seat. The

main driving gear or clutch gear shaft is connected to the engine either by an extension of the engine crank shaft or by a short shaft connected with it.

In both the sliding clutch and sliding gear transmissions, the gear set consists of four shafts placed either

the propeller shaft to the driving axes and rear wheels of the truck. Shaft *C* is the transmission back gear shaft or countershaft (called the "lay shaft") through which the power is transmitted from the driving gear shaft *A* to the splined shaft *B* whenever any pair of gear wheels,

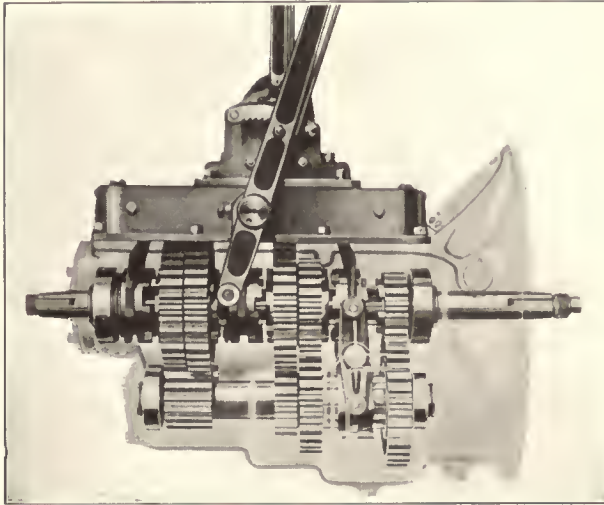

Fig. 17—Unit Power Plant, Sliding Clutch Type

in a vertical or horizontal plane. Gear wheels, whose diameters vary according to the ratios and speeds for which the transmission is designed, are mounted on these shafts, those on the lay shaft being keyed or otherwise fastened in position, and those on the main drive shaft being splined in the case of the sliding gear type, and

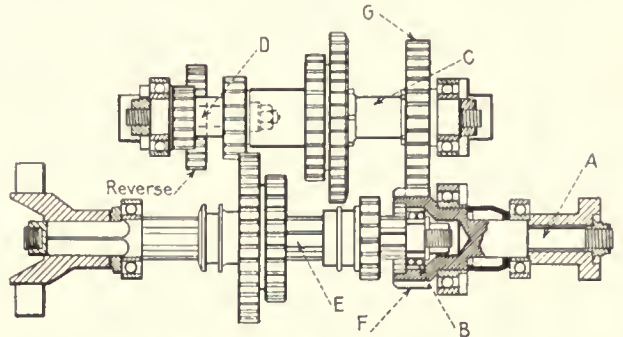

Fig. 19—Transmission Assembly, Sliding Gear Type

except *F* and *G* are in mesh. It is to be noted that gears *F* and *G* are always in mesh as they transmit the power from shaft *A* to shaft *C*.

Shaft *D* is the reverse gear shaft which carries the third gear necessary to cause the shaft *B* to rotate in the reverse direction. Shafts *A* and *B* rotate on the same axis,

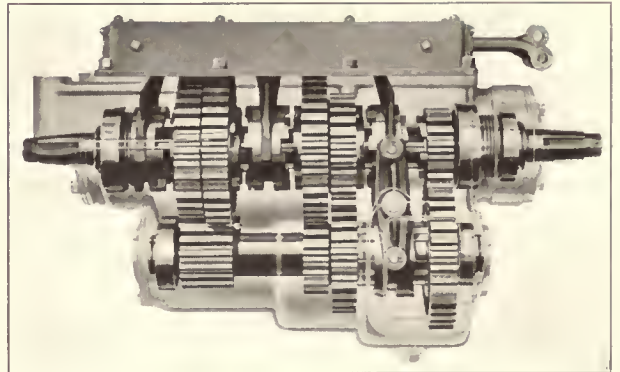

Fig. 20—Sliding Jaw Clutch Transmission

the front bearing of shaft *B* being supported on bearing *E* located in the rear end of shaft *A*.

The sliding jaw clutch type of transmission operates on the same general principle as the sliding gear type except that the gears are in constant mesh, the speed ratio desired being obtained by bringing the proper gears into operation by sliding jaw clutches which are mounted on the shafts.

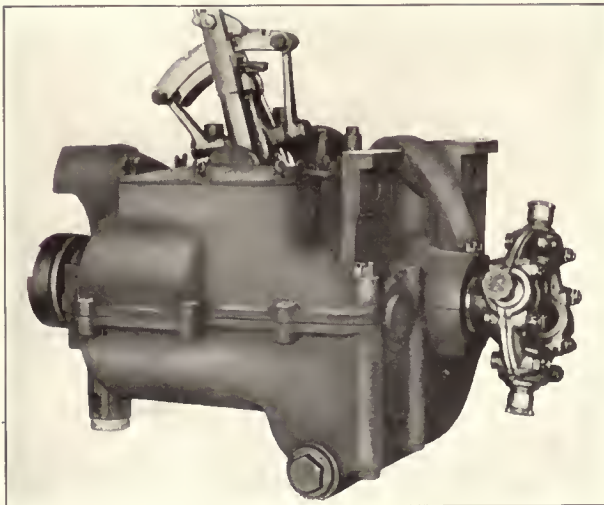

Fig. 18—Amidship Type Transmission

rotatively mounted in the case of the sliding clutch type, with sliding jaw clutches on the splined sections of the shafts.

Transmission Assembly

The general assembly of these four shafts with change speed gears is shown in the drawing which illustrates the layout of a four-speed sliding gear transmission. Shaft *A* is the main driving gear or clutch gear shaft, and is rotated by the power from the engine. Shaft *A* is the main drive shaft or sliding "gear" shaft (called the "splined shaft"), from which power is transmitted through

Steering Gears

Steering gear is the term applied to the mechanism used on motor trucks to guide the vehicle. Usually only the front wheels are so guided—or steered—the steering gear proper being connected to the wheels by a ball socket drag link—or steering connecting link—one end secured to the pitman arm of the steering gear, the other to an arm on one of the axle pivots.

Practically all steering gears comprise a handwheel mounted at the upper end of a steering column or shaft. Spark and throttle controls are mounted either concentrically or eccentrically. At the lower end of this column the rotary motion of the steering handwheel is converted

to an oscillating fore and aft—or side to side—motion at a lesser speed than the handwheel, by a suitable reduction gear. In motor truck design, five distinct types of reduction gears are in general use. These are illustrated and classified according to design (A) worm and gear, or worm and sector (part gear); (B) worm and split nut; (C) worm and full nut; (D) bevel pinion and sector; (E) double worm or double thread.

End thrust of the worm or the pinion and side thrust of the worm gear—or bevel gear—are taken either by plain bearings or anti-friction bearing, according to the ideas of the designer and maker. Worm, worm gear, bearings, etc., are enclosed in a grease tight case or housing.

(A) The worm and gear, or worm and sector, steering gear is fundamentally similar in design to that of a worm drive rear axle, but with the following important modifications demanded by the application:

(1) The handwheel and worm on the lower end of the steering column rotates from $1\frac{1}{2}$ to 2 full turns, while the worm gear, which is attached to a horizontal shaft (or pitman shaft) with steering or pitman arm at the other end, rotates or oscillates only one-sixth to one-fourth of a turn.

(2) Efficiency in the transmission of power is of relatively small value.

(3) The ratio between the amount of turn of the handwheel (and worm) and the shape of the teeth on the worm and worm wheel are such as to make the steering nearly non-reversible—that is, road shocks on the front wheels are not transmitted through the steering gear to the handwheel.

(B) The worm and split nut type of steering gear consists fundamentally of a worm, or screw, having both right and left hand threads cut upon its surface. Two half nuts are provided, held against rotation by rectangular guide pockets. One of these half nuts has a right hand

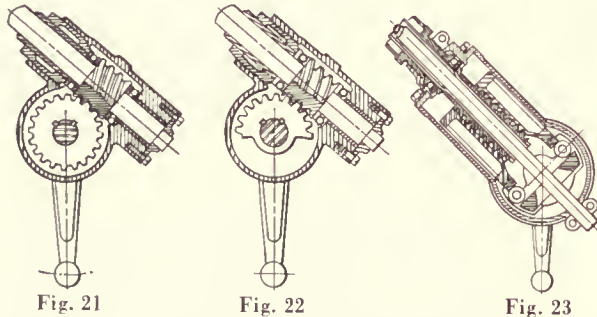

Fig. 21—Worm and Gear; Fig. 22—Worm and Sector;
Fig. 23—Worm and Split Nut

thread cut on its inner face; the other nut has a left hand

thread. Rotating the worm shaft, which is held against endwise movement by the handwheel, causes one nut to move away from the handwheel, the other towards it. The extended ends of the two nuts bear against a rocking arm integral with or attached to the pitman shaft, thus actuating the pitman arm. This type of gear is adjustable for wear by forcing the thrust bearing axially closer to the split nuts.

(C) The worm and full nut type of gear uses a worm with only a single set of threads—either right hand or left hand.

Rotating the worm (by the handwheel) causes the nut to move up or down on the shaft. By means of a sliding

block, or pair of blocks, the nut bears against arms or trunnions formed on the pitman shaft, causing it to oscillate, hence moving the pitman arm.

(D) The bevel pinion and sector type of gear has a bevel pinion fastened at or near the lower end of the steering shaft, and meshing with a section of a bevel gear of much larger diameter. Turning the handwheel

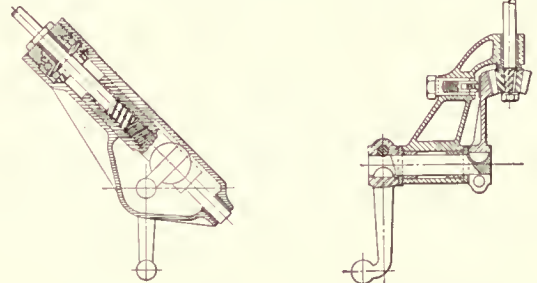

Fig. 24

Fig. 25

Fig. 24—Worm and Full Nut; Fig. 25—Bevel Pinion and Sector

rotates the bevel gear pinion, thus rotating the gear sector, which is integral with or keyed to the pitman shaft. This type of steering gear is reversible; that is, road shocks are transmitted, at least to a degree, to the handwheel.

(E) The double thread type steering gear is one in which the reduction or ratio and the non-reversible feature are secured by a dual set of threads. An outer nut, loosely splined to the pitman arm, has a set of spiral grooves or threads on its outer face. These threads mesh with corresponding threads on the inside of the housing. The inner face of this nut also has a set of threads of a different pitch (number of threads per inch) meshing with a set of similar threads on the worm shaft.

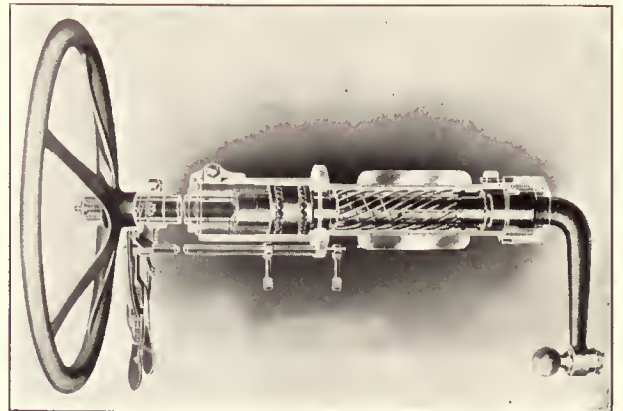

Fig. 26—Double Thread Type

Turning the handwheel causes the nut to slide endwise and at the same time to rotate in the opposite direction from the handwheel, but at a much slower rate of speed. The pitman arm being splined to the nut, rotates with it and accomplishes the required steering effort.

Clutches

Clutches as commonly used in motor trucks are classified under four general types, according to their characteristics of design. These four types are cone, plate, multiple disc and friction band. The last named is so

little used, except in combination with a planetary type transmission, that a description of it is omitted.

Cone Clutch

Cone clutches consist of a section of a cone formed on the outer rim of a disc or spider, the hub of which is slidably mounted on a square shaft, which is splined or keyed in such a way that it may be moved in the direction of the axis of the shaft. The outer surface of this cone is faced with leather, asbestos, woven fabric, or in some cases composition metal, the whole cone fitting into a conical recess in the engine fly-wheel. Both the cone member and the recess in the fly-wheel have the same angle of contact. This angle varies between 12 deg. and 40 deg. included angle. The 25 deg. included angle has been adopted as standard by the Society of Automotive Engineers.

In the driving position the cone with its facing is forced into contact with the surface of the conical recess in the fly-wheel by one or more springs. Releasing the clutch by pushing on the clutch pedal is accomplished by forcibly withdrawing the cone from the recess, against the pressure of these springs.

Dry Plate Clutches

Dry plate clutches are constructed so that the driving effort or torque of the engine is transmitted from the engine to the transmission by the friction between the plane surfaces of suitable discs. These discs may be of plain metal, such as steel, or they may be fitted on either side with an annular ring of leather, asbestos fabric or composition metal. Such clutches also may be run in a bath of oil.

In certain types of dry plate clutch, only one fairly large diameter revolving disc is used; it is mounted on the driving shaft to which its hub is keyed or splined. In this type the single disc is made of plain steel with leather, asbestos fabric or metal facings riveted to the fly-wheel or to discs attached to the fly-wheel. The plate type of clutch is made in two styles, one the lever operated type, and the other the expanding wedge type.

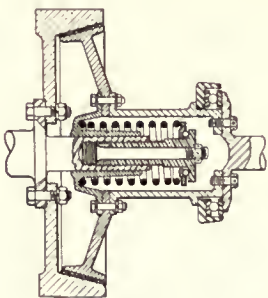

Fig. 27—Cone Clutch

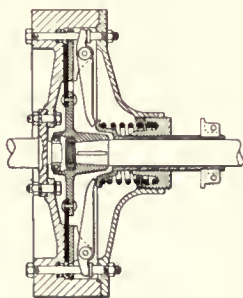

Fig. 28—Dry Plate Clutch Toggle Operated

In the lever operated type a toggle is furnished which has a pivot point on a plate attached to the fly-wheel and revolving with it. The longer end of the toggle engages with a suitably shaped sliding member on the shaft, which is forced into position by a spring. The short end of the toggle lever presses the various friction surfaces together. The operation is sometimes performed by a series of coiled springs which force the various discs into engagement with each other. When it is desired to free the clutch the springs are compressed by suitable linkage, thus eliminating the friction contact between the discs.

In the wedge operated type the wedges are suitably arranged, usually radially, spring and toggle operated. The surfaces of the wedges are operated against two or more wedge plates or rings, thus forcing the discs into engagement.

Multiple Disc Clutches

Multiple disc clutches are in many respects similar to the dry plate type. In this type a number of thin discs or annular rings, provided with tabs on the inner periphery, are mounted on the outer surface of a splined drum which is keyed to the driving shaft of the transmission.

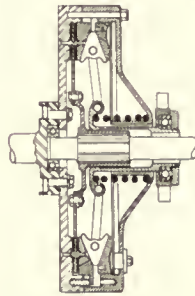

Fig. 29—Dry Plate Clutch, Wedge Operated

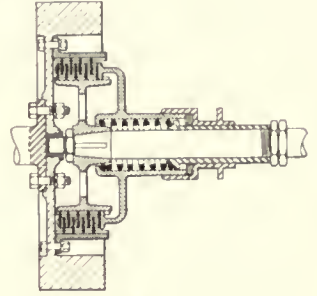

Fig. 30—Multiple Disk Clutch

A second set of thin discs or annular rings, whose inner and outer diameters are each greater than the corresponding diameters of the rings just mentioned, are provided with tabs on their periphery. These are mounted on the inside of a housing or shell attached to the fly-wheel, the tabs fitting into internal splines. These discs or rings are stacked alternately. There are a number of modifications of this type of clutch as follows:

- (1) Plain steel discs or rings forming a metal to metal contact, the whole clutch immersed in oil.
- (2) One set of the rings, usually the inner or small diameter set, is faced on both sides with a suitable friction material such as asbestos or fiber.
- (3) The rings may be so stamped or formed that they constitute a series of small annular cones. The cones on the smaller diameter discs or rings mesh, each one with a corresponding cone on the outer rings. This type is operated in a bath of oil.

Engines

Engines (internal combustion) used in motor trucks, although fundamentally alike, differ considerably in construction and design. They are sometimes classified as slow speed, medium speed and high speed, according to their relative speed of operation. It has been found difficult to secure agreement as to just what constitutes the limits of each of these classes. In general, engines which have a maximum working speed of 900 r.p.m. or 1,000 r.p.m. are classed as low speed, those operating at a maximum speed ranging from 1,100 r.p.m. to 1,800 r.p.m. may be termed medium speed, while high speed engines may have a maximum speed of 2,000 r.p.m. or more.

There are many successful gasoline engines of each of these types produced commercially, the speed class of any engine being largely determined by the truck engineer when considering the design of the truck as a whole.

The principal major modifications of truck engines are to be found in method of cooling, method of lubrication, type of valves, etc.

The horsepower of an engine and its suitability for use in a motor truck depends upon a number of different factors as follows:

The possible total pressure in one cylinder, due to the explosion, is proportional to the square of the cylinder diameter. It is directly proportional to the average or mean effective pressure. The mean effective pressure in turn depends upon the quality of the gasoline-air mixture, as it affects completeness of combustion; the size of the valves, as they govern the amount of fuel mixture delivered to each cylinder; the location of the valves as they affect the completeness with which fresh gas is drawn in and the burnt gases are expelled, and the mechanical efficiency of the various working parts.

The factors mentioned are those which affect, or govern, the torque or twisting effort of the engine. This torque or twisting effort is of low value at low speeds, as for example at speeds below 300 r.p.m. At higher speeds the torque valve, with wide open throttle, is gradually increased until the maximum value is reached.

Maximum torque value is ordinarily found at one-half to two-thirds of the speed at which the engine delivers its maximum horsepower. From this point to still higher speeds the torque value is reduced. This is principally because the time elements involved in the opening and closing of valves and in the movement of the piston and velocity of the gases are not sufficient to permit the proper quantity of fresh fuel mixture to be drawn into the cylinder and properly ignited and expelled.

Horsepower is a function of both speed and torque. If a gasoline engine could maintain an absolutely uniform torque value at all speeds, then the horsepower delivered by the engine would be proportional to the speed at

Fig. 32, which is a chart showing typical horsepower and torque curves of a medium speed, 4-cylinder truck engine, with 4-inch bore and 5½-inch stroke, operating

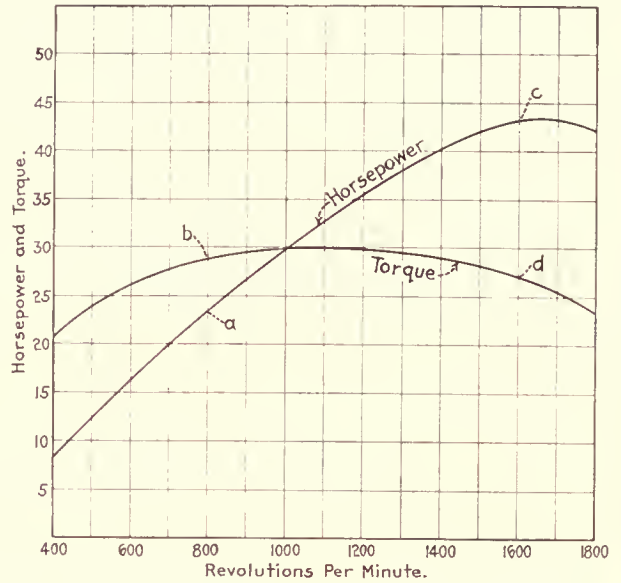

Fig. 32—Typical Horsepower and Torque Curves of a Gasoline Motor

at a maximum working speed of 1,600 r.p.m. It will be seen that at 800 r.p.m., the horsepower (a) is 23 and the torque (b) 29 lb.; whereas at 1,600 r.p.m. the horsepower (c) is 43 and the torque (d) is 27 lb. The torque values stated are at 63.025-in. radius.

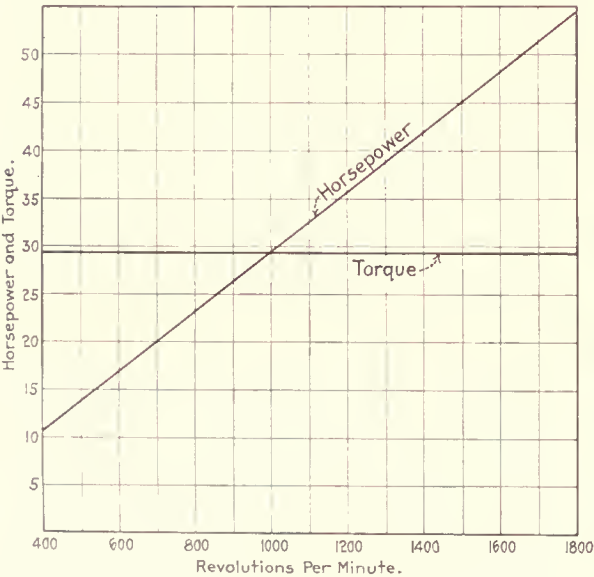

Fig. 31—Theoretical Horsepower Curves at Uniform Torque

which it was operated. Under these conditions horse power and torque curves would be straight lines as shown in Fig. 31. The falling off or lowering of the torque above certain engine speeds results in a horsepower at such speeds less than that proportional to the speed. A gasoline engine of the medium speed class, which delivered 23 horsepower at 800 r.p.m. probably would deliver only 43 horsepower at 1,600 r.p.m.; that is, doubling the speed does not double the horsepower. This is illustrated in

Methods of Cooling

Cooling motor truck engines is usually accomplished by circulating water, although air-cooled engines have been produced. Considering water-cooled engines only, the cylinders are so designed that water may be circulated around the outside of the cylinder proper in a jacket.

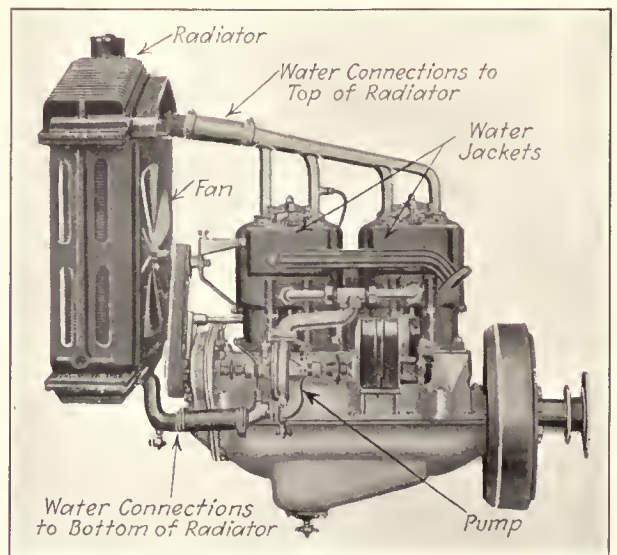

Fig. 33—Cooling System

This water-jacket is usually cast integral with the cylinder proper, although in some instances it has been made

separate and either bolted, riveted or welded to the cylinder.

Inasmuch as the valves are subjected to the greatest temperatures, cylinder castings are usually arranged so that the water-jacket extends around or partly around the pockets where the valves are located.

This cooling water is circulated either by the thermo-syphon system or by a power-driven pump. In the thermo-syphon the circulation of the water is caused by the difference in temperature in the two parts of the cooling system (engine and radiator) in much the same way as water is circulated in residential water heating systems.

The forced circulation system employs a pump to force the water through the water jacket and radiator. A fan is also used to draw air through the radiator tubes in order to increase the rapidity of radiation.

Pumps

Pumps may be either of the "gear type," the "centrifugal type" or the "rotary type." Gear pumps have two small gears which are in mesh and enclosed in a comparatively snug casing. The inlet and outlet are placed on opposite sides of the casting at points approximately within the plane where the gear teeth mesh. The water enters on the side where the gear teeth separate and is carried around and discharged through the outlet located on the opposite side of the casing.

The centrifugal pump consists of a number of blades mounted on a hub and revolved at high speed inside a comparatively snug casing. The water enters at the hub and is thrown out by the blades through the outlet in the side of the casing.

The rotary pump is made up of a disc placed eccentric in a ring-shaped casing. Slots in the disc permit the insertion of two arms or blades which are pressed against the walls of the casing by springs and which, acting as blades, carry the water through the pump. The water enters at the top and is discharged at the side of the pump case.

Radiators

Radiators are required for both the thermo-syphon and force systems of cooling. These are constructed in a number of forms and with various modifications. All of these forms are classed under two general types: "tubular radiators," which include all those composed of vertical water passages, of different forms and shapes, and "cellular radiators," composed of a number of individual cells, which may be arranged in different ways and are made in a variety of shapes.

In the tubular type the hot water from the engine, after delivery to the top of the radiator, passes down through the vertical tubes. These tubes may be round or oval, zigzag or straight, or they may be provided with a series of metal fins of various shapes fastened to the outside to increase the radiating surface. These fins are disposed in such a way that the air, passing through the radiator, can carry off the heat radiated from their surfaces, thus helping to cool the tubes and, in turn, the water. The fins are of many shapes, such as plain, round, plain square, corrugated round, etc., or they may be lateral plates or shelves extending across the radiator, according to the ideas of the different designers.

In the cellular type of radiator the hot water delivered at the top of the radiator passes down through a series of narrow spaces or interstices formed around the outside

of what are in effect horizontally disposed tubes. These tubes may be round, hexagonal, octagonal, or square in section, and they are usually arranged in horizontal layers, the joints of one layer being staggered with reference to the joints in the layers above and below.

From the bottom of either of these types of radiators, the water is returned to the jackets of the engine, either by the thermo-syphon or pump system.

Lubrication

* Lubrication of gasoline truck engines falls naturally into three classes:

(a) Splash lubrication, accomplished by the crank shaft ends of the connecting rods splashing in a reservoir of oil in the bottom of the crank case. This splashes the oil on the inside of the cylinders and on the bearings.

(b) Force feed, in which system the oil is pumped under considerable pressure to the main bearings and is distributed from them by centrifugal force to the connecting rod bearings, etc.

(c) Combination systems, where part of the lubrication is accomplished by force feed and the balance by splashing.

Cylinders

Cylinders of internal combustion engines are made in a number of different forms:

(1) Each cylinder is cast and machined separately and then the desired number of cylinders are bolted to the crank case.

(2) The cylinders are cast in pairs, and these pairs after suitable machining are fastened to the crank case.

(3) The entire number of cylinders are cast in one block; this is termed "en bloc." Either of these types of cylinders may be cast with the head or top integral, or, with that part of the cylinder which is above the top of the piston in its highest position a separate casting. The separate or detached head is a convenience for cleaning out carbon, etc.

Cylinders are of three general types:

(a) T-head, in which the exhaust valves are on one side of the engine and the intake valves on the opposite side.

(b) L-head, in which the exhaust and intake valves are located on the same side of the engine.

(c) Overhead valve engines, in which both the exhaust and intake valves are located in the cylinder head. In this type the cylinder head is usually of the detachable type.

Valves

Valves of internal combustion engines are of three principal types: poppet, rotary and sleeve valves. The poppet type is the one generally used in the motor truck engines. Rotary valves consist of a rotary disc—a section of a cone or of a cylinder, having suitable apertures or openings so arranged that when revolved they will register with other apertures in the cylinder proper, and thus control and regulate the flow of fresh gas into, and of burnt gases from, the cylinder.

Sleeve valves are made of one or more thin-walled cylinders or tubes interposed between the piston and the cylinder wall. Apertures are arranged in these sleeves in such a way that as the sleeves are moved they will register with corresponding apertures or ports in the cylinder walls, thus regulating the flow of fresh gas into, and burnt gas from the cylinder. The sleeve, or sleeves, actuated by suitable cams or other mechanism, have an up-and-down, or a rotary movement in order to secure this periodical regis-

tering of the valve apertures with ports in the cylinder walls.

Pistons

Pistons used in gasoline motor truck engines are usually made of a special grade of cast iron although in some cases various aluminum alloys have been used; steel pistons have also been used.

Wrist pin bearings, or bearings at the piston end of the connecting rods, are of two types. In one the wrist pin is clamped to the piston, the connecting rod bearing being free, or it may be clamped to the wrist pin end of the connecting rod, the actual bearing then being in bosses in the piston. The second type employs a floating pin which has a bearing in both the wrist pin end of the connecting rod and the bosses of the piston. In this latter type the wrist pin proper is prevented from moving endwise and scoring the cylinder walls by a pair of plugs which fit into the bosses of the piston and bear against the cylinder walls.

Crank Shafts

Crank shafts for nearly all gasoline truck engines are of the four-throw type. A bearing is provided at a proper distance from the center line of the crank shaft for the big end bearing of the connecting rod for each of the four cylinders. These crank shafts may have two or more main bearings in which the crank shaft rotates. The number of main bearings is regulated by several factors, including the bore and stroke of the engine, the length between main bearings, the size of the crank shaft, and the design.

The crank shaft of an engine functions to translate the power of the reciprocating parts—pistons—to rotary power at the fly-wheel. The crank shaft is required to do a large amount of work, and the material of which it is composed is subjected to heavy stresses. For this reason it must be of ample size, of proper material, and properly heat-treated.

The material at the bearing surfaces (both main and connecting rod) must be fine grained, that it may be ground exactly true and be polished. At these bearing places the metal must also be hard to resist wear. For these reasons, it is necessary that the crank shaft be heat-treated in such a manner as to insure these qualities; that is, it must have strength and rigidity throughout to minimize vibration, and it must have hardness to resist wear.

Carburetors

The carburetor is a device for minutely dividing or atomizing the liquid fuel (gasoline, benzine, kerosene, etc.),

and at the same time adding to it the proper quantity of air to secure combustion in the cylinders. Ordinarily, carburetors are arranged to control the total amount of this mixture of air and gasoline which is allowed to flow to the cylinders per second or per minute, the throttle being usually under the control of the operator of the truck or car.

Throttles

Throttles are made in three principal types:

(1) Butterfly valve, which consists of a metal disc placed within the path of flow of the gasoline mixture at the throat of the carburetor. This disc is arranged to be revolved at right angles to the path of flow of the gasoline mixture, in a manner similar to the damper in a stove pipe or flue.

(2) Barrel type; i.e., a cylinder or barrel provided with suitable apertures, so that rotating the barrel changes the sizes and shapes of the orifice through which the gases are to flow on their way to the cylinder.

(3) Diaphragm types are arranged to provide an approximately circular orifice of variable area, somewhat like the expanding shutter of a camera.

Ignition

Ignition: The charge of gasoline vapor or mixture of gasoline and air, after it has been drawn into the cylinder and compressed to a suitable point, is exploded or ignited by an electric spark. The energy for the spark is produced either by a magneto, which is a permanent magnet dynamo of small current but high voltage, or by a spark coil. In the latter, the current furnished by the low voltage of the storage battery energizes one winding (the primary) of a coil. The interrupter or timer driven by the engine in exact synchronism, interrupts the current in this primary coil, causing the other winding (secondary) of the spark coil to produce a current of high voltage, but small amperage, in many respects similar to the current produced by the magneto. The cylinders of a gasoline engine are provided with one or more spark plugs, usually one, the function of which is to receive this high voltage, small current discharge from the magneto or from the spark coil, and to cause this current to jump or bridge the gap maintained at the points of the spark plug inside of the cylinder, thus causing the ignition of the compressed charge of gasoline vapor.

Principles of Motor Truck Selection

There are approximately 975,000 motor trucks in the United States, representing an investment of nearly \$2,000,000,000. These trucks, operating at an average of 25 mi. per day, have a potential carrying capacity of 10,000,000,000 ton-miles a year. It is estimated that in ten years there will be 5,000,000 motor trucks in operation, with a potential carrying capacity of 53,000,000,000 ton-miles.

The motor truck buyer should be cautious in his selection of motor truck equipment, that he may be assured of its dependability and of the permanency of his investment. Conflicting theories of design and construction should have little direct bearing on motor truck selection because the motor truck industry is not agreed as to what constitutes the best design or practice or regarding the selection of metals and assembling of different parts.

In offering his product for consideration, the truck manu-

facturer should not only be confident that his equipment and organization fulfill the exacting requirements of the service, but he should establish his ability to assume the moral obligations which the continuation of the service and the nature of the business entails. In order to do this he should submit to the attention of the purchaser evidence as to his qualifications on the following points:

1. His financial standing and responsibility as a manufacturer.
2. The general reputation of the company as a sound business organization.
3. The experience behind the product and the extent of manufacturing facilities.
4. The responsibility of the maker as regards design and construction of the component parts of his truck with assurances in the matter of future service.

5. The purchaser should be secure in his investments from the effects of instability in price, due to other reasons than normal variations in the general cost of production.

6. Manufacturing methods and factory equipment should be such as to insure the purchaser that the trucks are economically and substantially built.

7. The quality of the equipment should be reflected in a reliable and comprehensive record of performance in service.

8. Of paramount importance is the adequacy and per-

manency of service facilities, both as regards organization and parts and the purchaser should know that parts always will be available regardless of any modifications or changes in design which may occur at some future date.

These considerations outweigh any other of a technical nature, and it is only by being satisfied on these points that the purchaser can be confident that the trucks offered will assure him against loss in value of investment and against high operating expense with its corresponding decrease in transportation profits.

Factors of Motor Truck Performance

Motor truck performance is affected by a number of factors which vary according to the "characteristics of service" under which the vehicles operate and with the locality where they are applied. Consequently in the selection and application of motor trucks it is desirable that the full weight of these factors be given proper consideration in order that the type of equipment best suited to the purpose may be employed.

The characteristics of service in motor vehicle operation are the elements of time as affected by length of haul, road conditions, tractive resistance, topography of the country, peculiarities of distribution, operation organization, type of equipment, average speed of operation, limitation of speed, traffic congestion, frequency of stops, duration of time consumed per stop, and the available time in a working day. All of these bear more or less upon the problem of successful motor vehicle application.

Length of Haul

Distance of haul will vary according to the nature of the work. Consequently the gross tonnage which it is possible to move in the time available in a working day depends upon distance, other factors remaining constant. This distance factor may also limit the operation in such a manner as materially to affect the efficiency or ratio of performance. For example, under certain time elements for loading, unloading and running, and under certain road conditions and restrictions of design, a 5-ton truck might be able to make three round trips of 20 miles each in a 9-hour day, consuming for each trip a matter of 2½ hours or for the three, 7½ hours. One and one-half hours would then be available which could not be utilized for the same work, since it is not enough for another trip. Consequently the truck performance would show a gross efficiency in time utilization of 83½ per cent. It is conceivable that for other distances this efficiency might be reduced to 55 per cent or 60 per cent.

Road Conditions

Road conditions affect performance, both as regards speed and cost of operation, varying in its restrictions according to the nature and condition of the road surface and the kind of material of which the roads are constructed. It is quite obvious that the same average vehicle speed cannot be maintained on cobblestone streets as is possible when running on a smooth asphalt pavement, nor do the same characteristics of performance apply to an asphalt road as to a sandy one.

Tractive Resistance

Tractive resistance is affected by the nature of the material of which the roads are constructed. Different types of roads present different values of resistance to motion,

which values are usually expressed in pounds pull per ton of weight and represent the power required to move the vehicle along the road. These values vary widely with the different types of road or surface from 5 lb. to 9 lb. per ton on steel rails to from 200 lb. to 400 lb. on loose sand roads. The values used for the different roads are as follows:

	Pound Per Ton
Concrete, dry	28 to 30
Asphalt, dry	30 to 40
Concrete base with asphaltic oil and screenings	45 to 55
Water-bound macadam, good condition, dry....	64 to 70
Gravel road in good condition, dry	75 to 85
Earth road, fine dust top, dry.....	90 to 100
Earth road, stiff mud on top	200 to 250
Loose gravel, not packed, new road.....	250 to 275
Sand	200 to 400

Topography

The topography of the country limits the time and speed elements of motor vehicle operation as well as the maximum load carrying ability of the truck, the extent of this influence depending upon the frequency and length of grades and their steepness. Grades also have a direct bearing upon the cost of operation because of the greater horsepower or expenditure of energy required to move the mass of vehicle and load on grades. This is reflected in increased fuel consumption and maintenance.

Distribution

Peculiarities of distribution are factors which vary according to the nature of the business in which the trucks are employed and the type of service which must be rendered. These peculiarities directly affect the size or load-carrying capacity of the trucks as well as their dispatching and operation. It is because of these peculiarities that different sizes of trucks are manufactured.

Operating Organization

The operating organization may embrace both shipping and delivery departments, such as are employed in large retail establishments, an entire organization like the express companies, or one man, who performs all of the duties attending the necessary delivery or trucking.

Equipment

The type of equipment is a matter of application to the needs of the business and the characteristics of service, and consequently will vary as to size, body dimensions, tire equipment, gear ratios, routing and dispatching.

Speed of Operation

The average speed of operation is a controlling factor, dependent upon the influence and operation of the other

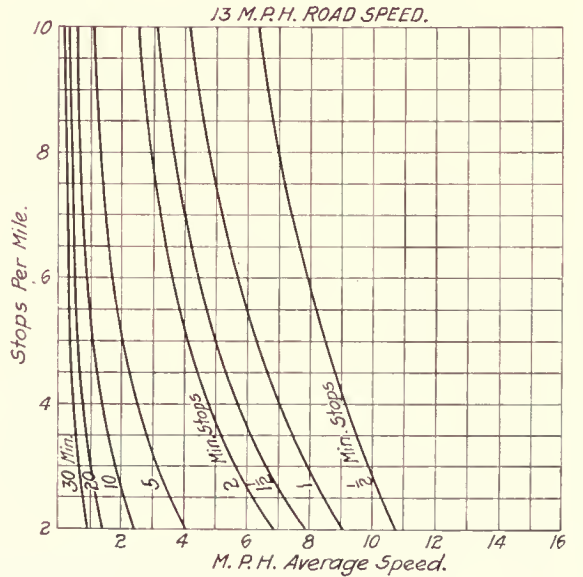
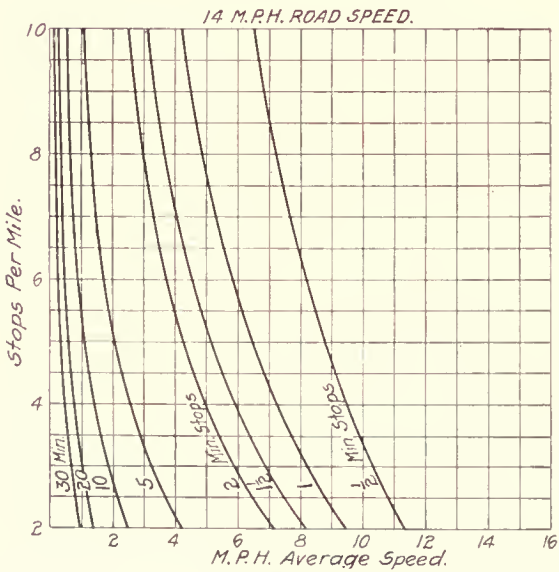
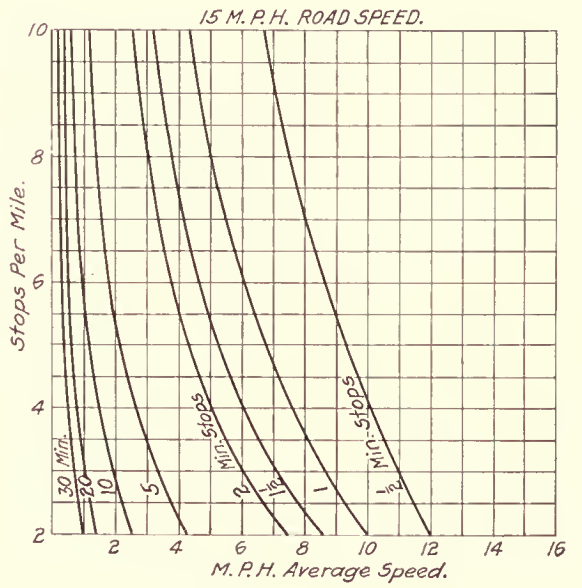
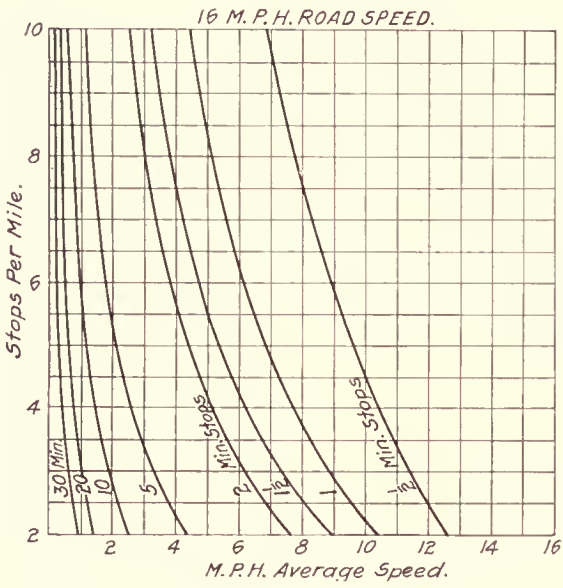
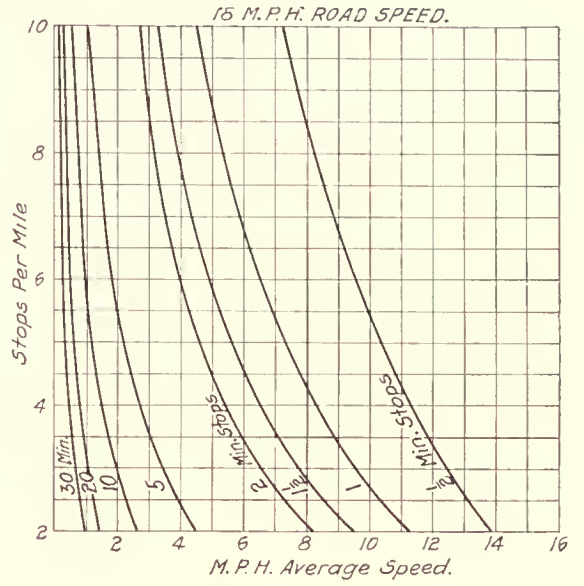
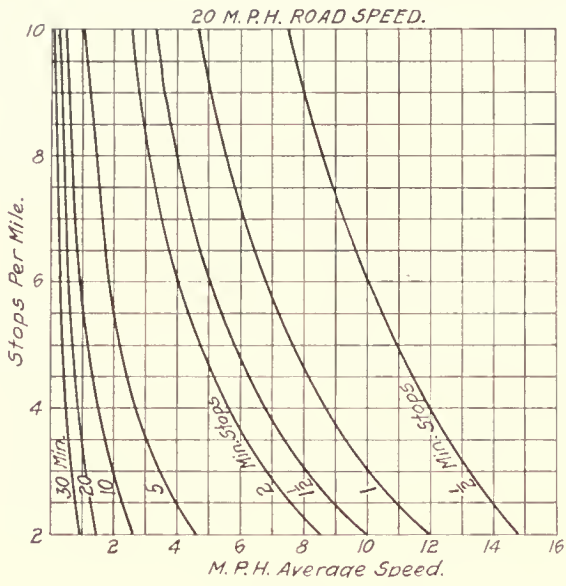

Effect of Frequency and Length of Stops on Average Vehicle Speeds

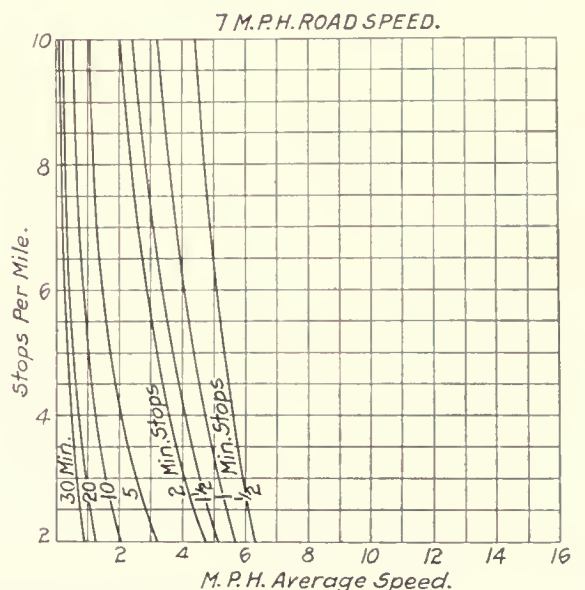
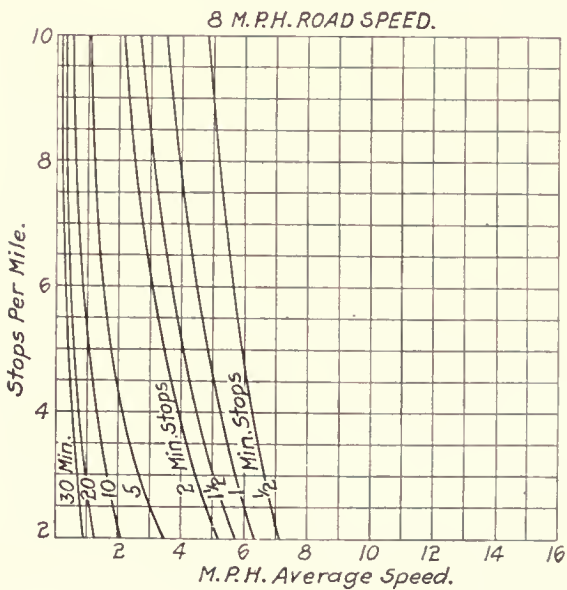
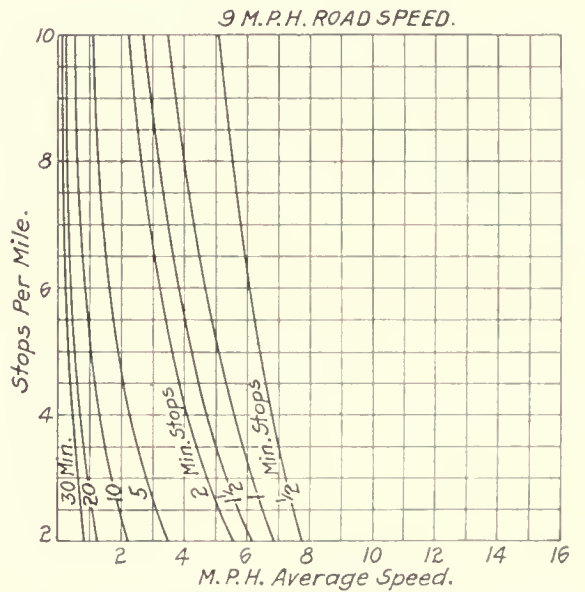
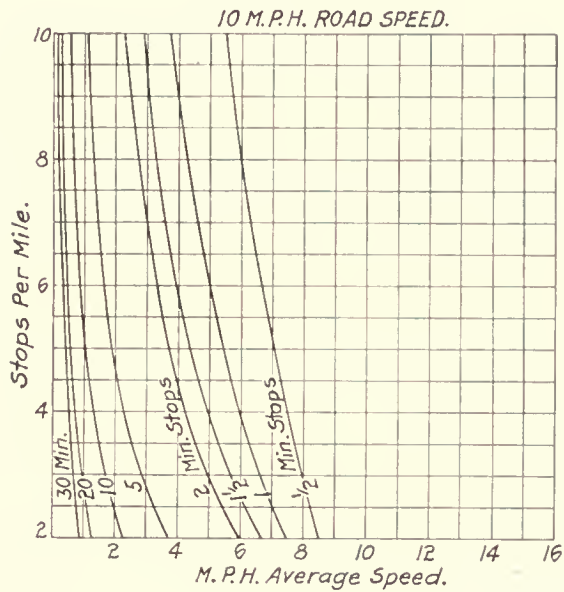
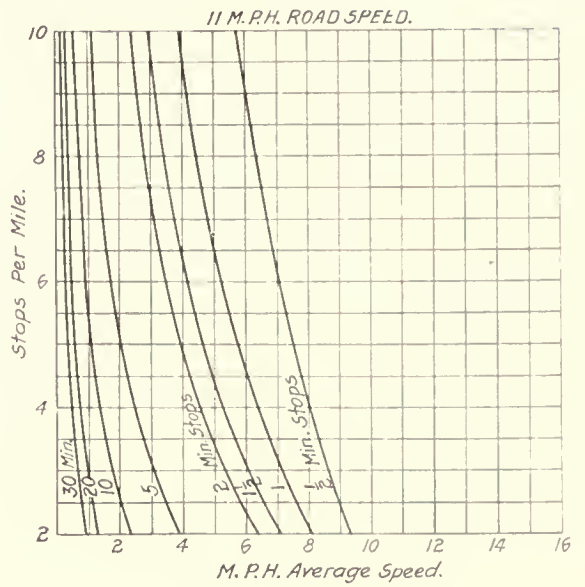
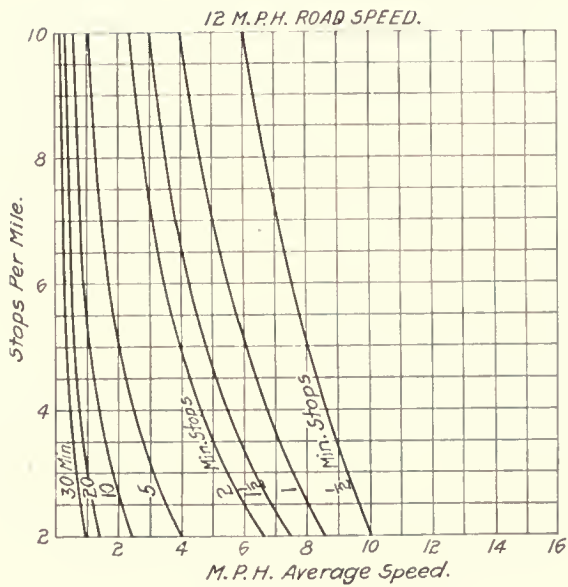

Effect of Frequency and Length of Stops on Average Vehicle Speeds

MOTOR TRUCKS, TRACTORS AND TRAILERS

Column		A	B	C	D	E	F	G	H	I	J	K	L	M	N	O	P	Q	R	S	T	
Line	Miles		Total Time in Minutes Consumed per Round Trip for Loading and Unloading																			
	One Way Trip	Round Trip	2	4	6	8	10	12	14	16	18	20	22	24	26	28	30	35	40	45	50	60
1	1/2	1	60	48	40	34	30	27	24	22	20	18	17	16	15	14	13	11	10	9	8	7
						4		-6		-4			4			4	12	29	20	21	32	14
2	1	2	34	30	27	24	22	20	18	18	16	15	14	13	12	12	11	10	9	8	7	6
			4		-6		-4		-8	-6			4	12	24		18	10	12	24	46	48
3	1 1/2	3	24	22	20	18	18	16	15	14	13	12	12	11	11	10	10	9	8	7	7	6
				-4		-8	-6			4	12	24		18	-4	20		3	16	29	4	12
4	2	4	18	18	16	15	14	13	12	12	11	11	10	10	9	9	9	8	7	7	6	5
			-8	-6			4	12	24			18	-4	20		30	12	6	8	32	-3	36
5	2 1/2	5	15	14	13	12	12	11	11	10	10	9	9	9	8	8	8	7	7	6	6	5
				4	12	24		18	4	20		30	12	-6	32	16		25	10	30		30
6	3	6	12	12	11	11	10	10	9	9	9	8	8	8	7	7	7	6	6	6	5	5
			24		18	-4	20		30	12	-6	32	16		46	32	18	54	24	-6	50	
7	3 1/2	7	11	10	10	9	9	9	8	8	8	7	7	7	7	7	6	6	6	5	5	4
			-4	20		30	12	-6	32	16		46	32	18	4	-10	48	18	-12	45	18	72
8	4	8	9	9	9	8	8	8	7	7	7	7	6	6	6	6	6	5	5	5	5	4
			30	12	-6	36	16		46	32	18	4	-10	48	36	24	12	65	40	15	-10	48
9	4 1/2	9	8	8	8	7	7	7	7	7	6	6	6	6	6	6	5	5	5	5	4	4
			32	16		46	32	18	4	-10	48	36	24	12		-12	60	35	10	-15	64	24
10	5	10	7	7	7	7	6	6	6	6	6	6	6	5	5	5	5	5	4	4	4	4
			46	32	18	4	-10	48	36	24	12		-12	60	50	40	30	5	80	60	40	
11	5 1/2	11	7	7	6	6	6	6	6	6	5	5	5	5	5	5	5	4	4	4	4	3
			4	-10	48	36	24	12		-12	60	50	40	30	20	10		76	56	36	16	102
12	6	12	6	6	6	6	5	5	5	5	5	5	5	5	4	4	4	4	4	4	4	3
			36	24	12		-12	60	50	40	30	20	10		-10	80	72	52	32	12	-8	84

8-Hour Day--Running Speed 10 M. P. H.

Column		A	B	C	D	E	F	G	H	I	J	K	L	M	N	O	P	Q	R	S	T	
Line	Miles		Total Time in Minutes Consumed per Round Trip for Loading and Unloading																			
	One Way Trip	Round Trip	2	4	6	8	10	12	14	16	18	20	22	24	26	28	30	35	40	45	50	60
1	1/2	1	65	53	43	36	32	28	25	23	21	19	18	16	15	14	13	12	10	9	8	7
			5	3	7	12	0	4	5	-3	-3	10	-6	16	15	18	25	0	30	30	40	25
2	1	2	40	34	30	27	24	24	20	18	17	16	15	14	13	12	12	10	9	8	8	7
				4		-6		-4		12	4			4	12	24		30	30	40		-10
3	1 1/2	3	28	25	23	21	19	18	16	15	14	13	13	12	11	11	10	9	8	8	7	6
			4	5	-3	-3	10	-6	16	15	18	25	-1	12	29	7	30	30	40		25	30
4	2	4	24	20	18	17	16	15	14	13	12	12	11	11	10	10	9	8	8	7	7	6
			-4		12	4			4	12	24		18	-4	20		30	40		25	-10	
5	2 1/2	5	18	16	15	14	13	13	12	11	11	10	10	10	9	9	8	8	7	7	6	5
			-6	16	15	18	25	-1	12	29	7	30	10	-10	21	3	40		25	-10	30	55
6	3	6	15	14	13	12	12	11	11	10	10	9	9	9	8	8	8	7	7	6	6	5
				4	12	24		18	-4	20		30	12	-6	32	16		25	-10	30		30
7	3 1/2	7	13	12	11	11	10	10	10	9	9	8	8	8	7	7	7	6	6	6	5	5
			-1	12	29	7	30	10	-10	21	3	40	24	8	53	39	25	-10	30		55	5
8	4	8	11	11	10	10	9	9	9	8	8	8	7	7	7	7	6	6	6	5	5	4
			18	-4	20		30	12	-6	32	16		46	32	18	4	-10	30		55	30	80
9	4 1/2	9	10	10	9	9	8	8	8	7	7	7	7	6	6	6	6	5	5	5	5	4
			10	-10	21	3	40	24	8	53	39	25	11	-3	54	42	30		55	30	5	60
10	5	10	9	9	8	8	8	7	7	7	7	6	6	6	6	6	5	5	5	5	4	4
			12	-6	32	16		46	32	18	4	-10	48	36	24	12	0	55	30	5	80	40
11	5 1/2	11	8	8	7	7	7	7	7	6	6	6	6	6	6	5	5	5	5	4	4	4
			24	8	53	39	25	11	-3	54	42	30	18	6	-6	65	55	30	5	80	60	20
12	6	12	7	7	7	7	6	6	6	6	6	6	6	5	5	5	5	4	4	4	4	4
			46	32	18	4	-10	48	36	24	12		-12	60	50	40	30	5	80	60	40	

8-Hour Day--Running Speed 12 M. P. H.

Tables Showing Number of Trips Per Day

Column			A	B	C	D	E	F	G	H	I	J	K	L	M	N	O	P	Q	R	S	T
Line	Miles		Total Time in Minutes Consumed per Round Trip for Loading and Unloading																			
	One Way Trip	Round Trip	2	4	6	8	10	12	14	16	18	20	22	24	26	28	30	35	40	45	50	60
1	2	1	85	66	54	45	40	35	31	28	26	24	22	20	19	18	17	15	13	12	11	9
			5	6	5	5		5	11	12	2		6	20	11	6	5		15		-5	15
2	1	2	50	43	38	33	30	27	25	23	21	20	19	18	16	16	15	13	12	11	10	8
				-2	-8	6		6		2	12		-8	-12	24	-8	15		-5			40
3	1 1/2	3	35	31	28	26	24	22	20	19	18	17	16	15	14	14	13	12	11	10	9	8
			5	11	12	2		6	20	11	6	5	8	15	26	-2	15		-5		15	
4	2	4	27	25	23	21	20	19	18	16	16	15	14	13	13	12	12	11	10	9	8	7
			6		2	12		-8	-12	24	-8		12	28	2	24		-5		15	40	40
5	2 1/2	5	22	20	19	18	17	16	15	14	14	13	12	12	11	11	11	10	9	8	8	7
			6	20	11	6	5	8	15	26	-2	15	36	12	39	17	-5		15	40		5
6	3	6	19	18	16	16	15	14	13	13	12	12	11	11	10	10	10	9	8	8	7	6
			-8	-12	24	-8		12	28	2	24		28	6	40	20		15	40		40	60
7	3 1/2	7	16	15	14	14	13	12	12	12	11	11	10	10	10	9	9	8	8	7	7	6
			8	15	26	-2	15	36	12	39	17	-5	30	10	-10	33	15	40		40	5	30
8	4	8	14	13	13	12	12	11	11	10	10	10	9	9	9	8	8	8	7	7	6	6
			12	28	2	24		28	6	40	20		42	24	6	56	40		40	5	60	
9	4 1/2	9	12	12	11	11	11	10	10	10	9	9	8	8	8	8	8	7	7	6	6	5
			36	12	39	17	-5	30	10	-10	33	15	64	48	32	16		40	5	60	30	75
10	5	10	11	11	10	10	10	9	9	9	8	8	8	8	8	7	7	7	6	6	6	5
			28	6	40	20		42	24	6	56	40	24	8	-8	54	40	5	60	30		50
11	5 1/2	11	10	10	10	9	9	8	8	8	8	8	7	7	7	7	7	6	6	6	5	5
			30	10	-10	33	15	64	48	32	16		61	57	33	19	5	60	30		75	25
12	6	12	9	9	9	8	8	8	8	8	7	7	7	7	7	6	6	6	6	5	5	5
			42	24	6	56	40	24	8	-8	54	40	26	12	-2	72	60	30		75	50	

10-Hour Day—Running Speed 12 M. P. H.

Column			A	B	C	D	E	F	G	H	I	J	K	L	M	N	O	P	Q	R	S	T
Line	Miles		Total Time in Minutes Consumed per Round Trip for Loading and Unloading																			
	One Way Trip	Round Trip	2	4	6	8	10	12	14	16	18	20	22	24	26	28	30	35	40	45	50	60
1	1/2	1	100	75	60	50	43	37	33	30	27	25	23	21	20	19	17	15	13	12	11	9
							-2	8	6		6		2	12		-8	12	15	28	12	6	24
2	1	2	60	50	43	37	33	30	27	25	23	21	20	19	18	16	15	14	12	11	10	9
					-2	8	6		6		2	12		-8	-12	24	30	-2	24	17	20	-12
3	1 1/2	3	43	37	33	30	27	25	23	21	20	19	18	16	15	15	14	13	11	10	9	8
			-2	8	6		6		2	12		-8	-12	24	30		12	-11	28	30	42	24
4	2	4	33	30	27	25	23	21	20	19	18	16	15	15	14	13	13	11	10	10	9	8
			6		6		2	12		-8	-12	24	30		12	28	2	39	40	-10	16	-8
5	2 1/2	5	27	25	23	21	20	19	18	16	15	15	14	13	13	12	12	11	10	9	8	7
			6		2	12		-8	-12	24	30		12	28	2	24		5		15	40	40
6	3	6	23	21	20	19	18	16	15	15	14	13	12	12	11	11	10	9	8	8	7	6
			2	12		8	-12	24	30		12	28	2	24		28	6	10	24	48	8	12
7	3 1/2	7	20	19	18	16	15	15	14	13	13	12	12	11	11	10	10	9	8	8	7	6
				8	-12	24	30		12	28	2	24		28	6	40	20	33	56	16	45	72
8	4	8	18	16	15	15	14	13	13	12	12	11	11	10	10	10	9	9	8	7	7	6
			-12	24	30		12	28	2	24		28	6	40	20		42	-3	24	61	26	48
9	4 1/2	9	15	15	14	13	13	12	12	11	11	10	10	10	9	9	9	8	8	7	7	6
			30		12	28	2	24		28	6	40	20		42	24	6	32	-8	33	-2	24
10	5	10	14	13	13	12	12	11	11	10	10	10	9	9	9	8	8	8	7	7	6	6
			12	28	2	24		28	6	40	20		42	24	6	56	40		40	5	60	
11	5 1/2	11	13	12	12	11	11	10	10	10	9	9	9	8	8	8	8	7	7	6	6	5
			2	24		28	6	40	20		42	24	6	56	40	24	8	57	22	66	36	80
12	6	12	12	11	11	10	10	10	9	9	9	8	8	8	8	7	7	7	6	6	6	5
				28	6	40	20		42	24	6	56	40	24	8	-8	54	19	72	42	12	60

10-Hour Day—Running Speed 15 M. P. H.

Tables Showing Number of Trips Per Day

characteristics of service enumerated. This average speed is affected by the limitation of speed as influenced by design, traffic congestion, frequency of stops, and the duration of time consumed per stop.

The effect of these elements is graphically presented in the charts compiled for running vehicle speeds of 20, 18, 16, 15, 14, 13, 12, 11, 10, 9, 8 and 7 miles per hour. These road speeds are the average speeds which the vehicle maintains when it is actually rolling. The charts present a series of curves, each one representing the average length of stop in minutes, as shown (i. e., 1-minute stop, 1½-minute stop, etc.). The horizontal scale shows the average speed in miles per hour including stops, and on the vertical divisions the average number of stops per mile for each mile of vehicle operation is shown. The charts are shown on pages 564 and 565.

To illustrate the manner in which these charts may be used, let us assume characteristics of service and the use of a vehicle which will permit of an average road speed of 20 m.p.h. Refer to the chart marked, "20 Miles Per Hour Road Speed." If the service under consideration requires an average of six stops per mile and the duration of each stop averages one minute, we will find that the average speed of the vehicle in this service will be 6.4 m.p.h. This is arrived at by observing the position of the point where the horizontal line extending from the figure 6 on the perpendicular scale marked "Stops Per Mile" intersects the curve marked "One Minute Stops," and by dropping from this point to the horizontal scale marked "M.P.H. Average Speed." In like manner, the average speed in miles per hour can be obtained for any average number of stops per mile and for the duration or length of stops as indicated on the individual curves in each chart.

In the use of these charts it must be borne in mind that the road speed in miles per hour as given represents the actual speed of the vehicle when rolling, and is not to be taken as the maximum available speed. For purposes of general calculation, the average speed may be considered as representing approximately 70 per cent of the maximum vehicle speed performing under normal operating conditions. The maximum available speed is a factor of truck design and is controlled by the engine speed, gear reduction and total wheel diameter as described in the section covering design and construction.

Time Elements

Time and distance as limiting factors control the amount of work which a motor truck can do in a given number of hours. Time consumed per trip in running depends upon the length of haul and the average speed of operation, the latter being governed by road and traffic conditions, as has been described.

Time employed in loading and unloading is a factor which largely controls the efficiency of operation, and time, as the hours available for operation in a full day's work, is the

measure of gross performance. Consequently, close observation and control of the time elements will materially increase the efficiency of truck operation and reduce per unit costs of transportation.

Similarly, a knowledge of the time elements involved will enable the truck operator to predetermine the service and arrange operating schedules. Therefore, if we reduce the time and distance factors to averages, it should be easy to determine the performance to be expected from motor truck operation under the average time elements for loading, unloading and running, and with the available time in a normal working day.

The effect of time elements is shown in the tables on pages 566 and 567, which show the number of trips of varying distances possible in an eight-hour and ten-hour day, under varying time elements for average speeds of 10 and 15 m.p.h. From the method used and the description that follows, however, other results can be readily estimated for conditions, including different lengths of day, loading and unloading times, and speeds.

The tables are arranged as a series of columns (identified by index letters) each of which applies to different average time elements in minutes for loading and unloading per round trip of truck operation. For example, column A applies to a time element of 2 minutes consumed in these operations, while column T applies to 60 minutes consumed for loading and unloading. The columns are intersected by lateral lines (indexed by number), which apply to the length of haul in miles for one way and the round trip distance as given. The rectangles formed by the intersecting columns and lines are arranged in three divisions in which appear certain figures designating factors according to their relative position in the rectangles. The figures in the upper left-hand divisions of the rectangles show the number of trips which can be made under the time elements for loading and unloading, and for the distance given within the length of day and at the average speed in m.p.h. stated. The figure of the lower section of the rectangles is the number of minutes remaining in the day's time which are unused in the number of trips shown. The figures in the upper right-hand sections of the rectangles are the line index figures for the number of miles in a single trip for the same loading and unloading time, which can be made in the remaining time set forth in the lowest section of the rectangles.

To illustrate the method of using these tables refer to the table which shows the performance in an 8-hour day at 10 miles per hour. Assume that the distance of haul is 2½ miles one way, and the time required for loading and unloading is 16 min. per trip. By observing the figures in the rectangle formed by the intersection of column "H" (16 min.), and line number 5 (2½ mi.) we find that in an 8-hour day the truck can make 10 round trips. Twenty minutes will remain, and in these twenty minutes, as indicated by the line index, a 1-mile single trip can be accomplished under the same time-loading factors.

Motor Truck Applications

The motor truck may be roughly classified under three general heads: Light delivery in capacities up to one ton, general utility in capacities of 1½ to 2 tons and heavy duty in capacities of 3½ to 7 tons.

Two types of units will be considered, the electric and the gasoline truck. Each is adapted for performing certain duties which it can carry out with more satisfaction and at lower cost than the other. It is profitable to use the gaso-

line truck in suburban or interurban haulage under conditions where high speed is desirable and the distances between stops are comparatively long. The electric truck has proven to be more economical for urban deliveries, where the service includes short hauls and frequent stops. The selection of the proper type and some of the factors which govern this selection are defined in the section on Principles of Selection and Factors Governing Performance.

For convenience, the many forms of trucks are designated under the body types. These types may be grouped under, Open or Express, Stake or Platform, Enclosed or Panel, Dump, Tank, Refrigerator, Construction and special types. All of the above are constructed to be used on the chassis of the truck which uses either the electric motor or gasoline engine as a power unit, with the exception of the tank body, which is generally used with the gasoline engine truck.

Each of these body types may have many modifications in form of construction, size, shape and capacity, which makes it applicable for hauling a particular kind of commodity. Each of these forms is best suited to a certain application, depending upon the class of commodity and conditions surrounding the installation. For instance, the platform type can be used to best advantage for hauling heavy boxes and crates, the dump body for loose material such as coal, the tank body for liquids such as oil and water.

Rural and Inter-City Express

More than 600 rural motor express lines are now in operation, enabling farmers to remain on the farm instead of spending much of their time in marketing their produce. It has been estimated that an efficient truck line saves the work of one man and one horse to each farm, increases the food supply by furnishing regular transportation of farm products, stimulates the efforts of farmers by the knowledge that such transportation is available, enables the farmer to obtain goods from town on the day of order and facilitates traffic between farmer, market and consumer.

The general plan of operation is similar for most lines. Trucks are sent out daily from central points on regular schedules and over prescribed routes of from 15 mi. to 100 mi. and more. From farm to city they carry fruit, vegetables, dairy products, eggs, grain and live stock; from city to farm they carry merchandise, farm implements, meats, canned goods and seed; along the route they pick up and drop all kinds of merchandise.

Intra-city shipping by truck, commonplace even before the railroads began to falter under their burden, was stimulated in the spring of 1920 by the strike of railway switchmen. Motor caravans undertook hauls that increased in distance as they multiplied in number, until numerous instances had been recorded where 1,000 miles were negotiated in single trips.

Logging and Lumber

Through its established ability to save time, men and money, the motor truck has made its place in the logging and lumber industry. The truck with the platform body is used for this service. In many places the motor truck is to be found skidding green logs in the timber, toiling in mill yards, and delivering finished lumber through the streets.

Motor trucks haul the green logs from the timber to the mills or rail sidings. They form a dependable supply line between isolated camps and the nearest towns. Frequently they are used in building the roads that make cutting operations practical.

Often they transport material for dams, that sufficient water may be collected for log floating.

Trucks haul green cut lumber from the saw mill to air dry yards, kilns or sidings, and later to planing mills. They deliver slabs, sawdust and shavings for use as fuel. They transport hewed or sawed stock, such as ties, mine props,

mine timbers, posts, poles and bridge material. They haul short dimensions stock, such as shooks, tight and slack cooperage, veneers, vehicle materials, lath, shingles and the like.

Maximum efficiency in a logging fleet is obtained when at least one of every two trucks is winch-equipped. The versatility of the winch-equipped truck means dollars to the logging man, for the truck does much more than haul. For instance, three yoke of oxen and five men will load 14 average-sized logs upon a truck in 60 min to 70 min. The winch-equipped truck, with two men, will load an equal number of logs in 20 min., saving 40 min. to 50 min. of time per load.

Truck needs vary in the different cutting fields. Through the West, where the average hauling road is fairly good, where logs are large in diameter and range in length from 16 ft. to 50 ft., the most efficient equipment is a 5-ton truck with a 2-wheel trailer or semi-trailer. In the South, where trees are smaller, but are cut in long lengths, and where roads are not as solid as in the West, 3 to 3½-ton trucks, with trailers where needed, do the best work. In the Eastern and Central sections (including the logging states of Maine, Wisconsin and Minnesota), where logs are cut in shorter lengths and roads are solid, 5-ton trucks operate with maximum efficiency.

Three-quarter and 2-ton trucks are the logical units for supply service. Isolated logging camps find the trucks unfailing links connecting them with the nearest outposts of civilization.

Motor trucks may be used for many hauling jobs at the lumber mills, and they are particularly valuable at distribution centers. Customers are now served at distances not to be considered when reliance for deliveries had to be placed in horses.

In the first place, the trucks with their roller equipment consume a minimum of time in loading. The contrast is even more striking once the load is in motion. Formerly a team of horses, starting on a 16-mile haul, consumed the entire day in completing the round trip. With the advent of motor trucks, one truck, hauling twice as much lumber in a single load as a team of horses, is able to leave an hour later than the horses and still be back in time to make a second trip in the afternoon.

Motor trucks are used in the work of hauling the lumber through the intermediate stages leading up to actual use in a new building, when the manufactured lumber has been distributed to retail dealers throughout the country.

Agriculture

Wherever time and labor-saving machinery has been employed in agricultural operations added profits have been an immediate result. The advent of the motor truck was no exception. Farmers who early became motor truck owners and users soon found they could transport more produce in less time and at lower cost, which is but another way of saying that they were saving money. Ninety per cent of the farmers who replied to a questionnaire sent out by the Department of Agriculture designated "time-saving" as the biggest advantage to them of their motor trucks.

The increasing number of farmers who own motor trucks is testimony to the ability of the motor carrier to add to the profits of the farmer through dependable and economical performance of a multitude of duties, ranging from the transportation of farm crops, live stock, garden produce, fruit, berries, eggs, poultry, milk and other dairy products



Typical Motor Trucks. Fig. 1—Novel Method of Car Loading; Fig. 2—Dump Body, Lever Operated; Fig. 3—Oil Tank Truck; Fig. 4—Motor Sprinkler; Fig. 5—Dump Body, Hoist Operated; Fig. 6—Handling Barrels; Fig. 7—Handling Fruit; Fig. 8—Handling Grain

to market, to the carrying of farm laborers to and from places where they are needed, and the pulling of drags and other road machinery.

It has been estimated that more than 78,000 motor vehicles are being used by American farmers. The figures indicate that the farmer, as a class, is the largest user of the motor truck.

The computed average saving of the motor truck over the cost of horse haulage is 56 per cent. The mileage-life of quality trucks is unmeasured. Many have covered 100,000 to 300,000 miles in from five to nine years of service. Motor trucks enable the farmer to dispense with horses for road-hauling and to keep them on the farm, where they are most useful.

Tasks on the farm can be performed with fewer laborers when motor trucks are sharing the burden. It requires only a few minutes each day to keep a good motor truck in efficient working condition, whereas the care of horses consumes considerable time; hours of work make no difference to a motor truck, but the overworking of horses one day means less work from them on the following day; extremes of heat or cold have little effect on truck operation, but they seriously reduce the efficiency of horses.

Motor trucks with convertible bodies are easily adapted to almost any kind of farm work.

Textiles

Transportation in the textile field covers a wide range of haulage. A single establishment often has problems of light and heavy loads, indoor and outdoor trucking, long and short hauls, materials in packages and bulk.

Motor trucks, through their ability to do better hauling at lower cost over a long period of years, are solving the problems of delivering raw materials for shipment to the mills, of hauling it when it arrives, of moving it through various stages of manufacture, and delivering the finished product to warehouses and freight depots.

Trucks are being used to haul general supplies, bales of cotton and other raw materials, if not delivered by railroad directly to the warehouses; to haul cotton to picker rooms; to transport the cotton, after it has been spun into yarn; to transfer woven goods to bleacheries, dye houses or finishing departments, and from there to other departments, and finally to the warehouses, and perhaps later to the freight houses; to haul barrels of dye and bleaching material to storehouses and from there to dye houses or bleacheries; to haul materials for shipping boxes to shops, and from there, as boxes, to finishing rooms and shipping departments; to move lumber to various places around mills where repairs are going on; to haul coal, ashes and machinery.

Many Southern cotton manufacturers have lowered their transportation cost by utilizing the big-load motor truck for their short hauls.

Retailers

Nowhere have motor trucks been a more direct influence in building up business than in the closely competitive field of retail merchandising, where friends are won as much by the character of customer service maintained as by the quality and price of merchandise sold. Department stores, furniture, carpet and musical instrument dealers have been enabled by the purchase of good motor trucks to expand strictly local business until today they are serving territories embracing several cities instead of neighborhood districts in single cities. They are making profitable deliveries to points 25, 50 and 100 miles and more distant, thus

developing thousands of customers formerly too remote to reach. The truck with the express type body is used for this service. In addition to making retail deliveries, motor trucks supply transportation service between railroad freight stations and company warehouses, and between warehouses and stores.

Coal and Ice

Cost of coal at the mines is approximately the same for all coal dealers. Freightage is the same. There is little difference in yard expense. It is in delivery efficiency, then, that the dealer has his chief opportunity to increase profits. And it is for delivery efficiency that coal dealers are learning to depend on motor trucks.

Not only does the motor truck, by its speed, increase the dealer's zone of delivery, hence the volume of sales, but during the rush season it is often run 12 to 18 hours a day and may be run 24 hours if necessary.

For this service the motor truck has been successful not only in the long haul, but also in the short haul field, where a single haul is less than three miles for the round trip. This has been made possible by the use of mechanical loading and unloading, thus releasing the truck quickly at both ends of the route. The unloading rear dump body is the one in common use. A single movement of the lever, beside the driver's seat is sufficient to elevate the body to an angle of 45 deg., and in 30 seconds the load can be dumped.

The modern coal plant is equipped with the latest and best machinery for unloading the coal from barges and cars into pockets, from which it is in turn discharged into motor trucks and delivered to the consumer. In the past a customer who ordered five tons received five deliveries of one ton each. Today seven or eight tons are hauled in a single trip, each motor truck delivering as high as 125 tons of coal a day, and with delivery hours much shorter than they were in the days of horse-drawn equipment.

The ease of dumping is one great advantage of the motor truck, since the driver can work as efficiently at the end of a day as at the beginning, and deliveries are not slowed up because the driver is tired.

Where loads of one or two tons capacity are delivered, division boards are placed in the body of the truck and each order is put in its compartment and weighed so as to get the correct weight in each case.

Many large coal companies have been established in which motor trucks are systematically operated. The city is districted into several zones, one coal yard being located as nearly as possible in the center of each of these zones. Trucks work out of the yards in these respective zones, thus eliminating the long hauls that would be necessary if all trucks were loaded at one central yard.

Where coal and ice are handled by the same firm, trucks used for coal delivery in the winter may be used for delivering ice during the summer months.

Municipalities

The comparatively modest installations in numerous medium-sized municipalities, as well as the great fleets employed in metropolitan centers—more than 500 units in some instances—are practical proof of the adaptability of the motor truck to a wide range of work. Whether engaged in the work of road-building, of street sprinkling and flushing, of snow removal, of ash hauling, of garbage collection, all of which are so essential to efficient municipal work, the motor truck is particularly adaptable.

The efficiency of motor equipment in hauling ashes and

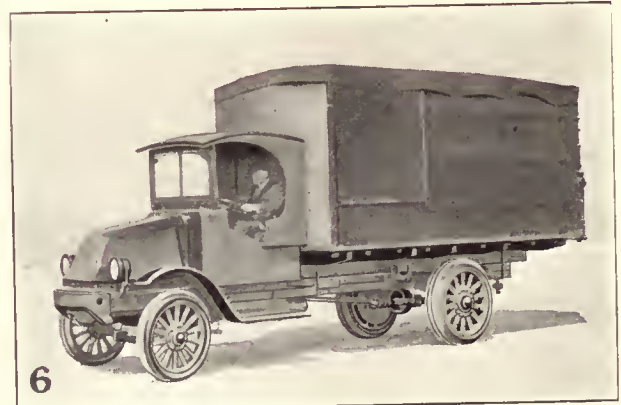
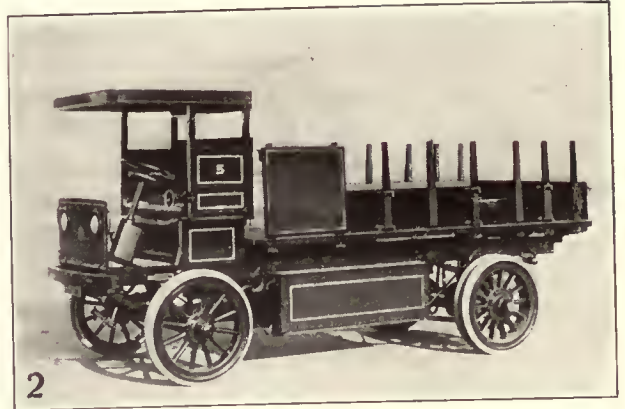
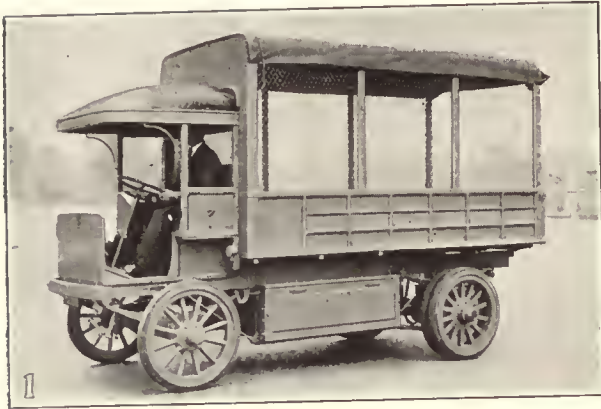

Several Types of Motor Truck Bodies

garbage from residences to municipal dumps and reduction plants has been shown in many cities. The trucks furnished to municipalities are sometimes equipped with removable bodies to permit of their being readily converted into flushers and sprinklers by the substitution of tank bodies to replace the dumping bodies. The trucks participate in all phases of street cleaning work, including the removal of garbage, ashes and snow.

Oil and Rubber

Oil, rubber and automobiles are products each of which has stimulated the demand for the other. Increased production of motor cars and trucks means increased demand for oil and rubber. In turn, increased production of oil and rubber creates the demand for more and more motor trucks to perform the multiplying hauling duties incident to the production and distribution of oil and rubber products.

In both the oil and rubber industries, motor trucks are to be found in installations ranging from a few trucks to great fleets consisting of several hundred units, contending with the severities of the oil fields and rubber plantations at the production end of the industry, or delivering oil and gasoline, rubber tires and manufactured goods at the distribution end.

In the fields where petroleum is produced, motor trucks begin to work the day the decision is made to drill a well. They first haul timber to the location. They haul the boiler, rig, fishing tools and casing. When it is time for the well to be "shot," a motor truck brings the nitro-glycerine. Later the trucks bring tubing, sucker rods and pumping outfits, assist in laying and maintaining the pipe lines which carry the petroleum away, and finally work in and about the refineries and tank farms.

Gasoline and oil, as well as all other petroleum products from the refineries, are shipped by water and rail to many stations in these districts, and from there are transported daily by motor trucks to filling stations, manufacturing plants and to other consumers. Routes average 50 miles for each truck.

Motor trucks fill many hauling needs in the rubber industry. Many trucks are engaged in local hauling between the factory and railroad freight depots, handling incoming fabrics, chemicals, crude rubber and other raw material, and transporting outgoing tires, tubes and other finished products.

Motor trucks operate on schedules over established routes and distribute these products to service stations in their respective territories.

Hauling Food Products

Dealers in groceries, baked goods, meats, vegetables, fruit, produce, ice cream, dairy and other highly perishable food products, appreciate the value of dependable delivery equipment. In this field, unflinching punctuality is a business builder of appreciable power. Under these circumstances, it is not surprising to find the motor truck in increasing demand. Motor fleets, according to the testimony of owners, have stimulated business growth by extending the radius of deliveries and opening avenues to new customers; reducing unnecessary delays, thus insuring the delivery of perishable products in better condition and winning the customer's appreciation and continued patronage; serving more customers in less time on old routes; meeting emergencies and handling rush orders with a minimum of delay and confusion.

Meat packers, dealing in a product that must be distributed with maximum dispatch and minimum handling,

are building up great fleets of motor trucks. Single operators own fleets that range from a few trucks to several hundred units.

Again, in the dairy business, with its possibilities for loss through poor transportation of a perishable product, the motor truck is proving an important factor in producing profits. A truck with the refrigerator type body is used for this service. It hauls milk from farms 60 mi. to 75 mi. distant from the city, and delivers to other units which distribute it. Delivery of baked goods and groceries presents an equally exacting problem. Truck fleets are common in both fields.

Public Utilities

In the building and extending of telephone and telegraph, water, gas, railway, light and power lines, the hauling is heavy and the roads often are bad. But despite these conditions, the hauling unit that serves public utilities companies must be able to go anywhere at any time. In this, as in other exacting work, motor trucks are predominantly used. They have the ability to stand up under hard service, and in almost every phase of work involved in installing and maintaining public utilities they are proving indispensable.

In the installation and maintenance of a telephone system there is a truck adapted to suit almost every operation. For light delivery service, station installation work and small jobs of all kinds, there is the $\frac{3}{4}$ -ton unit. The 2-ton unit is the general utility truck. This truck is the backbone of the maintenance department, carrying all the necessary equipment and men for repair jobs. It is also used for construction work of the heavier type, hauling cross-arms, glass and wire and construction material. It is able to travel great distances with speed and certainty. Sometimes the truck is constructed with a tower for overhead work in the city.

The 3 or $3\frac{1}{2}$ -ton truck lends itself to almost all heavy construction work. Equipped with a power-driven winch, it can be used for loading, unloading and setting poles as well as transporting them, besides pulling underground and aerial cable.

Where winch equipment can be used, three men and the truck driver can easily set a pole. As many as eight men are required where the winch is not used, depending on conditions and the sizes of the pole.

The 5-ton truck is suitable for the heaviest kinds of construction work and for hauling lead-covered cable of great weight.

Special Services

The preceding are only a few of the many possible applications of the motor truck in material handling, and many special appliances are used which make the trucks more valuable in various places. Among these may be mentioned power winches which are used to aid in the unloading of heavy objects, and swinging crane apparatus used to remove heavy objects from the truck platform. Also the manufacture of special type trucks has increased the scope of motor truck application. One of these is the gas-electric truck which uses a combination of the gas and electric types of power units. The principles of design are such that no starting clutch, long shaft, countershaft, differential gear, sprockets, chains or live rear axle are required. The functions of these parts are performed by the generator, wiring and driving motors. This type of construction permits the truck to be built with a low platform, which feature is advantageous in loading.

Another special design is the electric truck which automatically loads and unloads without the driver leaving his seat. This unit is adapted for hauling in industries where materials to be carried can be straddled and picked up, such as lumber, brick, pipe, paper, bar iron, steel, cotton and cement. The material to be transported is piled on two wooden bolsters, the carrier straddles the pile, two hooks on each side of the carrier pick up the load and it is carried away and dropped wherever desired.

Demountable Bodies

Demountable bodies are manufactured in two principal types—open and completely enclosed. The open type usually has staked sides and ends. The enclosed type has an enclosed body with side or end doors. Either type forms a complete body for a motor truck or trailer. These bodies are provided with hooks or other attachment, or slings can be readily slipped underneath and the body with its load can then be lifted from the truck chassis with an overhead crane or other appliance.

The motorization of the Cincinnati, O., terminal, where motor trucks and demountable bodies have been substituted for freight cars in the movement of less-than-carload freight within the terminal, is an interesting example of the application of demountable bodies and of the correlation of the railroad and the motor truck as the solution of a difficult transportation problem.

Prior to the organization of the Cincinnati Motor Terminals Company, the handling of less-than-carload freight involved unloading from the car and piling on the main station platform; loading either into horse-drawn vehicles for moving to the station to which it was consigned, or into trap cars when sufficient accumulation justified trap car movement. On arrival at the outbound station of the connecting line, freight was unloaded to the platform and then reloaded into cars.

Two handlings now complete the operation. Equipment consists, in the main, of 225 demountable motor truck bodies and 16 5-ton trucks. When the loaded body has been lifted by electric cranes and hoists from a truck

chassis, it is replaced by an empty body, to be returned to the inbound platform of the same freight house. The operation of unloading from the car, reloading the body with freight and delivering to an outbound platform is then repeated.

Advantages of the new system have been a net economy in handling of \$0.352 per ton, indicating an annual gross

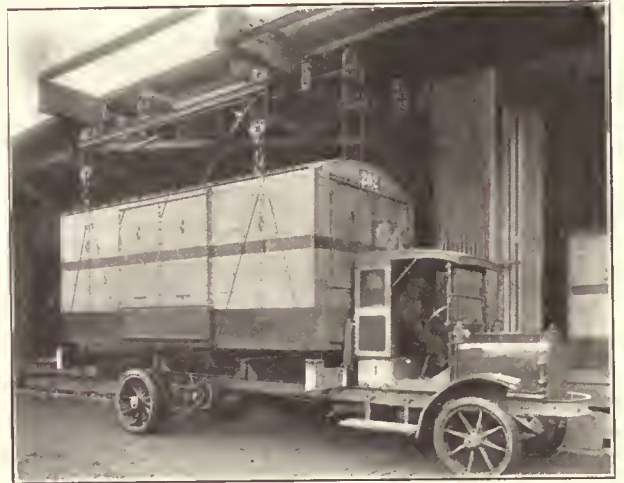

Demountable Bodies Eliminate Waiting Time of Trucks

economy of \$126,507, a gain of approximately 52.4 hours in the speed of handling freight; a saving of 50.4 per cent in platform area (equivalent to increasing platform capacity by 498.4 tons daily); reclamation of 248,504 square feet of station realty by the elimination of 6,232 lineal feet of trackage and space between tracks, formerly used by trap cars; the annual release of 66,862.5 trap cars for other service; conservation of labor by 30 per cent through elimination of two rehandlings of freight; reduction of loss through damage claims, in proportion to the decrease in amount of handling of goods necessitated.

Truck-Tractors and Tractors

The motor truck or truck-tractor is used principally to haul trailers over improved roads at motor truck speeds. In this way the truck not only carries a load on its own frame, but may also haul one or more trailers; when it is used with semi-trailers, part of the load is carried by the truck and part by the trailer.

The track-laying tractor is a type which carries no load, but hauls its load on slow-speed trailers. It is not used to any great extent for what might be termed industrial haulage, but rather for cross-country hauling, where unfavorable conditions prevail. It is used for material hauling, road making, logging and similar service over country that is in many instances unimproved and over almost impassable muddy and rough roads.

A special type of electric tractor has a motor in the large driving front wheel. This is used on docks and piers to haul trailers loaded with lumber. Another special type consists of an electric tractor with a crane. This can be used for heavy work to load the trailers and then haul them to the desired location.

Determination of Loadings

The load that can be pulled by a motor truck on a trailer:

or semi-trailer depends upon factors which vary with different equipment and different operating conditions. Distinction must be made between the amount of load which it is possible for a truck to pull and the amount which it is advisable to haul. The possible total load depends upon the available driving effort at the truck tires, mechanical efficiency of the trailer and the operating conditions. The advisable load depends upon the costs of doing the work.

The determination of the possible total load a motor can haul necessitates the determination of the available "tractive effort" and the "tractive resistance," because in order that a truck may haul any load, the tractive resistance must be less than the available tractive effort.

Tractive effort (T E) is the maximum driving force expressed as the number of pounds pull or push at the truck tires. It is determined by the maximum torque of the truck engine, the gear reduction, efficiency of the driving mechanism and diameter of the driving wheel.

The torque of the engine (T_e) is its turning moment at the flywheel, and is usually expressed in pound-feet.

Efficiency (E) is the ratio of the amount of power developed by the engine to the amount delivered at the wheels. This will vary in different vehicles from 80 per

cent to 90 per cent when operated in direct speed, and from 70 per cent to 85 per cent when operated in slower than direct speed.

Speed ratio or total gear ratio (Gd) is equal to the transmission ratio times the final driving ratio.

The diameter of the wheels must also be taken into consideration, as the tractive effort varies inversely as the radius. The actual diameter of pneumatic tires is greater than the nominal or listed diameter. However, the weight of the vehicle compresses the lower part of the tire so that the distance from the center of the wheel to the ground is approximately equal to one-half of the nominal diameter. The actual diameter of solid tires also exceeds the nominal diameter, but on account of wear, one-half of the nominal diameter is used as equal to the radius (r).

The tractive effort (T E) for any motor vehicle can be determined by use of the following formula, which takes into account the factors presented.

$$T E = \frac{T e \times G d \times E}{r}$$

The average motor truck when loaded will develop a maximum tractive effort in pounds equal to approximately one-half of its rated carrying capacity in pounds. For example, a 5-ton truck usually develops about 5,000 lb. tractive effort. The maximum tractive effort is developed on low gear and, therefore, when a motor truck has exceptionally high or exceptionally low total gear ratio, this rule-of-thumb will not hold good.

Tractive resistance (T R) is the "holding back" force due to grade (Gr), road resistance (T Re) and wind resistance (Wrc). The wind resistance is so slight to a vehicle operating at the speed of motor trucks that it may be neglected. The total tractive resistance (T R), therefore, is found by adding together the grade resistance (Gr) and road resistance (T Re).

Grade is the magnitude of inclination of a roadway from the horizontal. It is expressed as the percentage of the amount of rise to the horizontal distance traveled. Grade resistance is due to the raising of the load through a vertical distance as the load moves forward. If the load were lifted vertically the force required to lift it would be equal to the weight of the load, but when a load is carried up a grade, it is moved both horizontally and vertically, and as grade is expressed in the percentage that the vertical rise is to the distance traveled horizontally, the lifting effort or grade resistance (Gr) can be obtained by multiplying the total weight by the per cent grade. This expressed as a formula is:

$$Gr = W \text{ (weight)} \times G$$

Road resistance (Re) is that characteristic or quality of a road surface which tends to hinder or prevent the movement of a wheeled vehicle over it. Road resistance (Re) is usually expressed in pounds per ton of weight moved, and varies widely for different types of roads. The approximate resistance expressed in pounds per ton offered by the various types of roads is shown in the table on page 563.

Total road resistance (T Re) for any given road is found by multiplying the total weight of vehicle or vehicles and load expressed in tons by the pounds resistance per ton shown in the table for the type of road, i. e.:

$$T Re = W \times Re$$

The total tractive resistance (T R) which is equal to the sum of the grade resistance (Gr) and the total road resistance (T Re), can be found by using the following

formula, the terms of which have been explained:

$$T R = Gr + T Re = (W \times G) + (W \times Re)$$

The following example will illustrate how to determine the total load which can be handled by a motor truck under a given condition. Suppose the truck in question is of 5 tons capacity with a total tractive effort equal to 5,000 lb., and it is desired to determine how much load can be carried on this truck and trailer up a 5 per cent grade over a good gravel road.

Total tractive resistance is obtained as shown above by adding the grade resistance and the road resistance. For one ton of weight every per cent of grade adds 20 lb. to the tractive resistance. The road resistance (see road resistance tables) and grade resistance are expressed in pounds per ton; therefore, the total tractive effort in pounds divided by the sum of the road resistance and grade resistance, expressed in pounds per ton, will give the total number of tons which can be moved:

$$\begin{aligned} \text{Total weight that can be hauled} \\ TR &= \frac{5000}{(G \times 20) + Re} = \frac{5000}{(5 \times 20) + 80} = 27.7 \text{ tons} \end{aligned}$$

The total weight of 27.7 tons arrived at above includes the weight of the truck and trailer as well as the load; therefore, the weight of the truck and trailer must be subtracted from the total weight to obtain the weight of the pay load. For example, if the truck and body weighed 10,000 lb., trailer and its body 5,400 lb., the total weight of the two vehicles is 15,400 lb., or 7.7 tons, and the pay load would be 20 tons.

The example given illustrates a method of determining the maximum load which can be hauled (in low gear) under the given conditions, but does not take into account all the factors which should be considered when deciding whether or not trailers should be used on continuous operation.

The advisability of the use of trailers on continuous operation depends upon the average performance and average costs which will be experienced over a long period of time and not upon whether or not the work can be done in a demonstration of short duration. Careful consideration must be given to all phases of the operating problem which include not only the grades to be encountered and the condition of the roads during the various seasons of the year, but also the time factors which determine the possible average trips that can be made per day throughout the year. Low costs are obtained by maintaining the highest practical road speed while the equipment is running; by reducing the standing time of the equipment to a minimum and by maintaining the lowest possible equipment and operating cost per unit of material handled.

A set rule cannot be given by which it can be determined in general what type and size of trailer or trailers should be used for different kinds of work and whether or not economies would be effected by their use. Sometimes, when it is possible to reduce the standing time by the use of trailers, reduction in running time because of the use of trailers and the increase in operating and maintenance expenses will more than offset the saving which can be effected in the reduction of loading or unloading time. Every trailer application problem is a study in itself and must be carefully considered to determine what the probable haulage costs will be over a long period of time.

Special work, such as handling of extra long or extra bulky material, frequently makes the use of trailers absolutely necessary, and in cases of this nature consideration



Typical Tractors and Trailers: Fig. 1—Semi-Trailer; Fig. 2—Pole or Pipe Trailer; Fig. 3—Four-Wheel Trailer with Dump Body; Fig. 4—Four-Wheel Trailer, Slow Speed; Fig. 5—The Trailer Doubles the Capacity; Fig. 6—Semi-Trailer with High Sides; Fig. 7—Tractor Used in Logging; Fig. 8—Hauling Logs on Two-Wheel Trailers

in the selection of the equipment must be based entirely upon whether or not the pulling vehicle is of sufficient size con-

stantly to perform the work without excessive depreciation and maintenance cost.

Trailers

Any vehicle which can be attached behind a motor truck or tractor is not necessarily a good trailer. Trailers should be designed and constructed with much care and skill and the selection of the proper type naturally depends upon conditions and the commodity to be hauled.

Trailers have six major functions: They (1) increase the load-hauling capacity of the motor truck; (2) reduce the cost of transportation; (3) save waiting time of motor truck while loading and unloading; (4) move objects that cannot be carried on motor trucks alone; (5) take care of excess loads and peak haulage; and (6) enable passenger automobiles to be used for freight haulage purposes.

Great savings are possible by the use of trailers for hauling bulky materials which take up a great deal of space in proportion to their weight. Trailers are also used to haul long lengths which will not go on the truck alone.

They are used also on short-haul work, where the truck is used as a tractor and carries no load, and in some long distance hauling.

Single large castings, steel girders, funnel sections and large boilers as heavy as 16,000 lb. and of a size and weight too great to be hauled on a motor truck alone, can be hauled on a trailer coupled to a truck wherein the length and weight are divided between the truck and the trailer.

The strongest arguments in favor of a trailer used as an auxiliary to a truck are increased carrying capacity and reduced hauling cost.

In any line of business where there are large tonnages to be hauled the cost per ton-mile is least when the tonnage hauled per mile is largest. On long hauls the question of speed is also an important one. A number of states, however, to preserve improved roads, prohibit the use of trucks of more than four or five tons capacity or limit the total weight of truck and load to 20,000 lb. or 25,000 lb., which is equivalent to limiting the pay load to 5 or 6 tons. Loads of double this tonnage can be hauled by single power units drawing trailers without violating the laws or doing any more injury to the roads than when the loads of five or six tons are transported on single trucks. The total weight is distributed over six or eight wheels instead of being concentrated mainly on the two driving wheels of a truck. On a hard, smooth, level road two loaded trailers are not infrequently drawn by a single truck, thus tripling the tonnage per trip.

In operating motor trucks, the item of time spent in loading and unloading is often a most expensive one. It is imperative that this lost time be reduced to a minimum. The truck is too costly an article to be used as a loading platform and should be kept under load and on the move to be a profitable investment. This may be accomplished by the use of one or more of the many forms of trailers which are applicable for the particular kind of commodity to be transported.

If one trailer is used it can be loaded while the truck is making the trip alone, and be picked up by the truck every other trip. Two trailers can be used to still better advantage, while a fleet of three trailers makes a very efficient hauling unit, especially where loading and unloading take up a large part of the truck's time. In the latter case it may be found good practice to use the truck only as a tractor, and keep it in motion almost continually. One

trailer may be kept at each end of a haul, while the truck is in transit with a third trailer.

The class of service and type of construction divides the trailer into two general forms; high speed trailers and slow speed trailers.

High speed trailers are used principally behind motor trucks at speeds from 4 m.p.h. to 15 m.p.h. There are many soft road conditions where it is required to haul bulk material or for logging or similar service under which it is impossible to operate efficiently and economically with motor trucks and high speed trailers. Under such conditions the cheapest and most dependable method of transportation is by a tractor with a train of slow speed trailers of strong, sturdy construction.

Trailers fall into four general classifications, according to type:

- (1) Four-wheel trailers.
- (2) Two-wheel trailers.
- (3) Semi-trailers.
- (4) Pole or pipe trailers.

The four-wheel trailers are sub-divided into reversible and non-reversible types; light high-speed trailers, for use with passenger automobiles; heavy duty trailers, hauled by motor trucks for general haulage purposes; straight frame and drop frame models; and slow-speed trailers with dump bodies, for use in trains with tractors.

Two-wheel trailers may be classified into light and heavy types for use respectively with passenger cars and motor trucks; dumping and non-dumping types.

The semi-trailers may be classified into straight-frame and drop-frame types.

Pole and pipe trailers are made in extension reach and non-extension reach types.

Almost any type of body can be mounted on the four-wheel trailer and many different types on the semi-trailer and the two-wheel trailer. The pole and pipe trailers are not intended to carry bodies, but instead are provided with bolsters to retain their loads.

There is a type and size of trailer for almost every purpose, ranging in capacity from 500 lb. to 15 tons.

Four-Wheel Trailers

Four-wheel trailers are complete vehicles in themselves, intended to carry their own load and be pulled by another vehicle. This type of trailer is manufactured in two general classes; one class being intended for use behind slow-moving tractors and the other for use behind fast-moving tractors or motor trucks. The first class was the result of a transition from the horse-drawn wagon, developed for use in connection with heavy slow-moving road tractors. Trailers of this kind are of a construction similar to that of wagons built for carrying the same kind of load, except that certain parts in their construction are necessarily heavier to withstand the strains of towing other trailers behind them in addition to carrying their own load; in some cases they are made reversible, i. e., can be steered from either end. Slow-speed trailers are suitable only for use behind slow-moving tractors, and are ordinarily used in rural districts.

The advent of the high-speed tractor and the extensive

commercial use of motor trucks as tractors made changes in trailer design necessary to make them practical for use in connection with vehicles which maintain a road speed higher than three or four miles an hour. Road-shock absorbing devices, such as springs and rubber-tired wheels, are not necessary on slow-moving vehicles, but these features are necessary in the faster moving vehicles in order to obtain a reasonably long operating life and to reduce to a minimum the effort required to pull them.

The details of design vary in different makes of four-wheel trailers produced today for use behind high-speed tractors and motor trucks, but in principle they are all similar. The universal practice is to use a steel frame supported by two axles with automobile or truck type wheels. Springs similar to those used on motor trucks and built in proportion to the load to be carried are mounted between the axles and the frame. Rubber tires are provided both to lessen the road shocks to the entire vehicle and to make practical the use of anti-friction wheel bearings.

The chassis of the four-wheel trailer is designed to standard construction so that the many types of bodies mounted on motor truck chassis are adaptable and can be used interchangeably. The types of bodies may include: Stake or platforms, open or express, enclosed or panel, dump and tank.

Some trailers are fitted with hand-operated roll-offs, but a type of four-wheel trailer that is coming into common use has a hinged frame that permits the load to be tilted until it rolls off at the rear by gravity.

Four-wheel trailers are made either reversible or non-reversible. The reversible trailers have provision for steering at either end, and are equipped with a drawbar at both



A Train of Trailers

ends which permits the truck to be attached at either end without turning the trailer around. This feature is also provided to facilitate backing and "spotting" the trailer, as

with this construction it may be guided from the opposite end from which it is pushed. Non-reversible trailers have the steering mechanism and drawbar at one end only, and the rear axle is permanently fixed in position similar to the rear axle of a wagon.

Provision for steering four-wheel trailers is made by the use of either steering knuckle axles of the automobile type,



A Fleet of Trailers

or by the use of fifth-wheel construction similar to that used on wagons. When the former type is used a suitable steering linkage mechanism is attached to the drawbar on the trailer so that when the drawbar is turned to the side the wheels are cut in the same direction. The reversible type trailers have steering mechanism locking devices, so that the wheels at the end of the trailer, not being used for steering, can be held rigidly in a straight position. When the fifth-wheel type of steering is used, the drawbar is attached to a part of the construction which turns with the axle, and steering is accomplished by the rotation of the axle with the two wheels about a king pin at the center of the fifth wheel.

Four-wheel trailers are sometimes connected to the towing truck or tractor by a drawbar, provided with springs to take up the shock of starting and to cushion the pull and thrust of the trailer when running. On some trailers the drawbar is attached at the rear end to the steering rod and is provided with compression springs, which are enclosed within the drawbar and are packed in grease. Sometimes the drawbar, which is swiveled to a truss draft beam bolted to the frame, swings from side to side in a slot between the front frame and a sub-member below. On other types the swivel drawbar not only swings on the draft beam and steers the front wheels, but is jointed immediately back of the curved member of the frame. It can be locked into position, but the drawhead swivels on the bar, allowing the motor truck, when backing the trailer, to get far out of line with the trailer without bending or breaking the drawbar. The drawbar is sometimes hinged at the axle so that it may take any necessary angle in a vertical plane.

Safety chains are attached to the drawbar and front axle and are provided with hooks to be placed in eyes on the motor truck coupler to insure against accident in case of possible breakage or failure of the connection between machine and trailer.

The types of work for which four-wheel trailers are ordinarily used are the haulage of bulky, light loads, such as barrels, empty boxes, cotton bales, metal stampings, etc., and exceptionally heavy loads such as safes, boilers, large machinery, etc.

Tank trailers of the four-wheel type are coming into use by oil and chemical companies. They are proving economical because they double the load hauled at each trip of the truck and also because they save loading and unloading time. Truck and trailer tanks can be fitted simultaneously and the trailer can be left at a garage or supply station to discharge while the truck proceeds alone to the next station to be emptied. The trailer is picked up on the return trip.

Saving of loading time is of particular interest to the lumber manufacturers because the making up of a load of boards, shingles, lath or trim, requires a great deal of time. The custom usually in the lumber trade is to leave wagons at mill to be loaded, while drivers and horses are on the road with other wagons. Adoption of trailers and semi-trailers enables the trade to continue this operating method and to get the additional advantage of the superior speed, load capacity and endurance of motor truck.

Dump Bodies

The bottom dumping body and the spreading body is a development of the result of a demand for a trailer body for road-building purposes; as a means of hauling bulk material, they have many advantages. Loose material can be hauled and dumped in a small compact pile. Either the bottom dump body or spreader type has a cubic capacity of about $3\frac{1}{2}$ yd. A provision is made to adjust the lower door for spreading material to various thicknesses. Sectional bodies are sometimes used by operators and carry different kinds of material to one or more points on the same trip. The hoppers operate independently of each other. Usually they are made of equal capacity.

The automatic side dump body discharges the load outside of the wheels. This body operates by gravity, and no power is required to dump or return the body after dumping. The particular drop-frame construction brings the loading height to about 60 in., which is within easy reach of the shovel, thus saving time and energy. The short wheel base makes possible a short turning radius, and often team tongues are provided because in some instances the trailers are pulled by horses. Under difficult conditions there is only one other form of hauling equipment which

can be considered for road work, and that is the industrial railroad. Trailers are better because of the smaller initial investment; the freedom from track limitations makes the trailer movements much more flexible.

In practically every city, one of the greatest problems which the officials must solve is the disposal of garbage and ashes. Many cities employ the trailer train system for garbage and ash removal. Briefly, the method followed is to hitch a team of horses to each trailer and drive from house to house to collect the loads. When filled they are driven to a central point in their respective zones in the city. Here they are met by a motor truck with three or four empty trailers. The loaded trailers are coupled into a train and hauled by the truck or tractor to the city incinerator or to the city dump. While the train is on the way the teams have been hitched to the empties and continue the work of collection. Thus teams and trucks are used in their fields of greatest efficiency, the trucks hauling 12 tons to 15 tons per trip on the long hauls and being continuously operated at a speed of 8 m.p.h. to 10 m.p.h.

Two-Wheel Trailers

The two-wheel trailer, as distinguished from the semi-trailer or pole trailer, is used principally for transporting comparatively light loads of 500 lb. to 2,000 lb. at automobile speeds.

Two-wheel trailers are different from semi-trailers in that the entire load is carried by the trailer's axle and wheels. The entire load is balanced over its axle and the pulling vehicle serves only to balance the trailer and tow it. A bracket or other coupling device is attached to the rear end of the tractor or truck for attaching the tongue or drawbar of the trailer.

The two-wheel trailer is used by truck farmers, retailers and contractors. Most of the trailers of this construction are of the light high-speed type, but heavier types are manufactured for capacities from 3,500 lb. to 4,000 lb.

Semi-Trailers

Semi-trailers are a type of two-wheel trailer which have their axles and wheels placed under the rear portion of



Semi-Trailers Eliminate Waiting Time of Truck-Tractors

their frame and which are supported in front by the vehicle which tows them. With this type of trailer approximately 40 per cent of the load is carried by the towing vehicle and 60 per cent by the trailer. The construction of these trailers is similar in principle to non-reversible four-wheel trailers, except that in place of an axle in front there is a fifth-wheel which rests upon and is attached to the truck or tractor with which they are used.

Several types of fifth-wheel are in common use which allow universal action and permit sidewise as well as fore-and-aft rocking, and also permit the truck and trailer to stand at an angle to each other. A pair of compression springs are often furnished to take the shock of starting the semi-trailer and its load.

Special trailers of the semi-trailer type with drop frame are produced to meet heavy hauling conditions, and where a low loading height is essential.

The single form is used for hauling machinery, heavy blocks of stone, plate glass, boxes and barrels. As the center of the platform is only 18 in. to 20 in. from the ground, it makes the loading and unloading of such articles much easier.

Jacks, that operate with either screw or ratchet or some other means, for supporting the trailer when it is detached from a truck or tractor are necessary on this type of trailer so that the truck or tractor will not have to remain idle while the trailer is being loaded or unloaded.

Supporting devices, whether they are jacks, pedestals with wheels or some other type, are sometimes permanently attached to the trailer and so arranged that they may be fastened under the trailer in such a way as not to interfere with the operation of the truck or tractor and trailers when in transit.

Long loads, such as telegraph poles, long lumber or

timber, steel beams of extra length, etc., are usually hauled on semi-trailers.

Pole or Pipe Trailers

The satisfactory pole and pipe trailer must have strength combined with flexibility. The front end of the load on this type of trailer is supported by the towing vehicle. The principal form of construction consists of two wheels mounted on a rectangular forged dead axle. The standard equipment is for hauling logs, lumber, pipes, poles, heavy beams and other articles too long to be loaded on motor trucks and trailers of ordinary wheelbase. For heavy duty work wide tire equipment is recommended.

As the type of articles mentioned vary in length, it is necessary to make trailers with extension tongues or reaches so they can be lengthened 6 ft. to 18 ft. or shortened to fit the load, preventing undue overhang at the rear and preserving a proper distribution of weight between the trailer and the motor truck or tractor.

The connection between the truck and the trailer is hook or hitch, with a relief spring to take up the strain of stopping and starting.

No bodies are used on pipe trailers. Bolsters are provided with removable stakes or adjustable blocks to retain the load, and are fitted to the trailer and also to the towing vehicle, where it is mounted on the fifth-wheel or is a swinging or pivoting type, to allow turning.

Considerable hauling in the oil fields is done on trailers. The type of trailer most in use is the two-wheel pipe trailer with adjustable reach. Hauling in this sense is difficult because of the lack of roads, heavy mud during wet weather, and length and weight of oil-well material, which amounts in some instances to from 10 to 15 tons, and includes machinery, boilers, well casings and stills.

INDUSTRIAL RAIL TRANSPORTATION

Railways for Manufacturing Plants, Steel Mills,
Foundries, Power Plants, Mines, Construction,
Logging and Plantation Work, Including
Cars, Locomotives and Track Devices

A Treatise Covering the Construction and Application of
Rail Transportation Devices Used in
Handling Materials

By

ROBERT C. AUGUR

Member, American Society of Mechanical Engineers



Industrial Rail Transportation

TRANSPORTATION BY RAIL is the most economical method of moving large quantities of either loose or packed material for a considerable distance. Industrial railways are extensively used around steel mills, smelters, foundries, machine shops, power plants, shipyards, boiler shops, chemical plants, brick yards, glass works and other manufacturing plants. They are also the principal means of transportation in and around coal and ore mines, quarries, stone crushing plants, sand and gravel plants, sugar and other large plantations. In the handling and storing of coal and iron ore, in large logging and lumbering operations and in grading, road building and other construction work an industrial railway is frequently the indispensable means of transportation.

A careful study of all factors entering into the problem should be made before deciding upon the adoption of any transportation system. Some of the points to be considered are: the quantity, weight and character of materials to be moved; the points between which they are to be transported; the distance; the character of the ground; the differences in levels; the methods to be used for loading and unloading; the cost of installation, operation and depreciation; the kind of labor and the types of motive power available. Without such a study an intelligent choice cannot be made as no hard and fast line can be drawn between the various types of material handling machinery.

For short distances movements along fixed routes, especially where a continuous flow is desirable, some form of a conveyor or elevator is most suitable.

Where flexibility of movement is important and neither the quantity nor the weight of material is too great, industrial trucks or tractors and trailers may be preferable; while if suitable public roads are available the motor truck is a flexible and economical transportation unit for the handling of many commodities. For the lifting of heavy and bulky articles a crane is usually employed and when installed may be used to transport such articles for moderate distances. In a rough country or where streams or valleys have to be crossed or for temporary construction work a cableway or an aerial tramway may be more suitable than an industrial railway because of its quicker installation and lower initial cost.

Some authorities have attempted to classify the fields of the industrial truck or tractor and trailers and of the industrial railway by the simple rule of distance. Thus, for example, the short distance haul of not over 1,500 ft. is assigned to the trackless devices and these over that distance to the track devices. Such a rule is of slight value because it does not give due consideration to the character of material to be handled; cost of investment; operating

costs, etc. Industrial railways and their equipment do not have the flexibility of trackless devices but they are low in cost of construction, operation and maintenance while cars cost less than trailers and the tractive effort required is only a third as much as that for the same load handled on trackless equipment running on cement floors.

The fullest measure of success and usefulness of an industrial railway system will depend in a large degree upon the care with which it is located. Another important factor affecting the economy and value of the system is a proper selection of track, switches, turntables, types of cars and methods of haulage. These are points which can be determined but by one familiar with the solution of transportation problems.

Many types of cars have been designed to meet the different requirements of the various industries. A number of these types have such a broad field of usefulness that

their designs have become standardized. However, specially designed cars are often better fitted to meet the particular local conditions. The more commonly used forms of cars will be described in detail later on.

Cars are frequently pushed by hand but they may be coupled together and hauled in trains by animal power, by a cable or by a locomotive. Various types of locomotives are available to meet the requirements of different conditions. A choice may be made between steam, fireless, compressed air, gasoline engine, kerosene engine, storage battery, trolley and third rail locomotives. Moreover, under certain conditions self-propelled cars are even

better adapted than locomotives.

Classes of Railways

The designation industrial railways, in the broad sense of the term, covers all railways operated as subsidiary to industrial undertakings and not as separate commercial enterprises. As thus used the name includes railways used for logging, construction, plantation work and mining as well as those used around industrial plants. They range from those laid with an 8 lb. rail and a track gage of 18 in. or less and carrying small four wheel hand cars to those laid with the heaviest rails and in construction and rolling stock conforming to regular standard steam railroad practice. They may be divided into twelve or more general classes.

Industrial Inter-plant Railways. These are used around factories, foundries and power plants for handling rough, semi-finished and finished materials, coal and other commodities and are often called simply industrial railways. They are commonly of 24 in. track gage, although 21½ in.

Industrial Railways: Inter-plant; Mine; Logging; Plantation; Construction; Portable; Cable; Automatic; Inclined Plane; Rack; Skip Hoist.

Cars: Platform; V-Body; Scoop; Charging; Square Body Rotary; Box Body Dump; Hopper Bottom; Gable Bottom; Inclined Bottom; Creosoting; Charcoal; Logging; Cane; Dryer; Transfer; Ore; Coal Mine; Mill; Ladle; Foundry; Larry; Self Propelled; Skip.

Locomotives: Steam; Fireless; Compressed Air; Combustion Engine; Storage Battery; Electric Trolley and Third Rail.

Track: Gage; Rails; Joints; Ties; Switches; Frogs; Crossings; Derails; Portable Track; Cast Plate Track; Turntables; Transfers; Track Tools.

outside gage and other narrow gages are sometimes used. They are usually carefully laid and in a well designed system arranged to reach all necessary points and permanently installed. Rails range from 12 lb. to 25 lb. per yard according to the loads carried. For inside use in boiler rooms and elsewhere cast plate tracks are frequently substituted for steel rails. For reaching outlying points, as in foundry yards or for disposing of refuse, portions of portable track may be advantageously employed. Cars are generally of the four-wheel type although double truck cars are occasionally used for handling unusually long or heavy material. Storage battery or gasoline locomotives are advisable where there is considerable traffic or the distances are long.

Heavy Mill Railroads. These are required around steel mills and large manufacturing plants. They are usually of 56½ in. gage and as they conform to well known railroad practice will not be described in detail here. Cars are usually of the double truck type and sometimes self-propelled. Any one of the many types of locomotives may be used dependent upon local conditions.

Mine Roads. All mines from the smallest to the largest depend upon a railway system for the transportation of outgoing and incoming material. Ore mines frequently use roads with a track gage of 18 in. or less and small hand cars. Coal mines use roads with track gages ranging from 18 in. to 56½ in. In the larger coal mines there is a marked tendency toward the adoption of a 42 in. track gage, a practice which is strongly recommended. For strip mining 56½ in. gage is common although a narrower gage is sometimes preferable.

Logging Roads. These are usually constructed with a minimum amount of grading, are frequently taken up and relaid—especially branches and extensions—and often have heavy grades and sharp curves.

A 36 in. track gage is used in many places on account of the low cost of construction, but the standard railroad gage of 56½ in. is more generally adopted so that cars of logs may be delivered without reloading.

Logs are sometimes used instead of steel rails, although this practice is not as common as it once was.

Plantation Roads. These are frequently employed on sugar cane, coffee and other large plantations. The track gage used varies from 24 in. to 56½ in. while in countries using the metric system 60 c. m. and 1 meter are common gages. Track construction varies greatly, dependent upon the size of the plantation, the distance traversed, the character of the country, etc. Sections or portable railway are frequently used for reaching out into the fields and gathering in cane and other products. Such portions of track are easily changed from one location to another and need not necessarily be of the same gage as the main road. On such feeders the cars are frequently hauled by animal power.

Long Sidings. Manufacturing plants, logging camps, quarries, sand or gravel pits, mines and other enterprises are sometimes located at a considerable distance from a railroad and to connect with a shipping point a long siding or branch is required. The cost of construction and the amount of material to be transported may not warrant the expense of a standard gage railway. In such cases a narrow gage road generally of 36 in. gage may meet the requirements. The lighter and cheaper construction possible with such a narrow gage road will often more than offset the cost of transferring material at the shipping point. By the use of modern handling machinery such a transfer can usually be made at a low unit cost. However, where the amount and value of the traffic warrants, it is preferable

to adopt the standard gage and thus obtain the benefit of car interchange.

Construction Roads. In the building of railroads, highways, dams, tunnels, aqueducts, canals, sewers and in other construction work a railway system is often employed. It is frequently narrow gage, commonly 36 in. and sometimes only 24 in. As the installations are temporary the line is frequently made up of portable track with steel ties although wooden ties are used where they can be obtained at a favorable price.

Portable Railways. Where operations require the track to be frequently changed from place to place, portable railways are usually the most economical type to use. The sections of rails and ties with joints are fastened together by the manufacturer and thus delivered to the customer. Portable track is usually made up in 15 ft. sections so that two men may easily carry a section anywhere. These sections are simply laid on the ground, coupled together and the road is ready for traffic. The use of special slip joints at the end of the sections makes it possible to lift and relay a portion of track in a short time.

Cable Railways. These are used most extensively around industrial establishments for handling heavy bulk material in volume, at coal and ore storage points and in mine haulage. While this system of operating cars is a very old one it is of limited application. The cars are moved by being attached to a running wire rope. The rope may run continuously at a constant speed and the cars be attached and detached by grip on the car or the cars may be permanently attached and the cable started and stopped by an operator at will. Cable railways may run on a level, or up grade and down grade as required by local conditions. For industrial use they are often elevated 10 ft. to 15 ft. above the ground level and the space below used for storage. There are four systems of cable railways in common use:

(1) **Endless Cable.** In this type the wire cable is constantly running in one direction at a fixed speed and a car is attached or detached at any point by a cable grip operated by a man on the car. This method is suitable for heavy service and any number of cars desired may be used.

(2) **Double Shuttle.** In this type two cars are permanently attached to the wire cable in such a way that as the loaded car goes out the empty car comes in. The cars may pass each other on a centrally located switch or they may run on parallel tracks. The winding engine is usually located at the loading point and is started, stopped and reversed by the operator who also attends to the loading. The system is best adapted to moving material between two fixed points. Cable bottom cars are generally used and are arranged to dump automatically upon striking a trip.

(3) **Single Shuttle.** In this type only one car is used, the loaded car being drawn outward by power, dumped automatically and then drawn back to the loading point. The winding engine is usually so located that it may be operated by the man attending to the loading.

(4) **Mine Haulage Systems.** These differ according to conditions. In some places the empty cars attached to a cable run down a slope by gravity and the cable is then attached to a trip of loaded cars and they are hauled up to the head house. In other places a main or head rope is used to haul out the loaded cars while a tail rope is used to haul the empty cars back into the mine, the tail rope passing around a pulley at the inner end of the mine.

Considerable effort has been expended in perfecting the details of the auxiliary devices used on cable railways. Without going into descriptions it may be said that the

success of a system will depend largely upon the design of such details as cable grips, layout of curves with guide pulleys and winding engines.

Cable railways are low in cost of construction, equipment, maintenance and operation. No more economical method has been found for handling quantities of coal and some other bulk materials which have to be unloaded and stored in large piles.

Automatic Railways. These are mainly used for transporting coal, sand, ores, limestone, cement and other loose materials from vessels or cars to storage bins which are not over 500 ft. or 600 ft. away from the receiving point. Their most extensive use has been for handling coal along the water front although they have been installed at many other places. As no power is required the operating cost of automatic railways is extremely small.

In operation, a car after being loaded is started down an incline which has sufficient pitch to carry the loaded car at a high speed to a movable automatic dumping point. Just before reaching this point the loaded car picks up a wire cable which is indirectly attached to and raises a weight. The energy stored up in the counterweight which has been raised by the loaded car causes the empty car to return up the incline to the starting point.

The cars used on automatic railways are of the hopper bottom type. They are especially designed for the service, have sloping sides and ends and are provided with a cable pick-up.

These cars are described in detail further on in this section.

Inclined Planes or Railways. These are extensively used at mines where the pit heads open on hillsides above railroads or points to which the coal or other material is to be delivered. Under these conditions "gravity planes" are employed; the loaded cars attached to one end of a cable descend the grade while the empty cars attached to the other end of the cable are pulled up the grade to the top of the plane. The cable passes around sheaves located in the head house, the speed of the cable being controlled by brakes attached to the sheaves.

A power plane differs from a gravity plane in having a winding engine provided for hauling loaded cars up the incline. One end of the cable is attached to a trip of loaded cars being hauled up the plane while the other end of the cable is attached to a trip of empty cars being lowered to the mine.

Inclined planes may be equipped with double tracks or with a single track provided with a long central passing switch.

Inclined railways are sometimes used at places other than mines where it is necessary to haul cars up an incline.

Rack Railways. Where grades are too steep for plain or geared steam or electric locomotives to operate satisfactorily, rack railways are required.

The special rack locomotives used in such places are described in that part of this section devoted to the various types of industrial locomotives.

Skip Hoists. Where bulk materials have to be elevated and dumped at a fixed point the skip hoist provides a

simple, speedy, reliable and economical device for accomplishing the desired result. They are used at practically all blast furnaces for hoisting charges of ore, fuel and limestone from the stock house to the top of the furnace and are extensively employed at boiler houses for elevating both coal and ashes to overhead bins. Other places where they are frequently used are at quarries for elevating stone to a crusher or for raising crushed stone to an elevated bin, at sand and gravel pits for elevating the material to the washing plant, at lime kilns for elevating stone and fuel, at gas plants for elevating coal, in concrete construction work for charging mixers and at ore and coal mines. They may be used for handling liquids as well as solid bulk materials.

A skip hoist consists of a car running on inclined or overhead tracks and hoisted by means of a cable attached to a winding engine. The track may be at any angle up to the vertical.

The cars, which are described in detail further on in this section, are of many shapes, sizes and capacities. They are mounted on two pairs of wheels, the rear pair of which usually have treads of at least double the ordinary width. At the dumping point the rails are curved to carry the car over the bin or hopper. Starting at a point just ahead of the place at which the track rails are curved, an outer pair of rails are installed to take the extended tread of the rear pair of wheels. These outer rails guide the rear wheels in such a manner that as the front pair of wheels runs in on the curved track, the rear pair continues to travel in a straight line. The rear of the car is consequently raised and the load dumped. Instead of using double rear wheels a third pair of wheels is sometimes used, these being of a wider gage to suit the outer set of rails.

When the incline is very steep, suitable guide rails are provided in addition to the track rails.

For vertical installations the guides and rails resemble those used for elevators while the cars closely resemble buckets.

In the single unbalanced skip hoist only one car is used and the hoisting cable is wound onto a single drum.

In a balanced skip hoist two cables are used, one attached to the skip car and the other to a counterweight. The cables are wound on the drum in opposite directions, so that as one is wound up the other is unwound.

A double skip hoist employed two cables arranged in the same manner as for a balanced skip hoist, but each of the cables is attached to a car so that as a loaded car is hoisted an empty car is lowered.

The operation of a skip hoist may be governed by an automatic push button control. The operator then simply pushes a button when it is desired to make a hoist. When the car is dumped an automatic switch reverses the machinery, causes the car to return to the loading point and then stops the machinery.

Illustrations showing the application of skip hoists for handling coal and ashes at boiler houses, and also at sand and gravel washeries and at stone and lime plants are shown in other sections of this book.



V-Body Dump Car in Construction Work



Inclined Bottom, Side Dump, Concrete Cars



Air Dump Cars in Railroad Construction



Tractor with Train of Dump Cars



Inclined Bottom Lime Car



Third Rail Electric Locomotive and Gable Bottom Cars



Electric Locomotive, Pusher Type



Electric Locomotive and Coke Cooling Cars

Industrial Cars

THE INDUSTRIAL CAR in some one of its various forms is used in almost every branch of industrial activity. It is found in the busy manufacturing plant, underground in the coal mine, in the woods where the lumberman is working, on the sugar cane plantation and wherever construction work is done. It is the universally adopted medium for the transporting of coal and ore from the point where it is mined to the surface. In quarries, sand and gravel plants, brick and clay works, steel and rolling mills, forge shops, smelters, foundries, machine shops and many other places it has been found to be either the only really practical device for moving material or has been adopted as the most economical one. Thus, while it does not attract so much attention as does the larger and more conspicuous railroad freight car, yet in its particular fields it has just as vital and essential a function to perform.

The industrial car is, however, only one link in the chain of a complete transportation system and in order satisfactorily and economically to perform its functions, and not prove to be the weak link in the chain, its general type and its design must be carefully developed to meet the working conditions. For steam railroad transportation the handling and packing of material must be done in such a way as to conform to terminal conditions or to the character and size of the cars available; but in industrial transportation the railroad itself, together with the types of cars, the methods used for loading and unloading, and the means taken for moving the cars, should all be intelligently selected to meet the conditions prevailing at the time or anticipated in connection with probable future developments.

There is such a wide diversity in the character of the materials to be moved and in the conditions under which the cars are used that a great many variations in design and size are necessary. As an illustration, the character of a coal mining car and the track gage are dependent upon the thickness of the vein of coal, width of entrance, grades, curves, whether the cars are pushed singly by man power, hauled by mules, by rope haulage or by locomotives; also by the method of loading, means for unloading, etc.

Although many different kinds of cars varying in type, design, capacity, track gage, etc., are required to meet the widely varying demands, yet considerable can and should be done in the direction of standardization and in the elimination of unnecessary variations. As an example of the present existing lack of uniformity, consider such a vital factor as the track gage. Manufacturers' catalogs show over 25 different gages ranging from 16 in. to 56½ in., the latter being the common steam railroad standard.

The different types of cars may be classified according to the industrial field in which they are used and according to their general form. The most widely used forms of general purpose cars will be described first, after which those of a more special character will be taken up.

Platform Cars

For general utility purposes, whether in and around industrial plants or elsewhere and for handling a wide variety of materials, small platform cars are more convenient and more widely used than any other type. To meet such diverse service conditions so many variations in di-

mensions, capacity and details of design are necessary, that the leading manufacturers have standardized only a limited number of cars.

Four-wheel Platform Car

Standard four-wheel platform cars are made for a wide range of track gages. In addition to those shown in the table below, some manufacturers also list standard cars for 18 in., 20 in. and 42 in. together with 20½ in. outside gage.

The length of the platform can be varied to suit conditions, but the sizes given in the table represent those most commonly used.

SIZES OF STANDARD FOUR-WHEEL PLATFORM CARS

Track Gage	Wheel Base	Width of Platform		Length of Platform
		Bearings Inside	Bearings Outside	
24 in.	24 in. to 30 in.	20 in. to 30 in.	36 in. to 48 in.	5 ft. to 6 ft.
30 in.	30 in. to 36 in.	24 in. to 36 in.	42 in. to 60 in.	6 ft. to 8 ft.
36 in.	40 in. to 48 in.	28 in. to 42 in.	48 in. to 72 in.	7 ft. to 12 ft.
56½ in.	60 in. to 84 in.	66 in. to 90 in.	8 ft. to 15 ft.

The underframe is often of wood but on the more substantial cars it is of steel, usually of channel iron construction. Except in the larger and heavier cars center sills are not required.

The most common practice is to use a platform of yellow pine or oak, preferably tongued and grooved to prevent warping. This may be protected by a light steel plate or the cars may be ordered equipped with a heavy steel plate top or deck riveted to the underframe with counter sunk rivets to ensure a flat surface.

The carrying capacity for which platform cars are ordinarily designed is two to three tons for the smaller sizes and five or six tons for the larger sizes. Cars of larger capacity are often required for certain purposes and may be made for practically any capacity for which the track and roadbed are adequate.

Bearings may be inside or outside of the wheels, dependent largely upon the width of platform desired. Cars with bearings inside of the wheels usually have platforms from 6 in. wider to 8 in. narrower than the track gage, while cars with bearings outside of the wheels usually have platforms from 1 ft. to 2 ft. wider than the track gage, as shown in the preceding table.

Journal boxes usually are rigidly attached to the frame but if desired the platform may be spring-supported with the journal boxes working in pedestals.

Chilled cast iron wheels, single plate or with spokes, are generally used, although cast steel wheels are sometimes

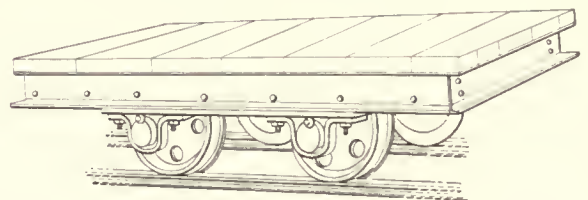

Fig. 1—Four-Wheel Platform Car

furnished, especially for heavy service. Wheels for the smaller cars are usually from 12 in. to 16 in. in diameter, for the larger cars from 16 in. to 20 in. The wheels are usually pressed on the axle, but where there are many short curves in the track one wheel on an axle is some-

times left loose. Most manufacturers now regularly furnish their cars with roller bearing axles or with rollers in the wheel hub where the wheels are loose on the axle. Plain bearings offer about double the resistance of roller bearings and require so much more attention to lubricate that it is rarely economical to use any other than roller bearings on four-wheel cars.

The wheel-base, or the distance between centers of wheels is usually kept short so that cars may be easily pushed around sharp curves. If curves of large radius are used and the character of the material handled makes it desirable, the wheel-base may be greater than the figures given in the table of sizes.

Brakes are not usually required on small platform cars and are never furnished unless specified.

As platform cars are usually pushed singly by hand and not used in a train, or coupled to a locomotive, couplers are not regularly supplied. If couplers are desired, the style and the height from the top of the rail should be specified. The couplers most commonly supplied are of the link and pin type, although in the larger cars automatic types are frequently used, and should, of course, be specified if the cars are of standard gage and are ever to be coupled to steam railroad cars, which are all equipped with M. C. B. automatic couplers. If more than a very few cars are coupled together and hauled by a locomotive, spring draft rigging should be applied.

Stake pockets are not regularly furnished but are often required and can be applied to any car if called for. The same applies to stakes and also to wooden or steel sides and ends, which are made either attached to or separate

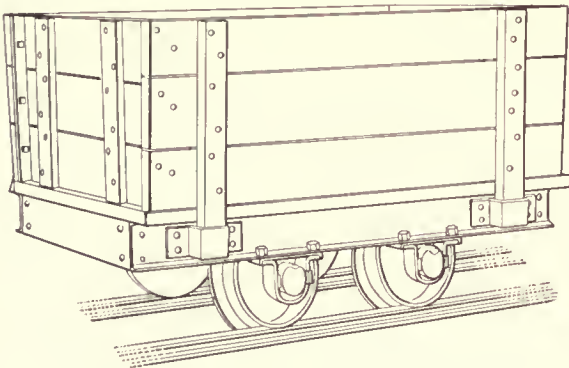

Fig. 2 Platform Car with Sides and Ends

from the stakes. The ends can be set in cleats if desired, thus making them removable for loading and unloading or for carrying long material.

A low-down platform car is useful where heavy, tall

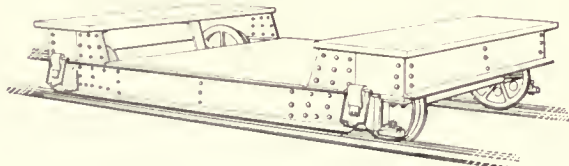

Fig. 3—Low Platform Car

or bulky articles have to be handled and it is desired to load and unload the cars without elevating the material very high above the floor level. This type of car is used to a considerable extent in marble and granite works, by piano manufacturers, in some machine shops and in many steel mills for ingots, coils of wire, etc.

Cars with tilting platforms are convenient for the rapid unloading of certain materials and are used in machine shops, foundries and elsewhere. They are designed to dump the load on either side of the track and, if desired,

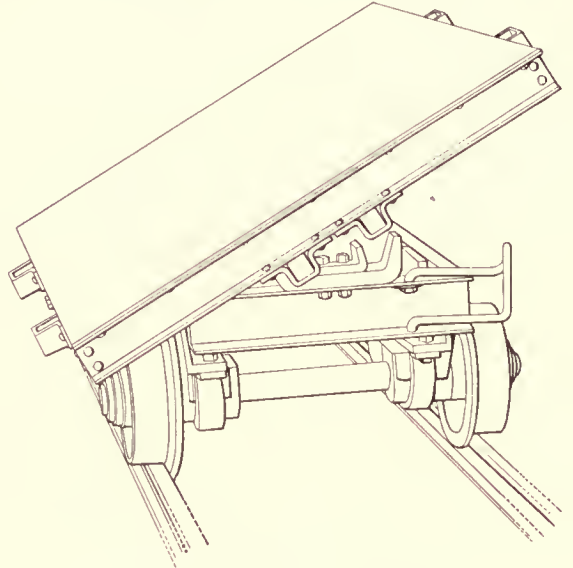

Fig. 4—Tilting Platform Car

can be equipped with sides and ends either to be lifted off or arranged as hinged doors. This makes a suitable car for handling sand, gravel, ashes and small or loose material, although if regularly handled in quantities some other form of a car, such as the V-body dump, is more extensively used. The particular car shown has a metal top which will stand hard service and can be used for hot metals if desired.

Skeleton platform cars are used for carrying buckets, skips and similar loads for concrete and construction work; also for carrying plates and other material in mills and shops. Cars are frequently purchased in this form, the user adding a specially designed top or upper structure to suit some particular material to be handled.

Many other modifications in platform cars have been made to meet different requirements, a few of which may be referred to as typical of many others.

Cars with wooden frames often have the side sills extended and the ends formed into handles for convenience in lifting the car off the track; it is frequently desirable to

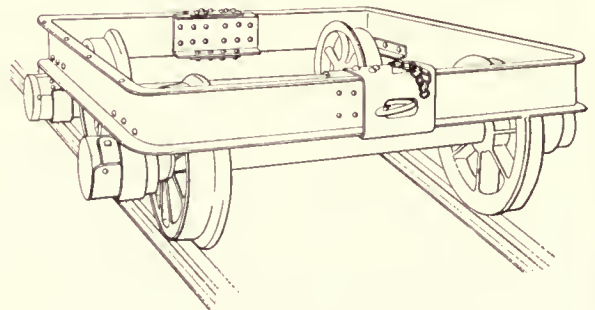

Fig. 5—Skeleton Platform Car

do this when the cars are used to push material around by hand and the tracks are also used for moving trains of cars by power.

In mills and shops it is sometimes desirable to lift the cars by a crane and transport them to a balcony or some

other point away from the track where cars are to be loaded or unloaded. In such cases the cars may be equipped with eye-bolts or lifting rings at the corners or with eyes fastened to the frame.

Where cars are used for transporting rails or bars, steel sliding plates are provided at the ends and rollers near the corners. This form is usually called a rail car.

Cars may be obtained with a swivel or revolving top for greater convenience in loading and unloading tubes and other long material.

Other modifications, such as charging box cars, annealing furnace cars, billet and ingot cars, together with special cars for bars and long forgings are described under the head of Mill Cars.

Double-Truck Platform Cars

Platform cars are also furnished with eight wheels, or double trucks, and are then often called flat cars. They are convenient for handling long, bulky or heavy articles which cannot readily be carried on the four-wheel cars. The carrying of heavy loads on eight wheels so distributes the weight that the capacity of the car may be doubled without necessitating the adoption of heavier track. In many places, where practically all of the material handled can be carried on four-wheel cars, the addition of a few double-truck cars will often be found advantageous for moving exceptionally bulky or heavy articles.

In general details, double-truck cars are similar to four-wheel cars except for the fact that they approach more closely standard gage railroad practice in such things as

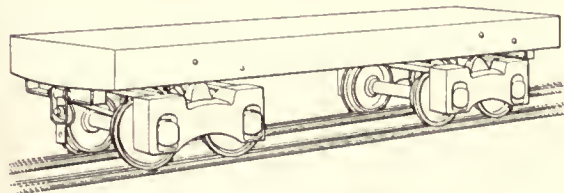

Fig. 6—Double Truck Platform Car

framing, couplers, brakes, etc. The bearings on this type of car usually are of brass, babbited, instead of the roller type.

The short double-truck platform car illustrated is designed to supplement the ordinary four-wheel platform car in carrying material in manufacturing plants. It has a platform 10 ft. long and 40 in. wide and is built for capacities of three, five and ten tons. The wheels have flanges on the outside such as are ordinarily used on

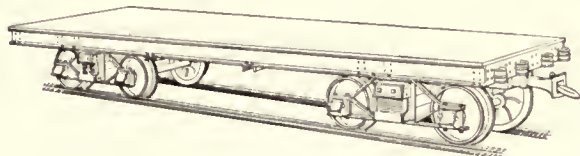

Fig. 7—Platform Car with Diamond Trucks

tracks of $21\frac{1}{2}$ in. outside gage. Similar cars are built with flanges on the inside of the wheels and for any desired track gage.

Diamond frame or arch bar trucks, so common in steam railroad practice, may be and frequently are used on industrial cars. Such double-track cars are made for any track gage, of such length as desired, and in capacities from two to fifty tons.

Details of the design may be modified to suit special conditions.

V-Body Dump Cars

Aside from platform cars probably no form of industrial car is more extensively used than the V-body dump type. It is the general utility car in many different kinds of industrial plants and is extensively used by contractors for various construction operations because of its adaptability for handling a wide range of materials. Among other things commonly carried by these cars are coal, ashes, sand, gravel, shale, rock, ore, earth, cinders, cement, concrete, clay, phosphates, nitrates, etc.; because of the steep angle of discharge, wet as well as dry materials may be dumped successfully. Cars of this type are used in mining and quarrying works; at sand and gravel plants; stone crushers; cement mills; fertilizer, phosphate and nitrate plants; powder works; smelters; clay, pottery, brick and glass works; by contractors for road paving, excavating and concrete work; in foundries for sand, slag and waste and in various other chemical and industrial plants.

The cars may be pushed by hand, hauled by power, or coupled in trains and pulled by a locomotive. In addition to operation on level ground they may be hauled up an incline and then dumped, as is done at some stone crushers and sand and gravel washers, or they may be hoisted on an elevator for dumping, as has been found convenient in handling concrete.

V-body dump cars, to meet the many requirements, are made in various sizes and shapes and differ considerably in details of design. They usually are built entirely of metal.

The bodies should be well reinforced around the top by angle irons, preferably rounded, or by other substantial means, as this is the part that receives the hardest usage. While the body is ordinarily of a decided V-shape, it is sometimes modified into more of a U-form, where greater capacity is desired and the materials dump easily. The ends are ordinarily straight, although in some designs they are inclined which is an advantage in dumping wet or sticky substances. Lifting rings or eyes are provided if cars are to be lifted by a crane.

These cars ordinarily dump on either side, but they can be built for end dumping. The shape of the car body and the steep angle of discharge is such that the load is usually discharged entirely clear of the track.

Considerable study has been given to so balance the body that it is not only easy to dump but will automatically return to an upright position unless it is desired to have a car which can be returned to the normal position only by hand. Cars are sometimes arranged for slow dumping under the full control of the operator, but this is not characteristic of the usual design.

The capacity, except in special cases, ranges from 12 cu. ft. to 5 cu. yd. The smaller cars are usually of the "trunnion" or "cradle" type and hold from 12 cu. ft. to 40 cu. ft., while the larger cars of $1\frac{1}{2}$ cu. yd., to 6 cu. yd. capacity are more generally of the "rocker" type.

The track gages ordinarily used are 24 in., 30 in. and 36 in. Cars may also be obtained for as narrow as 18 in. gage, or for standard railroad gage ($56\frac{1}{2}$ in.). For some industrial installations they are also made for $20\frac{1}{2}$ in. outside gage and equipped with swivel trucks.

Various locking devices or body fasteners are used. The locks are preferably applied on diagonally opposite corners so that they may be easily operated from the side without necessity for the operator reaching across or between the cars and so that when released the car will dump only on

the side away from the operator. This is a safety precaution which should not be overlooked.

Locks are commonly so designed that they will not only hold the body in an upright position while being transported but also in a partly tipped position, thus making it easy to load the cars by hand shovelling. In some cases the locks also hold the body in the dumping position which is at times convenient when handling sticky clay, wet concrete, etc., which may be a little slow in dumping and where it may occasionally be desired to scrape the car out. In some designs the catch automatically locks the body when it returns to the upright position.

While some of the smaller cars of this type are equipped with a hook so that they may be pulled by horse power; couplers are usually omitted as such cars are generally pushed by hand. The larger cars, which are more apt to be hauled by rope or by locomotives, are commonly equipped with couplers, ordinarily a simple form of link and pin. If trains of more than five or six cars are used they should be equipped with drawheads of the spring type.

Brakes may be of the ratchet, lever, or hand-wheel types but are so rarely used that they are ordinarily omitted. If

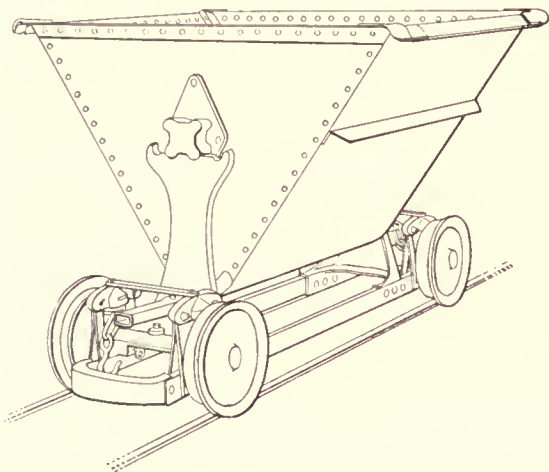

Fig. 8—V-Body Dump Car, Light Trunnion Type

they are used the frame is sometimes extended on one end to provide a platform on which the brakeman may stand.

The wheels are generally of chilled cast iron, although they are sometimes made of steel. They are ordinarily pressed on the axles which are preferably equipped with roller bearings. Brass or babbitt bearings may also be used and if desired one or all of the wheels may be loose on the axles and the wheels may be equipped with rollers in the hubs. The wheels are usually from 12 in. to 16 in. in diameter.

Cars of the trunnion type are usually made only in small sizes, ranging from 12 cu. ft. to 40 cu. ft. capacity. By using swivel trucks, a wheel-base of from 50 in. to 60 in. is possible; this permits the body being carried between the wheels, and gives a low center of gravity. Such cars are very convenient for loading. In dumping, the edge of the car comes down to the rail. This is desirable for unloading into a pit or from a trestle, but is not so convenient when the tracks are on a level floor. Small cars of the trunnion type are also made with a short rigid wheel-base and body above the wheels; this gives a car of compact design which is preferred in places where the load is dumped onto shop floors.

Cars of the cradle type are ordinarily built for capacities ranging from 18 cu. ft. to 40 cu. ft. with 24 in. track gage; 27 cu. ft. to 54 cu. ft. with 30 in. gage, and 27 cu. ft. to 81

cu. ft. with 36 in. gage. The cradle is fitted with double flanges so that the body can not jump off the support and is provided with bottom lugs to prevent the body moving sideways. The cradle support is curved and preferably

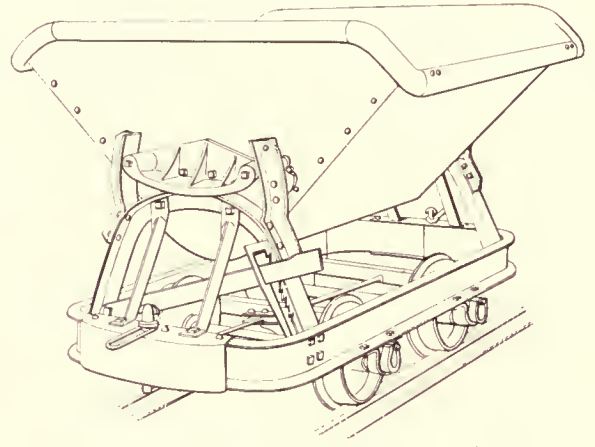

Fig. 9—V-Body Dump Car, Rocker Type

braced to secure end stiffness. The frame is of channel iron, rounded to do away with joints at the corners thus giving a compact, strong construction and avoiding interference between cars when passing around sharp curves. The journals are placed outside of the wheels. The car illustrated is equipped with a simple form of lever brake operated from the side of the car.

The rocker type car is similar to the cradle type, except that the body is provided with a rocker having projections engaging with holes in the horizontal rocker support on which the body rolls. This car is made in the same sizes as the cradle type. It is usually preferable for the larger sizes.

V-body dump cars of large capacity are also built. These are adapted for locomotive haulage and steam shovel loading. The substantial construction makes them also suited for the severe requirements of quarry service. The car illustrated has a frame with a square end and four longitudinal channel irons, the center ones being placed to receive a continuous spring type drawbar. This design is

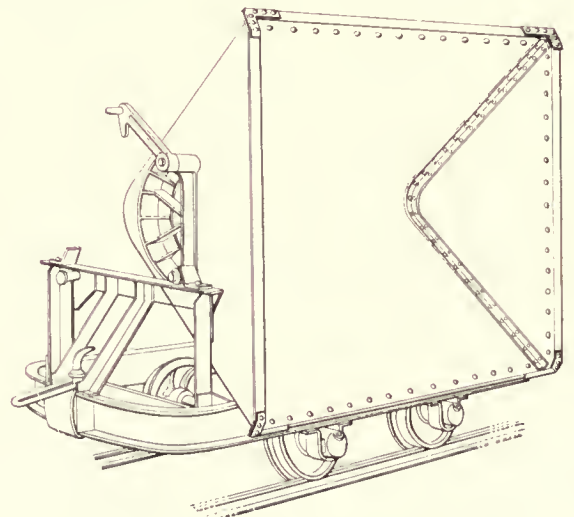

Fig. 10—V-Body Dump Car, Cradle Type

adapted to withstand the strains resulting from being hauled in long trains, on heavy grades and at fair speeds. For high

speeds, however, especially on poor track, it is best to use springs on top of the journal boxes.

V-body dump cars mounted on eight wheels, or double trucks, are also made for carrying heavy loads. This distributes the load so that light rails may be used. They often

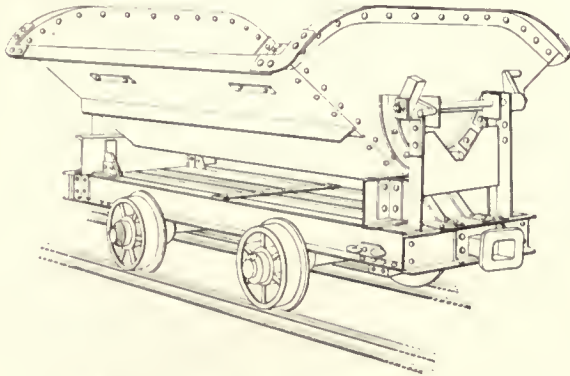

Fig. 11—Heavy Duty V-Body Dump Car

are built for standard gage railroad in capacities of as much as 40 tons and are used for handling garbage and waste.

The cars illustrated show the general characteristics, but there are many variations of this type of car designed to meet special requirements. Bodies are sometimes arranged to be lifted off from the frame by a crane and are fitted with short legs on which to stand. Another modification of this type mounted on a swivel base permits dumping in any direction. If salts or acid substances are to be handled the body can be lined with wood or preferably may be made of wood with galvanized body irons.

Scoop-Body Cars

Scoop-body cars are extensively used for handling coal, ashes, sand, gravel, crushed stone, ore and other loose materials and are particularly adapted for transporting wet or semi-liquid materials, such as concrete, mortar, wet sand, etc. They are the general utility car in certain concrete

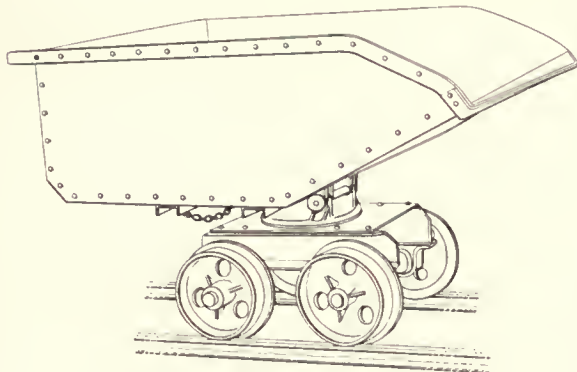

Fig. 12—Scoop Car, Upright Position

construction work, being used to handle muck from excavations, bring charges to the mixer and carry concrete to the point where it is to be deposited. For handling materials to be mixed in definite quantities these cars are sometimes provided with partitions, arranged to hold the right proportions of each material. They have also proved to be a very convenient car in mines and are used in many foundries, rolling mills and in forge shops for charging coke and coal into cupolas, furnaces and gas producers and are frequently used for removing ashes from boiler houses.

The body of these cars, being of scoop form and mounted on a swivel so as to permit of dumping in any direction, makes them particularly desirable for depositing the load in the exact location desired; in fact, these cars are frequently called "all-around dump cars." The operator is always on the side opposite to that on which the load is dumped and where he may easily reach the latch to unfasten it when it is desired to dump the car.

Several different types of latches are used, some being controlled by hand and others by the operator's foot. A handle is provided at the rear at a convenient height to assist in dumping and in returning the car to an upright position. The angle of discharge is so steep that even pasty substances are completely discharged. As the cars are used singly they are not equipped with couplers and rarely with brakes.

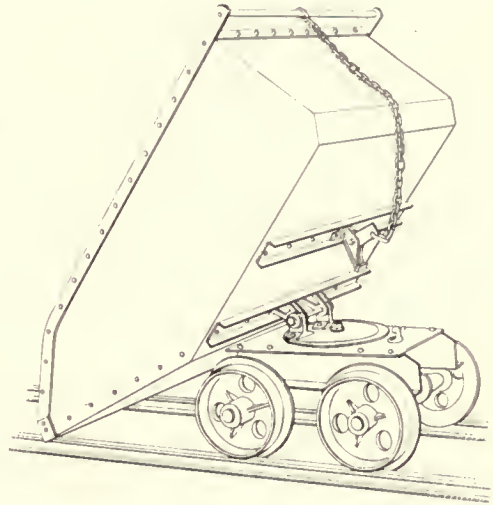

Fig. 13—Scoop Car, Dumping Position

As the cars are used singly they are not equipped with couplers and rarely with brakes.

The angle of discharge is so steep that even pasty substances are completely discharged.

As the cars are used singly they are not equipped with couplers and rarely with brakes.

Since the body is usually only from 30 in. to 36 in. wide, scoop-body cars can be used in very narrow passages which makes them desirable in certain mining work and elsewhere.

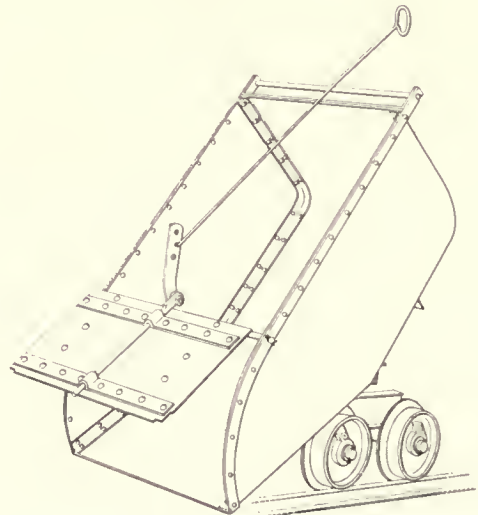
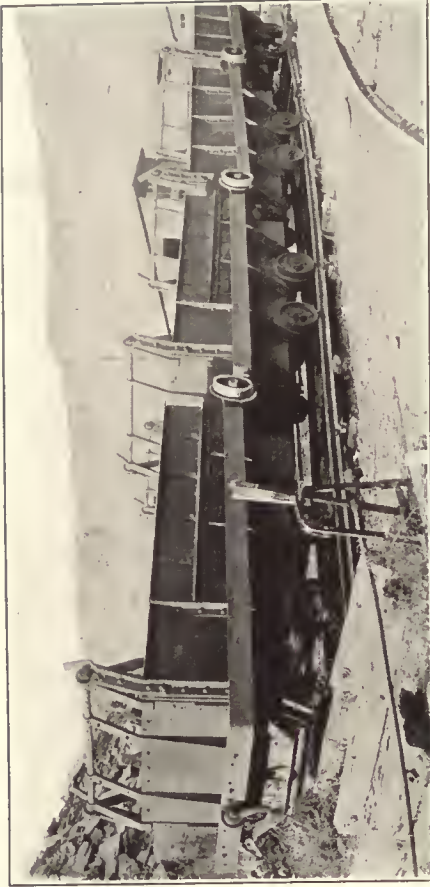

Fig. 14—Scoop Car with Gate

Since the body is usually only from 30 in. to 36 in. wide, scoop-body cars can be used in very narrow passages which makes them desirable in certain mining work and elsewhere.



Heavy Skip Cars for Quarry Service



Skip Cars Hauling Coal to Overhead Bunkers

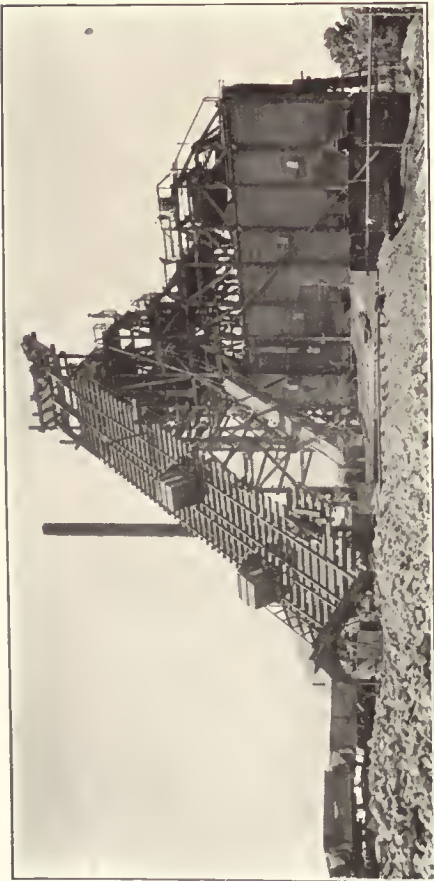

Skip Cars Handling Gravel



Skip Cars Handling Stone from the Crushers



Automatic Railway Handling Stone



Automatic Railway Delivering Coal from a Barge



Cable Haulage, Incline



Cable Railway Showing Curves



Combination Skip Hoist and Cable Railway

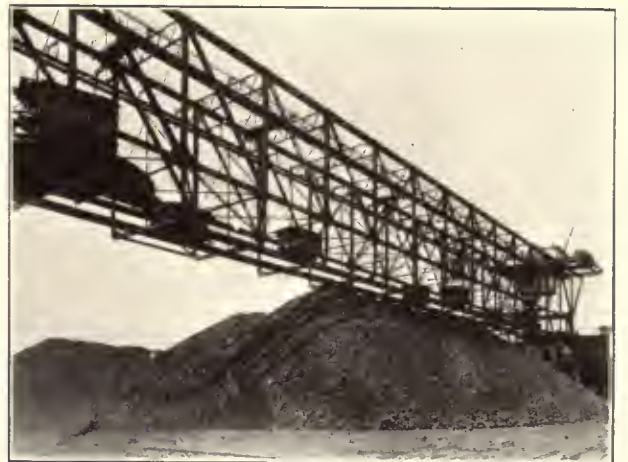

Distribution of Coal by Bridge and Cable Railway



Weighing in Transit

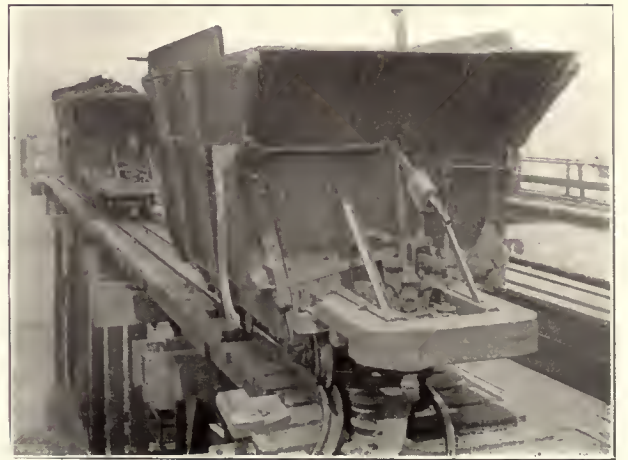

Cable Car With Automatic Dump Attachment

The height, from 36 in. to 44 in., makes hand loading easy.

Scoop-body cars are built for 18 in., 24 in., 30 in. and 36 in. track gage and of 12 cu. ft., 18 cu. ft. and 27 cu. ft. capacity. The wheels are of 10 in. or 12 in. diameter; and the wheelbase quite short, generally from 16 in. to 21 in. Square axles are ordinarily used with the wheels loose on the axles. The wheels are frequently of the self-oiling type but those with rollers in the hub are preferable.

For handling liquid or semi-liquid materials, such as concrete, end gates such as shown in one of the illustrations are frequently used to prevent waste in transit. The gates are furnished only when specified and are generally fitted with a rod and a handle so that the gate may be opened from the rear.

In the use of a swivel-base, scoop-body cars resemble the square body rotary dump cars and ore mining cars which are described elsewhere.

Charging Cars

Charging cars, while primarily designed for the transportation of coal from storage yards or bins to the boiler house, are also used for many other purposes where the car is to be unloaded by shoveling; they may be properly

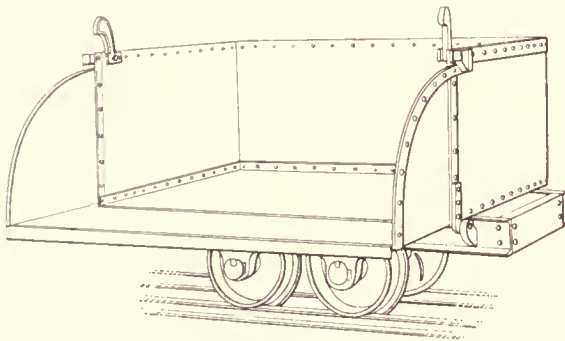

Fig. 15—Charging Car, Single Drop Side

classified with the general purpose cars. In all power plants where mechanical stokers are not installed, these cars running on an industrial railway constitute the most economical and convenient method of handling coal and ashes. By keeping the coal in the cars and shoveling direct from the cars into the furnaces the labor is much less than when the coal has to be shoveled from the floor. At the same time the conditions in the boiler room are much improved by freedom from the dust and litter which is so common where the cars are not used. The center of the track should be about 8 ft. from the front of the boiler, as this location with a height of platform of about 18 in. has proved to be the most convenient for the fireman.

The most commonly used charging car has one side arranged to let down and is always built of steel. When the door is dropped it is usually slightly above the bottom of the car so that the shovel will not meet with any obstruction. The track gage generally used is 24 in., although a good many installations have been made with 21½ in. outside gage. Cars for other gages are not sufficiently used to be considered. The usual capacity is one ton of coal, although many cars of one-half and one and a half tons are used, and for special requirements bodies are made of any dimension and capacity. Modifications frequently made are: Both sides arranged to drop so that the material may be discharged from either or both sides; one or both ends to drop instead of the sides. The second arrangement is

used where a narrow car is necessary and where the side doors can not be used. In this case both the bearings and the car body are inside of the wheels.

Wheels for charging cars are usually 12 in. to 16 in. in

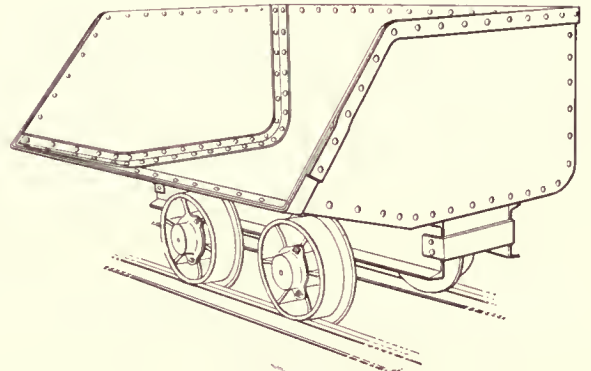

Fig. 16—Charging Car, Inclined Sides

diameter and are pressed on the axle, which has roller bearings; however, rigid axles with wheels loose on the axles and rollers in the hub are often used, especially where there is much curved track.

The scoop or inclined side type is preferred by some, as it is easier to shovel into for loading and it also is easy to shovel the material out. It is also made with one side scoop shape and the other side with a drop door, and it is frequently arranged to dump.

One of the illustrations shows a car with drop side and dumping gear for discharging on one side of the track. It has a flexible wheel-base and flanges on the outside of the rails. The dumping gear is completely under control during the dumping process so that there is a freedom from the shocks that occur when the body dumps solely by gravity. If desired, these cars can be made so that the load can be discharged on either side and the dumping controlled from the end instead of the side.

The charging car with rotary body and end doors is

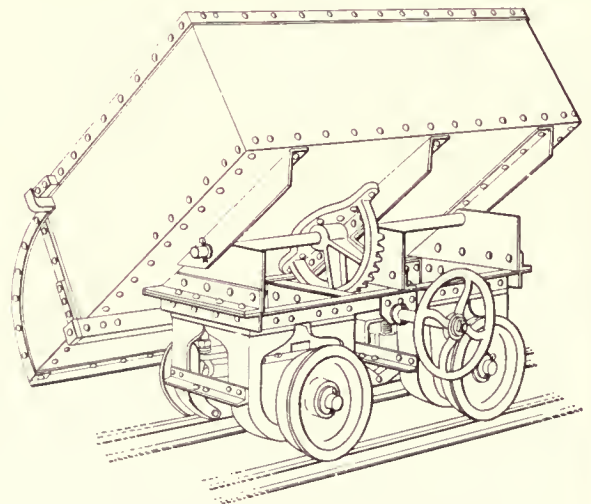

Fig. 17—Charging Car with Dumping Gear

another modification which will sometimes prove to be very convenient.

Other modifications of design can be made to most satisfactorily meet the requirements of the material to be

handled or the plant conditions, among which the following may be mentioned.

Doors may be hinged at the top instead of the bottom. This is rarely done except in cars with a dumping arrangement.

Increased capacity may be obtained by using higher sides with drop doors of the usual size. This type is convenient for handling coke and light material.

Cars can be arranged with two or more compartments, a modification which has proved to be quite convenient in smelting and refining works, brass foundries, etc., where several metals or other materials are weighed out and afterwards mixed. Compartments are also desirable in certain drop forge and machine shops where several different articles may be transported at the same time.

Charging cars are also made with flangeless wheels for running on steel or cast iron boiler room floors, or with special wheels having wide flat flanges suitable to carry the car when it is run off from the track and used on the floor.

In small boiler houses charging cars may be the only cars needed, but in larger plants V-body dump cars are frequently better adapted for handling ashes, as the dumping angle is considerably steeper. Scoop cars are also used

are also used at brick and tile works where they are commonly called "clay cars"; at quarries and rock crushers, and are also often used at small mines for conveying rock

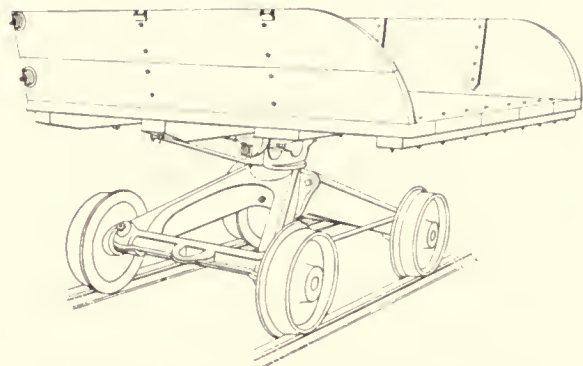

Fig. 19—Light Square Body Rotary Dump Car

from the screens to the waste pile, as well as for other purposes.

The particular design shown is generally used where the cars are pushed by hand. Brakes are sometimes used and are generally operated by a foot-power lever. Cars are usually made for 24 in., 30 in. and 36 in. track gage, but may be made for any other gage. Usual capacities are three-quarter, one, one-and-a-half and two cubic yards.

Another design of a rotary dump car, of a heavier type, is largely used in certain classes of construction work, being particularly useful at the end of trains where it is desired to dump over the end of an embankment or through a trestle. The car is substantially built for heavy service. It may be dumped on either side, or at one end. To permit of end dumping the draft timbers are shortened at one end and to insure stability in transit the overhanging weight of the load is carried on a roller, the body being turned around for dumping. A bar or coupling rod is used when the dumping end is connected to other cars in a train. The car is equipped with an automatic end gate provided

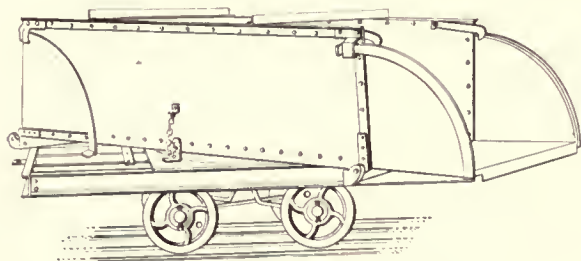

Fig. 18—Charging Car with Rotary Body

for the same purpose especially where the ashes are delivered to a skip hoist and platform cars are used where the ashes are taken out in ash cans. Gable bottom cars or hopper bottom cars are the most convenient type for handling coal which is dumped from a track or other elevated point into a bin.

In iron foundries charging cars are commonly used for handling coke, small scrap, sprues, gates and limestone up to the charging floor of the cupolas. Where a charging machine is used, or where the load is tipped directly into the door of the cupola, special cars are used and will be found described under the head of foundry cars.

Square-Body Rotary Dump Cars

These cars, often called simply rotary dump cars, are quite similar to scoop-body dump cars, the principal difference being that they have a body of a somewhat different form.

In the lighter types the body is sometimes made of steel, but is usually constructed of oak and is frequently lined with sheet steel, which should be done if the cars are to be used to handle rock or shale. One end is generally left open, as shown in the illustration, for convenience in loading and in dumping, but a sloping end is sometimes used. On account of their low height which permits of easy hand-loading, their lightness and their ability to receive and discharge the load in any direction, this form of car is used for many classes of construction work. They

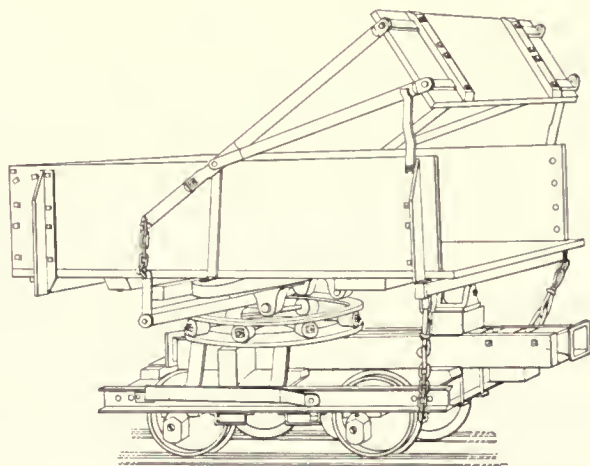

Fig. 20—Heavy Square Body Rotary Dump Car

with an attachment for holding it in an open position for loading by hand shovel. This design is made in the same sizes and track gages as the light design.

For large construction operations neither square-body rotary dump cars, scoop-cars nor V-body dump cars are as

convenient or as economical as box-body dump cars.

Other designs of small rotary dump cars, used in many ore mines will be found under the head of Ore Mine Cars.

Box-Body Dump Cars

Cars of the box-body type are used much more extensively than any other kind, in many fields of construction work. They are generally referred to as "dump cars," although they are sometimes called two-way dump cars to distinguish them from one-way dump cars. This type of dump car is especially adapted for extensive operations in steam and electric railroad construction, highway construction, the building of dams, and in any place where there is a large amount of material to be handled. They are used to handle earth, clay, crushed rock, sand, gravel, coal, coke, cinders and all kinds of loose bulk material ranging from soft mud to hard rock. In addition to the construction field, where excavating, filling and ballasting are done, they are also employed around many industrial plants for the carrying away of waste materials, such as burned out sand from foundries, accumulations of slag, ashes, cinders and miscellaneous refuse. They are also used at iron, copper and coal mines, brick kilns, cement plants, ore reduction plants, stone quarries and rock crushers, gravel and sand pits. They are also useful in moving such materials as pig iron, castings, small forgings, steel billets, rail ends, etc.

Because of the importance of box-body dump cars and the large number used, considerable attention has been given to the details of design. Some desirable features which should be given attention in the selection of a car are: Staunch construction to withstand rough usage; ability to ride well on poor track, so as to avoid spilling; ability to stick to the track both in transit and while being dumped; body low and broad, for ease in loading by hand, and quickness in filling by steam shovel, and safely secured in a horizontal position for filling and for transit; door held in a well elevated position for filling by hand shovel; dump readily with a small amount of power and return easily to the horizontal position; acute angle and smoothness inside to insure clean and rapid dumping; load thrown clear of track, so that bed in dumped position clears unloaded material without hand shoveling.

Hand Operated Two-Way Side Dump Cars. The smaller sizes of box-body dump cars are loaded either by hand or by steam shovel and are dumped by hand. In small operations they may be pulled by a horse but are usually hauled by some type of industrial locomotive. A car of 1½ cu. yd. capacity, level load, for 24 in. gage track is shown in the first illustration. The dumping angle is approximately 45 deg.; the automatic side doors give a wide discharge opening; the underframe and running gear are simple; and the steel lining adds to the durability as well as to the ease with which the load is discharged. A larger car of the same general type but of 4 cu. yd. capacity and built for 36 in. gage track is also illustrated.

In these cars, the side door can be lifted and held locked in an open position for ease in loading by hand shovel.

Hand dumped cars are usually built of 1 cu. yd. and 1½ cu. yd. capacity for 24 in. gage track; 1½ cu. yd., 2 cu. yd. and 3 cu. yd. for 30 in. gage; 3 cu. yd., 4 cu. yd. and 5 cu. yd. for 36 in. gage, and 6 cu. yd., 7 cu. yd. and 8 cu. yd. for standard gage, all being mounted on four wheels. Similar cars, but mounted on double trucks or eight wheels, are also made of 8 cu. yd., 10 cu. yd. and 12 cu. yd. capacity for standard gage tracks.

The capacity of box-body dump cars is rated as water level, or even full, but by heaping up, they will carry from 20 per cent to 30 per cent more than their rated capacity.

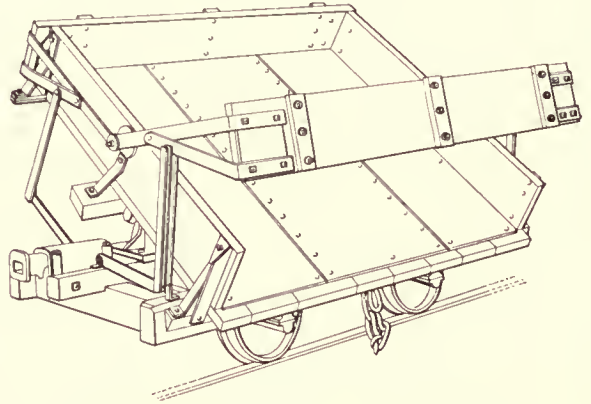

Fig. 21—Hand Operated, Dumping Position

There are obvious advantages in the use of cars of the larger capacity, but there are also limiting factors which do not always make this desirable. For certain work on a 36 in. gage track, which is extensively used in construction

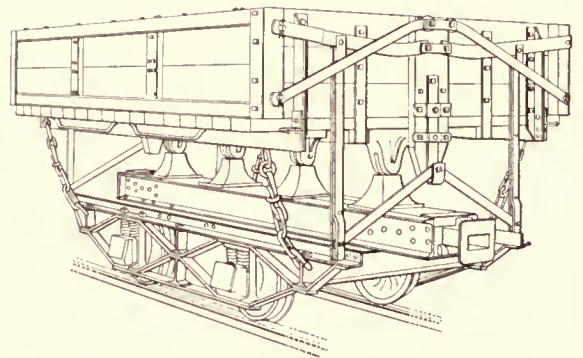

Fig. 22—Hand Operated, Running Position

work, a 4 cu. yd. car is preferable to a 5 cu. yd. car because of its lighter weight, lower height and the fact that it can be used on lighter rails and softer trackbed.

Air Operated Two-Way Dump Cars. Air-operated dump cars usually are used for large operations where standard gage tracks and double truck cars are the rule. As the hand-operated side dump car has largely superseded the gondola car with hinged side doors which was unloaded by a plow and the A-frame car with which considerable hand shoveling was often required, so the hand-operated side dump car is being replaced by the air-operated side dump car for such railroad work as widening roadbeds for laying additional tracks, trestle filling, reducing grades, track elevation in cities, ditching, building yards, etc.; for the construction of canals and large dams and for the stripping of large beds for open mining of coal or of iron.

The operation of dumping being under the control of the engineman and being practically instantaneous results in considerable economy in labor and in time. The ability to dump while running is also an advantage in distributing the material. Most air-operated cars can also be dumped by hand if it is not convenient to connect them to the air system.

Two general types of air dumping mechanism are in common use. The first employs a long horizontal cylinder which operates through a cable passing around sheaves, while the second uses a short stroke vertical cylinder di-

rectly connected to the bottom of the bed. Cars of the long cylinder type require side chains, the same as used on hand dump cars. Such cars of 12 cu. yd. and 16 cu. yd. capacity have been used extensively for a number of years by con-

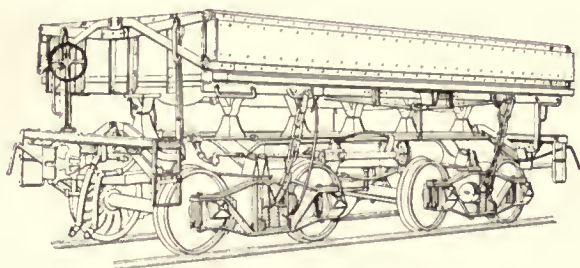

Fig. 23—Air Dump Car, Long Cylinder

tractors. The 12 cu. yd. car is light enough for use on soft tracks, is substantial enough for steam shovel work and large enough to be economical on short and medium length hauls, while the 16 cu. yd. car is preferable for longer hauls and on more substantial tracks. A car of 20 cu. yd. capacity is better adapted for railroad work and in stripping for large mining operations. Cars with vertical cylinders are known as "automatic" because means are provided for shutting off the air from the cylinder when the dumping position is reached and because the bed is locked or unlocked by the operation of the cylinder, thus making the use of side chains unnecessary.

To provide for cases where the locomotive is not equipped with an operating valve and hose connection, the cars can be equipped with storage reservoirs which are charged from the brake pipe, and which hold sufficient air for the operation of the cylinders. In this case the unloading of the cars is controlled by a dumpman who can be stationed at any point on the train. All of the cars in a train can be dumped together or each one can be dumped separately.

Automatic air dump cars are built in capacities of 16

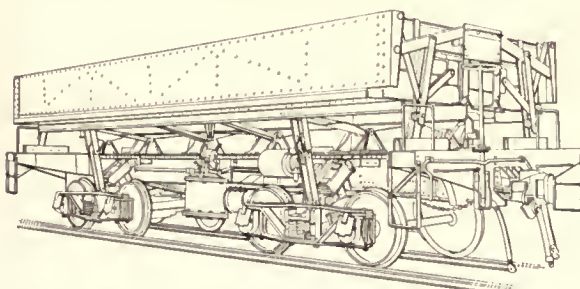

Fig. 24—Air Dump Car, Vertical Cylinder

cu. yd., 20 cu. yd. and 30 cu. yd., all for standard gage tracks. Cars of 20 cu. yd. capacity are extensively used in railroad construction and maintenance and also in quarries and at iron and copper mines. There is a tendency, however, in many operations to use a car of 30 cu. yd. capacity.

Special Box-Body Dump Cars. In addition to the common forms of two-way side dump cars already described, a number of modifications can be made to meet special conditions or for the character of the materials which they are designed to handle. A few of these will be mentioned.

Cars can be arranged to dump on one side only instead of on both sides. This is sometimes desirable in small hand-dumped cars.

An automatic dumping attachment can be provided on

one-way dump cars. Self-dumping is obtained by the use of a movable roller on the side of the car which is connected by levers to the body. At the desired dumping point an inclined rail terminating in a horizontal portion is placed alongside of the track in such a position as to engage with the roller, and when the roller runs up the inclined rail the body is dumped.

Cars may be arranged to dump over one end instead of on the side. This modification can be applied to cars of from 1 cu. yd. to 6 cu. yd. capacity.

Small cars of 1 cu. yd., 1½ cu. yd. and 2 cu. yd. capacity and of the end dumping style can be mounted on a swivel-base so as to dump in any position. (See Rotary Dump Cars.)

In the construction of the New York aqueduct a specially designed car of 40 cu. ft. capacity and 30 in. track gage was used. The body was carried on rockers of a design similar to that used on many V-body dump cars. The doors were hung at a considerable distance above the bottom of the bed so as to secure a wide opening, and to provide

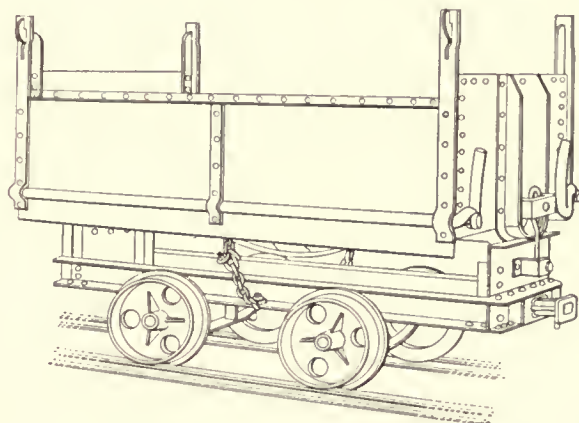

Fig. 25—Small Box-Body Quarry Car

for handling very large rocks the doors were designed so that they could be easily lifted off. The same design has also been found quite useful in general quarry work.

For use around industrial plants, in mines, for coaling locomotives and for other purposes small box-body cars of special design and arranged to dump on the side or on the end have been found to be satisfactory.

Hopper Bottom Cars

Hopper bottom cars are suitable for use where the load can be dumped between the rails of the track. They are extensively employed in steam railroad service for handling coal, ore and other substances and are used in the industrial field for moving such loose bulk materials as coal, ashes, coke, sand, gravel, crushed stone, earth, cinders, clay, shale, ores, soda ash, phosphates, fertilizer, etc. They have been found useful at many manufacturing plants, power houses, railroad terminals for coaling locomotives, chemical plants, fertilizer works, coal mines, ore mining and refining operations, smelters and for filling and for ballasting tracks.

As the load is deposited between the rails, it may be dumped from a trestle or elevated track into a bin, or there may be a receptacle underneath the track and a conveyor provided to carry the material away.

Hopper bottom cars for industrial purposes range from a very light car for 24 in. gage and a capacity of 15 cu. ft. to a standard gage car carrying a load of 100,000 lb. or more.

As the requirements are so diverse, there are no standard designs for hopper bottom cars. The small cars most generally used are for track gages of 24 in., 30 in., and 36 in. and a capacity of 2 cu. yd., 3 cu. yd., 4 cu. yd. or 6 cu. yd.

The first car illustrated is of small capacity and has a bottom slide controlled by a hand lever. Various designs of

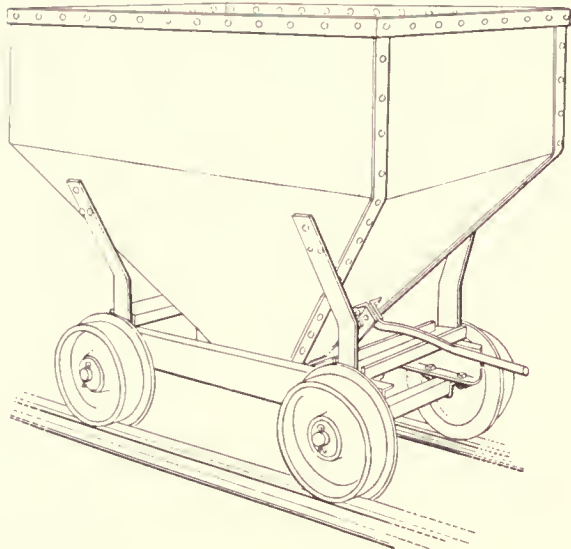

Fig. 26—Hopper Bottom Car, Light Service

doors of the sliding type are used but most cars are equipped with doors of the drop type, in which case two doors are generally used for each hopper. Drop doors may be hinged either crosswise or lengthwise of the car and may be controlled either from the side or the end of the car. When in the dumping position the doors ordinarily just clear the track.

The car bodies are generally made of steel but wood is quite frequently used, particularly for handling coal. Wooden bodies are also commonly used for handling clay, sand, shale, etc. For such purposes the sides are made quite steep so as to give large bottom doors of the drop type.

A hopper bottom car suitable for heavier work and arranged to be hauled in trains is shown in the second illustration. Drop doors are used which are opened and closed from the side of the car. In this particular case

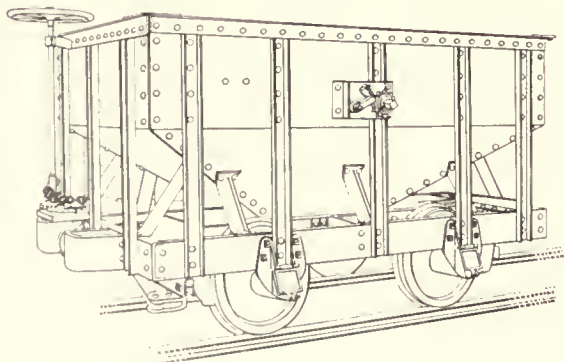

Fig. 27—Hopper Bottom Car, Heavy Service

a removable lever is employed for dumping the car, but a fixed handwheel is frequently substituted. The car is

equipped with a hand brake operated by a staff and hand-wheel similar to that used on freight cars. Others forms of brakes are used, a common form being that controlled by a long hand lever on the side of the car. The coupler is of the hook type and is equipped with a spring.

Cars of the same general design and of about five tons capacity are particularly well adapted for handling zinc, lead and other high grade ores.

For handling iron ore, a larger car of from 15 tons to 20 tons capacity is often used. If the track is sufficiently substantial such a car may still be mounted on four wheels when spring supported. Cars of even smaller capacity are, however, commonly mounted on double trucks.

"Monitor" cars used on inclines around coal mines are frequently of the hopper bottom type. For this service automatic dumping is often employed, the doors being arranged to be opened and also closed by trips either between the rails or at the side of the track.

For certain concrete construction operations, hopper bottom cars are employed. Such cars have a narrow bottom opening the full length of the car controlled by a radial gate and a long operating lever. These cars are also usually provided with a crane hook connection.

Gable Bottom Cars

Gable bottom cars are particularly well adapted for use on inclined and elevated tracks or trestles. The facility with which the load may be dumped, either automatically or by hand, makes them the most efficient and economical type of car for delivering many kinds of loose bulk ma-

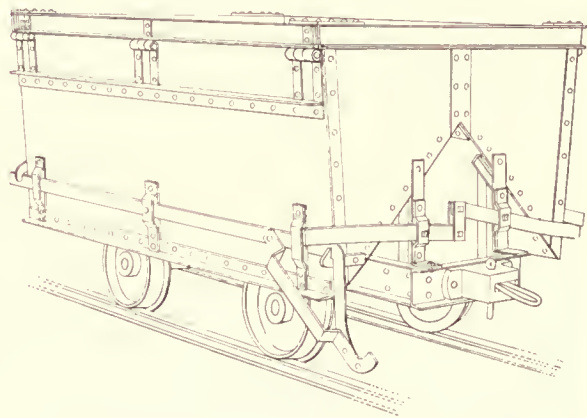

Fig. 28—Gable Bottom Car, Automatic Dumping

terial to storage bins. With slight modifications they are the universally used cars for the automatic and cable railways so commonly employed on the water front along the seaboard, rivers and lakes for handling coal for domestic and industrial purposes from vessels and barges to storage bins and pockets.

In addition to being used at coal yards and power houses, gable bottom cars are employed at mines for handling iron and copper ore, and for disposing of waste rock; at brick yards for bringing material from clay and shale banks; at sand and gravel pits; at fertilizer and chemical plants, and at quarries for crushed stone. Phosphates, salt, cement, coke, charcoal, ashes and even pig iron are also handled in these cars.

The shape of the inclined bottom is such that the load is discharged well clear of the tracks. While the angle of the bottom is ordinarily that best suited for handling

coal, it can be modified so as to be equally well adapted for other substances. Usually both doors are connected together so that when opened the load is discharged equally on both sides at the same time, but if desired the doors can be arranged to be operated independently.

The first car shown is equipped with a door-locking device, so arranged that the levers are released by striking a trip placed alongside the track, and the load is dumped on both sides at a pre-determined point. Many other designs of door-locking devices are used which are operated automatically or by hand and in some cases by an air cylinder.

The car bodies are made of steel, or of wood either plain or steel lined.

There are so many different modifications called for to meet special conditions imposed by the nature of the materials handled or by the local surroundings there is no standard design. However, cars of capacities ranging from 25 cu. ft. to 80 cu. ft. and for track gages of 24 in., 30 in. and 36 in. meet the more common requirements. These cars are also frequently made for 21½ in. outside track gage, to some extent for 42 in. track gage and can be made for any other capacity or track gage. Cars for narrow-gage tracks are in use which have a capacity of from

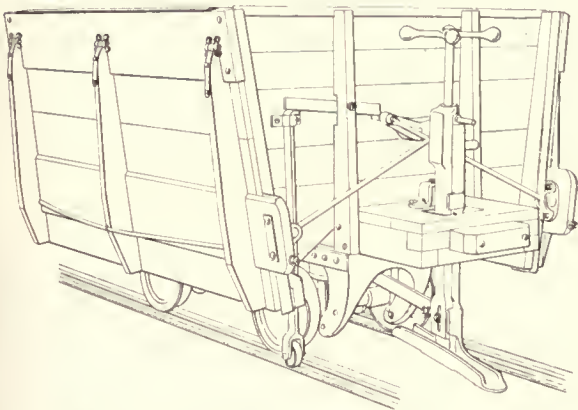

Fig. 29—Cable Bottom Car for Cable Railway

300 cu. ft. to 400 cu. ft. and for a load of as much as 10 tons, while similar cars for standard railroad gage tracks may have a capacity of 50 tons.

The smaller cars are always carried on four wheels, but double trucks are required for the larger cars.

The sides are higher than for flat bottom cars of the same capacity. For handling ashes, coke, charcoal and light substances the height is still further increased.

If the cars are to be pushed by hand, couplers are omitted; but in most cases couplers are required, a simple form of link and pin being the type most used.

Brakes of any desired type can be applied if required.

Cars may be hauled by a locomotive or may be arranged for any other method of propulsion. If the cars are used on cable railways they are equipped with a cable grip and provided with a platform for the operator. The one illustrated is typical of such cars which are made in a variety of designs, wheel gages and capacities.

Cars used on automatic railways ordinarily have wooden bodies, lined with steel plate, sloping ends, and a long wheel-base which permits of the body being carried low between the wheels. If material other than coal is to be carried the angle of the bottom should be designed to suit. The capacities usually employed are one and two tons. The doors

are usually operated automatically by a movable tripping block at the side of the track. A pick-up attachment will be noticed on the front of the car shown, arranged to engage with a cross-bar connected to a counterweight which auto-

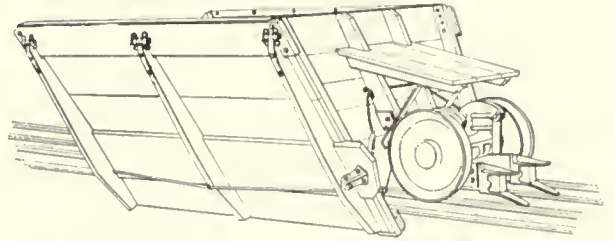

Fig. 30—Hopper Bottom Car for Automatic Railway

matically returns the car to the loading point after it has been dumped.

Under certain operating conditions it has been found to be an economical arrangement to employ self-propelled gable bottom cars equipped with electric motors.

Cars with sloping bottoms, and arranged to discharge on one side only or on one end only are also built but, as the slope is only one distinction, they are not gable bottom cars although they resemble them somewhat.

Inclined Bottom Cars, Side or End Dump

While inclined bottom cars of the hopper bottom type which discharge in the center, or of the gable bottom type which discharge on both sides, answer the requirements in most instances, there are some places where inclined bottom cars which discharge on one side only, or on one end only, are more satisfactory. Such cars are built for any track gage and of many different designs.

One of the most extensive uses for cars of the general type shown in the first illustration is for the handling of concrete. For this reason it is frequently called a "concrete car," and is also known as a "hopper" or "bucket" car, although the last name is applied by some only to a modification in which the ends are vertical or without the batter shown in the illustration. This change of design makes it possible to use a much larger radial gate which is of ad-

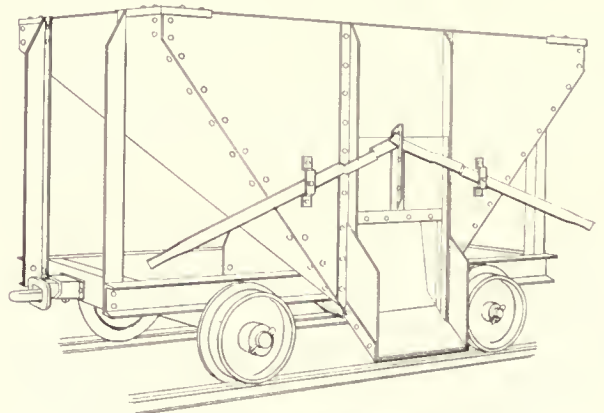

Fig. 31—Inclined Bottom Car, Lift Gate

vantage when placing concrete, which is somewhat stiff, and it does not interfere with the use of the car for handling sloppy concrete. The larger gate is also of advantage if the same car is used for handling dry aggregates, etc., in addition to concrete.

For concrete construction work radial gates are preferred



Creosoting Car for Ties



Creosoting Car for Poles



An Economical Arrangement for Handling Ties



Cane Car and End Dumper



Small Foundry Ladle Cars



Cupola Charging



Core Oven Car



Trunnion Dump Car for Ash Handling



Swivel Top Car for Rods



Annealing Oven Car

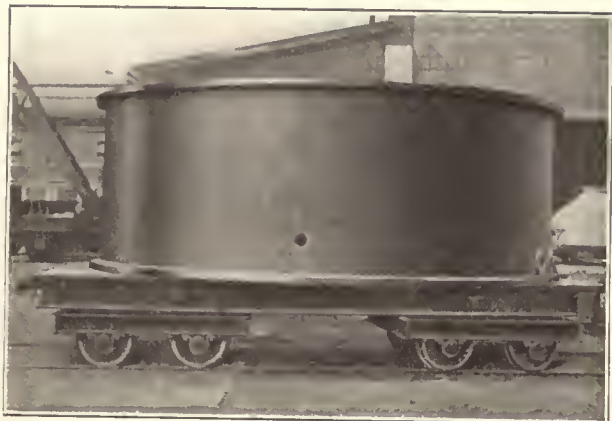

Double Truck Car for Heavy Castings

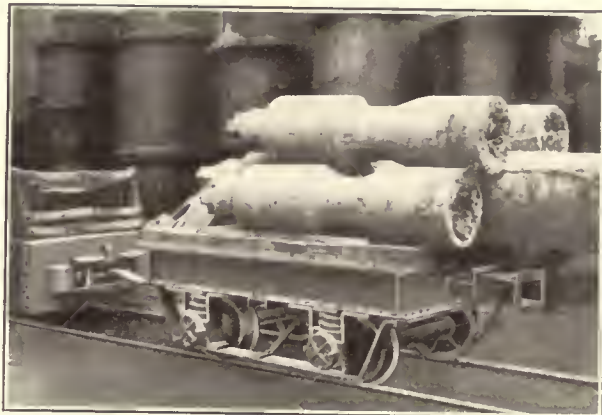

Heavy Type Four-Wheel Platform Car

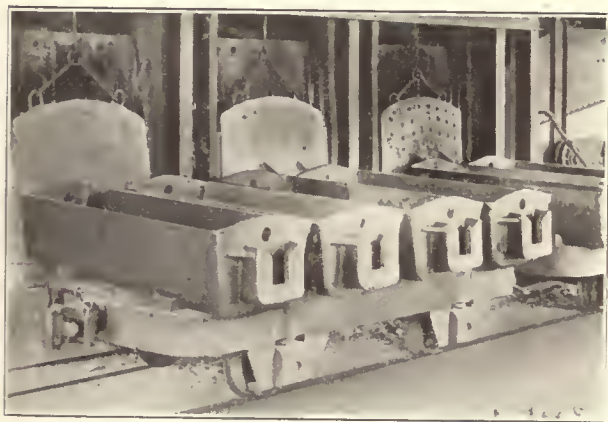

Furnace Charging Box Car

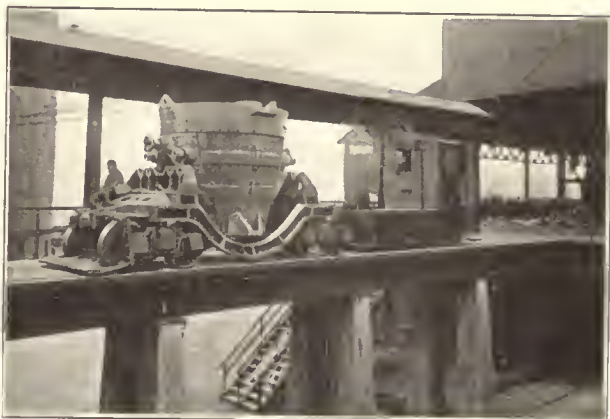

Steel Ladle Car and Electric Locomotive



Hopper Bottom Ore Cars

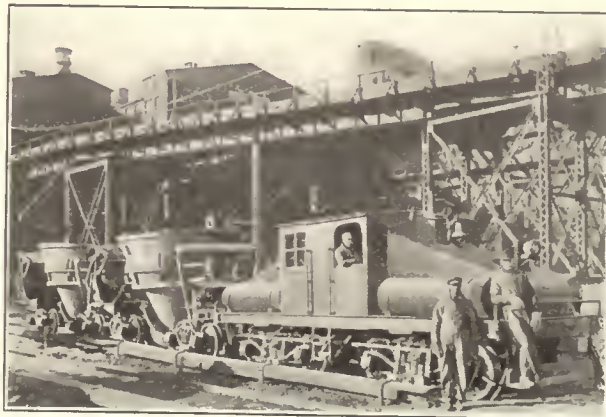

Electric Locomotive and Ladle Cars at Smelter

because they can be made grout tight, are easily operated and give the most satisfactory control of the discharge.

While these cars are used in many kinds of concrete construction they have been found to be particularly desirable

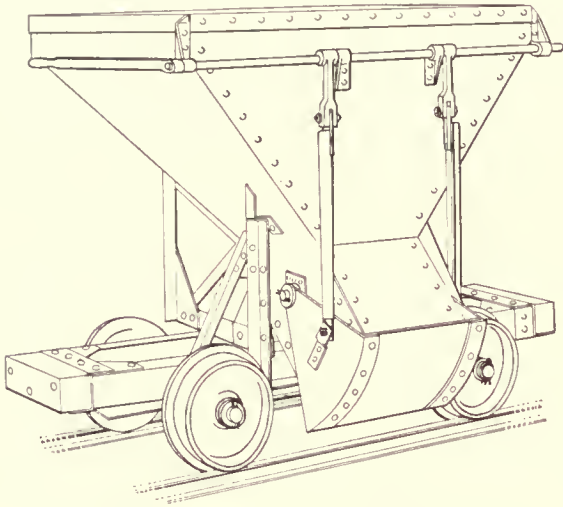

Fig. 32—Inclined Bottom Car, Radial Gate

in some bridge and pier work where they have saved the installation of a more expensive cableway.

Cars of this type are usually built for track gages of 24 in., 30 in. and 36 in. and of capacities ranging from $\frac{3}{4}$ cu. yd. to 2 cu. yd. although larger and smaller cars, as well as those for other track gages, are sometimes desirable. Cars with the discharge at the end are also available.

Cars with radial gates are ordinarily used for handling concrete and aggregates and can also be used for handling many other materials, but, for general purposes, sliding gates with chutes are preferable. Such cars are used for handling coal, sand, gravel, cracked ice, etc., and can also be used for concrete. For lighter materials, such as ashes, a similar car with higher sides is often used. If preferred, and space permits, a longer circular spout can be substituted for the chute. For narrow passages the chute can be arranged to fold back against the car body.

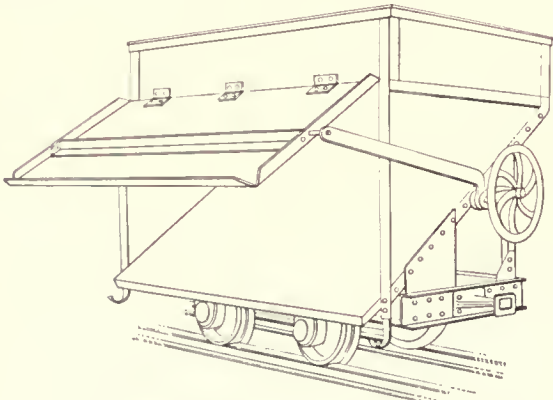

Fig. 33—Incline Bottom Car, Hinged Gate

If desired, cars may be obtained with end instead of side discharge. A similar car, water-jacketed and with modified doors, is in use for handling incandescent coke at gas works. In the coke regions a large quenching car with inclined bottom and perforated lift doors on the sides is used for conveying coke from the ovens. Such cars are of standard

railroad track gage, about 50 ft. long and of 10 tons coke capacity.

For handling coal and some other kinds of loose bulk material it is frequently desirable to have a larger discharge opening than can be obtained by a sliding gate. To meet such a demand inclined bottom cars are also constructed with a large hinged door. The design is sometimes modified by hinging the door at the bottom and providing it with end pieces, so that when let down it acts as a chute.

Doors may be arranged to be opened by a trip if automatic dumping is desired. Couplers and brakes are provided, if conditions of service require their use.

Creosoting, Charcoal and Acetone Cars

Creosoting, charcoal and acetone cars, while differing in certain features, have so many points of resemblance and are used in such similar industries that they have been classed together for convenience in treatment.

Creosoting Cars. The treating of wood with creosote or other preservatives is an extensive and important business. As the pieces which are treated range in size from a paving block to a telegraph pole, a number of different designs of cars are required to meet the varied needs.

Creosoting cars are of an approximately circular shape and are built to run into cylinders which are commonly of from 6 ft. to 7 ft. in diameter. They may be mounted on single or double trucks. The track gages generally used are 24 in. or 30 in.

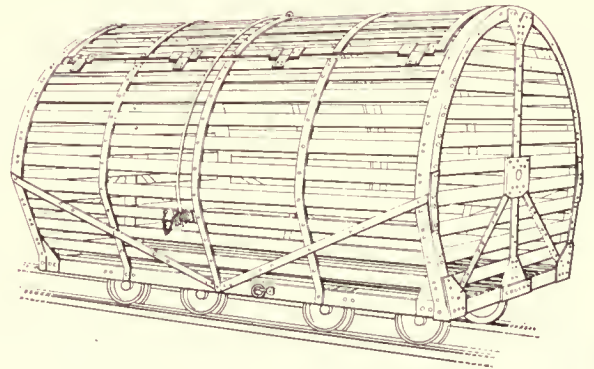

Fig. 34—Creosoting Car for Blocks

Cars used for treating paving blocks, such as used for streets and factory floors, also for treating telephone cross-arms and other short pieces, are usually of steel-slat construction, which allows a free circulation of the treating compound and a quick draining off of the liquid when the car is withdrawn from the compound.

Two doors are ordinarily provided at the top so arranged that they can be quickly and easily fastened and unfastened. The cars must be strongly built, as they are usually lifted by a crane or derrick and turned over for unloading. Trunnion plates, with or without trunnion pins, are provided in the center of each end and rings or links are attached to the side sills. The usual length is from 8 ft. to 10 ft.

Instead of being constructed entirely of steel slats, the sides and ends of such cars are, sometimes built of steel plates, perforated for the circulation of the treating mixture, the slat construction being used only for the floor.

If the cars are not to be turned over for dumping, end or side doors may be substituted for the top doors.

Cars used for treating railroad ties, fence posts and short timbers have two yokes, usually formed of angles or chan-

nels and are mounted on four wheels. The usual length is about 6 ft.

For handling telephone poles, piles and long timbers two cars are required, one at each end. These cars usually have

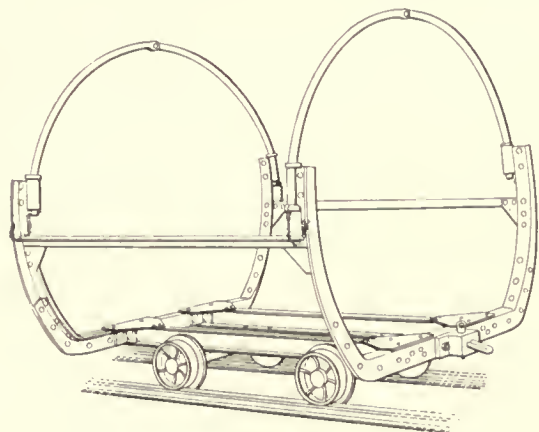

Fig. 35—Creosoting Car for Ties

only one yoke mounted on a swiveling bolster to enable the train to pass around curves and through switches.

A special combination car is used in some places instead of a car with a single yoke, as illustrated. Such a car is similar to the double yoke car used for treating ties but has the body mounted on a center plate resting on an underframe so that it is free to swivel when used for long poles, but can be held rigid by pins when used for ties. Where both ties and long poles are treated such a double-purpose car has obvious advantages.

Charcoal Cars. The old method of producing charcoal was to make a pile of wood and cover it with earth, leaving a few small openings to admit a limited amount of air and allow the gases to escape when the wood was ignited. After enough wood had been burned to insure a thorough charring of the mass the openings were

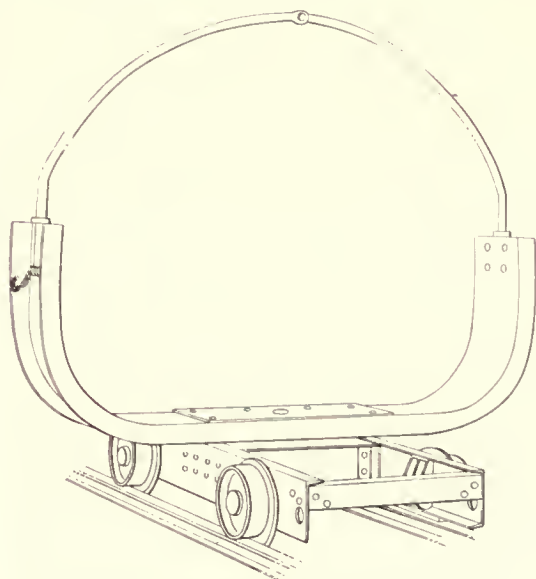

Fig. 36—Creosoting Car for Long Poles

closed and the pile allowed to cool slowly. By this method all volatile constituents were allowed to escape and only a small amount of tar was recovered.

The wood, in the method now largely followed, is placed in

a car and pushed into a closed retort where the heating takes place. This gives a distillation in which a large amount of tar, creosote, methyl alcohol, acetone and acetic acid are obtained and at the same time the yield of charcoal is also nearly doubled.

Charcoal cars are of steel-slat construction and are provided with side curtains which can be lifted off, or are hinged at the top and can be turned up and fastened in an open position.

Cars holding 2 or 2½ cords of wood and for standard gage tracks are extensively used. Such cars are about 5 ft. 4 in. wide, 7 ft. 2 in. high and from 11 ft. to 12 ft. 6 in. long over all. Four-wheel trucks with 18 in. to 20 in. wheels are common.

Special cars of other sizes and for narrow gage tracks are also employed. For narrow gage tracks the wheels are usually inside of the frame and boxed over. If circular retorts are used, the cars are of a shape to suit and in appearance resemble creosoting cars for paving blocks.

Acetone Cars. These cars, which are used at charcoal distillation plants, are of slat construction and in

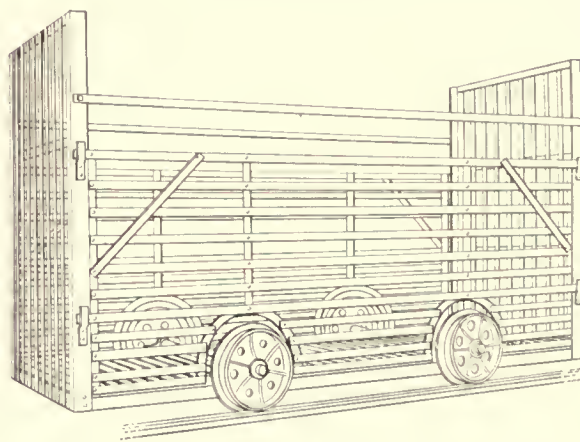

Fig. 37—Charcoal Car

general appearance resemble creosoting cars for ties. They are provided with rack frames for holding tiers of shallow pans.

Logging and Lumber Cars and Trucks

So many things help to determine the character of the equipment used in logging operations that there exists a wide variety of apparatus in different locations. These include the extent of the territory being lumbered, the character of the country, the proximity to streams and railroads, the distance from the mill, the methods used for skidding and loading, and the diameter and length of the logs. The logs may be skidded in some places by teams to the banks of a stream, down which they are driven to the mill. In other places they may be loaded on trucks or trailers and hauled out by traction engines or by track laying gasoline tractors. In still other places the logs may be brought in by cableways and loaded on special cars by log-loaders, after which they may be hauled for long distances to the mill.

In many northern operations the logs are gotten out in the winter time when there is plenty of snow, which permits of economical hauling by teams to streams or railroads.

Simple railroads which can be built for a relatively small expense are used to a large extent. As such roads are frequently taken up, no more grading is done than is necessary and the grades are often quite heavy.

In some places log roads are used. In such cases logs of about 10 in. diameter are usually selected and laid on 48 in. centers. On roads of this kind the wheels used on the cars are of spool shape, a common size being 18 in. diameter at the center and 24 in. diameter on the sides.

Flat wood rails are also used for logging roads and are also employed around many mills. In this case the car wheels have flat treads of 5 in. to 6 in. face and special flanges, $2\frac{1}{2}$ in. to 3 in. high. The cars may also be equipped with wheels that can be used on either wood or steel rails. These also have wide flat treads and flanges $1\frac{7}{8}$ in. to 2 in. high. While unchilled cast iron wheels are sometimes used on wood rails, the greater durability of chilled iron wheels makes them preferable.

Steel rails are used in some instances and are laid for 36 in. track gage. Most logging roads are, however, laid on $56\frac{1}{2}$ in. gage, so that standard gage railroad cars may be run over the roads and cars of loaded logs may be delivered to and hauled by the railroads without reloading. The car wheels used on roads equipped with steel rails are of chilled cast iron except in a few cases where steel wheels are used.

Logging Cars. Originally four-wheel cars were used for logging work but they are now rarely employed except for short hauls and around mills. Four-wheel trucks are still used, however, for even the heaviest logs, but the logs rest on two trucks. The two trucks are sometimes connected together by a coupling beam, but frequently the logs form the only connection between the trucks.

Where animal power is used for hauling, the trucks are of very simple construction and of 2 tons to 5 tons capacity each.

Ordinary flat cars are frequently used for transporting logs, but as they weigh much more than logging cars, cost more to build and maintain, and are not equipped with bunks and special means for securing the logs, they are neither as economical nor as convenient to use.

A logging car which is used more than any other type and in practically all sections of the country is of skeleton construction and has a wooden frame. The one illustrated is of 30,000 lb. capacity, is 21 ft. long, and weighs only 7,000 lb., or less than half as much as a regular flat car. The bunks on which the logs rest and which are the equivalent of the body bolsters in other cars are 8 ft. 6 in. long and the bunk centers are 11 ft. Cone-headed bolts are used at the ends of the bunks to keep the logs from rolling off. The couplers may be of the simple link and pin type but automatic couplers are preferable for safety and other reasons and, of course, must be used if the cars are ever hauled

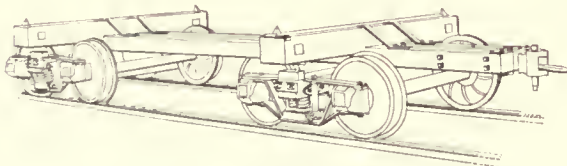

Fig. 38—Logging Car, Wooden Frame

on other railroads. Cars of the same general type are built in capacities up to 80,000 lb.

For hauling long logs, the center sills are cut in two at the center and reinforced with straps so that the distance between the truck centers can be adjusted to suit the length of the logs.

As the grades on logging roads are usually heavy and frequently long the use of air brakes is strongly recommended even though the cars are not sent to other railroads.

For heavy service, logging cars of all-steel construction are coming into use. They are usually of from 60,000 lb. to 80,000 lb. capacity. The one illustrated has four bunks and is provided with rails for a log loader. If log loaders of

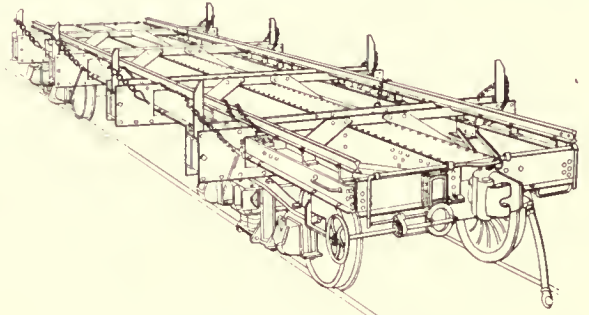

Fig. 39—Logging Car, All Steel

the type which run over the tops of the cars are not used the rails may be omitted.

The use of four bunks permits of the loading of two tiers of short logs, but if only long logs are to be hauled the cars need only be equipped with two bunks.

The bunks shown are equipped with short stakes which can be released from the opposite side of the car, a safety device of considerable importance. There are a number of similar designs which have been proved to be so efficient that there is no need of releasing the logs on the side of the car from which they are unloaded.

The car is equipped with automatic couplers, air brakes and all appliances required for interchange traffic.

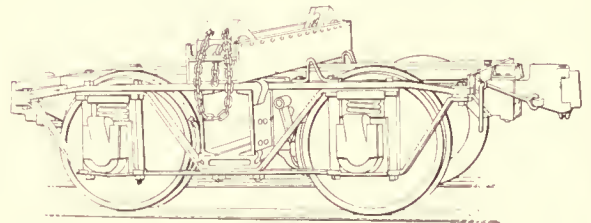

Fig. 40—Logging Truck

Logging Trucks. Detached logging trucks, sometimes called logging cars, are frequently referred to as "Pacific" trucks because of their extensive use on the Pacific coast where they are employed to haul logs of very large diameter and at times of considerable length.

The design illustrated has a capacity of 100,000 lb. for a pair of trucks and is suited for handling very large logs. Other designs are used which range in capacity per pair from 50,000 lb. to 100,000 lb. The bunk shown is equipped with chocks which can be easily adjusted in position and locked and unlocked from the side opposite to that on which the logs are discharged. For the large logs hauled on the Pacific coast such chocks are better than stakes. Detached logging trucks are also used for heavy work in the south, in the Philippine Islands and other places. Bunks are equipped with chocks or stakes of the kind best suited to the character of the logs handled.

Such trucks are equipped with couplers on both ends so that they may be coupled together when run as empties.

Each truck is equipped with a handbrake and frequently with an air brake, the cylinder and brake apparatus being mounted directly on the truck. Separate pieces of pipe and hose are used to connect a pair of loaded trucks.

Lumber Cars. For use around mills a simple form of a four-wheel platform or skeleton car with side stakes is commonly employed. In their simplest form they are not equipped with springs and if they are to be pushed by hand, brakes and couplings may also be omitted. If they are to be hauled by animal power, by cable or by locomotive, both couplers and brakes are usually applied.

The lumber car illustrated has a small side platform or running board on which a man can ride and operate the brakes. The ends of the frame are extended to give a distance over the couplings suitable for the length of the

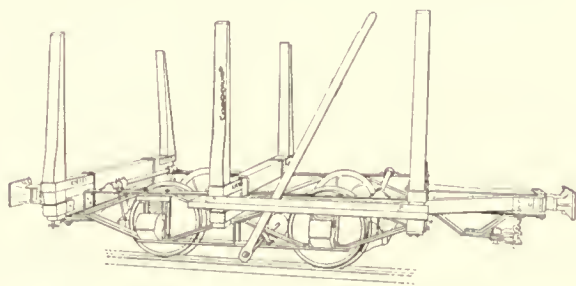

Fig. 41—Lumber Car

lumber usually handled. If longer lumber is handled reach rods will be required between the cars. The particular car shown is also equipped with a low coupling for connection to a cable.

Such a low connection is desirable where the cars are hauled by cable over tracks with a number of curves or up inclines, as to the second floor of a mill.

Lumber cars can be built for any gage of track which seems best suited to the conditions. Although steel rails are generally used, special wheels suitable for wood rails may be supplied if desired.

Cane and Plantation Cars

Cane cars are of many different types and sizes, as naturally follows from the fact that they are used under such diverse conditions and in so many different countries. Extensive sugar cane plantations are found in the United States, in Cuba, Porto Rico, Mexico, Central America, parts of South America, Hawaii, the Philippine Islands, Java, South Africa and other tropical countries.

In size, cane cars range from a small four-wheel car for a 24 in. track gage, holding one ton, to a large eight-wheel compartment car for standard railroad track gage, holding 30 tons or more.

The track gage, most commonly used for cane cars range from 24 in. to 56½ in. and, in countries using the metric system, from 60 c. m., to 1 meter (equivalent to about 24 in. to 39¾ in.).

In addition to the general practice of the locality, some of the factors which have to be considered when deciding upon the design of a car best adapted to a particular plantation are the following:

Size of the plantation and amount of cane produced; labor conditions; size or capacity of car most convenient to handle; method of haulage and the length of haul to the mill; the manner in which the cane is handled at the mill; and the means adopted for loading and for unloading.

On small plantations the cane is often brought in by mule drawn wagons or bull carts and this means is still employed to a considerable extent, even on large estates, for hauling from the fields to the loading point for the cane cars. On

other plantations, especially in Cuba, bull carts are being replaced by portable railroads and small four-wheel cars for bringing in the cane to the large cars.

The loading of carts or cars in the field, or the transferring to large cars, may be done by hand, by a portable loader consisting of a derrick and grapple mounted on a wagon or a car and operated by animal power or by a gasoline engine. At transfer points the derrick may be stationary or may be replaced by a transfer crane consisting of an overhead bridge with a trolley and a chain sling operated by a winch driven by a gasoline engine.

Modern sugar cane mills or "centrals" are usually equipped with conveyors, often called conductors or carriers, for moving the cane from the place where the cars are unloaded to the crushers.

Various means are employed for unloading the cars. This may be done by hand, by rake type feeders which pull the cane off the cars sideways, by a grab or cane fork and a hoist, by a chain sling and a hoist or by a crane or car dumper which tilts the car sideways or endwise and causes the load to slide out into a hopper from which it passes to the conveyor. Instead of employing a car dumper and flat bottom cars, in a few instances cars are used which have inclined or gable bottoms so as to be largely self-discharging when the side doors are unlocked.

There are wide variations in structural details, as well as in type and size. Only the more important parts, however, will be mentioned.

The underframe and trucks are usually of steel, although the frame may be of wood in some cases, as for small four-wheel cars. The floor may be of planks or of sheet steel. Smooth floors are used where the cars are unloaded by hand, by tilting, or by raking out. If unloaded by means of chain slings and a hoist, the floor is provided with cleats so that the chains can be passed through under the load. These cleats may be wood strips, rolled shapes such as angles, or pressed steel. The floor is sometimes inclined to facilitate the discharge of the cane.

The superstructure, including the ends, sides and partitions, may be of wood, entirely of metal, or of a combination of wood and metal.

The ends may be solid, steel racks, stakes, a door hinged at the top if the car is dumped by tipping endwise, or they may be omitted entirely for hand loading lengthwise.

The sides may consist of stakes with solid or releasable stake pockets; stakes held in releasable stake pockets and hinged at the top either on a rod or by an individual hinge; stakes hinged at the top and fastened together to form a door so that the entire side of a compartment will open at once or be held locked by a rod at the bottom; stakes fastened solidly to the side frame at the bottom, in which case they may or may not be attached to a top side rail, or a door hinged at the bottom so as to drop down. In some cases where loading is done crosswise by hand the sides are omitted entirely.

In some instances where the cane is bundled, horizontal hinged partitions or slats are provided so that the load is divided into two or three parts.

Couplings may be automatic, such as are standard on American railroads; automatic of three-quarter size; link and pin; link and hook, or of other design to suit local requirements.

The larger cars are frequently equipped with air brakes and the smaller cars usually have hand brakes. On level roads, for short hauls and for slow speeds, brakes may be omitted.

Cane cars are of two general groups; first, large double-truck or eight-wheel cars; and, second, small four-wheel or single-truck cars. Only the principal typical designs of each group will be described.

Double Truck Cane Cars. In the largest cane producing sections, especially in Cuba, car dumpers of the side tipping platform type are extensively used. This makes necessary the employment of some kind of a side discharging car.

The side stakes or slats are hinged at the top and fastened together to form a separate door for each compartment and are held by locking bars at the bottom which can be operated from the end of the car. The cars are usually divided into two or three compartments. Both sides may be hinged, but in most cases this is done on one side only, the other side having the stakes riveted on. The discharging side is com-

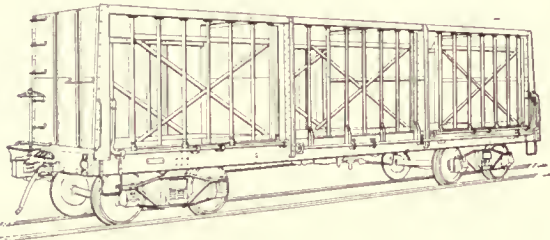

Fig. 42—Side Discharge Cane Car, Hinged Stakes

monly made higher than the fixed side to facilitate the passage of the cane.

If preferred, the stakes may be independent and be held at the bottom by releasing stake pockets, the discharge being controlled by the number of stakes released.

A further modification is to hinge the stakes to a top rod which permits of sliding them endwise to facilitate side loading by hand. Cars of this type vary in length from 20 ft. to 38 ft. and in capacity from 7 tons to 30 tons.

In some places in Cuba and South America the cane cars have an end door hinged at the top for use in connection with car dumpers of the end-tilting type.

Such cars are sheathed on the inside with wood or steel plates so that the contents will slide out readily.

Where rake type unloaders or feeders are installed and in many instances where hand unloading is still employed, the

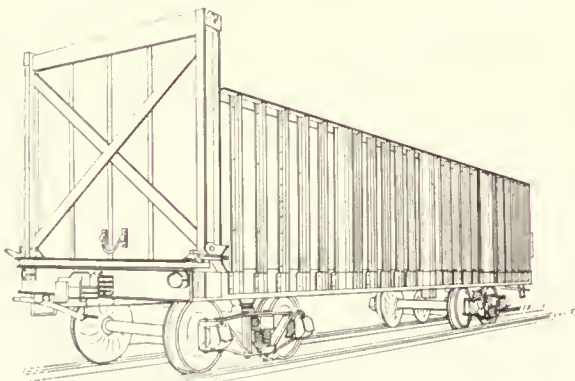

Fig. 43—End Discharge Cane Car

cars used are ordinarily fitted with separate stakes and releasing stake pockets, although on some estates they still use solid stake pockets, removing the stakes by hand for unloading.

The floors are generally of planks or sheet steel. By adding floor cleats, chain sling unloaders may be used.

Where the cars are unloaded by passing chains through

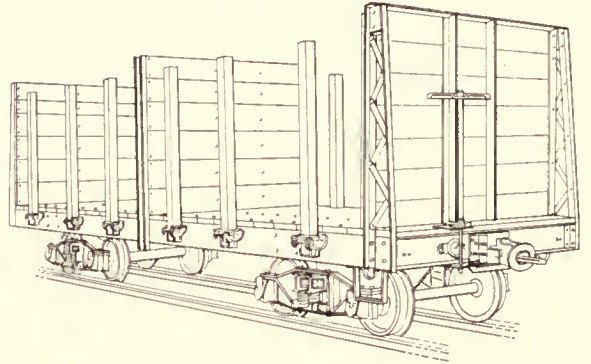

Fig. 44—Side Discharge Cane Car, Releasing Stake Pockets

under the load, and lifting the cane out of a compartment by a hoist and sling, the platforms are always fitted with cleats.

The side stakes are usually fastened rigidly to the side frame at the bottom and to a side rail at the top. The upper side rail is sometimes omitted where the load is hoisted out and it is generally dispensed with for hand unloading.

Horizontal bars are sometimes hinged to the stakes so as to divide the cane into two or three different levels, each one of which may be hoisted out separately.

For strictly hand unloading, the end walls can be replaced by rigid stakes, or in very flat countries end stakes

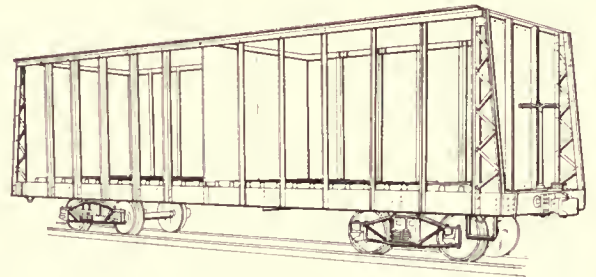

Fig. 45—Cane Car, Hoist Unloading

can be entirely dispensed with. Such cars are usually built only in the smaller sizes and have but one compartment.

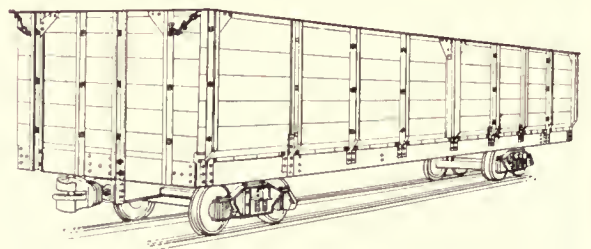

Fig. 46—Cane Car, Drop Side Doors

For top unloading by cane grapples or grabs low skeleton rack sides may be used and the cane piled up about twice as high as the sides.

In another design the side doors are hinged at the bottom and drop down for loading and unloading. The sizes most commonly used are from 5 ft. to 8 ft. wide, 20 ft. to 30 ft. long and have a capacity of from 7 tons to 17 tons. The su-

perstructure may be of steel rack design or sheathed with wood. The cars are usually equipped with a center partition which divides them into two compartments.

Two doors are used on each of the sides, which are commonly 3 ft. to 4 ft. high. Where cars of large capacity are desired the sides may be increased in height, and in some instances where this is done a double set of doors is used, one above the other.

Four-Wheel Cane and Plantation Cars. Four-wheel cane cars differ as widely in design as do the larger double-truck cars, and are used more extensively. With little or no change in details they are used on other than cane plantations for handling such material as sisal grass, henequen, manila, wood, coffee, bananas, boxes of oranges and grape fruit, tobacco, etc. Although commonly known as cane cars they might very properly be called by the broader name, plantation cars.

The track gages commonly used are from 24 in. to 36 in. although in some instances four-wheel cane cars are built for standard gage. The usual capacities range from 1½ tons to 6 tons, although this may be exceeded at times.

Couplers are of various types, dependent upon the local customs and the means employed for haulage, whether animal or locomotive.

On many plantations four-wheel cars answer all requirements and even on the largest estates they frequently are employed in conjunction with portable railways for bringing

methods are used the floors should be smooth and the end uprights sheathed. Solid stake pockets are also used but the stakes cannot then be so easily removed.

This style of car is frequently called the "Hawaiian" type, although this name is also used to designate cars with flaring sides and drop doors. Both styles are widely used in the Hawaiian Islands and are also used in other places.

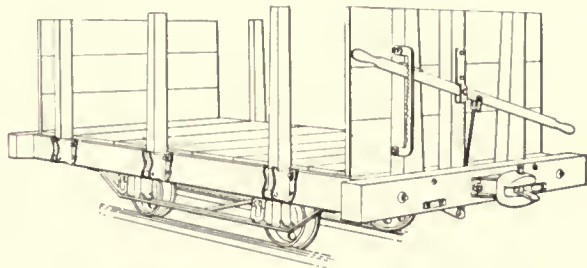

Fig. 48—Cane Car, Releasing Stake Pockets

Another form of car is equipped with side doors hinged at the bottom. In the Hawaiian Islands the sides are usually flared as shown in the illustration and the car is

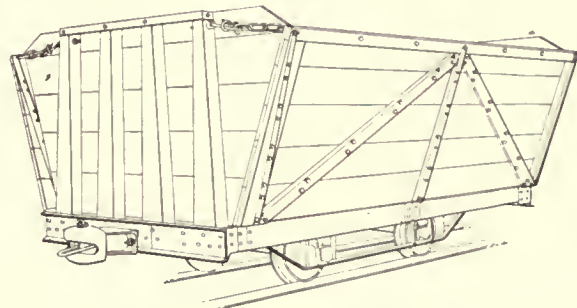

Fig. 49—Cane Car, Drop Side Doors

often called the "Hawaiian" type. A similar car is used in Louisiana but the sides are usually made vertical. These cars are generally designed for a capacity of from two to six

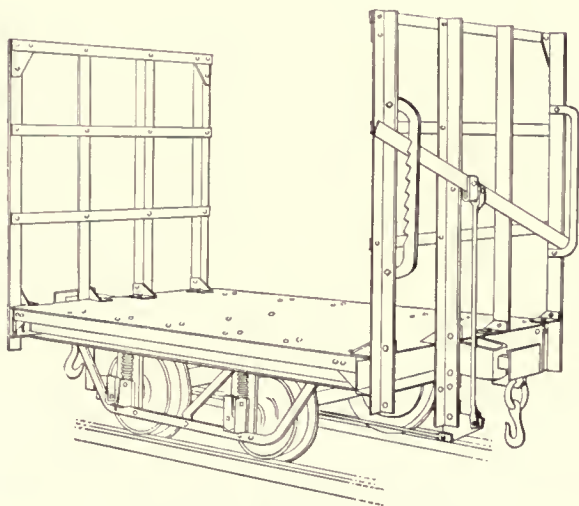

Fig. 47—Cane Car with End Racks

in the cane from the fields to be loaded on large double-truck cars.

Cars without sides and with end racks are frequently called the "Porto Rican" type, although they are used in many other countries. The floor is usually smooth, this being best suited for loading and unloading by hand, the cane being placed on the cars crosswise.

A windlass is often attached to one end for securing the load by a chain passed over the top.

A modification with curved ends and known as the "basket" or "Equador" type is used in certain sections.

Side stakes with releasing stake pockets are a convenience in retaining the load and are frequently used on cars which are unloaded by hand or by unloaders of the "rake-out" type. They can also be used in connection with side tilting unloaders, but in this case cars having side stakes hinged to a top rail are most popular. Where mechanical unloading

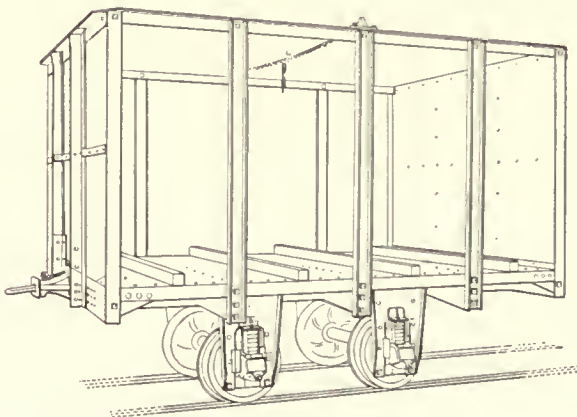

Fig. 50—Cane Car, Top Unloading

tons and are ordinarily loaded about twice as high as the sides.

For top unloading the side stakes are usually rigidly attached at the bottom. Top side rails stiffen the car and give a better support for the stakes but are somewhat in the way when loading. If chain slings are employed floor cleats are

used. Such cars are known as the "Cuban" type and are largely used in conjunction with narrow gage portable railroads for bringing in the cane from the fields to a point where it is transferred to large double-truck cars. They generally have a short wheel-base for greater ease in passing around curves, and are commonly hauled by animal power but small locomotives are sometimes used.

Where cars are unloaded, as well as loaded, by hand, end stakes can be substituted for the sheathed end upright, and in very level sections even end stakes are omitted and the cars are loaded at the ends.

Another type of car which is employed where end loading is followed, has one end closed and the loading end partly

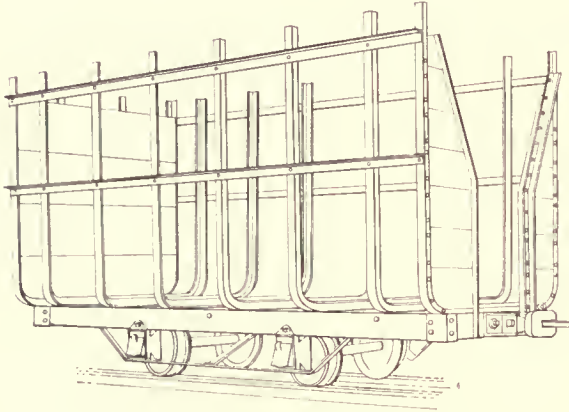

Fig. 51—Cane Car for End Loading

closed, sufficient space being left open to permit a man to enter the car.

This arrangement is economical in the use of labor and is frequently used for bringing in the cane, particularly on portable railroads.

Dryer Cars

The three most important groups of industries in which dryer cars are extensively employed are as follows:

1. Clay products manufacture. The value of the clay products manufactured in the United States is some \$200,000,000 per year. Plants both large and small are found in almost every section of the country and most of them use some kind of dryer cars. The products include common brick, pressed brick, face brick, paving brick, drainage tile, hollow building tile, roofing tile, concrete blocks, etc.

2. Foundries. Various kinds of cars are used for the drying of cores and molds which will be described more fully under the head of Foundry Cars. A car quite extensively used for drying small cores is practically the same as the soft mud brick or pallet cars.

3. Japanning and enameling. The cars used for this purpose differ widely according to the shape of the articles treated. In general, they resemble pallet cars, being divided into from one to four sections.

For brick cars the track gage most commonly used is 24 in, and there appears to be no good reason why this should not be adopted as a standard instead of using such odd gages as 23 in., 25 in. or 26.

Wheels are usually 10 in. to 12 in. in diameter and are generally pressed onto axles about one and a half inches in diameter. The axles usually have bearings outside of the wheels, although this is not always the case. The bearings

are generally of the roller type. Care must be taken to prevent the ever prevalent dirt and sand from getting into the bearings. Another thing to be considered is the high

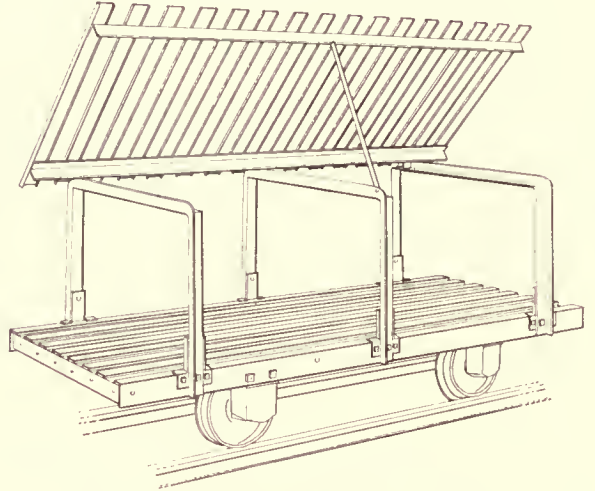

Fig. 52—Car for Stiff Mud Brick and Tile

temperature of the ovens and its effect on lubrication and distortions which may throw the wheels out of line.

Dryer cars for stiff mud brick or hollow ware may have one, two, or more decks of wood or of steel slats. Upper decks may be rigidly attached, may be hinged or double folding, or may be removable, the folding type being preferable for convenience in loading and unloading. Such cars are usually about 3 ft. wide and 7 ft. long. A double deck car of this size will hold 500 bricks.

Triple deck cars are commonly used for drying face brick and fire-proofing brick. For concrete blocks two-deck or three-deck cars are preferable.

For sand-lime brick a single deck car with a steel plate top is employed.

For drying soft mud or hand-made brick, roofing tile, etc.,

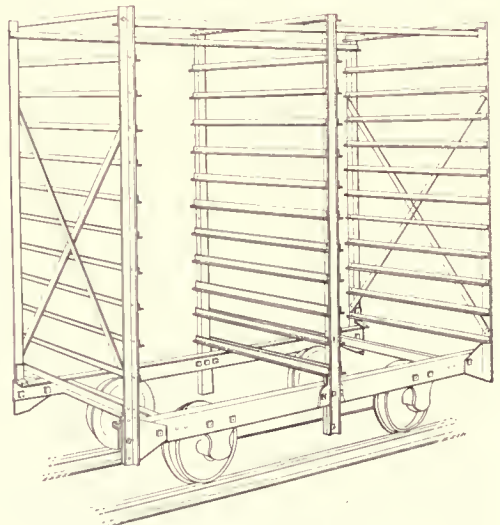

Fig. 53—Car for Soft Mud Brick

a pallet car is used. Standard pallets are 2 ft. 10 in. long and 10 in. wide and the car most generally employed holds 24 pallets in 12 tiers of two each. Such a car is about 3 ft. wide, 7 ft. long and 6 ft. high.

With modifications in dimensions to meet the particular requirements similar cars are used in foundries for drying cores and shops for Japanning and enameling work.

After stiff mud bricks have been formed they may be taken to sheds to dry out by natural air currents or they may be taken to hot air dryers for the removal of moisture before they go to the kilns to be burned. The handling of undried bricks from the machine to the dryer and from the dryer to the kilns by means of lift platform cars is probably the simpler and cheaper method in most cases. The cars used for the purpose have platforms about 5½ ft. long and

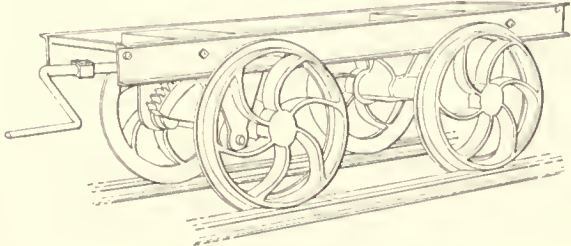

Fig. 54—Lift Platform Car

2½ ft. wide, a height of about 20 in. and a lift of from 3 in. to 4 in.

As the bricks are formed they are placed on pallets holding about 200 bricks each. A car is then run under the pallets and the platform is elevated to lift off two pallets, or about 400 bricks. After being pushed on the transfer and run into the desired point in the dryer, the platform is lowered and the load is deposited on rests. Another lift platform car and transfer is used for handling the dry brick from the other end of the dryer or shed to the kilns.

Car Transfers

In laying out industrial railway systems it often happens that the use of switches is not practical. In some such places turntables at intersecting points will satisfactorily meet the requirements. In other places the use of car transfers will give the best results. As their name implies, car transfers are used where there are no switches and turnouts to transfer cars from one track to another parallel track. These transfers carry a short piece of track of the same gage as the industrial railway system. In operation, the cars used to transport material around the plant are run from the tracks on which they are operated onto the track on the car transfer, which is then moved to a point opposite some other track onto which it is desired to run the industrial car.

Car transfers are used at practically all brick and tile manufacturing plants in transporting the dryer cars from the machines to the dryers and from the dryers to the kilns.

They are frequently employed in iron foundries, especially on the cupola charging floor and occasionally in raw stock yards, in front of the core ovens and at other points. They are used to meet special conditions around various types of industrial plants and are often installed in large sizes at steel making plants for handling regular steam railroad cars loaded with ore, coke and other materials.

Car transfers may be equipped with a single, a double or a triple set of tracks dependent upon the number of cars to be transferred at one time; they may have three tracks so that cars of two different gages may be transferred; or may be equipped with a turntable so that cars may be turned around as well as transferred.

When designing or ordering car transfers the following factors must be considered:

1. The track gage of the industrial railway system.
2. The length over-all of the various cars which are in service or are liable to be used in the future. This determines the length of the track and the width of the transfer car and also the gage of the track on which the transfer runs. For single truck cars the usual length of track is 6 ft. or 8 ft. except where cars of 56½ in. gage are used, when the length of track is made 8 ft. or 10 ft. For double truck cars the ordinary lengths of track are 15 ft., 20 ft., 25 ft. or 30 ft.
3. The width over-all of the cars transferred and the spacing of the tracks carried, where the car is equipped with more than one set of trucks, determine the length of the car transfer.
4. The gross weight of the loaded cars and their wheel bases so that the car transfer may be of the necessary strength and capacity.
5. Height from top of rail on which transfer runs to top of rail on transfer.

If the transfer is to be moved by hand a push handle may be added if desired. With this is frequently combined a pair of brake shoes so arranged that by pushing down on the push handle the shoes are brought into contact with the wheels and the transfer stopped when opposite the desired track.

If a large number of transfers are to be made in the course of a day it will probably be economical to equip the car transfer with an electric motor drive. In this event it will be necessary to know whether the available current is direct or alternating; the voltage; and if alternating the number of phases and cycles; the location of the trolley wires and the speed at which the transfer is to travel.

Ordinarily car transfers run on straight level tracks. Should there be any grades or curves this should be noted.

The side pieces of car transfers are usually made of channels, diagonally cross-braced to keep the car square. For large capacities, cross girders should be placed under the rails on the car. Where the length of rails is not over 10 ft. it is customary to use a long axle with wheels pressed on each end. Where the length of the rails is greater the long

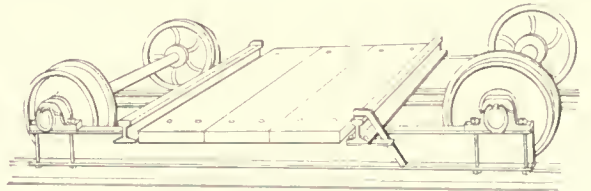

Fig. 55—Car Transfer

axles may be omitted and each wheel may be carried on a short axle, the car then being constructed with longitudinal channels inside as well as outside of the wheels. Bearings should preferably be of the roller type. Guards or stops should be provided on each side to prevent the car carried from accidentally running off the transfer.

Dogs or latches are often used to lock the car transfer in position when the tracks on the car register with the tracks on the side of the transfer pit, but their use is by no means universal.

Ore Mine Cars

In the majority of copper, lead, zinc, gold, silver, and most other metal mining operations, the quantity of material handled is relatively small in comparison with coal mining where tonnage is the important factor. Exceptions to these conditions are found in iron ore mining and in some copper mining where the operations are generally of the open pit

type, and the cars used are of the box-body side-dump type, the same as used in construction work, or of the hopper-bottom type, the track gage being either 56½ in. or 36 in.

As ore mine cars are commonly used in restricted tunnels with narrow openings and short curves they are necessarily of small size and compact design. The name "ore mine car" is usually understood to mean a car with a rectangular or box-shaped body, hinged so as to tip and generally mounted on a swivel so that the load may be dumped in any direction. The front end has a gate hinged at the top and held by a latch controlled from the rear of the car, thus making it unnecessary for the operator to go in front for dumping. When

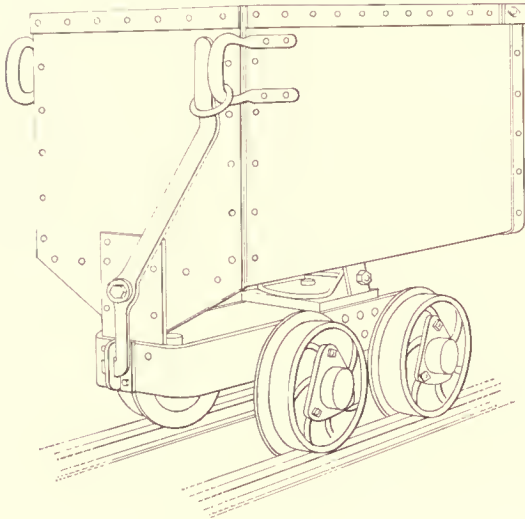

Fig. 56—Ore Mine Car

the latch is released the material in the car forces the gate open.

In the design most frequently used a latch on the rear holds the body in the horizontal position. The latch is controlled by a lever on the rear of the car, which also turns a shaft running lengthwise which is provided with an upturned end in front that acts as a latch for the gate. In some designs the two latches are independent. One form which is used to a considerable extent retains the lever and shaft for the gate latch and uses a foot-operated latch for the body.

By another arrangement the dumping is automatic, that is, the latch for the gate may be omitted and a series of levers so arranged that as the body is tipped the gate is automatically opened by the levers; or side levers may be connected to the gate latches in such a manner that the tipping of the car automatically releases the latches.

In most ore mines a track gage of 18 in. is used, although 16 in., 20 in., 24 in. and occasionally 30 in. or 36 in. are also employed. Car capacities range from 8 cu. ft. to 30 cu. ft., widths from 22 in. to 32 in., lengths from 36 in. to 48 in., and heights from 33 in. to 48 in.

The sides of the body are generally of steel plate of about No. 10 gage, the bottom is usually of a heavier gage than the sides. The bottoms are ordinarily flat but in some cases they are rounded at the corners to facilitate unloading. There is also a small demand for cars with wooden bodies.

The wheels are usually 10 in. in diameter and occasionally 8 in. or 12 in. with a wheel base of about 18 in.

The ordinary practice is to use square axles from 1½ in. to 2 in. in size. The wheels are loose and either plain, self-oiling or with rollers in the hub. In some instances, however, the "Anaconda" type of wheels and axles are preferred

as the journals are practically dust proof. In this type a saddle fits over a round axle and is provided with babbitted bearings and waste-packed oil cellars or with roller bearings. One of the wheels is pressed on the axle and the other is loose.

The majority of ore mine cars are not equipped with couplers, as they are pushed by hand. If it is desired to couple a number of cars together and pull them by animal power or handle them by a cable, as is sometimes done when cars are lowered down an incline, a simple link and pin or a chain and hook are employed to fasten the cars together.

Brakes are rarely required, and if necessary are generally of a very simple design. When they are used a small platform is usually provided at the rear end of the car on which a man can ride.

Cars which are used on mine cages are frequently made somewhat shorter than other cars and are often provided with attachments for clamping the car to the cage. As accidental unlocking and dumping would be dangerous, automatic dumping cars are preferable for cage service.

Automatic rail clamps for holding the car while it is being dumped are an additional safety device which is often applied and is especially valuable where cars are dumped on a trestle.

Several modifications may be made in the general design. If the rotary dumping feature is not desired the swivel base can be omitted and the car may be end dumped. In some places all of the cars are dumped on one side and side dumping cars are used. For some mines a very low car is desired; at least six inches in height can be gained by omitting the swivel and hinge and rigidly fastening the body to the truck frame. Cars of this type are dumped by tipping the body and truck together around the front wheel as a fulcrum.

In small mines and in exploration work, the ore is frequently hoisted in round buckets holding from 4 cu. ft. to 15 cu. ft. For transporting the buckets a small pan or bucket truck is used. This has small wheels and either a plain square wooden top to which the axles are fastened or a

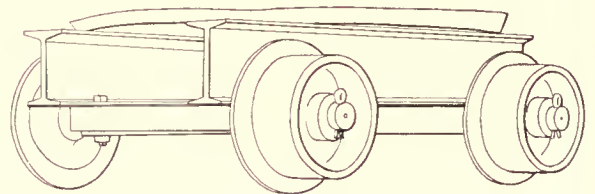

Fig. 57—Bucket Truck

framework of steel with a steel plate pan on which the bucket rests.

In large mines various kinds of general purpose cars, which are described elsewhere, are used to a greater or less extent. Among them may be mentioned scoop-body cars, of the usual rotary type or single side dumping; V-body dump cars of the trunnion, cradle or rocker type; gable bottom cars and hopper bottom cars.

As the ore is mined it may be dumped into receiving bins from which it is afterwards transferred to hoppers at the mill. For this purpose an end dumping car may be hauled up an incline by a cable and automatically dumped. Such a car is illustrated. At the desired dumping point the extra pair of rear wheels engage a dumping rail which raises the rear end of the car and as the pull on the cable lifts the bar in front of the hinged gate, it is permitted to open and discharge the load. Instead of

the separate pair of dumping wheels, double tread wheels may be used on the rear axle. Such cars are usually of

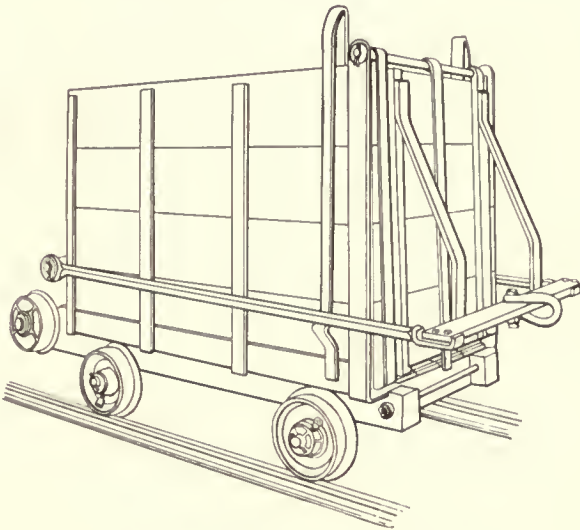

Fig. 58—Inclined Cable or Skip Car

from 30 cu. ft. to 75 cu. ft. capacity and for 36 in. or 42 in. track gage.

Coal Mine Cars

No matter where the mines are located, cars will be found in use for transporting the coal from the point where it is mined to the surface. Because of the widely varying conditions in different localities the cars employed are of many sizes and forms. In the bituminous coal regions the majority of the cars are of either the single or double flare form, although drop bottom cars are used to some extent, particularly in the coke regions. Similar cars are used in the anthracite regions although many cars of the square box form are also employed.

As the operating costs of a mine will be considerably affected by the design of the car selected, it is important that not only the general type but also the various details be given careful consideration.

There are no recognized standard designs for coal mine cars. In fact it would seem as though every effort had

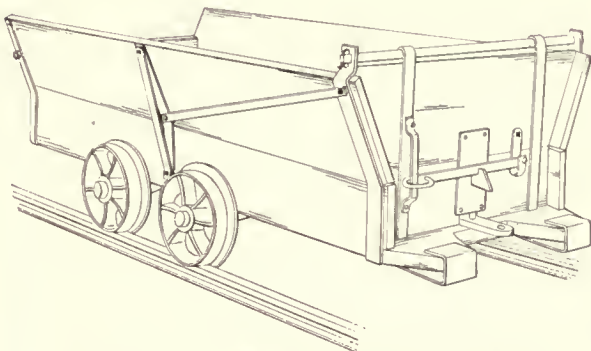

Fig. 59—Coal Mine Car, Swing End Gate

been exerted to devise as many variations as possible in practically every detail. Many of these deviations are unquestionably not necessary and it is to be hoped that the near future will see a considerable advancement toward standardization.

In opening up new mines or considering plans for the improvement of existing mines, one of the first points to be considered is what track gage shall be adopted. In this, as in other points, there is a wide diversity of practice which is typical of the whole mining car field. A recent inquiry showed that coal mine cars were being ordered for some 25 different track gages ranging from 18 in. to 56½ in. While no one standard gage will meet all requirements, a limitation to 24 in., 30 in., 36 in., 42 in., 48 in., and 56½ in. would reduce the number to six, and give sufficient variations to cover all contingencies. There has been noted a strong tendency lately toward the adoption of a 42 in. gage for all important new work. The economy and advantages of a few standard gages in reducing the initial cost of equipment and in making it possible to transfer cars and locomotives from one mine to another, or to dispose of surplus rolling stock, are self-evident.

Narrow gage tracks are cheaper to construct and the cars can be more easily pushed around sharp curves, but they are apt to be rather top heavy. Broad gage tracks require a larger investment in ties, but the cars have greater stability, while the wear on track and rolling stock will be decreased.

The width of the car is limited by the width of the entry to the mine, which is dependent upon the condition of the

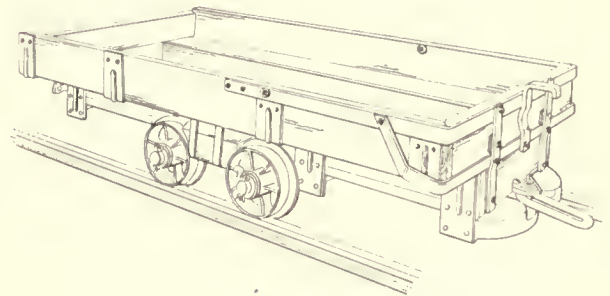
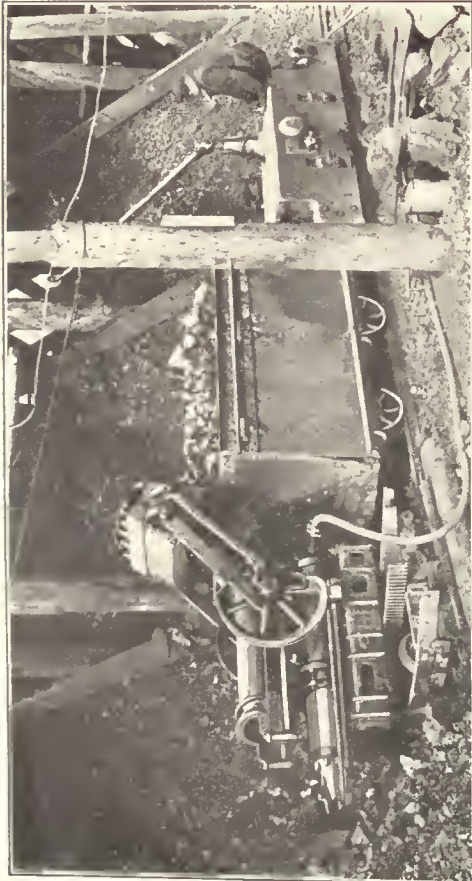

Fig. 60—Coal Mine Car, Lift End Gate

top and bottom. With a low seam and a good top a car of considerable width may be used. The difficulty is to obtain sufficient strength for that portion of the body which overhangs the wheels. The overhang can, of course, be decreased by increasing the track gage, but this may increase the cost of track construction beyond what is deemed advisable. In some cases the width of the car has been made practically twice the track gage.

The length inside of the body of coal mine cars is ordinarily from 8 ft. to 10 ft. and the wheel base from 28 in. to 32 in. The length and capacity could be increased by using a longer wheel base but the objection to so doing is the greater difficulty in replacing derailed cars and the larger radius of curves necessary to ensure easy running.

For low seams the height of the car is restricted to narrow limits. Some cars are used whose height is less than 20 in. For thick seams the height of the car is dependent upon what is the most economical height for hand shoveling, if this method of loading is employed. As the physical effort is dependent upon the height to which the coal is to be lifted, it has been found that a man can shovel considerably more coal per day into low than into high cars. For this reason some large operators will not use cars whose heights exceed 32 in. Where machine loading is employed the height may be as much as 48 in., or even 60 in.



An Electric-Operated Shovel Loader Loading Coal into a Cable Bottom Car for Transportation with a Trolley Type Electric Locomotive



A Conveyor Type Loading Machine Loading Coal Direct from the Breast to the Mine Car

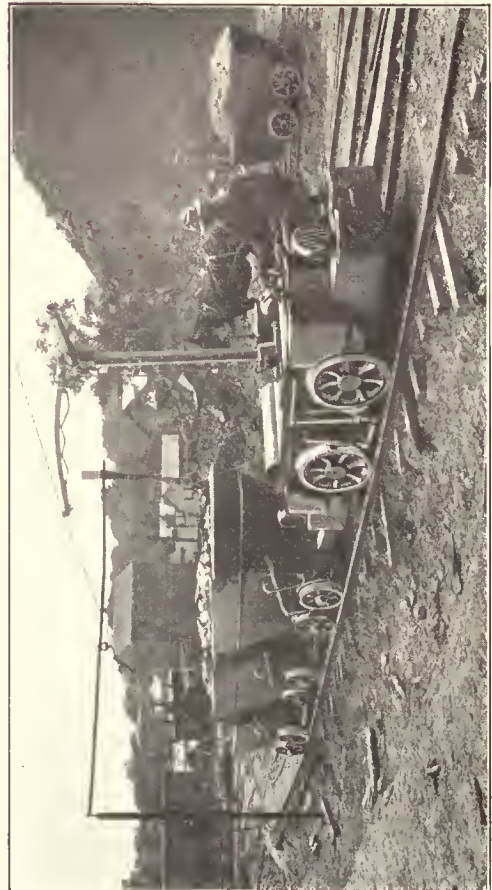

Two Methods of Haulage; Bottom Dump Cars Hauled by Trolley Type Electric Locomotive and Horse Drawn



Coal Cars Are Sometimes Hauled for Long Distances from the Mine to Shipping Point

The capacity of coal mining cars is usually given in cubic feet, water level. This can be reduced to pounds by multiplying by 50, the average weight of a cubic foot of loose coal. By topping, the capacity can be increased about 20 per cent. In size, cars range from 25 cu. ft. to 140 cu. ft. capacity, which is equivalent to from 1,500 lb. to 8,000 lb. of coal.

The loaded weight of a car consists of from about 65 per cent to 75 per cent coal, the balance representing the light weight of the car.

Cars may be of wood, steel or composite construction, each of which has certain advantages and disadvantages.

Wooden cars have the advantage of low initial cost, can be repaired at the ordinary mine shop by unskilled labor and have a flexibility which makes them ride easily. They do not, however, have the durability, strength or capacity of steel cars of the same size. Wooden cars are usually built of oak, and have bottoms about 3 in. thick and sides $1\frac{1}{2}$ in. thick. Many operators find it advantageous to purchase the trucks and iron parts and build the cars at their own shops.

Steel cars have about 15 per cent greater capacity than

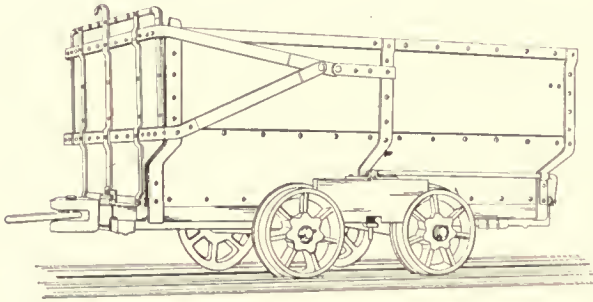

Fig. 61—Composite Mine Car, Lift End Gate

wooden cars of the same size, or can be built lower for the same capacity which is important for thin veins and is also desirable for thick veins because of the greater ease in loading. They are also stronger than wooden cars, will withstand greater shocks, retain their shape better, will not leak as much coal and do not require as frequent repairs. The objections to their general adoption are a considerable increase in cost, the fact that repairs are not so easily made and often requires skilled labor, a lack of flexibility in riding and rapid corrosion, especially of the bottom.

To retain the advantages of steel construction as far as possible and yet avoid some of the disadvantages, cars are frequently built with wooden bottoms and steel sides, especially in sizes over 50 cu. ft. capacity where rusting has given more trouble than in the very small sizes.

In all-steel cars and cars with steel sides and wooden bottoms, the side plates may be made in several ways. They may be made of single sheets bent to the proper shape, but such cars are difficult to repair. They may be made of two or three pieces, flanged and either bolted or riveted together; in the event of the car being damaged by a wreck or a fall of slate from the roof, the bolts can be taken out or the rivets removed, and the plates easily straightened. A third method is to make the sides in two or three pieces, flanged to overlap but not bolted or riveted together. This arrangement permits of easy repairs and, should it be advisable, the pieces can be shipped from the manufacturer in a knocked-down condition and easily assembled at the destination.

The majority of coal mine cars are unloaded by tipping endwise on a cross-over or a horn dump. Where this is done the cars are provided with end gates which may be either of swing type and hung by two or more straps from

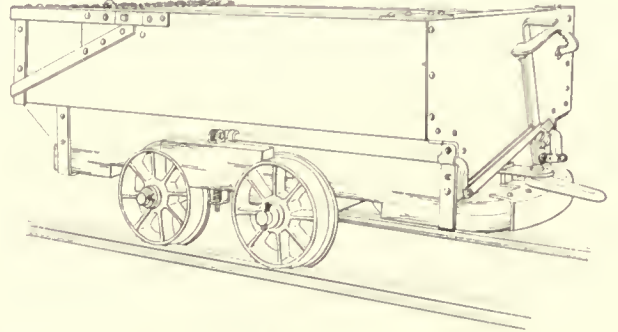

Fig. 62—Steel Mine Car, Lift End Gate

a crossbar attached to the top of the front binder, or of the lift type. The latter type is also standard at mines using self-dumping cages.

Cars having swing gates must be equipped with latches which are fastened before the cars are loaded and unfastened as the cars are dumped. Many different designs of latches are in use but a breakage or jarring in transit may permit the gate to open, spill the coal and possibly cause a derailment.

Lift gates are much more reliable as the chances of failure because of breakage are insignificant and they cannot jar loose while the cars are in transit. For these reasons they are preferred by many operators and their use has extended rapidly in recent years. Both lift and swing gates have, however, one serious fault. As they cannot be made and kept tight they permit the leakage of a certain amount of fine coal which falls on the haulage-way and is ground up by the passing of cars, men and animals. This fine dust is carried by currents of air and adds greatly to the danger of an explosion, even though the risk is lessened by using sprinkler cars to keep the haulage-way damp. For this reason many operators have abandoned end

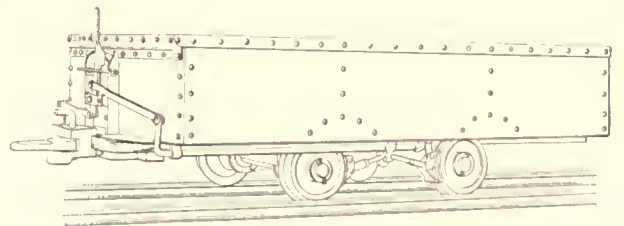

Fig. 63—Steel Mine Car, Without Gates

gates and are now using cars with solid ends. In such places rotary dumps are required to unload the cars.

In addition to tightness and freedom from leakage, cars without gates are cheaper to build, retain their shape better, cost less to maintain and spend more of their time in service and less in the repair shop. Indications all point to the steady increase in popularity of this type of a car, especially in drift mines.

In some bituminous coal mines, where there are only slight grades and where the coal is in the form of large lumps, open end cars are used and simple end bars or lattice gates hinged at one side keep the coal from jarring out while in transit.

Hopper bottom coal cars as has already been stated, are also used to a certain extent, especially in the coke regions. Where they are employed, a string of cars may be pulled out of the mine, run over a long bin and all unloaded at one setting. This gives an even distribution of coal throughout the bin and makes unnecessary the installation of power driven levelers. Such cars are, however, somewhat high in first cost, are expensive to maintain, will spill the load if the door fastenings break and they are not free from leakage troubles.

In open pit mining, gable-bottom cars are employed to a considerable extent. They are run onto an elevated truck or trestle and can be dumped by hand or automatically, as desired. No dumping machinery is required, except for a trip, if the cars are dumped automatically.

The method of haulage, whether by animal power, rope or locomotive, has an important bearing on the selection of couplings, bumpers, bearings, lubrication, use of draft and bearing springs and other details.

Coal mine cars are generally equipped with continuous drawbars, usually having the ends enlarged with holes for coupling pins. In some cases one end is forged into a hook and the other end has a coupling pin hole or is turned over and a permanently attached link inserted. Spring connections are also sometimes used on the ends of the drawbars. If side bumpers are used the drawbars are straight but if center bumpers are used the ends are bent up in order to give room for the coupling link.

The couplings used to connect cars equipped with drawbars are commonly called hitchings. These consist of one or more links with separate coupling pins, of links with clevises on one or both ends or other modifications.

Large cars, especially where locomotive haulage is used, are generally equipped with spring drawheads or with automatic couplers. These reduce shocks and make the starting of a string of cars easier, but, of course, add to the initial expense.

Where rotary dumps are employed, cars may be equipped with swivel couplers which permit of dumping without uncoupling.

Cars may be provided with side bumpers consisting of projections on each side of the drawbar or with center bumpers consisting of single projections. Bumpers are subjected to severe shocks and must be strongly built. Wooden bumpers have their faces protected by steel plates or cast iron blocks may be substituted. Side bumpers sometimes interlock and cause derailments. Center bumpers are free from this fault and add to the life of a car because it is not subjected to the racking stresses resulting from corner bumps.

Wheels are usually of cast iron chilled on the tread, although cast steel wheels are now being used to a considerable extent. The production of chilled iron wheels requires the proper equipment, iron of the right analysis, a knowledge of the best wheel foundry practices and careful supervision. In steam railroad practice the importance of these points is so well appreciated that remarkably satisfactory results are obtained from chilled wheels. Unfortunately, these requirements have not always received the proper attention in foundries making wheels for industrial cars, with the result that the life or mileage of the wheels in general is much less than it should be and the wheels are, at times, scored by the action of the brake shoes. Wheels are commonly 18 in. in diameter, although 16 in., 14 in. and even 10 in. wheels are used in mines working thin seams.

Axles may be square in the center and rigidly attached

to the car body, in which case the wheels are loose on the axles. The objection to this arrangement is that the wear is concentrated on the bottom of the journals and they wear out of round. Such axles were formerly extensively used but have been largely superseded by round axles. With the latter all wheels may be pressed onto the axles which run loose in boxes attached to the car body, but this arrangement is usually not satisfactory because of the resistance in passing around the sharp curves which are often necessary in mines. To overcome this one of the wheels on each axle may be left loose but it is generally considered the best practice to leave all wheels loose. This has proved to be economical and makes it easy to take off any wheel.

Plain bearings, self-oiling have been extensively used but are being rapidly superseded by roller bearings which offer much less frictional resistance. In the bituminous coal fields the rollers are usually placed in the wheel hub, the boxes being inside of the wheels. In the anthracite region, however, it is quite customary to have the journals outside of the wheels and the rollers inside of the bearing boxes on which springs are mounted.

At some mines where the grades are slight, brakes are not applied, the cars being stopped by the insertion of sprags in the wheels. Most cars are, however, equipped with some kind of brake. In the simplest form, this consists of a wooden block between and above the two wheels on one side of the car and operated by a lever on the rear end. Instead of a wooden block a band of steel may be used on one or more of the wheels. The best practice is to apply brake shoes to all of the wheels. For small cars the shoes or blocks may be wood, but for large cars they should be of cast iron. If the brake shoes are above the center of the wheels precautions should be taken to prevent their dragging against the wheels when not in use. If the brake shoes are below the center of the wheels, they will hang free but as there is danger of their dropping down and causing a derailment and as the brake rigging is apt to be damaged in the event of a derailment, brake shoes are usually placed above the wheels. In applying the brakes, they should never be set hard enough to cause the wheels to slide as the retarding effect is thereby decreased and flat spots may be worn on the wheels. For this reason the use of sprags is not good practice, although they are used to a considerable extent, especially in the anthracite region.

Mill Cars

Cars used around steel plants, rolling mills and forging plants are commonly known by the general name of mill cars. As the conditions in steel making plants, bar mills, sheet and plate mills, rod and wire mills, pipe and tube mills, forging plants and other steel mills differ so widely and there is such a diversity in the character of products the term mill car covers a group of cars of many types and designs.

The track gages most frequently used in steel mills are 24 in., 36 in. and 56½ in.

Owing to the wide variations in design no attempt will be made to more than briefly indicate the general character of the different types.

Platform Cars. These are used not only in steel mills but in practically every industry and are therefore general purpose cars and have been already described. For mill use they may be of the skeleton type or equipped with steel tops. Tilting platforms are also desirable in some cases, for quick and easy unloading.

As platform and other mill cars are in many places fre-

quently lifted by cranes they are often fitted with links or eyes at the corners for convenience in attaching chains and hooks.

Ladle Cars. These are used in steel making plants for handling molten metal and slag. They are described elsewhere.

Charging Box Cars. These cars are used to carry charging boxes to open hearth furnaces where they are taken from the car and emptied into the furnace by a

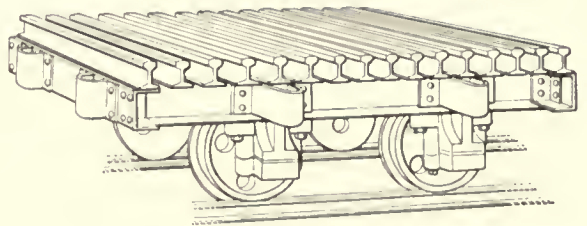

Fig. 65—Billet or Ingot Car

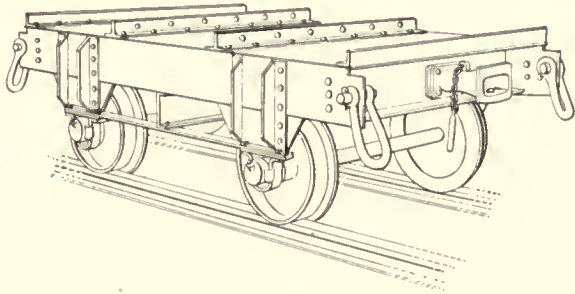

Fig. 64—Charging Box Car

charging machine such as is described in the chapter on Cranes.

Charging box cars may be constructed of structural steel, as shown in the illustration, or of cast steel. They are usually made to hold three or four boxes which requires a platform length of from 6 ft. to 12 ft. and a width corresponding to the length of the boxes, which ranges from 4 ft. to 8 ft. The capacity varies from 5 tons to 15 tons. The most common track gages are 36 in. and 56½ in.

Ingot Mold Cars. These are a modified form of platform cars, heavily built and of the proper size to hold one or more ingot molds.

Billet and Ingot Cars. Cars of many different designs are used to transport billets and ingots. They may be of skeleton construction or with tops formed of rails, structural shapes or bars, running either lengthwise or crosswise. These top bars may be flat or turned up slightly at the sides or ends of the cars, dependent upon the shape of the material handled and the way in which it is loaded.

Cars for Long Bars or Rods. Cars used for carrying long bars or rods are either equipped with steel side stakes or have the rails or bars which form the top turned up for some distance, to prevent the load from rolling off as indicated in the illustration.

Cars for Short Bars, Coils of Wire, etc. When employed in handling short bars or billets for re-rolling or forging of such a length that they are piled crosswise on the car, upturned ends are required. The height of the ends depends upon the size of the load to be carried. Such cars are used not only for short bars, etc., but also for coils of wire and other heavy material.

Cars for Large Bars and Forgings. For handling large bars or forgings, such as shafting for engines and ships, a strongly built car with a swivel top is often convenient. If the layout of the shop and the location of the hammers or presses is such that a swivel top is not needed, a car similar to the one illustrated, but without the swivel top feature, can be used instead.

Annealing Furnace Cars. Annealing furnace cars are used in steel mills, forge shops, steel foundries and other factories where the annealing or heat treating of forgings or castings forms a part of the process of manufacture.

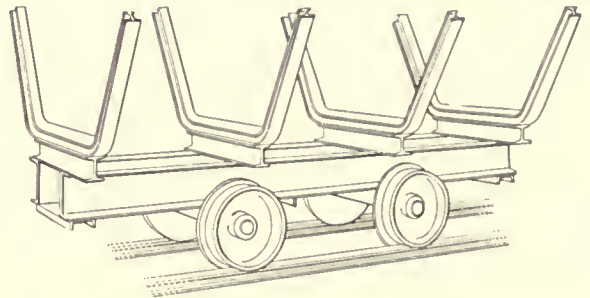

Fig. 66—Car for Bars or Rods

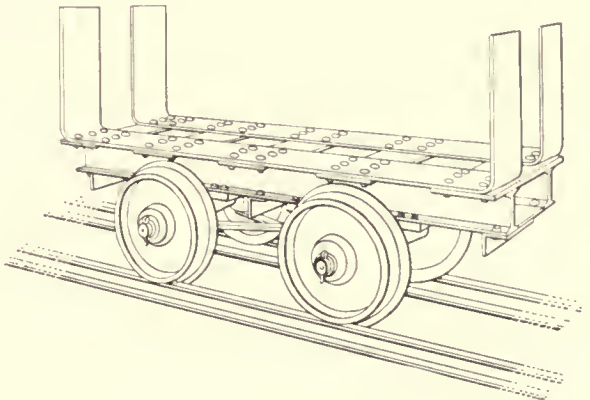

Fig. 67—Car for Short Bars and Coils

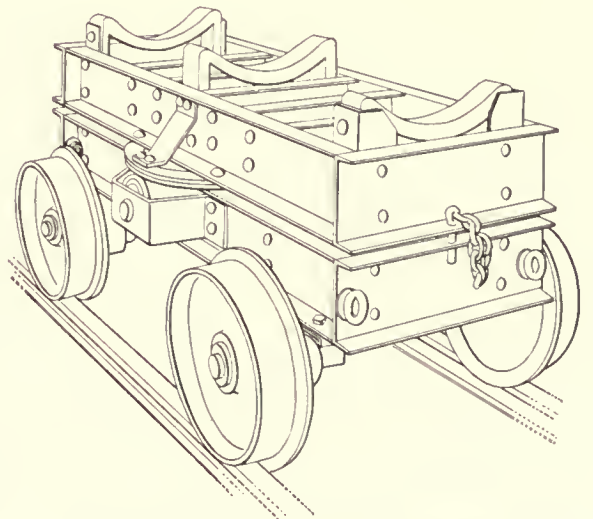

Fig. 68—Swivel Top Car for Forgings

The general practice is to cover the tops of these cars with fire brick and sand which is held in position by cast iron angles around the edge. The sand and brick provide an insulation to avoid loss of heat and to protect the underside of the car.

As these cars are only moved the short distance necessary to pull them in and out of the furnace, the track

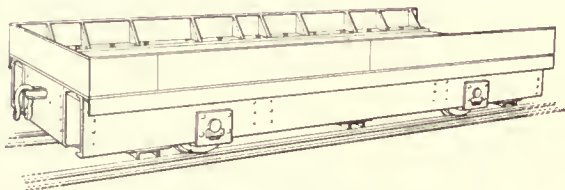

Fig. 69—Annealing Oven Car

gage and size of the car can be devised to suit the work. Short cars may be carried on two pairs of wheels, while extremely long forgings cars may have as many as eight pairs of wheels, or several short cars may be fastened together.

Ladle Cars

Ladle cars are used extensively for handling molten metals and slag in and around blast furnaces, steel mills, iron foundries, steel foundries and smelters. In capacity they range from a small car holding a few hundred pounds to one holding 60 tons or more. Small cars are mounted on four wheels and larger ones on eight or twelve wheels. In order to meet the many varied requirements there are necessarily wide differences in the design as well as in the size of ladle cars. However, such cars are naturally divided into three groups according to the general nature of the industry for which they are adapted.

Ladle Cars for Foundries. The best method to adopt for handling the melted iron in foundries depends upon the general character of the work; the size of the castings; the shape and type of the buildings; the type, size and number of cranes available; the number and melting capacity of the cupolas or furnaces, as well as various other less important factors. In small iron foundries engaged on light work the molten metal may be tapped into reservoir ladles from which it is poured into the hand or sulky ladles used for pouring the molds. Where very large castings are made a good equipment of cranes will probably be available. The iron will then be tapped out into crane ladles from which the molds are poured direct. In some foundries which cover a considerable area, especially those engaged in medium and light work and where the buildings are not high, an overhead track carrier system may be the most satisfactory. In many foundries, however, there is no method as satisfactory as a properly laid out industrial railway system which can be used for the transportation of sand, pig iron, coke, castings, etc. For foundries making both large and small castings a center bay served by overhead traveling cranes may be used for the heavier work, the side bays being used for the lighter work. In such cases the large castings may be poured by crane ladles, while the molten metal can be distributed to the bays by ladle cars.

The track gage ordinarily used for industrial railways in foundries is either 18 in. or 24 in. although many installations have been made where 21½ in. outside gage was used. For heavy work track gages of 30 in., 36 in., 42 in. or even 46½ in. are also used.

The ladle bowls are ordinarily made of boiler plate and are lined with fire brick and clay.

Small ladle cars, often called trucks, are usually built for capacities of 1,500 lb., 2,000 lb. and 3,000 lb. and occasionally for as little as 1,000 lb. The practice in most foundries is to use ladle cars to carry the iron to the different points where it is transferred to hand or sulky ladles for pouring the molds. The cars may be without gearing and with a shank as shown in the illustration although it is generally considered to be safer and better practice to use gearing, except possibly for the smallest sizes.

If used only as a car, a bail is not necessary. In many places, however, a bail is at times an advantage and is frequently added and is, of course, necessary if the car is used for transporting the molten iron and the ladle is to be lifted by a crane and used to pour the molds without transferring the iron to hand or sulky ladles.

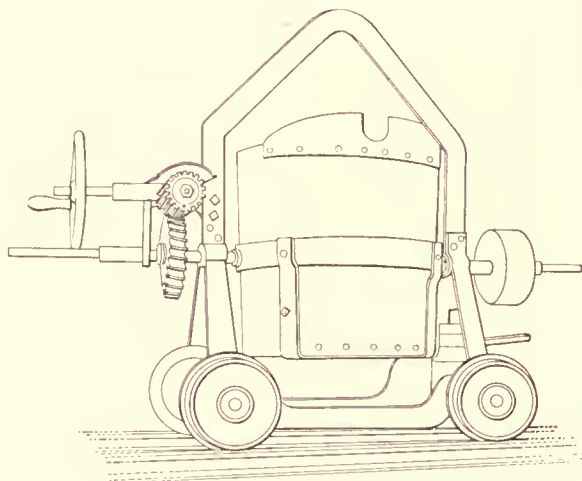

Fig. 70—Geared Ladle Car

Geared ladle cars are made in the same sizes as those without gearing and also in capacities up to 8,000 lb. without a bail, and up to 12,000 lb. or even larger with a bail attached. The larger sizes are used only on tracks of at least 30 in. gage. When bails are provided, the standards

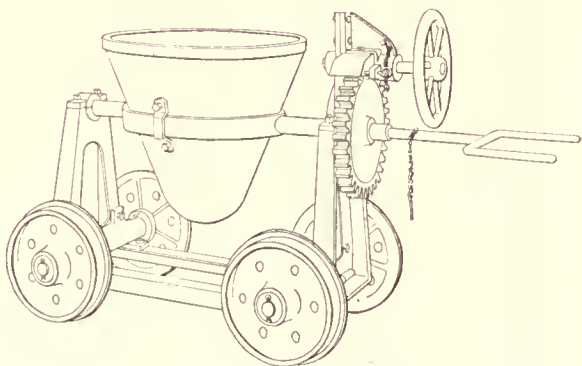

Fig. 71—Cupola Slag Car

are so constructed that the ladle itself may easily be lifted off from the bearings and used as a regular crane ladle.

The gearing for controlling the tipping may be of either the spur or worm geared type. Spur gearing is quicker acting but worm gearing is safer in that the ladle is always locked no matter in what position, and the rate of pouring

can be accurately controlled. The gearing in foundry ladles may be either partly or fully enclosed, the latter being preferred by many because of greater protection from the splashing of the molten metal.

For the handling of cupola slag some foundries use a V-body dump car lined with clay but such cars used for this service do not retain their shape very long. The better practice is to use a car similar in construction to a ladle car for handling molten metal but with a bowl of cast iron and of somewhat different shape as shown in the illustration. These slag cars are ordinarily made in capacities from 1,000 lb. to 4,000 lb. and for the usual track gages.

Ladle Cars for Furnaces and Steel Making Plants. Ladle cars are extensively employed for the transporting of hot metal and slag in and around steel plants in connection

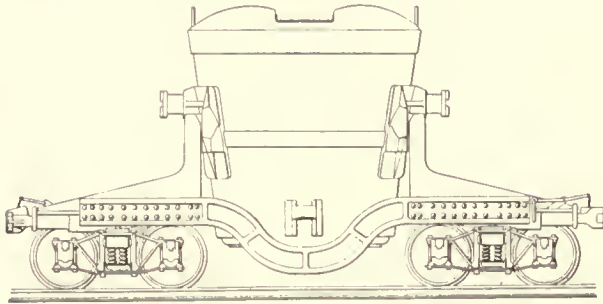

Fig. 72—Hot Metal Car

with blast furnaces, Bessemer converters, mixers and open hearth furnaces.

Hot metal ladle cars are of various sizes and designs. They may be carried on 4, 8 or 12 wheels and arranged for lip, bottom or side pouring. The ladle tilting apparatus employed and the car haulage system adopted have an important bearing on the car design. Some cars are of only a few tons capacity while others will hold as much as 60 tons. Although certain features are common, these cars are all of special design.

The track gage is almost universally the regular railroad standard, 56½ in.

The larger cars are nearly always equipped with standard automatic couplers, substantial draft gear and air brakes and conform to the best railroad practice.

At the blast furnace the molten iron may be tapped out

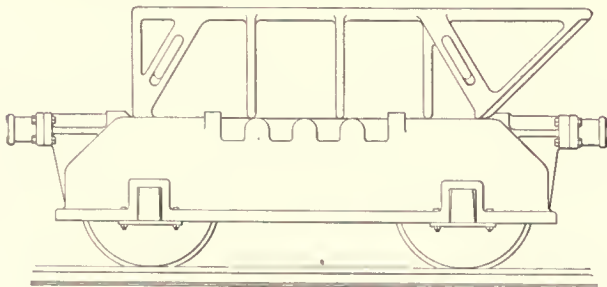

Fig. 73—Slag Box Car

into ladles and poured into pigs, either sand or machine cast; but if the iron is to be made into steel it is tapped out into ladle cars and transported to the steel department which may be as much as 10 miles away. At the steel plant ladle cars may be used to transport the hot metal to and from the mixers, converters or open hearth furnaces. The transfer ladle cars are sometimes electrically operated.

As it will be impossible to illustrate here even the most common designs of hot metal ladle cars only the outline of one 65-ton car is shown. This particular car is arranged for side pouring, a feature which may or may not be desired.

The slag from blast furnaces, converters and open hearth furnaces may be received in slag pots mounted on standards and lifted off by cranes, in slag boxes carried on cars, or in slag pot cars.

Cars used for handling slag are of many different sizes and designs. Those illustrated are simply indicative of what may be used for the purpose. In many instances slag is transported for miles before it is dumped.

Ladle Cars for Smelters. Ladle cars are not ordinarily used at copper and lead smelters for handling hot metal.

The method of handling the slag depends upon the size of the smelter and the surrounding conditions. Hand pots are used in small plants. Slag cars, varying in capacity from 10 cu. ft. to 250 cu. ft., depending upon the size of the smelter, are used in larger plants. These cars may be transported by steam or electric locomotives, or in small plants by horses and mules.

The car illustrated has a capacity of 25 cu. ft. and is typical of the design ordinarily used around medium size plants. The bowl is round, of cast iron and easily removable from the trunnion ring which is made of steel. The car is tipped by means of a worm wheel, usually protected by a guard which is not shown. The frame is extended at one end to carry a platform on which a man can ride and control the brake.

Small cars are usually of very simple design. A convenient car has a scoop shaped body mounted on a turntable

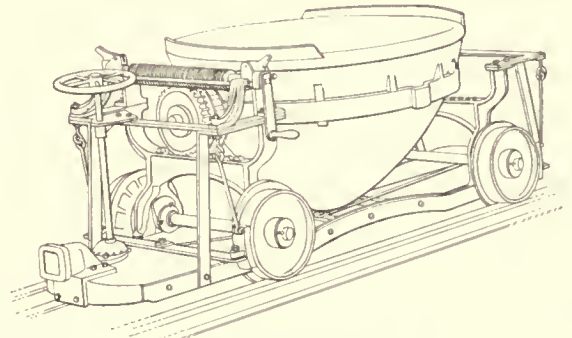

Fig. 71—Smelter Slag Car

and may be dumped in any direction by means of an iron bar placed in a hole in a lug cast on the back side.

Cars of from 40 cu. ft. to 80 cu. ft. capacities are usually of the same general type as the 25 cu. ft. car illustrated but have oblong bowls. Cars of 100 cu. ft. and larger capacities often resemble those used by the steel industry. The tilting in such cars is frequently done by means of an air cylinder or by an electric motor.

Foundry Cars

Industrial railways have for years played so important a part in the transportation of material around foundries that it would be difficult to find a progressive foundry of any size without some kind of industrial railway system. As the cars are used to transport pig iron, scrap, coke, sand, molten metal, slag, castings, and refuse, and also for

the drying of cores and molds they are necessarily of a number of different types.

The selection of the material handling equipment best suited for any foundry can intelligently be made only after a careful study of the particular plant. The equipment may include cranes, overhead track carrier systems, hoists, elevators, conveyors, hand and power-driven industrial trucks. Even though practically all of these devices may be installed, there yet will remain in most instances a field that can be covered advantageously only by an industrial railways system and its equipment.

The track gage best suited for most foundries where the work is not too heavy is 24 in., although many installations have been made where the gage was 18 in. and in other places 21½ in. outside gage has been adopted. For places where the work is quite heavy, 30 in., 36 in., or even 56½ in. gage may be advisable.

Foundry cars are apt to be handled roughly and should be substantially built. The bearings should be well protected from dust and sand and preferably should be of the roller bearing type.

Couplings are usually omitted but can be added if local conditions make their use advisable.

Ladle cars for hot metal and slag and such general purpose cars as platform and V-body dump cars have already been described.

Cupola Charging Cars. The handling of the melting stock, including pig iron, scrap, sprues, eoke and flux from the yard to the charging floor is almost universally done in industrial cars. These differ in design according to the material handled and the method of charging used, whether by hand or by machine. Unless local conditions prevent, raw materials should be received on railroad tracks running parallel to the foundry, on the cupola side

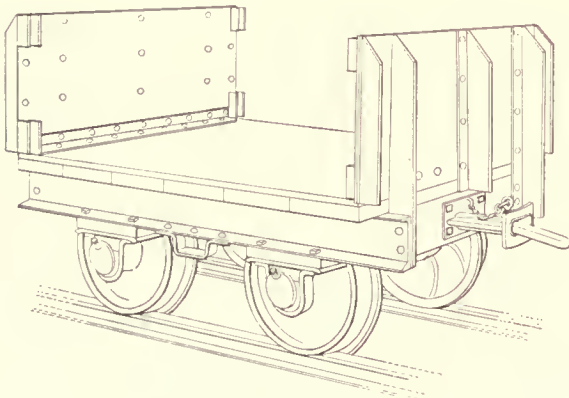

Fig. 75—Charging Car for Scrap

and some distance away. The space between the tracks and the buildings should be used for a storage yard and should be served by industrial railway tracks. Pig iron should be piled and scrap and coke unloaded into bins.

Each charge should be made up on a car and not handled again until unloaded into the cupola. The cars most generally used have a capacity of two tons and when equipped with roller bearings can easily be pushed around on level tracks by one man. The mixtures may be weighed into the car while it is standing on a scale platform or a car transfer equipped with a scale may be used to carry the car from point to point while the different materials are added. After the charge has been made up the car is pushed to the elevator and raised to the charging platform. The charging floor should be large enough and a sufficient number of

cars should be provided to handle about half of the total melt. As the cars are emptied they are returned to the yard for additional charges.

On the charging floor the cars may be run off the elevator onto a car transfer and then onto short transverse tracks, or the car transfer may be dispensed with and a series of turntables used to distribute the cars onto the different storage tracks. The charging floor in some foundries is made of plates and the tracks are omitted. In such cases the cars are equipped with combination wheels having flat top flanges so that they can be used on both tracks and flat floors.

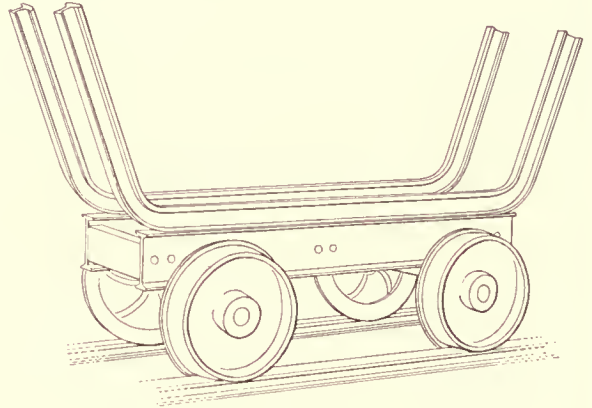

Fig. 76—Pig Iron Car

Where charging is done by hand, platform cars may be used for pig iron and scrap. Charging cars, such as have been previously described and illustrated, may be used for coke, sprues and gates, light scrap and flux, or any material handled by a shovel or a coke fork. A modified platform car with ends as illustrated may be used for scrap and pig iron and with the addition of sides it can also be used for handling sand, castings, and other materials. It is also suitable for use with a side dumping charging machine.

A car with a top consisting of two bars of rail spaced a proper distance apart to hold half pigs is often used for handling pig iron. This design is recommended only where the charging is done by hand.

Some foundries use charging cars in which most of the weight is carried on one axle having relatively large wheels, the balance of the weight being carried on a pair of small trailing wheels. Such cars can run on rails and can also be easily pushed and turned on smooth floors. They can be pushed to the charging door of the cupola and the load easily dumped by lifting the back end. While this may be done by hand an overhead air hoist is generally provided for the dumping operation. The car illustrated is designed for handling pig iron and large scrap. For coke and small scrap high sides are added.

Many of the larger foundries are now equipped with charging machines. Those of the side dumping type consist of a platform having a hinge on the side toward the charging door. The cars are run onto the platform, locked in place and the platform is tilted by an air cylinder which is usually placed underneath the platform.

Coke cars used with such charging machines usually have steel bodies and a side gate hinged at the top.

Cars for pig iron or heavy scrap generally have ends only about 12 in. high.

While the majority of cupola charging machines are of the side dumping type, end dumping machines are used where they are better suited for the arrangement of the

charging floor. In such cases the cars are arranged for end discharge.

Oven Cars for Drying Cores and Molds. As cores differ widely in size, many designs of core ovens are used and the method of making and drying cores varies widely in different foundries. For small work the core ovens may be provided with a number of individual swinging or sliding shelves or which cores are placed and removed by hand. In some places the men walk into the ovens and carry the cores. In the larger and better equipped foundries core oven cars are very generally used. These may be of any track gage and superstructure best adapted to the work, the ovens being built to suit the cars.

For small cores many foundries use a design similar to the soft mud brick or pallet car described under the head of dryer cars.

To accommodate different kinds of cores adjustable brackets are convenient. A car equipped with such brackets is illustrated. Shelf rods are used on which the core plates are placed. If preferred, corner posts can be substituted for center posts, and steel plates with holes may be used instead of rods.

For drying large cores and also large molds in connection with dry sand work, cars of many different gages, sizes and capacities are required. As such cars are only moved for short distances in and out of the ovens, the track gage may be any dimension best suited for the work, regardless of any other standards, although $56\frac{1}{2}$ in. is preferable if suitable for the local conditions. The car shown is simply typical of the type and may be modified as found advisable. Such cars are sometimes as much as 25 ft. long and 15 ft. wide, or even larger and have a capacity of 30 tons or more. Four wheels are used for most cars, although six wheels are advisable for the longer cars.

Cars of the same general type are sometimes used for transporting heavy castings. They are also used for annealing purposes and for large japanning work.

Self-Propelled Cars

Many types of industrial cars are equipped with motors and made self-propelling where conditions are such as to make their use advisable. They are generally electrically operated by current received from a trolley, a third rail or from a storage battery, although gasoline engines are sometimes employed. Some of the places in which they have been found to be economically advantageous are at boiler houses for bringing in coal and hauling away ashes, at fertilizer works, at glass factories for handling batches, at blast furnaces and other places where considerable quantities of materials are moved and a single operative unit is preferable to train operation. Self-propelled cars may also be used for a certain amount of switching and for hauling other cars.

Transfer cars used at blast furnaces and at some coal shipping terminals are frequently of very large capacity and handle more material in a single load than any other form of car.

Larries

The term larry is usually limited to certain transfer, gathering or mixing cars used in boiler houses, at glass works, furnaces and smelters. They are self-propelled with but few exceptions, are commonly equipped with scales and may run either on surface or overhead tracks.

In boiler houses they are used to transfer coal from overhead bunkers to stoker magazines. They have a suspended

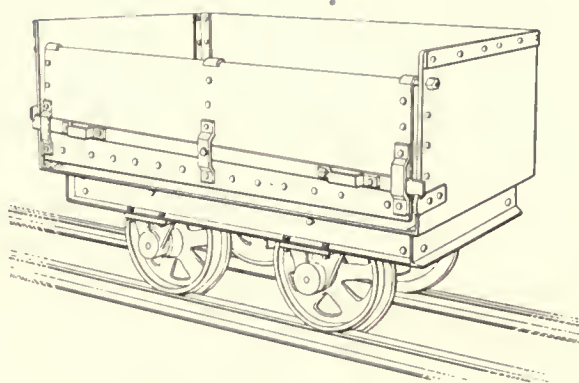

Fig. 77—Coke Charging Car

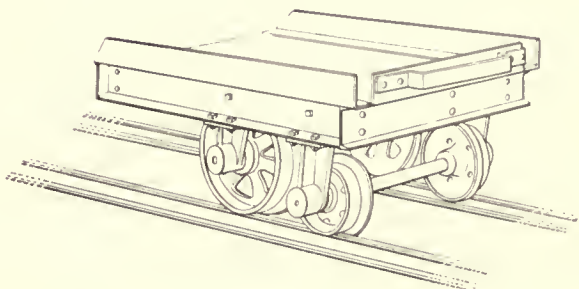

Fig. 78—Pig Charging Car, Balanced Type

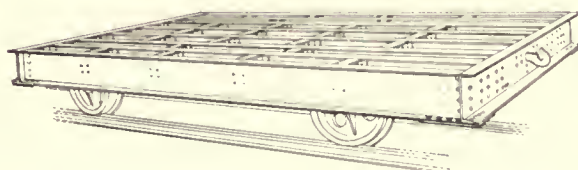

Fig. 79—Heavy Type Oven Car

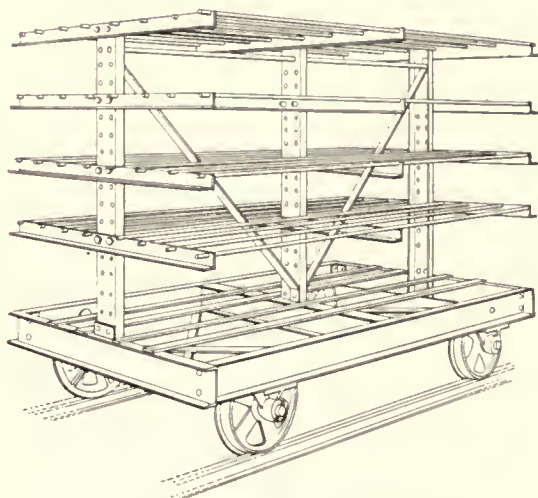

Fig. 80—Small Core Oven Car



Transfer Car Handling Iron Ore



Larry Car Receiving Load

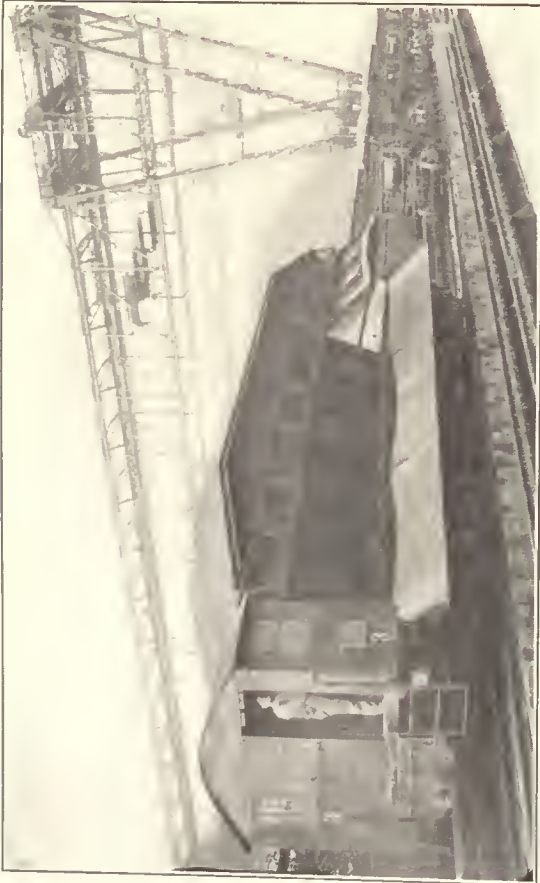

Ore Transfer Car at Blast Furnace

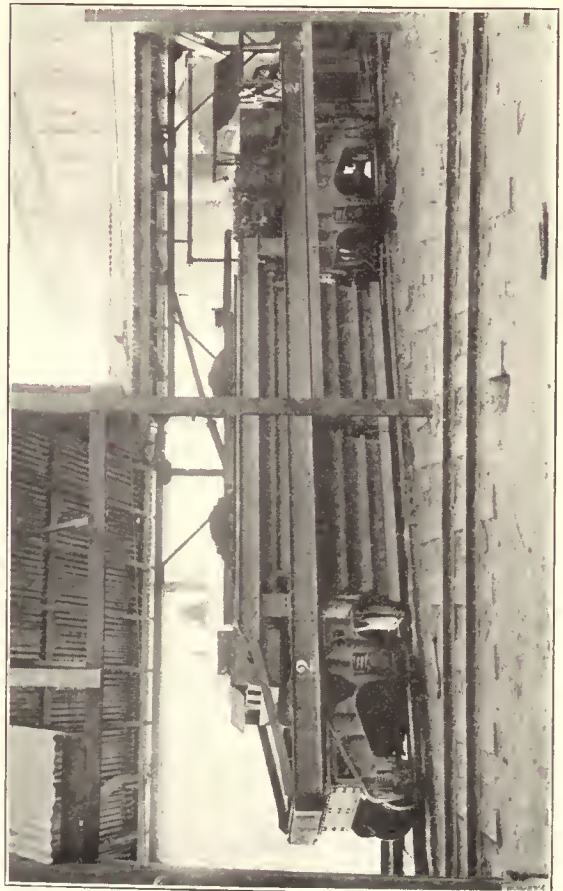

Larry Car for Miscellaneous Materials

hopper, run on broad gage elevated tracks and are usually provided with scales, often of the self-recording type. Such carriers are referred to and are illustrated in that section of this book devoted to the handling of coal at boiler houses.



Storage Battery Platform Car

At blast furnaces and smelting plants, carriers are used to gather the proper quantities of coke, ore, limestone and other materials used in a mixture and to transfer them from the various stock bins to the skip hoist which elevates them to the furnace top. They may be run on surface tracks or overhead tracks resembling those used for crane runways.

At glass works they travel from bin to bin and gather

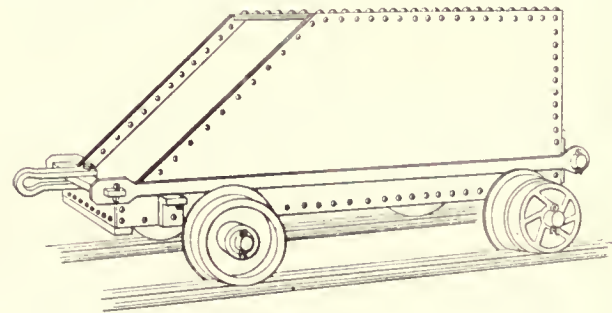

Fig. 64—Skip Car

and weigh sand, lime, ground cullet and other materials. These cars may transfer the material collected to a stationary mixer or they may be equipped with rotary mixers for mixing the batch while in transit.

Skip Cars

Cars used on skip hoists at blast furnaces, boiler houses, quarries, mines, sand, gravel and clay pits and other places where incline work is necessary are hoisted by a cable attached to a bale and are dumped automatically. Dumping is accomplished by allowing the front wheels of the car to run in on a horizontal section of the track while

the rear end of the car continues to travel up the incline. The rear wheels are usually of double the ordinary width, and at the dumping point the extended portion of these wheels runs onto another set of tracks. Such an arrange-

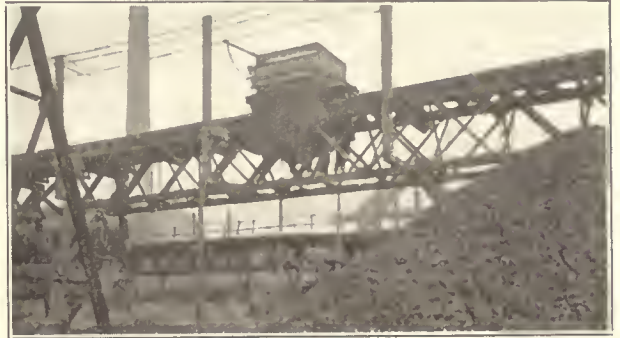

Trolley Type Gable Bottom Car

ment is shown in the skip car which is illustrated in Fig. 64. In other cases all four wheels are alike and an extra pair



Blast Furnace Skip Car

of wheels is provided at the rear. A skip car of this type is described and illustrated under the head of ore mine cars.

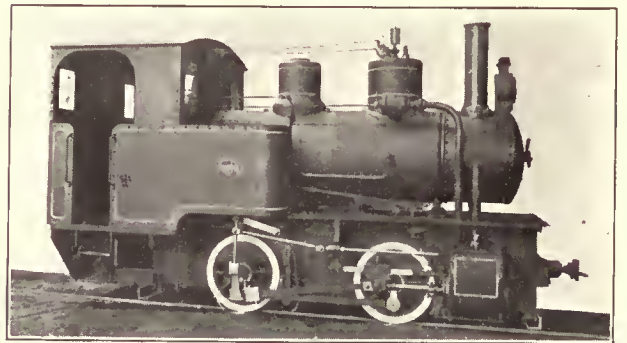
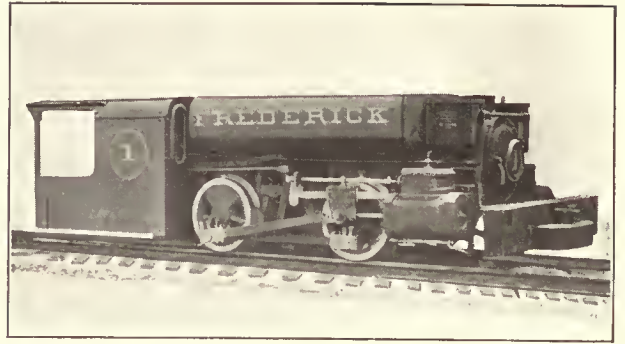

Some Types of Industrial Steam Locomotives

Industrial Locomotives

AS THE LENGTH of the haul, the weight of the articles moved and the amount of the material handled increases, a point is reached where it is not economically profitable to push individual cars by hand. Under certain conditions cars may be coupled together and hauled by animal power, but even in mines and on plantations where such an arrangement has been used extensively the tendency is to displace animal power by some form of mechanical haulage. Except for very small operations, the resultant increase in speed and capacity and the decrease in operating costs, number of men and cars required, will make such a change advisable.

For moving either individual cars, or trains of cars, between points not too far apart, and particularly where such points are of fixed location, some form of cable haulage may prove to be the most satisfactory means that can be adopted. Such haulage may be on the level, up or down inclines and on straight or curved tracks. Cable haulage is extensively used in mines and quarries. Automatic railways as well as cable railways are also frequently employed in unloading and storing coal, ore, crushed stone, fertilizer and other bulk material.

Individual self-propelled cars furnish a means for quickly and economically moving certain materials and have been found useful around many manufacturing and warehousing establishments. They are extremely flexible in their operation and when of sufficient weight and power may be used as locomotives for switching purposes or for hauling trains of industrial cars.

An examination of the surrounding conditions having shown that the use of locomotives is advisable, a careful investigation should then be made to determine the type, size and number of locomotives to best meet such conditions and to provide for possible future changes and extensions. There are steam, fireless, compressed air, combustion engine, storage battery, trolley and third rail electric locomotives from which a choice may be made. Each of these types are available in many different sizes and designs. While there are certain places in which anyone of several types might be used satisfactorily, each one has been developed to meet certain requirements and is best adapted to such a field.

Steam Locomotives

These have been used longer than any other type, have a wider field of usefulness and are more independent and flexible in their operation. Supplies of fuel and water can be provided for easily, at convenient points.

Any kind of coal, wood or oil may be used for fuel, dependent upon the ease and certainty with which it can be procured, the relative cost and the comparative convenience in handling.

Design

In order to enable a builder to recommend the locomotive which will most satisfactorily meet the conditions, the following information should be supplied:

1. Track: Gage (the perpendicular distance between heads of rails measured on straight track), weight of rail (pounds per yard), ties (kind, size, distance between centers), ground and ballasting.

2. Layout of Road: Length of road or haul, grades (maximum grade and its length against the load, also with the load together with data relative to average

grades), curves (radius, length and if on grade or level), turntables (length), fuel and water stations (location and distance apart).

3. Traffic: Material handled, amount per day, speeds, number of cars in train (loaded and empty).

4. Cars: Types, weight empty, weight of load carried, wheels (loose or tight on axles), journals (oil boxes, grease or roller bearing), couplings (style, height of center above top of rail).

5. Clearance limitations (height and width, if any).

6. Fuel and Water (kind of fuel and characteristics of water).

7. Suggestions and preferences relative to design and details.

No attempt can be made in this connection to even refer to many points of detail design which might well be considered when looking over specifications of locomotive boilers and running gear. However, a few points in connection with details of design will be mentioned very briefly.

Cylinders are usually placed outside of the frames on account of simplicity and greater accessibility, and this practice should be followed unless clearance limitations as to width requires them to be placed between the frames.

Stephenson valve motion is generally used on most types of industrial locomotives. This is a very simple valve motion, but on account of its location between the frames has been superseded to a large extent by the Walschaerts outside gear for large locomotives having three or more pairs of driving wheels.

The number of driving wheels is increased in order better to distribute the weight along the track. However, the wheel base must necessarily be kept quite short if the curves are sharp, and this may prevent the use of more than two pairs of drivers.

On narrow gage tracks, especially where there are many curves, the center of gravity should be kept low in order to decrease the danger of derailment and overturning.

The front end and stack, as well as the fire-box, should be adapted to the kind of fuel used. For coal fuel, a tapered stack with high exhaust nozzles and an extended front end containing a baffle plate and steel wire netting are commonly used. A diamond stack with wire netting in the stack, low exhaust nozzles, a petticoat pipe and a short front end are now rarely used. For soft and pitchy woods the large balloon-shaped stack with a spiral cone is the safest design. For hard wood the sunflower stack with netting across the top and an inside cast iron cone are usually provided.

Couplers may consist of a single, double or triple pocket drawhead, a hook, a forged drawbar, a M. C. B. pivoted coupler of full, three-quarter or half size or some special type.

The water tank may be carried on a separate tender mounted on four, six or eight wheels, or it may be in the form of a saddle tank over the boiler, two side tanks alongside of the boiler or rear tanks.

Two injectors are ordinarily supplied for feeding water to the boiler, although a reciprocating pump may be substituted for one of the injectors if so desired. A steam syphon may be added for filling the tanks from ponds or streams.

Superheaters are sometimes advisable, especially where fuel is expensive.



Geared Locomotive; Railroad Construction

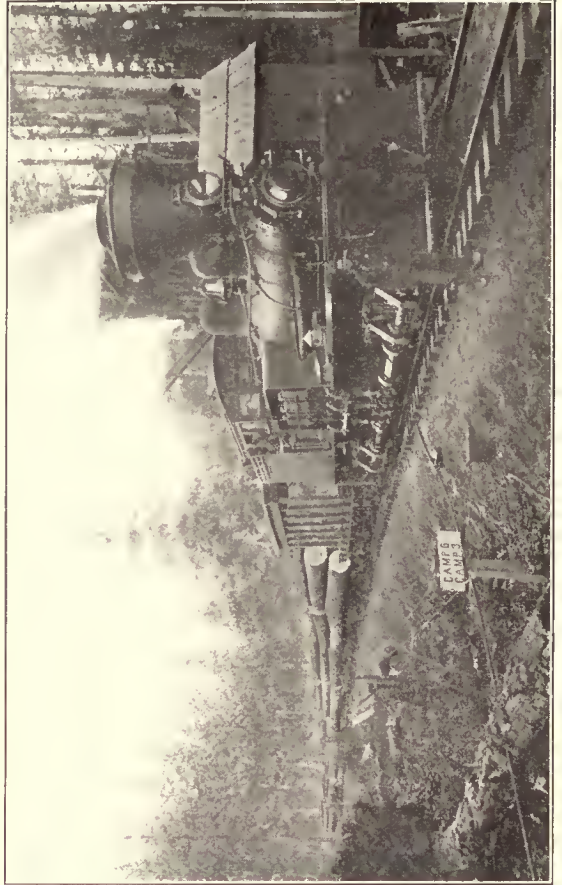

Geared Locomotive with Balloon Stack for Fire Protection; Logging



Geared Locomotive; Cement Works



Geared Locomotive; Logging



Chemical Plant



Sugar Central



Brick Plant



Manufacturing Plant



Coal Mining



Coal Mining



Road Construction



Switching

Typical Applications of Gasoline Locomotives

Locomotives may be equipped with hand brakes, or with steam, vacuum or air operated power brakes. When used to haul heavy cars or long trains for logging, construction or other work they should be equipped with the necessary air brake apparatus for handling the brake on the cars.

Capacity

The rule which is commonly used to obtain the tractive force of a locomotive is to multiply the square of the diameter of the cylinder in inches by the stroke in inches, multiply again by 85 per cent of the boiler pressure in pounds per square inch, and then divide the result by the diameter of the driving wheels in inches.

The tractive force and the draw-bar pull are often taken to mean the same thing but the tractive force includes the power required to move the locomotive and tender as well as to pull the train. The actual draw-bar pull is therefore, always less than the tractive force. In calculations of haulage capacity, the power required to move the locomotive itself should always be considered.

The hauling capacity may be calculated by deducting from the tractive force the resistance required by the locomotive to handle itself—and tender, if any—and then divide the remainder, which is the draw-bar pull, by the sum of the rates of resistance of gravity and rolling friction assumed for the cars.

The resistance of gravity due to grades is usually expressed in pounds per ton. The grade should be stated in per cent or number of feet rise in 100 ft. The resistance will be 2,000 lb. multiplied by the per cent of grade. Thus, for a 2 per cent grade the resistance is 40 lb. per ton.

The resistance of rolling friction due to wheel flanges and journals varies with the character of the rolling stock and the condition of the track. For locomotives this can be taken at approximately 8 lb. per ton. For extra good cars and track it may be as low as 5 lb. per ton, for reasonably good conditions, 10 lb. per ton and for poor cars and bad track conditions as high as 50 lb. or more per ton.

The resistance due to curves is considerable and also extremely variable. This resistance is increased as the radius is decreased and is so dependent upon the wheel base and other factors that no general formula can be given. It can be somewhat reduced by widening the gage of the track on curves and by elevating the outer rail.

Operation

The care and maintenance of locomotives as well as their running should be intrusted to as competent men as possible. A few general precautions may not be out of place in this connection.

The feed water should be as pure as possible. River and pond water is generally preferable to spring or well water. Muddy water or that contaminated by sewerage or drainage from mines should be avoided. Even clear water may contain salts or acids in solution which are injurious to the boiler. Muddy and impure waters cause deposits of scale or mud which decrease the efficiency or result in corrosion and leaks. Under certain conditions it may be advisable to treat the water with suitable chemicals. Boilers should be washed out every month or oftener if conditions require.

Boilers should be heated and cooled slowly. If used only part of the time, the fire should be banked when not in use and ash pan and fire doors kept closed. Such precautions will minimize the danger of leaky flues.

Leaky stay bolts or flues should be repaired promptly. Lost motion due to wear should not be allowed to accumu-

ulate in bearings or in driving box wedges. Pedestal braces and all bolts should be kept tight.

Geared Locomotives

For use on the steep grades, sharp curves, uneven track, light rails and bridges frequently found in lumbering operations, coal mines, clay banks, stone quarries and many other industrial enterprises, geared locomotives are better adapted than ordinary direct connected steam locomotives. Such locomotives are ordinarily mounted on two or more four-wheel center-bearing or swiveling trucks. All wheels are geared and act as drivers.

One of the best known types has vertical cylinders on the right hand side which drive a horizontal shaft. The power is transmitted through flexible couplings to pinion shafts provided with bevel gears meshing into gears attached to all wheels on that side of the locomotive. Each truck is thus free to adjust itself to the curves and irregularities of the track. This construction furnishes the shortest possible rigid wheel base and the longest possible flexible wheel base. The boiler is offset to the left to compensate for the weight of the driving machinery.

Another type employs a central shaft driven by inclined cylinders at right angles to the center line of the track. This shaft is connected by flexible couplings and bevel gearing to one axle in each truck, the other axle being driven by side rods connecting the two pairs of wheels.

A third type uses inclined cylinders parallel to the center line of the track which drive a cross crank shaft equipped with a master gear which transmits the power to the longitudinal center shaft. This shaft is connected by bevel gearing to each of the truck axles.

These geared locomotives are restricted to slow speeds, commonly from six to twelve miles per hour. On heavy grades they are able to haul about twice as heavy a load as direct connected locomotives of the same weight.

Another type of geared locomotives resembles an ordinary locomotive in general appearance, but the cylinders are connected to a transverse crank shaft back of the rear pair of drivers. This shaft is connected by a single spur pinion to a gear on the rear axle. Two or three pairs of drivers are used and they are connected by side rods in the usual manner. The wheel base is short. Such locomotives are adapted for industrial switching around sharp curves and for use on the rough track used in construction work. They have high tractive power and can be operated at higher speeds than other types of geared locomotives.

Fireless Locomotives

These employ the usual steam cylinders and running gear of an ordinary locomotive but instead of a boiler and fire box are equipped with a well insulated storage tank. This tank is charged with steam and hot water from a stationary plant. As the steam is drawn off and used in the cylinders at reduced pressure, the water gradually evaporates and maintains the steam supply. When the storage pressure falls to the cylinders' working pressure, the tank should be recharged.

The higher the pressure to which the locomotive is charged the longer it will work. One charge to a pressure of from 100 lb. to 180 lb. is usually sufficient for from two to five hours work. The cylinder pressure is usually about 60 lb.

Fireless locomotives are adopted for use around powder works, lumber yards, creosoting plants, cotton and textile mills, sugar central refineries and other extra hazardous

locations where it is desirable to eliminate sparks and smoke and where the hauls are not of too great a length.

Fireless locomotives eliminate fire risks, reduce insurance rates, are easy to operate, can be left without attention, cannot be damaged by low water and cost but little for maintenance.

Compressed Air Locomotives

These locomotives consist of a storage reservoir for carrying a supply of compressed air under a high pressure, a regulating valve for maintaining a uniform reduced pressure in an auxiliary reservoir from which the air is taken for operation, together with suitable control valves, cylinders and running gear somewhat similar to those on a steam locomotive.

A central station with air compressors, stationary storage and charging connections is also a necessary part of the system.

The cost of equipment for the central station and for the locomotives will ordinarily be more than double as much as for steam locomotives or about as much as for an installation of electric locomotives with a central power station, generators, trolley wires, bonded rails, etc.

As an offset to the increased cost, compressed air locomotives have certain definite advantages which may make their use advisable. They insure absolute protection against fire or an explosion due to sparks, flame or heat caused by steam locomotives. The exhaust consists of pure air and cannot contaminate the atmosphere, blacken walls or soil fabrics or raw materials in textile or paper mills.

Considerable economy has been obtained by using two stage expansion engines.

Compressed air locomotives are used mainly around powder works, textile mills and certain copper, bituminous and anthracite coal mines.

Combustion Engine Locomotives

These are usually driven by gasoline engines, although kerosene oil engines are sometimes used. Such locomotives have been so perfected that they are now available in many different sizes and designs which adapt them to a wide range of conditions.

They possess the advantages of being an economical type to install and operate as they are self-contained power units, requiring no central power station, overhead wiring, bonding or rails, charging station or extensive pipe lines. They are particularly adapted for use in localities where water is scarce, the cost of coal or electricity is high and in isolated places without power supply. They are in common use around many industrial plants, plantations, mines, quarries, brick yards, cement works, fertilizer works, smelting plants, construction work, lumber mills and for light switching around railroad yards.

Electric Locomotives

There are two general classes of electric locomotives. In the first the power is taken from a trolley or from a third rail. In the second class the power is supplied from a storage battery. Some locomotives are so arranged that they can either take power from a trolley or third rail, if that is accessible, or they may be shifted to battery power and operate where outside current is not available.

Electric locomotives are best adapted for use where electric current can be economically generated, where traffic is heavy and where the length of hauls is not too great.

They are frequently used around manufacturing plants, steel plants, ship yards, brick yards, cement factories, quarries and also in mines and tunnels.

They are simply and easily controlled, can be operated by one man, use power only when in actual operation, are ready for use at any time, require attention only when in use and can be operated inside buildings and in places where the smoke, exhaust and fire risk of a steam locomotive would be objectionable.

They are more expensive than steam locomotives and cannot be used in places where there is no suitable central power plant but they are not as independent and flexible in operation as steam locomotives or as well adapted for limited traffic. They, however, are capable of exerting a large momentary overload, can be used on heavy grades, exert a continuous tractive effort and have a large starting power.

Trolley and Third-Rail Locomotives

These are available in many types and sizes. They are arranged to operate on direct current of 250 volts or 600 volts tension. Alternating current is very rarely used for operating industrial electric locomotives. Double trolleys and a complete wire circuit are often employed.

In coal mines both haulage and gathering locomotives are employed. The latter type is equipped with a motor driven conductor-cable-reel which allows the locomotive to run into rooms on temporary tracks. The conductor cable is attached to the trolley wire in the main haulage way and is automatically paid out as the locomotive runs into the room and is rewound as the locomotive returns.

Storage Battery Locomotives

These are extensively used in mines and around industrial manufacturing plants, and have the advantage of a flexibility of operation not possessed by locomotives operated by current taken from a trolley or third-rail. They are decidedly preferable for use inside of buildings as there is no danger of shock from exposed conductors. They require a charging station but as the charging can ordinarily be done during the noon hour and at night there is, ordinarily, no lost time during the charging period.

Storage battery locomotives are furnished in sizes ranging from 4 tons to 50 tons in weight and of many different designs to meet various conditions.

They are operated on battery currents of 85 volts, 170 volts and 200 volts.

Articulated locomotives are employed where curves are sharp and a heavy draw-bar pull is desired. Such locomotives have a short, rigid wheel base and a long flexible wheel base. They are available in either trolley or storage battery types.

Rack Locomotives

In hilly mines and occasionally in other places there are portions of the road which are too steep for the use of ordinary traction locomotives and where it is not desirable to install chain car hauls or inclined plane cable hauls. To meet these conditions a rack is installed in the center of the track and the locomotive is equipped with a power driven gear which meshes into the rack.

For mine use the rack locomotives are of electric type and are frequently of the combination form, that is, they may operate either as ordinary traction locomotives or as rack locomotives dependent upon conditions. They are used in places where the grades are as high as 15 per cent.

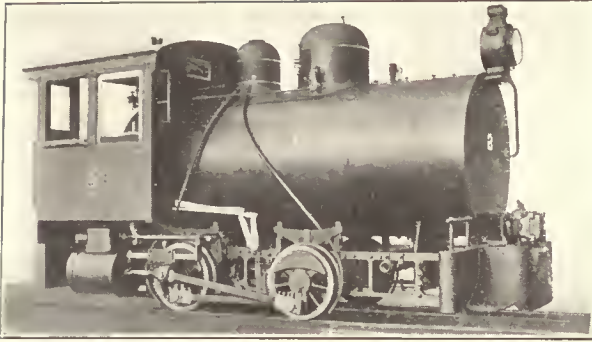

Fireless Locomotive

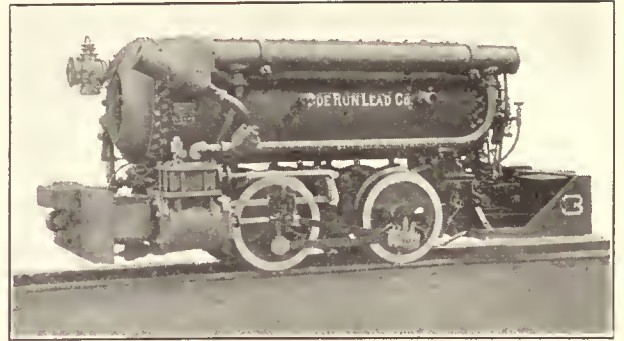

Compressed Air Locomotive

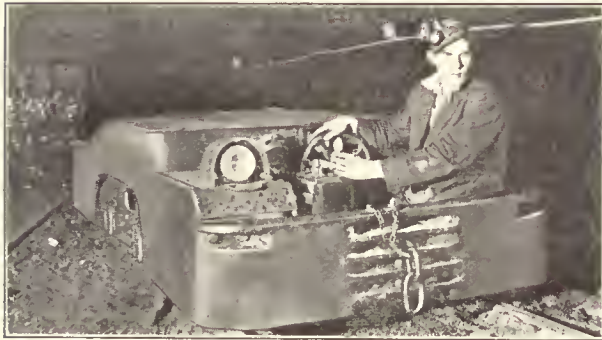

Electric Locomotive: Coal Mining

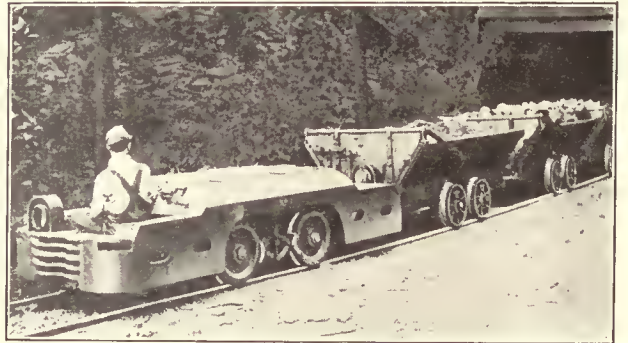

Electric Locomotive; Swing Gate Type Cars



Storage Battery Electric Locomotive and Train

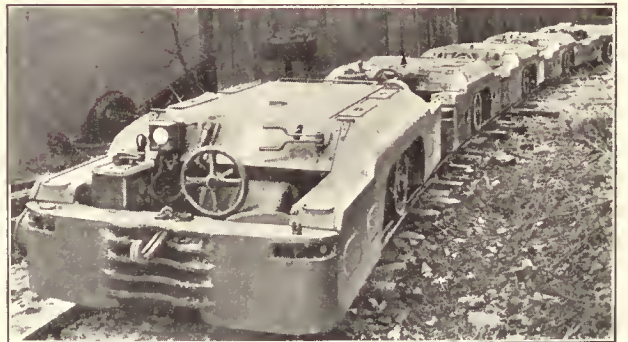

Fleet of Electric Mine Locomotives

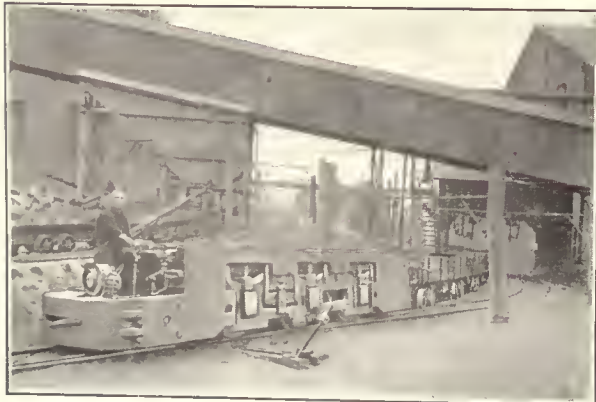

An Exceptionally Heavy Electric Mine Locomotive



Rocky Mountain Type Ore Cars

Track

THE IMPORTANCE of the selection of the proper type of a railway to meet the existing conditions, the necessity of care in the layout of the system and the need of judgment in the selection of cars and locomotives have already been mentioned. Success in the operation of the rolling stock depends in a large measure upon the choice of track details and also the manner in which they are installed. Some of the points which should be borne in mind are the nature of the road bed, the amount of grading and character of ballasting which are warranted, whether the installation is to be permanent or only temporary, whether the tracks are to be out of doors or inside buildings, the track gage, the weight and wheel base of loaded cars, the weight of the locomotives and the distribution of the weight on the drivers, the running speed and the amount of traffic.

As good a road bed as possible should be provided to secure the best operating results and to reduce the derailments to a minimum. The keeping of the track in proper alinement and of the right gage will decrease the wear on rolling stock and permit of the use of higher speeds with safety. An apparent saving obtained by a neglect of track maintenance may result in annoying delays, in damage due to cars leaving the rails and possibly in injury to workmen.

The different track devices can best be considered by taking up each one separately and showing briefly the functions and essentials of such details as rails, ties, turntables, etc.

Track Gage. This is the first detail to be decided. The subject has already been considered in describing the different types of railways, cars and locomotives but it may be well to repeat that light railways around industrial and power plants are usually of 24 in. gage although 21½ in. outside gage (for wheels with flanges on the outside of the tracks) is used to a considerable extent; that 24 in. and 36 in. gages are common in construction and plantation work and that gages from 18 in. to 56½ in. are used in mining with a strong tendency toward the adoption of 42 in. for the larger coal mining operations. Many odd gages have been used in the past and a number of such gaged roads are still in operation, particularly in the mining field. There would appear to be no good reason, however, for the use of anything except 18 in., 24 in., 30 in., 36 in., 42 in., or 56½ in. gage for new construction, with the possible exception of a few cases where 20 in. or 48 in. gage appear to be warranted.

Rails. Steel rails are designated by their weight per yard. Those most commonly used for industrial railways weigh 12 lb., 16 lb., 20 lb., 25 lb., and 30 lb. per yard. Occasionally 14 lb. rails are used and for very light construction 8 lb. and 10 lb. rails are common. For heavier work 50 lb. or 60 lb. rails may be used, while around steel mills and large manufacturing plants the rails required may be considerably heavier than 60 lb.

Various rail sections have been used from time to time by different mills, but those rolled at the present time are usually of either the A. S. C. E. or the A. R. A. standard. The former is more commonly used for the lighter sections and is the one used for the accompanying table of dimensions. The A. R. A. standard rails have a slightly greater height and a narrower base and head than the A. S. C. E. rails.

When ordering rails, and the standard section is not

known, a sketch should be furnished or the height, width of base and width of head should be stated; also the drilling dimensions for the joint.

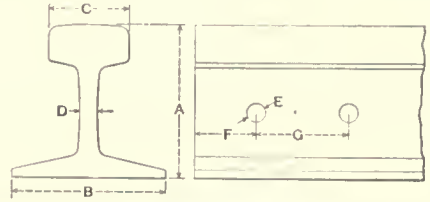

DIMENSIONS OF STANDARD A. S. C. E. RAIL SECTIONS

Weight l.b. Per Yd.	A	B	C	D	E	F	G
8	1 7/8	1 3/4	1 1/2	5/32	1/2	2	4
10	1 3/4	1 3/4	1 1/2	3/16	1/2	2	4
12	2	2	1 1/2	3/16	5/8	2	4
14	2 1/8	2 1/8	1 1/2	1/4	5/8	2	4
16	2 3/8	2 3/8	1 11/16	7/32	5/8	2	4
20	2 5/8	2 5/8	1 1/2	1/4	5/8	2	4
25	2 3/4	2 3/4	1 1/2	19/64	5/8	2	4
30	3 1/8	3 1/8	1 1/2	21/64	3/4	2	4
35	3 3/8	3 3/8	1 3/4	23/64	3/4	2	4
40	3 1/2	3 1/2	1 7/8	25/64	7/8	2 1/2	5
45	3 11/8	3 11/8	2	27/64	7/8	2 1/2	5
50	3 3/4	3 3/4	2 1/8	7/16	1	2 1/2	5
55	4 1/8	4 1/8	2 1/4	15/32	1	2 1/2	5
60	4 1/4	4 1/4	2 3/8	31/64	1	2 1/2	5

The standard lengths for rails 8 lb. to 45 lb. per yard are 30 ft. with 10 per cent of rails shorter, but not less than 20 ft. The standard lengths for rails 50 lb. per yard and heavier are 33 ft. with 10 per cent of rails shorter, but not less than 24 ft. Rails 8 lb. to 45 lb. per yard may be obtained in all 30 ft. lengths and rails 50 lb. per yard and heavier in all 33 ft. lengths if so specified, but in such cases there is a slight increase in cost. Mill lengths are usually sold at a lower figure than standard lengths. For such rails, the length varies usually between 20 ft. and 30 ft., averaging about 26 ft. For portable track the rail lengths are usually 15 ft.

Rail Joints. Two types of joints, known respectively as fish plates and angle bars, are in general use. They are

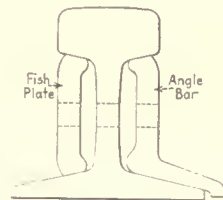

also called plain splice bars and angle splice bars. Fish plates are regularly used with rails 8 lb. to 25 lb. per yard and may be used with heavier rails. Angle bars are stiffer and therefore preferable for rails 30 lb. per yard and heavier.

As there have been considerable differences in the drilling of rails by different manufacturers, a sketch similar



to the one shown herewith should be made, properly dimensioned and furnished with all orders for rail joints.



Electric Trolley Locomotive; Quarry Installation



Electric Trolley Locomotive; Fertilizer Works



Electric Trolley Locomotive; Coal Mining

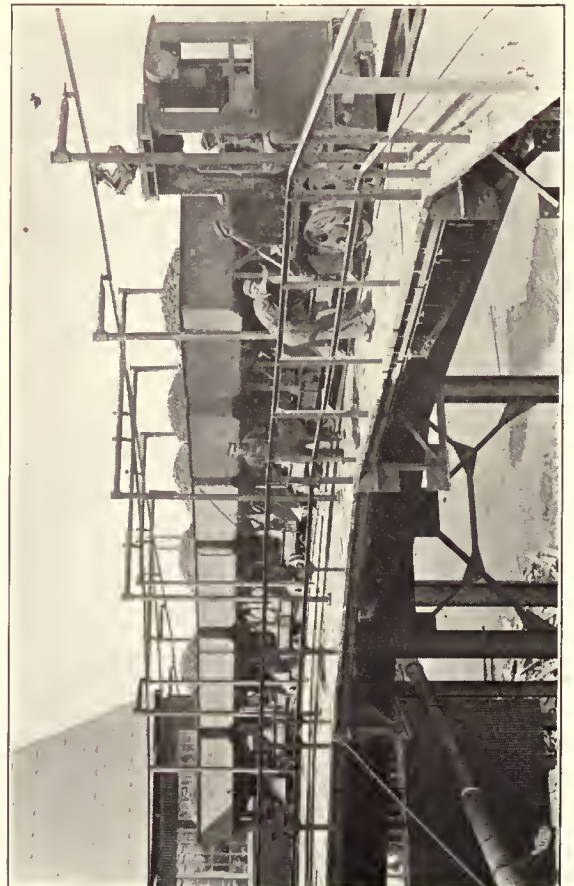

Electric Trolley Locomotive; Steel Mill

The following table will be helpful in selecting the size of rails to use under different conditions:

MAXIMUM WHEEL PRESSURE IN POUNDS

Rail Section, Pounds	Tie Spacing, Inches							
	8	12	16	20	25	30	35	40
20.....	1,140	2,200	3,550	4,970	6,390	8,340	10,540	12,780
24.....	950	1,830	2,950	4,140	5,320	6,950	8,200	10,650
30.....	760	1,460	2,360	3,310	4,260	5,560	6,700	8,520
36.....	630	1,220	1,970	2,760	3,550	4,630	5,820	7,100

Compromise or step joints are required for joining rails of different sections. To obtain the proper designation one should stand in the center of the track facing the joint and take the size of the left hand rail, then the size of right hand rail.

Track Bolts. Rail joints are furnished either with or without track bolts. If purchased separately the following table will be of assistance in estimating requirements:

Rail Section, Pounds	Size Bolt	Weight, Lb. Per Joint	Number Per Keg, 200 Lb.
8-10.....	3/8 x 1 1/2	0.38	2,116
12-14-16.....	1/2 x 1 3/4	0.865	1,012
20.....	1/2 x 2	0.91	964
25.....	1/2 x 2 1/4	0.97	915
30-35.....	5/8 x 2 1/2	1.74	505
40-45.....	3/4 x 3	2.66	302
50-55.....	3/4 x 3 1/4	2.90	291
60.....	3/4 x 3 1/2	3.12	281

Ties. Wooden ties are generally used for permanent tracks and may be used for temporary tracks provided they can be readily obtained and at an economical price. For ordinary conditions they are spaced about 2 ft. apart but for heavy service or where the ground conditions are poor, the ties may be spaced closer together with advantages.

Steel ties are used practically universally with portable tracks and are also extensively used for permanent installations. They are mainly of three general types: rolled steel of a channel shape; rolled steel of a corrugated shape and pressed steel of a dished shape. For light service

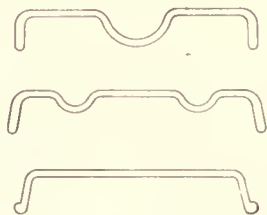

Some Tie Sections for Portable Track

and light rails the channel form is frequently chosen, although the corrugated form has a somewhat greater bearing area. Either of the rolled steel ties are satisfactory when set in concrete. The pressed steel tie of a dished shape is the most satisfactory type for general conditions. The dished form with ends as well as sides flanged, prevents the road bed material from shifting and consequently holds the track in better alinement.

Some manufacturers are prepared to furnish galvanized ties if desired. Experience thus far obtained would indicate that the additional expense was well worth while.

Rivets or tee-head bolts and clips may be used for attaching steel ties to the rails although other forms of bolts and clamps are also used. In some cases the ties are attached to the track by welding. This is said to give good satisfaction in service but does not permit the track to be taken apart for long distance shipment; neither can it be repaired easily at outlying points.

Spikes. For fastening the rails to wooden ties, spikes are used. The size is designated by the length under the head measured in inches and the size of the square stock

from which the spikes are made. Those ordinarily used for industrial trucks range in size from 2 1/2 in. by 5/16 in. (2,200 pieces per 200 lb. keg) used for rails weighing up to 10 lb. per yard to 6 in. by 9/16 in. (320 per 200 lb. keg) used for rails weighing 45 lb. or more per yard.

Screw spikes or tirefonds are sometimes used instead of the ordinary drive spikes.

Rail Braces. For supporting rails at switches and on curves, rail braces are employed. They are made of malleable iron or of pressed steel and of different sizes and shapes to suit different rail sections and conditions.

Tie Plates. Malleable iron tie plates placed between the rail and wooden ties materially decrease the tendency of the rail to cut into the tie and correspondingly increase the life of the tie. Tie plates are rarely used for rails weighing less than 20 lb. per yard and are not employed where wheel loads and traffic are light.

Switches. Stub switches made with square rail ends are sometimes used but they have been largely superseded

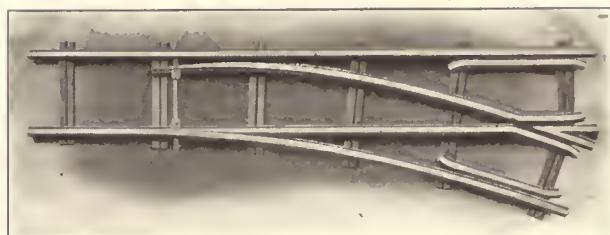

Right Hand Switch and Portable Track

by split switches with planed tapered points which are safer, more durable and eliminate the pounding which takes place when cars pass over stub switches. They are furnished in sets consisting of a pair of points with tie bars and sliding plates. Rail braces are also frequently included. The points are usually furnished straight throughout their entire length so that they can be used for either right or left-hand switches. One tie bar is sufficient for points 5 ft. long while four bars are used with points 15 ft. long. Spring tie bars can be obtained if they are desired.

Orders for switch points should always specify the track gage, the size of the rail and radius of curve. The radius of switch curves frequently used for permanent industrial tracks are 115 ft. for 24 in. gage, 150 ft. for 30 in. gage and 165 ft. for 36 in. gage, although much sharper curves are frequently employed.

Complete switches for portable track include the movable points; the frog; all necessary straight, curved and intermediate rails; tie rods; guard rails and ties riveted together ready to lay down. The curves on such tracks are frequently of 12 ft. or 15 ft. radius for the narrower gages and frequently 30 ft. for other gages.

Switches may be right hand, left hand, symmetrical two way or three way.

Climbers or inclines may be used to divert cars from a permanent track to a portable line. Two sets of climbers with a section of straight track afford a temporary crossing over another line of tracks. Two sets of climbers with curved track may be used as a combination cross-over and switch. These devices have to be removed to permit cars to pass on the main line. This may be overcome by the use of two inclines attached to a portable switch.

Frogs. Three types of frogs are in common use. In the first form the sections of rail are riveted to a steel

base plate. In the second form, used for heavier sizes only, the sections of rail are held together by bolts passing horizontally through the rails and filler blocks. The third form is cast in one piece, usually of manganese steel, and on account of its durability is economical for mines and other places where the traffic is heavy.

Frogs are designated by a number denoting the ratio of the length to the spread. Referring to the diagram, the frog member will be the result of dividing the length L by the sum of spread H at the heel plus the spread T

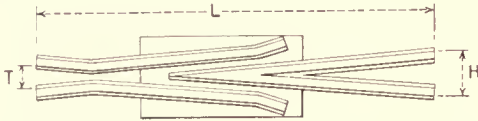

at the toe. For example: if the length L is 88 in. the spread H is 15 in. and the spread T is 7 in. the number of the frog is 4. It should be noted that H is measured between the outside edges of the rail head and T between the inside edges, both being gage sides.

Ground Throws and Switch Stands. In some cases, particularly where cast plate track is used, the switch point is thrown by foot or by a plain bar. However, in most cases, the switch is operated by means of a ground throw. The simplest form consists of a lever, frequently with a weighted end, and a connecting rod for operating the switch points, the movement of the lever being at right angles to the center line of the track. By using a bell



Ground Throw

crank the movement of the throw will be parallel to the track.

A low switch stand with a target may be added to the ground throw or a higher stand with a lever may be used instead. The shaft is usually extended above the target

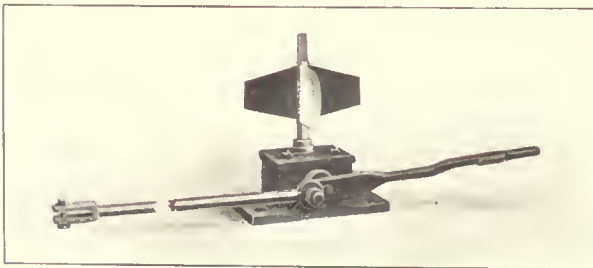

Switch Stand

and made square so that a lantern may be used if desired.

Spring connecting rods may be used in connection with ground thrown or switch stands. Their use is often desirable, as they permit a car to trail through a switch without being derailed, even when the switch is not set for such a movement of the car.

Crossings. These are constructed similarly to frogs. For medium service, the sections of rail are riveted to a steel base plate, while for heavy service the crossing is built up and bolted together with suitable guard rails and fillers.

Curves. For industrial railway work, curves are usually designed by their radius. For standard gage tracks and for heavy work the ordinary railroad practice may be followed and curvature designated by the degrees of deflection from a tangent measured from stations 100 ft. apart.

Derails. In many places derails are placed on side tracks in order to derail and stop a car should it start to roll onto the main line. They consist of a steel casting so shaped that the flange of the wheel will roll up onto it and pass over the rail. When a clear track is desired they may be swung back out of the way.

Portable Track. For construction work and other temporary installations, portable track is particularly useful as it can be quickly laid down and readily changed to new locations. If such track is not for export or to be transported for long distances by rail, the usual practice is to rivet together the rails and ties. Where cost of transportation and compactness in shipment are important, the track and the ties may be bolted together and taken apart for shipment.

Portable track is usually made up in standard lengths

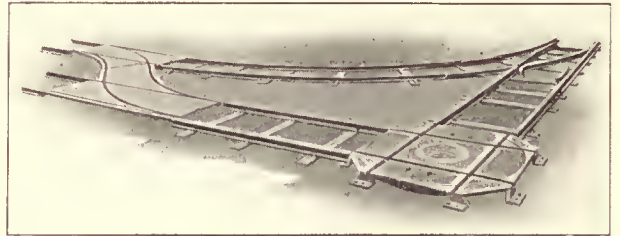

Turntable, Crossover and Switch

of 15 ft., although lengths of 30 ft. are used for track of the lighter sections.

Switches and curves are also made up in interchangeable standard units.

Cast Plate Track. For use in boiler rooms, machine shops and other places where a smooth and easily cleaned floor and one that will not interfere with other traffic is desirable, cast plate track is frequently used.

Such track is made up in standard straight and curved sections; 90 deg., 60 deg., and 45 deg. crossings and switches. Such track is usually set in concrete and laid flush with the floor. The surface is checkered to prevent slipping.

Turntables. Many designs have been made for cast iron and steel turntables. Their use is desirable in cramped quarters, as they require less floor space than switches and curves.

Transfers. For moving cars from one track to other parallel tracks a car transfer is conveniently employed. The cars used for making such transfers are described and illustrated in that section of this book describing the different types of cars.

Track Tools. For laying and maintaining track a number of standard tools are practically essential. Those ordinarily required are picks (plain, tamping and mattocks), shovels (round points, square point and tamping), axes (regular, double edge and adz), crow bars, pinch bars, tamping bars, spike pullers, sledge hammers, spike mauls, cold chisels, track winches, rail forks and carrying tongs; also track gages and track levels. Other tools which are needed for roads of considerable size are track jacks, rail saws, rail drills and rail benders.

HANDLING SYSTEMS

Modern Methods of Handling and Storing Coal

at

Mines, Storage Points, Boiler Houses, Coal Yards,
Locomotive Coaling Stations, Coaling and
Loading Vessels,

and

Methods of Handling and Preparing Sand, Gravel,
Stone and Lime.

By

HENRY J. EDSALL



Modern Methods of Handling and Storing Coal

THE INDUSTRIES OF THE PRESENT DAY are more dependent upon coal than upon any other commodity. The amounts handled are enormous. The methods of handling and storing it are, therefore, of the greatest importance. Coal is the most important item of freight which has to be handled by rail and by water. Undoubtedly the greatest factor in expediting its handling and in eliminating delays to the carriers is modern coal handling machinery.

Systems of storing coal, by making it possible to handle the coal to and from storage at a very low cost, are of great value in stabilizing the rate of output in the coal industry and also in enabling transportation companies to utilize their equipment to much better advantage, avoiding an overtax at one time and more or less idleness at another.

The amounts of coal loaded at the shipping points are large, so that considerable investment in handling and storing equipment is justified and the saving of a small amount in the cost of handling each ton means a large total saving. Coal shipments, however, are distributed among a great number of consignees, a large percentage of whom receive only comparatively small amounts, so that the investment justified for handling facilities at receiving points is apt to be much less than at shipping points where larger amounts are handled. In either case, however, the facilities should be such as to avoid excessive labor costs and delays to the carriers.

The initial handling of coal is at the mine where it may be stored or loaded direct to a railroad car. Before shipment it may pass through a breaker or a preparation plant, after which it is forwarded to the ultimate consumer, possibly passing through the hands of a dealer where it may be stored for a certain length of time, or it may rest in a central storage plant until later on when the demand is greater. Sometimes it is transferred several times from one carrier to another before it reaches its destination. There are, therefore, a number of different handlings and transfers to be accomplished before the coal finally reaches the consumer, necessitating various types of handling equipment.

The mine car in any of its several forms is the primary handling device used in coal mining. Drag chain conveyors and several types of shoveling machines are used for loading the coal into the car which ordinarily is taken to a tippie at the mouth of the mine for unloading.

Elevators or mine cages are ordinarily used in shaft mining for moving the car from the mine to the tippie. Cable-railways, chain car-hauls, locomotives—both electric and compressed air—are also largely used in the movement of the cars. Where it is not desirable to move the car direct to the tippie the coal is discharged into skip hoists or conveyors for transfer to the mouth of the mine.

Mine cars, locomotives, car-hauls, cages, etc., are treated in detail in other sections of this book.

Preparation Plants for Coal

Some of the more important essentials of separation plants, or tipples follow:

- (1) A satisfactory method of handling and dumping the loaded mine cars, and of taking care of empties.
- (2) A satisfactory transfer of the coal from the dumping point to the tippie where it is not feasible to dump the cars at the proper point for direct delivery to the preparation system.
- (3) An arrangement of picking tables, screens, transfer conveyors and refuse conveyors which will provide for the desired preparation and mixing of the coal, and the disposal of refuse.
- (4) The proper devices to load the various sizes or combinations of sizes into the railroad cars with the minimum amount of breakage.
- (5) An arrangement of railroad tracks which will provide for the easy and rapid handling of empty and loaded railroad cars, starting with the dividing up of the train of empty cars, and finishing with the making up of a train of loaded cars.

The standard cross-over dump, Fig. 1, for handling and dumping mine cars is the usual method. The loaded cars are brought to the dumping point in trains, are uncoupled as they go over a hump or knuckle, and start down a slight incline to the dump. Each car is caught by two horns, or stops, and the dump is tripped by an operator so that the car is tilted and the coal dumped out. As the

car rights itself, the stops are held down until it passes over and runs up to the kick-back, which sends it back and through a switch to another track. It can then be allowed to run on down by gravity; or it may be lowered with a car haul if the dumping point is at a higher level than that at which the trains of empties are made up; or, if it is necessary to take them up hill, this can be done with a similar car haul.

Rotary mine car dumps, which may be operated by gravity or power, are also used. This type permits the use of solid end cars, and is arranged so that the horizontal track receiving the cars comes in line with tippie floor. In the gravity type, Fig. 2, after a car has been run onto the dump, the band brake which holds the dump in position is released and the weight of the car and its load is heavy enough to cause rotation. A counterweight provided at the bottom causes the dump to return to its normal position after the car is emptied.

The power-operated rotary dumps are controlled by means of a lever which is manipulated by an attendant, and operates as an eccentric block, which throws out an automatic stop, at the same time lowering the rings of the dump on a constantly rotating trunnion. The lever is immediately released by the operator after the car latch is tripped, and the dump makes a complete revolution, turning the car over, pouring the coal out and returning to the original position; here it comes against the automatic stop in such a way that the large rings of the dump are but a

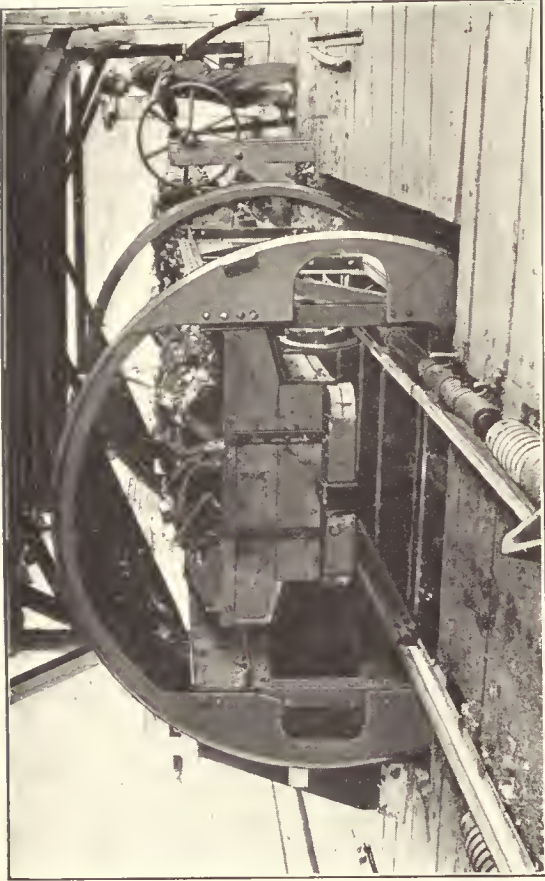

Fig. 2. Rotary Car Dump

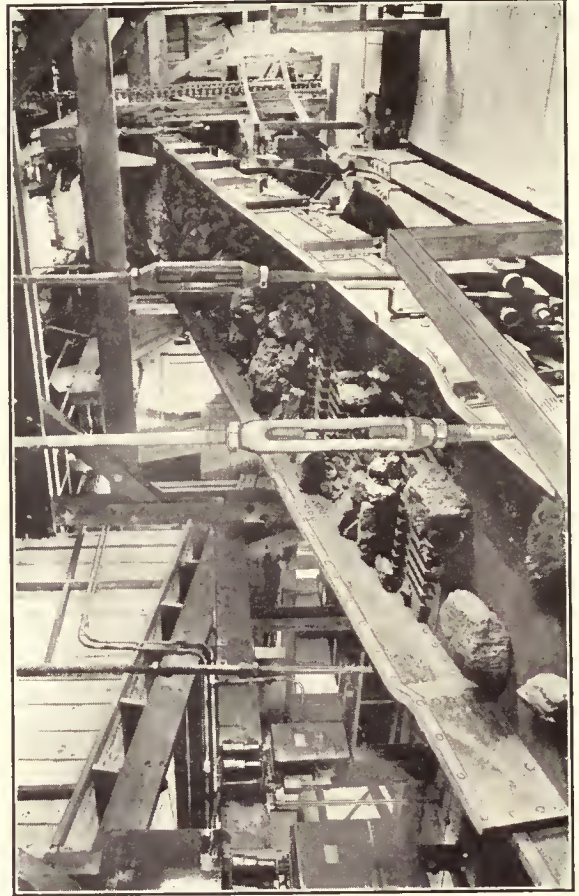

Fig. 4. Shaking Screen



Fig. 1. Cross-Over Car Dump

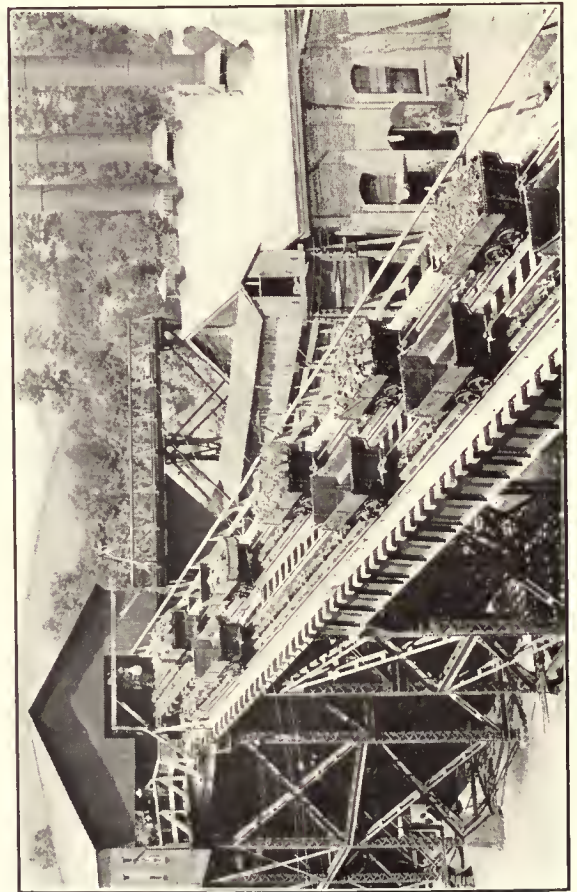

Fig. 3. Car Haul

fraction of an inch away from the rotating trunnion. After the operator trips the dump, a complete cycle is made without further attention.

Where it is desired to take the mine cars from a lower level up on to the dumping point of the tippie, it is frequently done by means of a car haul which pushes the loaded cars up an incline as shown in Fig. 3. After they are dumped they automatically pass over to the down haul, which lowers them to the foot of the incline.

In many cases when the coal is to be elevated into the preparation plants, it is dumped from the mine car, and is lifted by an inclined apron conveyor or flight conveyor. Where the mouth of the mine is above the preparation plant, the coal is usually lowered by a retarding conveyor, either a double-strand chain flight conveyor, or a cable conveyor. Sometimes the coal is lowered down the hillside by means of monitors that are similar to double-balanced skip hoists, which are raised and lowered with a double cable haul, so arranged that the two monitors balance each other, and as one goes up the other goes down.

The most usual device for screening the coal is a shaking screen, such as is shown in Fig. 4. This is hung on adjustable hanger rods, and the shaking motion is imparted to it by an eccentric connected to the screen by means of a wooden eccentric rod. The screen plates are of the lip screen type, with slotted holes a little wider at the lower end, a slight drop in the screen at the lower end of each row of slots. This makes the screen self-cleaning; that is, it keeps the holes from becoming clogged with coal and refuse, and allows the free passage of undersized material.

The most effective picking table is the corrugated apron conveyor, on which the coal is carried slowly along past the pickers so that the refuse can easily be removed. To insure effective picking, it is necessary first to remove the slack and small coal, so that it will not cover up and hide the refuse. The material is usually, therefore, first screened into several sizes, and the different sizes are carried by separate picking tables, or by the two sides of one picking table, so that the different sizes can be picked separately. In some cases the coal is screened in such a manner that the fine coal is deposited first on the picking table, and the larger coal is deposited on top of it so that it can be inspected and picked.

The refuse is usually dropped into chutes leading to a flight conveyor, or to a drag chain conveyor; that is, a wide chain which slides in a steel or cast iron trough, and pushes the material along with it without the use of any flights or other attachments. The refuse can then be delivered to a bin for removal by cars, or it may be delivered direct to a car.

After the coal is screened and picked, it is delivered either in the separate sizes to railroad cars on various tracks, or certain sizes are first combined with others by means of chutes, transfer conveyors, or a combination of the two. The smaller sizes are delivered to the cars by means of chutes, but as this method is apt to cause excessive breakage of the larger sizes, loading booms are substituted for chutes when loading the larger sizes in the best modern tipples. A loading boom is simply a hinged end of an apron conveyor, which can be raised and lowered, usually by means of an electric hoist, so that the coal may be deposited in the car with a minimum amount of drop, and therefore a minimum amount of breakage.

The railroad tracks should be so arranged that the train of empties can easily be broken up and delivered to the tracks under the tippie, and there should be room on each track for at least one empty car directly back of the one

being loaded, so that it can take its place without delay. The tracks usually have a sufficient grade to allow the cars to drop down quickly by gravity; they are held back by a cable lowering device which is operated by one of the attendants who takes care of the proper filling of the cars. The tracks come together again on the other side of the tippie so that the cars may be passed over a scale and be weighed, and then be made up into trains.

A simple and comparatively inexpensive tippie is shown in Fig. 5. There are no shaking screens and only one apron conveyor which also serves as a picking table. The coal is delivered from the dump hopper to a section of lip screen by a short apron feeder. The fine coal falls from the screen onto the apron conveyor at a point back of where the lump is deposited, thus bringing the larger coal on top, so that it can be picked properly. The apron conveyor takes the coal up an incline to the proper level, and then along a horizontal length where the picking is done. The coal is then delivered over a bar screen, the large coal going over the end of the screen into a chute with a hinged end, and thence into railroad cars on one track, while the slack goes through the screen and into railroad cars on another track. The refuse is dropped into a hopper underneath the picking table, and is taken away by mine cars. By using veil plates to cover up the screen, run-of-mine coal can be loaded. The apron conveyor is 5 ft. wide by 66 ft. long, center to center, and is driven by a 15 H.P. electric motor, which also drives the apron feeder. The conveyor operates at a speed of 45 ft. per min.; and the hourly capacity is 150 tons.

Another comparatively simple tippie is illustrated in Fig. 6. In this case, the dump hopper is at a higher level than the screen house. The coal is fed from this hopper, by means of an apron feeder, to a short section of lip screen, which delivers to the main apron conveyor and deposits the slack underneath and the lump coal on top. The apron conveyor is 5 ft. wide by 94 ft. centers, the upper part being inclined and the lower part horizontal. It is along this horizontal section that the picking is done. The coal is delivered over the end of the apron conveyor to the shaking screen where it is screened to lump, egg, and stoker sizes, the lump being loaded by means of a loading boom and the other sizes by means of chutes.

A somewhat more elaborate anthracite coal preparation plant is shown in Fig. 7. The tippie has a capacity of 400 tons of coal per hour, and is equipped with balanced shaking screens. Lump and egg are loaded by means of loading booms, and there are horizontal sections of these loading boom conveyors which are used as picking tables. Provision is also made to permit the slack and nut to be afterwards re-combined with the egg and lump, thereby making a carefully picked run-of-mine.

The coal is transferred from the dump hopper to the shaking screens by an apron conveyor, set at a slight downward incline, and the preliminary picking is done on this conveyor. A reciprocating feeder delivers the coal over the lip screen to the apron, so located that the slack will be on the bottom and the lump on top. This screen separates the coal into lump, egg, nut and slack, which can be loaded separately on four tracks underneath the screen house, two of these tracks being served by loading booms and two by means of chutes; or, by means of a mixing conveyor, the smaller sizes can be added to the larger to form almost any combination desired. The lower run of the mixing conveyor acts as a refuse conveyor and takes the refuse up to a hopper on the hillside, from which it is removed by mine cars.

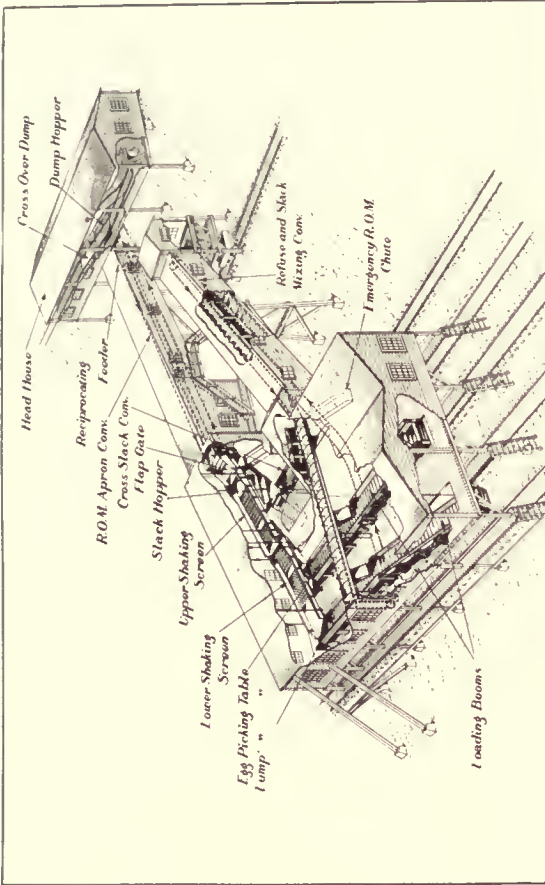

Fig. 7. Preparation Plant for Anthracite Coal

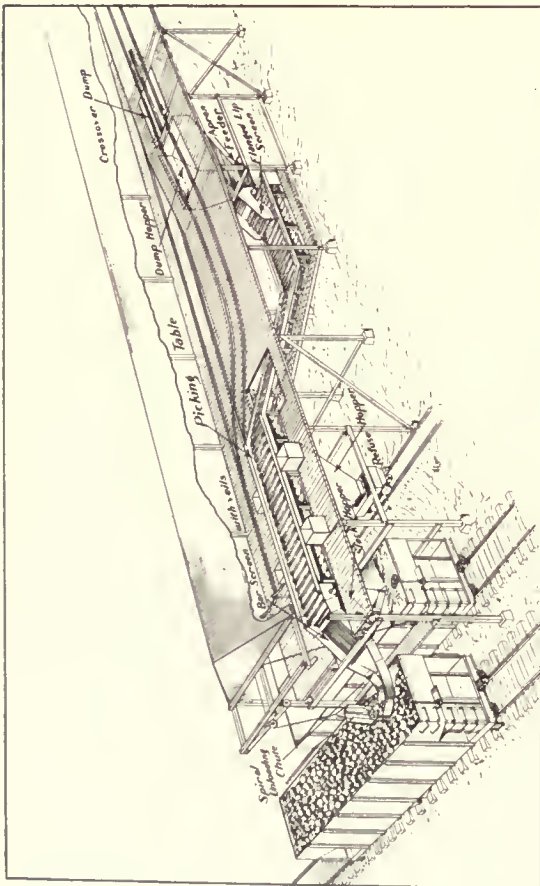

Fig. 5. Bituminous Coal Tipple



Fig. 8. Tipple for Low Vein



Fig. 6. Tipple for High Vein

A preparation plant of a somewhat different arrangement is shown in Fig. 8. Two seams of coal are mined, the lower Freeport and the upper Kittanning, and the tipple is built double so that the two kinds of coal can be handled separately, or may be combined in any proportions desired. Each of the two sets of equipment has a capacity of 250 tons per hour, which makes a total possible capacity for the tipple of 500 tons per hour.

The mine cars are brought in on two tracks, each of which has its own dump hopper and its own kick-back for running the empties back on another track, where they are picked up by a short car-haul conveyor and taken back up to a somewhat higher level for making up into trains. This arrangement brings the dump house close to the ground level and reduces the amount of structure necessary. Each dump hopper delivers to an inclined apron conveyor, these conveyors taking the coal up an incline, and delivering it to two sets of double balanced shaking screens 6 ft. wide. The screens separate the coal into slack, nut and lump, the smaller sizes being delivered to cars on two tracks under the screen house by means of chutes and the larger sizes to two other tracks by means of loading booms.

The picking is done on horizontal sections of the loading boom conveyors, Fig. 10. There is a double chain flight conveyor with a partition in the middle for taking care of the bone and refuse, so that the bone can be handled on one side and the refuse on the other; this is done so that the bone may be crushed and used in the boilers, whereas the refuse is taken away in mine cars and disposed of. This same partitioned flight conveyor connects with a cross conveyor, which is also partitioned, and which takes care of the mixing of the smaller sizes with the larger sizes, as well as the mixing of the two kinds of coal from the different seams. In addition to this, there is an emergency run-of-mine chute, leading from the head of each apron conveyor, so that the unprepared run-of-mine can be delivered to cars on one track in case the screens or loading booms are shut down for repairs.

A bituminous coal preparation plant which serves several mines is shown in Fig. 9. In this case a narrow gage railroad serves the mines so that the coal has to be transferred from the narrow gage cars to the standard ones at the junction point with the standard gage railroad. In order, therefore, to be able to prepare the coal, as well as transfer it, a preparation plant was built and its conveying equipment so arranged that the coal could be discharged from the narrow gage cars to track hoppers, serving conveyors which take the coal up into the preparation plant; the standard gage tracks are located underneath the plant so that the prepared coal can be delivered to the standard gage cars.

The diagram shows the general arrangement of the plant. It is built in two units combined under one roof, either of which can be operated separately or in conjunction with the other. As the capacity of each unit is 300 tons per hour, one unit is sufficient for handling the present output of the mines which ship over the road and the other unit is used as a reserve. This insures the station against a shutdown for repairs and makes it possible to overhaul one unit while the other is in operation, thereby making it easier to keep the plant in good operating condition. It also avoids congestion, as both units can be operated together when an extra large amount of coal has to be handled in a certain time.

The narrow-gage cars arrive on the two narrow-gage tracks which come in over the track hoppers. These track hoppers are in pairs, and each pair delivers coal, by means

of reciprocating feeds at the bottom, to two main inclined apron conveyors. Each conveyor takes the coal up and delivers it to a double-deck shaking screen in the transfer building.

The upper deck of each shaking screen has large perforations and the lower deck smaller ones. At the discharge end of each shaking screen is a main picking table; one receives the coal passing over the upper screen on one side, the smaller lump coal passing through the upper screen and over the lower one on the other side. Or, at least this is the case where these two sizes of coal are to be shipped together. When they are to be kept separate, the smaller size, instead of going over the end of the lower screen, goes through a trap door, which can be opened for this purpose, and onto a secondary picking table.

The smallest coal or slack, which goes through the perforations in the lower screen, is collected by a gathering hopper and either is delivered direct to standard gage cars or is elevated by an inclined flight conveyor, located between the two picking tables, to a height sufficient for delivery by means of a two-way chute to either of the two picking tables at the forward end. This arrangement deposits the slack underneath the lump coal and makes it possible to pick two sizes of lump coal without interference from the presence of slack.

There is a single refuse conveyor, running at right angles to the picking tables and underneath the center of the picking space to take care of the bone and slate which is picked from the coal. Chutes are provided along the tables to receive the refuse and deliver it to the refuse conveyor, which discharges to a narrow-gage car standing on a track at one side of the transfer building.

Underneath the transfer building are four standard gage tracks for cars which are to be loaded. The two main picking tables are equipped with loading booms the ends of which are raised and lowered by electric hoists. The coal from the secondary picking tables is delivered into the cars by means of inclined chutes, which can be raised and lowered, as desired.

There are also emergency run-of-mine chutes which can be used to deliver unprepared run-of-mine coal direct from the main apron conveyors to the standard gage cars, or to standard gage locomotives when it is necessary to coal them.

All the tracks are set at a sufficient grade so that the cars can be dropped down into position by gravity. These standard gage tracks have the ladder arrangement of switches so that a train of empty cars can be run in and split up so as to feed the cars down the tracks under the transfer building. The switch points are kept far enough back so that there is, in each case, room enough for an empty car just behind the one being loaded, ready to take its place without delay.

The track hoppers under the narrow gage tracks are built mostly of reinforced concrete, but with steel plates forming a certain part of their construction. The track beams are supported on cross walls and crossbeams. The transfer building and conveyor bridges are of steel frame construction covered with corrugated iron and amply provided with windows for light and air. The main apron conveyors and the picking tables are constructed with two strands of 9-inch pitch steel-strap chain with case-hardened steel bushings and flanged cast-iron rollers at the joints. The pans are of the overlapping corrugated type, made of 3/16 in. steel plates. The tracks for the rollers are made of angle irons. The width of each main apron conveyor is 42 in., that of each picking table 60 in. and each secondary picking table 36 in. The main apron conveyors are de-



Fig. 10—Picking Table and Loading Boom

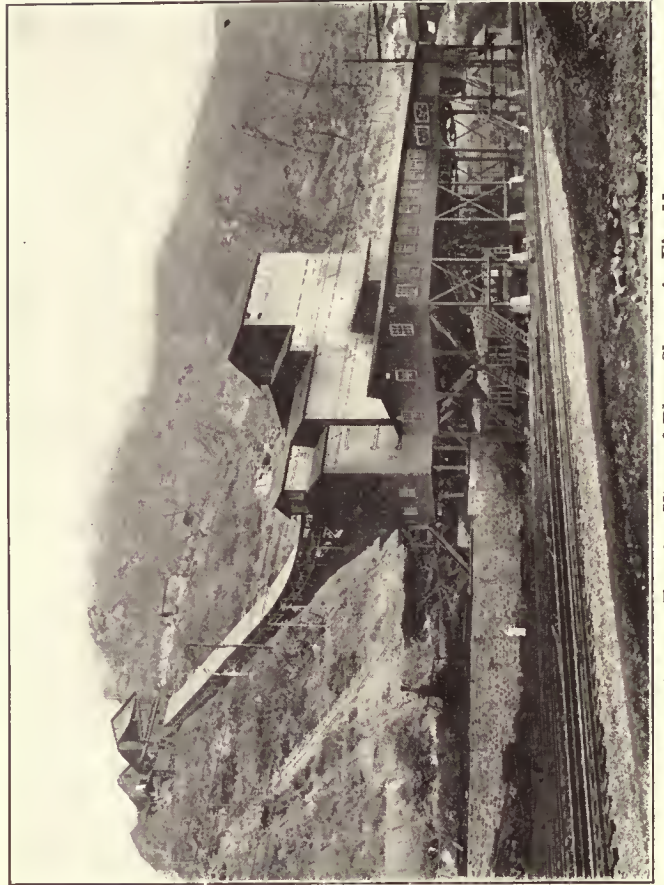

Fig. 12—Exterior View of Plant Shown in Fig. 11

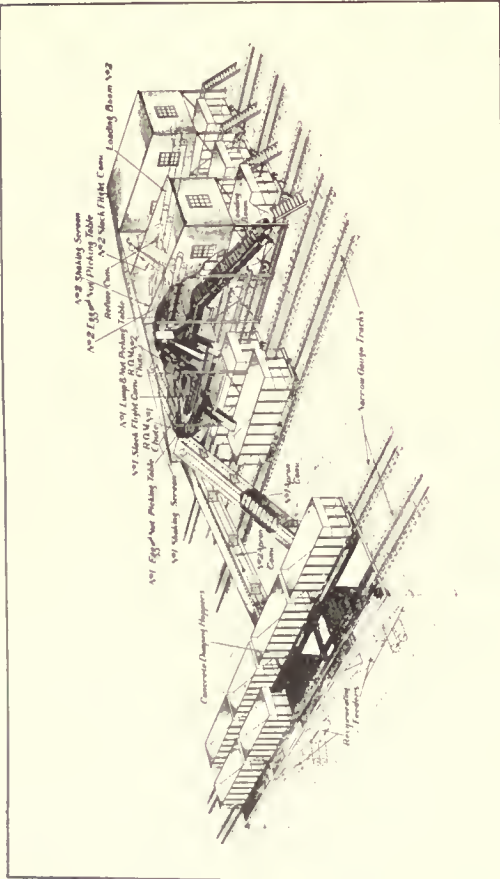

Fig. 9—A Central Tippie

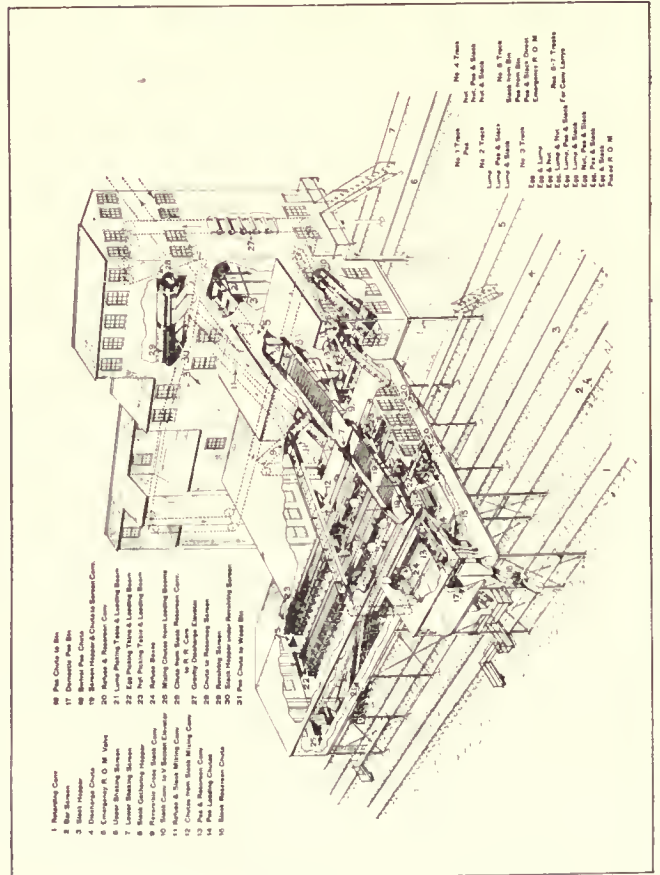

Fig. 11—A Complete Preparation Plant

signed to operate at a speed of 80 ft. per min. and the picking tables at a speed of 40 ft. per min.

Each main picking table and loading boom conveyor has a capacity of the full 300 tons per hour, so that all the coal being handled through one unit can be loaded over the single conveyor if desired. The secondary picking tables have a capacity of 150 tons per hour.

The shaking screens are 6 ft. wide and 24 ft. long and each screen is suspended by four forged steel adjustable hanger rods. The screens are operated by pairs of heavy cast-iron babbitted eccentrics with wooden connecting rods. The eccentric shaft runs at a speed of 110 r. p. m. The screens are constructed of 3/16 in. steel plate sides and 1/4 in. steel plate bottoms, with sections of lip screens arranged in both the upper and lower decks, so that the screens can be changed when it is desired to alter the size of the coal.

A very complete preparation plant is shown in Figs. 11, and 12. By referring to Figs. 11 and 12 it will be seen that the tippie is really divided into two parts, a low building over the loading tracks for the picking tables and part of the conveyor system, and a high one a little to one side that contains pea, slack and refuse bins, a rotary screen for separating the pea and slack, and a gravity discharge V-bucket machine for handling these sizes.

The two main buildings are connected by an intermediate structure, which spans one of the loading tracks and a space adjoining. The upper shaking screen extends across the intermediate building and delivers over the end to the lower shaking screen located over the rear end of the picking tables. There are five loading tracks under the picking table and intermediate building and two coke-larry tracks under the pea-and-slack building for the larries which take coal to the coke ovens.

The coal is brought into the building by a retarding conveyor, of the double-strand flight type, which has a capacity of 450 tons per hour. This conveyor extends through the pea-and-slack building and delivers over the end and through a chute to the upper shaking screen. Just above the lower end of the conveyor the trough is replaced by a bar screen with 3/8-in. openings between the bars. This screen takes out some of the slack and relieves the shaking screens of part of this work, thereby increasing the effectiveness of the screening. The slack that passes through this bar screen goes into a hopper underneath, from which it is fed to the gravity discharge machine.

When the slack is not to be removed from the coal, but the entire output is to be shipped as picked run-of-mine, or other mixtures that include the slack, the gate in the bottom of the hopper is left closed so that the hopper fills up and the slack passes over the screen.

At the lower end of the retarding conveyor is a chute to the upper shaking screen. In the bottom of this chute is a gate which, when open, allows the coal to go through into a six-ton hopper or bin for emergency run-of-mine, when this coal is to be loaded without passing it over the shaking screens and picking tables. A chute of special design to minimize breakage leads from the hopper to the cars.

The upper shaking screen is 8 ft. wide by 28 ft. 9 in. long. The screen part is 16 ft. long and contains 1/2 in. x 3/4 in. perforations to take out pea and slack. Underneath this shaking screen is the pea and slack gathering hopper, with a chute leading to the cross slack conveyor No. 9. This cross slack conveyor takes the pea and slack over to the mixing conveyor, when it is to be put back with some of the coal that is being loaded, or, if the cross slack conveyor is reversed, the pea and slack is taken over to conveyor No. 10, which conveys it to the gravity discharge V-bucket machine in the pea-and-slack building.

The coal which passes over the upper shaking screen moves on to the lower one, which is 8 ft. wide by 29 ft. 3 in. long. In the upper part of this screen is a section of lip screen through which the nut size passes to the gathering hopper underneath and then to the nut picking table. In the lower part of this screen is another section of lip screen for taking out the egg. The egg size that goes through this screen is delivered to the egg picking table.

In both the egg and nut gathering hoppers under the lower shaking screen there are sections of rescreening plates with small openings for cleaning the egg and nut coal still more carefully by taking out any slack and pea coal which they may still contain, just before they go onto the picking tables. This pea and slack goes first to one of the conveyors, No. 20, and then to the rescreen conveyor No. 13 for delivery either to the cross slack conveyor No. 9, or, at the end, to a small hopper for loading to cars on track No. 5.

There are three picking tables for lump, egg and nut in the picking-table building. Each table has a horizontal part upon which the picking is done that is 29 ft. long from the center of the driving shaft to the hinge of the loading boom. Adjacent to this is a loading boom section 37 ft. in length which can be lowered into railroad cars so that the coal may be deposited with a minimum amount of drop, and therefore, with a minimum of breakage.

There is room for at least six pickers at each table. These pickers remove the bone, slate and other refuse from the coal and drop it down conveniently located chutes leading to the refuse conveyors, which deliver it to conveyor No. 11, which conveys it to the refuse bin in the pea-and-slack building. From this bin it can be discharged into rock cars on tracks just beyond the larry tracks.

Going back to the pea and slack, it was previously stated that these sizes could be delivered to the V-bucket machine from conveyor No. 10. The V-buckets elevate this coal and discharge it over a chute to a rotary screen, the screening part of which is composed of wire cloth with 3/8-in. square openings. After the slack goes through the screen, it is again discharged to the V-buckets which travel underneath the screen. The buckets then convey and discharge it into a 350-ton slack bin.

If desired, it can be delivered to the upper run of the mixing conveyor instead of to the bin, by means of a rack and pinion gate in the conveyor trough. It may then be deposited on the lump, egg or nut loading booms at the hinge points, when it is desired to mix it with these sizes. The pea size goes over the end of the screen into a bin of 150 tons capacity. The slack coal may be drawn off from the slack bin into railroad cars on track No. 5 or into the larry cars on tracks Nos. 6 and 7, to go to the coke ovens.

The pea can be loaded into railroad cars on track No. 5 or it may be reclaimed by the V-buckets from the bin and delivered to the upper run of the pea-and-rescreen-conveyor No. 13, which discharges it at the far end over a chute to railroad cars on track No. 1, or to a five-ton pea-coal bin for domestic purposes, this bin being equipped with a swivel chute for loading to wagons. The chute to the cars has a rescreen plate in the bottom to remove small coal and deliver it to the screen conveyor.

The loading of the various sizes on the different tracks is accomplished as follows:

Lump—From lump loading boom direct to cars on track No. 2. From lump loading boom, in raised position, over chute to cars on track No. 3.

Egg—From egg loading boom direct to the cars on track No. 3.

Nut—From nut loading boom direct to cars on track No.

4. From nut loading boom, in raised position, over chute to cars on track No. 3.

Pea—From end of conveyor No. 13 to cars on track No.

1. From pea bin over chute to cars on track No. 5.

Slack—From slack bin over chute to cars on track No. 5.
5. From slack bin over chute to larries on tracks Nos. 6 and 7. From mixing conveyor No. 11 to lump, egg or nut loading booms and thence to cars on tracks Nos. 2, 3 or 4.

Pea and Slack—From gathering hopper under upper shaking screen. From mixing conveyor No. 11 to lump, egg or nut loading boom and thence to cars on tracks Nos. 2, 3 or 4. From gathering hopper, under shaking screen, through gate in conveyor No. 9 and over chute to cars on track No. 5.

By using the above operations in different ways, the separate sizes and combinations can be loaded on the several tracks as follows:

No. 1 Track—Pea

No. 2 Track—Lump; lump, pea and slack; lump and slack

No. 3 Track—Egg; egg and nut; egg and lump; egg, lump and nut; egg, lump, pea and slack; egg, lump and slack; egg, nut, pea and slack; egg, pea and slack; egg and slack; picked run-of-mine

No. 4 Track—Nut; nut, pea and slack; nut and slack

No. 5 Track—Slack from bin; pea from bin; pea and slack direct; emergency run-of-mine

Nos. 6 and 7 Tracks—For coke larries.

The picking-table building and the intermediate building are of steel frame construction, covered with corrugated ingot iron. A generous supply of light is obtained by a large number of windows around the sides of the building, and the picking tables receive additional light from a skylight. The pea-and-slack building is covered with corrugated ingot iron, and the machinery there housed is well lighted from the windows in the sides and ends.

The shaking screens are of the double, balanced type and are suspended from four hanger rods, with turnbuckles for adjusting the angle of inclination. They are operated by ball-and-socket eccentrics, which are self-aligning and are driven at a speed of 100 r. p. m. The first shaking screen takes out the pea and slack, which goes into the gathering hopper underneath, and then into the cross slack conveyor. The lower shaking screen removes the nut and egg, which are delivered, by means of hoppers and chutes underneath, to the nut and egg picking tables. The lump coal that passes over the screen openings goes over the end of the screen to the lump picking table.

As stated previously, the egg and nut picking tables are both 5 ft. wide, and the lump table is 4 ft. wide. The picking tables are constructed of 3/16 in. corrugated steel pans, attached to a double strand of 9-in. pitch, steel-bushed strap chain, with through rods every 3 ft., to act as spacers and to tie the chains together efficiently. There are 3/4 in. rollers at the chain joints, which travel on steel angle tracks on both the carrying and return runs.

Steel channel guards are placed along the tables on each side where the pickers stand. The chains are further protected by side guards to keep the coal from getting on them and to make it safer for the pickers. The channel sides also serve as a table on which the refuse can be separated from the coal with picks.

Steel refuse chutes, by means of which the refuse is delivered to the refuse conveyors, are placed at convenient intervals along the picking tables. Each picking table and loading boom is a continuous machine, the loading-boom end being constructed so that it can be raised and lowered. This operation is accomplished by means of an electric

hoist, the hoisting rope being attached to a bale at the end of the loading boom; these electric hoists make it possible to raise and lower the booms easily and quickly. Ordinarily each boom is lowered into a car when coal is being handled over it, but, as previously described, the outside booms are sometimes used in the raised position, when it is desired to deliver the coal into chutes which lead from the booms to cars on track No. 3, so that certain mixing operations can be accomplished.

Conveyors Nos. 9, 10 and 11—namely the reversible cross slack conveyor, the slack conveyor to the V-bucket elevator and the refuse and mixing conveyors—are all double strand flight conveyors of 12-in. pitch, steel-bushed, steel strap chain, with 36 in. x 12 in. x 3/8 in. steel flights every 3 ft. The trough bottoms are of 1/4 in. steel plate, and the sides of the trough are plates and shapes. The chains have 3/4 in. rollers at the joints, and these rollers travel on steel angle track on both the carrying and return runs, so that the flights are supported slightly above the troughs along which they push the coal. The power required is thus reduced to a minimum. The speed of these conveyors is 100 ft. per min. and at this speed they can handle 250 tons of coal per hour.

Conveyor No. 13, the pea and rescreen conveyor, is of similar design except that the flights are smaller, the size in this case being 20 in. x 8 in. x 1/4 in. These flights are spaced at intervals of 3 ft.

Conveyors No. 20, the refuse and rescreen conveyors, are of the same size and construction as conveyor No. 13, except that in this case the flights are spaced at intervals of 4 ft. instead of 3 ft.

Conveyor No. 27, the gravity discharge elevator, or V-bucket machine, is made up of a double strand of 18 in. pitch, steel-bushed, steel strap chain, with 5-in. enclosed oiling rollers at the joints. The buckets are 48-in. long by 24 in. wide by 16 in. deep, spaced 36 in. They are made of 1/4 in. steel plate and have reinforcements of 2 in. x 1/2 in. ovals around the top edge. On vertical runs the rollers of the chains travel between double guides, and the coal is carried up in the elevator buckets.

On the horizontal and inclined runs the chain rollers travel on steel tracks, and the buckets serve in a similar manner to the flights of a flight conveyor—namely, to push the coal along in the trough, which is of 1/4 in. steel plate.

This machine runs at a speed of 100 ft. per min. and has a capacity of 250 tons of coal per hour.

The revolving screen is 5 ft. in diameter and 24 ft. long, and revolves at a speed of about 12 r. p. m. There is a 3 ft. section of dead plate at the receiving end and a 6 ft. section of dead plate at the discharge end. Between these dead plates is the screening section, made up of No. 8 gage wire, with 3/8-in. clear openings.

The longitudinals of the screen frame are made of double 5 in. x 3 in. x 3/8 in. angles riveted back to back. There is also an intermediate ring at the center, 12 in. wide, with three 1/4-in. reinforcing rods. The screen is mounted on two cast steel rings, one of which has a bevel surface to engage with a thrust roller, and the friction rings ride on, and are revolved by two pairs of 22 in. x 5-in. chilled face rollers.

The motors for operating the machinery are as follows:

One 125 h.p. motor, for the V-bucket machine and revolving screen.

One 60 h.p. motor for the shaking screens and cross slack conveyor to V-bucket machine.

One 50 h.p. motor for the picking tables and the pea and rescreen conveyor and the two refuse and rescreen conveyors.

One 30 h.p. motor for the refuse and mixing conveyor.

The driving machinery includes clutches, so that any unit can be cut out at will. Walkways and stairways are

provided for access to all parts of the equipment, and these all have a clear headroom, to avoid injury to the attendants.

Large Central Coal Storage Plants

The necessity for storing greater amounts of both anthracite and bituminous coal during the summer season and during times of low demand is becoming more and more apparent. The objects are as follows:

1. To stabilize the coal mining industry.
2. To equalize the transportation of coal at various seasons of the year.
3. To avoid coal shortage.

From the standpoint of the coal mining industry it is important to keep the output of the mines as uniform as possible, so that the miners will have regular work instead of working only part time during the summer season or other times of low demand, and having a great deal of overtime during the winter season, or other periods of high demand. Such a condition in terms of the electrical engineer is called a "bad load factor." It tends to an excessive amount of equipment and personnel to meet the high peak loads of excessive demand, which cannot be used when the demand is low. Such irregularities tend to increase costs of production and also tend to promote dissatisfaction among the miners, resulting in demands for high wages for the irregular hours of actual work, and also causing disputes between miners and operators resulting in strikes which interfere with the coal supply which is so vital to industry in general.

From the transportation point of view the results are somewhat similar. An excessive amount of freight train equipment is required to meet the high peak loads in the transportation of coal, and this is more marked since the amounts which can be handled by each coal car are more or less fixed. A great many extra cars, locomotives, etc., have to be supplied to transport the large amount of coal which must be handled at times when the demand is greatest, usually in the winter when transportation difficulties are at their worst. In the summer time, and at other times when the demand is low, a great deal of this rolling stock is idle, and the need for men to man the trains, etc., is greatly reduced. Additional equipment means, of course, additional investment and additional overhead expense, and a tendency to the same sort of trouble and additional expense in regard to the personnel as is the case with the mining companies. In other words, uniform output and uniform transportation mean minimum expense in the cost of mining and transporting coal.

As to the importance of insurance against coal shortage, this phase of the question has been brought home most forcibly in the last few years, especially to the large coal consumers such as the gas and electric companies and large manufacturing plants and coal dealers. There is, therefore, a tendency among large consumers to store more and more coal in their own reserve storage plants, but this practice is not universal enough to take care of the problem in an adequate manner. It is doubtful whether consumers and dealers will ever provide sufficient storage facilities properly to equalize the demand upon the mines and transportation companies.

If, therefore, adequate facilities are to be provided it must be done by the coal mining companies, the railroads, the large consumers and dealers, by combinations of consumers or dealers, and by states and municipalities, or other political subdivisions.

The building and operating of large coal storage plants means, of course, an additional expense which must be added to the cost of the coal, but this additional cost should be more than offset by the reduction in the cost of mining and transporting the coal which will be accomplished by stabilizing the industry.

Best Location for Storage Plants

In determining the best location for a large central coal storage plant, a number of factors must be taken into consideration. If the coal is to be stored by a mining company, the logical location would ordinarily be convenient to the mine so that the coal could be handled from the mine to the storage plant economically and with little likelihood of interruption. If this handling is done by equipment belonging to the mining company it places the work entirely under the control of that company and relieves the transportation companies. The loading and unloading of railroad cars will be eliminated, the mine owner will not be dependent on the supply of railroad cars, and he can arrange his rate of mining to suit his own convenience, either shipping the coal or stocking it according to the demand.

Since the length of haul will be the same whether the coal is shipped direct from the mine or from a storage plant adjacent to the mine, such a location for a storage plant will not help solve the transportation problem to any extent. From the transportation point of view the best location for a storage plant is at some point centrally located in relation to the principal points of consumption so that the coal can be delivered to the storage plant during times of low demand and favorable weather conditions, and can be distributed from the storage plant rapidly and economically because of the short hauls and also the greater trackage facilities which are usually available in large industrial centres.

Determination of Type of Storage Plant

In designing large coal storage plants the first question to be considered is the kind of coal to be stored; first, whether it is anthracite or bituminous; second, the size of the coal and other special characteristics. Anthracite coal deteriorates scarcely at all when exposed to the weather and there is little, if any, danger of spontaneous combustion.

Bituminous coal loses some of its heating value when stored exposed to the weather, but the amount of this loss is less than usually supposed and the rate of loss decreases as the coal becomes seasoned providing it does not heat up. If heating occurs due to oxidation of the coal and there is not sufficient circulation of air to carry off the heat, the oxidizing effect increases until finally the coal catches fire by spontaneous combustion. This makes the problem more complicated with bituminous coal than with anthracite, and in addition to this, anthracite coal is usually uniform and small in size so that it is easier to handle with conveyors than run-of-mine bituminous coal which contains large lumps.

Anthracite Coal Storage Plants

While various methods are resorted to in storing anthracite coal in moderate sized plants or in temporary plants, the system which is used almost exclusively for large an-



Fig. 3—Covered Storage Plant

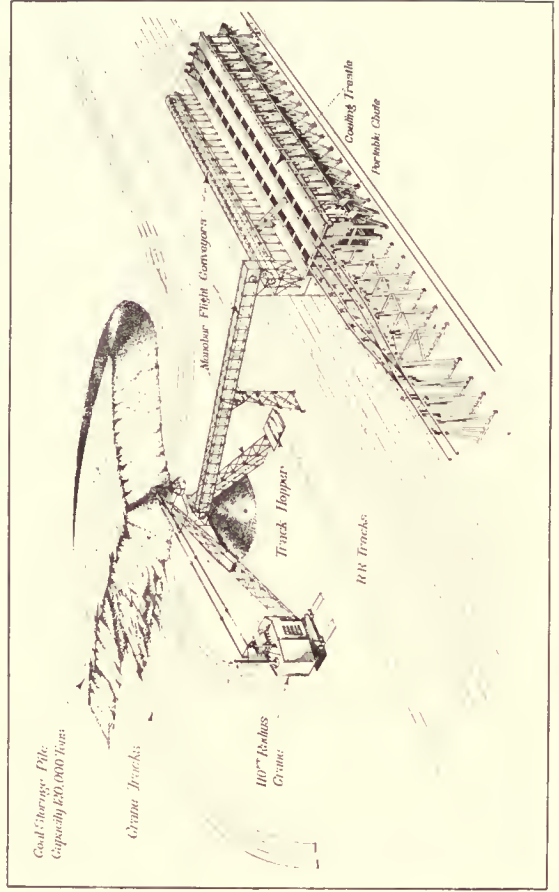

Fig. 4—Semi-circular Storage Plant

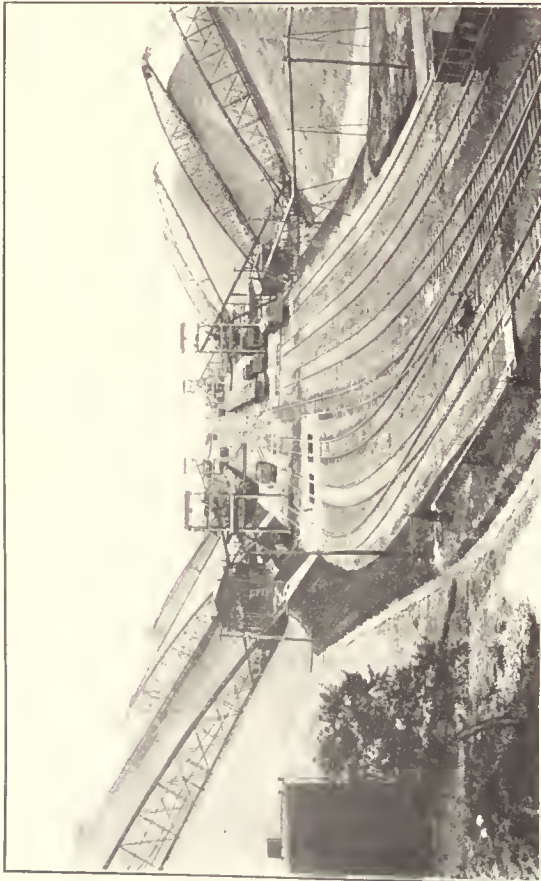

Fig. 1—Dodge System of Storage

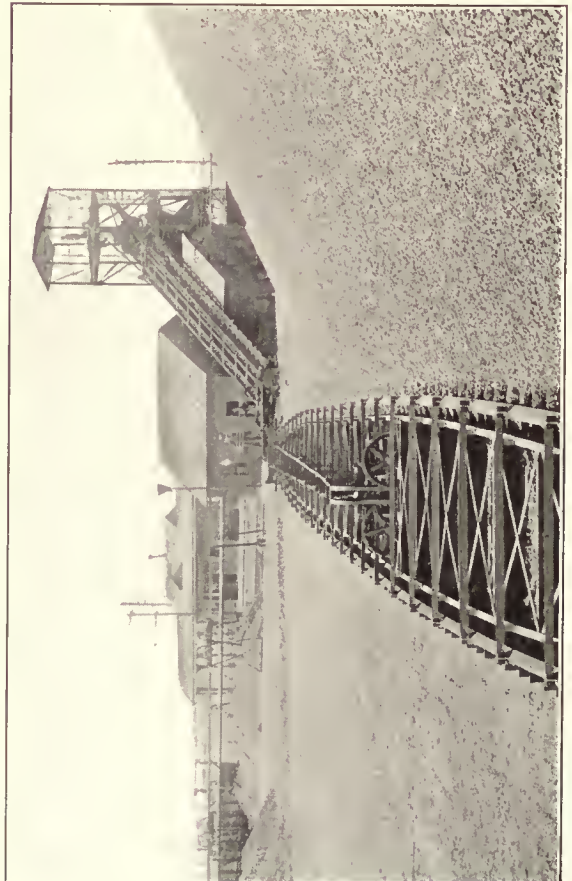

Fig. 2—View of Reclaiming Conveyor

thracite storage plants is what is known as the Dodge system. This system was designed by James M. Dodge, and it has been so successful in handling coal economically and rapidly that it has been adopted as practically a standard system for this kind of coal. The coal is piled in large conical piles containing usually from 30,000 to 60,000 tons each. A general view of a complete plant is shown in Fig. 1. Two piles, with two delivery conveyors and one reclaiming conveyor, form a unit and all of the conveyors are of the chain and flight type. Each delivery conveyor is set at an incline of 27 deg., the angle of rest of the coal pile, and a pair of light trusses connected together just above the peak of the pile is used to support each conveyor, the conveyor using one truss, the other one completing the triangle that makes the trusses self-supporting.

The coal is dumped through the hopper doors of the freight cars into a track hopper and is fed to the delivery conveyor which discharges to the pile. To avoid dropping the coal any distance and causing breakage the pile is started at the lower end of the conveyor and close to the ground; as it increases in height, the discharge point is moved up the conveyor by pulling up a steel ribbon which forms the bottom of the conveyor trough and which is unwound from a drum at the foot.

The reclaiming conveyors, Fig. 2, are reversible flight conveyors with chains and wheels set in a horizontal instead of a vertical plane; each conveyor is pivoted and is supported on circular tracks at the ground level. The pivot point is near the railroad track, and just back of this point the conveyor goes up an incline so that the coal can be delivered over screen chutes back into the railroad cars. The swinging of the conveyor is accomplished by steel cables which extend from the pivot point to the outer end and then to each side of the storage area and are there dead-ended so that the conveyor can be moved in either direction. The outside of the conveyor trough on both sides is left open, so that when the conveyor is started and swung against either pile of coal the flights get behind the coal and push it along the trough and up the incline to the point where it discharges over the screen chutes to the cars.

While in most cases these large anthracite coal storage plants are in the open, in a few instances where the winters are especially severe the piles have been housed over to protect them from weather conditions. A plant of this kind is shown in Fig. 3, this plant being located at Superior, Wis. The anthracite coal is shipped over the lakes by boat and is unloaded at this point for distribution by rail. The circular buildings used for housing the storage piles are built of steel, each being 246 ft. in diameter by 90 ft. high. Each of the two buildings has a storage capacity of 50,000 tons of coal.

The circular storage system using a locomotive crane equipped with a grab bucket and traveling on circular tracks is especially adapted to the storing of bituminous coal and is in some cases used for storing anthracite. An installation of this kind is shown in Fig. 4, this being a storage plant belonging to one of the railroads and located at a locomotive coaling station. The locomotive crane in this case is a wide gage machine traveling on four rails, with a fixed boom of 110-ft. radius, equipped with a 5-yd. grab bucket. The coal is dropped from the cars into a track hopper and is handled by conveyors to a central digging point. A pile on the ground is formed at this point so that the coal can be picked up by the bucket and be distributed by swinging the boom of the crane.

As there is practically no danger of fire with anthracite coal, it can be piled deep; the depth of the pile is 50 ft.

and a large amount of storage can be obtained for the amount of area covered. There are two sets of circular crane tracks, one with a radius of 110 ft. from the centre of the digging pile so that the crane can reach this pile from any point on the circle and the other at a radius 100 ft. greater, so that when the outside pile is to be filled up the crane moves out to the outside track and rehandles the coal into the outside part of the storage. This makes two handlings of the coal for this part of the storage. As long as the daily requirements are not too great it is just as well to have the crane in more constant operation as to have it idle and this rehandling of the coal avoids the necessity of greater expense for additional equipment. The storage handled from the inside circle is the more active storage, that handled from the outside circle being used only when the former is filled or empty according to whether the handling is to or from storage.

The coal is reclaimed by the crane and delivered to a loading hopper on a tower near the centre of the digging pile. From this hopper it is fed to an inclined flight conveyor which takes it across a bridge over a number of railroad tracks to the coaling station, where it is delivered to a distributing flight conveyor which runs at right angles to it and along the length of the pocket.

Storing Bituminous Coal

Since it is not feasible to store bituminous coal in deep conical piles, the Dodge system is never used for storing this kind of coal. The method usually employed includes some type of grab bucket equipment, this being either complete in itself or used with a conveyor, cable railway, or some other combination. Whatever type of equipment is used must be arranged to spread the coal over a large area to avoid piling it too deep, and it must be able to reclaim the coal from this area.

In some cases a bituminous coal storage plant is so arranged that the coal can be submerged in water to prevent deterioration and spontaneous combustion. As far as the deterioration is concerned this makes an expensive type of coal storage plant which is seldom justified, according to investigations by the United States Bureau of Mines and others, which seem to prove conclusively that there is comparatively little loss in heating value in bituminous coal when stored in the open; the longer the coal remains in storage the smaller the rate of loss unless the coal becomes heated. Submerged storage does, of course, prevent spontaneous combustion, but this can usually be prevented by other and less expensive means. Some of the factors which are conducive to spontaneous combustion are the following:

1. Excessive depth of pile. The limiting depth of pile varies with different kinds of coal, but it is usually somewhere between 15 ft. and 30 ft.
2. A large amount of fine coal stored with lumps that tends to form the air pockets which furnish the live oxygen needed to start spontaneous combustion.
3. Piling the coal in such a way that there is a segregation of the lump and fine coal, so that at some point in the pile there is a dividing line where the lump and fine coal are brought together in such a way as to form the air pockets which are responsible for starting spontaneous combustion, and where the circulation of air is not sufficient to carry off the heat.
4. The presence in the coal of sulphur, oily waste, wood or other inflammable materials which are easier to set on fire than the coal itself, and which, therefore, tend to make it easier for combustion to start.

If bituminous coal can be stored as lump coal with the

Crane Radius A	Crane Track Gauge B	Number of Crane Rails	Type of Truck Swivel	Size of Bucket	Cap. Min. of Mine Coal Per Hour	Storage Capacity, 20 ft Pile One Semi-Circular Pile	Storage Capacity, 20 ft Pile Two Circular Piles	Length of Width of Property C	Width of Property D	Pit Centers E	Dimension F	
65' 0"	9' 0"	2	8" Wheel Swivel	2 1/2 yd.	100 tons	86,650 tons	175,000 tons	34,000 ft	525' 0"	300' 0"	225' 0"	25' 0"
80' 0"	20' 0"	4	16" Wheel Swivel	3 yd.	125 tons	12,600	25,200	50,000	640' 0"	360' 0"	280' 0"	25' 0" to 27' 0"
100' 0"	20' 0"	4	16" Wheel Swivel	5 yd.	200 tons	21,500	43,000	75,000	790' 0"	440' 0"	350' 0"	30' 0"
110' 0"	20' 0"	4	16" Wheel Swivel	5 yd.	200 tons	26,000	52,000	100,000	865' 0"	480' 0"	385' 0"	30' 0"

DIMENSIONS AND CAPACITIES FOR 20 FT. PILE.

Crane Radius A	Storage Capacity, 15 ft Pile One Semi-Circular Pile	Storage Capacity, 15 ft Pile Two Circular Piles	Length of Width of Property C	Width of Property D	Crane Radius A	Storage Capacity, 12 ft Pile One Semi-Circular Pile	Storage Capacity, 12 ft Pile Two Circular Piles	Length of Width of Property C	Width of Property D	
65' 0"	6,225 tons	13,050 tons	260,000 ft	515' 0"	290' 0"	5,360 tons	10,600 tons	200,000 ft	509' 0"	284' 0"
80' 0"	9,800	19,600	38,000	630' 0"	350' 0"	7,875	15,750	30,000	624' 0"	344' 0"
100' 0"	16,650	33,300	65,000	780' 0"	430' 0"	13,375	26,750	51,000	774' 0"	424' 0"
110' 0"	20,750	41,500	80,000	855' 0"	470' 0"	16,715	33,430	65,000	849' 0"	464' 0"

DIMENSIONS AND CAPACITIES FOR 15 FT. PILE.

Note: Dimensions not repeated remain constant.

Fig. 6—Capacity Tables of Circular Storage

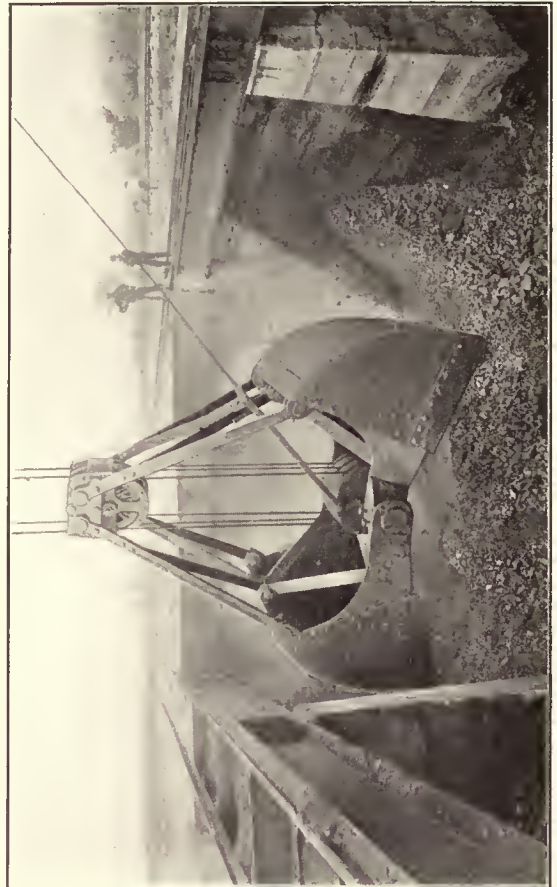

Fig. 8—Grab Bucket Digging from Pit

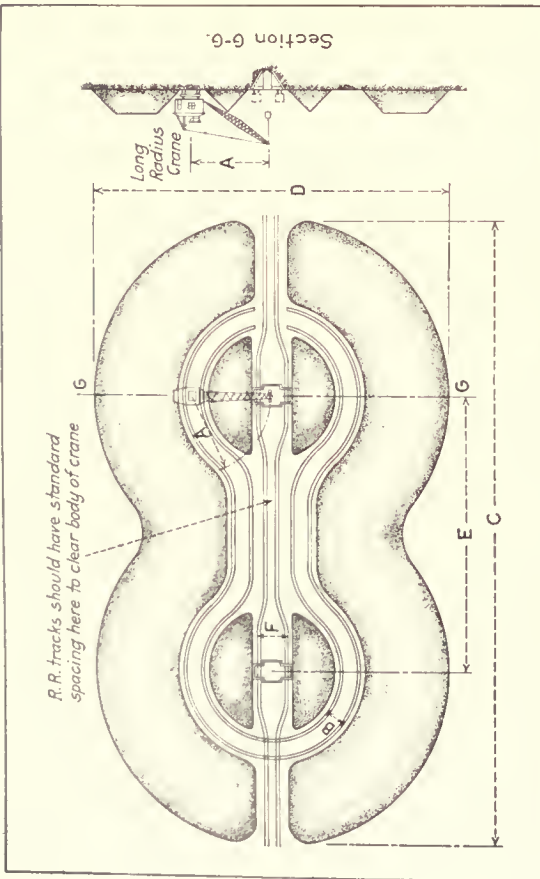

Fig. 5—Diagram of a Circular Storage

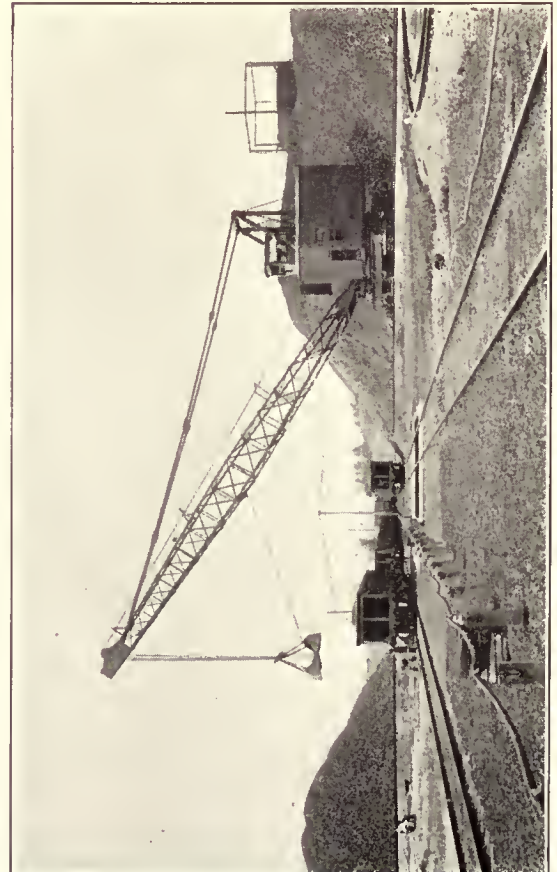

Fig. 7—Locomotive Crane Circular Storage

fine coal screened out it is undoubtedly the safest method, as this gives a good opportunity for the circulation of air and the dissipation of heat, and there is also the absence of fine coal or dust which is most easily set on fire. If it is not feasible to store the coal as lump it is undoubtedly better to crush it and store it as crushed coal since in this condition it packs more closely and with smaller air pockets.

Storing coal in hot weather should be avoided if possible, for the tendency of the coal to oxidize increases with the temperature. Various methods for the ventilation of coal piles have been experimented with, but unless the ventilation is great enough actually to carry off the heat instead of simply adding oxygen to help along the oxidation it is worse than no ventilation at all. The general consensus of opinion in this country seems to be against ventilation, though there have been cases where it seems to have been quite effective. The Canadian Pacific Railway employs ventilation extensively in its large storage piles, and according to reports its methods have been successful.

The United States Bureau of Mines reports as follows in Technical Paper No. 16, in relation to the deterioration and spontaneous combustion of coal:

"The results show in the case of the New River coal a loss of less than one per cent of calorific value in one year by weathering in the open. In two years the greatest loss was at Key West, 1.85 per cent. There was practically no loss at all in the submerged samples in one year, fresh or salt water serving equally well to preserve the virtues of the coal. There was almost no slacking of lumps in the run-of-mine samples. In all tests the crushed coal deteriorated more rapidly than run-of-mine.

"The Pocahontas run-of-mine coal in a 120-ton pile on the Isthmus of Panama lost during one year's outdoor weathering less than 0.4 per cent of its heating value, and showed little slacking of lumps.

"Gas coal during one year's outdoor exposure suffered no loss of calorific value measurable by the calorimetric method used, not even in the coal forming the top 6-in. layer in the bins.

"Submerged storage is an absolute preventive of spontaneous combustion, and on that account alone it is justified when the coal is particularly dangerous to store, and when large quantities are to be stored; but unless the storage period is to be longer than one year, there seems to be no ground for storing coal under water merely for the sake of the saving in calorific value.

"Losses of value from spontaneous combustion are a much more serious matter than the deterioration of coal at ordinary temperatures. Oxidation proceeds more rapidly as the temperature rises. The oxidation, beginning at ordinary temperatures, attacking the surface particles and developing heat, is probably in some degree an absorption of oxygen by the unsaturated chemical compounds in the coal. In a small pile of coal this slowly developed heat can be readily dissipated by convection and radiation, and very little rise in temperature results. If the dissipation of heat is restricted, however, as in a large pile densely packed, the temperature within the pile rises continuously. The rate of oxidation of the coal, plotted against the temperature, makes a curve which rises with great rapidity. When the storage conditions are such as to allow warming of the coal to a temperature of about 100 deg. C., the rate of oxidation becomes so great that the heat developed in a given time ordinarily exceeds the heat dissipated and the temperature rises until, if the air supply is adequate, the coal takes fire. Evidently, therefore, it is important to guard against even moderate heating, either spontaneous, or from an external source. Increased loss of volatile

matter and of heating value occurs with a moderate rise of temperature, even though the ignition point is not reached.

"Spontaneous combustion is brought about by slow oxidation in an air supply sufficient to support it, but insufficient to carry away all the heat formed. The area of surface exposed to oxidation by a given mass of any one coal determines largely the degree of oxidation which takes place in the mass; it depends on the size of the particles and increases rapidly as the fineness approaches that of dust. Dust is, therefore, dangerous, particularly if it is mixed with lump coal of such a size that the interstices permit the flow of a moderate amount of air to the interior. Coal differs widely in friability; that is, in the proportion of dust which is produced under like conditions. In comparative tests samples of Pocahontas, New River and Cambria County (Pennsylvania) coals produced nearly twice as much dust (coal through a $\frac{1}{8}$ -in. screen) as coal mined from the Pittsburgh bed in Allegheny County, Pennsylvania. This variation in friability is a factor in affecting the liability to spontaneous heating.

"Ideal conditions for such heating are offered by a mixture of lump and fine coal, such as run-of-mine with a large percentage of dust, piled so that a small supply of air is admitted to the interior.

"High volatile matter does not of itself increase the liability of coal to spontaneous heating. A letter of inquiry sent by the bureau to more than 2,000 large coal consumers in the United States brought 1,200 replies. Of the replies 260 reported instances of spontaneous combustion, and 220 of the 260 gave the name of the coal. The 220 instances were distributed as follows: 95 were in semi-bituminous low-volatile coals of the Appalachian region, 70 in higher-volatile coals of the same region, and 55 in western and middle-western coals.

"Freshly-mined coal, and the fresh surfaces exposed by crushing lumps exhibit a remarkable avidity for oxygen, but after a time the surfaces become coated with oxidized material, 'seasoned,' as it were, so that the action of the air becomes much less vigorous. In practice, coal which has been stored for six weeks or two months and has even become somewhat heated, if rehandled and thoroughly cooled by the air, seldom heats spontaneously again."

The extinguishing of fires in bituminous coal piles by water is very difficult, unless the part where the fire occurs is thoroughly soaked. This method seems to help the fire along rather than put it out. One method of using water is to make an excavation in the coal pile directly over the fire, then keep a constant stream of water running into this excavation as long as necessary to extinguish the fire. The water is retained in the bowl-shaped depression and necessarily soaks down through the pile to a considerable extent and if it can be made to thoroughly drench the fire will put it out.

The usual method nowadays is to arrange the mechanical equipment for storing the coal in such a way that any part of the pile can be easily reached and the coal rapidly dug out by mechanical means; the burning coal can thus be spread out and the fire extinguished. This is the safest and surest method and usually involves the least amount of labor and expense.

In some cases storage plants for bituminous coal and for anthracite coal also are of a more or less temporary character; where the plant is not considered a permanent one it is, of course, desirable that the equipment should not be too expensive, even though the labor cost per ton for handling the coal to and from the storage may run higher than it would with more efficient, but also more expensive types of equipment.

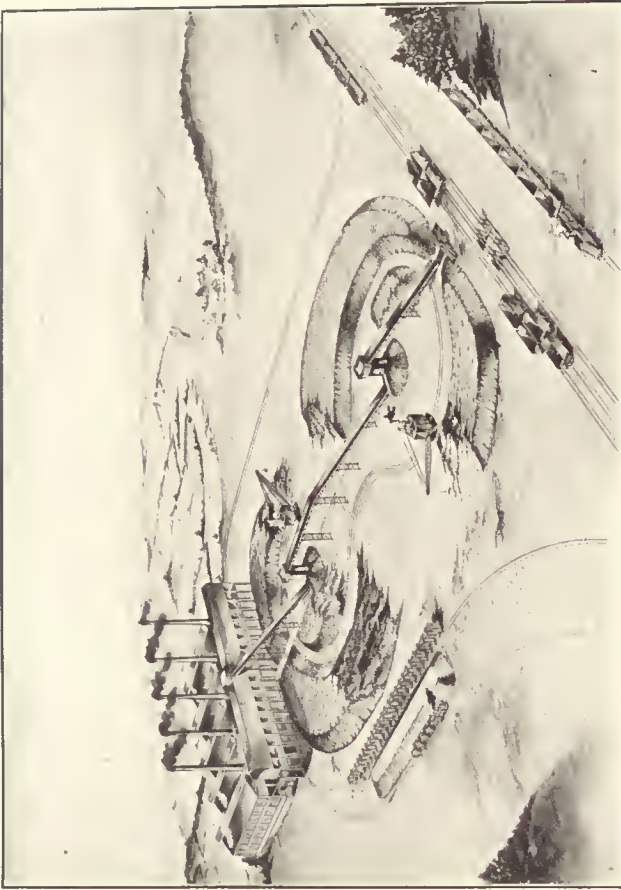

Fig. 11—An Interesting Storage Layout

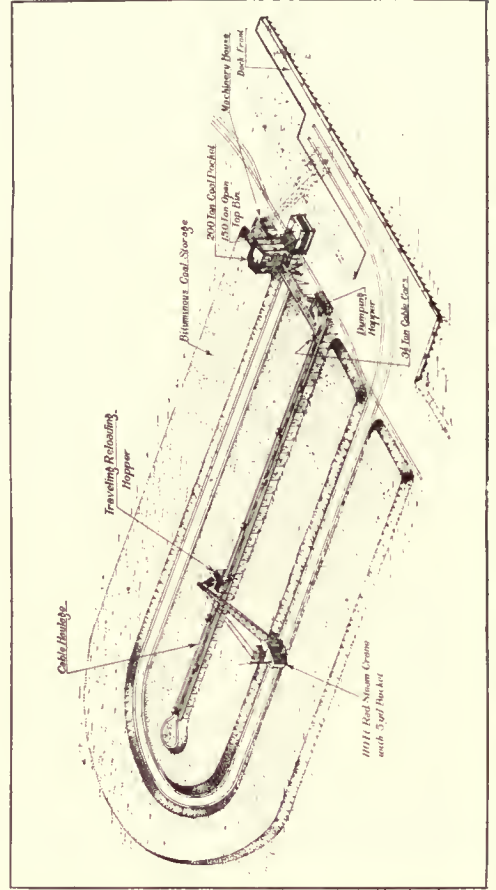

Fig. 12—Storage by Locomotive Crane and Cable Railway

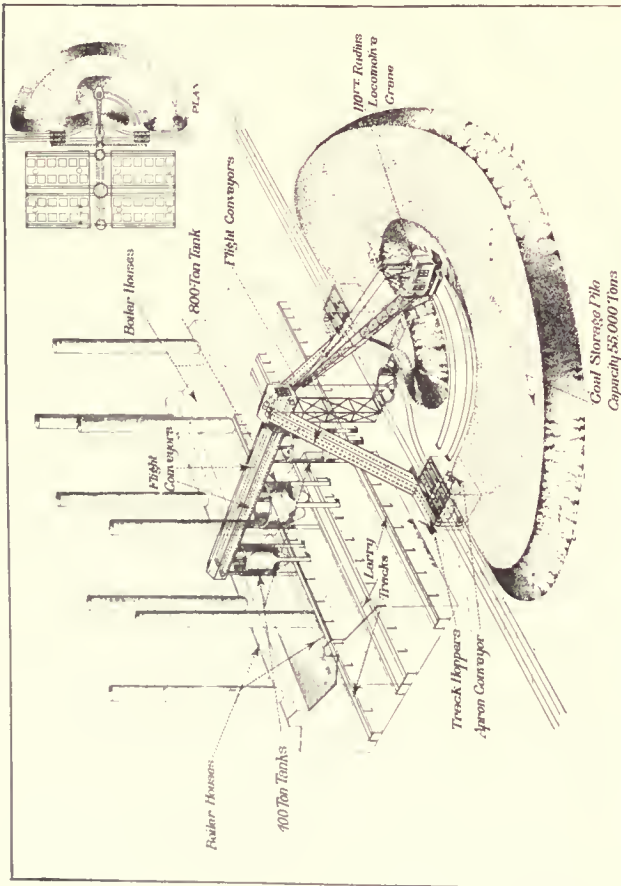

Fig. 9—Semi-circular Storage at a Boiler House

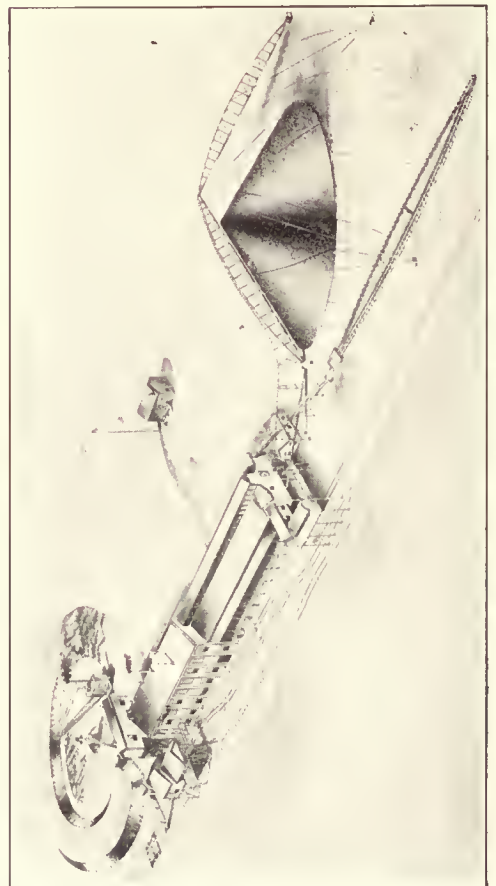

Fig. 10—Circular and Dodge Storage

Sometimes the side-hill storage system is used where advantage is taken of a track location on the side of a hill, the coal being dumped on the lower side of the track and allowed to form a storage pile along the slope of the hill. By installing another track on the lower side of the pile the reclaiming of the coal can be made easier since the coal can be delivered down hill by means of chutes or conveyors and into the cars on the lower track.

Sometimes portable elevators, portable belt conveyors, or a combination of the two, are used for unloading the coal from the cars and piling alongside the track; then by reversing the operation of these machines the coal may be reclaimed and delivered back to the cars. Since, however, the capacity of these machines is limited usually to from 40 to 60 tons an hour, this is not a very rapid method for large plants, a number of machines being necessary to obtain much capacity.

Coal can also be piled by starting a pile on the ground and then running trucks or bottom dump wagons up on the pile and extending it by dumping the coal along the edge, and continuing this operation until a large area is covered. Such piles can be reclaimed by portable loaders or locomotive cranes equipped with grab buckets.

Locomotive cranes can be used in various ways for piling coal, either unloading direct from the cars, picking up with the grab bucket from the pits into which the coal was discharged from the cars, or spreading out the coal deposited under a trestle. The same locomotive crane can be used to pick the coal up from the storage area and deliver it back to the cars or to a conveyor system.

In some cases an embankment of coal is formed alongside a railroad track; then another track is laid on top of the coal pile and the railroad cars are run up on this track. The coal is discharged from the cars on the upper track level and the pile or embankment of coal is extended sideways. The track is then shifted over towards the edge of the pile and the operation repeated. Various combinations of these methods can be used, but where a large permanent plant is to be equipped there are various systems which have been developed through long experience and do the work more rapidly and economically, and if the cost of the equipment is spread over several years' use lower costs per ton for handling the coal can be obtained.

Storage Systems for Bituminous Coal

The principal storage systems used for bituminous coal are as follows:

1. Circular storage system, using a long radius locomotive crane of wide gage equipped with a large grab bucket, the crane operating on circular tracks and picking up the coal from and delivering back to a central point. Sometimes the coal is picked up from a pit into which it is discharged from the railroad cars at the centre of the circular track or in other cases it is deposited on the ground at this point by means of an elevator or conveyor. When the pit is used the coal is usually delivered back to railroad cars when reclaiming. When an elevator or conveyor is used for forming the initial pile, the coal is usually delivered back to the conveyor system.

2. Long radius locomotive cranes used with a conveyor, cable railway, or railroad trestle, the coal being deposited on the ground and then spread over the storage area by a grab bucket operated by the crane; when the coal is reclaimed it is picked up by the grab bucket and delivered to the conveyor, the cable cars or the railroad cars.

3. Rotating or traveling bridge tramways which pick up the coal with a grab bucket from boats, from a pit, or from an initial pile and spread it over the storage area; when

reclaiming, the coal is picked up from the storage area and delivered back to the cars, boats or to a conveyor system.

4. The Stuart system using a belt conveyor with a belt conveyor stacker for piling the coal along one or both sides of the belt conveyor, and a Stuart reclaimer for reclaiming the coal from the ground storage pile and delivering it back to the belt conveyor.

5. Overhead cableway equipped with grab bucket.

These are the principal systems used, though they may be combined and modified in various ways to suit special conditions.

A diagram for the circular storage system is shown in Fig. 5 and a table of capacities in Fig. 6. Two circular piles are shown, each with a pit at the centre from which the coal is picked up by the grab bucket and spread over the storage area. In reclaiming it is delivered back to railroad cars. Some of the advantages of this system are as follows:

1. Low investment. The equipment and construction work includes only the crane with the grab bucket, the track system and the pit. The tracks may be laid on ties directly on the ground, so that the only excavating and concrete work required is for the pit.

2. Low operating and maintenance cost. Only one or two men are required to operate the locomotive crane and the power cost is low compared to the amount of coal handled. The maintenance costs also are low considering the amount of work done.

3. Dependability. The best locomotive cranes designed especially for this work are ruggedly constructed and thoroughly reliable. These plants are little affected by weather conditions, and therefore are not likely to be out of service when most needed.

4. Flexibility. The number of circular storage piles may be extended indefinitely and either one or more locomotive cranes used, depending upon the handling capacity required.

5. Low insurance charges. There is little fire risk with the locomotive crane, since it is entirely of iron and steel construction. There is practically no danger of damage from the wind because of the wide base and low centre of gravity of the crane.

6. Minimum danger of loss of coal from spontaneous combustion. With the whole storage area within reach of the locomotive crane at all times, if spontaneous combustion does occur a fire can be quickly dug out and extinguished.

A view of a circular storage plant is shown in Fig. 7. The locomotive cranes usually run on four rails, the rails being so placed as to form two tracks, usually of standard gage, the distance, centre to centre of tracks, being about 20 ft. The body of the crane is supported on four trucks, one under each corner, two of these trucks being idle and the wheels of the other two being connected by means of the necessary gearing to the main engine, so that the crane can be moved along the tracks. Separate swing engines are used on the latest cranes for rotating them.

A 5-yd. grab bucket digging coal out of a pit into which it is discharged from railroad cars is illustrated in Fig. 8. The railroad tracks are usually placed at a standard distance, centre to centre, throughout the plant, except at the pit where they are spread out to give room for the grab bucket to dig the coal between them.

A semi-circular reserve coal storage plant of about 55,000 tons capacity located directly adjacent to a boiler room is shown in Fig. 9.

The coal cars come in on two railroad tracks and there are two sets of track hoppers quite widely sep-

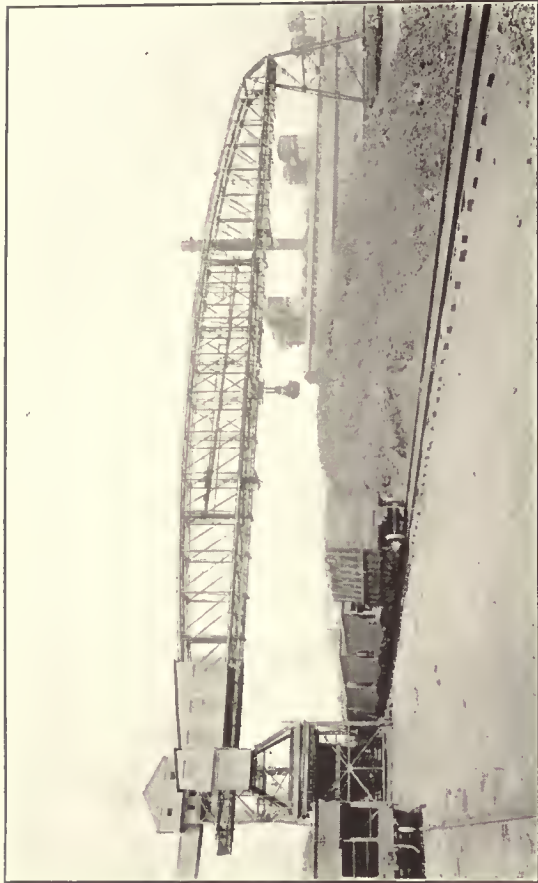

Fig. 15—Rotary Bridge Storage

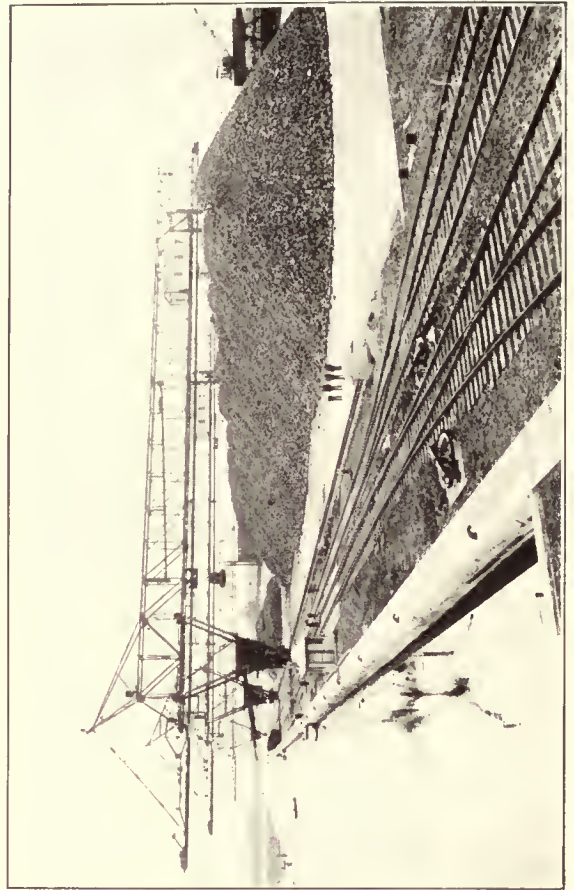

Fig. 16—Traveling Bridge Storage



Fig. 13—A River Front Storage Plant

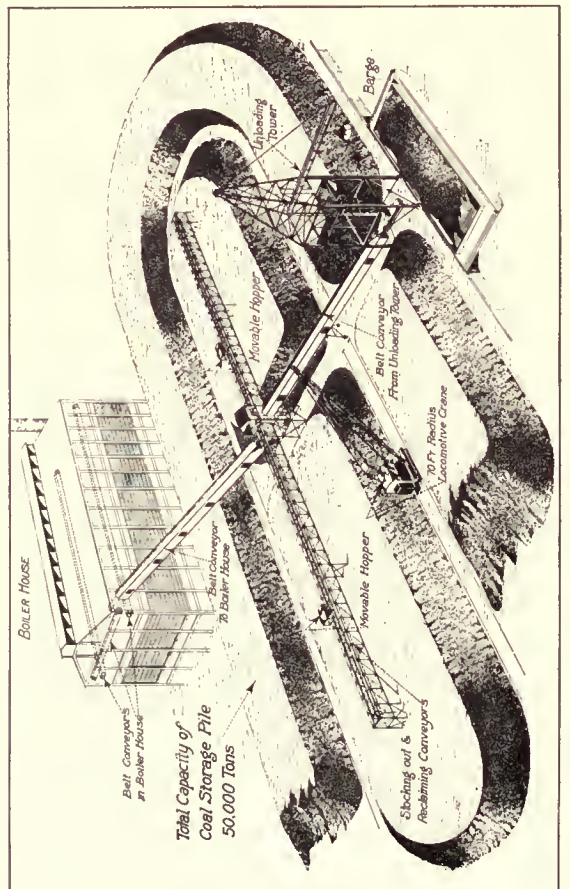

Fig. 14—Barge Unloading and Storage

arated so as to give considerable room for shifting cars between them. This arrangement allows four cars to be handled at one time, thus making it easy to unload the coal at the desired rate. Underneath each set of track hoppers are two double reciprocating feeders; that is, one under each track, each double feeder delivering to an apron conveyor which runs over to one side and delivers the coal to a crusher.

After passing through the crusher the coal goes to flight conveyors of the double strand roller chain type, delivering at the upper end to two flight conveyors running at right angles to the tracks and discharging into the overhead coal bins. The overhead bins are located between the two sections of the boiler house and underneath the bins are larry tracks running to both sides so that the coal may be drawn out of the bins into the larries, run into the boiler room and delivered to the stoker magazines.

By placing the bins between the two sections of the boiler room they are made to do double duty by serving both sides, and the length of distributing conveyors over them is reduced to a minimum.

The coal destined for storage is unloaded into a third track hopper which feeds a digging pit from which it is taken by a grab bucket and distributed by a locomotive crane. When reclaiming is done the coal is picked up from the pile by the locomotive crane and delivered to one of the first mentioned track hoppers.

In another arrangement there are also double tracks and two pairs of double-track hoppers under each track so that four cars can be unloaded at one time; the track hoppers are, however, all close together. The coal is fed by reciprocating feeders to crushers and then goes to one of two inclined flight conveyors running at right angles to the track and delivering at the end either to two inclined belt conveyors to the overhead bin or to conical piles on the ground from which the coal is picked up by a grab bucket operated by a locomotive crane and spread over the storage area.

It will be noted that by delivering the coal to piles above ground, from which it can be distributed by the crane, the digging pit may be eliminated. When the coal is to be reclaimed it is handled by the crane back to a feeding hopper over the foot of the inclined belt conveyors and the inclined machines take it up and deliver it to the distributing belt conveyors which distribute it in the overhead bin.

A 50,000-ton bituminous circular coal storage at one end of a large briquet making plant and a 60,000-ton Dodge storage plant for the finished briquets at the other end of the plant are shown in Fig. 10. Since it is only the small sized coal that is used for making briquets the large coal is first screened out and reloaded to railroad cars; screening and loading is accomplished by a tippie equipment with shaking screens and loading booms. At the receiving end of the plant the cars are brought in on two railroad tracks which pass over a double-track hopper and are then spread out and run under the tippie building.

The coal is discharged from the cars into the hoppers which deliver to an apron conveyor running up between the tracks to the head of the tippie building and delivering to either one of two shaking screens. The lump coal, after passing over the shaking screens, goes to one of the loading booms and is loaded into railroad cars. The coal which passes through the shaking screens goes to a belt conveyor which delivers either to a gravity discharge elevator-conveyor equipment, for distributing in overhead

storage bins or to a 36-inch belt conveyor running at a slight incline to the center of the coal storage space.

At the center of this coal storage is a concrete silo. The coal is discharged from the end of the belt conveyor to a pile outside the silo from which a locomotive crane digs it with a grab bucket and spreads it over the storage area. When the coal is reclaimed it is picked up by the grab bucket and is deposited on the pile alongside the silo; from there it flows through an opening in the silo into the foot of a double strand gravity discharge elevator with 30-inch x 15-inch buckets attached to a double strand of 12-inch pitch steel strap roller chain. This elevator delivers the coal back to the belt conveyor which in turn delivers it to the elevator-conveyor serving the overhead storage bin.

At the other end of the plant is a cross flight conveyor which delivers the briquets either to the loading booms for loading into railroad cars, or to the carrying run of a Dodge trimmer conveyor which takes them out and up the inclined trimmer truss and delivers them in the usual manner to the Dodge storage pile. This pile contains, when full, 60,000 tons of briquets. All the above conveyors are designed for capacity of 200 tons an hour except the apron conveyor which handles the run-of-mine coal from the track hoppers up into the tippie building and which is designed for a capacity of 300 tons an hour.

This plant is designed for future extensions in the direction away from the railroad tracks, the storage building at the receiving end and the flight conveyor equipment at the delivery end being designed for extension sufficient for the addition of three briquet making buildings.

One of the most interesting bituminous coal storage plants is that at the Old Hickory powder plant built by the government near Nashville, Tenn. This plant is shown in Fig. 11.

After considering various arrangements for storing and reclaiming the coal it was decided to adopt the circular storage system with two locomotive cranes of 110-ft. radius, and use two points of delivery from the conveyor system so that the cranes could pick the coal up from each point and spread it over two circular storage areas, and then arrange the conveyors so that the coal could be handled back by the cranes and again be delivered to the conveyors at these central points. These two circular storage plants fitted nicely in the space between the railroad sidings and the overhead coal bin at the boiler room, and by piling the coal 16 ft. deep the required 100,000 tons storage was obtained without covering the crane tracks.

Taking the conveyors from the railroad tracks to the boiler room storage bin as the center line of the plant, it should be noted that there is a set of track hoppers on each side of the center line, one set under the center track and the inside track, and the other under the center track and the outside track. These hoppers are large enough for four railroad cars to be placed over each set at one time, making a total of eight cars which can be placed at the same time. The coal is fed from the track hoppers to the crushers by apron feeders. Underneath each crusher is an inclined belt conveyor running up to a feeding point for feeding to either of the duplicate belt conveyor lines running to the distributing point of the first circular storage unit.

At this distributing point is a circular concrete tower, or silo, which serves as a support for the heads of the first pair of belt conveyors and protects the lower ends of the second set of belt conveyors and the chutes and feeders for delivering the coal out into the storage pile

for distribution by the locomotive crane, and for feeding it back from the storage to the second set of belt conveyors. If the coal is going directly through to the boiler room bin, it is delivered from the first to the second set of belt conveyors by chutes. There are other chutes for delivering outside the silo on either side to the piles in the outside storage. From the first silo the second pair of belt conveyors conveys the coal up an incline to the second silo at the center of the second circular storage unit and here the coal is either delivered to the third pair of belt conveyors, or to the second outside storage pile. The third pair of belt conveyors are inclined so that they lead up to the top of the overhead bin at the center, and here the coal is delivered by a system of chutes to two pairs of distributing belt conveyors running to each end of the overhead bin and distributing the coal along the full length of the bin.

A coal storage plant of a large manufacturing company is shown in Fig. 12. A locomotive crane unloads the coal from the boats and discharges it into a receiving hopper which feeds pivoted bucket carriers that deliver to an overhead transfer bin. From this bin the coal is either fed to the cable car system for distribution to storage or it is delivered by gravity direct to railroad cars. There is also a coal crushing equipment so that the coal may be stored either as run-of-mine or as crushed coal; it is interesting to note that while there have been fires in the run-of-mine coal there have been no fires in the coal which was stored crushed. The coal is spread out and reclaimed in the same manner as at the plant next described.

The storage plant of the New York Edison Company at Shadyside, N. J., is shown in Fig. 13. It has a storage capacity of 225,000 tons of bituminous coal. The coal is unloaded from boats by a hoisting tower equipped with a grab bucket and is delivered to the cars of a cable railway. The cable railway has a long straight run on a trestle through the center of the storage area and the cars dump the coal under this trestle. There are two 100-ft. radius locomotive cranes equipped with 5-yd. buckets and these cranes pick the coal up from underneath the trestle and distribute it over the storage area as shown in the photograph. Each crane has a rated capacity of 200 tons per hour and in a test made by U. S. Government officials each of the cranes averaged 240 tons an hour for a ten-hour run. When the coal is reclaimed, it is picked up by the crane buckets and is delivered to a feeding hopper which can be moved along the line of cable cars which take the coal back to the wharf for shipment to the power plants in New York City.

A 50,000-ton storage plant for bituminous coal, located between a water front and a power house, is shown in Fig. 14. The coal is unloaded from the boats by a grab bucket operated from a hoisting tower. In the latter is a crusher and as the coal is crushed it goes to an inclined belt conveyor which is supported a little above the ground level. This belt conveyor is at the center of the storage pile and carries the coal either to a second inclined belt going up to the top of the overhead bin in the boiler room or to one of the two distributing flight conveyors running lengthwise of the storage pile. The coal can thus be sent either direct to the power plant or to the storage pile by the flight conveyors.

For spreading the coal further in the storage pile there is a 70-ft. radius locomotive crane equipped with a 2-yd. bucket. The crane runs on 9-ft. gage tracks but otherwise is very similar to a standard gage crane and is not much

more expensive, so that it is a much cheaper machine than the long radius cranes used in the plants previously described. The coal is spread over the storage area so as to obtain the 50,000 tons with the pile 15 ft. deep. When the coal is to be reloaded for the power plant it is reclaimed by the crane and delivered back to the flight conveyors, which deliver to the inclined belt to the power plant.

It will be noticed that the boat unloading tower does not need to be very high as it lifts the coal only far enough to deliver it to the crusher from which it feeds to the inclined belt conveyor just above the ground level. A low tower of this kind, can, of course, be built much lighter and at much less expense than a high tower and the handling capacity and safety is greater on account of the lower lift of the bucket. The plant can be operated by a minimum number of men, and in many cases the tower and locomotive crane may be operated by the same man, since it would not be necessary to operate both at the same time.

A photographic view of a rotating bridge tramway, with a grab bucket traveling back and forth on the bridge, this bucket being handled by cables winding on drums in the machinery house, is shown in Fig. 15. The coal is discharged from the railroad cars to a hopper at the center of rotation of the bridge, from which it is picked up by the grab bucket and is spread over the circular storage area served by the bridge. The span of the bridge is 280 ft., and 50,000 tons of coal may be stored, piled 30 ft. high with an opening left for the railroad tracks through the center of the pile. When reclaiming, the bucket picks the coal up from the storage area and delivers it to the railroad cars.

Bridge tramways which move longitudinally instead of rotating are used extensively for storing coal, as well as ore and other materials. In the plant illustrated, Fig. 16, the bridges are each equipped with 5½-ton buckets, operated by wire rope and controlled by an operator at a fixed point. The coal is unloaded from lake steamers and is stored for distribution by rail. Since the steamers are designed for rapid unloading, with almost the whole deck removable, a remarkably high rate of handling can be obtained in unloading the coal from the boats with the bridge equipment. In the Stuart system of coal storage described herewith the coal is unloaded from the railroad cars and delivered to a belt conveyor located in a trench running longitudinally through the center of the storage area. This belt conveyor is equipped with a high tripper, which delivers to a short belt conveyor running at right angles and arranged so that it can be used on either side of the main belt, this combination being known as a stacker, and serving to stack the coal up on either side of the main belt conveyor. The stacker is shown in Fig. 18.

For reclaiming the coal from the storage area a special type of reclaimer shown in Fig. 17 is used. It consists of a belt or apron conveyor, traveling on the same tracks on which the stacker travels, and arranged so that it can pivot around the truck which travels on the track. On the outer end of the machine is a plow which is pushed into the coal pile by a tractor which supports this end of the reclaimer. This plow is forced in under the coal, which slides up and over onto the conveyor, which takes it up an incline and delivers it to the main belt conveyor, from which it can be transferred to any point desired, the transfer in the case illustrated being to a locomotive coaling station located in the center of a railroad yard. The storage space in this case is 80 ft. by 440 ft. on each

side of the main belt, the coal storage capacity possibly being 30,000 tons. The capacity of the stacking machine is from 250 to 300 tons an hour, and the reclaimer is

initial pile along each side of the main belt conveyor, and then use a locomotive crane for spreading and reclaiming the coal. The locomotive crane fills in the area between its



Fig. 17—A Pivoted Bridge Carries the Reclaiming Conveyor



Fig. 18—The Stacker May Be Used for Storing or Coaling Locomotives

capable of handling the coal back to the belt conveyor at about the same rate.

Some coal storage plants somewhat similar to the Stuart system use a belt conveyor stacker only for making an

tracks and the belt conveyor, and also covers a large space outside the tracks. In this way a very large area can be covered. When reclaiming the crane can handle the coal back to the belt conveyor or direct to railroad cars.

Coal and Ash Handling Equipment for Boiler Houses

Fuel is the largest item of expense in the cost of generating power in a steam power plant and the cost of handling this fuel, and the resulting ashes are also important items especially in a large plant. The hand firing of coal to the boiler furnaces is being rapidly replaced by the use of mechanical stokers, and hand methods of handling and storing coal and ashes are also rapidly disappearing.

In arranging for a coal supply for a boiler room, it is customary to store at least a part of the coal in an overhead bin, either directly in front of the boilers, so that it can be delivered by gravity to the stoker magazines or at some convenient point, frequently the end of the firing aisle or aisles, so that it can be transferred to the stoker magazines by means of a traveling weighing hopper or larry, or sometimes of a conveyor. In addition to this active overhead storage, it is usual to provide reserve storage, which will insure a supply of coal under all ordinary conditions and make it possible to take care of a quantity of coal,

when it can be obtained most advantageously, thereby avoiding the necessity of purchasing it under adverse conditions of supply or delivery. Since the overhead bin type of storage is expensive to build, it is usually made large enough for only three or four days' supply and in some cases even for a shorter period. The reserve storage, usually an outside ground storage pile, is frequently made large enough to furnish a supply for several months or sometimes even for a year or so.

In order to obtain the best efficiency and most satisfactory operation of mechanical stokers it is necessary to get rid of all large lumps of coal, and this is ordinarily done by means of a crusher. The crushers are usually placed at the point where the coal is unloaded, and to make them operate satisfactorily the coal should be fed to them regularly, this being done usually by means of a reciprocating feeder or an apron feeder.

Since the active storage is used almost constantly, it justifies considerable investment in order to keep the cost



Fig. 1—Both High and Low Tower Are Used for Unloading Boats



Fig. 2—A Low Tower Installation



Fig. 3—An Interesting Water Front Power Station Layout

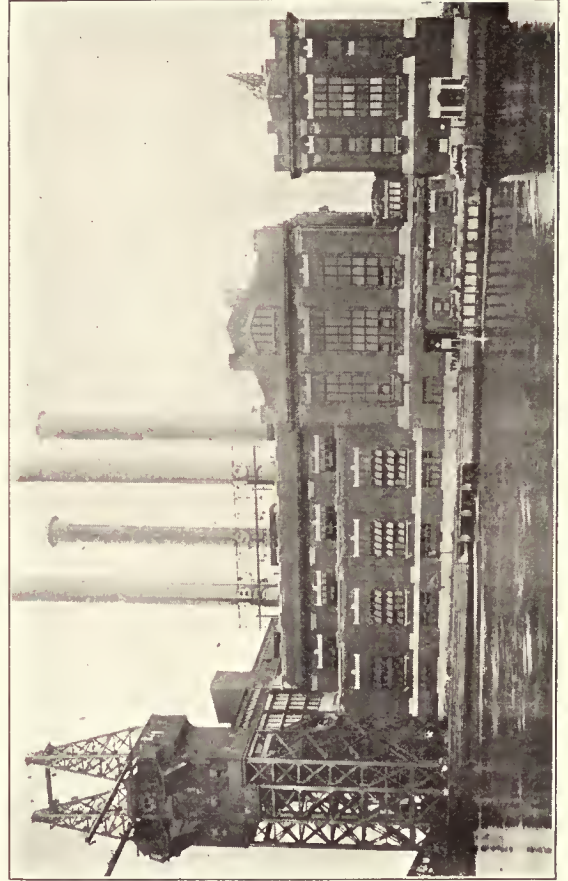

Fig. 4—A Power Station Equipped with a Double High Tower

of handling the coal down to a minimum. The amount of expense justified for the reserve storage handling equipment depends upon the amount of coal to be handled by it during the year.

In some cases the reserve storage is designed almost entirely as an insurance against coal shortage, and is active only in cases of necessity so that a comparatively small amount of coal is handled each year and there is, therefore, not a great deal of saving possible in the yearly cost of handling. In other cases the reserve storage is designed as a regular supply for the winter season—from three to six months—so that it will be filled and emptied once a year, and may be called upon more or less all through the year if coal is not received regularly. In such cases the yearly amount handled is frequently large so that a saving of a few cents in the cost of handling each ton may mean a large yearly saving and justifies a comparatively expensive handling equipment in order to accomplish this saving.

Equipment for Large Central Power Stations

Most large central power stations are built on the banks of a river, or on some other waterway, partly because an ample supply of condensing water is essential to economical operation, and partly because of the possibility of receiving coal by water. The greater part of the coal in such cases is received in boats, so that the main coal handling equipment is for unloading the coal from boats, though provision is usually made for also receiving it by rail and equipment for handling from cars is provided.

The usual method of unloading coal from boats is by means of a grab bucket, handled usually by a high speed hoisting tower, though in some cases a locomotive crane or some type of a bridge tramway is used.

Most of the recent hoisting towers are electrically operated, and they are one-man towers; that is, the machinery is entirely under control of a single operator. The grab bucket usually delivers the coal to a feeding hopper, equipped with an automatic feeder of the reciprocating or apron type, which feeds the coal to a coal crusher. With the high tower type, the coal is elevated by the grab bucket to a sufficient height so that after passing through the crusher it can go directly into the horizontal distributing system, which distributes the coal in the overhead bins. When the low tower type is used, the crusher is set at a lower level, and the coal after passing through the crusher goes to an elevator or inclined conveyor of the belt or flight type, and it is then conveyed to the distributing system over the bin.

The machines ordinarily used for distributing the coal in the bins are belt conveyors, flight conveyors, and cable railways. Cable railways are low in cost of installation and maintenance and extremely flexible in application, being capable of traveling around in loops over several bins, regardless of where they are located. They are not so automatic in their operation as the conveyors and require more men to operate. The automatic railway is also used in some places. This is similar to a cable railway, but is operated by gravity and the cars are self-dumping. Where the low type unloading tower is used conveyors are nearly always employed, since they can be used for taking the coal up to the bin, as well as distributing it in the bin and are practically automatic.

A coal handling equipment for a large central power station is necessarily of large capacity, and even then it is usually necessary to operate it only for a few hours

each day in order to keep the station supplied with coal. A separate ash handling equipment is, therefore, practically always installed in a large station, and some form of car which can be run under the ash hoppers is the most common type of equipment for this work. In some cases these cars are pushed by hand, but they are usually electrically operated. Sometimes the railroad cars are run into the basement of the boiler room, and the ashes are delivered from the ash hoppers direct to them. For elevating the ashes to an overhead bin, the skip hoist is the usual method employed.

A central power station provided with both a low and a high tower receiving coal from boats is shown in Fig. 1. The grab bucket picks up the coal from the boat, elevates it and delivers it to the receiving hopper. From the receiving hopper, it is fed by means of a reciprocating feeder to a screening chute leading to the coal crusher. The fine coal passes through the screen openings and is directed by another chute into the gathering hopper underneath the crusher, and the large coal is delivered to the crusher to be reduced to the proper size. After passing through the crusher the coal is delivered through a chute to the foot of a continuous bucket elevator, which elevates it and delivers it to a belt conveyor running across a bridge to the power plant, and delivering it to the distributing system which distributes the coal in the bins.

Sometimes it is convenient to receive the coal both by rail and by water. In a layout of this character the coal which is unloaded from boats is frequently transferred to the plant by a cable railway, the coal being delivered to the cable cars from the unloading towers and discharged from the cable cars to the foot of an elevator.

Coal received by rail may be delivered to the same elevator through a track hopper. From the elevator the coal is usually delivered to flight conveyors which distribute the coal to the overhead bins.

In another large plant located on the water front the coal is unloaded from boats by means of a low type tower as shown in Fig. 2. The coal is passed through a crusher and is delivered to a 30-in. inclined belt conveyor 450 ft. long, which elevates it and distributes it to overhead bins. The crusher is capable of handling coal at the rate of over 200 tons an hour. The coal is weighed while in transit by means of a belt conveyor weigher.

A power plant somewhat similar to the one just described is shown in Fig. 3. A low type tower is employed for handling a grab bucket which is of 1½-ton capacity. This tower is equipped with a coal crusher and an automatic scales for weighing the coal before it is delivered to the belt conveyor. One belt conveyor takes the coal up the incline and delivers it to a second horizontal belt conveyor which distributes the coal in the overhead bins.

Provision is also made at the coal tower for receiving coal from railroad cars and elevating and delivering it to the crusher. This equipment consists of a gravity discharge elevator, with an apron feeder at the foot for feeding the coal to it from the track hopper. An overhead bin is provided in the boiler room from which the coal is delivered to the stoker magazine by means of a 10-ton electrically operated weighing larry. The ashes at this plant are handled by means of a 10-in. pneumatic conveyor system, the duct of which extends along the line of the ash pits and then runs up to the top of a 75-ton circular storage tank outside of the building.

A power station with a double high tower for unloading coal from boats, and where there is an equipment also for unloading from railroad cars is shown in Fig. 4. The



Fig. 2—A Convenient Layout for a Small Plant

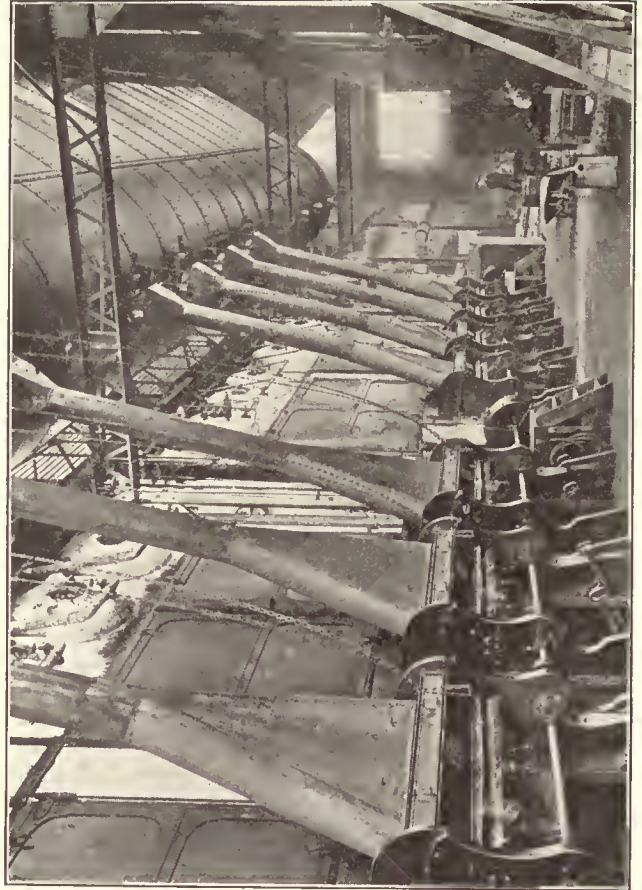

Fig. 4—Overhead Bin and Stokers

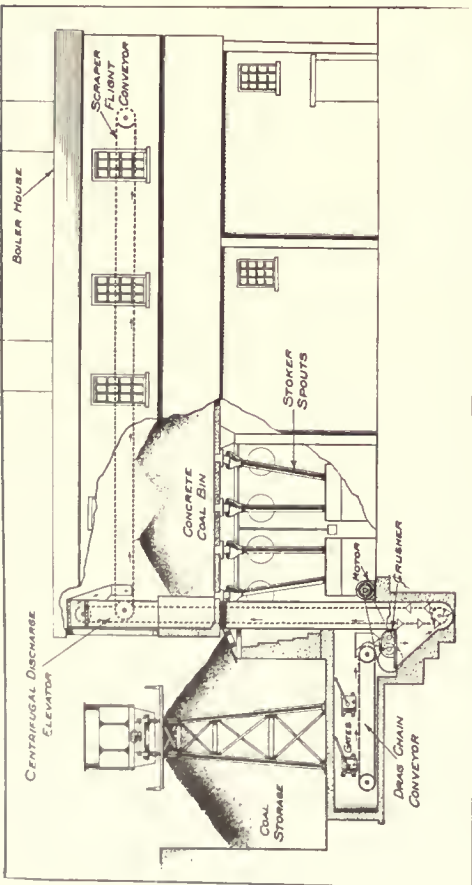

Fig. 1—This Layout Permits of Ground Storage Under the Trestle

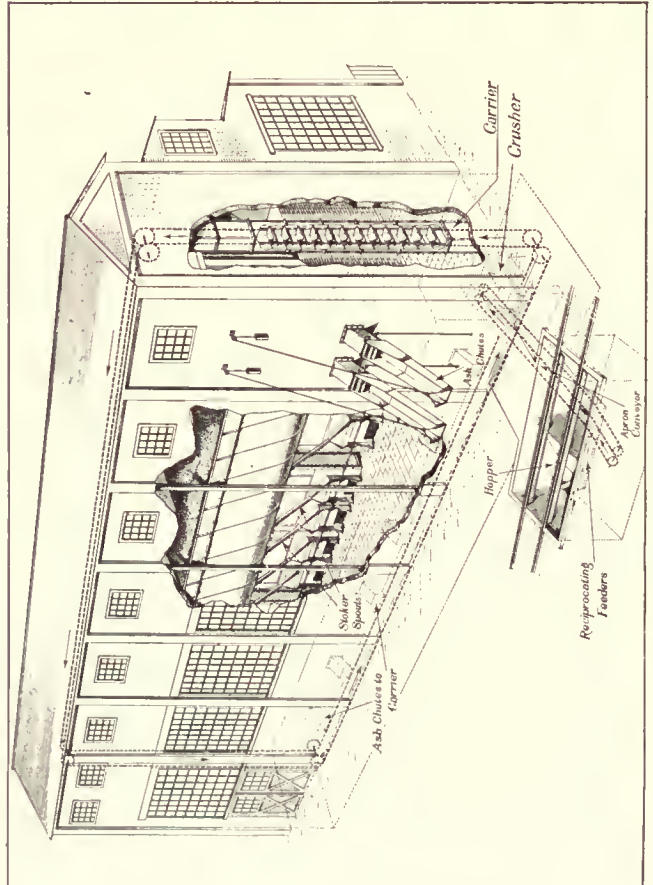

Fig. 3—A Carrier Equipped Boiler House

grab buckets are elevated by the towers to a height of about 160 ft., where they deliver to a receiving hopper from which the coal is fed to the crushers, and then goes to a belt conveyor, which distributes it in the overhead bin. The bin in this case runs alongside the building at right angles to the firing aisles, and traveling weighing larries are used to transfer the coal from the bin to the stocker magazines.

Small and Moderate Sized Boiler House Equipment

A boiler house in which mechanical stokers were used several years before a coal and ash handling equipment was installed is shown in Fig. 1. This boiler house is located in a quarry depression some distance below the surrounding ground level, and the railroad siding is on a trestle about 30 ft. above the boiler room floor level. The siding runs across one end of the boiler house, and it is possible to store a considerable amount of coal underneath the trestle.

Before the coal handling equipment was installed the daily supply was wheeled into the boiler room, the lumps broken by hand, and the coal shoveled into the stoker magazine. The coal is now handled by feeding it through gates in the walls of a tunnel, located underneath the ground storage coal pile, to a drag chain feeder conveyor, which feeds it regularly to a crusher. After passing through the crusher it goes into the boot of a bucket elevator, which elevates it and delivers it to a distributing flight conveyor, which in turn distributes it in an overhead concrete bin, and from this bin it is spouted by gravity direct to the stoker magazine. After the coal is delivered to the feeder conveyor, therefore, the handling and delivery to the stoker magazines is entirely automatic.

This gives a chance for a direct comparison between the cost of hand methods of taking coal into a boiler room from an outside storage and handling it by hand to mechanical stokers, and of doing the same work by mechanical means. This boiler room contains six boilers of a total normal horse power rating of 1,530, the overhead bin in this case being supported partly on the outside boiler room wall and partly on concrete columns. The amount of coal used per day averages about 60 tons, and the coal handling machinery has a capacity of 30 tons per hour. The overhead bin holds 250 tons, or about four days' supply.

The saving in the cost of handling the coal has been quite striking. Before the installation of the mechanical coal handling equipment three firemen and three coal and ash wheelers were required on each 12-hour shift, or a total of 12 men per day divided into two shifts. Since the installation of the mechanical coal handling equipment this number has been reduced to one stoker operator and one ash wheeler for each shift, or a total of four men per day divided into two shifts. This makes a saving of 8 men per day, each working 12-hour shifts, so that the actual saving in cost of labor would be as follows:

Four firemen @ 40c. per hr. for 12 hr. per day. Saving per day \$19.20.
 Four coal wheelers @ 30c. per hr. for 12 hr. per day. Saving per day \$14.40.
 Total saving per day \$33.60.

For 365 days per year at \$33.60 per day there would be a saving in the cost of labor of \$12,264. The total cost of the installation of the overhead bin and the machinery equipment was about \$15,000, even at the high prices prevailing during the war, so that the saving obtained probably paid for this installation in a year and a half or two years. The power cost has been small, as it always is in handling coal mechanically.

Up to the present time there has been practically no maintenance cost; if the machinery is properly taken care of this maintenance cost should be quite low, probably not over an average of \$300 or \$400 per year for an indefinite period, and with replacements of certain parts at the proper time there should be no necessity of a general rebuilding of the whole equipment; i. e., this rebuilding is done piecemeal when necessary and is considered as maintenance cost. The concrete bin is practically everlasting, so that the depreciation should be very slight.

A rather novel method was adopted at this plant for obtaining additional reserve coal storage. There is a lower level in an old quarry quite close to the boiler house, this lower level usually containing more or less water. It occurred to the management that additional storage of the submerged type could be obtained at the bottom of this quarry hole, and the scheme adopted for delivering the coal to the quarry hole was to handle it by the conveyor system and deliver it from the distributing flight conveyor to a chute, extending over the boiler house roof and over the edge of the quarry. It was not possible, however, to make the chute steep enough so that the coal would slide down it without help; this difficulty was overcome by flushing the coal down the chute by water; this made a very economical method of transferring the coal. In removing the coal from the quarry the water is pumped out and the coal elevated to the upper level by means of an inclined cable haul.

An equipment for a boiler house using about 20 tons per day is shown in Fig. 2. The storage capacity in the outside pile is about 600 tons, or 30 days' supply, and it is served by a gravity discharge elevator conveyor encircling the pile, with the lower end in a tunnel underneath so that the incoming coal can be taken from the track hopper and delivered to storage from the upper run or coal can be taken from the storage by means of gates and chutes to the lower run of the machine. There is also a flight conveyor running into the boiler room which delivers the coal through chutes to the floor in front of the boilers which are hand-fired. This conveyor receives its coal from the upper run of the gravity discharge machine.

A carrier equipped boiler house is shown in Fig. 3. This is designed for six 600 h.p. boilers set in batteries of two and equipped with mechanical stokers, with short extended furnaces. Each battery of boilers takes up a length of 31 ft. 6 in., and there is a 6-ft. space between each two batteries. The building is about 135 ft. long, and the front part is high enough to accommodate a 1,300-ton overhead steel bin of the suspension type, with spouts direct to the stoker magazine. At one end of the bin, and also inside the building, is a 100-ton overhead ash bin with spouts leading out to railroad cars on the siding.

The rear of the boiler room is built with a sloping roof (that is, one of the lean-to type), and is considerably lower than the front of the building. The bin is supported on steel columns set 28 ft. center to center sideways, and 19 ft. center to center longitudinally. The bottom of the bin is 22 ft. above the floor; the bin is 18 ft. deep to the top of the girders, and the crossbeams which support the conveyor are 12 ft. above this point. Light roof trusses span the columns at a height of 6 ft. 6 in. above the crossbeams. This makes the eaves about 67 ft. above the floor level, whereas the eaves at the rear wall of the lean-to are only 31 ft. above the floor level. The total width of the building, center to center of the columns, is 50 ft.

The railroad track comes in at the level of the boiler room floor. This track runs at an angle of about 20 deg. with the side of the building and comes quite close to one

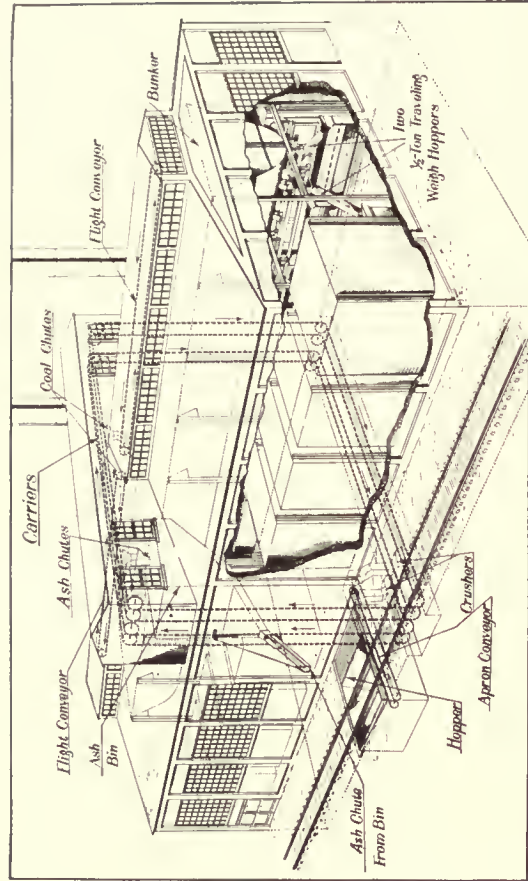

Fig. 6—A Combination of Pivoted-bucket Carriers and Flight Conveyors Constitute the Handling System

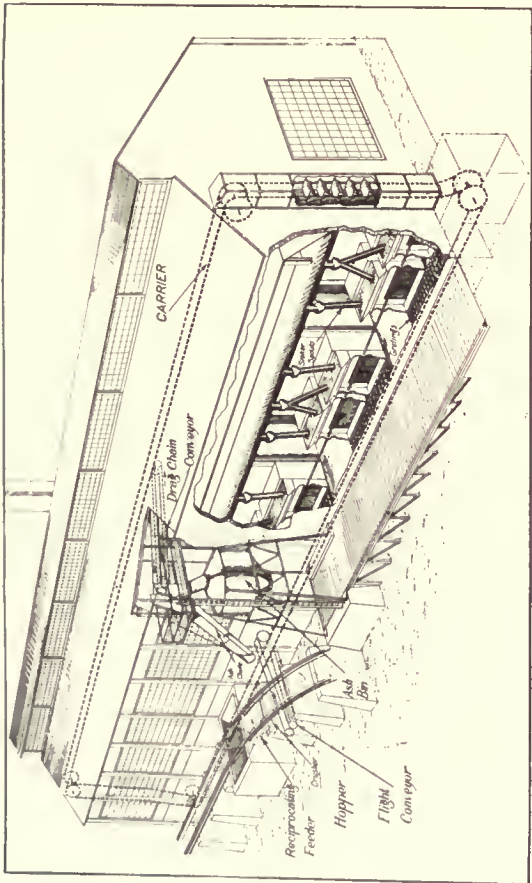

Fig. 5—A Remodeled Plant with a Trench Provided for the Lower Run of the Carrier

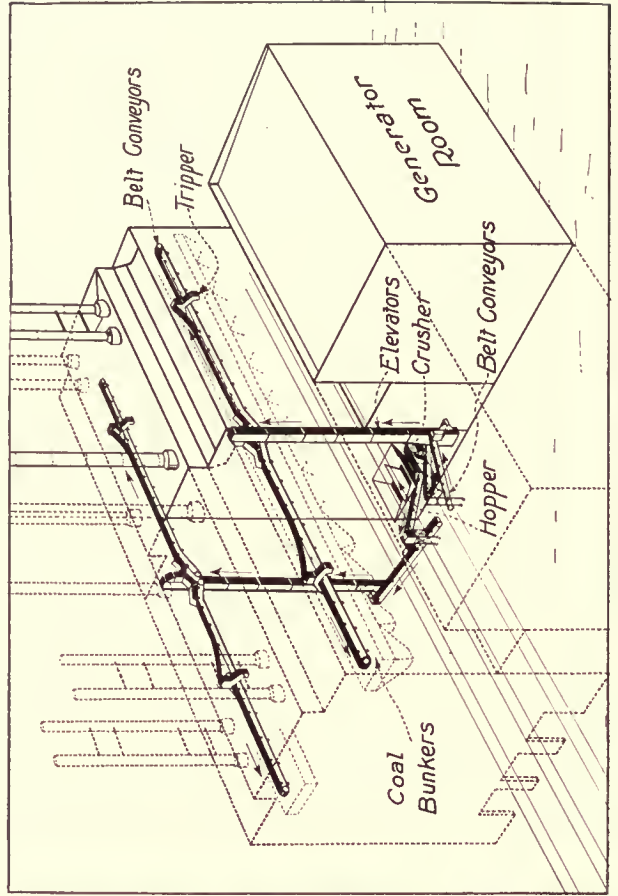

Fig. 8—An Interesting Layout



Fig. 7—View Showing Ground Storage and Ash Disposal Method

corner. The track hopper is located in this corner, and, since the siding is a dead-end one with little room for shifting cars, it was especially desirable that the track hopper should be made large enough to unload the largest cars without moving them. Since, therefore, the over-all dimension from the outside of the doors for the 140,000-lb. coal cars is about 22 ft., it was decided to make the track hopper 22 ft. long by 12 ft. wide.

The coal and ash handling equipment consists of a double reciprocating feeder underneath the track hopper, an apron conveyor to the crusher which is located directly over the carrier, a two-roll crusher, and a 24 in. x 24 in. pivoted bucket carrier following a rectangular path and having horizontal centers of 131 ft. and vertical centers of 61 ft. This carrier encircles the overhead bin and has the lower run in a tunnel, or basement, below the boiler room floor so that the ashes can be handled entirely in the basement. This equipment has a capacity of 60 tons of coal per hour, or an equivalent volume of ashes with the carrier running at a speed of only 45 ft. per min. There are three electric motors for driving the machinery, a 5 h.p. motor for the double reciprocating feeder, a 15 h.p. motor for the apron conveyor and crusher, and a 10 h.p. motor for the carrier.

The coal is dropped through the hopper doors of the railroad cars into the track hopper, from which it is fed to the apron conveyor by the double-reciprocating feeder. The apron conveyor then delivers it to the crusher, after which it goes directly into the carrier buckets, which elevate it and then distribute it by means of a tripper which tilts the buckets at any desired point along the horizontal run, thereby discharging the contents into the bin. From the bin the coal feeds by gravity through spouts to the stoker magazines. The ashes are raked out of the ash pits underneath the furnaces and directly into the buckets of the carrier on the lower run. They are elevated and discharged into the ash bin from which they can be delivered to railroad cars by means of gates and spouts. The fine coal which sifts through the upper part of the stoker grate bars is deflected into chutes leading to the lower run of the carrier. These chutes are emptied at intervals, and the siftings are sent back to the overhead bin. An interior view of the operating floor with the overhead bin and the spouts to the stokers is shown in Fig. 4.

In some cases, usually where remodeling an old boiler room, it is expensive to build a basement underneath the operating floor, or to raise the boilers to give the same effect; in such cases the lower run of the carrier is sometimes located in a trench directly in front of the stokers, and just underneath the operating floor, the ashes then being raked up out of the pits and fed through gratings to the lower run of the carrier in the trench. An installment of this kind is shown in Fig. 5.

The boiler room has seven 750 h.p. boilers set in batteries of two and each equipped with stokers. A 500-ton overhead bin is provided for the coal, with spouts from the bin to the stoker magazines through which the coal feeds by gravity.

A pivoted bucket carrier is the main conveyor for both the coal and ashes, this machine following a rectangular path with the upper run above the coal bin, and the lower one in a trench underneath the boiler room floor and close in front of the ash pits, so that the ashes can be raked or shoveled out of the pits and be delivered directly through gratings into the carrier buckets. For disposing of the ashes there is a small overhead steel bin outside the boiler house; this bin holds about 10 tons of ashes and is arranged to deliver to carts. To get the ashes out to this bin there

is a double strand drag chain ash conveyor for transferring from the carrier to the bin or to a spout leading to railroad cars standing on a trestle alongside the bin. The ashes, therefore, can be delivered either directly to railroad cars or to the small overhead bin and then to carts.

To provide additional ash storage and make it possible to load a railroad car quickly without having it stand on the railroad siding, the center section of the coal bin opposite the stack was partitioned off for ashes, thereby making an ash bin having a capacity of 50 tons. The ashes are put into this bin until it is desired to load them into the railroad car; then they are fed back to the lower run of the carrier by means of chutes, and the carrier and drag chain conveyor handle and deliver them to the railroad cars.

The coal is unloaded from the railroad cars at the center of the boiler room into a 10-ft. 6-in. square track hopper hung underneath the trestle stringers. This track hopper is fitted with a reciprocating feeder which delivers the coal to a two-roll crusher, crushing to a size about 4 in. and under. After the coal passes through the crusher it is handled by a short, double-strand flight conveyor across to the lower run of the carrier buckets, these buckets then taking it up and distributing it in the overhead coal bin.

The overhead coal bin is of the steel suspension bunker type, with the weight carried by girders along the upper edge, these girders being supported by steel columns. The outside ash bin is circular in shape with a sloping roof and hopper bottom. The body is 9 ft. in diameter, the cylindrical part being 5 ft. high and the conical part extending 2 ft. 6 in. below the cylinder. It is supported on steel angle posts resting on concrete foundations.

A boiler room in which the coal and ashes are elevated by pivoted-bucket carriers, the coal being delivered to roller flight conveyors running over the bins at right angles to the carriers, and distributing the coal in these bins, is shown in Fig. 6.

The track hopper is 18 ft. long by 14 ft. wide, and is made of $\frac{1}{4}$ in. steel, with angle stiffeners. Underneath this track hopper is an apron feeder 30 in. wide and having 21 ft. centers, which delivers the coal to a two-way chute crusher. The crusher rolls are 26 in. in diameter by 30 in. long, each crusher being driven by a 15 h.p. motor. The apron feeder is driven by a 3 h.p. motor, and operates at a speed of about 8 ft. per min. The carriers have 24 in. by 24 in. buckets, following a rectangular path having 74 ft. vertical centers and 84 ft. horizontal centers; they operate at a speed of 50 ft. per min. and have a capacity of 60 tons of coal per hour, or an equivalent volume of ashes.

The roller flight distributing conveyors have flights 19 in. long by 8 in. deep, spaced every 24 in., each conveyor having 86 ft. centers, and operating at a speed of 100 ft. per min. A $7\frac{1}{2}$ h.p. motor operates each conveyor. The coal bins are of the suspended type, built of steel and supported on steel columns. Underneath each bin are two $\frac{1}{2}$ -ton motor-operated traveling weighing hoppers for delivering to two rows of boilers. Each half of the plant has space for eight 600 h.p. boilers, or a total of 9,600 h.p.

A carrier equipped boiler room, with an outside ground storage for coal is shown in Fig. 7. In this plant there is a 300-ton suspension bunker in the boiler room, the upper horizontal run of the carrier being located above the overhead bin and extending out over the ground storage space, where it is supported on a bridge carried by steel bents protected by concrete. The lower horizontal run of the carrier is located in a tunnel underneath the ground storage, and underneath the ash pits of the boilers.

The coal is discharged from the railroad cars to a track



Fig. 11—Screw Conveyors for Conveying Coal Eliminate Dust

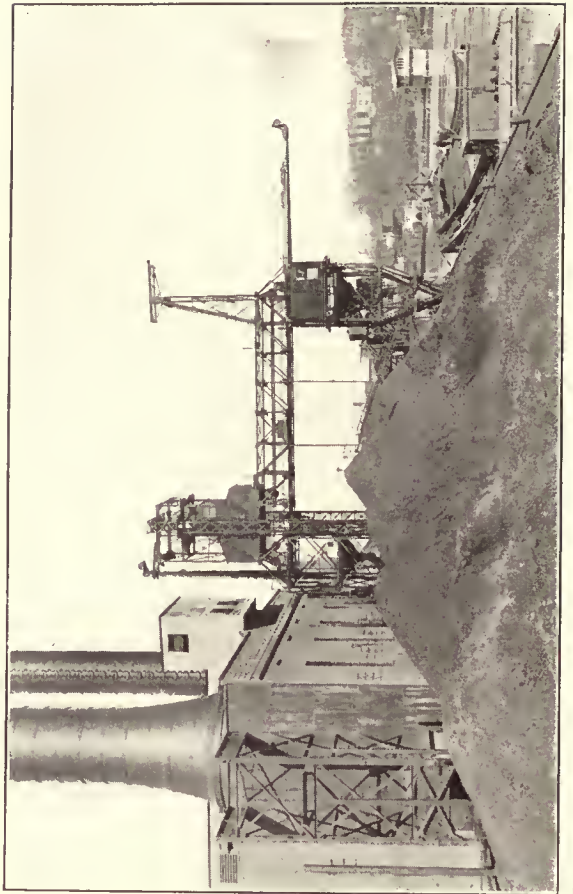

Fig. 12—Power House Served by a Traveling Bridge and Grab Bucket for Unloading Coal from Boats

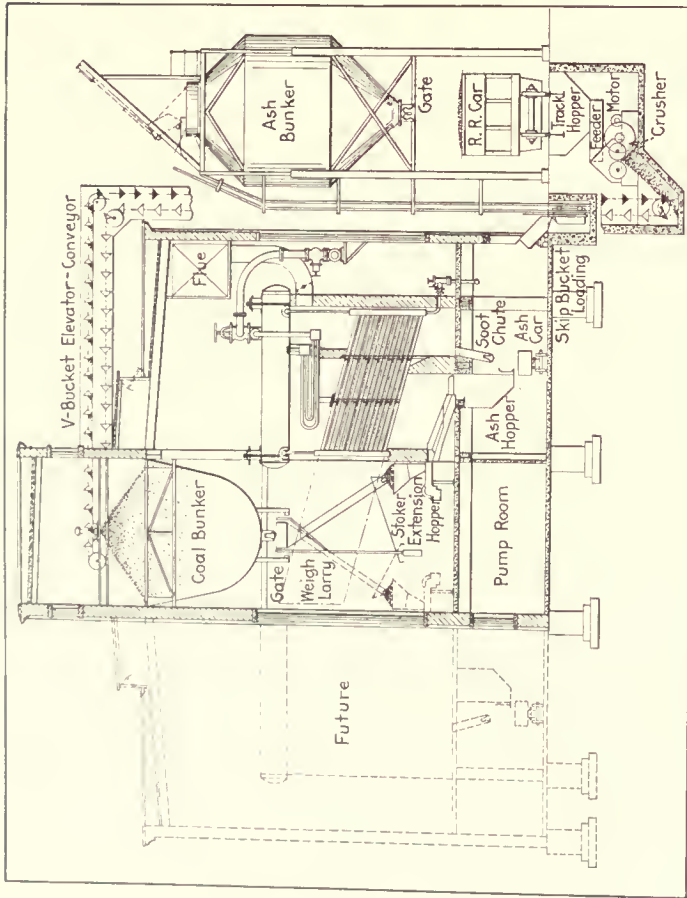

Fig. 9—The Overhead Coal Bunker Is Located Outside the Boiler Room in this Plant

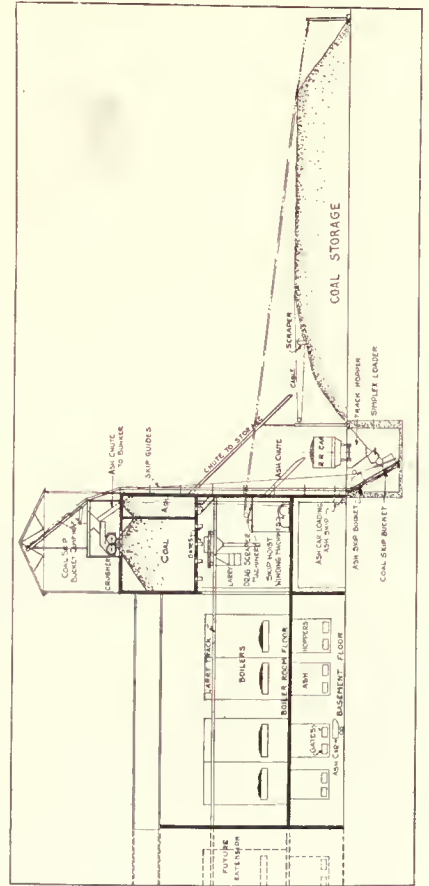

Fig. 10—A Boiler Room Equipped with Skip Hoists for Coal and Ashes

hopper, passes through a crusher, and is elevated by the carrier buckets and distributed either in the overhead coal bin in the boiler room, or to the outside ground storage. When the ground storage coal is needed, it can be fed back to the lower run of the pivoted bucket carrier, and be conveyed to the boiler room bin. The ashes are fed from the ash pit to the carrier buckets and are conveyed to an overhead bin, located close alongside the railroad tracks, and from which they can be delivered by gravity to the railroad cars.

A power plant with a rather novel coal handling equipment is shown in Fig. 8. There is an overhead bin to which the coal is conveyed by belt conveyors and continuous bucket elevators and the reserve coal storage is in a sub-basement; the coal is taken out of this storage by an overhead traveling crane, equipped with a grab bucket.

Provision has been made for eventually quadrupling the size of the plant. The present boiler room contains six 600 h. p. boilers which are equipped with stokers. The boilers are set in a single row, in batteries of two. Each battery occupies a space of about 30 ft., with spaces between the batteries 10 in. center to center of columns and similar spaces at the end, so that the total length of the present building, center to center of columns, is 130 ft. Space for economizers is provided over the boilers.

The railroad tracks are run into the building on a level 28 ft. below the operating floor. Underneath the railroad track is the reserve coal storage space, the bottom of which is 23 ft. below the track level, or 51 ft. below the operating floor level. The track hopper for feeding the coal to the conveyor system is located underneath the center track and outside tracks are run underneath the present and future ash hoppers. The track hopper is unusually large, the length being 28 ft., to serve all the hoppers of the largest railroad cars without moving them; the width is 20 ft. to provide for two feeders underneath.

The present feeder delivers to a 30 in. x 30 in. two-roll crusher, supported on a steel frame about 6 ft. 4 in. above the floor. The foot of belt conveyor No. 1 is located underneath this steel frame, so that the coal that passes through the crusher is delivered to the belt. This belt conveyor runs in the same direction as the railroad track and underneath it a little to one side of the center; the distance from the center of the track to center of the belt is about four feet. The belt conveyor and the future duplicate belt conveyor when installed deliver the coal to a chute arranged with flap gates in such a way that the coal from either of the belts can be delivered to either one of two other belts, running at right angles, one of these belts delivering to an elevator close alongside the wall in the present boiler room.

The future belt conveyor, running in the opposite direction, will deliver to another elevator on the opposite side of the boiler room. The present elevator elevates the coal and delivers to a belt conveyor which distributes it in the overhead bin. It is also arranged to deliver to a future belt conveyor running in the opposite direction over the future coal bin. The equipment on the opposite side of the future boiler room will be a duplicate of this.

The elevators are of the continuous bucket type and are 94 ft. 6 in. center to center. Two stands of 18 in. pitch steel strap chains are used, and the buckets which are of the super-capacity type, are riveted to the chain. The belt conveyors in the basement are 24 in. machines, operating at a speed of about 200 ft. per min. The distributing belt conveyor is a 20 in. machine, also operating at a speed of about 200 ft. per min. The machinery is designed for a capacity of 85 tons per hour. The motors used are as follows:

For driving the crusher, feeder and the two belt conveyors in the basement at 35 h.p. 900-r.p.m. motor.

For driving the elevator a 20 h.p. 900-r.p.m. motor.

For driving the distributing belt conveyor a $7\frac{1}{2}$ h.p. 900-r.p.m. motor.

When the coal is taken from the reserve storage in the basement by the grab bucket, it is delivered to the track hopper to be crushed, after which it is taken to the overhead bin. The ashes are delivered direct to railroad cars which are run into the basement underneath the hoppers.

Sometimes instead of locating the overhead bin in the boiler room, it is desirable to locate it outside, usually at one end. This is sometimes done when remodeling an old boiler room where the roof is too low to get the bin underneath it. A case of this kind is illustrated in Fig. 9.

A boiler room equipped with skip hoists for elevating coal and ashes, overhead coal and ash bunkers, larries for distributing the coal to the boilers and cars for transporting the ashes with an outside ground coal storage served by a cable drag scraper system is shown in Fig. 10.

The coal is received in cars on a track which separates the boiler house from the ground storage. From the cars the coal is discharged through a track hopper to a loader which feeds the coal skip bucket and is elevated to the overhead bunker by the skip hoist.

Coal destined for the boilers is discharged from the bunker through gates provided in the bottom to the larries. A chute is provided from the coal bunker to the ground storage over which it is distributed by the drag scraper. The scraper system also is used for reclaiming the coal.

Ash hoppers are provided below the level of the boiler room floor. These discharge to ash cars which in turn deliver the ashes to the skip hoist for elevating to the overhead ash bunker for delivery to railroad cars.

The boiler room at a food product plant, where it was advisable to avoid dust, is shown in Fig. 11. Screw conveyors are used for conveying the coal. These conveyors as well as the bucket elevator and the external suspended bunkers are fully enclosed.

A boiler house shown in Fig. 12 is so situated that the coal is received in barges from which it is unloaded by a grab bucket running on a traveling bridge equipped with cantilever arms. The coal may be delivered to a hopper carried on the outer leg of the bridge and distributed by a suspended belt conveyor to the storage pile or it may be carried direct to a second hopper on the inner leg of the bridge and from there fed direct to a belt conveyor leading into the boiler house. The same equipment may be used to recover the coal from the storage pile and feed the belt conveyor just mentioned.

Reserve Coal Storage

The methods of handling the daily coal supply at a boiler house have already been described. In addition to the equipment for handling this daily supply at minimum expense, it has become almost a universal practice to provide for an additional and much larger coal supply to serve as a reserve, to be called upon when there are no coal shipments coming in and to furnish a supply during the winter season when the mines and transportation facilities are overtaxed, when coal is usually higher in price, and to serve as an insurance against coal shortage due to various causes. This reserve storage tends to make the plant more or less independent of variations in the coal supply, and makes it possible to purchase coal at the most advantageous prices, to store it during favorable weather conditions, and to

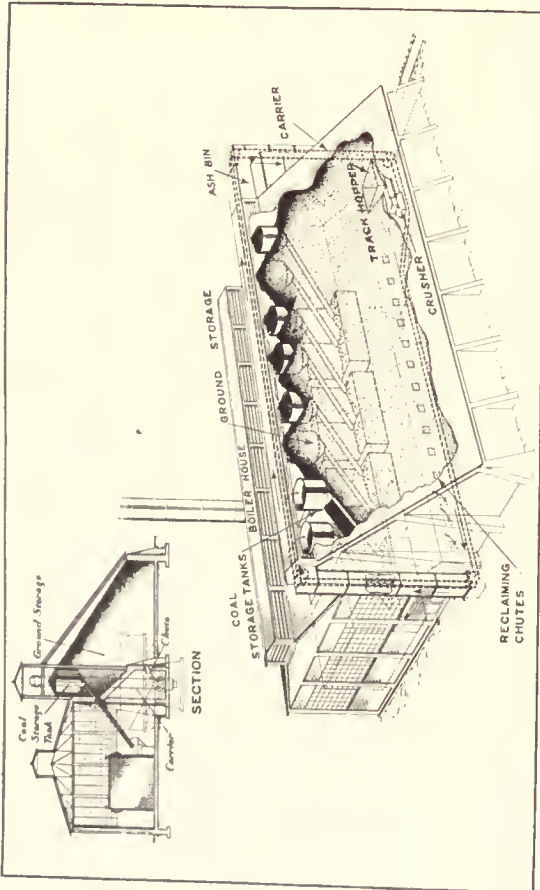

Fig. 1—A Pivoted Bucket Carrier Delivers the Coal to the Overhead Bin and Ground Storage

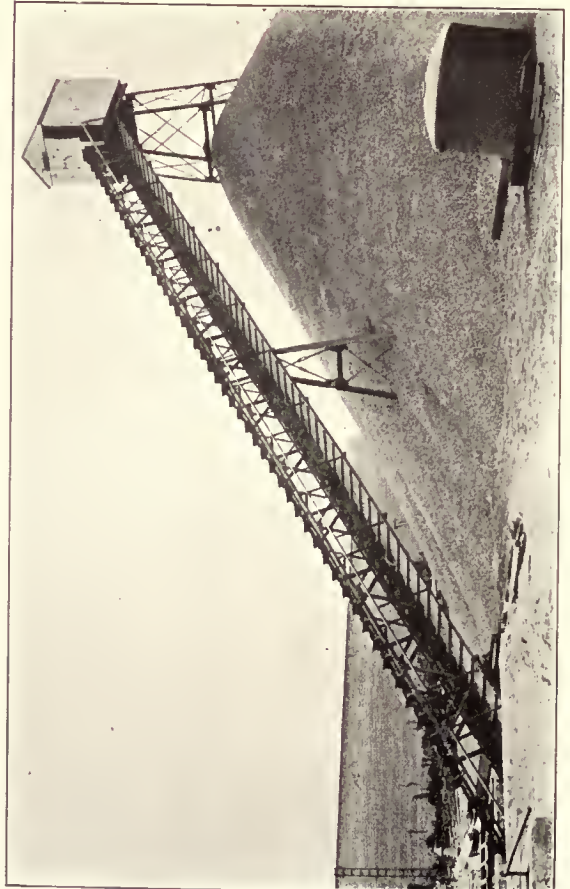

Fig. 2—Storing Coal with an Inclined Flight Conveyor

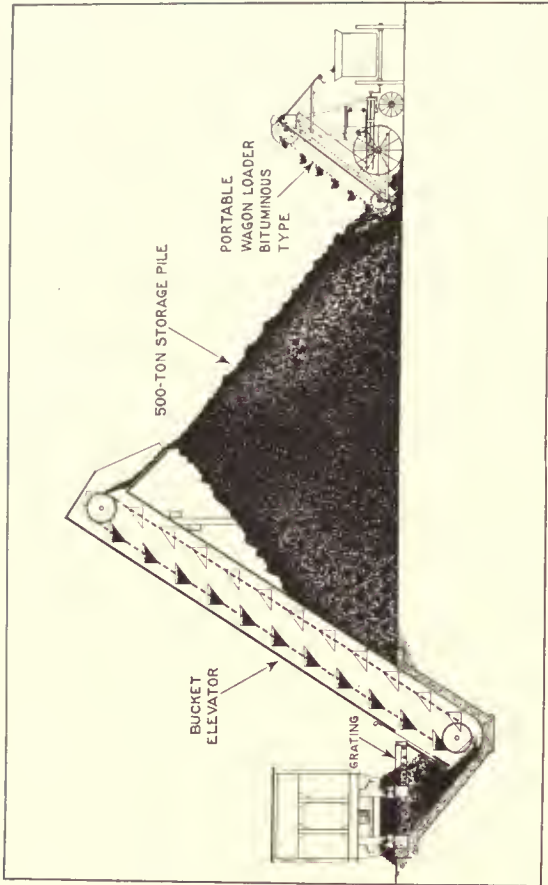

Fig. 3—Ground Storage Served by an Inclined Bucket Elevator and Portable Wagon Loader

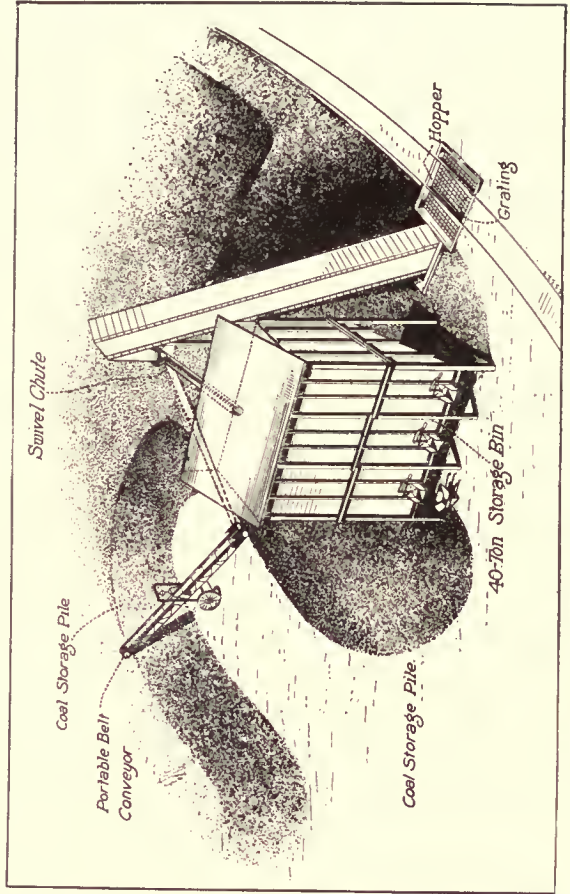

Fig. 4—An Interesting Combination of Machines for Storing Coal

avoid having to handle it during the adverse weather conditions in winter time, when the coal is apt to be frozen and the cars, therefore, hard to unload.

Since this reserve storage is not to be used as constantly as the active storage is, and since only a certain percentage of the yearly coal is to be handled to and from this storage, the cost per ton for handling the coal is not quite so important as it is with the active storage; since the amount of reserve storage is usually very much larger than the active storage, a much less expensive type of storage is ordinarily used.

The commonest method is to store the coal on the ground in an outside open storage though in some cases, it is housed, or bins are provided for it. These bins are usually of the ground storage type, where the weight of the coal rests on the ground instead of being supported on an elevated floor. Bituminous coal is sometimes submerged or covered with water so as to eliminate any danger of spontaneous combustion and also to avoid losses by oxidation.

If the coal which is being stored is anthracite, the piles can be made of any desired depth, since there is practically no danger of spontaneous combustion with this kind of coal. With bituminous coal, however, it is necessary to limit the depth of the pile in order to avoid spontaneous combustion, the maximum depth of pile being usually somewhere between 10 ft. and 30 ft., depending upon the kind of coal and various other conditions. Anthracite coal can therefore be concentrated in a deep pile, whereas with bituminous coal it has to be spread over a large area in order to avoid excessive depth. For this reason, and also because anthracite coal is usually small and regular in size, the reserve storage equipment is ordinarily cheaper and simpler for the anthracite than for bituminous coal. Where possible it is usually advisable to locate the reserve storage plant close to the boiler room, and arrange it so that the equipment which handles the coal to the active storage can also be used, in whole or in part, for handling the reserve storage coal.

An installation where a single pivoted bucket carrier handles the coal to the overhead bin, and also to and from the reserve coal storage is shown in Fig. 1. A number of circular steel bins provide for the overhead supply for feeding the stokers, the coal being delivered to these bins from the upper horizontal run of the carrier, which is located directly above them. When these bins become filled the surplus coal overflows into a concrete ground storage bin close alongside the boiler room in front of the boilers, this bin having a capacity several times as great as the overhead bin.

The lower run of the carrier is located in a trench, just below the floor level, and when the reserve coal storage is needed it is fed back by means of gates and chutes to the lower run of the carrier, which takes it up to the overhead bins for gravity delivery to the stokers. There is a certain amount of coal in the reserve storage bin which will not flow back by gravity to the lower run of the carrier, and which must be handled by hand when it is needed, but it is seldom necessary to do this and the labor cost will not add greatly to the yearly cost of handling the coal. The ashes are fed to the lower run of the carrier anywhere along the front of the boilers and are taken to the overhead bin over the railroad track at one end of the building, from which they can be delivered by gravity to the railroad cars.

A conical pile of small anthracite steam coal where the coal is delivered to the pile by means of an inclined flight

conveyor, supported by a steel truss resting on a tower at the center of the pile, with an intermediate bent lower down is shown in Fig. 2. The coal is discharged from the railroad cars to a track hopper underneath the tracks and is fed to the flight conveyor which discharges it at the upper end to the ground storage pile.

A ground storage pile to which the coal is delivered by means of an inclined chain and bucket elevator is shown in Fig. 3; a portable wagon loader is shown loading the coal from the pile into a cart. An arrangement somewhat similar to the above is shown in Fig. 4, except that in this case a portable belt conveyor is used in place of the portable wagon loader, and there is a small overhead bin for loading to wheelbarrows or carts. A certain amount of coal is piled in the ground storage area by discharging direct from the elevator with a swivel chute. When this area is filled up the coal is delivered by an extension chute to the foot of the portable belt conveyor, which spreads it over a larger area. In this way quite a large area can be covered; the portable belt conveyor may also be used for reloading to cars, carts or motor trucks.

Another reserve storage plant for small anthracite steam coal is shown in Fig. 5. This plant is located in a city where space is valuable. The storage space was excavated so as to form a pit, the coal being stored in the pit and also piled up above the regular ground level. The storage capacity of the plant is about 11,000 tons and all of this coal except a little which is used for boilers in an adjoining building is carted to the main boiler room of a publishing plant a mile or so away. The coal is unloaded from the railroad cars into the pit, and handled to either the overhead concrete loading pocket at the far end of the plant, or delivered to the ground storage.

The overhead distributing flight conveyor is supported by brackets attached to the adjoining building. The reclaiming flight conveyors that reclaim the coal from the storage pile, for delivery to the gravity discharge elevator-conveyor at the wagon loading pocket, are contained in concrete tunnels underneath the pile.

Another reserve storage plant, also using a gravity discharge elevator-conveyor encircling the pile, is shown in Fig. 6. To confine the coal pile to a certain area, concrete walls were built and concrete towers were built in the end walls for the up and down runs of the gravity discharge machine. The coal is distributed in the bin from the upper run of the gravity discharge machine, and is reclaimed from it by the lower run to which it is fed by means of gates and chutes in the tunnel. The gravity discharge machine delivers at one end to a flight conveyor, which takes the coal over to a bin in the boiler room for gravity delivery to the stokers.

A reserve coal storage plant, with a flight conveyor running over the storage and distributing the coal to it, and also a reclaiming flight conveyor in a tunnel underneath the storage to take the coal out and up into the boiler room bin is shown in Fig. 7. The distributing conveyor over the pile also extends over the boiler room bin, and coal may be handled direct to the boiler room if desired. The coal is handled from the track hopper to a crusher, by an apron feeder, and after passing through the crusher goes into the lower run of the flight conveyor, which takes it up an incline and along the horizontal run, either into the boiler room or discharging it to the ground storage pile. The capacity of the overhead bin in the boiler room is about 120 tons, and about 2,000 tons can be stored in the outside reserve storage. The daily coal consumption of the plant is about 60 or 70 tons.



Fig. 7—A Typical Layout Equipped with Flight Conveyors

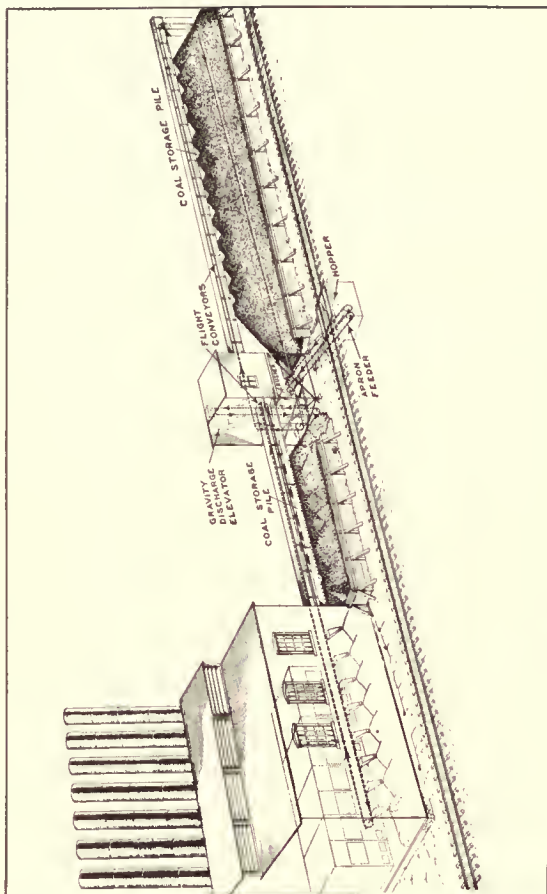

Fig. 8—An Inexpensive Storage Layout

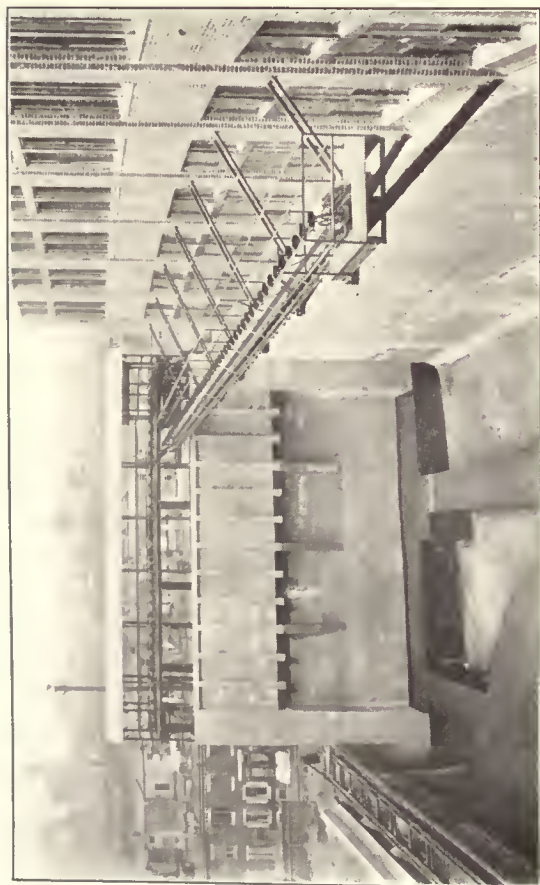

Fig. 5—Space Is Conserved in this Storage Layout



Fig. 6—The Storage Pile Is Encircled by a Gravity Discharge Elevator-Conveyor

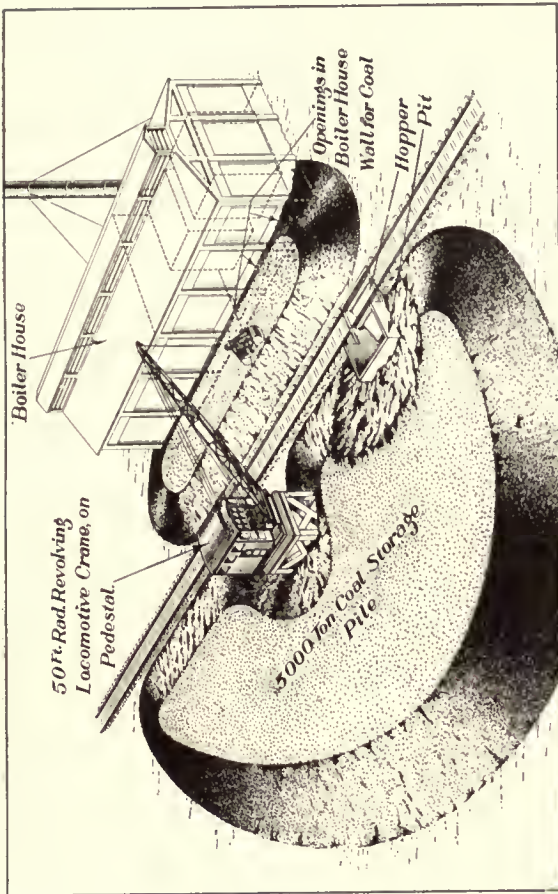

Fig. 10—A Stationary Locomotive Crane Is Used Here



Fig. 12—An Overhead Crane and Grab Bucket Serves This Layout

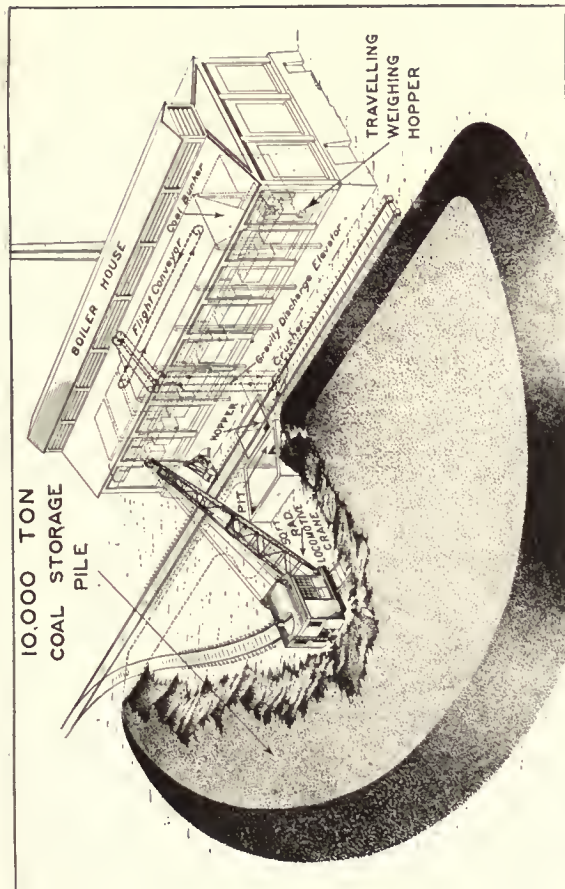

Fig. 9—Reserve Storage Served by a Locomotive Crane Traveling on a Circular Track

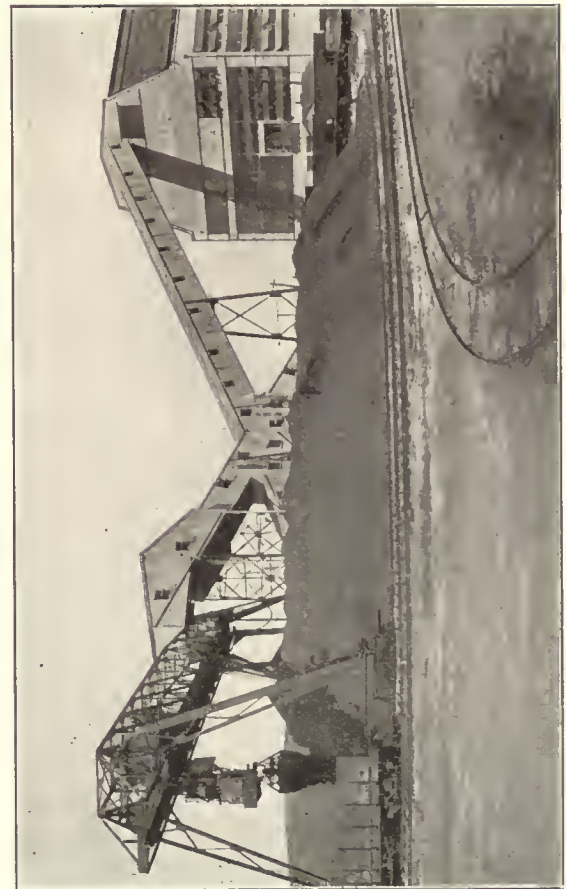

Fig. 11—Storage Plant Served by a Rotating Bridge and a Grab Bucket

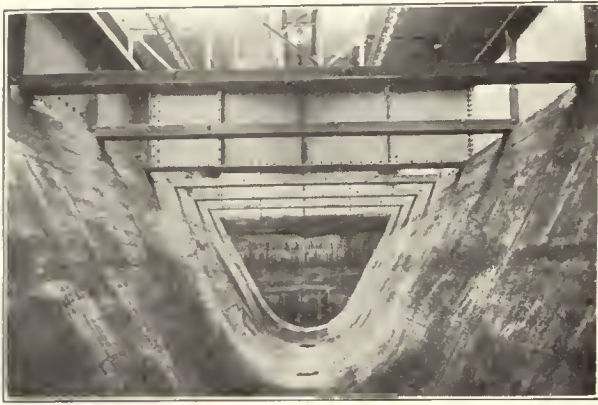

Fig. 1—Steel Bin with Concrete Lining

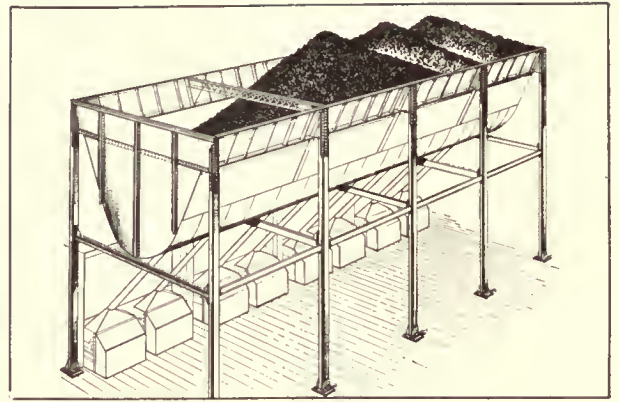

Fig. 2—Suspended Bunker

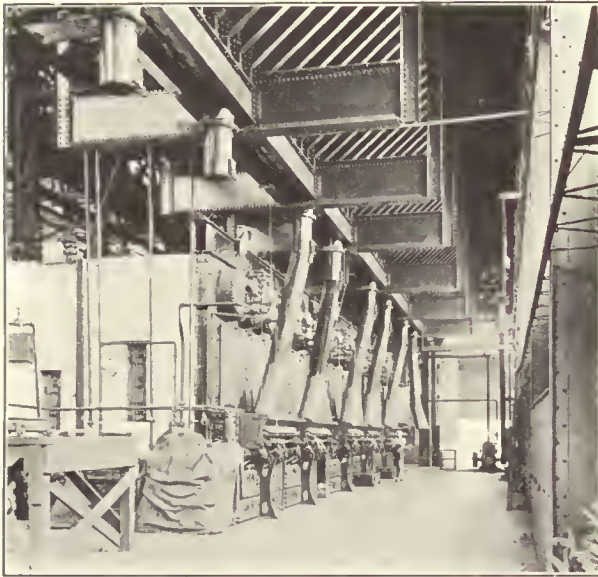

Fig. 3—Steel Bin and Supporting Girders

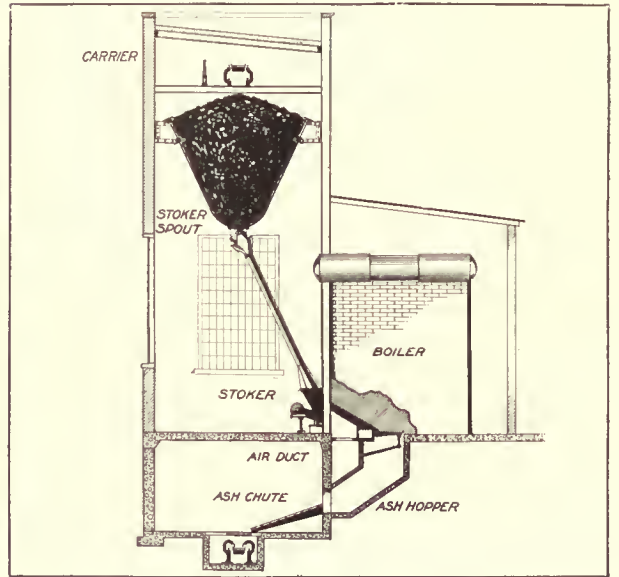

Fig. 4—Section of Boiler House and Suspended Bin



Fig. 5—Double Circular Bin



Fig. 6—Single Circular Bin

A comparatively inexpensive reserve storage extending alongside the railroad tracks is shown in Fig. 8. In this equipment the coal is unloaded from the cars to the track hopper and is transferred by an apron feeder to a crusher at one side of the track. After passing through the crusher the coal goes to a vertical elevator, which delivers either to a conveyor running to the boiler room or to a flight conveyor running in the opposite direction. The upper run of the flight conveyor is located above the storage pile and delivers coal to it; the lower run is in a tunnel underneath the pile and reclaims the coal from it. The conveyor which runs to the boiler room may either deliver the coal to piles on the boiler room floor or to a storage pile outside from which it is wheeled into the boiler room when required. When the coal is reclaimed by the lower run of the other flight conveyor, it is delivered to the foot of the elevator, which re-elevates it and delivers it to the conveyor to the boiler room.

An outside reserve coal storage served by a locomotive crane traveling on a circular track is illustrated in Fig. 9. When the coal is unloaded from the railroad cars, it goes either to a crusher and is conveyed to the overhead bin in the boiler room, or it goes into a pit alongside the track hopper from which the grab bucket picks it up and delivers it to the outside pile. When it is being reclaimed it is handled from the pile back to the track hopper and up into the bin, the crane being able to reach the track hopper from any point on the circular track. This makes an excellent type of locomotive crane storage in connection with a conveyor system for delivering to the boiler room.

A stationary locomotive crane on an elevated pedestal is used at another storage plant shown in Fig. 10. The locomotive crane picks the coal up with a grab bucket from a pit into which it is dumped from the railroad cars, spreads the coal over the storage area, and also reclaims it. The coal may be delivered to a pile against the boiler house wall and taken in through openings as shown, it may be delivered to cars or trucks, or it may be arranged to be delivered to the feeding hopper of a conveyor system.

Locomotive cranes are the most useful and flexible machines of any for handling coal to and from the reserve storage piles, and they are used in various ways, and with various track arrangements. Sometimes they unload direct from the cars, sometimes the coal is discharged from the cars to a pit or underneath a trestle and the grab bucket picks it up from the pit or from alongside the trestle and spreads it over the storage area.

In other cases the coal is fed from the track hopper to some form of elevator or conveyor which delivers it to the storage pile, and the locomotive crane then spreads it over a larger area and reclaims it from this area, delivering it back to cars or to conveyors leading to the boiler house. They are useful machines for this sort of work and can also be used for many other purposes around an industrial plant.

A reserve coal storage plant in which the coal is handled to and from the storage by a rotating bridge equipped with a belt conveyor for delivering the coal to the storage, and with a telfer machine and a grab bucket for taking the coal from storage is shown in Fig. 11. The coal is discharged from the railroad cars to a track hopper and is fed by means of an apron feeder to an inclined belt conveyor, which runs up to the center of the storage and delivers the coal directly over the pivot point of the bridge. From this point a belt conveyor with a tripper on the bridge distributes it over the storage area.

When it is reclaimed it is picked up by the grab bucket

handled by the telfer machine, and is delivered to the crusher located underneath the pivot point of the bridge; after passing through the crusher, it goes to another inclined belt conveyor which runs up and over the boiler house bin and distributes the coal in the bin. The storage capacity at this plant is 15,000 tons of coal, the stocking out capacity of the machine being 180 tons per hour, and the capacity of the crusher and conveyor to the bunker being 130 tons per hour. From the bunker the coal is delivered by a traveling weighing larry to the stoker magazines of the double row of boilers.

An electric hoist or telfer machine equipped with a grab bucket is frequently used for delivering coal to the storage pile and also for reclaiming and delivering the coal into the boiler house. Where only a small amount of coal is to be stored, a simple overhead monorail connecting the boiler house, the railroad siding and the storage pile may meet all requirements. By adding switches and additional overhead tracks the storage area can be greatly increased.

Another arrangement frequently used where a considerable amount of coal has to be stored, is to connect the monorail tracks with an overhead traveling crane covering the storage pile. Such an arrangement is shown in Fig. 12. The monorail hoist with its grab bucket runs out on tracks over barges and cars and back onto the traveling crane for depositing the coal on the storage pile. When reclaiming, the coal is again picked up by the grab bucket and when the monorail hoist has been carried by the crane to the proper point the hoist runs off from the crane onto a spur leading into the boiler house.

Bins and Bunkers

Various types of overhead bins are used for storing coal in boiler rooms; these bins are ordinarily built of steel, concrete, or a combination of both. The older bins were usually built of steel, with a supporting structure of beams and girders underneath, with steel plates to form the bin itself, as shown in Fig. 3. This type of construction requires a heavy weight of steel in the supporting beams, and does not take advantage of the strength of the plates themselves.

In the later types of bins, the weight of the coal is supported mostly by plates or rods hung from girders along the top edges of the bin. These are what are known as suspension bunkers and were first designed by A. Samuel Berquist. A typical bin of this type is shown in Fig. 2.

Sometimes the steel bins are lined with a layer of concrete, as shown in Fig. 1. The concrete lining protects the steel plates from the corrosive action of wet coal which is most marked where the coal contains sulphur. However this corrosive action in most cases does not appear to be serious, and steel bins which have been in service for 13 years or more are still in good condition. It is good practice, however, to empty the bin occasionally and paint it inside and out to protect the plates.

Another type of suspended bunker has steel girders along the top edges and steel supports, but the body of the bin is made of concrete which is reinforced with light steel ferro-inclave plates. By placing the ferro-inclave plates in position first, the concrete can be added to the inside of the bin with little form work, and a coating of concrete can be plastered over the outside of the ferro-inclave so that a reinforced concrete body is formed. In addition to this, steel straps are attached to the girders at intervals of 3 ft. to 5 ft. and are made to take the parabolic

form of the bin, these straps serving as hangers or saddles to support the weight.

Another type of suspension bunker has a supporting framework similar to the ones previously described, but the weight is supported by means of rods or bolts attached to the upper girders and extending down to ties across the lower part of the bin. Below the ties is a V-shaped section which gives the proper slope to the bottom of the bin. The bin is lined, just inside the rods, with concrete, steel, or sometimes with wood.

The usual location of a boiler room bin is directly above the space in front of the boilers; as the bin and conveyor over it require considerable height this part of the boiler room requires a higher roof than is ordinarily required over the boilers. In recent practice it is customary to make this part of the boiler room with a separate roof or monitor over the bin, and then run the trusses or beams for the lower part of the roof from the bin columns, or beams along these columns, back to the rear wall of the boiler room. In this way the roof is broken up into short spans so that light trusses or, in some cases, I-beams can be used. This construction is shown in Fig. 4.

Circular bins are commonly used for ashes and sometimes for coal. Bins of this character are shown in Figs. 5 and 6.

Weighing Coal

Equipments for weighing coal at power plants may be divided into three classes— (a) weighing the coal received, (b) weighing the total amount of coal consumed, and (c) weighing the coal consumed by each boiler unit. The primary object of the first is to check the amount of coal received, so that the purchaser may know whether he is getting what he pays for. The second class of equipment is for keeping a record of the quantity of coal used, so as to know what the requirements are for the future; also to see whether the boilers are operating at about the proper efficiency; the record of the total amount consumed by several units will, of course, not give an accurate check on the efficiency of each unit. The third class of equipment is used to get a record of the operation of each unit. In some cases two or more boilers are grouped together and each group is taken as one unit.

For checking the amount of coal received at a plant there are several types of equipment, such as track scales, wagon scales, weighing hoppers with hand-operated or automatic scales, conveyor weighers, and coal meters. For determining the quantity of coal used each day in a boiler room the same types of weighing or measuring devices may be used, and also the movable weighing hopper or traveling larry equipped with some kind of scale.

For keeping a record of the coal used in each separate unit, the devices ordinarily employed are the automatic scale or the coal meter, use of which is usually fitted to the spout or spouts supplying each unit. It is possible to weigh the coal used in each unit by a movable weighing hopper equipped with a hand-operated or automatic scale, but in this case it is necessary to depend on an attendant to keep the amounts for each unit separated from those for the others, and it is next to impossible to get men who will always keep their records properly separated. If these records are to be dependable the human element must be eliminated, and they must be made entirely automatic, and without any possibility of error through carelessness or intent.

Track scales are also used for overhead tracks, usually of the monorail type. In such cases a separate section

of rail or rails is supported on the scale beam so that the larries or trolleys carrying the loads can be stopped and weighed; or if an automatic recording scale is installed the loads can be weighed as they pass over this section of track.

Automatic coal scales, in addition to saving labor, eliminate the possibility of error resulting from the human element, as the recording of the weights is done by the mechanism of the scale. These machines consist essentially of some kind of device for feeding the coal into the weighing hopper, and are arranged so that the feed will be shut off at the instant the hopper is filled to the proper amount; that is, if the scale is of 500-lb. capacity, coal will feed into the hopper until it contains exactly 500 lb. when the feed will be automatically shut off and another gate at the bottom of the hopper will automatically open and the 500 lb. in the weighing hopper will be discharged providing there is sufficient space underneath. Then the lower gate closes automatically and the feed again starts to fill the hopper with another 500 lb. load.

Each load is recorded by an automatic counter, so that the number of loads which have passed through the hopper can be read at any time. If there is not enough space underneath the weigh hopper for the coal to discharge immediately, the mechanism remains inactive until the coal is removed sufficiently for the weighing hopper to discharge completely; then the lower gate closes and the feeding mechanism again starts.

These automatic scales may be placed underneath a receiving hopper into which the coal is dumped from wagons or cars, or, as is usually the case, they may be placed at some point in a conveyor system where the coal can be handled from one conveyor through the weighing hopper and be weighed before it passes on to another conveyor. In this way an accurate record may be obtained of the amount of coal passing through the conveyor system.

Conveyor weighers are devices for weighing coal passing over a belt conveyor, a bucket carrier, or some other type of conveyor. There are several of these machines on the market, and some of them are guaranteed for an accuracy of within one per cent. They are entirely automatic in their operation.

In one of the machines commonly used for this purpose a short section of the conveyor is supported on a frame separate from the fixed supports, and hung on rods connected with scale beams. The weight of this floating platform is balanced by an iron float in a cylinder of mercury. For varying weights within the range of the scale the float takes up different positions and therefore its movement offers a direct measure of the actual weight of the floating platform.

In order to multiply the weight by the speed of the conveyor there is a special integrating device which adds up and records the weights passing over the conveyor.

Another device which is used for measuring coal is the coal meter. This apparatus is placed in a spout through which the coal passes downward; it consists essentially of a shaft, at the lower end of which is a spiral vane or propeller, which is revolved by the coal as it moves downward, the speed of rotation being proportionate to the downward movement of the coal. The shaft is supported on a bracket attached to the inside of the spout, and is geared to a shaft which passes out through the chute at right angles and which operates a counter that records the amount of movement of the propeller. By weighing the coal which passes through a spout equipped with such

a meter, and dividing by the number of revolutions of the propeller, the proper factor can be obtained by which to multiply the number of revolutions of the propeller to obtain the amount of coal which passes through the spout in any desired period. These meters are claimed to operate satisfactorily with small anthracite coal and even with crushed bituminous, but the more lumpy the coal and the less free flowing, the less the accuracy.

In plants with overhead bins the weighing equipment is usually located between the bin and the stoker magazines, so that the coal can be drawn from the overhead bin and be weighed before it is delivered to the stokers. The type of equipment used is the traveling weighing hopper or the individual automatic scale.

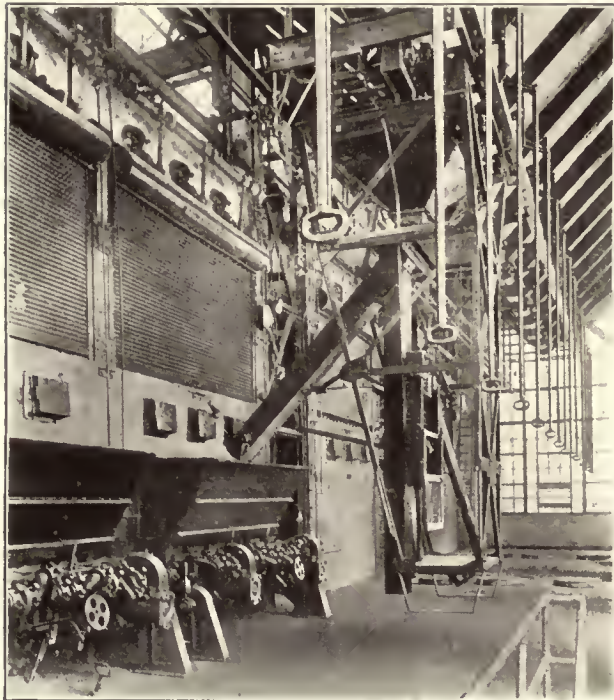

Motor Operated Traveling Weighing Hopper

A typical motor operated traveling weighing hopper is illustrated. When the service is light the weighing hopper is sometimes moved along the tracks by a shaft geared to one of the axles and operated by a chain wheel and a hand chain which extends to within easy reach from the boiler-room floor. The hand-operated machines are, however, fast going out of use, and the weighing hoppers are

being equipped with motors geared to one of the axles. The operation is directed by a controller with two ropes hanging within reaching distance from the floor. Pulling one rope causes the machine to travel in one direction, and pulling the other causes it to travel in the reverse direction.

The individual automatic scale for each unit offers the ideal way of obtaining the amount of coal consumed by each unit. A 100-lb automatic scale is not a costly device, and it will handle up to 4 tons an hour. These scales require no attendance, whereas the traveling weighing hopper has to be filled and discharged by the operator.

One of the illustrations shows an installation of three individual automatic scales. The coal feeds down through

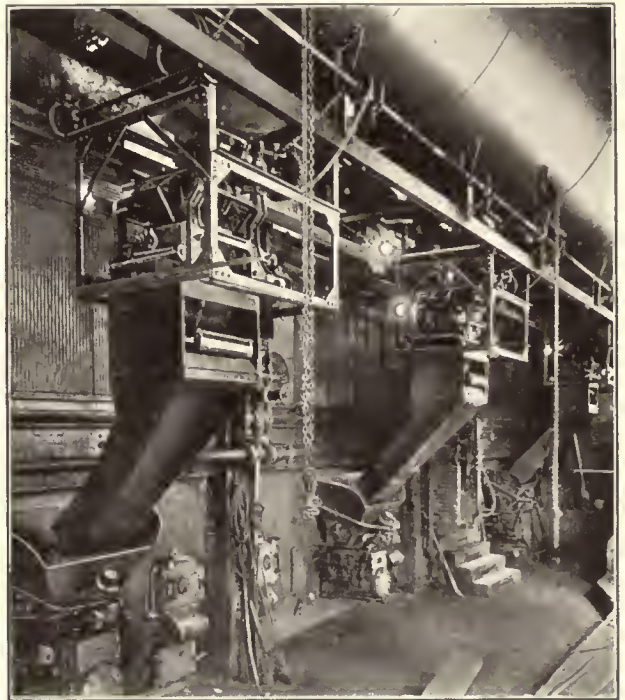

Individual Automatic Scales

the scales and the spouts to the stoker magazines, and, as a stoker uses up the coal in the magazines, more feeds down the spout until the weighing hopper is entirely discharged when the operating mechanism is again thrown into operation by the closing of the lower gate and the scale goes through another operation of filling up, weighing and discharging.

Coal Yard Equipment

Anthracite coal is ordinarily received at coal yards either in railroad cars or boats. When received in cars of the bottom dump type, a trestle of some sort is desirable which will permit the coal being discharged through the bottom doors of the cars. The trestle may be low, and the coal may be deposited on the ground beneath it, or it may be built high enough to permit of the construction of bins to receive the coal. When the coal is received in barges or boats it is usually unloaded by means of a grab bucket operated in connection with the mast and gaff, locomotive cranes or unloading towers which are described in other parts of this book.

The cost of providing ample storage in overhead bins is often prohibitive, particularly where the site of the structure is on level ground. In such instances the simple trestle and ground storage plan becomes a necessity. Handling coal by hand in such a layout usually means two movements of the coal—screening, and loading into the delivery conveyance. This is expensive work which can in many instances be reduced materially by the utilization of portable loaders capable of loading and screening the coal at the same time.

While the low trestle in conjunction with portable loaders often provides an economical layout the ideal plant is

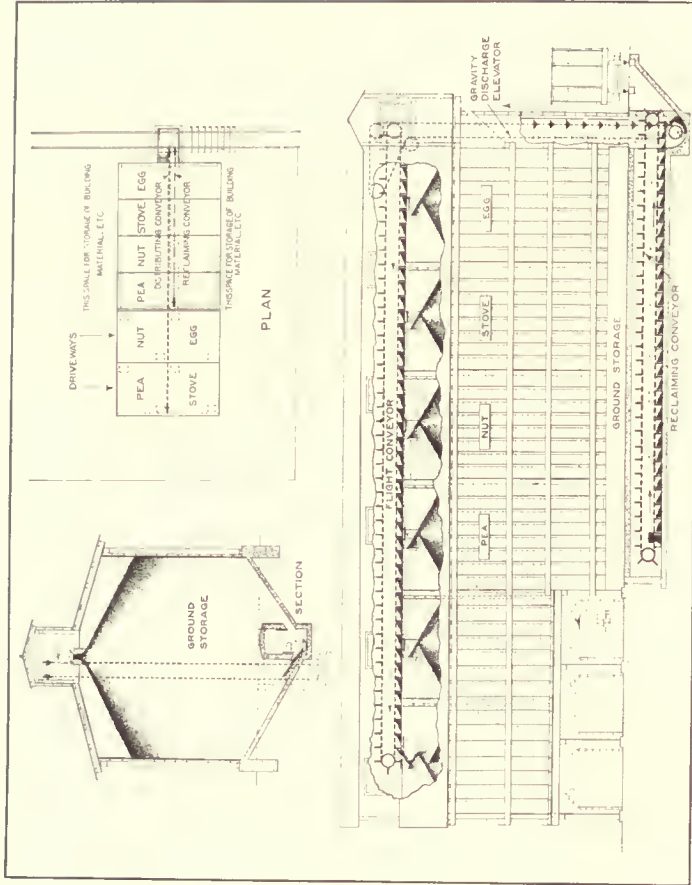

Fig. 4—Plant with Independent Distributing and Reclaiming Conveyors

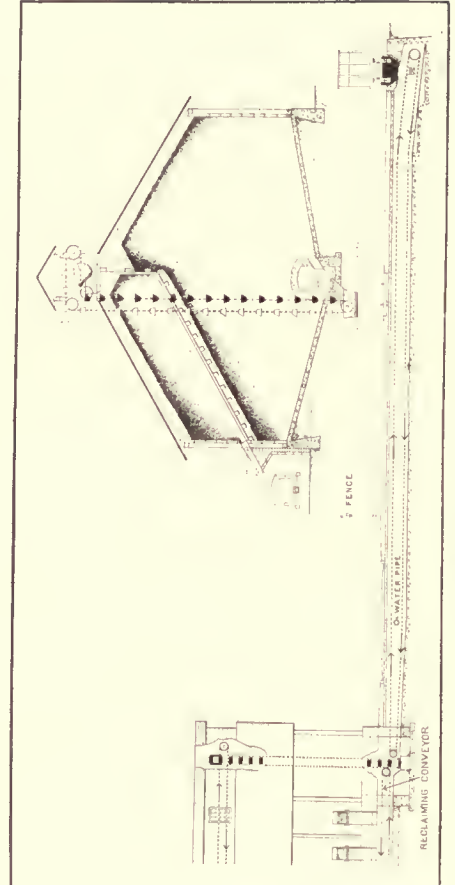

Fig. 5—Storage from Remote Receiving Point

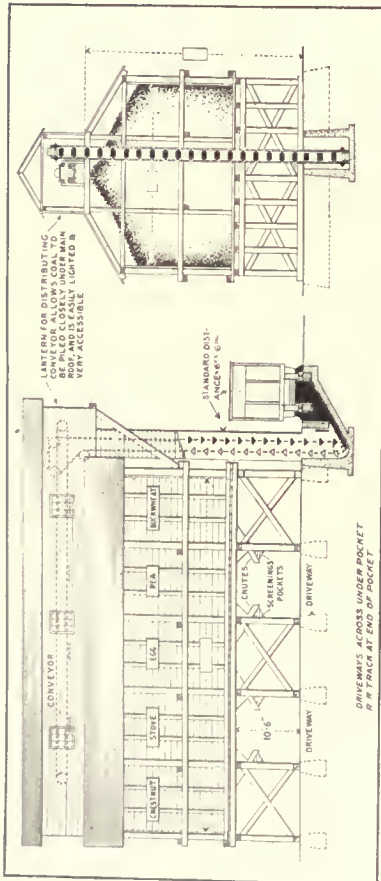

Fig. 1—All Storage Is Overhead

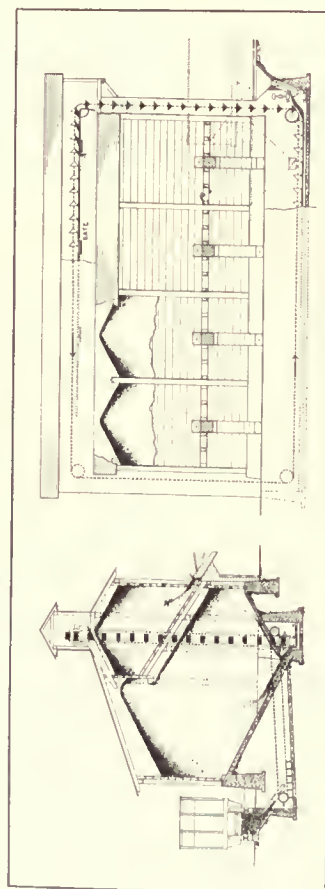

Fig. 2—Small Overhead Storage; Large Ground Storage

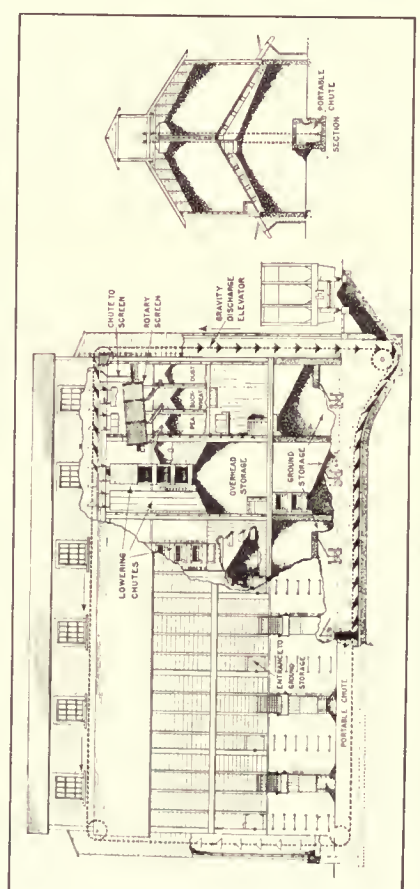

Fig. 3—Combined Overhead and Ground Storage; Two Side Delivery

the so-called high type gravity trestle where all the coal is unloaded into overhead bins so that it can be loaded out by gravity to wagons or trucks and automatically be screened as it passes over the screen chute. Conditions seldom warrant the construction of a trestle of the pure gravity type and it is usual to provide ground storage underneath the trestle so that the total storage will be sufficient to enable the dealer to purchase and receive coal at the most advantageous time.

Since each dealer has to handle at least four or five different sizes of coal, and frequently two or three grades in some or all of the sizes, his storage facilities should be arranged to keep these different sizes and grades separate, the greatest amount of storage being, of course, provided for the kind for which there is the greatest demand.

Where mechanical means are provided for handling the coal, the cars are usually unloaded at one point into a track hopper underneath the railroad track, and the coal is then handled by a conveyor system, and is delivered to the various bins. With the conveyor system a little additional height of the bins means very little additional cost for the machinery, and it is an easy matter to arrange the machinery to deliver to a number of overhead bins, and also to a number of ground bins if desired.

A typical retail coal pocket installation, where the coal is unloaded from railroad cars to a track hopper underneath the tracks, and is handled to the overhead bins by conveyors is shown in Fig. 1. The coal is delivered from the overhead bins by gravity over a screening chute to the wagons or trucks. A gravity discharge elevator and a flight conveyor are used for elevating and distributing the coal in the various bins. These types of machines handle the coal with very little breakage, but in order to eliminate breakage in discharging the coal into the bins, a so-called lowering chute should be used. The chute is essentially a series of shelves, one above the other, each shelf containing a small bed of coal, so that the coal which is being delivered to the bin rolls slowly back and forth from one pile to the other, without getting up much speed, and dropping only short distances from shelf to shelf. The machinery is usually operated by a small electric motor, though a steam or gasoline engine is sometimes used.

The screen chutes have bottoms made of screen wire of the proper mesh for each size of coal, the dust or screenings dropping into the small pockets underneath, from which they are taken out at intervals to be re-sized by means of a rotary screen or some other type of screen so that they can be sold to the best advantage. Small ground bins may be partitioned off underneath to receive the different sizes of coal and the coal removed from these bins by hand. Sometimes the re-sizing screens are located over small overhead bins, so that the coal can be drawn out of the bins by gravity, instead of having to be shoveled out. In such cases the screenings are either elevated and delivered to the screen by the main coal elevator, or a small separate elevator is installed.

An 8,000-ton retail coal pocket of concrete with the coal all stored in overhead bins is used in one of the large cities. This pocket serves not only as a distributing station for delivering to customers located in the central part of the city, but the coal is also handled by large automobile trucks, to four smaller pockets in outlying sections and is stored in the small pockets for delivery to local customers.

The coal is discharged from the railroad cars on a siding alongside the pocket, is elevated by a gravity discharge

elevator-conveyor which takes it up and across one end of the pocket and delivers it to either one of two longitudinal distributing conveyors, which run over the tops of the various bins and deliver the coal to them. The loading chutes underneath this pocket are made with two delivery spouts at different levels, the upper one for loading to large automobile trucks, and the lower one for loading to coal wagons or low trucks.

When a retail coal pocket is built so that all of the coal is stored in overhead bins, it means that the entire weight of the coal has to be supported on the under structure of the pocket and this necessarily makes the floor and under structure and the foundations expensive. It is, therefore, frequently more economical to store the greater part of the coal in ground storage bins and to build overhead bins for only a limited amount of the coal, and then arrange the machinery so that the same equipment will handle the coal to the overhead bins or to the ground storage, and also transfer it from the ground storage to the overhead bins when it is necessary to draw the coal from the ground storage.

With this type of pocket the ground storage is in the nature of a reserve storage and the overhead bins are the active storage, with gravity delivery to wagons or trucks. The greater part of the coal can be handled directly through the overhead bins to the trucks and wagons, so that this coal has to be handled only once. When, however, a greater amount of coal is received than can be taken care of in the overhead bins, it is stored in the ground storage bins, and then, when there is no coal coming in to be handled to the overhead bins, the supply in the ground storage bins is drawn upon. This means that the coal stored in the ground bins has to be handled twice, but the additional cost for this work does not amount to a great deal, since no additional force is necessary for doing the work and the cost of power for operating the machinery is a comparatively small item.

A diagram of a combination overhead and ground storage coal pocket is shown in Fig. 2. The overhead bins are along the front of the pocket and have a storage capacity of 300 tons. The ground storage bins are at the rear and have a capacity of 900 tons. The coal is fed by a chute with a regulating gate from the track hopper to a short flight conveyor which runs across in a tunnel underneath the pocket and delivers to a gravity discharge elevator-conveyor which encircles the pocket and delivers either to the overhead bins or to the ground storage bins. Lowering chutes are used for delivering the coal into the bins with a minimum amount of breakage. The chutes from the overhead bins to the wagons and trucks are housed over with a shed roof. When the ground storage coal is needed it is delivered through gates to the lower run of the elevator-conveyor in the tunnel underneath the pocket, re-elevated and delivered to the overhead bins. This equipment is driven by an electric motor and the handling capacity is from 35 to 40 tons of coal an hour.

A diagram of a somewhat similar pocket, except that in this case the whole upper part of the pocket is made into overhead bins with wagon loading chutes on both sides and with the railroad track running across the end of the pocket instead of alongside, is shown in Fig. 3. The storage capacity is 800 tons in the overhead bins and 700 tons in the ground storage bins. The walls of the ground storage bins are built entirely of concrete and the upper part of the pocket is built of wood resting on these concrete walls. The coal is discharged from the railroad cars into the track hopper

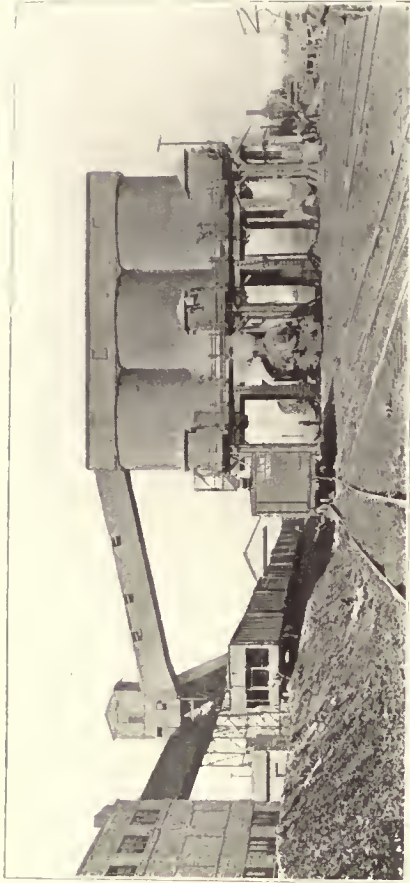

Concrete Silo Type Bunkers Served by Belt Conveyors

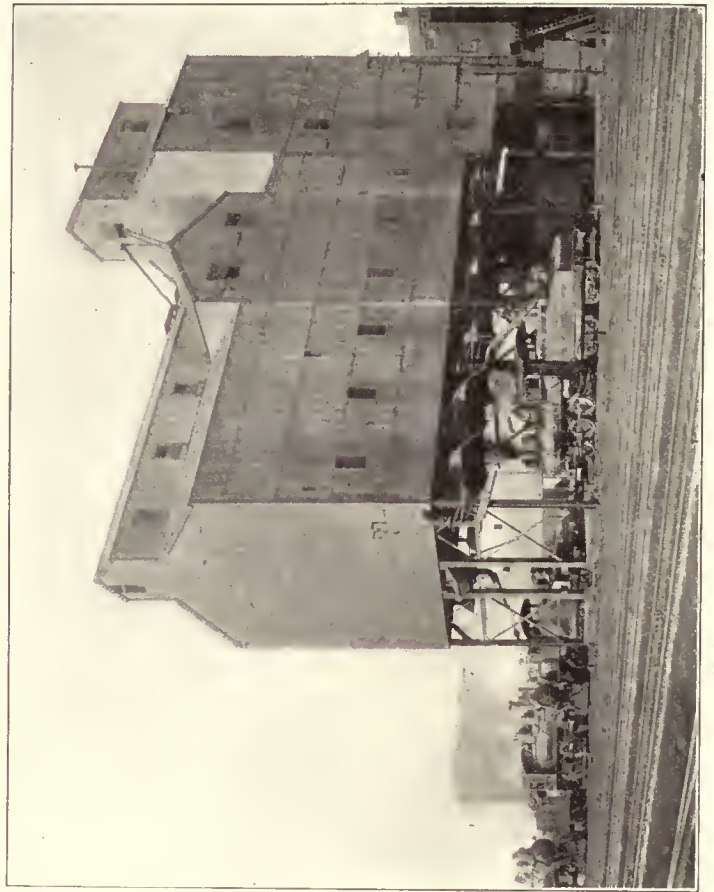

All Steel Plant Served by Balanced Skip Hoists

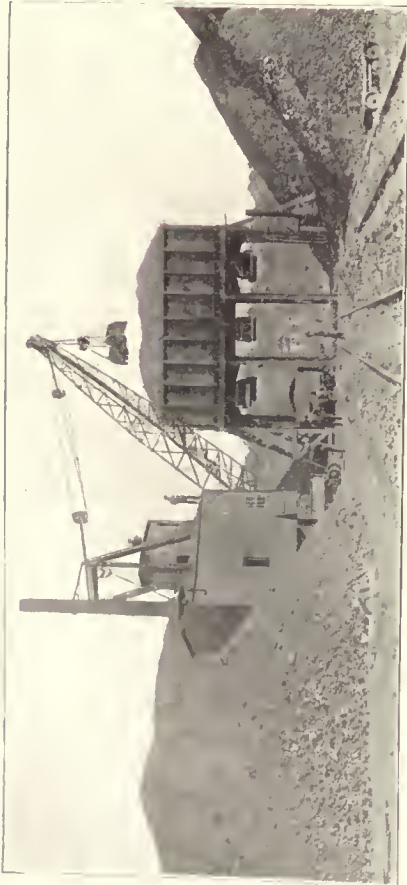

Small Engine Coaling Station with Locomotive Crane Supplying Overhead Bunkers

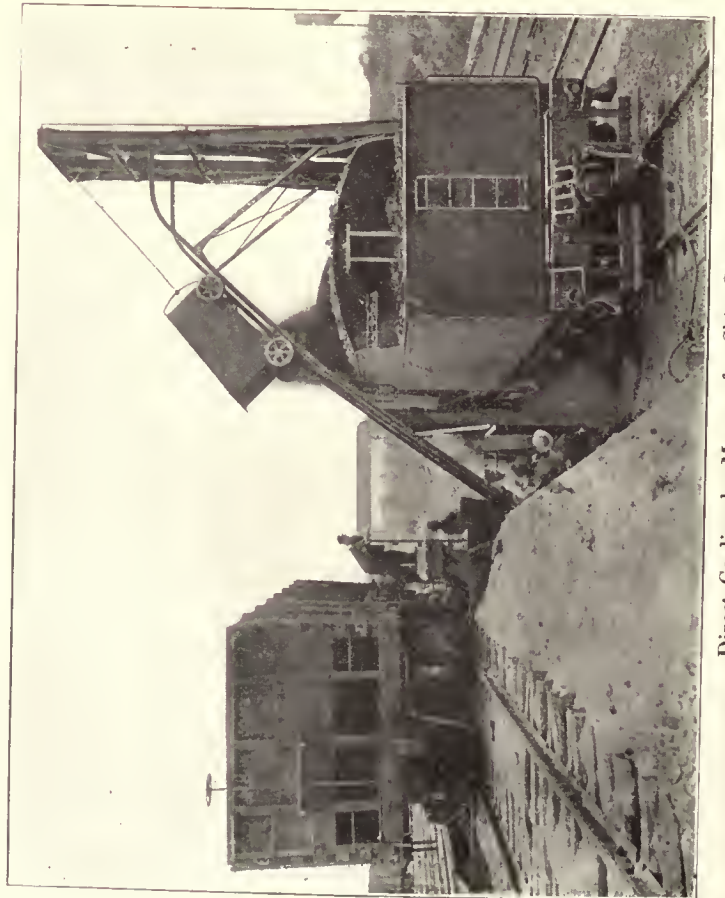

Direct Coaling by Means of a Skip Car

and is fed through a regulating gate to the foot of the gravity discharge elevator-conveyor, which elevates it and delivers it to the overhead bins. When these overhead bins are filled and there is more coal to be stored, part of the coal in the overhead bins can be discharged through gates in the floor down into the ground bins, and the overhead bins can then be refilled. The ground storage coal is rehandled to the overhead bins in the same manner as in the plant above described.

This pocket is also equipped with a rotary screen for resizing the screenings taken from underneath the wagon loading chutes. These screenings are collected and delivered to the main elevator which elevates them and delivers them to the rotary screen, which re-sizes them and delivers them to small bins underneath. The machinery is all operated by a single electric motor and the capacity is about 45 tons per hour.

A pocket with small overhead bins at one end with three driveways underneath, and with the rest of the pocket divided into four large ground storage bins is shown in Fig. 4. This design is suitable for a large amount of ground storage and a comparatively small amount of overhead storage. The machinery consists of a gravity discharge elevator and a distributing flight conveyor for delivering the coal to the bins, and a reclaiming flight conveyor in a tunnel underneath the ground storage bins to be used only when the coal is being taken out of the ground storage. This makes a simple and economical machinery arrangement, considering the amount of storage obtained, and one which costs comparatively little for

maintenance. When handling from railroad cars to the bins only the elevator and distributing flight conveyor need be operated.

A 5,500-ton overhead and ground storage pocket is shown in Fig. 5. The overhead pockets have a capacity of only 500 tons of coal. This pocket proved a most economical design considering the amount of storage obtained. It consists essentially of four walls and a roof with partitions and inclined floors to form the overhead bins. There is a monitor along the roof for the distributing flight conveyor over the bins, and a tunnel underneath for the reclaiming flight conveyor which takes the coal out of the ground storage bins. It was not possible in this case to run a railroad siding into the yard, so a tunnel was built underneath a street, and underneath part of a railroad yard adjoining, and a flight conveyor installed in this tunnel; the coal can thus be unloaded from railroad cars standing in the railroad yard and conveyed in the tunnel to the foot of the elevator.

The machinery has a capacity of from 45 to 50 tons an hour and is all driven by a single electric motor, located on a platform about half-way between the ground level and the distributing conveyor level at the elevator end of the pocket. One chain drive runs up to the head of the elevator, which is connected by means of bevel gearing to the foot shaft of the distributing conveyor. Another chain drive runs down into the tunnel and is connected by means of spur gearing to the head shaft of the conveyor from the railroad cars and to the head shaft of the reclaiming conveyor underneath the pocket.

Locomotive Coaling Stations

The coal usually is discharged from bottom-dump coal cars to one or more track hoppers, and is fed by reciprocating or apron feeders to a chain and bucket elevator, usually of the gravity discharge type, or sometimes to an inclined flight or belt conveyor. For small or moderate size pockets the delivery to the bins is by chutes; for longer pockets distributing conveyors are used or the gravity discharge machines are extended horizontally so as to distribute the coal in the bins. Skip hoists of the single or double type are also used for elevating coal at locomotive coaling stations, and, where the overhead bin extends over considerable length, car systems are sometimes used with the skip hoists for distributing the coal to the bins.

Trestle storage pockets are also used in many cases, the coal cars being run up on a trestle, with pockets underneath for delivering the coal to the tenders; on account of the height required to deliver the coal to the tenders, the trestles must be built high, and a long approach is required to get the cars up on the trestle; the construction and maintenance costs are high and much ground space is required for the approach. This type of coaling station is practically out of the question for a terminal in or near a city.

At points where few engines are handled hand methods of coaling are often used; the coal is shoveled from the cars to a coal wharf or platform, and is then shoveled into the tenders. In some cases, advantage can be taken of side hills by running an elevated track above the coal wharf and building small pockets with chutes which deliver to large wheelbarrows; the coal can thus be transferred from the pockets to the tenders. These hand methods are, however, expensive and, in order to load a locomotive without delaying it too long several men are required; when only a few engines are coaled each day this makes the

handling costs per ton excessive. Even at points where only a small amount of coal is required each day, some mechanical method of elevating the coal and some overhead bin storage is probably justifiable in almost all cases; the coal will then always be ready for the locomotive and can be loaded quickly by the fireman or possibly one man at the station.

With the smaller coaling station the overhead bin storage is sometimes dispensed with and a coal car is held at the station to act as storage; the machinery is then operated whenever a locomotive is to be coaled, the coal being handled directly from the car to the tender. The equipment for this work usually consists of track hopper, feeder, and some form of chain and bucket elevator, usually of the continuous bucket or gravity discharge type; sometimes a skip hoist is used in place of the chain and bucket machine. The machinery supporting structure is usually built either of wood or steel, or a combination of these. Where an overhead bin is added it is usually built of wood; a single coaling chute is used to load the coal from the head of the machine or from the bin to the locomotive tenders.

For somewhat larger stations, gravity discharge elevators and skip hoists are both used to quite a large extent for elevating the coal and delivering it to the bins. The feed in either case is usually automatic, reciprocating or apron feeders being used to feed the gravity discharge machines, and automatic gates on the track hoppers to feed the coal to the skip hoists. The overhead bins for these larger stations can be built of wood, steel, concrete, or a combination of these materials. The wood construction is usually the cheapest in first cost, but is not so permanent as the other two materials, and there is also a greater fire risk. A steel structure can be made quite permanent but the



A Small Combination Locomotive Coaling and Coal Transfer Station Served by a Bucket Elevator

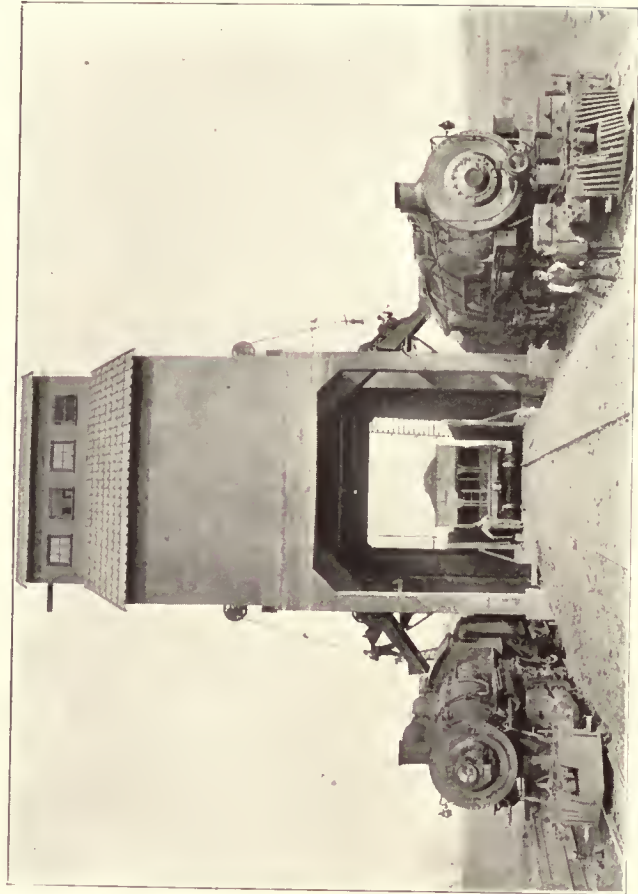

Small Concrete Coaling Station—Coal Is Received on the Center Track and Locomotives Coaled on the Outer Tracks



Large Concrete Coaling Station Served by a Gravity Discharge Bucket Elevator-Conveyor

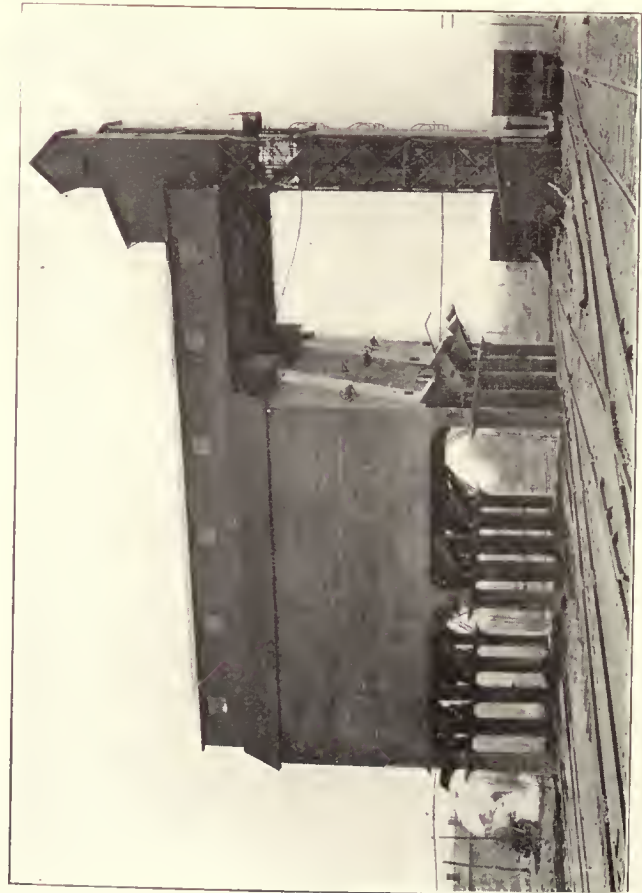

Large Locomotive Coaling Station—Concrete Construction—With Duplicate Automatic Equipment

locomotive gases tend to corrode the steel, so that at a large station where locomotives stand alongside or underneath the station much of the time, the maintenance cost is apt to be high. Concrete is undoubtedly the best material for coaling stations, since it is the most permanent and since the fire risk is practically eliminated, except for the rare possibility of the coal itself getting on fire; the concrete does not involve any maintenance cost for painting.

Where wooden bins are used they are usually made rectangular with sloping bottoms, whereas with the steel or concrete construction both rectangular and circular bins are used, the circular form being economical to construct. The bottoms are made sloping to make the bins practically self-cleaning, but this would not seem to be necessary in all cases, especially where the bins are not large, since, in such cases, there is little coal which will not flow out, even if the bottom is made flat, and flat bottom bins are much easier and cheaper to build.

Pivoted bucket carriers are also used for elevating and distributing coal in locomotive coaling stations, and since these carriers are the most rugged type of conveyor they are low in operating and maintenance costs; they are, however, not suited to handling large lump coal and can be used only for handling the smaller sizes, say not over 6 in. or 8 in. lumps.

Various track arrangements are used, the coaling tracks being sometimes underneath the bins, and sometimes at one end or at the side. The track arrangement is, of course, dependent to a large extent upon local conditions and requirements, but it would seem that certain standard track arrangements and certain standard designs for coaling stations could be developed, so that the engineering and construction costs could be reduced by the use of such designs, either in whole or in part, with necessary modifications to suit local conditions.

Handling Ashes or Cinders

The ashes or cinders are only about 10 per cent or 15 per cent of the weight of the bituminous coal consumed. These cinders must be collected from the points where they are cleaned out of the locomotive ash pans, and they must then be elevated and delivered to railroad cars. They are quite abrasive and, after being quenched with water tend to develop a weak acid which is quite corrosive to steel and somewhat corrosive to malleable iron or cast iron; the economical handling of cinders is, therefore, a somewhat more complicated problem than the coal handling.

The usual method is to build a pit underneath the dumping track with each rail supported on a wall, and either

discharge the cinders into the pit or into small cars or buckets in the pit. Where the cars or buckets are used they can be moved on rails in the pit and the cinders delivered to a skip hoist or some other form of elevator, or the car bodies or buckets can be picked up by a hoist and elevated so that the cinders can be discharged into an overhead bin or direct to a railroad car. Where the cars or buckets are not used the cinders are usually shoveled or scraped along in the pit by hand to the feeding point of a conveyor or are picked out of the pit by a small grab bucket operated by a locomotive crane, or some other form of hoist, or are shoveled out of the pit by hand. Pivoted bucket carriers have been successfully used for handling these cinders, the chains and buckets being made of malleable iron which does not corrode easily. These carriers may be made to serve a number of tracks, each track having its own pit and feeding point for delivering the cinders to the carrier, the handling from these feeding points to the overhead bin being automatic, thereby making it possible to handle the cinders rapidly and economically.

A special type of bucket or car with removable body has been developed for handling locomotive cinders, these buckets being mounted on trucks in the pit, and being lifted off these trucks by a hoist located at the overhead bin; the bucket is arranged for dumping through the bottom by a releasing door latch when it has been hoisted and moved over the bin. In some cases the hoist is arranged to deliver direct to a railroad car instead of to an overhead bin. Small cars which receive the ashes from the pits and deliver to a skip hoist are also used.

Sand Handling

The sand for the locomotives is usually received at a locomotive coaling station in a damp state, and has to be unloaded from the cars and either elevated to a wet sand bin, or first dried and then elevated to a dry sand bin, from which it is spouted to the locomotives. In some cases, where skip hoists are used for elevating the coal, the same machine is used for elevating the sand and delivering it to the wet sand bin. Where bucket elevators are used it is not usually advisable to use the coal handling machine for handling sand. As a rule a separate chain and bucket elevator is used, this machine being of small capacity and comparatively simple and inexpensive in construction. The sand is dried in special sand drying stoves or steam dryers, and, after it has been dried, it is usually raised by an air conveying system to the dry sand bins which should be located at the proper points for convenient delivery to the locomotives.

Equipment for Coaling Steamships and Loading Coal to Vessels

The enormous amounts of coal required to drive steamships, and the cargoes of coal handled by water, present problems in loading into the steamship bunkers and in the loading of cargo coal into the holds of the vessels that require great ingenuity and involve the expenditure of large amounts of money to accomplish the work expeditiously and economically. The bunkers of some of the larger steamships are capable of holding as much as 10,000 tons of coal, and this coal must be loaded in a short time, since any delay to a vessel of this size is costly.

Since, as a rule, the steamship is tied up to the wharf when the coaling is done, so that freight can also be loaded at the same time, the coal must be brought in barges and handled from the barges to the bunkers. Various methods

are employed for doing this work, such as loading the coal into tub buckets and hoisting it with the ship's derricks, handling with grab buckets operated as a rule by derricks or cranes, or handling by continuously operating chain and bucket elevators. The latter method is the most rapid and flexible yet devised; when coaling a large steamship a number of the chain and bucket machines can be operated at the same time. In some cases, instead of using chains with the buckets attached to them, buckets and steel plates are used alternately, and are attached together to form practically an endless steel belt traveling over drums at head and foot, the drums being made of steel discs connected by heavy steel rods so as to form wheels similar to wide sprocket wheels.



The Discharge Is Through Telescopic Chutes

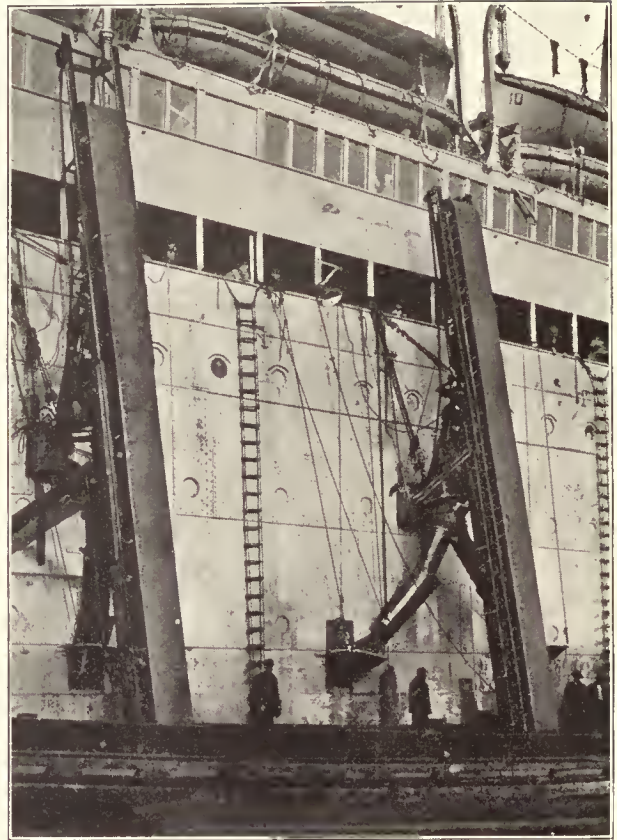

The Discharge Point Is Adjustable



Unloading Barge to Truck



Coaling Direct from Car

These machines are mounted on steel frames equipped with a ring or bail at the top, so that they can be moved by a derrick or crane. Where the buckets travel around terminal pulleys at head and foot, they dig up the coal from the barge as they pass around the foot wheel, carry it up to the top, and deliver it as they pass around the head wheel, long telescopic chutes serving to deliver the coal at the desired points. Where one machine does not reach a sufficient height, two machines are sometimes used, one delivering to the other; in other cases where more horizontal reach is desired, a portable belt conveyor is sometimes used to carry the coal over horizontally or at an incline, possibly in order to reach over an intervening lighter from which freight is being loaded to the steamship.

Another form of elevator is really of the gravity discharge type, the buckets being attached between two strands of chain, and the discharge being accomplished by turn-wheels which cause the chains and buckets to turn and travel horizontally or at a slight downward incline, so that the coal is discharged from the buckets as they turn. The height of the discharge point is adjustable with these machines, the turn-wheels being mounted on a frame which

strong and rugged to stand the severe service of digging this kind of coal.

In some cases portable conveyors are used to distribute the coal in the ships' bunkers, and sometimes ships are equipped with stationary conveyors which are fed at fixed points and which distribute the coal in the bunkers. Another method that has been devised for distributing coal in ships' bunkers is by revolving steel plates, located close together and close to the top of the bunker, and arranged with plows to scrape the coal off of one plate and on to the next. As the coal falls through the hatches which have discs adjacent to them, it piles up on the bunker floor, gradually rising to the level of the discs, and eventually falling on the top faces of the discs. The discs are then started revolving, and the coal is passed from one disc to the next, so that it is gradually stocked out in the bunker up to the level of the discs.

Another method of handling coal to steamship bunkers is by self-unloading coal lighters. These lighters are equipped with bins, into which the coal is loaded and from which it can be fed to a conveyor running underneath or between the bins; the conveyor carries the coal horizontally and

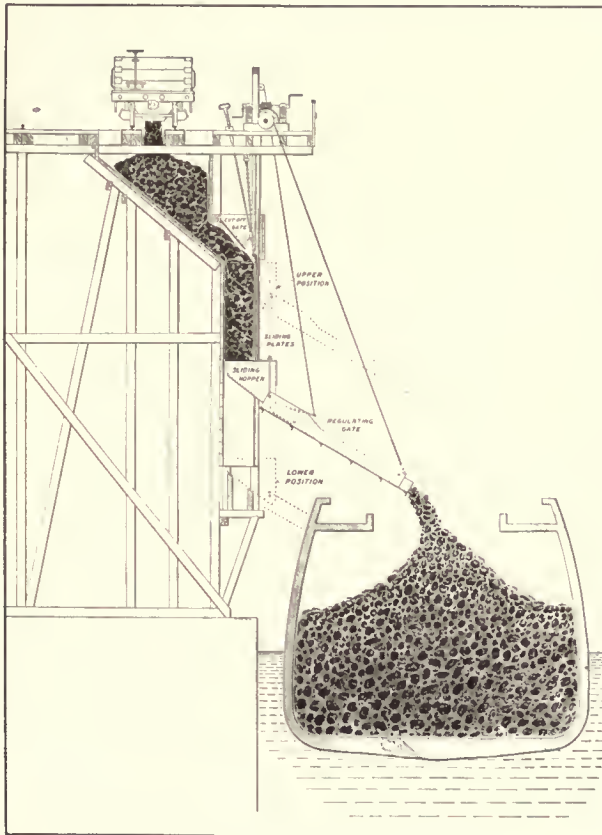

Loading Direct from Car to Vessel

can be moved up and down, so as to raise or lower the discharge point. This design eliminates the necessity of the long telescopic chute, the coal being elevated only to a sufficient height for delivery to the bunkers, instead of being elevated all the way to the top of the machine and delivered down a long chute. The whole machine can be allowed to descend so as to follow the coal down as it becomes lower in the lighter without changing the level of the delivery point. These machines are built to handle as much as 125 tons per hour of run-of-mine soft coal, and because of the large lumps have to be equipped with good sized buckets, usually about 24 in. long; all parts must be built

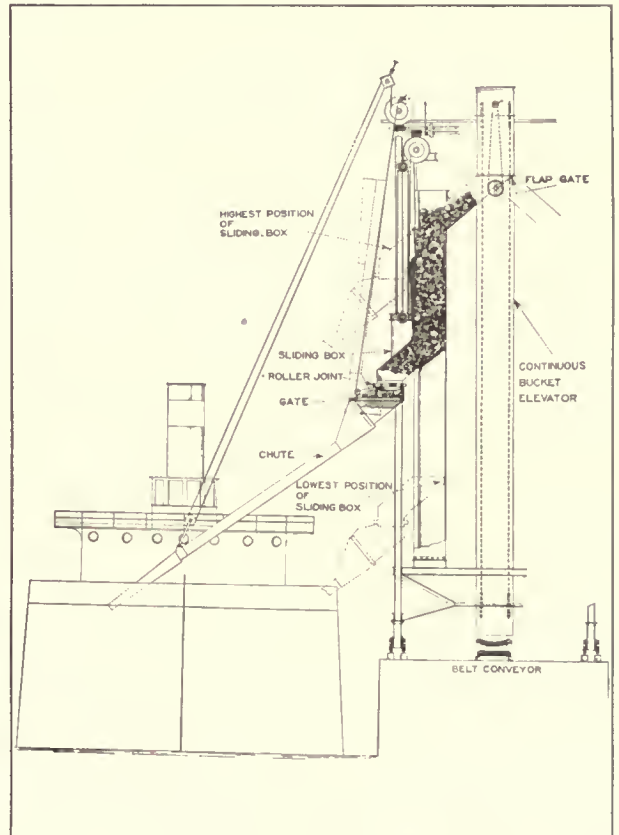

Coaling from a Traveling Tower

then up an incline, or delivers it to a second machine which does the elevating either vertically or at an incline, the coal being elevated to a sufficient height for delivery to the ship's bunkers. The machinery on these lighters is sometimes capable of handling as much as 500 tons per hour, so that a steamship can be coaled rapidly. As a rule the carrying capacity is not over 1,000 tons of coal, so that a single lighter cargo will not coal a large steamship. They are used to quite a large extent on the Great Lakes, where world's records are made for the rapid loading and unloading of vessels.

The loading of cargo coal into vessels is usually done

by fixed equipment on the shore, the vessel being tied up to the coal wharf, and the coal delivered over gravity chutes into the vessel. Trestles are sometimes built out on the wharf so that the coal cars can be run out on the trestle, and the coal delivered by gravity chutes direct from the cars to the vessels. Various methods have been devised to avoid breakage when delivering over these gravity chutes into the hold of the vessel, one of these methods being adjustable telescopic chutes. The hopper at the upper end of the inclined chute to the vessel is arranged to slide up and down, and there are sliding plates forming the front of the vertical part of the chute which also move up and down with the hopper. At the lower end of the vertical part of the chute is an inclined chute, the angle of which can be adjusted so as not to deliver the coal with too great a velocity. The inclined part of this chute is arranged to fold back out of the way when not in use.

Since run-of-mine bituminous coal does not flow freely through the bottom doors of standard railroad cars, the unloading of coal, even from the best types of cars, is not rapid enough and requires too much labor where large amounts of coal are loaded to vessels. In such cases a car dumper is used which turns the car over and dumps the coal out either to a chute leading direct to the vessel or to other transfer cars, which are designed to discharge rapidly and automatically through large bottom doors, these cars being taken up on a trestle, from which the coal is delivered by gravity to the vessel.

In some cases traveling towers, to which the coal is delivered by conveyors, have been used in place of high trestles, the traveling tower, of course, being much less expensive than the long high trestle, with the long approach or mechanical means for getting the cars up on the trestle. The illustrations show an equipment of this kind, which was designed for a location where only a moderate loading capacity was required, and where the expense for a car dumper or for a high trestle for the railroad cars was not considered justifiable. At the in-shore end of the pier are four parallel railroad tracks, under three of which are track hoppers into which the coal can be dumped from the railroad cars.

Just beyond the track hoppers is a car transfer table which connects with all four tracks, so that as soon as a car is unloaded it can be run on the transfer table and transferred to the fourth track and another car placed over the track hopper from which the car was removed. This arrangement avoids delay in shifting cars and with the three separate unloading tracks the blocking of one of them by a car that is difficult to unload, or from some other cause, does not interfere with the use of the other two track hoppers.

Running underneath the track hoppers at high angles to the tracks is an apron conveyor which receives the coal from the hoppers and delivers it to a belt conveyor running along the length of the pier. The coal from the rear track hopper, nearest the empty track, feeds direct to the apron conveyor, while that from the other two

hoppers is fed by reciprocating feeders to the moving apron and deposited on top of the coal already on it.

The movable tower rests on four eight-wheel trucks, traveling on rails along the length of the pier, and it carries a vertical continuous bucket elevator to which the belt conveyor delivers by a tripper fitted into the lower end and, therefore, moving along with it.

The coal is elevated and delivered at the head of the elevator to a two-way chute leading to two standard coaling chutes for delivery to vessels; one of these chutes delivers to vessels on one side of the pier and the other to vessels on the other side. The handling capacity of the equipment is figured at 600 tons per hour, i. e., 200 tons per hour for each track hopper, and all the coal can be delivered to a vessel on one side of the pier or the stream can be divided by the two-way gate at the head of the elevator so that it will go to both loading chutes simultaneously and, in this way, coal two vessels at the same time, one on each side of the pier. In practice coal will probably seldom be delivered to more than one vessel at a time, as the hatches of two vessels will not be likely to match up so that the chute can be easily set to reach both vessels.

The machinery is all electrically operated, the current being 220-volts, 3-phase, 60-cycle alternating current; the control system for the conveyor equipment is interlocked in such a way that the elevator is necessarily started first, then the belt conveyor, then the apron conveyor and reciprocating feeders; in shutting down the reverse order must be followed. This eliminates any possibility of flooding the elevator or belt conveyor.

The pier and the movable tower are made wide enough and are so designed that the capacity can be doubled or tripled if need be by adding one or two conveyor equipments exactly similar to the first one, this one being the central equipment and space being provided on each side for additional machines.

If the capacity should be increased to 1,200 tons per hour a car dumper would probably be added to dump the cars at the shore end, instead of unloading them through the bottom doors; this would surely be the logical step if the conveyor equipment should be tripled to a capacity of 1,800 tons per hour.

In loading lump coal or coal briquets, where it is especially desirable to avoid breakage, chutes have been used in some cases with mechanical feeders at the bottom to feed the coal slowly and deposit it gently on the pile in the hold of the vessel. A chute of this kind handled by a traveling gantry tower spanning the railroad tracks on a coal pier is shown in the illustrations. The coal is delivered from the regular adjustable coal pier chutes to this special feeding chute and thereby deposited gently in the hold of the vessel. In other cases, where breakage is no object, special high speed feeders are used at the bottom of similar chutes to spread the coal in the vessel hold by projecting it forward in the same manner in which it is delivered to the ends of box cars by the projecting box car loaders.

Sand and Gravel Washing Plants

THE EXTENSIVE USE of concrete for building purposes, foundations and roads, has led to a large demand for properly sized and properly washed sand and gravel. The sand and gravel must be screened to the proper sizes so that specifications for standard mixtures of certain sizes can be met, and must be properly washed so as to remove the loam which tends to adhere to the grains of sand and to the stones. Practically all sand and gravel contains more or less loam, and the only way to get rid of it effectively is by means of washing, and, to do this washing thoroughly, the material must be tumbled around in the water and the particles rubbed against each other. In practice the screening and washing usually are done simultaneously, though in some cases, preliminary scrubbers are used to tumble the sand and gravel around together and loosen up the loam before the material is started over the screens.

The digging of sand and gravel from banks or from bodies of water is accomplished as a rule by one of the five following methods:

(1) Automatic grab bucket, operated by a locomotive crane.

(2) Steam shovel.

(3) Drag-line excavator bucket operated either by a locomotive crane or by a cableway.

(4) Suction dredge, with rotary section pump.

(5) Chain and bucket elevator type of dredge.

A grab bucket operated by a locomotive crane is a rapid and effective method of digging sand or gravel, where the digging is not too hard, and the material can be dug either from a dry bank or from under water. The long reach of the crane boom makes it possible to dig a considerable amount of material without moving the tracks, and, since the bucket can dig some distance away from the track, pits of considerable depth can be dug without danger of cave-ins.

Steam shovels are satisfactory for digging dry banks, but the reach of the steam shovel arm is much less than the locomotive crane, so that the cut for one track location is narrower, and the steam shovel cannot dig much below its track level.

The drag-line excavator bucket is constantly being used more for this sort of work, since by the use of an overhead cableway, the drag-line bucket can be used as a conveyor and elevator as well as a digger, the material being taken direct to the washery, and discharged at almost any height desired.

The use of a suction dredge is limited to places where sufficient water is available, and where the sand and gravel does not contain stones too large to be properly handled by the suction pump. This type of dredge also requires a scow for carrying the dredge pump, so that it can be moved around on the body of water. The chain and bucket elevator type of machine is used to a certain extent where sand and gravel are to be dug from underneath water, and while this type of equipment is likely to be expensive in first cost, it will dig more effectively and handle coarser material than the suction pump.

For transporting the material from the bank to the washery, cars, operated by steam or electric locomotives, or cable hauls are used extensively. Belt conveyors are also used more or less, a movable conveyor usually being used at the loading point.

Where a drag-line cableway excavator is used, this equip-

ment, can, as stated above, be used also to transport the material to the desired point. Where a suction pump is used, the material can be pumped through pipes to the desired point.

Unless the material is handled by a drag-line cableway excavator which delivers it at the top of the washery, it is usually necessary to use some type of elevator or conveyor for taking the material up to the receiving hopper at the top of the washery. The machines most used for this purpose are inclined belt conveyors, inclined apron or pan conveyors, continuous bucket elevators and skip hoists. Belt conveyors have a large capacity on account of the comparatively high speed at which they are operated. Apron conveyors and continuous bucket elevators, if properly constructed, are very rugged and reliable, while the skip hoists are simple, and have comparatively few wearing parts though their service is intermittent instead of being continuous as with the other conveyors. Each type of machine has its own advantages under certain conditions, and the type selected should be the one best suited to the particular conditions in each case.

A sand and gravel plant is usually built with overhead bins with screens placed overhead, so that the material passing through the screens can be delivered direct to the bins. The bins are placed at the proper height so that the sand and gravel can be loaded out by gravity into railroad cars or trucks. If the material contains stone too large for the purpose for which the finished product is to be used, one or more crushers should be provided, the material either being crushed before it is sent up to the screens or passed over a preliminary screen which takes out the oversize stones. In the latter case the oversize material can be delivered by a chute, or otherwise, to a crusher, the crushed material being returned and mixed with the other material which is delivered to the washery.

In sizing, the best method is to take out the largest sizes or grades first. The greatest quantity of material is handled by the screen making the first separation and naturally the easiest and most effective screening result is attained by having the first screen provided with large holes, to pass readily all but the larger sizes. Then with the successive removal of the smaller sizes, the quantity of material to be handled is continuously reduced as the work approaches the screening of greatest difficulty—the separation of the finer sizes.

In addition to the superior screening efficiency by progression from large to small in the separation of sizes there is the mechanical advantage of greater durability and longer life for the screens, because the greater mass of material is handled by the heavier screens, whereas the reverse process throws the most destructive work on the fine screens, which naturally are least able to endure it.

An individual screen for each size or grade of product is also essential, that the whole volume of water used may be utilized in each screen as each size is taken out, thereby giving best results in washing and highest effectiveness to the water supplied.

Some materials carrying large amounts of clay, loam or molding sand, cannot be reduced properly in the first sizing screen, so they must be subjected to a preliminary agitation and washing, to break them up and scour them before they reach the screens.

After the material passes through the sizing screens,

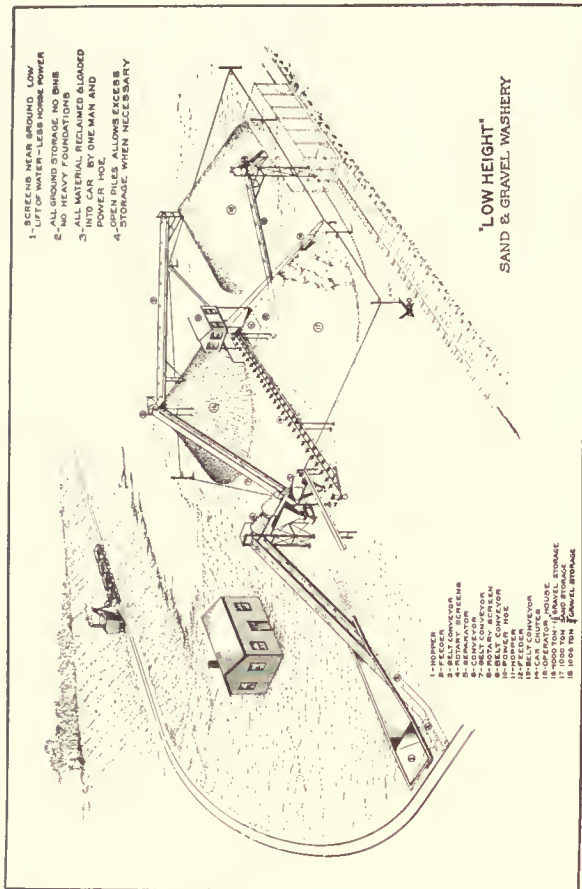

Low Height Washery

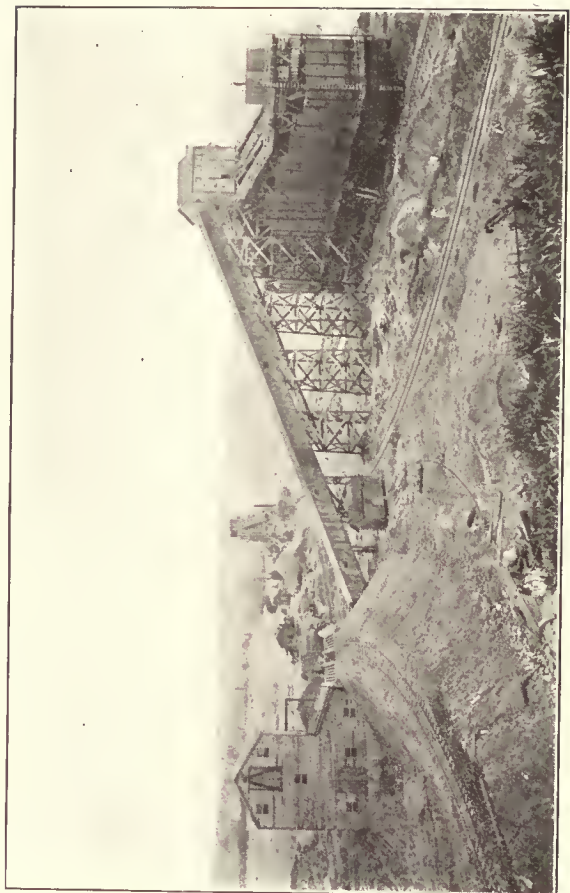

A Layout Served by a Conveyor from a Track Hopper to the Screens

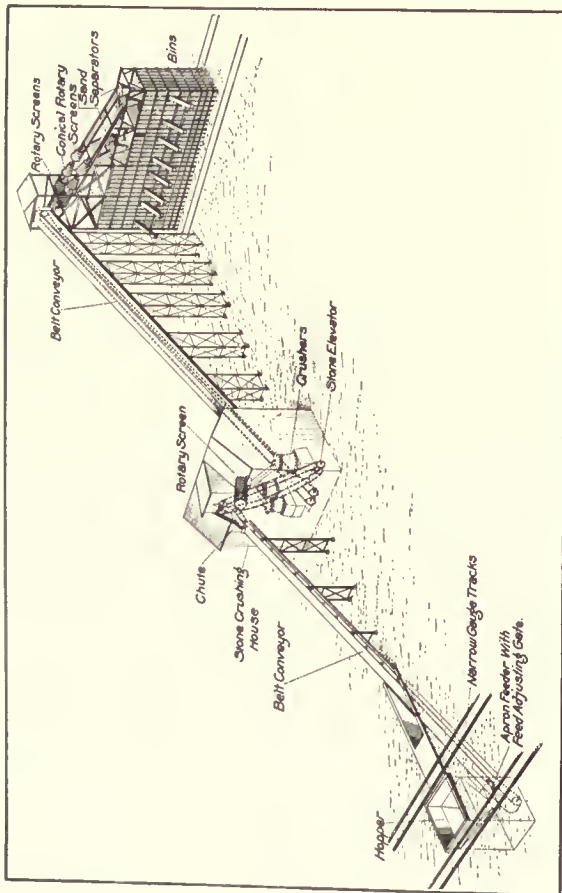

Typical Washery, High Bins

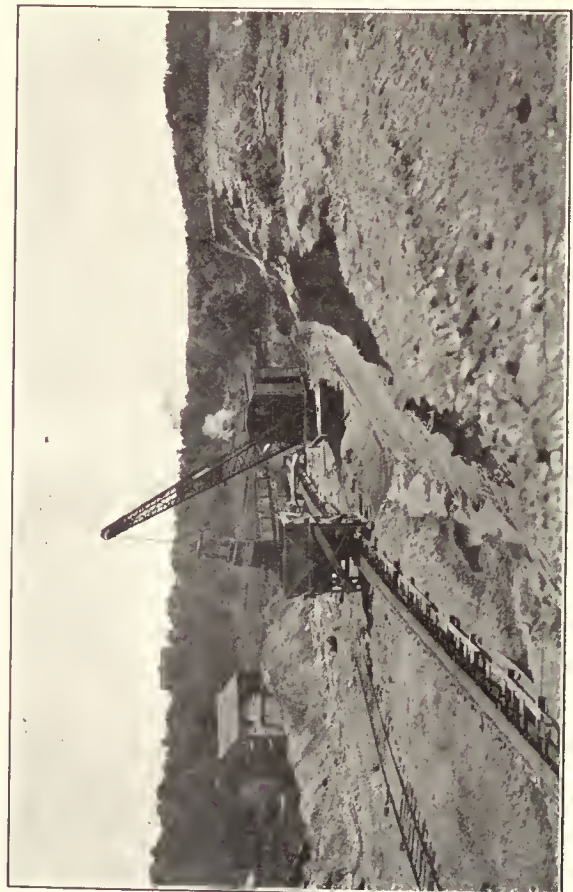

Steam Shovel and Belt Conveyor for Handling Sand and Gravel

the sand still remains with the soil water, from which it is separated by a sand separating tank or settling tank. This device automatically draws the sand from the bottom and allows the soil water to flow continuously out of a spillway at the top.

The number of screens used is governed by the number of sizes of material desired. In some cases the screens are mounted on skeleton framework or tipples, and the material drops directly into cars under the tipple. In the operation of such a plant a car must be provided for each size, and there must be a track for each size made.

In some cases the screens are mounted on dredges, from which the different sizes of material are spouted direct to scows; or, for portable plants, mounted on flat cars, truck wheels or rollers.

The bins can be made to hold from a few carloads to fifteen or twenty carloads and may be built of wood, steel or concrete.

Screens

The two most extensively used types of screens are conical in shape. In one the material is delivered to the small end of the screen, by means of a chute or water pan, extending back into the screen, and this end of the screen is closed by a plate so that the direction of flow of the water and gravel is reversed as it travels back towards the large end of the screen. The smaller material passes through the screen openings, and into a water pan or chute underneath, over which it flows to the next screen. Each screen is driven by a separate drive, the screen being mounted directly on the end of the drive shaft which it overhangs.

In the second type the material is delivered to the large end of the screen, the whole screen being inclined at an angle sufficient to insure the material traveling on down to the small end of the screen where the oversize material is discharged to a chute. The material which passes through the screen is caught in a water pan underneath, and delivered thereby to the next screen. With this system a series of two or more screens can be mounted on the same shaft, so that one drive serves for several screens. As the materials are fed into the large end of each screen and travel toward the small end, the principal work is imposed upon the large end of the screen. The large end has more perforations, more wearing surface, and is equivalent to a larger screen of other types. It therefore has greater efficiency, requires less power, and has small upkeep expense.

The screens have longitudinal joints and can be dismantled from the shaft without disturbing the shaft. Walk ways should be provided on both sides of the screens, to make them accessible. This type of screen does not require so much timber work for supports, neither does it require so great a height to install. It is made in four sizes, depending on the capacity required and the nature of the material. The number of screens depends on the number of sizes of material to be made.

The average plant is equipped with three screens. The first screen has usually $1\frac{1}{2}$ in. or $1\frac{1}{4}$ in. perforations, and all material over $1\frac{1}{2}$ in. or $1\frac{1}{4}$ in. is discharged through the small end of the screen into the first bin. The washing process now begins, as the revolving motion of the screens breaks the soil and foreign matter away from the gravel. The next size of gravel is separated from the mass by the second screen, in the same manner as the first. The second screen usually has $\frac{3}{4}$ in. perforations, and the material in the second bin is everything between $1\frac{1}{2}$ in. or $1\frac{1}{4}$ in. and $\frac{3}{4}$ in. The third screen is made with $\frac{3}{8}$ in. or $\frac{1}{4}$ in. perforations, depending on what class of trade the owner of the plant has, and how coarse he wishes his sand.

Pipe nozzles are placed at the discharge ends of the screens, for injecting water to prevent the material from discharging too rapidly and carrying over some of the finer parts. This fresh water is a rinsing water also and is an important feature of the washing process.

The sand, water, soils and impurities are discharged from the last screen into the sand separator. The sand settles to the bottom of the tank, and the water, carrying the impurities, passes over the opening at the top of the tank and is carried away by a launder. The sand is discharged automatically at the bottom of the tank.

Automatic Sand Separator

The sand separator is one of the most important parts of a washing plant. A poor one will spoil material in the bins as fast as it is prepared.

The body of the separator is conical in form, suspended from a lever system of scale-beam type, and fitted at the lower or small end of the cone with a discharge valve, fixed to a stem which rises through the center of the cone and is so attached to the lever system as to act with it—the valve opening as the cone descends, and *vice versa*.

Soil water and scoured sand from the screens are delivered into the conical body of the separator. The sand settles to the bottom and gradually accumulates, while the water, soon filling the tank, overflows and runs continuously out of the spill-way, carrying away with it the impurities in suspension.

The poise of the tank, with levers and counterweight, is such that the increased weight due to accumulation of sand in the tank acts to overcome the leverage of the counterweight, causing the valve to open and allow the excess sand to escape to the bin below. The passage of sand continues until the tank is in equilibrium or has discharged the excess weight of sand.

The capacity of a sand separator is governed more by the quantity of water it will be required to handle than by the amount of sand. The 72-in. sand separator will handle up to 1,000 gal. of water per minute.

The 60-in. sand separator will handle up to 650 gal. of water per minute.

Stone and Lime Handling

AT STONE QUARRIES the rock is usually handled to the crushers in some type of a car, usually either of the side dump or end dump type. Where the rock has to be elevated to the crusher, this is frequently done by means of skip buckets, operated by wire rope, or, in some cases, the cars are taken up an incline by means of a rope haul or chain haul. The rock is then delivered to the crusher, and after passing through it is delivered, either by gravity or by some form of conveyor, to a sizing screen. Rock crushers are of the jaw, gyratory or two roll type, most of the large ones being of one of the two latter types, and some of them being capable of crushing 600 tons of rock per hour.

Since the crushed stone is usually deposited in overhead bins, so that it can be loaded by gravity to wagons, trucks, or cars, the screens are located over the bins, and, in most cases, it is necessary to elevate the crushed stone to the screen. The type of machine most used for this purpose is a continuous bucket elevator, the elevator necessarily being of a capacity sufficient to take care of the output of the crusher, unless more than one elevator is used. Some of these elevators are, therefore, very heavy double strand machines with large buckets, and since the service is severe, especially where an unusually abrasive rock is handled, the best possible design and construction must be used, or rapid wear and high maintenance cost will result. The first cost of these machines is likely to be high, but the most expensive in first cost is apt to be the cheapest in the end when operating and maintenance costs are considered.

The screens most used are of the cylindrical rotary type, the material passing over the fine openings first, and then on down over the larger ones. Some of these screens are supported and revolve on shafts of the through type while others have a short shaft at one end, and have the other end fitted with tires which revolve on rollers. The service of the screens is also severe, so that they must be of heavy construction and well designed, with provision for easy replacement of the screen plates when worn.

The bins can be built of wood, steel, concrete, or a combination of these materials, and they can be made of almost any capacity desired, though they are ordinarily used more as loading bins than storage bins, the material not being allowed to remain in the bins for any great length of time, but being taken out almost as fast as it is put in.

In one of the large plants located on the great lakes where bins are provided for loading to vessels, the stone is received from the quarry in self-dumping cars, which deliver it to two crushers where it is reduced to cubes of about 8 in. and smaller. The crushers are located in front of two 30 in. by 60 in. open top carriers, each of which has a capacity of about 800 tons per hour, which elevate the stone and deliver it to small auxiliary bins which are provided with feeders. The stone is fed from the auxiliary storage to any of the revolving screens, located at the top of the tippie. The screens are arranged for making various sizes of stone, and are provided with hoppers so that the stone can be delivered either directly to the various bins of the tippie for shipment in railroad cars, or to either of the two belt conveyors.

Both of the belt conveyors are provided with belt 40 in. wide, troughing idlers of the 5-pulley type, and are 630 ft. centers. Each conveyor has a capacity of 600 tons per hour, running at a speed of 300 ft. per minute, and is

provided with self-propelling trippers for distributing stone in the overhead storage, which constitutes the loading dock. Each belt conveyor is equipped with an automatic weighing device which accurately records the material passing over the belt on its way to the dock.

These conveyors are driven by a high duty belt drive, which has been especially developed for heavy duty belt conveyors.

There are two auxiliary track hoppers equipped with apron feeder conveyors, into which stone that has been stored adjacent to the tippie, can be reclaimed. The stone is dumped into these hoppers and fed to two inclined stone elevators of about 150 ft. centers, each having a capacity of 600 tons per hour. These elevators deliver the stone to the belt conveyors, which in turn deliver it to the loading dock.

Where it is necessary to store a large amount of crushed stone of one or more sizes, an outside ground storage is usually the form of storage adopted as it is less expensive in first cost. Belt conveyors and locomotive cranes are used to a considerable extent for distributing the stone in these ground storage plants, the advantage of the locomotive crane equipped with the grab bucket being that it cannot only deliver the stone to the storage, but can also pick it up again at minimum cost.

The charging of lime kilns, handling coal, drawing kilns, picking core, storing lime and loading it into cars, are, except at a few large, up-to-date plants, all hand labor operations. The labor cost per ton of handling lime in the average plant is entirely out of proportion to the tonnage shipped, when compared with many other kinds of factories producing 50 to 150 tons of material per day.

Stone quarries have the steam shovel, skip cars, crushers, elevators, screens and storage bins, and the finished product is loaded by gravity direct to cars.

Lime kilns, however, are usually drawn by hand, the lime spread on the floor to cool, picked to remove the core, sorted by hand if there is more than one kind of lime, and loaded by wheelbarrows or buggies into box cars. In many places the fine lime is obtained by a process of elimination, being that which is left on the floor after the lumps are removed by hand or fork.

The advancing cost of hand labor has caused several of the more progressive lime manufacturers to look for other ways to get this work done. There is no reason why a lime plant cannot be made a factory, producing a regular output with a minimum of hand labor, using men of a better grade to operate machinery to do the work.

One of the plants illustrated has ten kilns, each of which is equipped with a pan conveyor to draw the lime. A heavy steel lime car, pulled by a rope haul, passes in front of all of the kiln drawing conveyors, which are extended to discharge into the car. A complete draw from each kiln is deposited in the car, which is then pulled by a wire rope to the switch point. Another rope operated by an electric hoist pulls it up an incline, and the self-dumping car drops the lime into the bin. One man in this way can draw the lime from all the kilns in turn, and by transferring at the switch point, can pull the car up the incline and fill the bin, unassisted. The bin is of a long, low construction to eliminate height, and thus cut down the breakage of the larger lumps. By dumping the lime in one end of the bin, and working it back, the drop is reduced to a minimum.

The bottoms of the hoppers of this bin are fitted with gratings, underneath which are plates, and these gratings hold up the larger lumps, and at the same time allow a free passage of air to be drawn through the lime to cool it. This makes it possible to put the lime in the cars very much more quickly than if held in any other kind of storage, or even if piled on the floor, as the lime sometimes comes out of the kilns a dull red, and unless the heat is radiated quickly, the shipment is held up until the lime is cool enough to put into wooden box cars. A 9-in. pitch standard pan conveyor draws the lime out of the bottoms of these hoppers under the bins, and a hinged plate resting on the corrugated pans, maintains an agitation in the bottom of several feet of lime, which keeps it loosened and feeds it uniformly to the pans. As the conveyor leaves the end of the bins the core is picked out by hand, and the lime is discharged to a shaking screen. The screen delivers the fines to a short conveyor delivering to the hydrating plant, and the lumps are delivered to another conveyor at right angles, which in turn feeds a box car loader. In this way it takes but one man to manage the loader, and one man draws the kilns and puts the lime into the bins. This work formerly required eight to ten men in night and day shifts.

A great part of the lime in this plant is shipped in barrels. In order to take care of this, chutes are introduced into the side of the bins, and the lime is fed out in piles on a table for inspection, and taking out of core, and it is then pulled by hand into the barrels which are set along the edge of the table. This results in a minimum of hand labor and no lifting, and materially speeds up the loading of barrels over the time required when shoveling from the floor.

One of the illustrations shows the plant of the Riverton Lime Company, Riverton, Virginia. The plant consists of three gas kilns, the lime from which is drawn on three pan conveyors. It also has five flame kilns, from which the lime is drawn by conveyors. The elevators take the lime up to overhead bins. The lime is all fed from the various bins to two large pan conveyors located in the floor of the shipping room, and the inclined end of this conveyor delivers to shaking screens. The shaking screens deliver the fines to a crusher, the lumps to box car loaders, or run-of-kiln to the box cars, or lumps to barrels.

The installation of the handling equipment in this plant has resulted in a force of six men doing the entire work on the shipping floor, including drawings of kilns, where formerly a gang of from 22 to 24 men were required.

CATALOG SECTION

Containing Specific Information
Regarding the Products and Services
of Leading Manufacturers of
Material Handling Machinery and Equipment

WHITE TRUCKS



Whites are the oil man's choice for the transportation of materials from ears or material yards to the scene of drilling operations. Similarly they handle poles and supplies in line work for power, light and telephone companies.



Five-Ton Whites with dump bodies are ideal for handling any bulk material.



In road building work White trucks with dump bodies handle economically any sort of road materials.



White 3/4-Ton trucks have the easy-riding qualities necessary to handling dynamite and other explosives.



Demountable bodies minimize truck idleness where slow loading is a factor.



White 3-3 1/2-Ton or 5-Ton models with platform or stake bodies are ideal handlers of baled goods of any kind.



Coal, ashes or other bulk materials are quickly and easily loaded and unloaded when White Trucks with power dumping bodies are used.

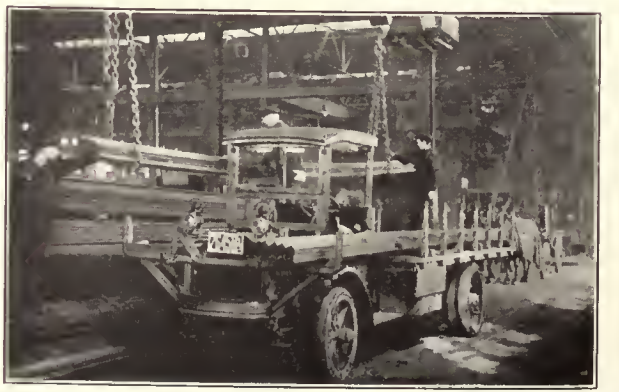

In steel mills and foundries Whites have adapted themselves to the handling of sheet, angles, rods, rails, castings or other products.

THE WHITE COMPANY, CLEVELAND

WHITE TRUCKS



White power dumping trucks are widely adaptable material handling units.



The White winch which may be had on 2, 3-3/4 or 5-ton models saves time and man-power in handling materials which have both bulk and weight. Above, an oil field boiler is being loaded upon a 5-Ton White with platform body.



A White 5-Ton truck equipped with White winch and cross-haul loading equipment reduces the loading time in logging from 60 or 70 minutes to as low as 20 minutes.



White trucks of all four capacities—3/4-Ton, 2-Ton, 3-3/4-Ton and 5-Ton—can be had with stake bodies, ideal for handling barrels, drums or casks.



White 2-Ton, 3-3/4-Ton and 5-Ton trucks meet every requirement for the transporting of lumber.

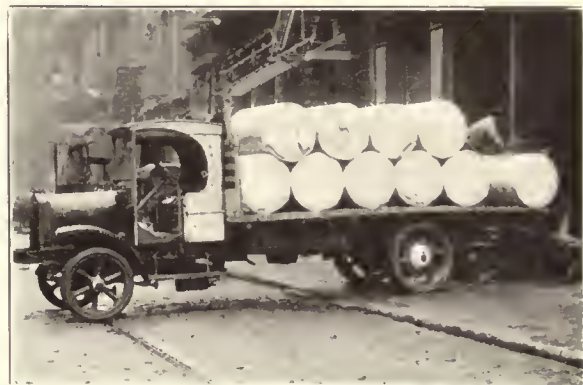

White 5-Ton trucks with stake or platform bodies easily handle newsprint or similar material.



Handling of wire and cable is a simple task with White winch equipment on the 2-Ton truck.



The 2-Ton with stake body serves tobacco factories, textile mills, bag, box and novelty makers and allied industries.

THE WHITE COMPANY, CLEVELAND

HOLT "CATERPILLAR" TRACTORS

The "Caterpillar" Tractor

The "Caterpillar" Tractor is pre-eminently a road locomotive. It is a self-contained railway—that lays its own track, travels over it, and picks it up again.

Hauling power without traction is waste. The "Caterpillar" does not waste power through slippage—the tracks providing positive traction under even severe conditions. Yet the "Caterpillar" may be operated continuously over improved roads or paved streets without damage to the surface.

Types

Holt "Caterpillar" Tractors (the only "Caterpillar" Tractors) are built in the following sizes: 5-ton, 10-ton and 20-ton. The 5-ton furnishes 3,100 lbs. drawbar pull at 3 miles per hour, the 10-ton 5,000 lbs. pull at 3 miles per hour, the 20-ton approximately 11,000 lbs. pull at $2\frac{1}{8}$ miles per hour.

In the Lumbering Industry

Investigation and study of all the various logging methods have convinced many of the largest lumber companies that "Caterpillar" Tractors provide the cheapest and most reliable hauling power ever applied to the logging industry. Hauling a heavy tonnage of logs to the mill depends



Holt "Caterpillar" keeping the mill running throughout the year

primarily upon traction, and "Caterpillar" freighting outfits solve that problem completely. Teams, motor trucks, temporary railroads and other methods are fast being replaced through better performance of "Caterpillar" Tractors. For winter logging over snow and ice roads, the 5-ton and 10-ton models have the power, the speed and the endurance for handling this most difficult work in a far more economical and more satisfactory manner than has ever been possible to obtain through ordinary methods.

In the Oil Industry

Nowhere is the problem of transportation so acute; nowhere is the ability to deliver so important as in the oil-producing districts. The rainy season turns the roadless country or the roads themselves into seas of mud, tying up every



Holt "Caterpillar" hauling 36 tons of casing direct to location

kind of traffic, except "Caterpillar" outfits. They haul continuously where no other motive power or horses can work. The elements of certainty and economy which only "Caterpillar" Tractors can produce are revolutionizing oil-field transportation. The Texas, Sinclair, Empire, Texas-Pacific, Gulf and many other large companies have adopted the "Caterpillar" method for heavy haulage in this most strenuous field.

In Overland Hauling

In a continuous overland hauling project, teams at best are slow, expensive, and have limited periods of operation. Motor trucks depend upon speed but require uniformly good roads. Wheel tractors, regardless of rated power and speed, can be used only on solid surfaces. In contrast, the "Caterpillar" puts the equivalent power of dozens of horses under the easy and constant control of one operator; continuous operation is insured day or night in any season of the year. Bridges that are unsafe for other tractors can be traveled over without risk by the "Caterpillar," and the smooth-running, spring-mounted track does not damage improved highways.

Road Building

In road building the "Caterpillar" will move more dirt per day and do it cheaper than can be done with animals or with an ordinary traction engine. Hauling road materials is a problem of total tonnage per day, and not speed per load. The "Caterpillar" can be counted upon to haul heavy loads even when the weather may prevent the rest of the road crews from working. It is this certainty of operation



Holt "Caterpillars" replacing 25 horses

THE HOLT MANUFACTURING COMPANY

PEORIA, ILL.

50 CHURCH ST., NEW YORK

STOCKTON, CAL.

HOLT "CATERPILLAR" TRACTORS



Holt "Caterpillar" Power Is Ideal for Pulling Road Machinery.

that makes the "Caterpillar" a profitable investment for any road contracting job.

For grading, leveling, dragging and other kinds of road-building operations, the "Caterpillar" has an unmatched record for endurance and economy. Its ability to turn short, to pull the largest-sized implements and graders, to operate in narrow cuts, and to work continuously without being handicapped by soil or weather makes it a vital piece of equipment in this work.

Farming and Sugar Cane Hauling

The "Caterpillar" applies the effectiveness of the railroad locomotive in farm, plantation, and sugar cane hauling. In sugar plantation work the railroad must be shifted as section after section is cleared. This involves many time-consuming operations. The "Caterpillar," on the other hand, lays its own line and grade as it travels along, and rolls up the track as it passes on. The endless tracks bridge all the inequalities in the ground. With "Caterpillar" trailers, a complete cane-hauling outfit is provided.

Plant

The two big Holt Plants, at Stockton, Cal., and at Peoria, Ill., have scientifically developed facilities for quantity and quality production. They are equipped with the finest machine tools obtainable and every "Caterpillar" part is subjected to the most exacting inspections. Over a dozen years of strenuous service have brought refine-



5-ton Holt "Caterpillar" hauling plant refuse

ment of design but "Caterpillar" Tractor performance is a result of the development of a fundamentally correct principle.

Typical Specifications

The following specifications of the 10-ton "Caterpillar" are typical of the other types with the exception of general dimensions. Length 143", width 81", height 103", length ground contact 96", ground clearance 17", tread of track 61", weight approximately 19,000 lbs.

Motor—4 cylinder, 4 cycle, valves in removable cylinder heads; 6½" bore, 7" stroke. Power capacity—40 drawbar H.P. at 3 m.p.h. Cooling—gear driven, centrifugal waterpump; sectional spiral finned copper tube radiator. Ignition—high tension magneto, impulse starter. Lubrication pressure system. Motor control—standard centrifugal throttling governor. Valves, chrome nickel steel. Crankshaft—heat treated high carbon steel, drop forged; five main bearings. Piston—gray iron—wrist pin bearings, cast bronze. All crankshaft bearings babbitt lined—removable.

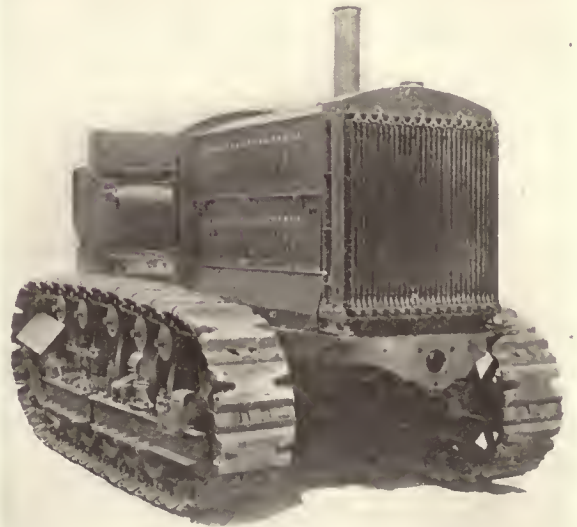

Holt 10-ton "Caterpillar" Tractor

Master clutch—multiple disc type—accessible—adjustable. Drive—three speeds forward and reverse; transmission of standard selective type. Two spur gear reductions from steering clutch to drive sprockets. Steering control through clutches and side brakes, no differential. Ball and Hyatt bearings. All shafts and gears of nickel steel, heat treated. Gears cut from forgings.

Truck rollers, six on each side, spring mounted on two separate trucks. Track idler on front frame. Hinged sectional roller frames enable tracks to conform to unevenness of ground and insure positive traction. Track, solid cast steel link 15" wide—case hardened bushings. Equipped with quick removable lugs. Main frame—solid cast open hearth steel. Power pulley located at rear of machine for 9" belt to operate at 3100' per min. belt speed. Speeds 3 forward, one reverse—1.67, 3.00, 4.78, and 1.25 miles per hour, respectively.

THE HOLT MANUFACTURING COMPANY

PEORIA, ILL.

50 CHURCH ST., NEW YORK

STOCKTON, CAL.

ELECTRICAL EQUIPMENT

PRINCIPAL WORKS OF GENERAL ELECTRIC COMPANY

Schenectady, N. Y.
Newark, N. J.

Lynn, Mass.
Watessing, N. J.

Pittsfield, Mass.
Erie, Pa.
Cleveland, Ohio
Bridgeport, Conn.

Harrison, N. J.
Fort Wayne, Ind.

ADDRESS THE NEAREST DISTRICT SALES OFFICE

Alabama, Birmingham
Arkansas, Little Rock
California, Los Angeles
California, San Francisco
Colorado, Denver
Connecticut, Hartford
Connecticut, New Haven
District of Columbia, Washington
Florida, Jacksonville
Georgia, Atlanta
Illinois, Chicago
Indiana, Fort Wayne
Indiana, Indianapolis
Indiana, Terre Haute
Iowa, Des Moines
Kentucky, Louisville
Louisiana, New Orleans
Maryland, Baltimore

Massachusetts, Boston
Massachusetts, Springfield
Massachusetts, Worcester
Michigan, Detroit
Michigan, Jackson
Michigan, Grand Rapids
Minnesota, Duluth
Minnesota, Minneapolis
Missouri, Joplin
Missouri, Kansas City
Missouri, St. Louis
Montana, Butte
Nebraska, Omaha
New Jersey, Newark
New Jersey, Trenton
New York, Buffalo
New York, Elmira
New York City

New York, Niagara Falls
New York, Rochester
New York, Schenectady
New York, Syracuse
North Carolina, Charlotte
Ohio, Cincinnati
Ohio, Cleveland
Ohio, Columbus
Ohio, Dayton
Ohio, Toledo
Ohio, Youngstown
*Oklahoma, Oklahoma City
Oregon, Portland
Pennsylvania, Erie
Pennsylvania, Philadelphia
Pennsylvania, Pittsburgh
Rhode Island, Providence
Tennessee, Chattanooga

Tennessee, Knoxville
Tennessee, Memphis
Tennessee, Nashville
*Texas, Dallas
*Texas, El Paso
*Texas, Houston
Utah, Salt Lake City
Virginia, Richmond
Washington, Seattle
Washington, Spokane
Washington, Tacoma
West Virginia, Bluefield
West Virginia, Charleston
Wisconsin, Milwaukee

*Southwest General Electric Company

Distributors for the General Electric Company Outside of the United States

INTERNATIONAL GENERAL ELECTRIC COMPANY, INC.

120 Broadway, New York, N. Y.

Schenectady, N. Y.

83 Cannon Street, London



G-E Products

The name General Electric Company on an electrical device is a guarantee of quality founded upon more than a quarter century's experience in the manufacture and application of electrical machinery. The thousands of G-E products in use in all parts of the world comprise practically every kind of apparatus and machinery used in the generation, distribution and use of electrical energy.

It is entirely practicable, therefore, to standardize with G-E equipment. By this procedure all parts interrelate. The advantage of having all electrical equipment built by one company and made ready for immediate installation is obvious.

Handling Material Electrically

Whenever the cost of any single element of distribution, such as unloading of boats, piling for storage, unloading trucks, etc., rises above a fair normal, it becomes a tax on business which the ultimate consumer must pay. Production as well as distribution costs can be materially reduced by the application, wherever possible, of electrically operated machines for mechanical handling.

In many industries there is an opportunity for the introduction of further economies by the judicious use of modern electrically operated material handling machines. It has been demonstrated in numerous installations at terminals, and in industrial plants handling a wide variety of materials, that electrically operated and controlled equipment is the most flexible, most rapid and most dependable of material handling machinery.

The electrically operated mechanical appliances for material handling include equipment for unloading ores

and coal from ships and cars; bucket and belt conveyors, and elevators, cranes, industrial locomotives, tractors and trucks for distributing materials within the plant; conveyors, elevators and stackers for handling bags, barrels, boxes, cans, cartons and package materials of all kinds. It is possible on the following pages to illustrate only a few of the hundreds of interesting installations of this character using G-E electrical equipment.

Co-operative Service

The manufacturer of material handling machinery assumes a responsibility as relates to the machine he manufactures and the results attributable to the electrical equipment used. On the electrical manufacturer properly rests the responsibility of initially recommending the most suitable motor and control, thus assuring maximum service and overall benefit to both machine manufacturer and user.

Two thousand five hundred leading machine manufacturers in widely diversified lines—many to the extent of exclusive standardization—use G-E motors. When you submit your material handling problems to a manufacturer of this equipment, specify G-E electric motors and control. The inherent motor values plus the practical ability and technical knowledge available in connection with their application eliminate chance or experiment.

The General Electric Company maintains a corps of engineers specializing on problems of this kind, whose services are at your disposal to co-operate with machinery manufacturers and to assist in the design of new installations, or in the electrification of your present material handling equipment. To avoid delay address communications to the nearest G-E office.

GENERAL ELECTRIC COMPANY, SCHENECTADY, N. Y.

Address nearest office. For list of offices see above.

ELECTRICAL EQUIPMENT FOR BULK HANDLING

Electricity in Bulk Material Handling

One of the most significant facts in connection with the rapid industrial progress during the last 50 years is the intimate part electric power has played in every phase of that advancement.

Electricity has contributed fundamentally to those new methods and processes which have conserved labor, cut costs, and saved time.

Particularly is this true of the improved methods for handling bulk materials. The modern machinery which the existing need demanded owes a large measure of its success to the speed, simplicity and flexibility of operation afforded by its electrical equipment.

Since the earliest steps in the development of bulk material handling machinery, the General Electric Company has been called upon to develop and manufacture the electrical apparatus for driving and controlling the mechanical appliances of this class. Thirty years have been spent in this development. During this period capacities have increased from the amount which could be handled manually to a capacity of 1,000 or more tons per hour.

Applications of G-E equipment to such service are portrayed in Bulletin 48026, mailed on request.



Coal Loading Pier—Machinery Driven and Controlled by G-E Apparatus.

Driving and Controlling Unloaders

Electric motors and control devices are used for every function of the automatic unloader illustrated herewith. Provided with G-E equipment throughout, this type of unloader is one

of the most successful devices ever constructed for handling ore cargoes from lake steamers. Although of immense proportions, the operation and control of such machines are extremely simple.

G-E motors supplied for this service are usually of the mill type. These are of strong construction, designed for just such services, giving them a dependability which fits them admirably for the heavy duty they are required to perform. Described on page 712.

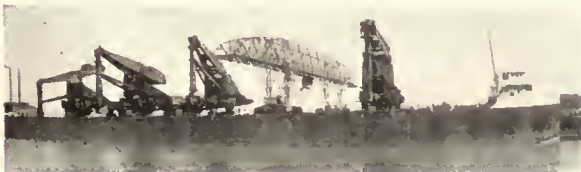

15-Ton Unloaders and Ore Bridge Operated by G-E Equipment.



Electrically Operated Gantry Crane Handling Ore.

Derrick Applications

Electric derrick hoists are particularly useful in the contracting and construction field for excavation, quarrying and concrete construction. G-E direct current, series wound, and alternating current hoist motors are widely used in this service. They are applied for handling three motions—boom lifting, swinging and raising of the load. Control is centrally located so that the operator can handle all motions from one position.

Electrically Operated Car Dumpers

Electrical equipment used on car dumpers is required to handle high peak loads, and to provide for dynamic braking. The car dumper is used in discharging the contents of open-top freight cars by turning the whole car sidewise about its longitudinal axis, dumping its contents into boats, bins or storage yards. G-E mill type motors are used also for operating machinery of this class. These motors are described briefly on page 712.



G-E Motors and Control Operating 100-Ton Car Dumper.

GENERAL ELECTRIC COMPANY, SCHENECTADY, N. Y.

Address nearest office. For list of offices see opposite page.

ELECTRICAL EQUIPMENT FOR WINCHES AND CONVEYORS

G-E motors and control equipment can be supplied for the operation of all types of material handling machinery. The same engineering skill which developed and built electrical apparatus and control for this massive equipment is available for every other electrical handling equipment design.

To supply the demand for extra power occasioned by the use of such machines as car dumpers, the General Electric Company is prepared to furnish complete substation equipment which includes transformers, motor generator sets, rotary converters, switchboard apparatus and all of the smaller devices necessary to complete the substation.

Electric Drive for Winches

Electric winches are finding useful application, especially for handling cargoes, either installed on the ship or made portable for use on the dock. Vertical winches are widely used for car pulling in freight yards and on sidings.

For use on winches the General Electric Company normally supplies either DC series wound or polyphase motors. Ordinarily the motor is geared to the winch head through a double reduction.

For winches used on level track pulling, a single speed controller is used, operated by a foot lever. Where grades are involved a controller for variable speed is supplied.

Conveying Electrically

Electric power is ideal for conveyor drive. Cleanliness, compactness, and freedom from heat and gases make the electric motor particularly adaptable for this drive. Where portable conveyors are used arrangements are easily made for connection with the power line. G-E motors and controllers are widely used for conveyor work on both outdoor and indoor installations.

In the assembling processes on machine parts, furniture, automobiles and many other products, the electric conveyor is the very backbone of production efficiency. Electrically operated conveyors are also extensively used in conjunction with other equipment for heat-treating glass-ware and steel; cooling castings and chemicals; drying clay products and enameled ware; roasting ores and foods; inspecting and picking coal, ore and fruits; and for transporting all sorts of bulk and package material.

Motors for Bucket Conveyors

In connection with cement mixers, crushers and screens on road building work, electric portable conveyors of the bucket type are widely used. Materials varying from non-gritty quality to hard substances, and in size from dust to 4½-inch cubes may be handled economically in this way. A 10-h.p. motor will enable an elevator type of conveyor to move 60 tons of sand per hour on an 80-foot lift.

In power plant work electrically driven conveyors of the bucket type are used extensively for handling coal and ashes. In granaries, fertilizer plants, and coke oven installations, this class of material handling machinery is also used extensively. In moving ore and coal incidental to its storage these conveyors have an equally wide field.

For service of this sort the driving motor must be capable of exerting high starting torque. Where atmospheric conditions are severe special G-E motors can be furnished with protection against damage from dust and dirt. G-E reversible motors are particularly adaptable to portable conveyors for wagon and car loading, since by reversing the motors the machines may be converted into unloaders.

Electric Drive for Belt Conveyors

Electric motors are used for driving belt conveyors of practically all types. Low power consumption is one of the economical features of electric drive on these machines—a factor which is supplemented by convenience and reliability. No experience is required to enable a workman to operate an electrically driven belt conveyor.

In conjunction with electric overhead trolleys, electric conveyors are used extensively for progressive assembly in large manufacturing plants. By means of the electric trolleys, heavy parts are carried to the point of assembly, and the progressively built product proceeds on the conveyor. Some electrically driven conveyors of this type are more than 700 feet in length.

Electric belt conveyors are used also for conveying loose bulk materials horizontally or up inclines. The reserve capacity of G-E motors fits them for the varying conditions.

G-E motors and control have been successfully applied to belt conveyors in many industries. Constant speed motors, direct or alternating current, are generally applicable. These are described on page 713.

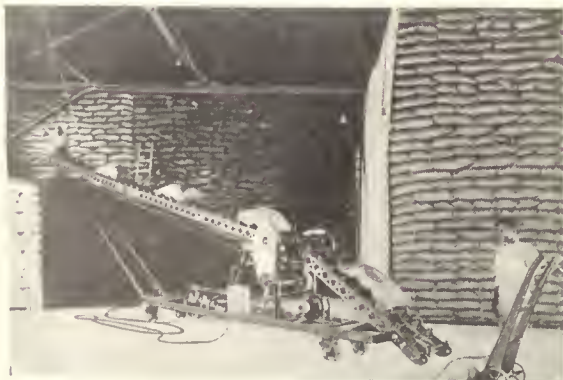

Portable Bag Stacker Driven by 5 H. P. G-E Motor.



Electrically Operated Belt Conveyor and Loading Boom at Coaling Pier.

GENERAL ELECTRIC COMPANY, SCHENECTADY, N. Y.

Address nearest office. For list of offices see page 706.

ELECTRICAL EQUIPMENT FOR SHOVELS AND CRANES

Electric Traveling Cranes

In no field of material handling machinery has electricity had a more prominent part than in the development of overhead traveling cranes. G-E motors and control devices are peculiarly adapted to handle the problems of precise motion and high starting torque which characterize this class of machinery.

Electric traveling cranes render vital industrial service in various and diverse ways. Equipped with buckets, they handle such materials as crushed stone, slag, sand, gravel, and lime. In conjunction with an electric magnet scrap iron may be handled, as well as castings, car wheels, etc. Equipped with hook and sling, huge crucibles, hot ingots, heavy castings, locomotives, plates, and heavy crates can be moved with ease.

Three G-E motors are usually supplied for each crane to furnish power for lifting, traveling, and traversing. These motors, both A.C. and D.C., are described more fully on page 712.

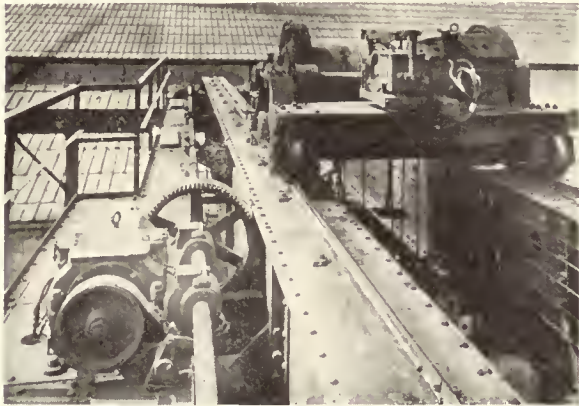

10-Ton Yard Crane Equipped with G-E Motors.

Electrically Operated Shovels

The electric shovel is a new development the possibilities of which are being recognized more and more, especially by quarrying and mining companies. The present high prices of coal, shortage of labor and general need of economical and increased production are causing many companies to adopt large electrics in preference to steam shovels. The success of the larger shovels in stripping has led to their development in other fields for excavating and loading directly into dump cars. For this work the large shovels are especially applicable, due largely to the greater amount of material available in front of the shovel at one setting.

Electrically operated shovels, equipped with G-E motors and control are rendering excellent material handling service under a wide range of conditions. In coal and iron mines these machines are meeting the demands for heavy, faithful service in a big way. And on the big irrigation projects the machine is equally valuable, handling heavy drag line work as well as the digging and loading functions more generally demanded of the machine.

The General Electric Company has furnished complete electrical equipment for some of the largest shovels now in operation. This machinery consists of

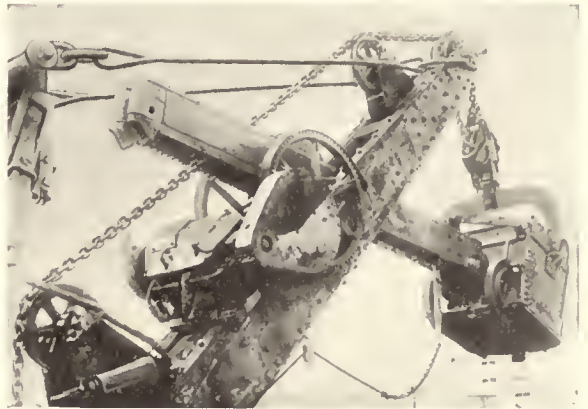

Crowding Motor and Controller on a 65-Ton Electric Shovel Equipped with Four G-E Motors.

motor generator sets, motors for hoisting, swinging, crowding and tripping, together with a variety of control equipment. G-E series direct current motors are furnished for this service in conjunction with differential wound generators with voltage control. Progress is constantly being made in the perfection of electrical control for shovels which is destined to make their advantages even more significant in the future.

Problems regarding the application of electric shovels should be taken up with the nearest G-E office.

Electric Drive for Elevators

Modern freight elevator service owes its smooth acceleration, speed, and convenience to its electrical equipment. The nicety of elevator control is due directly to the adaptability of electric power to this class of service. In warehouse and factory installations it is sometimes desirable to control the movement of a car from the various floors. Push button control furnished for such work obviates the necessity of an operator.

Ordinarily the safety brake operating on a large drum directly connected to the driving motor shaft is spring applied. This brake is released by the passage of current through an electric magnet and is reset the instant the current ceases to flow, which insures protection against accident in case of failure of power.

The General Electric Company has developed both constant speed and variable speed motors for elevator service, using either direct current or 3-phase or single-phase alternating current. Various types of single speed

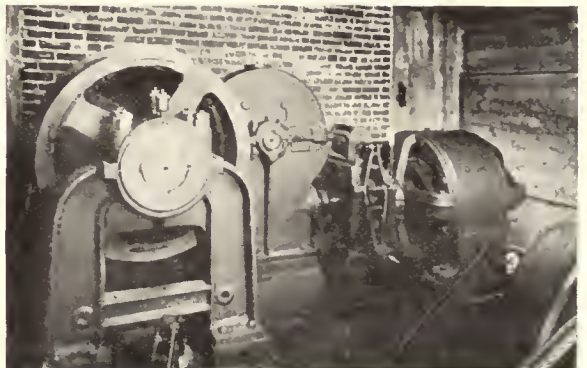

G-E Motor Driving Freight Elevator.

GENERAL ELECTRIC COMPANY, SCHENECTADY, N. Y.

Address nearest office. For list of offices see page 706.

ELECTRICAL EQUIPMENT FOR INDUSTRIAL TRUCKS

elevator motors manufactured by this company are described briefly on page 713. For information on 2-speed elevator motors it will be necessary to communicate with the company's general office.

Two main types of control are used; semi-magnetic in which reversing is accomplished by a mechanically operated drum type reversing switch, and full-magnet in which reversing is accomplished by directional contactors from a car switch installed in the elevator cage. The semi-magnetic control cannot be used on elevators at speeds above 100 feet per minute, according to A.S.M.E. rules.

G-E Motors for Trucks and Tractors

Electrically driven industrial trucks of the platform and elevating types are particularly fitted for handling material in and about buildings where fixed routes are undesirable. The electric industrial truck makes it possible to move material wherever there is a floor or paving surface. The elevating truck adds to the functions of the platform truck the ability to pick up and set down the load, even at higher elevations, and to place material with precision.

G-E propelling motors for industrial trucks can be mounted on one axle, or amidships for 4-wheel drive. The automotive motor used for this work is a series wound, heavy duty, totally enclosed machine characterized by its capacity for heavy overloads. For further information on these motors, see page 714. G-E control devices used on these machines include drum type controller, circuit breaker and lift switch.

The General Electric Company is in a position to supply also all battery charging equipment, including plugs and receptacles, necessary in the operation of battery-propelled vehicles, as well as storage battery locomotives. This equipment is described more fully on page 717.

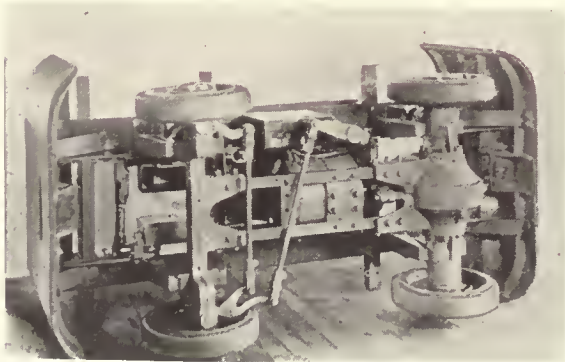

Electric Industrial Truck Showing Motor Mounting.

Dump and Crane Type Electric Trucks

G-E motors and control devices make the dump body type of electric industrial truck particularly convenient for handling loose materials, such as coal, ashes and small castings. Frequently these trucks are so arranged as to permit either side or end dumping, both actions being electrically operated and controlled by the operator of the truck from his normal position.

Electricity plays an equally important part in helping the crane type of industrial truck to deliver a maximum handling service. A small electrically operated crane is mounted on the truck and its use makes it possible to extend the service of traveling or monorail cranes to points not covered by their supporting rails. This type of truck will deliver castings from yard to machines, heavy cases to freight cars or assembly points, etc. Capacities up to 3,000 lbs. are within the range of this type of truck.

Electric Tiering Trucks

The tiering type of electric industrial truck is a combination of the load-carrying truck and the tiering machine. By virtue of its electric motors and the convenient control provided, this vehicle will pick up its load, transport it to any desired point, and elevate it to points six feet or more above the floor level. Two G-E motors are supplied for trucks of this sort,—one for traction and one for elevating.

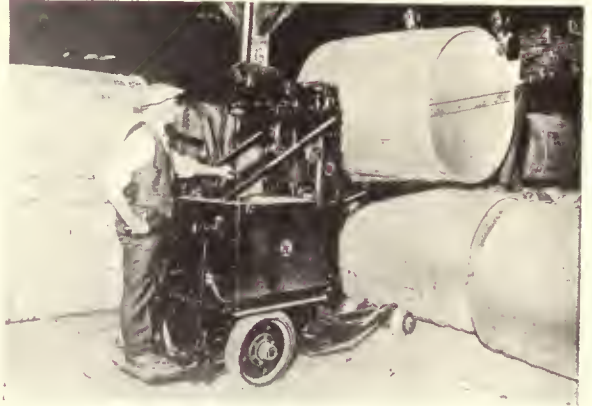

Electric Lift Truck Doing Work of Eight Stevedores Piling Hogheads.

Electric Tractors

Electric motors supplied for use on industrial tractors require careful design and construction to provide for the heavy overloads to which they are subjected on starting. The G-E series automotive motor is particularly designed for this service. G-E equipment furnished for machines of this class includes in addition to motors, con-



G-E Equipped Electric Tractor Handling Foundry Sand

GENERAL ELECTRIC COMPANY, SCHENECTADY, N. Y.

Address nearest office. For list of offices see page 706.

ELECTRIC CONTROL EQUIPMENT

trollers and circuit breakers. The control circuit is usually arranged to provide against accidental starting.

The design of G-E motors and electrical equipment supplied for use on tractors, like many other G-E products, is based on intensive study of the service which it is called upon to perform. Specialists are available for the analysis of every electrical problem.

Importance of Proper Control

The importance of control equipment in the successful electrification of most material handling processes should not be under-estimated. As stated in connection with the brief descriptions of the few G-E installations shown on the preceding pages, electric control equipment has immeasurably increased the scope of mechanical handling. It has simplified the operation of the most massive machinery. The controlling apparatus not only makes the motor function properly but can be made to protect it as well as the operator and the machine.

To automatic control may be credited the ability of modern material handling machines to empty more cars per hour, or to load and unload boats more quickly, by the elimination of every second of wasted time.

Adaptations of Manual Control

The simplest starting apparatus is sufficient for starting up small motors which run continuously. For larger motors driving constant speed machines, involving no special functions such as reversing, change of speed, braking, etc., the ordinary starting compensator, starting rheostat or drum controller is ample.

Possibilities of Automatic Control

The field of magnetic control equipment is practically unlimited. It is the basis of automatic control and the principal means of providing protection to men and machinery. It is the magnetic equipment which "does the thinking" on the job, thus providing that element of electrical control which may be characterized as human.

Automatic control actuated from various points cuts down operating costs. It enables the operator of a

modern ore unloader to ride with the leg and bucket down into the ship and, while retaining individual control of the entire machine, to control the bucket with such precision that nearly 100% of the cargo is unloaded without the use of shovelers. It eliminates attendants as in moving material with a series of conveyors, one dumping onto another, where a system of electrical interlocking prevents piling up the material at some intermediate point in case one conveyor stops.

Automatic control means economic handling in the sense that it speeds production. It makes possible the maximum safe rate of acceleration and deceleration with consequent maximum average speeds. Long time delays for making repairs are reduced to a minimum by equipment that stops the motor the instant one part fails to function properly. Quick, sure stops are also an asset as in the case of a car dumper which, by virtue of its control, places the empty car accurately on the track ready to be pushed away.

G-E Control for Every Purpose

Due regard for what can be achieved with ample control such as mentioned briefly above bespeaks the importance of proper consideration of this part of the electrical equipment of any material handling machine. The General Electric Company out of experience gained in extensive design and manufacture of motor controlling equipment and in years of application engineering, has evolved a complete line of standardized apparatus for material handling operations.

This company is, therefore, in a position to supply readily control apparatus for ordinary drives. Where special problems are involved, it can do the development work necessary to coordinate the entire electrical equipment. As evidence of thorough familiarity with electrical control problems, G-E automatic control is identified with many electrical systems. It has been successfully applied also in generating and distributing systems for railway, power and industrial service.

In recognition of the value of reliability in service, major attention is given to quality, and those parts necessarily subject to wear are made easily renewable.

It is obviously impossible to describe on these pages, even briefly, a significant portion of the G-E control equipment applicable to material handling. Some of these devices are enumerated in connection with the motors shown on the pages following. Requests for complete information are welcomed at the nearest G-E sales office.

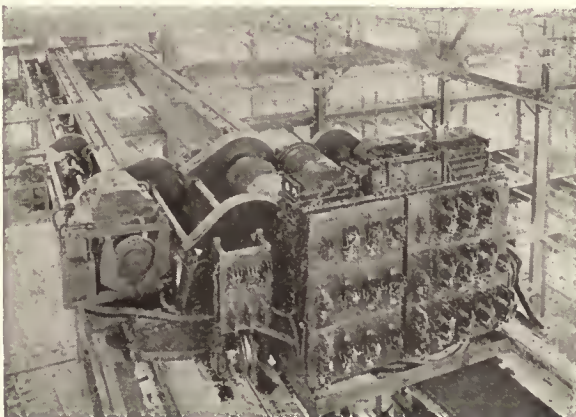

G-E Automatic Control on 15-Ton Grab-Bucket Crane.



150-Ton Crane Controlled by G-E Magneto Equipment

GENERAL ELECTRIC COMPANY, SCHENECTADY, N. Y.

Address nearest office. For list of offices see page 706.

HEAVY DUTY ELECTRIC MOTORS

Wide Range of Motor Manufacture

As a result of long experience in applying electric power to the various industries, there is a standard G-E motor suited for driving most material handling machines, such as enumerated on the preceding pages, while a special motor and control equipment can be provided to accomplish an unusual service.

For the benefit of manufacturers and engineers a brief description of the principal motors used for material handling machinery is given.

Mill Type Motors

G-E mill type motors, although primarily designed for driving steel mill auxiliaries, are admirably adapted for application to several material handling machines, including

heavy duty cranes, coal and ore bridges, unloaders and car dumpers; charging machines of all types as used in gas works and coke plants; coke pushers, levelers, etc.; electric shovels, electric dredges and small, heavy duty hoists. The chief characteristics of this type of motor are heavy mechanical design, large foundation area, ease of replacing parts and making repairs, small stored energy in the armature, good commutation and heat resisting insulation.

These motors are made in two general Types, M.D.

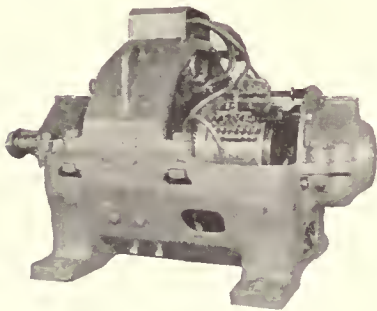

G-E Mill Type Motor.

for D.C. and Type M.I. for A.C. operation. The D.C. motors, described fully in Bulletin 48121.1, are standard with series or compound fields. They are built open and enclosed, the enclosed type having a large opening with cover in the frame to give ready access to the commutator and brushes, and other frame openings for inspection of the armature and field coil connections. The open type differs only in the upper half being entirely open, all essential dimensions being the same, making the two frames interchangeable on the same foundations. All MD motors are equipped with commutating poles which insure excellent commutation under all rated loads.

Mill type motors are furnished totally enclosed in sizes from 3 h.p. to 150 h.p. for 25-cycle, 200- and 440-volt alternating current, 4 to 175 h.p. and 230- and 550-volt direct current. Open type motors are furnished from 25 h.p. to 150 h.p. alternating current and 30 h.p. to 210 h.p. direct current for continuous duty.

This Company is prepared to furnish control either manually or magnetically operated for all classes of service to which the mill type motor can be applied. This equipment includes drum type controllers for reversing or non-reversing, and starting or speed regulating duty; master switches for use with magnetic control; control panels, resistors especially designed to withstand vibration; and also electric brakes, described briefly on the following page.

A.C. Variable Speed Hoist Motors

Alternating current hoist motors are made 3-phase or 2-phase, with standard riveted frame and skeleton frame construction. They give a maximum torque for a given weight

and are very strong mechanically; used for hoists and similar service of an intermittent nature where the limiting feature depends upon the frequent starting and accelerating torque required. These motors are regularly furnished with open frames and taper shafts on each end for gear and solenoid brake. Made in standard capacities of 1 to 300 h.p.; 60 and 25 cycles.

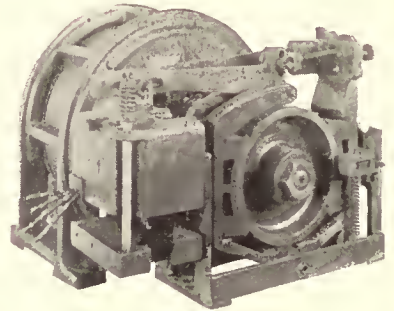

A.C. Hoist Motor Equipped with Solenoid Brake.

Drum type controllers are regularly recommended to control these motors

for capacities up to 112 h.p. For motors of large capacity, the magnetic type of control is used. Information can be obtained by addressing the nearest G-E office. Send for Bulletin 48119.1.

Direct Current Crane and Hoist Motors

The G-E Type CO 1800 line of motors are designed especially for variable speed crane and hoist service as applying to bridge and cargo cranes, winches, derrick hoists, ore bridges, unloaders, etc. These are D.C. motors, enclosed reversible and series wound, designed for intermittent service requiring a maximum torque motor

of ample overload capacity. Suitable for floor, wall or ceiling mounting and furnished with or without back gear. The top half frame can be lifted off without disturbing back gearing, armature is readily removed, the shaft can be removed without disturbing windings or commutator. All the parts are arranged for easy inspection or repair.

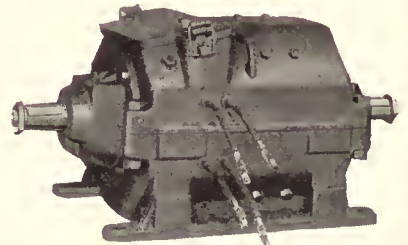

CO 1800 Crane and Hoist Motor

Sizes range from 2 h.p. to 100 h.p. standard voltages. Described in Bulletin 68100A.

Complete lines of drum type controllers and magnetic equipments are available for all classes of hoisting service. G-E crane protective panels, which provide overload and underload protection, protect also the motors which are individually controlled by other equipment.

Electric brakes for controlling hoisting motors to insure a quick positive stop can also be supplied. These are described briefly on the following page and more fully in Bulletin 68010 A.

GENERAL ELECTRIC COMPANY, SCHENECTADY, N. Y.

Address nearest office. For list of offices see page 706.

Automatic Electric Brakes

G-E Solenoid Brakes for use with either A.C. or D.C. G-E mill type and hoist motors, are designed for quick stopping. They are usually mounted on the driving motor shaft, although if desired, they can be furnished for mounting on the floor or other foundation. For use with motors of other than G-E manufacture, proper end shields and brake pads must be provided. Capacities from 1 to 300 h.p. standard voltages. Six sizes of brakes are available, providing a range in braking torque from 5 to 3,500 lbs. at 1 ft. radius.

These brakes are used extensively in connection with cranes, hoists, elevators, line shafting, etc., to save time in stopping, to prevent over-travel or to stop accurately at definite points; to hold loads without consumption of power by the motor; and to make emergency stops. Described in Bulletin 68010A.

Induction Motors

The Type KT Induction Motor is the general utility motor for alternating current, especially for services requiring constant speed, such as conveyors of different types and portable elevators. This line of G-E motors is made in riveted or skeleton frames up to 750 h.p. standard voltages.

The multi-speed types are wound for 60 cycle, 3-phase circuits only, 220, 440 and 550 volts, and can be furnished up to 12 h.p. for four constant speeds. Described in Bulletins 41302A and 61300A.

Various types of starting and controlling equipment for use with these motors can be furnished, including oil circuit breakers and safety switches for the feeder circuit; magnetic starting switches; compensators, automatic or manually operated; starting panels; and remote control accessories, such as push buttons, automatic switches and governors, for use with automatic starters.

Synchronous Motors

The G-E line of synchronous motors covers a wide range of speeds and capacities. Their application to material handling processes is confined to the machinery requiring constant speed, such as conveyors, pumps for moving liquids, etc., for which they are extensively used. In addition, this type of motor is especially desirable on circuits which need power factor correction. This condition is often indicated by the need for greater generator, transformer or feeder capacity. Synchronous motors are particularly desirable when a rate for purchased power is dependent upon the power factor of the load.

The synchronous motor is also applicable where continuity of operation is imperative and dusty operating

conditions make a motor with a small air gap inadvisable.

These motors are furnished from 25 to 2,000 h.p. capacity at commercial speeds, for belt drive or direct connection, and are designed to start any load met with in ordinary practice. Special winding makes them self-starting from an A.C. compensator which can also be furnished. Described in Bulletin 41309, and Bulletin 41310 gives a list of hundreds of G-E installations in various industries.

D.C. Constant Speed Motors

The Type RC motor may be classed as the universal D.C. motor and, hence, is applicable to material handling devices operating at constant speed where direct current is available. Furnished shunt wound for conditions requiring close speed regulation, compound wound for heavy starting torque or where violent power fluctuations occur, and series wound where load either possesses fixed value or may be subject to automatic or manual control. Series motors not recommended for belt drive.

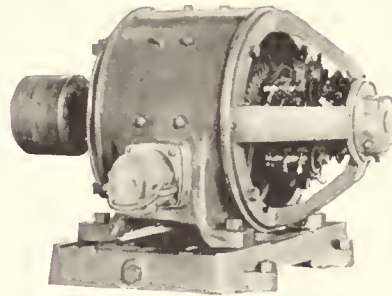

Type RC Constant Speed DC Motor.

Made in sizes ranging from 1/2 to 200 h.p. Regularly furnished for floor installation but can be arranged for wall or ceiling suspension. Construction details are given fully in Bulletin 41013A.

G-E control equipment includes all of the devices regularly used for starting and controlling motors of this type as well as accessories necessary to control from remote points. Complete information can be secured by addressing the nearest G-E sales office.

Elevator Motors

Squirrel cage induction motors supplied for elevator service are built with a high resistance rotor winding to insure a maximum torque at starting, which is approximately 250% of full load running torque. These motors are designed to be thrown directly across the line and are furnished for either 3-phase or 2-phase. Semi-magnetic or full magnetic control is used, either of which can be furnished with or without overload protection.

Slip ring type induction motors for elevator service are intermittently rated, laid out on the basis of maxi-



AC Motor for Elevators.

DC Elevator Motor.

GENERAL ELECTRIC COMPANY, SCHENECTADY, N. Y.

Address nearest office. For list of offices see page 706.

imum-minimum starting torque of 200% full load running torque. These motors can also be furnished for either 3-phase or 2-phase and with either full magnetic or semi-magnetic control. The acceleration with either type of control is automatic and is controlled by means of time element interlocks of the unbalanced flywheel type, which means that acceleration is unaffected by moisture or dirt.

On single-phase circuits the repulsion type induction motor is furnished, which can be reversed from full speed one direction to full speed reverse without danger. Motors of this type are limited in their application due to the lack of single-phase power and undesirable high starting currents resulting from throwing the motor across the line.

For direct current the Type RC reversible compound wound elevator motors are furnished. These are designed to have the series field cut out immediately after starting. G-E control equipments which are furnished with these motors employ the use of dynamic braking for slow-down.

Automotive Motors

The service requirements of storage battery vehicles demand the use of highly specialized motors, differing widely in mechanical and electrical characteristics from direct current

motors for the propulsion of street cars.

All vehicles, whose source of energy is derived from storage batteries, require that the motor or motors in-



Small G-E Automotive Motor.

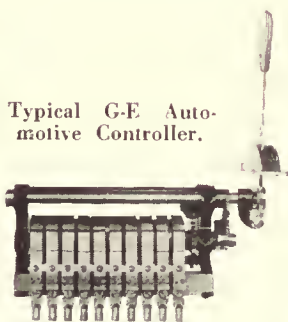

Typical G-E Automotive Controller.

sure at all times and under all conditions the most economical ratio of power output to wattage input. Sparkless commutation, great overload capacity, and a maximum of torque per ampere are also important factors in automotive motor design.

Mechanically, the automotive type of motor must have great strength and durability combined with accessibility and careful elimination of every ounce of useless weight.

An important advantage in the latest type of G-E automotive motor is its flexibility in meeting widely differing application requirements from the light industrial truck to the 7½-ton heavy duty road vehicle. The use of a plain cylindrical magnet frame allows motor to be mounted on the chassis by means of supporting brackets or cradles which may be easily designed and applied by the vehicle manufacturer.

Due to the extremely specialized nature of automotive motor drives, all inquiries should be taken up with the nearest G-E sales office.

Application of Electric Industrial Locomotives

In all industries the electric industrial locomotive is adapted to play an important part in the solution of material handling problems. Large factories usually have a spur connecting with the nearest railroad, and the movement of freight cars over this spur involves considerable handling charges if carried on by the railroad company. Many applications of industrial electric locomotives are shown in Bulletin 44251.

Where the manufacturer operates a locomotive of his own, the electric type has several advantages over the steam switch engine. These outstanding advantages of the electric locomotive may be summed up as follows:

1. Consumes power only when in actual operation.
2. Can be operated by one man of ordinary intelligence.
3. Is ready for use at all times.
4. Has large momentary overload capacity.
5. Has simple and easily operated control.
6. Has low maintenance cost due to small number of wearing parts.
7. Requires attention only when in use.
8. Can be run inside a building where smoke and fire risk of a steam locomotive would forbid its use.

Ideal Inter-Factory Service

For inter-factory material moving in large manufacturing plants covering considerable area, electric locomotives provide a highly satisfactory and economical service. At the General Electric Company's own factories the transportation of material between the various buildings is practically all done in this manner.

Factory service is, however, only one of the many fields in which the electric locomotive can be used to advantage. It is equally well adapted for service in shipyards, brick yards, stone quarries, cement factories, and similar places. With all of its weight on the driving wheels and a tractive effort which is continuous rather than pulsating, the electric locomotive is well



G-E Industrial Locomotive Transferring Miscellaneous Materials in Process of Manufacture.

fitted to haul ore from mines to the stamp mills, and log trains to the saw mill. Where heavy grades are encountered electric haulage is particularly effective.

Electric locomotives are also used with success on large public works where great quantities of earth, rock and concrete must be moved. Where this work involves tunnel driving, the low, mine type of locomotive provides an ideal form of haulage.

GENERAL ELECTRIC COMPANY, SCHENECTADY, N. Y.

Address nearest office. For list of offices see page 706.

ELECTRIC INDUSTRIAL LOCOMOTIVES

Wide Range of G-E Manufacture

G-E industrial locomotives are designed and built in a range of sizes and forms wide enough to include any haulage requirement. They incorporate principles of construction which are the result of many years of experience in this class of work. Full advantage has been taken of the experience gained in the manufacture of mine locomotives, which must be built to withstand unusually severe service and rough handling.

G-E industrial locomotives are built to take power from trolley, third rail, and storage batteries, or from either trolley or storage battery. They are of the single or double truck type with one motor mounted on each axle and vary in weight from 4 to 50 or more tons. They are built for gauges varying from 18" up to 56½". Storage battery locomotive motor equipments are designed to operate from 85, 170 or 200 volts—storage batteries. Equipments for the trolley and third rail type are designed for operation from 250, 500 and 600 volt D.C. circuits.

Industrial Locomotive Motors

Motors known as Type HM are standard for either storage battery or trolley type locomotives.

The capacity of motors for standard locomotives is based not only on determinations, but is the result of long experience with many locomotives operating under various conditions. The motor equipments are designed to operate satisfactorily without troubles due to overheating. Since the motor capacity is based solely on general practice, no locomotive can be guaranteed for a given service until service data has been submitted for investigation.



G-E Locomotives at Work in Chemical Plant.

Weight—12 tons. Gauge—56½". Wheel base—96". Wheel diameter—30". Overall width—93". Height over cab roof—114". Couplers—Standard MCB short shank engine type. Brakes—Combined straight and automatic air with hand auxiliary. Has extra air capacity and additional hose coupling to charge dumping mechanism on cars. Sanders—Air operated. Journal boxes—MCB 3¾" x 7" journal. Truck frame—Rolled steel. Cab—Sheet steel on steel angle framework. Motors—Two motors. Control—Series-parallel drum type. Speed—Eight MPH. Current collectors—Four over-running third rail shoes.



Hauling Material from Ship to Warehouse.

Weight—8 tons. Gauge—56½". Wheel base—54". Wheel diameter—24". Overall width—82". Height over cab roof 115". Coupler—¾ MCB short shank engine type with center 25" above rail. Truck frame—Rolled steel. Journal boxes—End thrust mine type. Brakes—Hand screw and nut type. Cab—Sheet steel on steel angle frame. Motors—Two. Control—Series-parallel drum type. Speed—Six MPH.



G-E Pusher Locomotive Designed for Spotting Cars Over Bins or Hoppers on Unloading Docks.

Weight—25 tons. Gauge—42½". Overall length—291". Wheel base—132". Overall width—67". Height over cab roof—145". Frame—Rolled steel. Journal boxes—End thrust mine type. Cab—Sheet steel on steel angle frame. Brakes—Straight air with hand auxiliary. Pusher arms—One on each side, cast steel, spring cushioned, air operated. Motors—Two motors. Control—Master controllers with contactors. Current collector—Two over-running third rail shoes. Operates from metallic circuit collecting from two rails located in center of track rails.

Storage Battery Locomotives

Where conditions render the operation of the trolley type of locomotive inexpedient the storage battery locomotive can often be used advantageously. In transportation in and about

factory buildings the battery type may be operated inside of the buildings, and by providing the elevators

GENERAL ELECTRIC COMPANY, SCHENECTADY, N. Y.

Address nearest office. For list of offices see page 706.

ELECTRIC INDUSTRIAL LOCOMOTIVES

with tracks they can be used effectively to distribute material on different floors. They can be used with safety in locations where the operation of the overhead trolley would be dangerous. Also, where materials have to be carried over temporary tracks or the location of the trackage is subject to frequent changes, the storage battery type of locomotive will give the necessary service with a minimum of investment and operating expense.

Data on Battery Locomotives

Every locomotive unit built by the General Electric Company is designed to meet certain requirements and necessitates definite engineering recommendations. However, the following

tabulated data, applying to commonly used types and the data given for units illustrated, will give an idea of the specifications on types which have been built to supply specific needs.

INDUSTRIAL HAULAGE LOCOMOTIVES, STORAGE BATTERY TYPE							
Approx. Wt. with Battery, Tons	Type	No. of Motors	Gauge	DBP, Lbs.	MPH at Rated DBP	Battery Capacity, K.W.H.	Brakes
4	LSB-2E4	2	24	1000	3½	20	Hand
4	LSB-2C4	2	24	1000	3½	17	Hand
5	LSB-2C5	2	30	2000	3½	33	Hand
8	LSB-2C8	2	56½	2800	3½	46	Hand
10	LSB-2C10	2	56½	3000	4½	45	Hand
15	LSB-2C15	2	56½	4000	5	64	Hand, Straight Air
30	LSB404-E6	4	56½	8000	5	128	Hand, Straight Air
40	LSB404-E8	4	56½	12000	5½	178	Hand, Straight Air

Ratings of Draw Bar Pull which appear in the table are determined by motor and battery capacity. Ordinary practice in rating the DBP of electric locomotives brings in weight on the drivers, but with a storage battery type the total weight is nearly always in excess of that required for developing the rated pull.

Battery capacities given refer to the batteries supplied with locomotives which have been built. To determine size of locomotive and capacity of battery necessitates engineering recommendations based on the particular service to be performed.

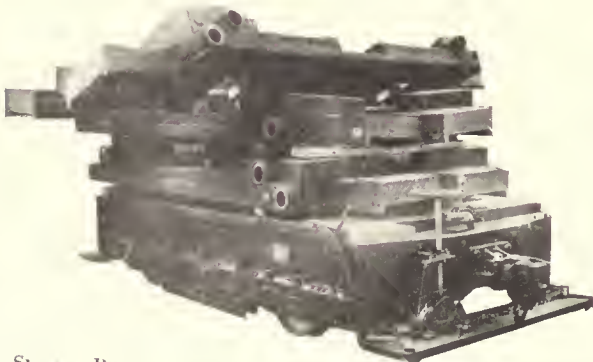

Storage Battery Locomotive Carrying 20 Tons of Castings.

Weight—5 tons. Gauge—56½". Overall Length—143". Wheel Base—72". Wheel Diameter—20".

Overall Width—76". Height over Platform—30". Brakes—Hand screw and nut type. Coupler—¾ size MCB with center 14" above rail. Journal Boxes—Mine type. Truck Frame—Steel channel side and end sills. Deck Covers—Two in. wood planking covered with steel checkered plate. Motors—Two. Battery Capacity—19 kw.-hrs. Speed—Two to 8 MPH depending on load. Control—Series-parallel drum type.

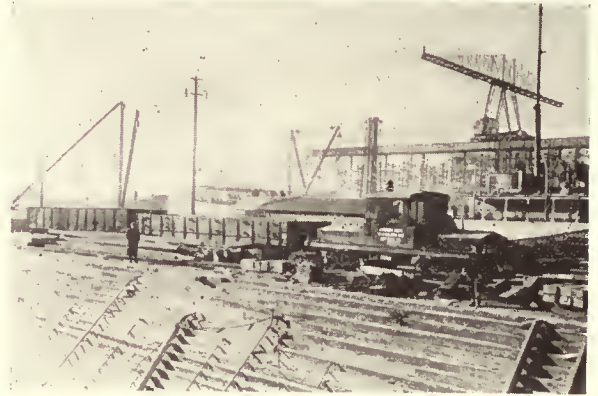

30-Ton Double Truck Storage Battery Locomotive in Switching Service at Shipbuilding Plant.

Weight—30 tons. Gauge—56½". Truck Centers—180". Rigid Wheel Base—76". Wheel Diameter—30". Overall Width—122". Height over Cab Roof—126". Couplers—Standard MCB long shank spring draft gear. Brakes—Straight air with hand auxiliary. Sanders—Double end air-operated. Journal Boxes—MCB 3¾" by 7" Journal. Trucks—Arch bar. Platform—Steel channel sills and sheet steel deck plate. Cab—Sheet steel on steel angle frame. Motors—Four motors. Battery—120 kw.-hr. Control—Series-parallel drum type. Two control stations in cab. Speed—4½ to 15 m.p.h., depending on trailing load.

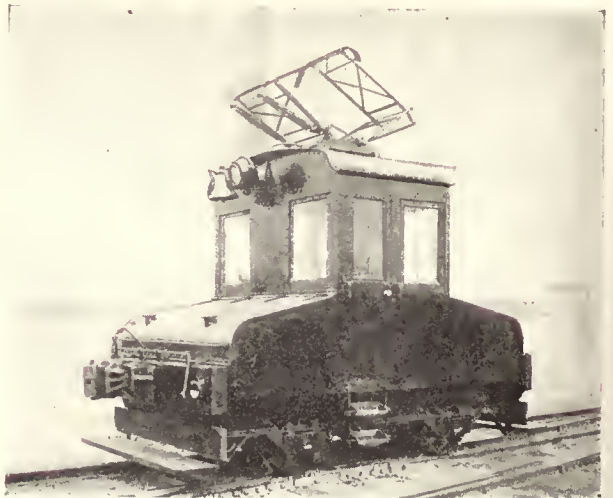

Combination Trolley and Storage Battery Locomotive.

Weight—10 tons. Gauge—56½". Wheel Base—72". Wheel Diameter—24". Overall Width—115". Height over Cab Roof—118". Coupler—Standard MCB short shank engine type. Brakes—Hand screw and nut type. Journal Boxes—Mine type. Truck

GENERAL ELECTRIC COMPANY, SCHENECTADY, N. Y.

Address nearest office. For list of offices see page 706.

BATTERY CHARGING EQUIPMENT

frame—Steel channel sills. Cab—Sheet steel on steel angle frame. Motors—Two motors. Battery—42 kw.-hrs. Voltage—250 V. on trolley. Speed—4 to 6 MPH. Control—Series-parallel drum type.

Mine Locomotives

The General Electric Company has been engaged in the manufacture of mine locomotives for gathering and haulage for the past 30 years, and as evidence of durable construction, can point to some locomotives in continuous service for this entire period. This is proof that the company appreciates the severe conditions of mine service, and builds locomotives that will stand up under most trying conditions.

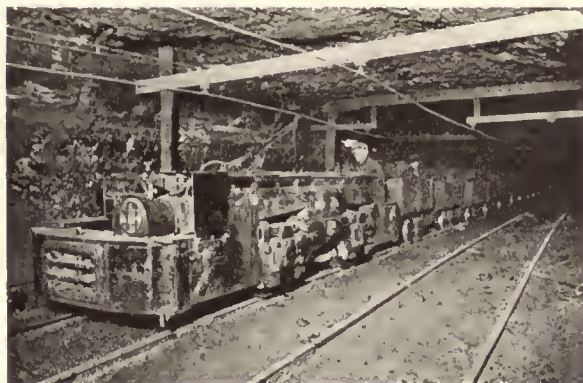

G-E 13-Ton Mine Haulage Locomotive in Service.

Renewal Part Service

The General Electric Company maintains a repair-part service which is expedited by the use of a special renewal parts catalog compiled for each locomotive. These catalogs contain all the information required for the correct ordering of any repair part. Delays incident to possible misunderstanding of orders are thus eliminated.

Each catalog contains exploded views of the component devices, giving accurately the names of individual parts and the proper ordering numbers. The locomotive data are segregated and tab indexed under headings such as, Frame and Truck Parts, Motors, Controllers, Cable Reel, Air Equipment, etc.

One of these catalogs is furnished with each locomotive, and extra copies are gladly made up for persons in the customer's organization who are charged with the upkeep of equipment.

Battery Charging Equipment

Storage battery charging equipment is, of course, a necessary accessory in connection with the operation of storage battery locomotives as well as industrial electric trucks and tractors; in fact, any storage battery propelled vehicle.

The General Electric Company is prepared to furnish battery charging apparatus of any type most desirable for any particular service, including rectifiers of the ionized gas, or "Tungar," and the mercury arc type, and motor generator outfits, including individual charging sets, starting and lighting battery charging sets,

and larger sets for multiple battery charging. In addition, suitable panels can be provided for service where a small panel is not built as a part of the outfit recommended.

Individual charging motor generator sets are designed to regulate the current and taper the charge of a single battery. Two sets can be installed for operation in multiple, the same as a two-circuit generator and panel in case of two trucks of the same size and number of cells. Described in Bulletin Y1372A. The sets for simultaneously charging two or more batteries in multiple are used with multiple circuit switchboards, necessarily different from the control panels for the individual charging sets in order that batteries of different degrees of discharge may be properly handled. Bulletin Y1364A.

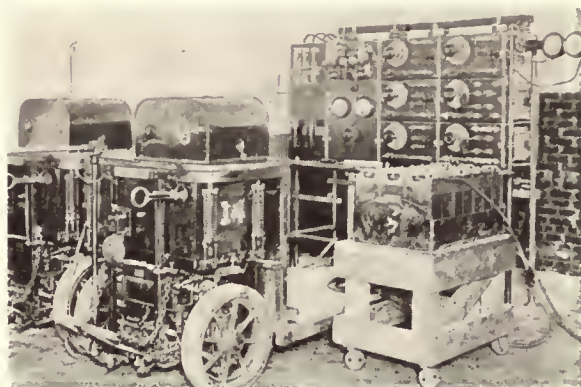

6-Circuit Battery Charging Switchboard in Operation.

Railway Line Material

The General Electric Company has developed a complete line of material used in the construction of overhead trolley systems and track return for electric railways in every service. This includes pole brackets, suspensions and ears of many types, strain and feeder insulators, splicing sleeves, trolley frogs and crossings, section switches and insulators, turn buckles, rail bonds, bonding tools, etc.

These devices have been designed to meet every possible condition and have been thoroughly tested. Sherardizing is the standard finish and protection for all iron and steel parts of G-E line devices. Japan finish can be furnished for use where devices are subject to the deteriorating effects of acids.

Owing to the many types and the variation in dimensions of rails and joint plates in common use, a great variety of forms of bonds has been developed. Occasionally exceptional cases arise requiring some modification of one of the standard forms in order that the best results may be obtained. The General Electric Company will gladly submit recommendations showing how best to meet any bonding conditions and its Engineering Department is always at the service of customers to give advice.

Special forms of these devices have been developed to meet the special conditions of mines and other industrial properties. This complete line is described in Bulletin 44005A. It should be ample for the selection of any devices needed in construction to provide electric haulage of materials over a new or electrified system.

GENERAL ELECTRIC COMPANY, SCHENECTADY, N. Y.

Address nearest office. For list of offices see page 706.

BALDWIN - WESTINGHOUSE STORAGE BATTERY LOCOMOTIVES

Combined Experience of Two Companies

Baldwin - Westinghouse electric locomotives for use in industrial plants can be supplied in a wide variety of sizes and types. The long experience of the Baldwin Locomotive Works and the Westinghouse Electric and Manufacturing Co. in the co-operative manufacture of electric locomotives insures a product of the utmost reliability. They are built for D.C. trolley operation and with storage batteries.

Application of Storage Battery Locomotive

Baldwin-Westinghouse storage battery locomotives can be divided into two general classes, those built for standard gauge tracks and those built for narrow gauges. They have a wide range of application in industrial service. They have been used in the construction of subways, railroads,

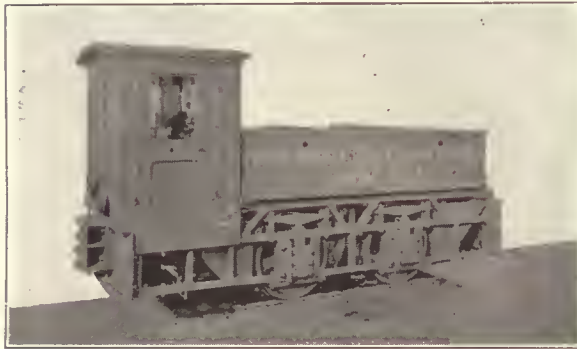

West Virginia Pulp & Paper Co. Use B-W Storage Battery Locomotive.

tunnels and aqueducts. Indoors they are used in foundries, iron and steel mills, power plants and various industrial plants.

Reasons for Selection

Where smoke, exhaust fumes or noise is objectionable and where readiness to start without delay is desirable, the Baldwin-Westinghouse storage battery locomotives are an important adjunct to a plant. Where insurance laws demand the minimum fire risk and trolley wires are impossible these locomotives furnish the natural solution. They assure a minimum danger of causing explosions in powder mills or other industries handling inflammable materials. They offer the possibility of using power when the generating plant is carrying a light load and in this respect are especially economical.

Efficiency in Design

The Motors are designed electrically and mechanically for storage battery operation. They have a very high efficiency throughout their operating range, including overloads. They are unusually rugged and are enclosed, avoiding the accumulation of dirt and water. Practically the

only attention needed is a periodical inspection for the purpose of renewing brushes when they are worn and replenishing the bearing lubricant. Ball bearings are furnished lubricated from grease cups.

The field coils of each motor are arranged in two groups to permit of series and parallel grouping and to obtain high tractive effort at low speed with minimum current during accelerating periods.

Control and Batteries

The control is of a special design which, in addition to the series paralleled, control of the motors themselves has the desirable characteristics of control as previously mentioned. This method of control reduces to a minimum the number of resistance steps and consequent losses, and economizes the battery energy.

The battery, assembled in trays, is mounted in a wood lined sheet steel compartment on top of the locomotive side frames. In special cases the battery can be mounted between the side frames and below the top of the locomotive, in order to secure a low over-all



B-W Storage Battery Locomotive in the Plant of Victor Talking Machine Co.

height. Standard locomotives are provided with a compartment which can be readily removed by a chain hoist.

A slate panel is provided having mounted thereon a double-pole, double-throw main knife switch and a Sangamo ampere hour meter which indicates the condition of the battery charge. A snap switch is included to control the locomotive headlights.

NARROW GAUGE LOCOMOTIVES				
Class	Weight Pounds Chassis Only	Rated D. B. P.	Rated Speed in P. Hr.	Normal Battery Capacity in W. Hrs.
A-6-2	6,000	1,000 lbs.	3.5	11-22
A-8-2	8,000	2,000 lbs.	3.5	23-35
A-10-2	10,000	3,000 lbs.	3.5	36-48

STANDARD GAUGE LOCOMOTIVES		
Weight Tons	Brakes	Nominal Battery Capacity in K. W. Hours
10	Hand or Straight Air	35-47
15	Hand or Straight Air	35-55
20	Hand or Straight Air	50-70
25	Hand or Straight Air	60-100
25	Automatic Air	60-100
30	Automatic Air	70-120

WESTINGHOUSE ELECTRIC & MFG. CO.

EAST PITTSBURGH, PA.

Address nearest office. For list of branch offices see page 758.

EDISON STORAGE BATTERIES

Principle and Construction

The Edison Storage Battery employs a principle differing radically from that of all other storage batteries having commercial importance at the present time. It is the only storage battery having iron or steel in its construction. Instead of lead grids, its grids are of steel. Instead of acid electrolyte, it employs an alkaline solution. Instead of a solution that destroys the plates and members, its solution is a preservative of its iron and steel parts. Instead of compounds of lead its active materials are compounds of nickel and iron. These changes are important because by virtue of the nature of the new Edison combination, greater strength, longer life and increased durability are achieved, together with a simplicity in care and operation not hitherto possible.



Industrial locomotives equipped with Edison Batteries assure continuous daily service and greater tonnage hauled.



This locomotive in metal mine haulage was equipped with Edison Batteries in November, 1911. They are still in use.



Gathering and hauling locomotives in coal mines rely on Edison Batteries for increased production.

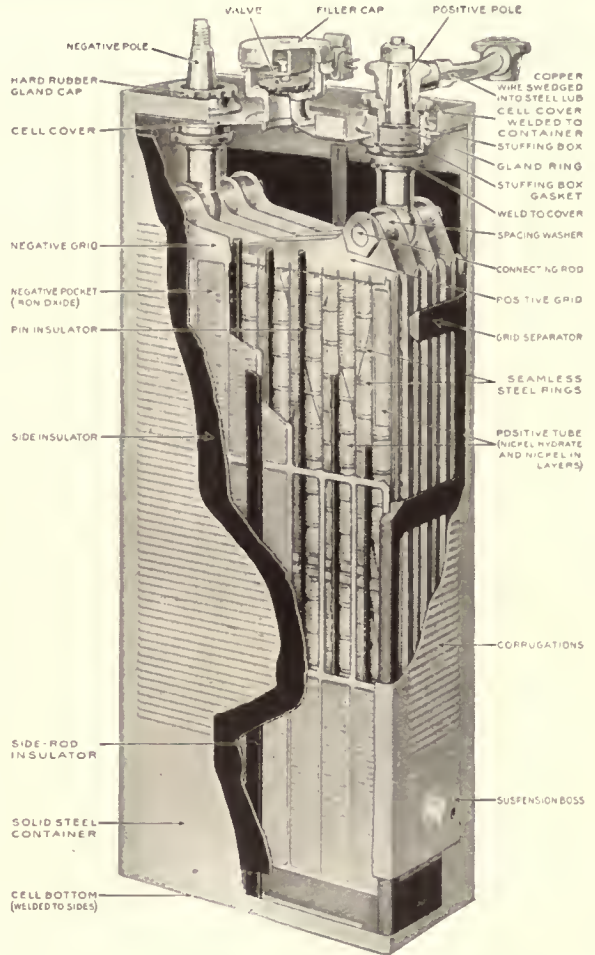

The Edison Alkaline Storage Battery.
"Built Like a Watch, Rugged as a Battleship."

Quality and Long Life

Because of its distinctive features in principle and its steel construction, the Edison Battery has great strength, long life, and is maintained with minimum upkeep.

In mines, industrial plants, etc., these features insure highest service efficiency over a long period of time.

GENERAL DATA AND TRAY DIMENSIONS OF EDISON STORAGE BATTERIES

Type (Letters denote size of Plate— Figures, Number of Positive Plates)	A4	A5	A6	A8	A10	A12	G4	G6	G7	G9	G11	G14	G18
Prices on Application													
Rated capacity, Ampere Hours	150	187.5	225	300	375	450	100	150	175	225	275	350	450
Discharge rate (A type, 8-hour; G type, 5-hour) Amps.	18.75	23.44	25.13	37.5	46.88	56.25	20	30	35	45	55	70	90
" " (A type, 5-hour; G type, 3½ hour) Amps.	30	37.5	45	60	75	90	30	45	52.5	67.5	82.5	105	135
Average Discharge Voltage (A type, 8 hours; G type, 5 hours)	1.24	1.24	1.24	1.24	1.24	1.24	1.23	1.23	1.23	1.23	1.23	1.23	1.23
" " (A type, 5 hours; G type, 3½ hours)	1.2	1.2	1.2	1.2	1.2	1.2	1.2	1.2	1.2	1.2	1.2	1.2	1.2
Normal Charge Rate (A type, 7 hours; G type, 4¾ hours)	30	37.5	45	60	75	90	30	45	52.5	67.5	82.5	105	135
Weight of Cell, complete, pounds	13.8	16.7	19.4	26.8	33.3	40.6	10.9	15.1	17.4	21.1	27.3	34	44.5
Weight per Cell, in Trays, pounds	14.9	17.5	20.8	29.0	36.2	43.9	13.0	16.8	18.2	23.0	29.6	36.9	47.8
Amount Renewal Solution per Cell (lbs.)	3.2	3.8	4.3	6.4	8.1	9.9	2.52	3.62	4.2	4.98	6.10	7.7	10.68
Over-all Tray Dimensions, in Inches:													
Width of Standard Tray	6½	6½	6½	6½	7¾	9	6½	6½	6½	6½	6½	7¾	9½
†Height over-all (Filler cap closed)	14¾	14¾	14¾	14¾	14¾	15½	14¾	14¾	14¾	14¾	14¾	14¾	15½
†Height over-all (Filler cap open)	16	16	16	16	16¾	17	16	16	16	16	16	16¾	17
Length of Trays:													
1-cell tray	4½	5¼	5¾	7¼	7½	7½	4½	4¾	5¼	6	7¼	7½	7½
2-cell tray	7¾	9	10	12½	13½	13½	6¾	8	9	10¾	12½	13½	13½
3-cell tray	10¾	12¾	14¼	18¾	19½	19½	9¾	11¼	12¾	14¾	18¾	19½	19½
4-cell tray	14	16¾	18½	24½	25¾	25¾	12¾	14¾	16¾	19¾	24¾	25¾	25¾
5-cell tray	17½	20	22¾	29¾	32¼	32¼	15	18¼	20	24½	29¾	32¼	32¼
6-cell tray	20¼	23½	27¾	36	---	---	17¾	21¾	23½	28½	36	---	---
7-cell tray	23¼	28½	32	41¾	---	---	20¾	25	28½	33¾	41¾	---	---
8-cell tray	27¼	32¼	36¾	47¾	---	---	23¼	28¼	32¼	37¾	47¾	---	---
9-cell tray	30¾	36	41¾	53¾	---	---	25¾	31½	36	42¼	53¾	---	---
10-cell tray	33¼	40¾	45¾	---	---	---	28¾	35¾	40¾	47	---	---	---
11-cell tray	36¾	43¾	---	---	---	---	31½	38¾	43¾	---	---	---	---
12-cell-tray	40¾	---	---	---	---	---	34¾	---	---	---	---	---	---

†Over-all heights are given for bottomless trays. Add ¼ inch to height and ¼ inch to length for trays with bottoms.

PORTER LOCOMOTIVES

The Porter Name-Plate

The Porter name-plate on a light Locomotive has been a standard for over fifty years. However, during the last two decades the H. K. Porter Company have been adding to this line, locomotives of heavier weight and greater power. Today a large portion of their output consists of heavy machines. These heavy locomotives are designed for more severe requirements than are usual in ordinary railroad service. They are admirably adapted to a wide range of service where uninterrupted performance close up to maximum capacity is demanded.

Porter Locomotives for Contractors

The Porter Class B-S, light, four-wheel-connected, saddle-tank locomotive is designed for contractors' use and other special service. It is the best possible selection for general contracting work, shifting and industrial service, where the haul is not long but where a simple compact design is needed for sharp curves, rough track, and hard work.



Porter Contractor's Locomotive

These locomotives are substantially built and can be depended upon for long service with infrequent renewals. The brake shoes are generally the only replacement items needed for a long time. Locomotives of this type can be equipped for coal, wood, or oil fuel.

Porter Compressed Air Locomotive

The H. K. Porter Company also build two-stage compressed air locomotives of all sizes. These locomotives furnish a safe and convenient motive power for gaseous coal mines and in other localities where fire, sparks, heat, or the products of combustion are dangerous. The locomotive exhausts nothing but pure air and cannot contaminate the atmosphere, blacken the walls or ceiling, or soil fabrics or raw material in cotton, woolen or paper mills.

Porter Fireless Locomotives

The Porter fireless locomotives are absolutely safe against fire danger and free from fire-box, flue, stay bolt and water supply troubles. They are the cheapest, safe locomotive power for lumber mills and yards, creosoting plants, cotton and textile mills, sugar plantations and powder mills

These locomotives are designed and built for all practicable gauges of track and to conform to reasonable limitations of height and width.

Details may be modified to suit the working conditions of any particular plant or job. The fireless locomotive is built in several different sizes, but the company is prepared to build larger or smaller sizes, locomotives with higher and lower initial pressures, as well as locomotives with six wheels if they are desired.

The Porter fireless stored-steam locomotives are similar in construction to the other Porter steam loco-

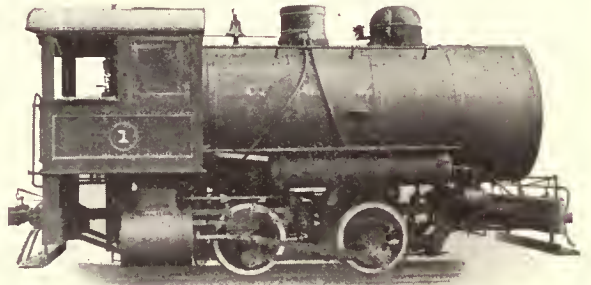

Porter Fireless Locomotive

motives. A large tank well insulated takes the place of a boiler and is charged from a stationary boiler. When about four-fifths full of hot water, the steam pressure in the locomotive tank is equalized with the steam pressure of the stationary boiler at 160 to 180. Until the tank pressure is reduced so that the cylinder pressure falls below 60 pounds the locomotive will develop its full tractive force. The locomotive tank is charged in approximately 10 to 20 minutes and runs from one to four hours with one charge. The cylinders are placed at the rear to secure a perfect balance of weight.

The Porter Stock System

All Porter locomotives are built to a duplicate system and corresponding parts of all locomotives of the same size and class are interchangeable. Furthermore, the company keeps on hand—independent of material required for locomotives under construction—a complete stock of duplicate parts for all of the standard sizes and designs. These are ready to ship on receipt of the customers' orders.

This Porter duplicate system is an efficient insurance to every owner of a Porter locomotive against the loss of time or money in case of wreck or wear that may easily be worth hundreds of dollars a day. It enables the company to deliver repair parts to distant customers not only quicker than the parts could be made at the customer's door, but at less cost, of correct fit, and of standard quality.

Besides the spare parts in stock the company carries a stock of fully completed locomotives of the latest design for both thirty-six and for fifty-six and one-half inch gauges ready for shipment as soon as the couplings can be adjusted to the required height and the cab and tank lettered to instructions.

H. K. PORTER COMPANY

PITTSBURGH, U. S. A.

INDUSTRIAL CARS AND EQUIPMENT

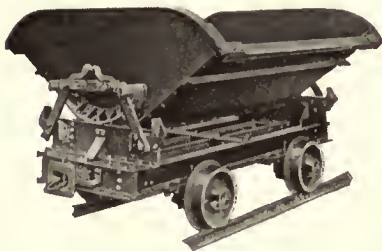

Koppel Quarry Car.

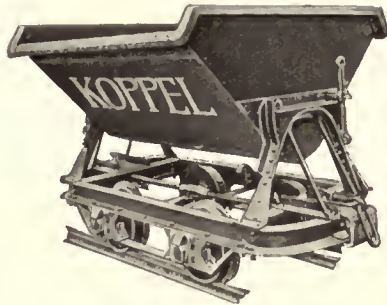

Koppel Contractors' Car

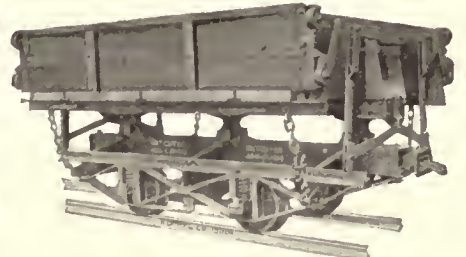

Koppel Square Box Dump.

Koppel Industrial Cars

The Koppel Industrial Car & Equipment Co. are builders of all types of cars for coal, clay and metal mines; all steel, composite or wood; all capacities and gauges. Their scoop car is especially adapted to industrial plants used for handling ashes, coal, sweepings, etc., and to contractor's use for concrete, dirt, sand, etc. Can be dumped on four sides. Capacities 12, 18 and 27 cu. ft., gauge 18" and 36".

The Koppel double-side dump cradle cars, so applicable to road building general contract work, coal and ash handling, etc., are made in capacities of 18, 27 and 36 cu. ft. with 18" and 30" gauge.

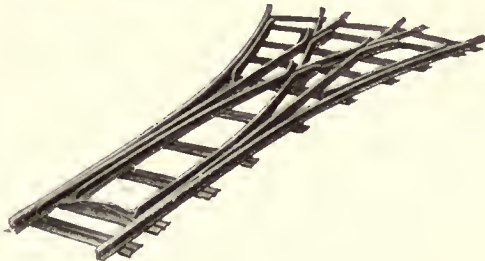

Industrial Switch Points and Frogs.

A similar car is the double-side dump, Koppel Rocker Car, designed for quarry service. It is low; therefore it can be loaded by hand. However, it is strong enough for steam shovel loading. Made in all capacities up to 5 yards and gauge up to standard.

Koppel flat cars are made in single or double truck, all capacities and gauges. For steel or forge plants cars with steel cover plates or rails on top can be supplied.

Koppel patented rocker supports and steel body frames are embodied in their square box dump contractors' car. This is a most rugged and economical car, made in 4, 6, 16 and 20 yards capacity.



Koppel Mine Car

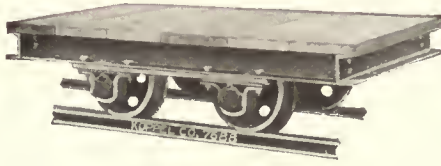

Koppel Flat Car.



Koppel Scoop Car.

Rails and Accessories

The Koppel Industrial Car & Equipment Co. manufactures switch points and frogs for any weights of rails and for any gauge of track. Complete track layouts consisting of rails and switches mounted in units on steel ties can be supplied for industrial plants and contractors' use.

In addition they manufacture wheels, axles, journal boxes, spring bearings, couplers, stake pockets, etc.



Koppel Steam Locomotive.

Koppel Steam Locomotives

Koppel steam locomotives are made either standard or narrow gauge in various types.

They are free from derailment troubles on account of their underslung water tanks, thus giving low center of gravity—all parts accessible for adjustment. Any construction features can be modified to suit special requirements.

Their Electromobile industrial truck, tractors and trailers may be equipped with a variety of Koppel bodies. Bulletins on any type of car or a general catalogue covering the entire line will be sent on request.

SALES OFFICES:

30 Church St., New York City.
Peoples Gas Bldg., Chicago, Ill.
Farmers Bank Bldg., Pittsburgh, Pa.
1420 Chestnut St., Philadelphia, Pa.
Book Building, Detroit, Mich.
Edw. R. Bacon Co., 51 Minna St., San Francisco, Cal.



KOPPEL INDUSTRIAL CAR & EQUIPMENT CO.
KOPPEL, PENNA.

EASTON INDUSTRIAL RAILWAYS

**Products,
Facilities and
Service**

Cars (for every industrial purpose). Rails and Portable Track. Switches, Permanent and Portable. Wheels and Axles.

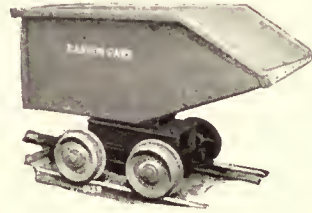

Fig. 5139.

Turntables. Crossings.

This space permits of only a bare summary of the wide and complete variety of Easton industrial railway equipment. Full specifications and additional and larger illustrations will gladly be sent to supplement these small cuts.

This company designs and builds narrow-gage railways complete, for all industrial purposes: contracting operations, factories, yards, warehouses, plantations, docks, power plants, quarries, etc. It furnishes everything required for a complete installation, either to its own or to customer's drawings and specifications: cars, rails and accessories, locomotives, switches, frogs, turntables, etc.

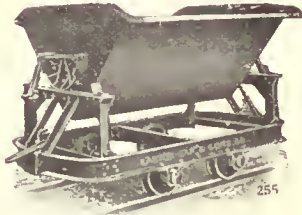

Fig. 255.

STANDARD SCOOP CAR											
Code Word	Capacity	Track Gage	Body				Length Scoop End	Wheel Base	Axles	Wheels	Weight Lbs.
			Length	Width	Depth	Height Overall					
Sporcheyza	18	18"	4'11"	2'0"	2'0"	3'6"	2'4 1/4"	26"	1 1/2"	10"	540
Sporisori	18	24"	4'11"	2'0"	2'0"	3'5"	2'4 1/4"	26"	1 1/2"	10"	550
Sporobole	18	30"	4'11"	2'0"	2'0"	3'7"	2'6"	26"	1 1/2"	10"	570
Spora	18	36"	4'11"	2'0"	2'0"	3'7"	2'6"	26"	1 1/2"	10"	580
Sporocarp	27	18"	4'11"	3'0"	2'0"	3'6"	2'5 1/4"	30"	1 3/4"	12"	700
Sporatorne	27	24"	4'11"	3'0"	2'0"	3'6"	2'5 1/4"	30"	1 3/4"	12"	710
Sportfully	27	30"	4'11"	3'0"	2'0"	3'8"	2'7 1/2"	30"	1 3/4"	12"	730
Sport	27	36"	4'11"	3'0"	2'0"	3'8"	2'7 1/2"	30"	1 3/4"	12"	740
Frame Channel			6"		Plates						1/8"

Table gives the rated capacity figured with heaped load.

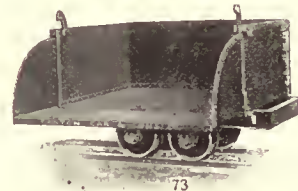

Fig. 73. Coal Charging Car.

STANDARD ROCKER DUMP CAR								
Code Word	Ribbenford	Ribblstick	Ribeavate	Ribbonison	Ribisco	Ribucammo	Ribollisco	Riburлато
Cap. Cu. Ft.	18	27	27	40	40	40	54	54
Track Gage	24"	24"	30"	24"	30"	36"	30"	36"
Overall Dimen.								
Height	3'7 1/2"	3'10"	3'11"	4'6 1/2"	4'7"	4'8"	4'16"	4'11"
Width	3'11"	4'5"	4'5"	5'4"	5'4"	5'4"	5'10"	5'10"
Length	6'8"	7'3"	7'3"	8'	8'	8'	8'8"	8'8"
Body Dimen.								
Length, inside	4'2"	4'9"	4'9"	5'5"	5'5"	5'5"	6'	6'
Width, inside	3'8"	4'2"	4'2"	5'	5'	5'	5'6"	5'6"
Wheels	12"	12"	12"	14"	14"	14"	14"	14"
Axles	2"	2"	2"	2"	2"	2"	2 1/4"	2 1/4"
Wheel Base	2'	2'	2'	2'6"	2'6"	2'6"	2'6"	2'6"
Plates—								
Side	1/8"	1/8"	1/8"	1/8"	1/8"	1/8"	3/8"	3/8"
End	1/8"	1/8"	1/8"	3/8"	3/8"	3/8"	3/4"	3/4"
Weight, pounds	900	1000	1075	1425	1475	1525	1750	1790

Table gives the rated capacity figured with heaped load.

STANDARD COAL CHARGING CAR			
Capacity	1/2 ton	1 ton	1 1/2 ton
Gage	24"	24"	24"
Code Word	Treckfuss	Treckung	Treckler
Body length inside	4'6"	5'0"	6'0"
Body width inside	3'4"	3'10"	4'0"
Body depth inside	1'6"	2'0"	2'6"
Overall height	3'0"	3'8"	4'5"
Height to floor	1'6"	1'8"	1'8"
Plates	1/8"	1/8"	1/8"
Wheels	12"	14"	14"
Weight	750 lbs.	1000 lbs.	1300 lbs.

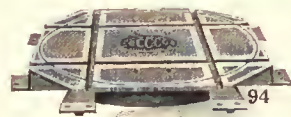

Fig. 94. C. I. Turntable.

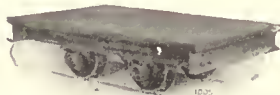

Fig. 1005.

STANDARD CAST-IRON BALL-BEARING TURNTABLE WITH AUTOMATIC LOCKING DEVICE					
Code Word	Diameter of Top	Track Space	Capacity Tons	Standard Gage	Weight Pounds
Revolvador	40"	41 1/4"	3	20"	700
Revolving	44"	45 1/4"	4	24"	800
Revolution	48"	49 1/4"	4	24"	1,150
Revotaba	52"	53 1/4"	6	24"	1,275
Revuelto	60"	61 1/2"	6	24"	1,675
Revne	72"	73 1/2"	7	24"	2,800
Revnlarum	84"	86 1/2"	8	24"	3,400

Turntables 44" to 84" will also fit 24 1/2" outside track gage. Other gages than standard can be furnished at a slight additional cost.

STANDARD PLATFORM CAR											
Code Word	Platf'm. Dimen.		Height	Wheels	Axles	Frame Channel	Wheel Base	Track Gage	Floor	Capacity in Tons	Weight in Lbs.
	Length	Width									
Stobrorum	4'0"	3'0"	15"	12"	1 1/4"	5"	20"	20"	1 3/4"	2-3	500
Stachetto	5'0"	3'4"	15"	12"	1 3/4"	5"	24"	24"	1 3/4"	2-3	550
Stockblind	6'0"	4'0"	15"	12"	1 3/4"	5"	24"	24"	1 3/4"	2-3	640
Saber	6'0"	4'0"	18"	14"	2 1/4"	6"	30"	24"	1 3/4"	5	825
Sable	8'0"	4'6"	19"	16"	2 1/4"	6"	42"	36"	1 3/4"	6	1,200
Saccharine	12'0"	6'0"	22"	16"	2 3/4"	7"	72"	48 1/2"	1 3/4"	6	2,000

EASTON CAR AND CONSTRUCTION CO.

40 DEY STREET, NEW YORK

WORKS, EASTON, PA.

EASTON INDUSTRIAL RAILWAYS

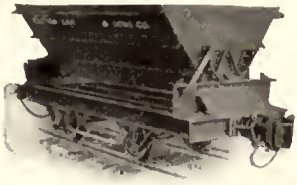

Fig. 974. Rocker Dump Car.
Special for locomotive traction. These large cars are made in any capacity or design, for any track gage either with or without brakes and automatic couplers

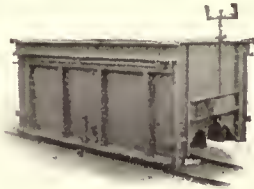

Fig. 3847. Gable Bottom Car.
With special reinforcements and heavily braced doors—for quarry service.



Fig. 435. Gable Bottom Car.
We build all types in standard and special designs with and without brakes, the smaller sizes being 4-wheel construction and the larger sizes double truck, or 8-wheel construction.



Fig. 276. Standard Cradle Dump Car with Brake.
Also built to dump end-wise or all around. Standards in stock.

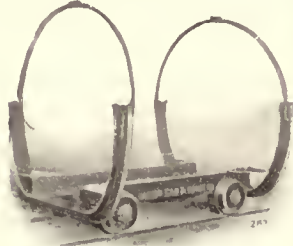

Fig. 283. Creosoting Car.
One of the many types we build.

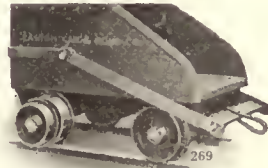

Fig. 269. All-Steel Skip Car.
Built in various designs and to meet special requirements.



Fig. 491. Locomotive.
Gasoline and Oil-burning steam. 3-12 ton, any gage.

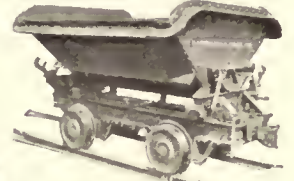

Fig. 4281. Heavy Rocker Dump Car.
Designed for extra-heavy service in mine and quarry work.



Fig. 1533. Special Double Truck Platform Car.
Built to meet any specific requirements, in any desired size. Both with and without brakes.



Fig. 147. Sugar Cane Car.
All steel with end racks. We build a complete line of steel sugar cane cars to meet any requirement or specification.



Fig. 403. Rotary Dump Car.
Designed for mine work, in tunnels and other services where small over-all dimensions are an important feature.



Fig. 1886. End Discharge Car.
Special design with chute and sliding gate. Other End Discharge Cars are shown in Bulletin No. 7.



Fig. 2236. Charging Box Car.
We build all types of Charging Box Cars in standard and special designs.

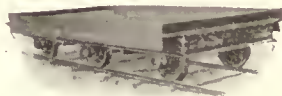

Fig. 1184. Easton Annealing Furnace Car.
Widely used in steel mills, foundries, automobile and other factories where annealing and heat-treating of castings, chains, forgings, etc., is a part of the manufacturing process.

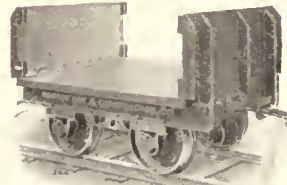

Fig. 264. Pig Iron Car.
This type of car can be furnished either with or without sides or ends, with ends and sides removable.



Fig. 4415-B Easton Super-Service Road Cars.
Carries three 32 cu. ft. steel batch boxes. Big saving in first cost by cutting down number of cars required by one-third. Two three-box cars do the work of three two-box cars.



Fig. 77. Portable Track on Steel Ties.
Any gage and weight of rail.

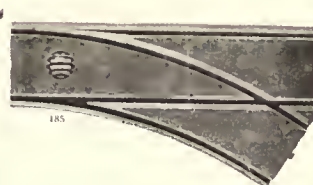

Fig. 185. Cast Iron Plate Switch and Track.
For boiler rooms, power plants, etc.

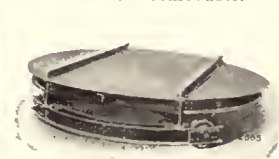

Fig. 2665. Turntable.
Heavy-duty turntables built for any capacity, diameter, and gage.

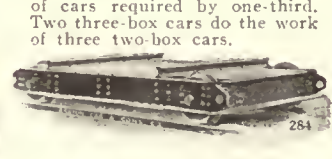

Fig. 284. Transfer Cars.
Built in a number of designs, many of them being underslung, so the load-platform is very close to the ground.

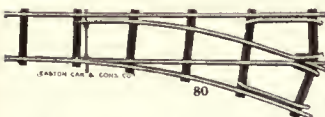

Fig. 80. Portable Switches With or Without Steel Ties.
All gages and weights of rail.



Fig. 135. Crossings
Of any design, angle, gage, or weight of rail.



Fig. 448. Wheels and Axle.
Of any design for all gages.

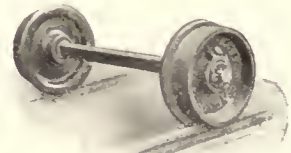

Fig. 87. Roller in Hub Wheels on Square Axles.

EASTON CAR AND CONSTRUCTION CO.

40 DEY STREET, NEW YORK

WORKS. EASTON, PA.

LAKEWOOD BURTON LOCOMOTIVE

The Lakewood Burton Locomotive

The Lakewood Burton Locomotive is one of the most satisfactory motive powers for narrow gauge railway haulage. It has a use in every industry, in highway and general building construction, quarries, plantations, logging, brick and clay plants, sand and gravel pits, and industrial plants of every description.

Wherever the transfer of materials from department to department, or from one shop to another, is a constant requirement, narrow gauge railways have proven economical and efficient.

Wherever narrow gauge railways may be installed the ideal motive power is the light-weight locomotive using gasoline or kerosene for fuel. These little machines are also used for switching standard freight cars with great convenience at low cost.

The Lakewood Burton Locomotive has been developed to its present perfection through many years of active service in these various fields of usefulness. It combines simplicity of construction, flexibility of operation, and economical performance.

Briefly, it consists of a power plant mounted on a rigid cast frame, carried on four flanged wheels set to a short wheelbase so that sharp curves may be easily negotiated.

Power is transmitted from the engine to the track wheels by means of a friction disc and roller chains, eliminating all spur and beveled gears, friction clutches, and other complicated parts.

This system of transmission enables the Lakewood Burton Locomotive to operate with load in either direction at equal speeds and with equal efficiency. Operating speeds range from 2½ to 10 miles per hour.

Magneto ignition, radiator cooling system, fuel tanks with ample capacity for a full day's run, sand box, link and pin couplers adjustable to suit various heights of cars, are other features.

Brakes are applied to all four wheels, controlled by a lever at the operator's hand, and have sufficient power to lock all wheels instantly in case of emergency.

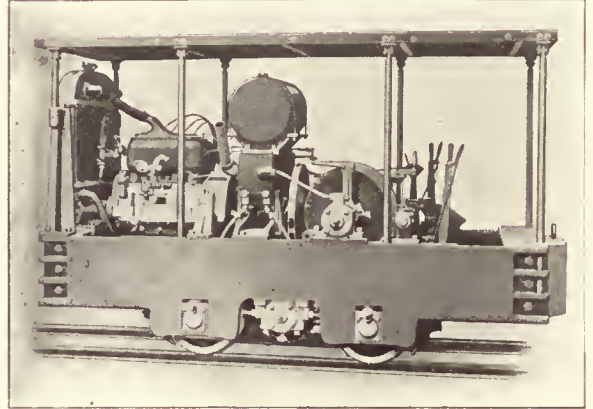

Lakewood Burton Locomotive

A winding drum to carry steel cable is furnished when desired, for the purpose of snubbing cars, or for assisting in hauling up heavy inclines.

The low center of gravity of the machine makes it smooth running, even on rough track, and reduces to a minimum the possibility of derailment.

Furnished in two sizes, 3½ and 6 tons, and in gauges of 18, 24, 30, 36, 42 and 56½ in.

SPECIFICATIONS

	3½ Ton	6 Ton
Size	3½ Ton	6 Ton
Size of Motor	4 Cyl., 3½ x 5	4 Cyl., 4½ x 6
Horse Power	23 at 1000 R.P.M.	46 at 1000 R.P.M.
Ignition	Bosch High Tension Magneto	Bosch High Tension Magneto
Fuel	Gasoline	Gasoline
Starting and Lighting	Two Unit single wire system	Two Unit single wire system
Electrical Equipment, extra	Adjustable search lights, front and rear, Klaxon Horn	Adjustable search lights, front and rear, Klaxon Horn
Wheels	Steel, pressed and keyed on axles; 18" diam.	Steel, pressed and keyed on axles; 18" diam.
Axles	3¼" diam. high carbon steel, carried on Hyatt Bearings, supported by Spring Pedestals	3½" diam. high carbon steel, heat treated, carried on Hyatt Bearings, supported by Spring Pedestals
Drive	Friction disc drive by chains to jack shaft and from jack shaft by chains to both axles	Friction disc drive by chains to jack shaft and from jack shaft by chains to both axles
Friction Disc	Cast Iron, 23" diam.	Cast Iron, 30" diam.
Spur Friction	Tarred Fibre, 22" diam. Shaft carried on Hyatt Heavy Duty Bearings	Tarred Fibre, 28½" diam. Shaft carried on Hyatt Heavy Duty Bearings
Drive Chains	Steel Roller, ¾" Roller, 1½" Pitch	Steel Roller, 1" Roller, 1¾" Pitch
Wheel Base	30"	48½"
Draw Bar Pull at 5 Miles per hour	1400 lbs.	2400 lbs.
Track Gauge	Optional, 18 to 56½"	Optional, 18 to 56½"
Length	10' 5"	12' 5"
Height	Regular with cab 6' 2", without cab 4' 9"	Regular 6' 3½", Special Construction 5' 3"
Width	24" Gauge, 49"	24" Gauge, 55½"
Weight	7600 lbs.	12000 lbs.
Brakes	On all four wheels	On all four wheels
Cab	Metal with side curtains. Extra for all-metal hood	Metal with side curtains. Extra for all-metal hood
Gasoline Capacity	20 Gallons	20 Gallons
Gasoline Consumption	Average conditions, 5 gal. in 10 hours	Average conditions, 9 gal. in 10 hours

Overall Dimensions:	3½-Ton			6-Ton		
	Width	Length	Height	Width	Length	Height
18" and 24" Gauge	4' 0"	10' 5"	6' 2"	4' 7"	12' 5½"	6' 3½"
30" Gauge	4' 6"	10' 5"	6' 2"	4' 7"	12' 5½"	6' 3½"
36" and 42" Gauge	5' 6"	10' 5"	6' 2"	5' 7"	12' 5½"	6' 3½"
4' 8½" Gauge	5' 2¾"	10' 5"	6' 2"	5' 2¾"	12' 5½"	6' 3½"

LAKEWOOD ENGINEERING CO., CLEVELAND, U. S. A.

For District Offices See Opposite Page.

LAKEWOOD CARS—TURNTABLES—TRACKS

**Flanged Wheel
V-Dump Car
No. 241**

Designed for handling loose material, such as coal and slag. Built in capacities 1, 1½ and 2 yards. Body and frame rigid steel construction, cast steel draw head, link and pin type.

For locomotive haulage, spring bumpers and spring pedestals are furnished. Gauges 24", 30" and 36".

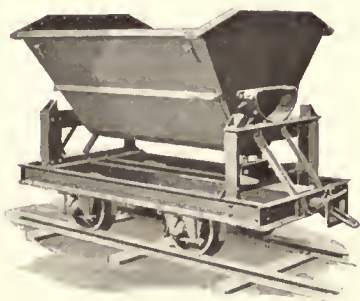

**Lakewood
Standard
Turntable**

Made of best quality cast iron, with top grooved for flange wheels or plain checkered surface. Table revolves on a serpentine circular track, filled with 2-in. or larger balls. Turns easily with heavy load. Built for all track gauges. Diameter 3½, 4, 5, 6 and 8 feet.

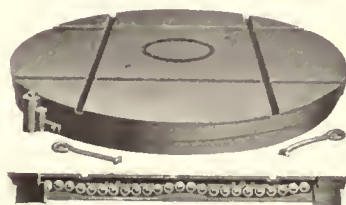

**Radial Gate
Hopper Car
No. 232**

Designed to handle concrete, but may be used to haul coal, sand or other loose material. Body constructed of 1/8 in. plate. Gate opening 14" x 14"—operated with a lever. Wheels

chilled iron. Car capacity 24 or 32 cu. ft.



**Lakewood
Track and
Joint Tie**

Narrow gauge track for temporary or permanent installation. Used by Allied armies during entire war. Pressed Steel Ties flanged all around, with center corrugation running the length of the tie and riveted to rails to secure

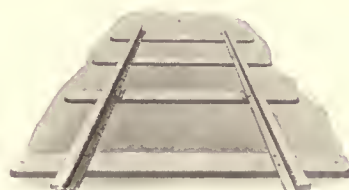

rigid section. Joint tie locks sections securely and takes the place of four fish plates, eight bolts and nuts. Nothing to come loose. May be taken up repeatedly.

**Platform Car
No. 271**

Designed for factory or yard work. Furnished with wood or steel top. Platform any size desired. Hyatt Roller bearings on all wheels. Built for locomotive or hand haulage.

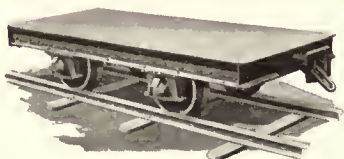

LAKEWOOD DISTRICT OFFICES

Atlanta, Ga.....90½ Forsyth St.
Baltimore, Md.....507 American Bldg.
Boston, Mass.....453 Washington St.
Buffalo, N. Y.....256 Main St.
Chicago, Ill.....1215 Lumber Ex. Bldg.

Cleveland, O.....305 Racine Bldg.
Dallas, Texas.....711 Sumpter Bldg.
Des Moines, Iowa.....202 Hubbell Bldg.
Detroit, Mich...1401 David Whitney Bldg.
Kansas City, Mo...Railway Exchange Bldg.
Minneapolis, Minn...529 Second Ave., S.

New York, N. Y.....141 Centre St.
Philadelphia, Pa.....1034 Widener Bldg.
Pittsburgh, Pa.....Union Arcade
Richmond, Va.....Times-Dispatch Bldg.
San Francisco, Cal.....473 Rialto Bldg.

THE LAKEWOOD ENGINEERING CO., CLEVELAND, U. S. A.

For District Offices See Above.

LAKWOOD TIER LIFT TRUCK

Lakewood Models

More than three years ago Lakewood sensed the need for an industrial truck that would pick up, transport and elevate by electric power loads of 4,000 pounds to heights sufficient for piling. After months of experimenting and testing, the Lakewood Tier-Lift Truck was developed to its present degree of mechanical perfection and added to the Lakewood line of Industrial Transportation equipment.

The merit of this truck has been proven in such diversified industries as steel mills, cotton mills, print shops, automotive shops, chemical plants, foundries, warehouses, etc.

The first three models comprised machines with tiering heights of 42, 60 and 76 in., which pick up, transport and elevate a load of 4,000 lbs. Since then, however, two new types have been added—a 96 in. Tier-Lift Truck and the Model 703-A, capable of handling 2,000 lbs. but having a lifting speed twice as great. This latter type is furnished in the four standard tiering heights, 42, 60, 76 and 96 inches.

What It Will Do

The Tier-Lift Truck will tier goods in the warehouse. Pile loaded platforms, one on top of another, practically converting ceilings into floor space. Load and unload trucks from the ground level. Place heavy dies on machines in forge shops. Handle pots at annealing or normalizing ovens. Transport material up steep grades. These and other operations it will do day in and day out. The Tier-Lift Truck does that back-breaking lifting and transporting which labor shuns and avoids.

The possible saving in time, men and floor space resulting from the installation of a Tier-Lift Truck is quite astonishing. Many instances can be cited where the original cost of the Tier-Lift Truck has been saved in a few months.

Big Saving Possible

At the plant of the Carpenter Steel Company the installation of a Tier-Lift Truck in their shipping department resulted in the reduction of their crew by seven men and a resultant saving of \$2.77 per ton of product shipped.

Even more startling are the figures compiled following the installation of a Tier-Lift Truck at the Ireland & Mathews Stamping Plant in Detroit; with proper die racks the Tier-Lift Truck will pick up, deliver and place any die weighing up to 4,000 lbs. in ten minutes. Allowing for production time lost by men and machine, this operation will cost by Tier-Lift method approximately \$5.00 instead of \$112.00 as under the hand labor method.

The Tier-Lift Truck at the Ireland and Mathews plant is also

used to store work boxes and forged parts.

With properly designed racks having a clearance sufficient for Tier-Lift platform, material may be removed from any part of the rack. This makes possible selective tiering. Tiering racks are designed to meet individual requirements.

The table covering the cost of handling tobacco hogsheads is typical of savings made in many industries by the Tier-Lift Truck.

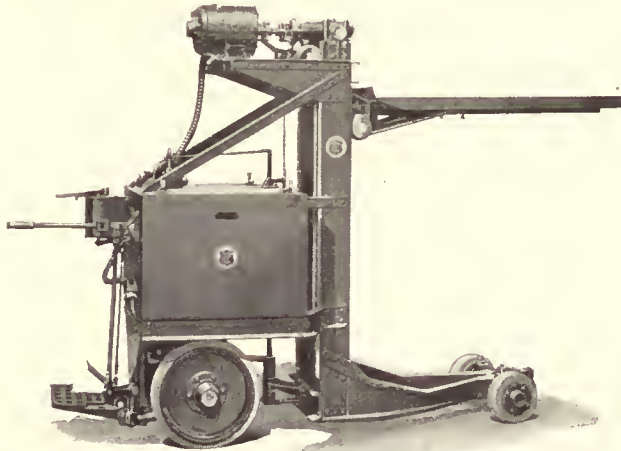

HANDLING TOBACCO HOGSHEADS

	By Hand	By Tier-Lift
Men required.....	8	4
Tons handled in 9 hr. day.....	77	135
Length of haul in feet.....	180	180
Labor cost for 9 hours.....	\$25.80	\$12.60
Cost per ton.....	0.337	0.094

HANDLING COTTON SEED MEAL

Men required.....	6	3
Bags per trip.....	6	9
Length of haul in feet.....	180	180
Labor cost.....	\$18.90	\$9.80
Cost per ton.....	0.58	0.15

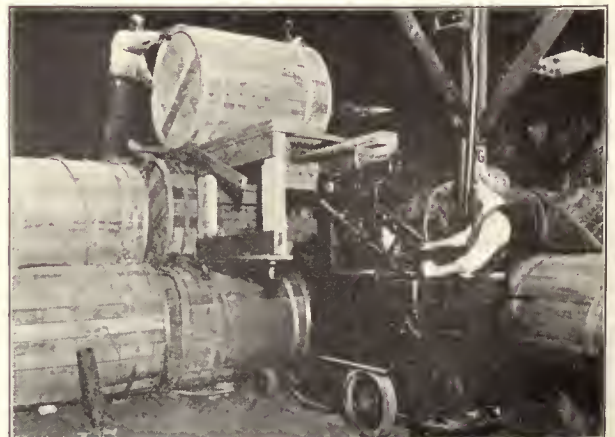
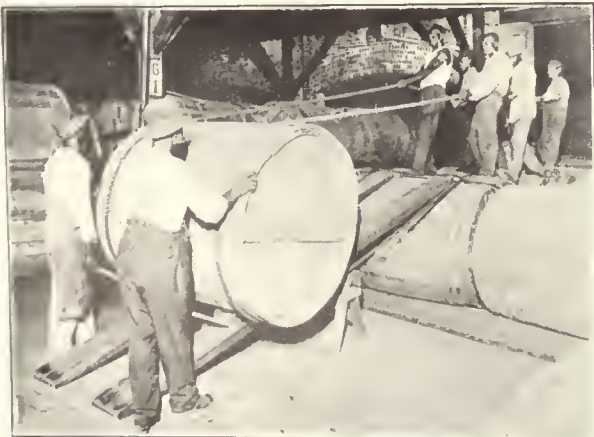

THE LAKWOOD ENGINEERING CO., CLEVELAND, U. S. A.

For District Offices See Page 725.

LAKWOOD TIER LIFT TRUCK

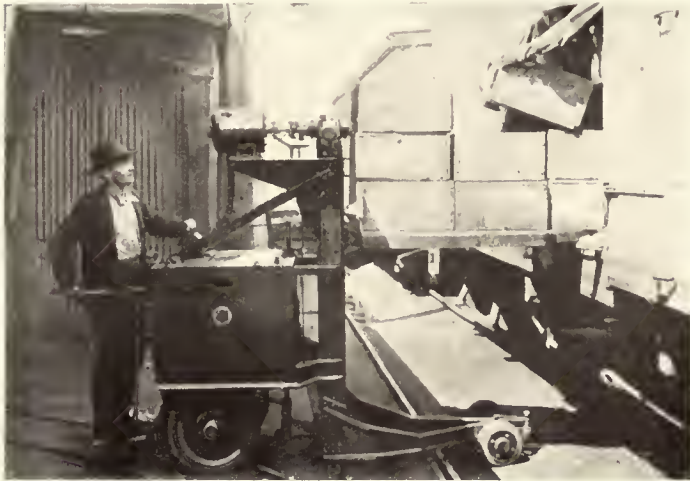

Tier Lift Truck saves \$2.77 per ton of product shipped at Carpenter Steel Co.



Tier Lift Truck picks up 4,000 lb. dies, delivers and places in 10 minutes.

Specifications

	Height of platform raised with 4,000-load.
	Model 703 or 703-A—42 in....42" maximum
	Model 703 or 703-A—60 in....60" maximum
	Model 703 or 703-A—76 in....76" maximum
	Model 703 or 703-A—96 in....96" maximum
	Platform—steel plate checkered.
	Platform height lowered, 11" from floor
	Platform length.....39 or 54"
	Platform width.....26"
	Four wheel steer controlled by horizontal lever operating vertically.
	Two wheel drive, Lakewood high efficiency worm and gear.
	Wheelbase62"
	Wheel tread, operating end.....27"
	Wheel tread, load end.....19½"
	Turning radius:
	Extreme outside corner.....92"
	Extreme inside corner.....42"
	Outer wheels.....78"
	Tires—solid rubber:
	Operating end.....20" x 3½"
	Platform end.....10" x 4"
	Length overall: (with 54" Platform)
	Steering handle in operating position.....121½"
	Step and steering handle folded.....109"

Width overall.....	36"
Overall height, Model 703 or 703-A—42".....	61½"
Overall height, Model 703 or 703-A—60".....	79½"
Overall height, Model 703 or 703-A—76".....	96¼"
Overall height, Model 703 or 703-A—96".....	116¼"
Clearance under truck with 4,000-lb. load.....	2¾"
Motors: Main drive, 24 volt, 65 amperes, series-wound high efficiency motor entirely enclosed and dust proof.	
Tier-Lift Motor: Independent unit, 24 volt, 40 amperes with ample overload capacity.	

Controller:

Drive Operating Controller: Steel drum type with positive neutral stop, adjustable renewable contact fingers.

Tier-Lift Controller: Special design, renewable contact fingers.

Safety Switch: Part of the controller.

Sliding contact rotary switch which reduces arcing to a minimum.

Brake: Contracting brake band on drive shaft.

Bearings: High grade Gurney ball bearings throughout.

Speed: Three speeds forward and three speeds reverse.

Without load 3 to 6½ mi. per hr.

With load 2½ to 5 mi. per hr.

Weight without battery 2400-2600 lbs.

Weight with battery 2844-3290 lbs.

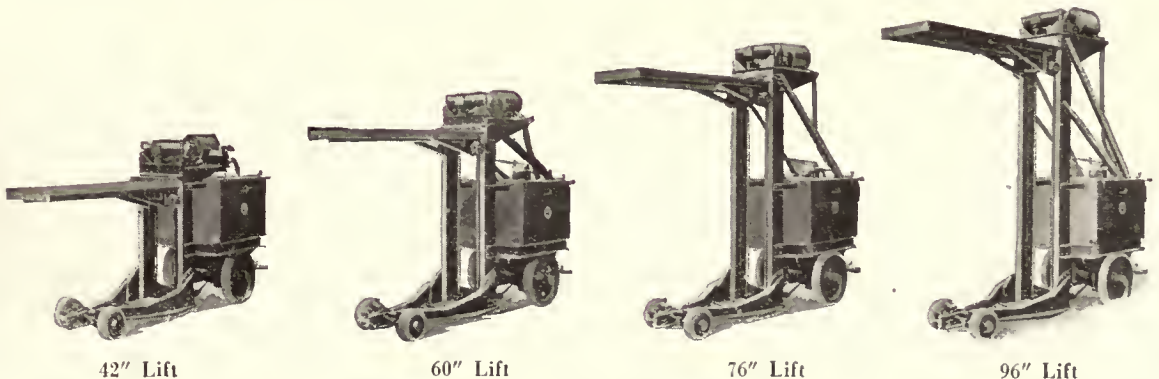

THE LAKWOOD ENGINEERING CO., CLEVELAND, U. S. A.

For District Offices See Page 725.

LAKWOOD STORAGE BATTERY TRACTOR

Four-Wheel Drive and Steer Tractor

Patterned after the electric locomotive, the Lakewood tractor has no front or rear. Each end has heavy bumper and coupling and will pull or push in either direction with equal power and speed. It turns on a radius of 61 in., making possible rapid operation in congested places.

The double end control feature eliminates turning around, enabling the operator to run straight into a

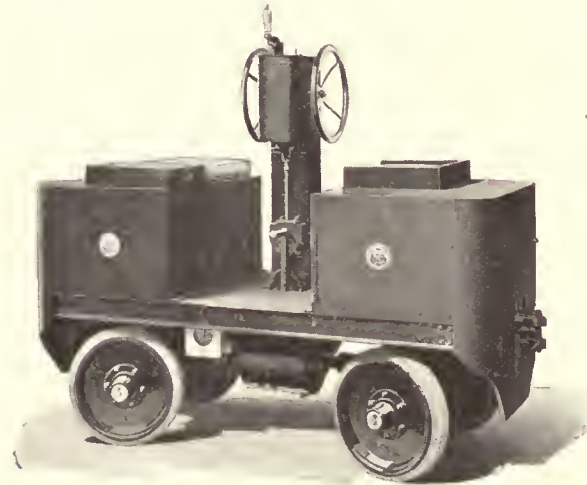

coupling and pull out by simply reversing his driving position. No backing out required.

The Four-Wheel Drive and Steer features of the Lakewood Truck and Tractor give maximum driving power for hauling heavy loads up grades or over slippery floors, straight ahead or on sharp turns. Operation is surprisingly easy in crowded places.

Drive is through enclosed high efficiency worm and patented bevel gear. All driving mechanism totally enclosed and running in oil or grease.

Performance

Lakewood Tractors will easily handle an 8 to 10-ton trailing load at approximately 4 miles per hour. This normally requires a drawbar pull of 400 to 500 lbs. when operating on level runways. The tractor is capable, however, of exerting a drawbar pull of five or six times this normal rating, should the emergency demand. The speed of the tractor without load is 7 to 8 miles per hour.

A brake and safety switch is combined in one pedal, which, when pushed over in either direction releases the brake and closes the electric circuit to the controller. This pedal is located on one side of the steering column on the other side of which is a similar pedal for the positive operation of a contracting band brake for emergency only.

Frame—Heavy steel channel construction, rigidly riveted together, securely braced on each end.

Tires—Solid rubber, industrial type, 20 x 3½ in. The same size of tires is used on all wheels.

Steer—Four-Wheel steer to permit easy turning in small space. Steers by automobile type wheel, through worm sectors to all four wheels.

Drive—Four-Wheel drive to get maximum tractive effect. High efficiency worm gear with vertical shaft at each wheel. Differentials are made a part of the worm gear.

Motor—Vehicle type, 48 volts, 45 amperes, continuous rating and ample overload capacity. Totally enclosed and protected.

Lakewood Lift Truck

The Lakewood Lift-Truck is of the self-loading type. The load is piled on a skid or on the truck platform. When skids are used, the truck picks up the skid, carries it to some distant

part of the plant and quickly returns for another load. The truck with one operator easily performs the work of several men. Positive worm-drive elevating mechanism, enabling operator to carry loaded platform skid at any elevation from the minimum of 11 in. to the maximum of 42 in. eliminates danger of skid legs dragging in passing over depressions and enables operator to set skids on benches convenient to machine operators.

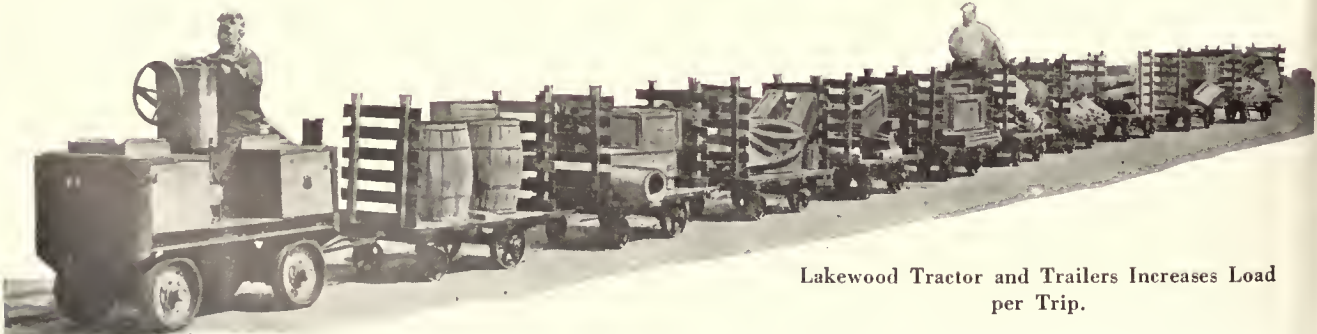
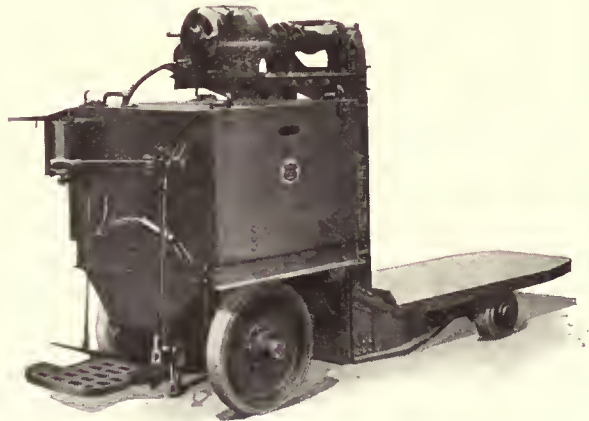

Lakewood Tractor and Trailers Increases Load per Trip.

THE LAKWOOD ENGINEERING CO., CLEVELAND, U. S. A.

For District Offices See Page 725.

LAKEWOOD STANDARD TRAILERS

Four-Wheel Steer Trailer Model 801

Used where narrow aisles and sharp turns make accurate trailing necessary. Couplers on either end—an invaluable feature in pier, warehouse and industrial work. Automobile type steering gear, applied on all four wheels. Capacity 4,000 lbs; weight 650 lbs. Cage roller bearings on wheels. Metal stake pockets, sides and end. Wood end racks extra.

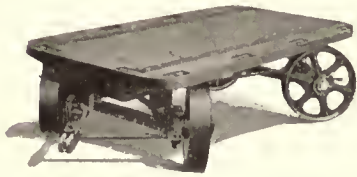

sides and end. Wood end racks extra.

Balanced Type Trailer Model 802

Particularly adapted to general factory use, where both power and hand haulage is necessary. Load being balanced on two center wheels, minimum effort is required to swing trailer around. Practically only type trailer that may be pulled or pushed by tractor. Capacity 8,000 lbs. Weight 1,030 lbs. Platform 3' x 6' of 1/16" inch steel plate riveted to frame. Hyatt roller bearings on center wheels, plain bearings on caster wheels.



1/16" inch steel plate riveted to frame. Hyatt roller bearings on center wheels, plain bearings on caster wheels.

Fifth Wheel Trailer V-Dump Model 806

Designed for handling coal, ashes or other loose material. All steel, side dump may be locked in half dumped position, to reduce lift when loading. Large diameter wheels reduce tractive effort. Short turns made possible by fifth wheel. Designed for hand or power haulage. Capacity 1 cu. yd., or 2,700 lbs. Weight, 1,300 lbs. Cage roller bearings on wheels.



Warehouse Type Trailer Model 810

Embodies maximum qualities in a trailer truck for warehouse. Power or hand haulage. Almost unbreakable construction insured by use of steel and malleable iron castings, combined with a fabricated frame of truss construction. Capacity, 4,000 lbs. Weight, 425 lbs. Platform size 72" x 36". Height from floor 16 1/2". Coupler long steel hook, self locking. Stake pockets side and ends. Hyatt Roller



Bearings on all wheels. New Departure ball bearings and heavy duty ball thrust bearings on casters.

Fifth Wheel Trailer Model 805

Adapted to power haulage in short trains where heavy unit loads are handled. Suitable for operation over rough floors. Large diameter wheels reduce tractive effort. Capacity 10,000 lbs. Weight 1,130 lbs. Frame, steel angle and channels riveted. Platform, wood; size 7' x 3'6".



Stake pockets end and sides. Cage roller bearings throughout.

Low Platform Type Trailer Model 804

Particularly efficient for handling heavy boxes or bulky material, because of 9 inch loading height. Adapted for hand or power haulage, over smooth runways or floors. Capacity 5,000 lbs. Weight 630 lbs. Platform size 3' x 5' 2". Rugged construction. Cage roller bearings on all wheels. Platform



wood. Steel deck extra.

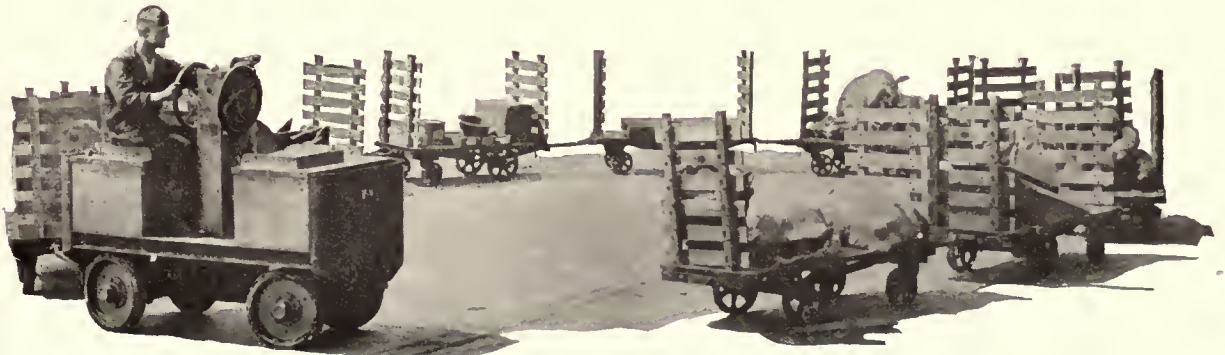

THE LAKEWOOD ENGINEERING CO., CLEVELAND, U. S. A.

For District Offices See Page 725.

LAKEWOOD STORAGE BATTERY TRUCK

Four-Wheel Drive and Steer Industrial Truck

This unit of Lakewood Haulage enables one man to do the work of a gang of laborers.

It will carry its 4,000 lb. load at an approximate speed of four miles per hour. It will operate

in warehouses, in and out of freight cars, and when equipped with a dump body is particularly well adapted to carrying bulk material, such as coal, ashes, fertilizer, etc.

Four-Wheel drive gives maximum tractive effort when handling heavy loads up grades or over slippery floors—the driving strain is equally distributed throughout the entire machine.

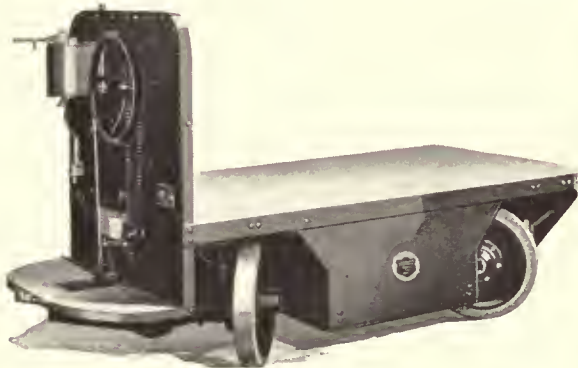

The motor drives each axle through worm gears and differentials. The horizontal driving shafts in the axles, without universal joints, deliver the power to the four driving wheels through beveled gears, thus effecting a continuous high efficiency drive. This same high efficiency worm drive is used on the Lakewood Tier-Lift Truck and Lakewood Tractor, thus permitting the maintenance of Lakewood Industrial Haulage units at the lowest possible cost with minimum repair part stock.

The Four-Wheel steer permits turning in minimum space. The driving mechanism of the wheels makes it possible to turn all four wheels at an angle of 60 degrees, allowing the truck to turn in a 6 ft. radius circle.

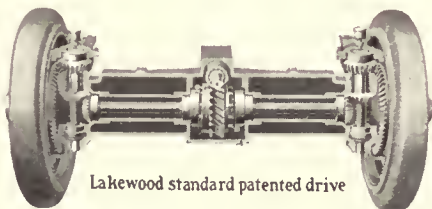

Lakewood standard patented drive

Brake Action and Safety Switch

It is practically impossible to operate the truck except when the operator is standing in proper position on the operator's platform, as the release of a foot pedal sets the brakes, and cuts

off the electric current by means of a safety switch. When the foot pedal is raised to stop the truck, it cannot be started again until the controller has been brought back to neutral position.

A heavy cast bumper at the platform end of the truck affords protection to the front wheels and run-

ning gear, and provides support for a pin coupler which enables the truck to pull one or more trailers in addition to its platform load, thus increasing the flexibility of its application.

All parts of the controller, motor and driving mechanism are accessible for inspection or repairs.

The batteries are carried in steel compartments underneath the deck, at each side of the driving motor.

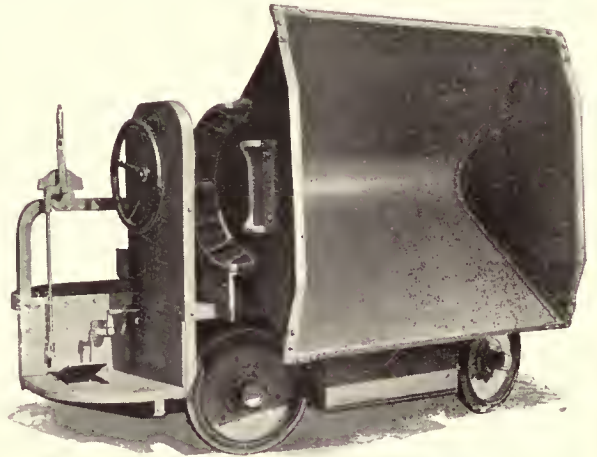

Compartments have removable sides for withdrawing the batteries.

Lakewood Storage Battery Trucks are equipped either with flat top deck or V-Dump body.

Specifications

Axles: Malleable iron, enclosing all driving parts.

Bearings: Ball bearings of highest quality.

Brakes: Two external contracting with non-burnable

band lining.

Control: Automatic safety switch in controller cuts off current and brakes are set when operator releases foot pedal.

Controller: Drum type with renewable fingers, three speed each direction.

Coupler: Pin Coupler bolted to bumper.

Drive: Four-wheel, worm gear with vertical shaft at each wheel.

Frame: Heavy steel channel construction, with heavy cast steel bumper.

Gears: Bevel, high carbon, heat treated, oil tempered, with machine cut teeth. Drive worms—special steel with teeth hardened and ground; worm wheel—phosphor bronze.

Lubrication: All driving mechanism running in grease or oil.

Motor: G. E. 24 volt, 65 ampere with overload capacity, totally enclosed.

Platform: 3/16" checkered steel plate in removable sections, for battery inspection.

Speed: 4 M.P.H. loaded; 8 M.P.H. without load.

Springs: Four heavy double coil springs.

Steer: Automobile type steering wheel and worm sector to all four wheels.

Weight: Truck without batteries 2,450 lbs; shipping weight, without batteries, 3,100 lbs. For 1 yd. V-Dump Body add 750 lbs., and for 1 1/2 yd. body, 875 lbs.

THE LAKEWOOD ENGINEERING CO., CLEVELAND, U. S. A.

For District Offices See Page 725.

HYATT ROLLER BEARINGS FOR TRUCKS



Scene at Engineering Test of Hyatt Equipped Trailer Trucks Where Power Saving of 21.8% Was Determined.

Modern Trucks and Trailers

Whatever forms of trucks or trucking systems are used, it is essential for the most reliable and economical operation to buy trucks that are carefully designed for the work, well constructed of good materials. One essential feature of any modern truck is Hyatt Roller Bearings, as the savings in power, lubrication and maintenance afforded by these modern bearings are of real importance in the reduction of trucking costs.

Manufacturers of trucks, realizing the advantages of Hyatt equipped trucks, are prepared to furnish this modern equipment for any form of truck. They can also furnish Hyatt Bearing replacement wheels to be applied to modernize your present plain bearing trucks.

Advantages of Hyatt Equipped Trucks

These modern bearings bring to trucks of all kinds the following advantages: Owing to the easy running qualities of the bearings, less power or effort to move the trucks is required. One charge of grease is sufficient for three to four months' operation, which decreases the cost of lubrication (material and labor). Because of their sturdy construction, Hyatt equipped wheels are capable of giving years of satisfactory service without requiring replacement, and in this way eliminate maintenance costs.

Power Saving

The importance of the power saving qualities of Hyatt equipped trucks is apparent when interpreted in terms of more trucks per train or quicker operation of truck trains, decreased strains on storage batteries and elimination of noon-day boosting of batteries. One man with a Hyatt equipped hand truck can quickly handle the heaviest load without fatigue and the easy running trucks put a snap in the work.

A test witnessed by a representative of the American Society of Mechanical Engineers showed a power saving of 21.8% in favor of Hyatt equipped trucks when compared with pin roller bearing trucks. If a comparison had been made between Hyatt equipped trucks and the plain bearing trucks the saving would have been even greater. And there are still thousands of ordinary plain bearing trucks in use, wasting power and lubricant and running up heavy maintenance charges.

Lubricant Saving

Any grease applied to Hyatt Roller Bearing trucks stays in the bearings for months, so that lubrication is required only at intervals of three months, or four times a year. This also eliminates the time lost by truckers and the labor of applying the lubricant. On a large pier operating over a thousand Hyatt equipped hand trucks, carefully kept records show a saving of 90% in the cost of grease and 98% in the cost of labor to apply it as compared with their former plain bearing trucks.

Maintenance Saving

The sturdy chrome-vanadium steel rollers of Hyatt Bearings are capable of giving years of service under the most severe conditions without appreciable wear. This eliminates worn-out hubs and wobbly wheels; the bearings stay in good operating condition throughout the life of the truck. An eastern railroad operating 200 Hyatt equipped trucks, carrying heavy loads at top speed, only replaced one caster in 18 months of war time service. The bearings examined at the end of the 18 months showed absolutely no signs of wear.

New Wheels for Old Trucks

One of the quickest, most economical methods of getting Hyatt Roller Bearing equipment is to buy Hyatt Bearing replacement wheels for trucks now in service.

Often there is no good reason why present plain bearing trucks should be thrown out and new equipment purchased, nor is it good policy to postpone securing the advantages of Hyatt equipped trucks until such time as the present trucks wear out. Therefore, the proposition of buying new wheels with Hyatt Bearings mounted in them is worth the careful consideration of every truck user.

The application of new Hyatt equipped wheels to old trucks is a simple proposition involving very little work, and when the change is once made the new wheels are capable of giving years of hardest service without the need of replacement.

Hyatt Engineering Service

Our engineers are bearing specialists and are often able to present designs and plans for the use of Hyatt Roller Bearings that are of real value to truck manufacturers and truck users. Get in touch with us regarding any bearing problem without obligation.

COWAN ELECTRIC SELF-LOADING TRUCK

"Through Ticket" System in Industry

Express Companies, Railroads and Ocean Forwarders, as well as Manufacturers, are waking up to the great economies of the "through ticket" system of moving loads.

Ocean Forwarders will pack a van at a customer's door and deliver it to the consignee in London or Calcutta without a single rehandling or repacking in transit.

Manufacturers in many lines are doing away with costly rehandling through the use of the Cowan Self-Loading Truck and skid system. In every factory where loads must be moved from machine to machine, department to department, or building to building, any rehandling between starting point and destination is waste of labor and loss of profit. An equipment of Cowan Electric Self-Loading Trucks to handle skids provides the "through ticket" system for thousands of manufacturers, wholesalers and warehousemen.

Cowan Self-Loading Electric Truck.

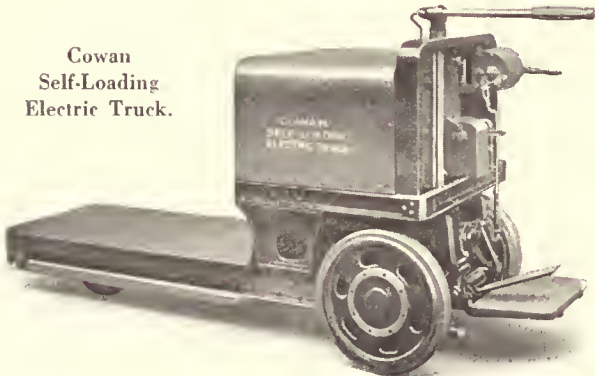

Distinctive Cowan Features

The electrically operated Self-Loading truck which has been developed by the Cowan Truck Company combines the long experience in lift truck manufacture of this company with the latest developments in industrial truck design. One of the outstanding features of this truck is its simplicity. The number of parts has been reduced to a minimum and all are interchangeable. It is sturdily constructed throughout with a guaranteed capacity up to 5,000 pounds.

Lifts in Five Seconds

The lifting mechanism is of the heavy bell crank type. This is an absolutely new application in the construction of electric truck lifting mechanisms. It is actuated by an independent, heavy duty, series wound motor with worm gear reduction. The platform elevates vertically with a maximum rise of $4\frac{1}{2}$ inches.

The truck, equipped with full capacity battery, elevates a 5,000-pound load in five seconds and without load in three seconds. The full lowering time is three seconds. This speed in loading and unloading is an important feature of Cowan Trucks, for time saved in this way makes a large total at the end of a day.

Shocks and Jars Eliminated

An "Anti-kick" device takes all jar off the steering handle when the truck travels over rough spots. The rear end of the truck is equipped with a heavy bumper which effectually takes all shocks and protects the rear end of the lift platform. The tray in which the battery rests is supported on springs which relieve the cells from vibrations and shocks under all conditions of operation.



Minimum Over-all Turn

The turning radius of the Cowan Electric Self-Loading Truck, measured to the extreme outside point, is seven feet five and a half inches, a distinctive Cowan accomplishment. This short radius permits the truck to operate in intersecting aisles fifty-seven inches wide. By folding the foot pedal and steering handle into a vertical position the over-all length is shortened for use on elevators.

Automatic Safety Devices

In order to operate, the foot pedal must be depressed, releasing the brakes and closing the circuit. The brakes are always applied when the truck is not running. To apply power, the controller handle must be in neutral, requiring the operator to start in first speed, and thus preventing "snubbing" of the motor, sparking under the brushes, and draining the battery. Should the operator step or fall from his platform, releasing pressure on the foot pedal, the circuit is broken, cutting off the power, and the brakes are at once automatically applied, bringing the truck to a standstill. These features render the truck "fool-proof" against careless or inexperienced operators and meddlers.

Use as a Tractor

The rear end of the truck is equipped with a draw-bar attachment which permits the truck to be used as a light duty tractor. This draw-bar attachment is integral with the frame so that the pull is against the frame and not against the lift platform. In trailing with a load on the platform there is no strain on the elevating mechanism.

COWAN TRUCK COMPANY, HOLYOKE, MASS.

Cowan Electric Load-Carrying Truck

In hauling large loads, where an extra platform area is required, the Cowan Electric Load-Carrying Truck will be most effective, in factories, warehouses, terminals, etc. The

extra platform area is obtained by the location of the battery, which is underslung between the front and rear wheels.

The Cowan Electric Load-Carrying Truck is distinctly a Cowan product, with those outstanding features of simplicity, safety, capacity, stability, flexibility in operation and accessibility of all parts which are responsible for the proven performance of all Cowan Trucks.

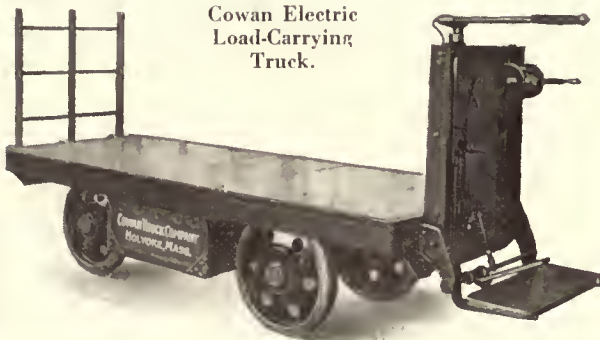

Cowan Electric Load-Carrying Truck.

Operating Features

The few requisite control levers are so conveniently arranged that the operator stands in a natural and easy posture. As in the Cowan Electric Self-

Loading Truck, the foot pedal must be depressed before the truck can be operated. The brake is always applied when the truck is not running. To apply power, the controller handle must be in neutral, requiring the operator to start in first speed. The heavy duty, drum type controller with integral circuit-breaker provides 3 speeds forward and 3 reverse, three to five miles per hour loaded, with a maximum speed, empty, of 8 miles per hour.

Horizontal steering lever operates the four-wheel steer; this steer makes possible unusually sharp turns. Intersecting aisles 72 inches wide are readily negotiated.

Simple, Durable Working Parts

The driving mechanism of all Cowan Electric Trucks is interchangeable—a feature of great practical value. All working parts of the Cowan Electric Load-Carrying Truck are en-

closed by a patented, dust-proof and grease-tight covering. The universal joint, through which power is transmitted to the wheels, is entirely enclosed and operates in grease. The driving motor is a General Electric Company, heavy duty, series wound type, protected by a metal housing. Access, for inspection and oiling, is through a dust-proof slide. The truck body may be detached from the chassis by loosening four bolts.

Automatic Safety Devices

Duplicates of those in the Cowan Electric Self-Loading Truck, described on opposite page.

Extra Capacity and Sturdy Construction

The Cowan Electric Industrial Tractor is designed solely as a tractor, and is not in any sense an adaptation of a load-carrying machine. However, the same perfection of design, sturdy construction and skilled workmanship are put into this tractor as into all other Cowan Products. It has a guaranteed tractor load capacity of 20,000 lbs. Four-spring suspension, with extra heavy helical springs. Machine guides, for the body to work on, transmit the draw-bar pull of trailers directly through power unit to body. Substantial front and rear bumpers; heavy, vari-height coupling heads. An extra heavy motor will stand frequent overloading. The universal joint is enclosed by a patented, dust-proof, grease-tight cover.

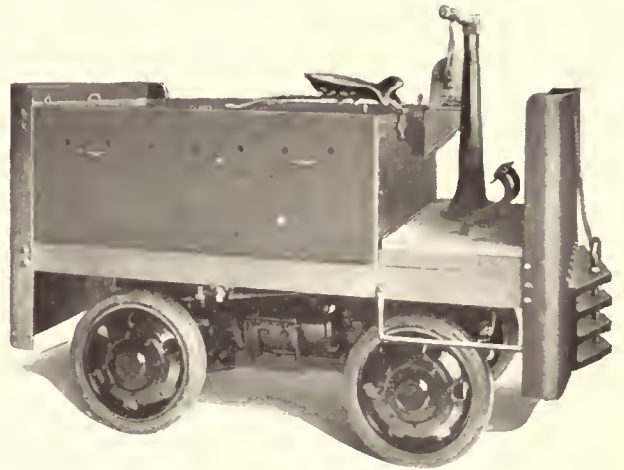

Cowan Electric Industrial Tractor.

Simple, Safe and Flexible Operation

From a comfortable operating position the tractor may be operated over any surface, for it has a ground clearance of $4\frac{1}{2}$ inches. Four speeds forward and four reverse, up to 7 miles per hour. End-control, four-wheel drive (2-wheel drive optional construction), four-wheel steer. Turning radius to extreme outside point of 68 inches. The tractor will operate in intersecting aisles 66 inches wide. Danger-, fool- and meddler-proof, for the controller has an interlocking safety device, and extra large braking surfaces are provided to stop tractor immediately. A train of Cowan Self-Loading Hand Trucks will give the greatest satisfaction as trailers.

Accessible and Interchangeable Parts

As in all Cowan products, all working parts are readily accessible. The entire frame can be lifted upon the removal of 4 nuts, disclosing the driving mechanism for inspection or oiling. The hinged cover of the battery compartment gives access for flushing, while the side plates of the compartment may be withdrawn for removal and replacement of batteries.

A very practical advantage of this tractor is the interchangeability of all wheels, with their bearings, knuckles and yokes.

MERCURY TRACTORS AND TRAILERS

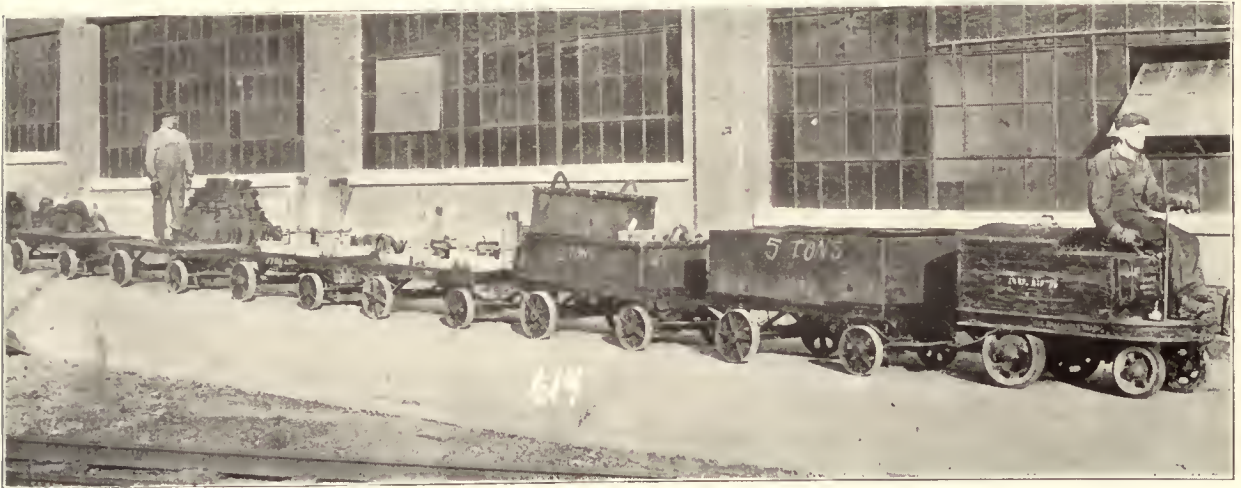

"Trackless Train" on outdoor inter-departmental run

Mercury "Trackless Train"

well the material handling system advocated by the Mercury Company.

The function of the "Trackless Train" is to bring about efficiency and economy in the handling of materials by replacing hand truckers or less suitable mechanical methods.

The "Trackless Train" makes use of a powerful and compact motive unit (The Mercury Electric Tractor) to push or pull the materials to be moved on trains of trailers. The power unit being separate from the train is able to work continuously and wastes no time in loading and unloading at terminal points. At the same time the unit utilizes to the fullest extent its ability to perform work by pulling its payload rather than carrying it. These transportation principles as exemplified in the steam railroad have withstood the test of time for over an hundred years.

The field of the Trackless Train is unlimited. Installations have been made in practically every classification of industry. Numbered among the users are:

Packing Houses	Express Companies
Steel Mills	Machinery Manufacturers
Foundries	Tanneries
Steamship Docks	Lumber Mills
Railway Freight Houses	Boots and Shoes
Automobile Manufacturers	Fertilizer Plants
Rubber Goods	Chemical Plants
Textile Mills	Paper Mills
Cotton Compresses	Tobacco Warehouses
General Warehouses	Car Shops

Mercury Tractors

The Mercury Tractor, motive unit for "The Trackless Train," is offered in three distinct types; a light-duty (Type K), a medium duty (Type L), and a heavy duty (Type M). Each type is built in a "three-wheel model" and in a "four-wheel model." All types follow the same uniform design and standardization of parts and assemblies is maintained throughout the entire line. Essential specifications and dimensions follow:



Mercury Tractor—Type L—4-wheel Model

Over-all Length, 68 ins.
Over-all Width, 39 ins.
Wheel Base, 39 ins.
Tread, Rear, 29 ins.
Tread, Front (four wheel model), 23 ins.
Size of Wheels (front), 15 ins.
Size of Wheels (rear), 20 ins.
Turning Radius, Outside Frame (three-wheel model), 57 ins.; four-wheel model), 71 ins.
Speed, Maximum with no Load, miles per hr., 7½.

Drawbar pull:—Type K, 500 lb. Type L, 800 lb. Type M, 1,600 lb.

Specifications in brief:

FRAME is of heavy channels bent to shape and riveted or in the case of the Type M, a single heavy semi-steel casting.

MOTOR used in all types is a General Electric automotive, series wound especially designed for tractor service.

CONTROLLER is of the drum type designed by the Mercury Company. Gives three speeds in either direction.

DRIVE is direct from the motor through a high efficiency worm gear to the rear axle.

MERCURY MANUFACTURING COMPANY
CHICAGO, ILLINOIS



"Trackless Train" moving bagged sugar from ship's side to storage

POWER PLANT is a unit assembly that can be easily and quickly detached from the framework without destroying alignments.

BRAKE is of the contracting drum type mounted on the motor shaft and operated by a foot pedal.

BATTERY CAPACITY for the Type K 12 cells of lead or 21 cells of Edison; for the Type L, 18 cells of lead or 30 cells of Edison; for the Type M, 24 cells of lead or 42 cells of Edison.

SPRINGS—all types and models are full spring suspended front and rear on semi-elliptic steel springs.

STEERING is accomplished by a lever.

pared to design and build special trailers to meet the unusual problem. The provision of trailer equipment exactly suited to the material to be moved is a distinct and important advantage of the tractor-trailer system.



Mercury Freight House Trailer—Type A-132

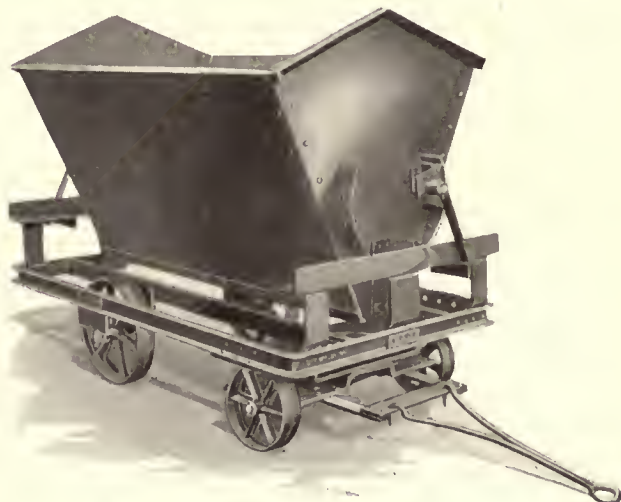

Mercury Side Dump Trailer—Type A-206

Mercury Trailers

Mercury trailers are designed and built expressly for service with the Mercury tractor in the "Trackless Train" system. The standard line embraces twenty-five distinct vehicles, each of

which has its own particular advantages in meeting the more common material handling problems. Two of the standard types are illustrated above. In addition to standard trailers the Mercury Company is also pre-

Engineering Service

The Mercury Company is the pioneer and only exclusive manufacturer of industrial tractors and trailers. We have accumulated a fund of valuable information relative to handling all kinds of material by means of tractors and trailers. Every "Trackless Train" representative is a tractor-trailer specialist. We will gladly confer with you and work with you to analyze your material movements. It is probable that the "Trackless Train" is the solution but at any rate an unbiased recommendation will be made. Offices are maintained in the following cities:

- Baltimore, Md.
- Boston, Mass.
- Buffalo, N. Y.
- Cleveland, Ohio
- Denver, Colo.
- Detroit, Mich.
- Greenville, S. C.
- Jacksonville, Fla.

- Milwaukee, Wis.
- Minneapolis, Minn.
- New York, N. Y.
- Philadelphia, Pa.
- Pittsburgh, Pa.
- St. Louis, Mo.
- San Francisco, Cal.
- Toronto, Canada

MERCURY MANUFACTURING COMPANY

CHICAGO, ILLINOIS

EXIDE-IRONCLAD STORAGE BATTERIES

The Requirements of a Heavy Duty Battery

The Exide-Ironclad Battery is one of many types produced by The Electric Storage Battery Company—the oldest and largest manufacturers in the world of storage batteries for every purpose and is especially built to meet the particular requirements of electric industrial trucks, tractors and locomotives.

It is made with a full realization that no industrial vehicle can deliver the service of which it is capable, unless the battery can furnish the necessary power as needed. This means (a) that the storage battery must be able to deliver power at high rates of discharge; (b) must permit of a good vehicle speed being maintained right through the day; (c) must have a high final voltage so that the speed and power of the vehicle may be maintained toward the latter part of the day's work. In addition, the battery must be sufficiently rugged to withstand the jolts and jars it is constantly subjected to, and it should require a minimum of care and attention.

Operating Characteristics

It is sometimes possible to obtain two or three of these characteristics, but the only battery to contain the combination of all four of the essential characteristics is the Exide-Ironclad Battery. By this we mean that it is the only battery



12 Cell Exide-Ironclad Battery for an Industrial Truck.

having the rare combination of high power-ability and ruggedness, with high efficiency and long life.

Yet, its first cost is reasonable; requires little care and attention; assembled in guaranteed Giant Jars and covers; rugged in every detail and the finished product of 33 years of battery building experience.

Where Exide-Ironclad Batteries Are Used

On a great majority of the United States Government's submarine boats, Exide-Ironclad Batteries are used for propulsion when submerged. In the submarines of seven foreign navies, Exide-Ironclad Batteries are also used.

In every make and type of electric industrial truck operating in plants of every description, these batteries

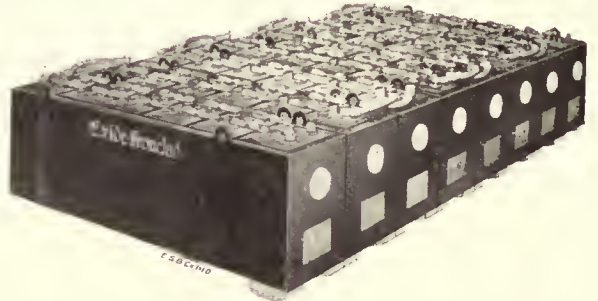

48 Cell Exide-Ironclad Battery for a Locomotive.

are making good. On industrial locomotives, on mine locomotives, and on thousands of electric street vehicles, Exide-Ironclad Batteries are furnishing power—economically, satisfactorily, and with the minimum of care and attention.

Constructive Features

Attention has already been called to the fact that the Exide-Ironclad Battery is rugged in every detail of its construction. But elaboration of one or two details of this con-



Two "Giant" Jars, in Which Exide-Ironclad Batteries Are Assembled, Supporting at Their Weakest Points, the Weight of 8 Men.

BRANCHES

NEW YORK.....23-31 West 43rd St.
West End Ave. and 64th St.
PHILADELPHIA..Allegheny Ave. and
19th St.; 671-673 N. Broad St.
WASHINGTON.. 1823-33 L. St., N.W.
PITTSBURGH.....Keystone Bldg.

ATLANTA.....Peachtree & Baker Sts.
CLEVELAND,
Chester Ave. & E. 24th St.
CHICAGO.....Marquette Bldg.
BOSTON.....718-20 Beacon St.
MINNEAPOLIS.....3 N. 15th St.
ROCHESTER.....184 Clinton Ave. S.

SAN FRANCISCO.....1536-56 Bush St.
CINCINNATI..600 Provident Bank Bldg.
DETROIT.....5740 Cass Ave.
ST. LOUIS..Federal Reserve Bank Bldg.
KANSAS CITY..17th and Walnut Sts.
DENVER.....1420-24 Wazee St.
SEATTLE.....811 White Bldg.

Exide Batteries of Canada, Limited, 133-157 Dufferin St., Toronto.

THE ELECTRIC STORAGE BATTERY CO.

19th & ALLECHENY AVE., PHILADELPHIA, PA.

EXIDE-IRONCLAD STORAGE BATTERIES

struction will serve to show how well built is the whole.

In the construction of its positive plate, the Exide-Ironclad is different from all others—another reason for this battery's long life. The active material, contained in numerous vertical tubes of finely slotted hard rubber, is in constant contact with the electrolyte, yet because of these fine rubber slits, cannot readily wash away and deposit in the bottom of the jars.



Cut-a-way Cell Showing New Construction — Positive Plates and Their Supporting Ribs; Negative Plates and Their Supporting Ribs; With Separators Extending Below All Plates.

The negative plate, of the same general type that has made the regular Exide negative plate so successful, is increased in thickness to meet the longer life and increased capacity of the Exide-Ironclad's positive plate.

The negative plates are sheathed at top with rubber; which with the rubber tubes of the positive, gives, at the top, a rubber to rubber assembly. This reduces the liability of short circuits within the cell.

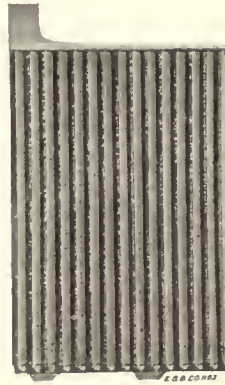

New Exide-Ironclad Positive Plate With Feet Which Raise It Above Its Supporting Ribs and Which Permit Separators to Extend Below It. Note Also the Slotted Rubber Tubes Which Contain the Active Material.

Now, as a glance at the accompanying illustration will show, these jars are equipped with four ribs ($2\frac{3}{4}$ inches in height). At the bottom of each positive and negative plate are two feet.

In assembling the cell, the positive plates rest on one set of ribs, while the negative plates rest on a different set. Better insulation of the plates is secured because the small feet raise them above the ribs and permit the separators to extend below them.

This construction reduces to the very minimum the liability of internal short circuits and insures longer life—a development of marked improvement in the construction of storage batteries.

It is this constant striving for something better, carried on through the 33 years that Exide Batteries have been manufactured, which makes the Exide-Ironclad such a superior battery today. To the plant executive, who has decided upon storage battery trucks, tractors, locomotives or commercial vehicles, Exide-Ironclads should be his battery choice, for they have been developed and perfected in the exacting school of experience.

Data is available of storage battery trucks running four years with no repairs to their Ironclad Exide batteries.

They have long life; give dependable day in and day out service; are economical and require but minimum care and attention.

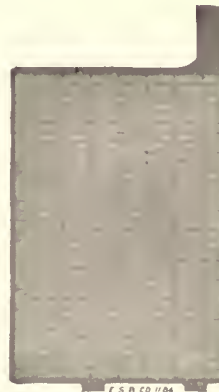

Negative Plate of New Exide-Ironclad Battery. Note position of Feet on This Plate With Relation to Feet on Positive Plate.

A New Feature of Assembly

Until recently, the Giant Compound jars, in which the Exide-Ironclad is assembled, were made with two supporting ribs, $1\frac{3}{4}$ inches high. Both positive and negative plates, as well as the separators between, rested on these two ribs.

USEFUL DATA ON THE EXIDE-IRONCLAD BATTERY

	7	9	11	13	15	17	19	21	23	25	27	29	31	33	
Number of plates	7	9	11	13	15	17	19	21	23	25	27	29	31	33	
Ampere hours service capacity (over 6 hours)...	102	136	170	204	238	272	306	340	374	408	442	476	510	544	
K. W. hrs. service capacity (over 6 hrs.) at 1.97 volts per cell201	.268	.335	.402	4.69	.536	.605	.670	.737	.804	.871	.938	1.005	1.072	
K. W. hrs. service capacity (over 6 hrs.) for 48 cells at 1.97 volts per cell	9.65	12.86	16.68	19.29	22.51	25.72	28.94	32.15	35.37	38.58	41.80	45.01	48.23	51.44	
Discharge in amperes for $4\frac{1}{2}$ hrs. (average voltage 1.97 per cell)	21	28	35	42	49	53	63	70	77	84	91	98	105	112	
Outside dimensions of cells, not including trays, in inches	Length	$2\frac{7}{8}$	$3\frac{3}{8}$	$4\frac{1}{8}$	$5\frac{1}{8}$	$5\frac{7}{8}$	$6\frac{5}{8}$	$7\frac{3}{8}$	$8\frac{1}{8}$	$8\frac{7}{8}$	$9\frac{5}{8}$	$10\frac{3}{8}$	$11\frac{1}{8}$	$11\frac{7}{8}$	$12\frac{5}{8}$
	Width	$6\frac{3}{8}$	$6\frac{7}{8}$	$6\frac{3}{4}$	$6\frac{7}{8}$	$6\frac{1}{4}$	$6\frac{3}{4}$	$6\frac{1}{4}$	$6\frac{1}{4}$	$6\frac{1}{4}$	$6\frac{1}{4}$	$6\frac{1}{4}$	$6\frac{1}{4}$	$6\frac{1}{4}$	$6\frac{1}{4}$
	Height $2\frac{3}{4}$ in. ribs	15	15	15	15	$15\frac{1}{8}$	$15\frac{1}{8}$	$15\frac{1}{8}$	$15\frac{1}{8}$	$15\frac{1}{8}$	$15\frac{1}{8}$	$15\frac{1}{8}$	$15\frac{1}{8}$	$15\frac{1}{8}$	$15\frac{1}{8}$
Weight of electrolyte	$4\frac{1}{4}$	$5\frac{1}{2}$	$6\frac{3}{4}$	8	$9\frac{1}{4}$	$10\frac{1}{2}$	$11\frac{3}{4}$	13	$14\frac{1}{4}$	$15\frac{1}{2}$	$16\frac{3}{4}$	18	$19\frac{1}{4}$	$20\frac{1}{2}$	
Weight of complete cell	$23\frac{3}{4}$	30	$36\frac{1}{2}$	$42\frac{3}{4}$	$49\frac{1}{2}$	$57\frac{1}{4}$	$63\frac{1}{2}$	70	$76\frac{3}{4}$	$82\frac{3}{4}$	89	$95\frac{3}{4}$	$101\frac{3}{4}$	108	

Height given is from bottom of jar to top of intercell connector, except where vertical diagonal connector is used when height should be increased $\frac{3}{8}$ inch.

THE ELECTRIC STORAGE BATTERY CO.

19th & ALLEGHENY AVE., PHILADELPHIA, PA.

THE IMPROVED "ROCHLITZ" AUTOMATIC WATER STILL

Distilled Water for Storage Batteries

It is absolutely essential to use distilled water in storage batteries to assure maximum efficiency and long life of the batteries.

The natural supply of water, as it issues from the earth, no matter how clear to the eye, is charged with iron, chlorine or nitrates. Iron causes self-discharge of the batteries, and chlorine and nitrates induce disintegration of the positive plates.

Filtered water is not pure water, as it contains the soluble impurities even though the insoluble impurities have been removed.

Water of condensation is highly undesirable, as the impurities are vaporized and carried over, due to the high temperature of high-pressure steam.

Distilled water is chemically pure because the temperature of the water is carried barely beyond 212 degrees, so that only the water vapor is carried over, and the impurities which require higher temperature to vaporize are retained in the undistilled water.

Distilled water, by eliminating the failures due to impurities, will prolong the life of the storage battery and assure maximum efficiency.

The Improved "Rochlitz" Automatic Water Still

The Improved "Rochlitz" Automatic Water Still will furnish a steady stream of pure distilled water free from carbonic acid and volatile impurities without any attention as

long as the electricity, gas or steam and the water supply holds out.

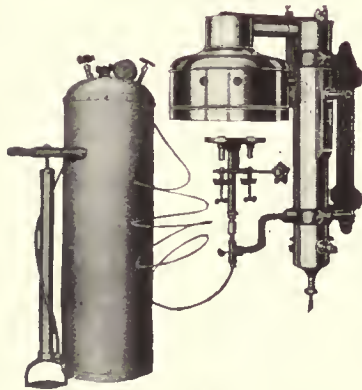

Gasoline or Kerosene Operated.

The cost of producing one gallon of distilled water varies from 1/2 cent to 2 cents, according to the kind of fuel used.

The Improved "Rochlitz" Automatic Water Still has the unqualified approval of all the leading manufacturers of storage batteries, and has been installed in over three thousand service stations.

Gasoline or Kerosene Operated Type

The equipment furnished with the gasoline or kerosene operated type includes Pressure Tank, Pump, Gauge, Valves, Hollow Copper Tubing, Special Kerosene or Gasoline Burner,

etc. The Kerosene and Gasoline Burners are powerful, wickless and odorless.

Gas Operated Type

The gas operated "Rochlitz" Automatic Water Still operates equally well with artificial or natural gas. It delivers absolutely pure, cold, aerated distilled water at a cost of less than 2 cents per gallon on a basis of \$1.00 per M for gas.

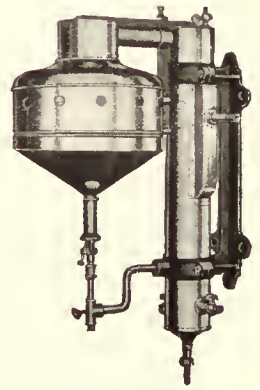

Gas Operated Type.

Electrically Operated Type

The electrically operated stills are equipped with Bayonet Type Immersion Heaters. This makes a very efficient heater as all the heat must go into the water.

The Heater is removable and consequently can be cleaned readily. It is of strong and rugged construction and is designed to withstand abuse and heat.



Electrically Operated.

A Control Switch with 6 feet of cord is supplied with this equipment.

The Heating Units are furnished for all standard voltages up to 250 volts; alternating or direct current.

A saving in transportation charges for carboys and water is made possible by purchasing C. P. Acid and reducing it to the proper battery strength with distilled water which can be obtained so economically by means of the Improved "Rochlitz" Automatic Still.

Steam Operated Type

The steam operated still can be attached to any boiler. It is simple and effective in operation and can be installed at a very small expense. It produces distilled water at average cost of 1/2 of a cent per gallon.

All impurities thrown down in the boiling process are flushed out at the apex of the conical bottom of the boiling chamber.

Approximately one thousand "Rochlitz" Water Stills have been purchased by the United States Government.

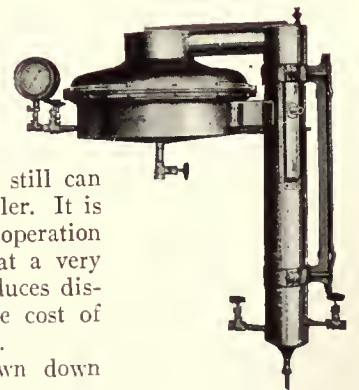

Steam Operated.

W. M. LALOR COMPANY

MAIN OFFICE 208 S. LA SALLE ST., CHICAGO, ILL. FACTORY 108-128 N. JEFFERSON ST., CHICAGO, ILL.



Crescent Truck Taking Load Up Grade Into a Freight Car.

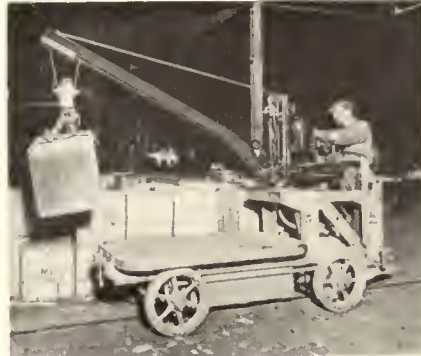

Crescent Crane Truck Breaking Out Stock.



Crescent Dump Body Truck in Dumping Position.

Crescent Load-Carrying Trucks

The Crescent electric industrial-truck is especially designed for severe working conditions. It will run without recharging with a full working load for ten hours. Four-wheel steer assures flexibility in operation. Outside turning radius, 8 ft. 2 in. Carrying capacity—4,000 pounds; Weight about 2,300 pounds (depending on Exide or Edison battery equipment); Speed per hour—light, 7 to 8 miles; loaded, 5 to 6 miles; Loading platform—7 ft. 6 in. long, 44 in. wide; Height—23 in. Overall length—9 ft. 3 in. Tread—36 in. Wheel-base—4 ft. 10 in.

Crescent Crane Trucks

The Crescent electric crane truck will carry a pay load of 4,000 lbs., and has a lifting capacity of 1,500 lbs. The speed of hoist is 12 ft. per min. It will tow a trailer or serve in handling cargo to trucks or trailers. Platform length—5 ft. 6 in., length 9 ft. 3 in. Turning radius—8 ft. 2 in. to outside corner of truck, 3 ft. 6 in. to inner edge. Wheel Base—4 ft. 10 in. Tread—36 in.

Crescent Dump Body Trucks

The Crescent dump body truck has a carrying capacity of 4,000 lbs., or 27 to 40 cubic feet. Its four-wheel steer enables a turning radius of 8 ft. to outside edge of truck. Its traveling speed is 6 to 7 miles per hour light, or 5 to 6 miles load. Chassis dimensions are the same as for the crane truck. The dump body apparatus can be readily demounted and truck used for general utility.

Crescent Tractors

Crescent Tractors are of two types. The Three-Wheel Tractor has draw bar pull normal 400 pounds, ultimate 1,500 pounds. Speed per hour, loaded, five miles, without load, seven miles. The outside corner swings on a radius of five feet two inches.

The Four-Wheel Tractor has a draw-bar pull normal, 600 pounds; ultimate, 2,400 pounds. Speed per hour, loaded 4 miles, without load, 6 miles. The outside corner swings on a radius of nine feet.

Both types have three forward and three reverse speeds. Positive stop at neutral.

Crescent Trailers

The Crescent standard trailer is designed for rugged work. Unusual flexibility is afforded by the fifth wheel wagon type construction and the use of large wheels and roller bearings. Capacity—4,000 lbs. Platform—7 ft. long, 3 ft. wide, 20 in. from floor. Steering—fifth wheel, assuring perfect tracking and eliminating unnecessary wearing parts. Dump bodies or other devices can be installed.

Industrial Haulage Engineering Service

Crescent engineers have made a special study of handling and haulage problems. They are continually in contact with ways and means of getting results. Their services are available, without obligation, for the development of the proper methods and systems of handling material.



Crescent Four-Wheel Tractor.



Crescent Wagon-Type Trailer.



Crescent Three-Wheel Tractor.

STROM BALL BEARINGS

Strom Ball Bearings

Strom
BEARINGS

and every possible care is taken to make Strom bearings as nearly perfect as possible.

The U. S. Ball Bearing Manufacturing Company makes ball bearings of all types and sizes to operate under any conditions of load and speed. The highest grade of ball bearing steel is used in both raceways and balls. A rigid inspection of the work from raw material to finished product is in force



Double-acting Self-aligning Thrust Bearing, 2100 Series

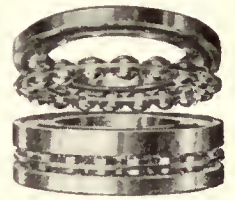

Double-acting Thrust Bearing, Flat Seats. 2100F Series

ing for misalignment. They are of the sturdy construction for which Strom bearings are noted and are adapted to sustain exceptionally large thrust loads.

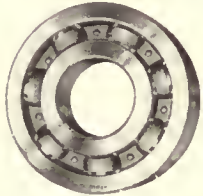

Radial Bearing

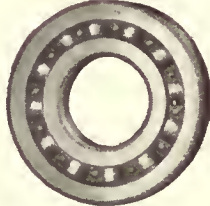

Angular Contact Bearing

Strom Radial Bearings

Strom radial bearings are made in any size for light, medium or heavy duty. They have deep grooved ball races in which large sized balls, separated by a light and sturdy retainer, roll with the least friction. They are especially adapted to sustain heavy radial loads under severe operating conditions. They are capable of resisting end thrust loads up to 25% of their available radial capacity in either direction.

Strom Angular Contact Bearings

Strom angular contact bearings are made in the same sizes and interchangeable with the radial bearings. They are of similar construction to the radial bearings, except that they are designed to support combinations of radial and heavy end thrust loads acting in one direction. They have an end thrust capacity equal to 150% of their available radial capacity.

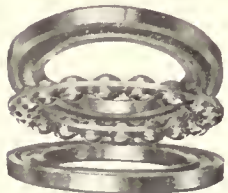

Single-acting Thrust Bearing with Flat Seats (Grooved Races). 1100F Series



Single-acting Self-aligning Thrust Bearing, 1100 Series.

Strom Thrust Bearings

Strom thrust bearings are made in all types and sizes with flat and grooved races to meet all conditions of speed and thrust load, acting in one or two directions, and compensat-

Strom Engineering Service

The engineering department of the U. S. Ball Bearing Mfg. Co. is composed of a staff of ball bearing experts, who will be glad to consult with and advise manufacturers of industrial trucks, tractors, conveying machinery, etc., in the selection of bearings. It is the company's desire that this service be utilized by those who have bearing problems to solve.

Strom Guarantee

There are four conditions which must be met if ball bearings of the proper load carrying capacity are to give entire satisfaction in operation. First: The race rings mounted on rotating machine members and in housings must have the correct fit.

Second: The method of mounting must be suited to the type of bearing used.

Third: The bearings must be correctly lubricated.

Fourth: Dust, dirt, grit and water must be kept out of the bearings.

The U. S. Ball Bearing Mfg. Co. guarantees its bearings to be free from all defect of workmanship and materials. If any bearing proves defective within one year from the date of its purchase from the company, they agree to replace it free of cost, providing always that the bearing was properly mounted, housed and lubricated. Any bearings to be replaced must be delivered to the company at Chicago with the transportation charges prepaid.

Further Information

To those interested in further information regarding bearings any of the following publications will be furnished on request.

Strom Bearings Catalog
S.A.E. data sheet size.

Pamphlets: S. A. E. Data Sheet Size

Lubrication of Ball Bearings. Limits and Allowances on Shafts and Housings.
Calculating Bearings Loads.
Interchangeable Sizes of Strom Bearings.

U. S. BALL BEARING MFG. CO.

(Conrad Patent Licensee)
4535 PALMER STREET, CHICAGO, ILL.

"IDEAL" INDUSTRIAL TRUCKS AND TRACTORS

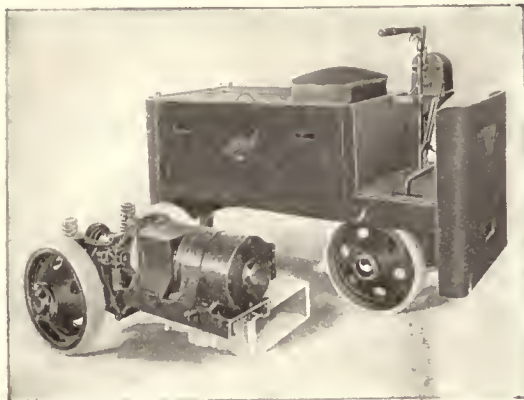

Complete Power Unit Removed from Tractor.



Complete Power Plant Being Installed in a High Load-Carrying Truck.

Models of IDEAL Trucks and Tractors

There is a type of Ideal Truck and Tractor for every purpose of Industrial Hauling; Heavy and Light Duty Four Wheel Tractors; Three Wheel Tractors; High Load-Carrying Trucks; Low Load-Carrying Trucks; Elevating Platform Trucks; Tier Lift Trucks; Trucks equipped with Crane; Side Dump Body or End Dump Body and Industrial Locomotives.

Interchangeable Power Unit

On all of these types except the Locomotives the complete Power Unit is interchangeable and a change can be made by two men in 30 minutes. The following parts comprise the Power Unit: Motor; Hill Climbing Device; Brake; Rear Axle Housing with Worm, Worm-Gear and Differential; Rear Axle; Universal Joint; Drive Wheels; Motor-Frame and Motor Trunnion Saddle. The complete power unit is hung on two trunnions permitting it to swivel on a horizontal axis and by virtue of properly proportioned coil springs between the rear axle housing and the frame, thus relieve the frame of strain and stresses resulting from wheels passing over obstruction or depressions.

IDEAL Hill Climbing Device

A new feature in Industrial Truck design invented, patented and manufactured by the Binghamton Electric Truck Company; a simple arrangement of three gears and a positive 3-jawed horn clutch. Ordinarily the motor drives directly through the clutch, but in order to ascend steep

grades or pull excessive loads over bad ground with only a normal ampere consumption, the clutch is thrown out and the gears meshed, changing the over all reduction of the drive from $17\frac{1}{2}$ to 1, to 35 to 1.

Electrically Welded Frame

The entire frame is electrically welded, doing away with riveting and bolting. The battery-cradle on the load carrier trucks and the battery-box on the tractors, form a part of the frame, reinforcing it at the center. Full advantage has been taken of the heavy section of the bumper plates to strengthen the entire construction.

Over All Width

The standard over all width of all Ideal Trucks and Tractors is 34", enabling them to pass through a 36" door-way and thus eliminating the necessity for remodeling doors and runways in older factories.

IDEAL Service

We maintain a staff of expert Industrial Transportation Engineers whose services are at your disposal in selecting the proper type of Ideal Trucks and Tractors.

Classification

All types of Ideal Trucks and Tractors are classified according to battery capacity as indicated in the table of classes of type MM Tractor. All other parts are identical on all classes.

CLASSIFICATION OF TRACTORS, TYPE MM								
Class	Battery			Capacity			Speed In M. P. H.	Weight Complete Pounds
	Type	Cells	Plates	Amp. Hrs.	K. W. Hrs.	Ton Miles		
A	Ironclad Exide	24	17	272	12.86	85.65	1 to 6	3850
	Edison	42	G-9	225	11.62	77.49	1 to 6	3275
B	Ironclad Exide	24	15	238	11.26	75.02	1 to 6	3650
	Edison	42	A-6	225	11.32	75.60	1 to 6	3250
C	Ironclad Exide	20	17	272	10.72	71.45	1 to 5	3600
	Edison	36	G-9	225	9.96	66.42	1 to 5	3125
D	Ironclad Exide	20	15	238	9.38	62.51	1 to 5	3400
	Edison	36	A-6	225	9.72	64.80	1 to 5	3100



Ideal Tractor Assembled.

BINGHAMTON ELECTRIC TRUCK CO.
MAIN OFFICE AND WORKS, BINGHAMTON, N. Y.

EDISON STORAGE BATTERIES

Application

Industrial Trucks and Tractors, Electric Street Trucks and Lumber Carriers need a battery having strength, long life, light weight and dependability. A brief description indicates how well the Edison Battery fills all the requirements.

The Edison Nickel-Iron-Alkaline Storage Battery consists of a new and scientifically correct combination of iron and nickel elements in a non-acid electrolyte. This new combination, the result of several years of painstaking work on the part of Thomas A. Edison, eliminates a long list of ordinary battery troubles, and achieves a simplicity and permanence hitherto unbelievable in battery construction.

Each Edison cell is encased in a steel container or "jar" having corrugated sides for increased strength, with top and bottom, both steel, welded on. The positive plate is made of steel tubes, and the negative of steel pockets. The positive tubes contain metallic nickel and nickel hydrate in layers; the negative pockets contain iron oxide.

The positive and negative plates, suitably mounted on steel connecting rods and poles, are intermeshed, properly insulated, and submerged in the alkaline solution, or electrolyte.

The chemical reactions do not destroy the mechanical strength of the battery; rather the alkaline solution is a preservative of the iron and steel members.

Exclusive Advantages

A few of the exclusive advantages resulting from its distinctive characteristics follow:

It is light in weight. The steel container is unbreakable.

It suffers small loss of charge when idle. No frequent hydrometer readings are necessary. The tray assembly and cell connections are simple. Severe vibration and concussion have no effect upon it.

It steadily increases in capacity for the first eight to twelve months.

Temperature of electrolyte may rise to 115 degrees Fahrenheit without harm. Sulphation and kindred "diseases" like buckling or growing of plates, are impossible. It may be boosted at high rates, several times normal rate being safely recommended for short periods. It is hermetically sealed except for the single filler opening, no plate renewals, no wood separator renewals or other repairs needed.

It may be left standing idle, either charged or discharged, for months at a time without injury and with absolutely no attention.

It gives off no noxious fumes and can be placed in any environment without fear of corroding nearby metal, or injuring persons in the neighborhood. It can be put on charge at any time, regardless of how little or how much of the previous charge has been used and similarly, it may be taken off charge at any time and used, whether fully charged or not.

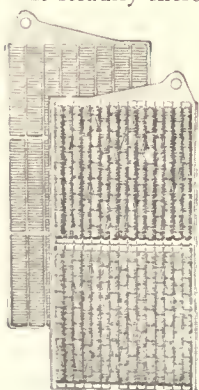

Plates of the Edison Cell. Positive in front, negative behind.

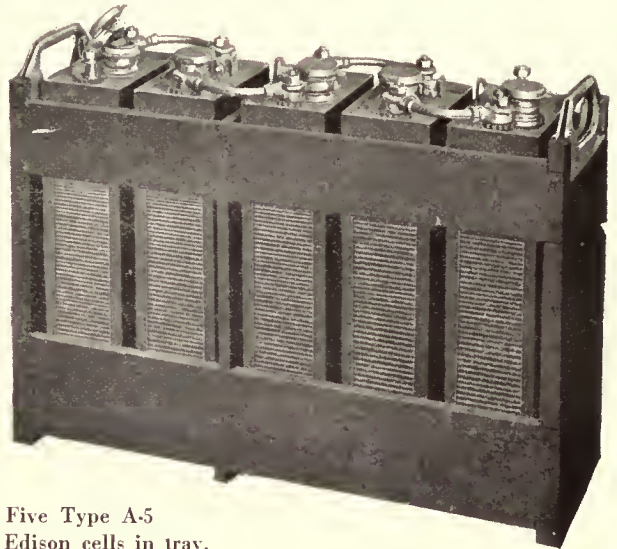

Five Type A-5 Edison cells in tray.

No expert battery man is required to handle an Edison Battery. Your electrician can secure the very best of results.

The Edison cell to cell connectors are made of copper and are practically unbreakable. No lead straps to burn out with subsequent delay and expense incident to their repair.

Accidents that are bound to occur occasionally, as for example, short circuits, continued overcharges, charges in the reverse direction, excessive "Boosting," or charging at too low a rate, have no permanent effect upon its life.

Operation and Maintenance

There is nothing complicated, nothing mysterious about the storage battery. The steel and iron construction and the nickel-iron-alkaline principle of the Edison Battery practically eliminate all battery troubles. Besides charging, practically all the care the battery needs is keeping outside of cells clean and adding distilled water. With no regular plate renewals; no broken parts or cracked containers; and no ordinary accident that will put the battery out of commission, the Edison Battery gives continuous and uninterrupted service.

Permanence

The characteristics of long life and ruggedness that are features of the service of Edison Batteries may be summed up in one word—permanence.

That this feature is highly important in economical and successful operation hardly need be pointed out. Yet such is the superiority of Edison Batteries in this regard that special attention should be paid to this point when considering storage batteries for severe service.

The ability to deliver continuous full rated capacity, even after years of service, is a feature distinctive of Edison Batteries. As a matter of fact, the maximum life for an Edison Battery cannot yet be stated. A great many Edison Batteries installed six and seven years ago are still performing their daily work satisfactorily; there have been no renewals of plates or separators.

EDISON STORAGE BATTERY CO., ORANGE, N. J.

For general data on Edison Batteries see page 719

BAKER INDUSTRIAL TRACTORS AND TRUCKS

Adaptability of Baker Trucks and Tractors

The Baker R & L Company manufactures electric trucks and tractors for inter-departmental, factory and other phases of industrial transportation.

Baker trucks and tractors are in efficient use by scores of the leading corporations of the country. They wind their way down narrow aisles, turn the sharpest of corners, climb ramps and perform the widest variety of tasks. Whether the nature of the work requires a husky pull or the rapid shifting of light loads, a 75% saving in cost of material-handling over the cost of hand truckage is not uncommon. Something more than 60% of all sales are repeat orders from satisfied customers.

98% of Parts Standardized

All parts are ruggedly constructed to meet the most severe usage. Every part has been specially developed for its particular service by engineering specialists who have been building

battery-driven vehicles since the beginning of the industry.

Ninety-eight per cent of all parts on all models are identical and interchangeable. This reduces manufacturing costs and user's stocks of spare parts. In emergencies complete units may be transferred from one truck to another.



Baker Utility Truck

either 2 or 4-wheel drive. Steering is accomplished through all four wheels.



Baker Low Platform Truck

load-carrying capacity, 6,000

pounds. The Low Platform Truck can be equipped with either end or side dump bodies of 27 or 40 cu. ft. in order to handle bulk material such as coal or ashes.



Baker Elevating Truck

metal platforms, it is a remarkable labor-saver in handling large quantities of material over short or long distances. Two-wheel drive; four-wheel steer; load-carrying capacity 4,000 pounds.

The Baker Utility Truck, as its name signifies, is designed for general trucking throughout the factory. It has a load carrying capacity of 4,000 pounds and is furnished with steering is accomplished

The Baker Low Platform Truck is built with the platform as near the ground as possible to facilitate loading, when the load is composed of heavy units stacked on the ground. Two-wheel drive; four-wheel steer, load-carrying capacity, 6,000

The Baker Elevating Truck raises and lowers its load platform 4½ inches in 10 seconds by means of an auxiliary electric motor. Operated in combination with an equipment of wooden or

Both the boom and the load hoists are electrically driven on Baker Jib Crane Trucks. The separate controls are operated from the dash and hence the truck and crane are always under control of the operator. Hoisting capacity, 1,500 pounds; truck capacity, 3,500 pounds.

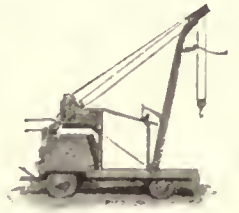

Baker Jib Crane

Baker Swivel Hoist Trucks are regularly furnished with a hoisting capacity of 1,000 or 1,500 pounds. The carrying capacity of the truck is 3,500 pounds. The hoist locks in the central position and is electrically driven by a separate motor.



Baker Swivel Hoist Truck

Baker Tractors are built in two models. The three-wheel type has a rated draw-bar pull of 300 pounds and a starting draw-bar pull of 1,800 pounds. Its speed varies from 1 to 6½ M.P.H. and it trails a load from 7½ to 15 tons.

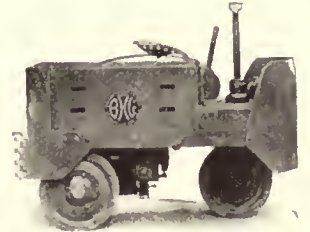

Baker 3-Wheel Tractor

The four-wheel tractor has a rated draw-bar pull of 400 pounds and a starting draw-bar pull of 2,000 to 3,000 pounds. It is built with two or four-wheel drive and four-wheel steer. The speed can be varied from 2 to 6 M. P. H. and will haul from 10 to 20 tons. The four-wheel tractor is also furnished in the locomotive type with flanged wheels for industrial railways.



Baker 4-Wheel Tractor

In all models the Baker tractor is a definitely huskier and more rugged machine than is commonly offered.

Baker Series "C"

Baker Series C sets entirely new standards for industrial tractors and trucks. Numerous refinements of construction put these machines in a class by themselves. Every one of these refinements is aimed at continuity of service and Baker Series C Tractors and Trucks move heavier loads, move them farther on a charge and cost less to operate than any industrial truck yet produced.

Duplex Compensating Suspension

An exclusive Baker axle suspension which allows for more flexibility, maintains accurate alignment at all times between the axle and the frame and relieves the springs of all driving strain. It reduces wear and tear on the machines and cuts maintenance costs.

BAKER INDUSTRIAL DIVISION OF

THE BAKER R & L COMPANY, CLEVELAND

**Universally
Used**

States, and many abroad, installing this haulage system.

Over one thousand of these users, representing 173 branches of industry, have adopted Elwell-Parkers for their standard.

Elwell-Parker Haulage Units are backed by the longest actual experience in this industry. All types incorporate the most recent electrical and mechanical improvements developed in the automotive and machine tool industries. Average upkeep costs on an Elwell-Parker will prove to be less than on any other make of electric or gasoline truck or tractor used for inside transportation.

**Points of
Superiority**

Fewer Parts.
Shorter Wiring.
Larger Wheels.
Greater Clearance.
Larger Motors.
Greatest Mileage.

No Fuses Required.
Full Floating Axles.
Removable Bushings.
Interchangeable Parts.
Free Coasting Worms.
No Delicate Parts.
Oversize Bearings.
Safer on Inclines.
Independent Brakes.
Interlocked Control.
Unit Power Plants.

Impossible to move unless operator is on truck. Brakes set automatically when dismounting. All parts accessible whether truck is loaded or empty.

Key to illustrated types opposite—

- No. 1 & 2 "Self-Loading" Elevating Platform Truck.
- No. 3 Light Utility Platform Load Carrier.
- No. 4 "Self-Loading" Revolving Crane Truck.
- No. 5 & 12 Heavy Duty Tractor or Floor Locomotive.
- No. 6 & 11 Heavy Utility Platform Load Carrier.
- No. 7 & 8 Straight and Drop Frame Baggage Truck.
- No. 9 Carrier with Detachable End Dump Body.
- No. 10 Carrier with Detachable Side Dump Body.

**General
Specifications**

Speeds—400 to 700 ft. p.m.
Truck Capacities—4,000 lb.
Crane Cap—1,000 to 3,000 lb.
Platforms—10 to 35 sq. ft.
Platform Height—11 to 33".
Dump Cap—30 to 40 cu. ft.

Four Wheel Steer Trucks, Front Wheel Steer Tractors, Special Roll Paper, Furnace Charging, Stacking, Ammunition, Crane, Dump, Tying, Lifting or Flanged Wheel Trucks for rail operation. Exide Iron-clad or Edison Battery furnished to operate 15 to 20 miles per charge. Power costs approximately 25c. per day.

One man with a Lift Truck has handled 125 to 150-4000-lb. loads on separate platforms, a distance of 400 to 500 feet per day.

One man with a Tractor has transferred 275 tons of bagged goods a distance of 1,800 ft. in seven hours.

A Crane Truck saved \$27.70 per day for one user stacking castings in the storage yard.

Complete data will be furnished upon request.

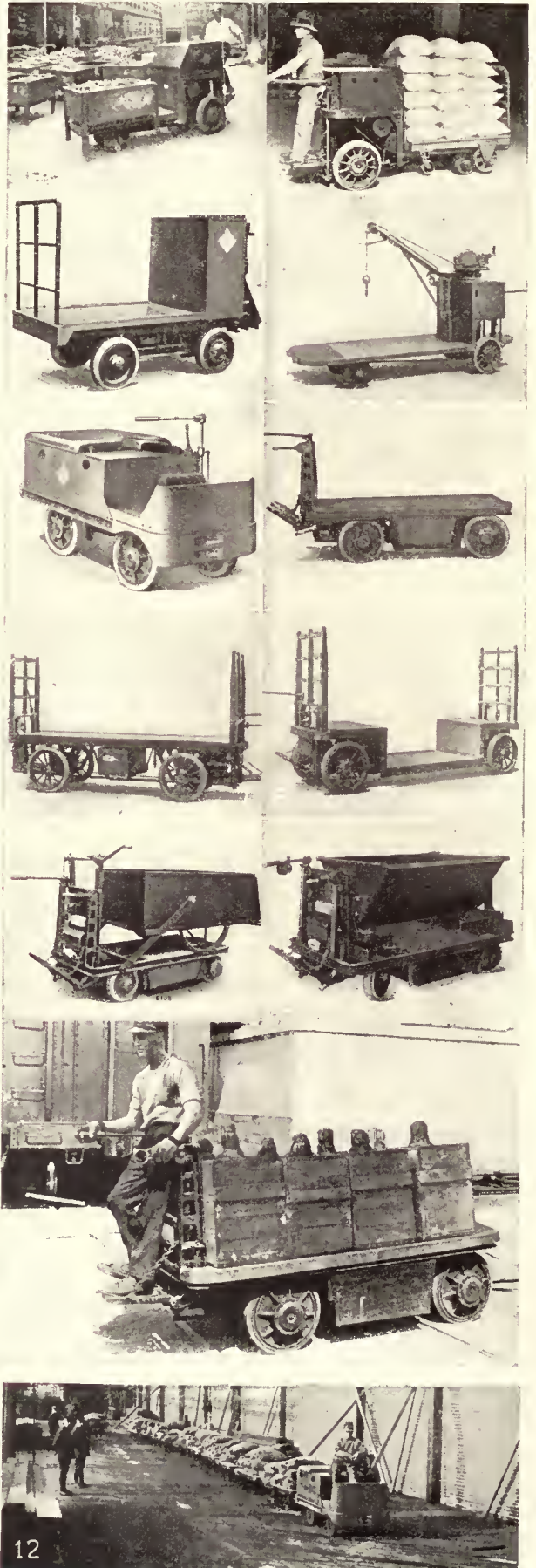

"AUTOMATIC" TRUCKS AND TRACTORS

A Type of Truck for All Conditions

Automatic Storage Battery Industrial trucks and tractors comprise eighteen different types, each of which is well adapted for the handling of certain classes of material.

There are three-wheel tractors, four-wheel tractors, rail locomotives, crane trucks, hopper trucks, lifting trucks, etc. The illustrations show some of these models.

Trucks are not needed for the tractor type and these tractors can haul their trains around corners, through narrow aisles and up grades. The Automatic Transportation Co. are the world's largest manufacturers of storage battery trucks and tractors.

Industrial Transportation Service

The most rapid and economical manner of conveying raw material of finished articles in a factory has in many cases proved to be by electric storage battery trucks or tractors. In the

case of the truck, the load is carried on a single self-propelled electric storage vehicle with a platform. In other cases a train of trailers is hauled either by a storage battery tractor or by an engine. Low cost of transportation is obtained because the truck or train will handle more material with less labor than hand trucks or teams. The operation of the machines is simple. Operating costs are low.



Type "E" Worm Drive.

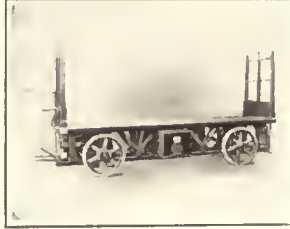

Straight Frame Baggage.



Three Wheel Tractor.

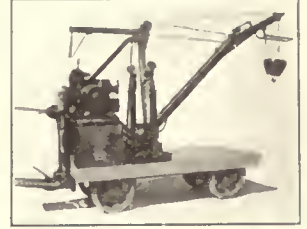

Type "E" 3000 lb. Crane.

Type "E" Worm Drive; Length, 118"; Width, 41"; Platform, 98 x 41"; Height of platform, 22 $\frac{1}{8}$ "; Wheel base, 60"; Capacity, 4,000 lbs.

Straight Frame Baggage Truck; Length, 170"; Width, 44"; Platform, 144 x 44"; Height of platform, 33"; Wheel base, 96"; Capacity, 4,000 lbs.

Type "T" Three Wheel Tractor Worm Drive; Length, 72"; Width, 40"; Wheel-base, 41 $\frac{3}{4}$ "; Draw bar pull normal, 600 lbs.; Draw bar pull ultimate 1,600 lbs.

Type "E" Worm Drive Truck with 3,000 lb. crane—for specifications see Type "E" Worm Drive Truck.

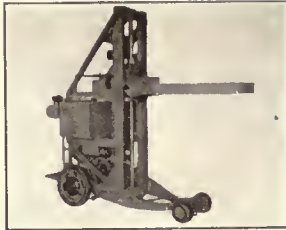

Tiering-Lifting Truck.

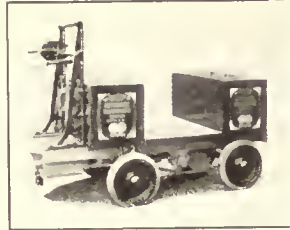

Type "D" Chain Drive.



Type AA Locomotive.

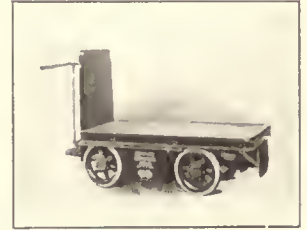

Type "R" Worm Drive.

Tiering-Lifting Truck made in three standard heights with lifts of 40, 60 and 75"; Length, 116"; Width, 37 $\frac{1}{2}$ "; Platform, 51 $\frac{5}{8}$ " x 26"; Wheel base, 56"; Capacity, 4,000 lbs.

Type "D" Chain Drive Tractor: Length, 76"; Width, 38"; Wheel base, 38 $\frac{1}{2}$ "; Draw bar pull normal, 250 lbs; ultimate, 1,000 lbs.

Type "AA" Locomotive made to fit gauges 18" to 36"; Length, 72"; Width gauge plus 6"; Wheel-base, 28"; Draw bar pull normal, 350 lbs.; Draw bar pull ultimate, 1,400 lbs.

Type "R" Truck Worm Drive; Length, 83"; Width, 28 $\frac{1}{2}$ "; Platform, 64 $\frac{1}{4}$ x 28 $\frac{1}{2}$ "; Height of Platform, 20 $\frac{1}{4}$ "; Wheel-base, 36"; Capacity, 2,000 lbs.

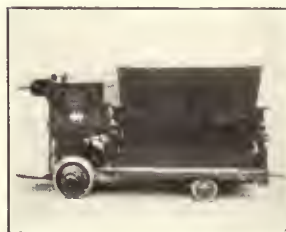

Type "H" Truck with Hopper.

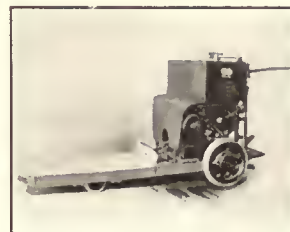

Type "L" Elevating Platform Truck.

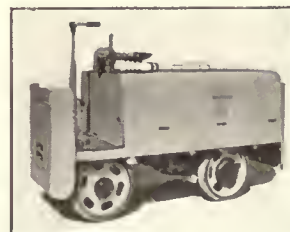

Type "M" Heavy Duty Tractor.

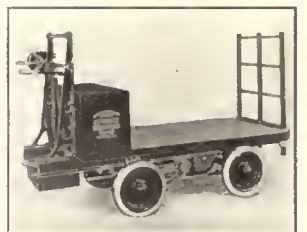

Type "D" Chain Drive Truck.

Type "H" Worm drive truck with hopper; Length, 111"; Width, 54"; Wheel-base, 52 $\frac{5}{8}$ "; Capacity, 4,000 lbs.

Type "L" Elevating Platform Truck; Length, 103"; Width, 37 $\frac{1}{2}$ "; Wheel-base, 54"; Height of Lift, 3 $\frac{1}{2}$ "; Capacity, 4,000 lbs.

Type "M" Heavy Duty Tractor Worm Drive; Length, 84 $\frac{3}{4}$ "; Width, 39 $\frac{3}{8}$ "; Wheel-base, 44"; Draw bar pull normal, 800 lbs.; ultimate, 2,000 lbs.

Type "D" Chain Drive Truck; Length, 91 $\frac{3}{4}$ "; Width, 38"; Platform, 61 $\frac{1}{4}$ " x 36"; Height of Platform, 20"; Wheel-base, 38 $\frac{5}{8}$ "; Capacity, 4,000 lbs.

THE AUTOMATIC TRANSPORTATION CO.

Main Office, BUFFALO, N. Y. Branches in all principal cities.

POWELL PRESSED STEEL PLATFORMS

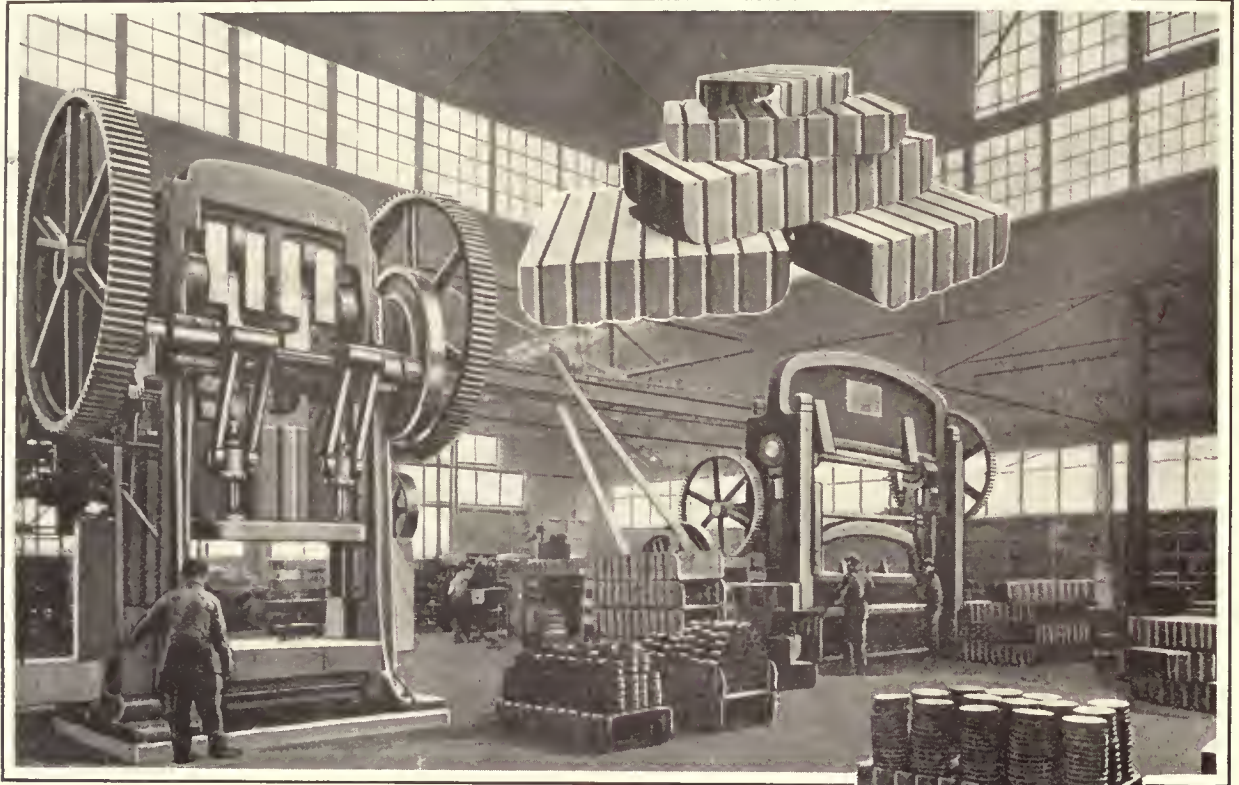

The Pressed Steel Platforms shown in the insert are produced cold on these giant presses. These two presses will handle material up to 13 ft. 6 in. in length, 60 in. in diameter, and draw to a depth of 20 in.

Powell Platforms Give Long, Lasting Service

Powell Pressed Steel Platforms are made of a single sheet of heavy gauge steel—without joints or seams. They are designed for service with any lift truck, carrying the heaviest loads with not the slightest danger of breakage or accident. Their lasting durability is practically unlimited. They never need repair and never collapse. They are pressed cold—standing absolutely rigid under the greatest strain.

One Powell Platform will outlast a dozen wooden ones. They are indestructible—never sag—never

cause delay—never give way under the heaviest loads.

Powell Platforms are designed to suit each particular user. They are made in any size and of any thickness from 7 to 12 gauge steel.

Strength in the Buckles

Powell Pressed Steel Platforms are shaped cold. In the illustration above are shown two of the presses on which the work is done. The most important feature of Powell Platforms is the buckle in the corner of each corrugation as shown in the lower illustration. It is this buckle which gives strength and rigidity to the legs of the platform. The corrugations of the platforms are $\frac{3}{4}$ inch deep and $1\frac{1}{2}$ inches wide, spaced on 6 inch centers. Cold forming of these deep corrugations makes the buckles which give the platform lasting strength. These buckles furnish the final touch of perfect rigidity and endurance.

The Most Economical Platform

The economy of Powell Platforms is evident when the heavy costs of repairing and replacing wooden platforms are considered. Powell Platforms are made to give service indefinitely—to do away with all repair costs and to stand the roughest usage. And their initial cost is so low that their comparison with wooden platforms need no longer be considered.

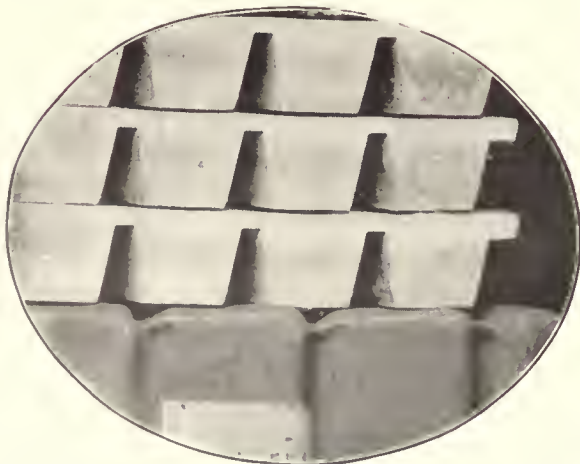

Showing Buckle in Corrugations of Powell Platforms.

THE POWELL PRESSED STEEL COMPANY, HUBBARD, O.

(Suburb of Youngstown, Ohio)

COWAN SELF-LOADING HAND TRUCK

Elevated with One Stroke of the Handle

is elevated by a single downward sweep of the handle lifting the loaded or empty platforms from the floor. It saves labor, time and floor space, and prevents wastage and breakage on account of goods being piled directly on the floor.

Standard and High Lift Types

There are two standard types, G and GB, of the Cowan Self-Loading Hand Truck, both with the same general structural features. The frame of type GB is wider than that of G, as it is intended for handling unwieldy and more bulky loads. Both are guaranteed up to 5,000 lbs. capacity, and as to materials and workmanship.

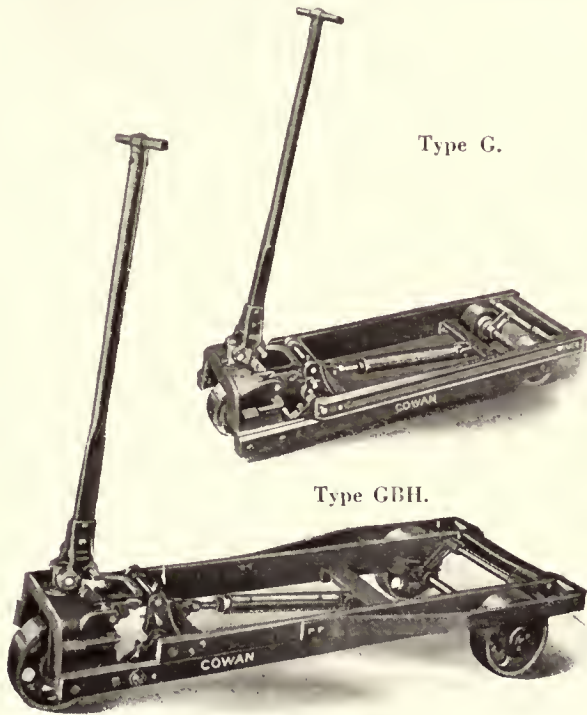

The standard lift is 1 13/16 inches, but there is a variation of each type, known as "high-lift types GH and GBH," with a lift of 2 3/4 inches. The additional height of the load above the floor or ground, when in transit on these high-lift types, is an advantage in traveling over rough surfaces.

Any type can be furnished with either one or two wheels in front, at the option of the purchaser. A pair of wheels in front give additional stability with bulky loads or over very uneven surfaces.

Mechanical Advantages

The materials used in the construction of the Cowan Self-Loading Hand Truck are selected as those best suited for each part. The most skillful workmanship in the construction of the truck, as well as the quality of the raw materials

used, are checked up by a series of inspections and tests starting with the selection of the raw materials and going through to the completed working product.

The handle fork straddles a king pin. This king pin is of large diameter and will withstand severe shocks.

Absolute accuracy on all machined parts insures smooth and flexible operation. A generous oil hole is provided for every bearing point and moving part. Every oil hole is conspicuous and accessible.

The wheels have wide flanges which add materially to the stability of the truck, at the same time conserving the floors upon which they travel. There are extra large roller bearings of the highest grade in each wheel. The oil reservoir assures perfect lubrication and the dust cap protects the bearings from dirt and grit.

Cowan Safety Features

There are several distinctive safety features incorporated in this truck. The lifting link drops away from the handle after the load is elevated. It cannot interfere with the steering nor engage the handle in lowering. An hydraulic release check lowers the load slowly and evenly to the floor. This check is of the compensating type so that heavy loads do not drop faster than light loads.

Platforms for Various Industries

Material entering the construction of the platform or skid while usually of spruce, varies according to the nature of the load. Special platforms for special loads can be designed and the Cowan Truck Company will be glad to cooperate with any Self-Loading Hand Truck user in designing platforms to suit his particular needs.

Service and Cooperation

Cowan representatives have been intimately connected with the solution of many material handling problems and will gladly study the problem of any prospective customer from every angle. They are at the customer's service to point out ways and means for time and labor saving, and to plan a system best adapted to his needs, whether it is desirable to use Self-Loading Hand Trucks or Electric Self-Loading Trucks (shown on page 732), or a combination of both.

Complete description, specifications and photographs will be sent upon written request.



COWAN TRUCK COMPANY, HOLYOKE, MASS.

CLARK TRUCKS

Standard Parts for All Trucks

The Geo. P. Clark Co. makes "everything in trucks" from a castor to the most complex and specially designed trucks for industrial use.

Each part of their regular truck is standard and made in large quantities. Special trucks are made from these standardized parts wherever possible to reduce the number of new parts to be made and cut down the cost of production.

Under ordinary circumstances the company can replace any part of any truck made either by themselves or by others when not covered by patents. Except in rare instances, this is done from stock. These parts can be furnished singly to individuals or in large quantities to manufacturers needing them for their own product.

Service for Truck Users

The company maintains a service department for the benefit of all users of trucks of any make. No problem is too insignificant to merit the attention of this department and none too big for it to handle. With complete standardization of parts, and the wide experience and skilled workmanship of its employees the company can give prompt, efficient service to all truck users.

Clark Transfer Trucks

The Clark three-wheel transfer truck is one of the lightest on the market. Strength has been maintained at the same time through the use of steel channels and flat bars. Carefully selected roller bearings render the wheels easy running and the truck stands up well under the most exacting conditions.

These two features, lightness and ease of operation, are most important factors. Incorporated in these trucks they save the workman the exertion of handling unnecessary weight and enable him to do a greater amount of work per day with less effort.

Clark transfer trucks are made with capacities ranging from 100 lbs. to 2,500 lbs. The frame rods and handle are all made of steel, the axles are steel fitted with iron wheels equipped with either Clark or Hyatt roller bearings. A fool proof device, operated by the handle, raises and lowers the upper frame of the truck, raises the load, moves the truck and lowers the load. The handle itself is attached to the top of a heap swivel which allows the truck to turn sharp corners easily.

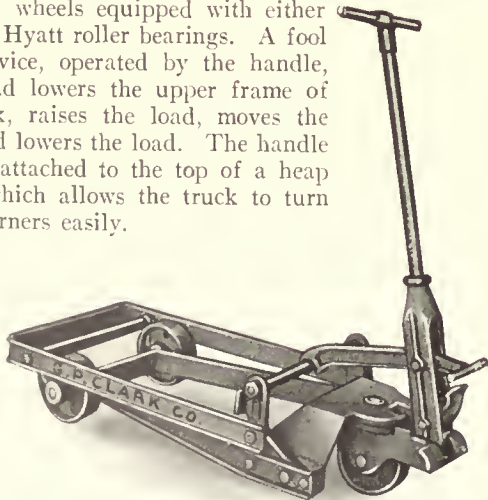

Clark Transfer Truck.

DIMENSIONS OF TRANSFER TRUCKS							
Type	Capacity	Length Over All Inches				Height of Top of Frame from Floor	
		Handle Down		Handle Up		Max.	Min.
		Frame Up	Frame Down	Frame Up	Frame Down		
WN31	1000	81½	85½	38½	44	77½	6
WN32	1000	91¼	95½	48½	54	77½	6
WN41	1000	82¼	86½	39½	45	87½	7
WN42	1000	92¼	96½	49½	55	87½	7
WN51	1000	82¼	86½	39½	45	97½	8
WN52	1000	92¼	96½	49½	55	97½	8
WN61	2500	78½	--	40	44½	8	6
WN62	2500	88½	--	50	54½	8	6
WN64	2500	88½	--	50	54½	8	6
WN65	2500	98½	--	60	64½	8	6

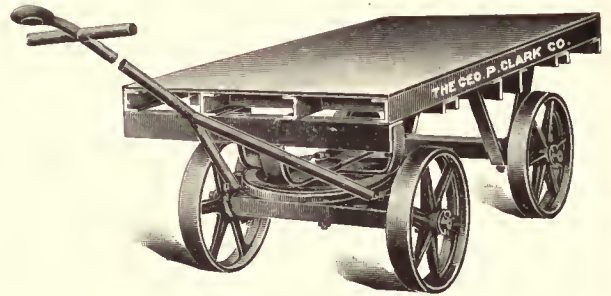

Combination Hand Truck and Trailer, Type NL11.

Other Clark Trucks

The combination truck and trailer shown above is built entirely of metal and designed for handling hot or cold sheet metal, large castings, etc.

The freight truck shown below is used around depots, docks, etc. It is well-made with sufficient bracing to guarantee a long life.

These trucks are two from among thousands built by this company. They have on file over one thousand photographs of special trucks which they have built for almost every conceivable purpose. These are in addition to the many standard trucks shown in the bulletins issued by the company. These bulletins are listed below and will be sent to anyone desiring them.



Clark Hand Truck, Type B3JFB15.

Bulletins:

AC Wheels and Casters.

D Trucks for Wood Workers.

E Butchers and Packers' Trucks.

F Fibre Cars, Rattan, Splint and Canvas Baskets.

G Office Trucks, Hospital Trucks.

H Miscellaneous Trucks.

J Platform, Table and Express Trucks, etc.

K Paper Makers and Printers' Trucks.

M Dry Goods, Dye House and Laundry Trucks.

GEORGE P. CLARK CO., WINDSOR LOCKS, CONN.

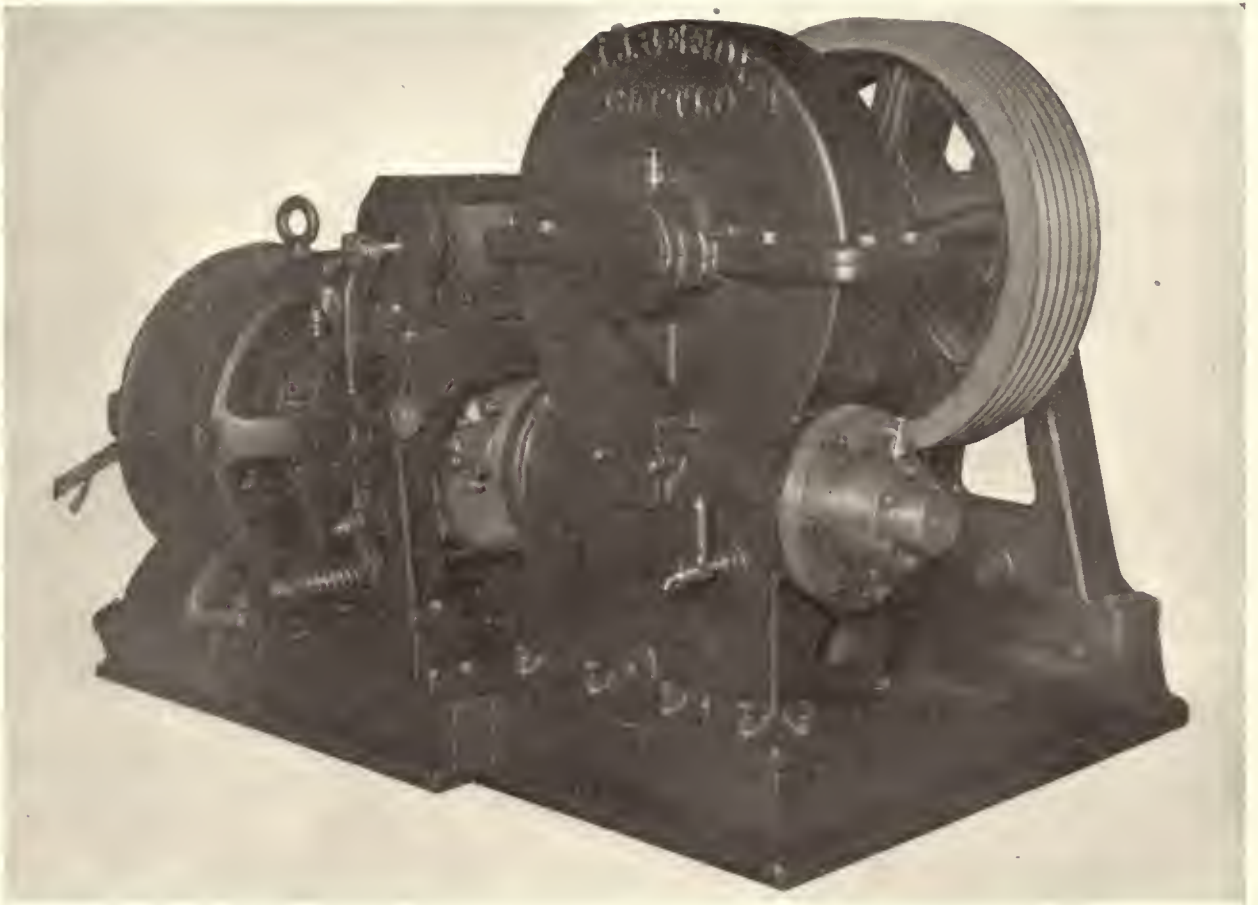

H. J. Reedy V-Groove Traction Drive Elevator.

**Half a Century
of Elevator
Experience**

The H. J. Reedy Co. was established in 1858. This company has to its credit the development of some of the permanent engineering advancements of the Elevator Industry in which Industry it was a pioneer.

This factory has been in continuous operation for over half a century and the highest standards of mechanical design with respect to safety, durability and economical service have been persistently maintained.

**Reedy V-Groove
Traction Drive
Elevators**

The illustration of the electric elevator shown on this page appears, to one not versed in elevator engineering, to be the ordinary electric elevator. Every part of the equipment shown is similar to standard machines with the exception of the driving sheave with its V-grooves.

The Reedy Co. has been using this V-groove traction method of drive for the past thirty-one years. A few years ago its principle was adopted universally. Any other type of traction drive elevator was not a success for the following reasons:

First, it was limited to the loads it could lift without slippage; second, the cost of maintenance was out of proportion to the service rendered; third, its cost of operation was prohibitive because of the excess current used.

With the adoption of the V-groove, the traction drive elevator became at once safer, less expensive to maintain and more efficient.

**Successfully
Designed by
Reedy Co.**

The design and manufacture of this V-grooved sheave is not as simple as it appears. Its very simplicity is deceptive. Its success depends upon engineering knowledge expressed in a series of formula acquired by years of experimenting. These formulas now used by the Reedy Co. have been proven both mathematically and mechanically correct by the continuous operation, for the past 31 years, of high speed steam elevators with the same V-groove sheave. These sheaves have never required replacement or re-cutting since their installation.

**Other Reedy
Elevators**

Besides the V-groove traction drive elevator the Reedy Co. manufactures many other types of passenger and freight elevators, some of which are listed below.

- Direct Connected Electric Worm Gear Elevators, 5 Types.
- Belt Connected Electric Elevators, 6 Types.
- Push Button Electric Elevators.
- Electric and Hydraulic Automobile Lifts.
- Electric and Hydraulic Ash Hoists.
- Direct Lift or Plunger Hydraulic Elevators.
- Horizontal and Vertical Hydraulic Elevators.
- Horizontal and Vertical Steam Elevators.
- Worm Gear Elevators.
- Driven from Line Shaft, Gas Engine, Electric Motor, Hand Power Elevators.
- Five Types of Hand Power Freight Elevators.

OTIS ELEVATORS

Cooperation

In the distribution and movement of goods in any plant of two or more stories in height, vertical transportation plays a most important part. Not only is elevator service necessary to the multi-storied plants of large dimensions, but it is no less essential to the factory, warehouse, or loft, of more modest size. It is essential, therefore, that a careful study should be made of each individual case to determine the number, type and duties of the elevators required, as well as the proper location and grouping of the elevators with respect to the horizontal movement of the material.

With offices in over 100 cities in the United States, the Otis Elevator Company offers its cooperation in every way in the determination of the proper elevator equipment and in planning provisions for such equipment. The Company, with a background of over 65 years of elevator designing and building, is well qualified to aid in the solution of problems of vertical transportation of materials.

Otis Service

Otis responsibility does not end with the completion of a successful installation. No matter how skillfully an elevator may be designed, how carefully it may be manufactured, or how

well installed, its real service value will not be all that it should be unless the elevator is properly taken care of. Periodic examination by trained elevator experts and reliable repair service by expert workmen is the surest and safest method of keeping your elevators tuned up to their highest efficiency. A complete list of Otis offices in the United States is given below. Any one of these offices will gladly give any desired information in regard to Otis Service.

Manufacture and Design

Otis Elevators are designed by engineers long trained in problems of elevator travel. In all their different parts—motor, controller, brake, gearing and guide rails—they are manufactured in Otis shops. For this reason each part is made to function with all other parts. The motor is strictly an elevator motor, the gears are accurately cut, every part is well and carefully made to meet the severe requirements of elevator service.

Duties and Speeds

Freight elevators, as a rule, are required for services of the heavier duties—of greater loads at lower speeds. The usual duties range from 1,000 to 8,000 lbs., at speeds from 25 to 200 feet per minute, although Otis Freight Elevators

DIRECTORY OF OFFICES OF THE OTIS ELEVATOR COMPANY

In the United States

Akron, Ohio Albany, N. Y. Allentown, Pa. Asheville, N. C. Altoona, Pa. Atlanta, Ga. Atlantic City, N. J. Augusta, Ga. Aurora, Ill. Austin, Tex. Baltimore, Md. Bangor, Me. Beaumont, Tex. Birmingham, Ala. Boise, Idaho Boston, Mass. Bridgeport, Conn. Brockton, Mass. Brooklyn, N. Y. Buffalo, N. Y. (Office & Works) Burlington, Ia. Butte, Montana Canton, Ohio Cedar Rapids, Ia. Charleston, S. C. Charleston, W. Va. Charlotte, N. C. Chattanooga, Tenn. Chicago, Ill. Cincinnati, O. Cleveland, O. Colorado Springs, Colo. Columbia, S. C. Columbus, O. Dallas, Texas Danville, Ill. Davenport, Ia. Dayton, O. Denver, Colo. Des Moines, Ia. Detroit, Mich.	Dubuque, Ia. Duluth, Minn. East St. Louis, Ill. El Paso, Texas Erie, Pa. Evansville, Ind. Flint, Mich. Fort Smith, Ark. Fort Wayne, Ind. Forth Worth, Tex. Fresno, Calif. Galveston, Tex. Grand Rapids, Mich. Green Bay, Wis. Greensboro, N. C. Greenville, S. C. Hammond, Ind. Harrisburg, Pa. Harrison, N. J. (Works) Hartford, Conn. Haverhill, Mass. Hot Springs, Ark. Houston, Tex. Huntington, W. Va. Indianapolis, Ind. Jackson, Mich. Jackson, Miss. Jacksonville, Fla. Jamestown, N. Y. Johnstown, Pa. Joplin, Mo. Kalamazoo, Mich. Kansas City, Mo. Knoxville, Tenn. La Crosse, Wis. Lexington, Ky. Lincoln, Neb. Little Rock, Ark. Los Angeles, Calif. Louisville, Ky. Lowell, Mass. Lynchburg, Va.	Madison, Wis. Macon, Ga. Memphis, Tenn. Miami, Fla. Milwaukee, Wis. Minneapolis, Minn. Mobile, Ala. Montgomery, Ala. Muskogee, Okla. Nashville, Tenn. Newark, N. J. New Bedford, Mass. New Haven, Conn. New Orleans, La. New York, N. Y. Niagara Falls, N. Y. Norfolk, Va. Oakland, Calif. Oklahoma City, Okla. Omaha, Neb. Paterson, N. J. Peoria, Ill. Petersburg, Va. Philadelphia, Pa. Phoenix, Ariz. Pittsburgh, Pa. Pittsfield, Mass. Portland, Me. Portland, Ore. Poughkeepsie, N. Y. Providence, R. I. Quincy, Ill. (Office & Works) Reading, Pa. Richmond, Va. Roanoke, Va. Rochester, N. Y. Rockford, Ill. Sacramento, Calif. Saginaw, Mich. Salt Lake City, Utah San Antonio, Tex. San Diego, Calif.	San Francisco, Calif. San Jose, Calif. Savannah, Ga. Scranton, Pa. Seattle, Wash. Shreveport, La. Sioux City, Ia. Sioux Falls, S. D. South Bend, Ind. Spokane, Wash. Springfield, Ill. Springfield, Mass. Springfield, Mo. Springfield, O. St. Joseph, Mo. St. Louis, Mo. St. Paul, Minn. Stockton, Calif. Syracuse, N. Y. Tacoma, Wash. Tampa, Fla. Terre Haute, Ind. Toledo, Ohio Topeka, Kansas Trenton, N. J. Troy, N. Y. Tulsa, Okla. Utica, N. Y. Waco, Tex. Washington, D. C. Waterbury, Conn. Waterloo, Ia. Watertown, N. Y. Wheeling, W. Va. Wichita, Kan. Wilkes Barre, Pa. Wilmington, Del. Wilmington, N. C. Wichita Falls, Texas Worcester, Mass. Yonkers, N. Y. (Wks.) Youngstown, Ohio
--	---	--	--

In Canada

Calgary, Alberta Edmonton, Alberta Halifax, Nova Scotia	Hamilton, Ont. London, Ont. Montreal, P. Q. Ottawa, Ont.	Quebec, P. Q. Regina, Saskatchewan Toronto, Ont. Vancouver, B. C.	Victoria, B. C. Windsor, Ont. Winnipeg, Manitoba
---	---	--	--

OFFICES, AGENCIES AND ASSOCIATED COMPANIES IN ALL FOREIGN COUNTRIES

OTIS ELEVATOR COMPANY

For List of Offices, See Above

are built with lifting capacities up to 10,000 and 12,000 lbs. and even greater, and for speeds up to 600 feet per minute.

Otis Single Wrap Traction Elevator Machine

The illustration here with shows an Otis Electric Single Wrap Traction Elevator Machine for use with alternating current. For direct current the machine is similar in construction and appearance, except that a direct current motor, controller and brake are used.

The Otis Single Wrap Traction Elevator Machine consists of a standard Otis steel frame motor, a mechanically released, spring applied brake, and a reduction gear which connects with a driving sheave, all mounted on a continuous bed plate to preserve alignment. The motor shaft is coupled directly to the worm shaft, the face of the coupling serving as the brake pulley. The worm is cut in a solid steel forging integral with the worm shaft. This worm meshes with a bronze rim worm gear. Both worm and gear run in oil and are entirely enclosed in an oil-proof housing. The traction driving sheave, around which pass the lifting cables, is of the best grade of semi-steel accurately turned and grooved to receive the cables.

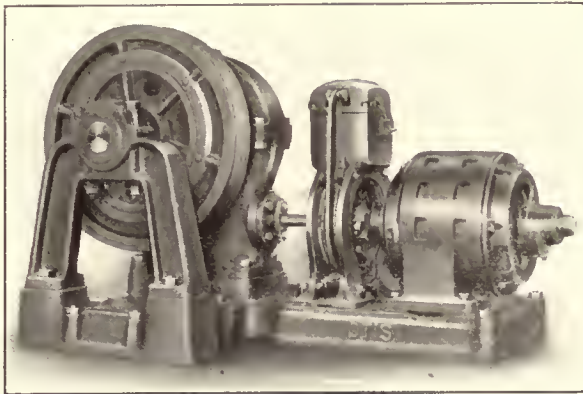

Otis Alternating Current Single Wrap Traction Elevator Machine.

Otis Motor, Controller, Brakes and Guide Rails

The motors used with Otis Electric Elevator Machines are Otis motors, especially designed and built in Otis shops to meet the severe requirements of elevator service.

The starting and acceleration of the motor is governed by the Otis Controller, which consists of reversing and accelerating switches, together with a main line magnet. It is actuated by a hand rope, by a switch in the car, or by push button.

The brake used is of the mechanically released, spring-applied type, assuring positive stops at landings. When the car operating device is turned to the "off" position, the brake is automatically applied to hold the car immovable.

The elevator guide rails may be of either steel or wood construction. Steel guides, however, are generally more satisfactory from the viewpoints of fire risk, permanency and ability to resist climatic conditions.

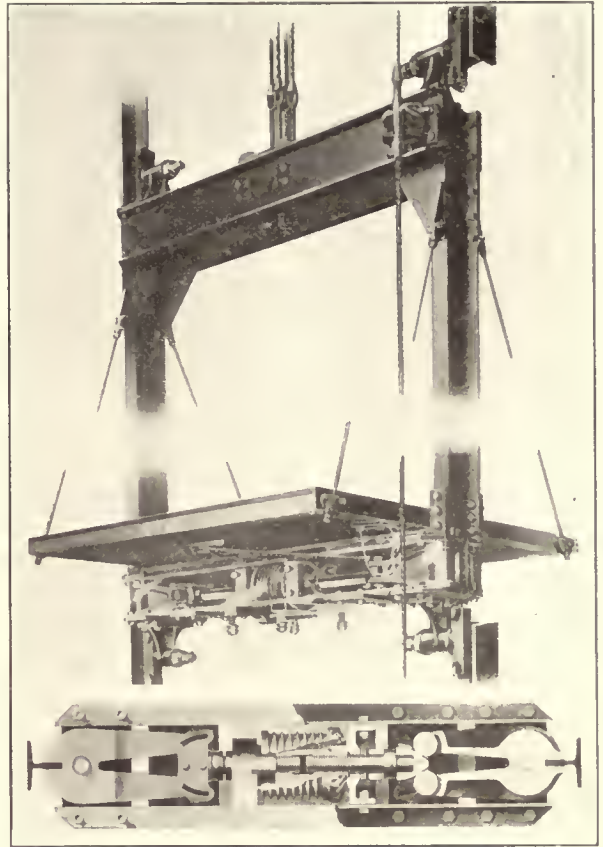

Otis Elevator Platform with phantom view of Wedge Clamp Safety Device. Bottom picture shows plan view of Safety.

Otis Safety Devices

Otis Electric Freight Elevators, no less than Otis passenger elevators, are designed, manufactured and installed to give absolute safety. The primary reason for their safety is found in their superior design and workmanship; in the high safety factor allowed in the construction of all parts; and in the perfection of their electrical control features. In addition, a mechanically operated car safety device is located in the lower member of the car suspension frame.

For freight elevators there are three types of safeties used—the Roll Safety and Wedge Clamp Safety for steel guides, and Double Grip Safety for wood guides. These safeties are operated by means of adjustable speed governors, which are designed to operate immediately in case the car attains excessive speed due to breaking of the cables or any other reason, causing the safety device to grip the guides securely and prevent the car from falling.

In addition to the car safety devices, limit switches are located in the hatchway and operated automatically by the car itself, interrupting the current and applying the safety brake should it from any cause run by the terminal landings. An automatic safety magnet switch is provided in the supply line to the motor and is designed to operate automatically to cut off the current supply to the elevator upon interruption of power circuit from any cause. An emergency switch is located in the car easily accessible to the operator, designed to cut off the current supply to the motor and

OTIS MICRO LEVELING ELEVATORS

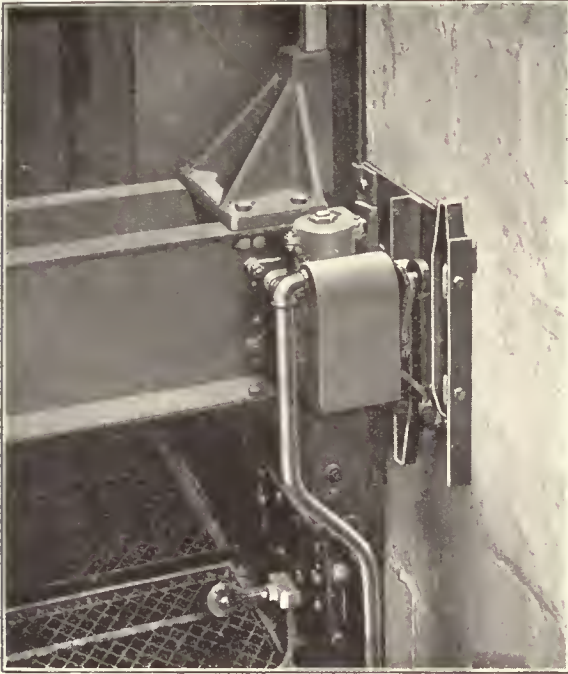

Leveling Switch on Top of Car and Cams in Hatchway, Micro Leveling Elevator.

bring the car to rest independently of the regular operating device.

For freight elevators operated by hand rope control, a device known as the Otis Safety Rope Lock is used to lock the rope when the car is at a landing, preventing the movement of the car by a person at any of the other landings.

Micro Leveling Elevators for Freight Service

steamship terminals, warehouses, factories and other

The Otis Micro Leveling Elevator is the logical result of the present tendency toward the development of a safe, economical and speedy means of moving material in railroad and

industrial establishments. It represents one of the latest and best achievements in the history of elevator design.

The most casual study of material handling reveals the need of an elevator that will consistently make an accurate floor level stop under all conditions of loading and unloading in one operation.

The Micro Leveling Elevator is an elevator capable of automatically making an accurate landing, irrespective of the load and speed, and of automatically maintaining this accurate landing during loading and unloading, independently of the stretch of the cables.

Micro Leveling Elevator Machine

The making of an accurate landing by the Micro Leveling Elevator is automatic and not controlled by either the car switch or push button operating device after the elevator has been brought within a limited zone above or below the landing. When within the leveling zone, cams located in the hatchway direct the operation of the elevator at reduced speed to a position such that the platform of the car will be level with the landing. If during loading or unloading this level is changed due to stretch of the cables, the car will automatically return to its level position.

Methods of Control

Micro Leveling Elevators are built in both the Gearless Traction and Worm Geared Traction types and may be used with either car switch or push button control.

When push button control is used, no regular operator is required. The elevator in this case may be called or dispatched by the freight handler or attendant, by the momentary pressure of push buttons located at the floors or in the car.

Where the installation consists of a large number of elevators, the elevators may be arranged in groups and each group controlled from a central dispatch station by one attendant.

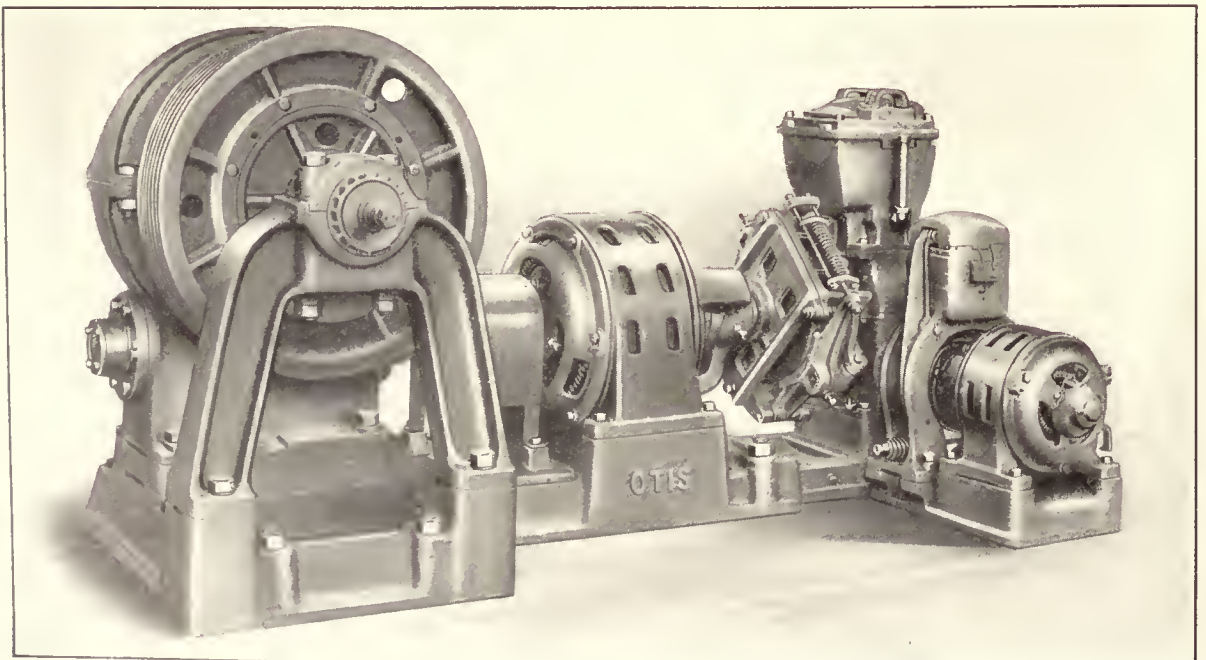

Otis Alternating Current Micro Leveling Elevator Machine.

OTIS ELEVATOR COMPANY

For List of Offices, See Second Page Preceding

OTIS MICRO LEVELING ELEVATORS



Group of ten Otis Operatorless Elevators in the United States Army Base, showing tractors and trailers unloading from an upper floor.

Grouping of Micro Leveling Elevators

Close consideration of the various methods of material handling in industrial establishments shows the superiority of the micro-leveling elevator used in connection with electric storage

battery tractors and trailers over other systems for the movement of miscellaneous material.

It is evident that when the maximum vertical flow of freight synchronizes with the maximum horizontal flow, the handling system operates with the highest efficiency. This can be accomplished by the proper arrangement of floor space to permit of the floor traffic moving along definite lines and by the proper placement of micro-leveling elevators in groups. This allows the greatest possible storage space, insures continuity of movement and prevents congestion.

Otis Operatorless Freight Elevators

In many large plants using batteries of commodity handling elevators, micro-leveling automatic push button control equipment may be advantageously introduced. Examples of

this equipment are the large government built terminal warehouses in Brooklyn, N. Y., and Boston, Mass., wherein groups of from 6 to 10 elevators are entirely controlled by a central dispatcher working with an automatic signaling system and a conveniently located push button control board. Automatic door operating machines facilitate the service. A single elevator also may be employed without regular attendant for the heaviest and most exacting freight service, if equipped with push button control and the micro-leveling feature.

Economies and Advantages

There are certain economical features and advantages of the Micro Leveling Elevator that are particularly noticeable. These may be summed up as follows:

1. Accuracy of Landing: This makes the use of the automatic micro leveling machine possible for a wide range of service.
2. Maintaining of Accurate Landing: When the car tends to move away from the landing due to stretch in the hoisting ropes, this movement is quickly checked by the micro which acts immediately, returning the car to the position accurate with the landing floor.

3. Saving of Time: As the time consumed in opening the car gate or door is more than that required for the micro to bring the car to a level landing it is evident that no time is lost through the use of the micro, and furthermore, time is actually saved by the elimination of the time ordinarily lost by the operator in attempting to make proper landings.
4. Economy of Power: The elimination of false stops and the final approach to the landing at reduced speed usually means a considerable saving in power, which will vary under different conditions and types of control.
5. Skilled Operators Are Unnecessary: Skilled operators are unnecessary because an accurate landing is made by the micro automatically and independently of the operator.
6. Greater Safety to Freight Handlers and less Damage to Merchandise carried.
7. Less wear and tear on Electrical and Mechanical Parts of the Apparatus, with the consequent reduction in maintenance cost.
8. Longer Life of Rolling Equipment.
9. Greater Facility in Handling Material.
10. In the larger installations where automatic push button control is used or the central dispatch system of operation is employed, the labor saving due to the elimination of operators is a large item in the operating expense of the elevator system.



Central Dispatch Board for a group of ten elevators—
United States Army Base, Brooklyn.

OTIS ELEVATOR COMPANY

For List of Offices, See Third Page Preceding

WATSON ELEVATORS

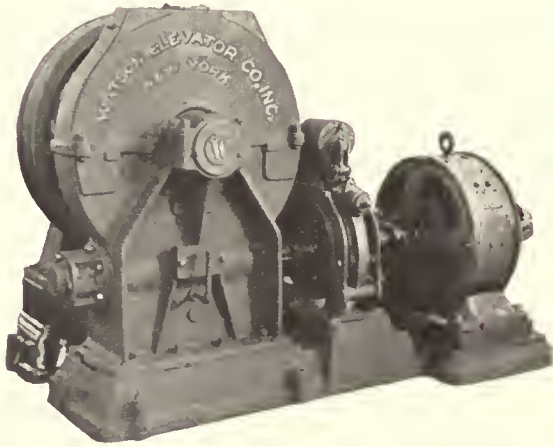

Watson Machine. Note Accessibility of Double Acting Ball Bearing Thrust.

Watson Electric Elevator Machine

The Watson Electric Elevator Machine is the finished product of twenty-five years of elevator engineering. It is durable, efficient, and possesses every quality that is required

for transporting material in a vertical direction.

Watson Machine is of what is termed the Worm Gear Traction Type; the feature of this construction being to reduce from the motor speed to the drum speed by means of an enclosed worm gear drive traveling in oil.

The worm and worm shaft is cut from a single forging of hammered crucible steel, and the end thrust is carried on a ball bearing of the double-acting self-aligning type.

The worm wheel of special phosphor bronze with teeth accurately cut to insure smooth and quiet running, is bolted directly to a flange of the traction sheave, thus avoiding the use of keys and set screws.

In the Watson Machine, the gear case, pedestal, brake and motor are mounted on a one-piece bedplate.

Five Sizes of Watson Machine

The smallest Watson Electric Winding Machine takes a 5 or 7½ H.P. Motor and a 16" dia. gear; the second a 10 or 15 H. P. motor and 20" dia. gear; third, 20 or 25 H.P.

motor and 27" dia. gear; fourth, a 30 H.P. motor and 28½" dia. gear; the fifth and largest, a 35 or 40 H.P. motor and 34½" dia. gear.

A range of capacities is thus secured from 1,000 to 16,000 lbs., and a car speed from 50 to 450 ft. per min. A further speed reduction is secured by gearing car and counterweights, 2:1 if required as shown in accompanying diagram.

Our Engineering Department is always ready to co-operate by making layouts and furnishing any data necessary.

Miscellaneous Types

In addition, the Watson Elevator Company produce a line of Sidewalk Dumbwaiter, Belt and Ceiling Machines, and Electric Skip Hoist Engines.

Watson Elevator Cars

The Watson Elevator car is built from steel sections and is provided on the under side with safety attachments designed to lock the car to the guide rails, if a certain speed is exceeded.

Factor of Safety

The factor of safety is as follows:

All moving parts essential to safety and control have a factor of safety of not less than ten (10); all moving parts not included under above heading have a factor of safety of not less than eight (8); non-moving parts have a factor of not less than six (6).

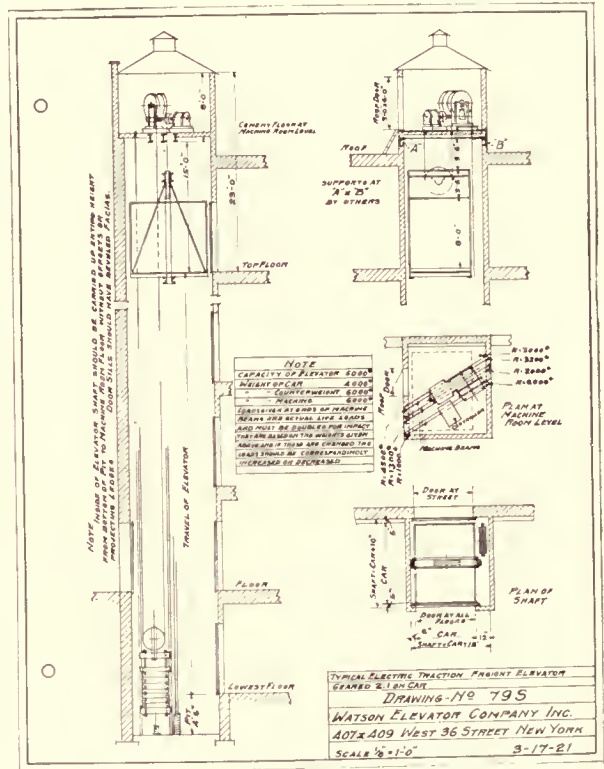

Details of Watson Freight Elevator.

Watson Service

The Watson Elevator Company maintains a complete Service Department. Skilled mechanics make regular inspections of all installations. Thus, for a nominal charge, minor repairs are adjusted before they become serious, and in addition, uninterrupted elevator service is assured.

In Making Inquiries Give This Information

A general description should be given of the work the elevator is to be put to, including nature of the building, etc. Further, state the size of shaft; the speed in feet per minute, capacity in pounds. If D.C. current is available give voltage; if A.C. give voltage, phase, and cycles.

A sketch locating doors to elevator shaft and space available for elevator engine should accompany data.

WATSON ELEVATOR COMPANY, INC.

407-409 WEST 36th STREET, NEW YORK CITY

HOWELL ELECTRIC MOTORS

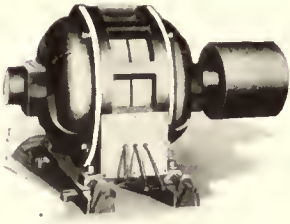

Type A—Skeleton Frame Motor.

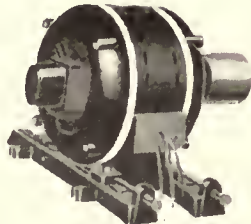

Type B—Riveted Frame Motor.

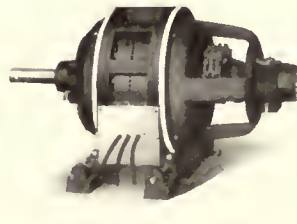

Slip Ring Skeleton Frame Motor.

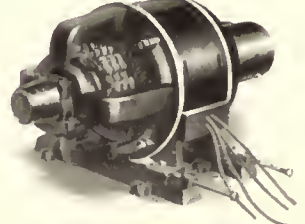

Slip Ring Riveted Frame Motor.

Application of Howell Motors

The Howell Electric Motors Company limits itself to the field of polyphase induction motors. Every effort is concentrated on this one line of motors to make it the best possible.

In addition to the standard general application motors, Howell Red Band Motors have a wide range of usefulness in the material handling field. They are specially designed and built for elevators, conveyors, cranes and hoists.

Delays Avoided With Howell Motors

Delays in manufacturing operations, resulting from bearing troubles in ordinary electric motors, are eliminated by the distinctive patented bearing in the Howell Red Band Motor.

The Howell Motor is so built that it really contains two bearings in one—a spare set of bearings always ready for emergency use. When the Howell bearing ultimately wears so that the rotor touches the stator, it is only necessary to turn the outer bushing half way round to recenter the rotor. Costly delays are thus avoided—not more than five minutes being required to recenter the Howell bearing.

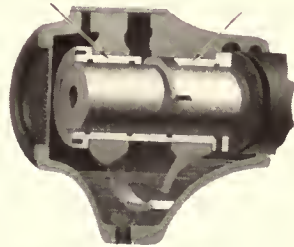

Section of Bearing Housing.

In addition to the recentering feature, Howell bearings have a patented oil trap which prevents the coils from being ventilated by oil laden air. This keeps the coils dry and clean, adding to their life.

All the wire used in making the windings of Howell Motors is enameled in addition to the usual double

cotton covering giving much greater insulation strength than the ordinary motor.

End rings are cast directly to the squirrel cage rotor bars, making an indestructible rotor.

Sizes of Motors

Howell Motors are built in sizes from 1 to 100 Horse-Power, inclusive. They are furnished for operation on 110, 220, 440 and 550 volts, two and three phase circuits of all commercial frequencies and standard speeds.

On all sizes up to $7\frac{1}{2}$ horse-power, starting compensators are not required and are not regularly furnished. The $7\frac{1}{2}$ horse-power, and larger motors, are regularly supplied with manually operated starting compensators, complete with no-voltage release, and overload relays.

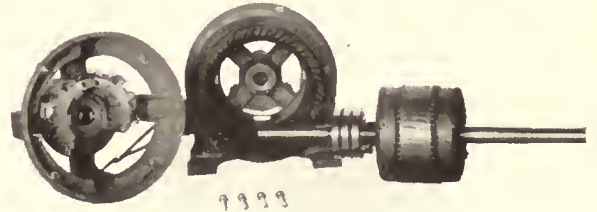

Unassembled View of Slip Ring Riveted Frame Motor.

Howell Service

The corps of engineers which has developed the Howell Red Band Motors to their present position in the electrical field is at the service of any motor purchaser. Questions of size and the application of various types to particular problems will be freely answered.

BRANCH OFFICES

Export Office: 90 West Street, New York

New York,
Philadelphia,
Chicago,
Minneapolis,
Milwaukee
Grand Rapids,
Buffalo,

Cleveland,
St. Louis,
Toledo,
Detroit,
Pittsburg,
Dallas,

Seattle,
Los Angeles,
San Francisco,
Boston,
Kansas City,
Denver,

Atlanta,
Saginaw,
Charlotte, N. C.,
Montreal,
Toronto,
Winnipeg,
Vancouver

WESTINGHOUSE CRANE MOTORS AND CONTROL

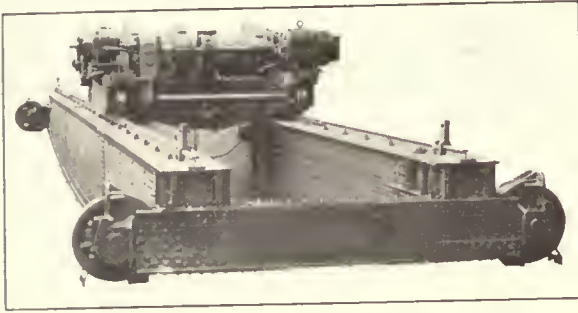

Type K Motors Operating Traveling Crane.

Wide Range of Applications

The products of the Westinghouse Electric & Manufacturing Company have a wide application in the material handling field.

Westinghouse Motors and control apparatus are in daily use in the operation of cranes, elevators, conveyors, shovels, winches and a host of other material handling machines.

Westinghouse Crane Motors

Motors intended for Crane service, must have special characteristics. The load is always started from rest and the motor must therefore be capable of exerting great starting effort.

The motor must be strong and rugged in mechanical construction to withstand the severe mechanical stresses encountered. The electrical performance, especially commutation, must be very good to withstand the severe overloads. It must be compact in over-all dimensions as the space for its installation is usually limited. The rotating part must be so constructed that it can be frequently reversed; the speed must be capable of control; and since the motor must often be located where it is difficult of access it must be capable of operating for considerable intervals without attention.

Westinghouse crane motors meet these requirements fully and Westinghouse Engineers are ready to give advice about applying motors for this special service. The



Traveling Crane Handling Steel, Driven by Type K Motors.

company has a complete line of motors and controllers for crane service for both alternating and direct current installations. The direct current motors are types K, HK and MC. The alternating current motors are types CI and MA.

Westinghouse Type H.K. Motor for Cranes

Westinghouse direct-current series-wound commutating pole motors, Type HK, are designed for severe, intermittent, varying speed service, where high starting torque is required, and where the load consists of a series of starts, stops and reversals, the motor being idle only for short periods of time.

The motors are enclosed with small openings in the lower part of the brackets for ventilation. Removable covers on the upper part of the front bracket give access to the brushes and the commutator. The most prominent features of this motor are the steel frame construction and ventilated design, giving small over-all dimensions, light weight and great mechanical strength. The low over-all height of this motor makes it particularly adaptable for use on cranes, where only low overhead room is available. Excellent commutation is obtained at all loads. They can be supplied in sizes ranging from 2 to 50 H.P. on 230 and 550 volts.

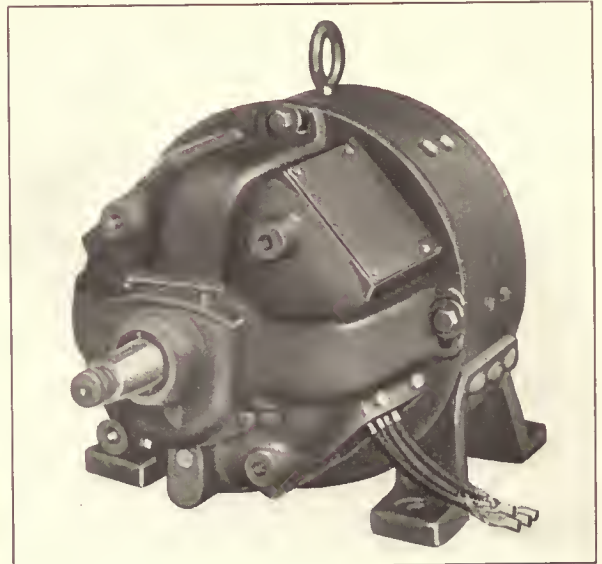

25 H. P. Type HK Motor.

Crane Control

Westinghouse type S drum contactor controllers are a new development of crane controllers, combining many of the advantages of magnetic controllers with the simplicity and low cost of drum control. Their successful operation under the most severe operating conditions has been proven in service. The contactors are actuated by cams operating on rollers with little friction. These rolling contacts together with their quick make and break action increase the contact life. The arching is reduced and confined to the contact tips where the current is carried only momentarily. The contacts can

WESTINGHOUSE ELECTRIC & MFG. CO.

EAST PITTSBURGH, PA.

Address nearest office. For list of offices see page 758.

WESTINGHOUSE ELEVATOR MOTORS AND CONTROL

be renewed in a short time. They are particularly the only wearing parts and are interchangeable with those of the Westinghouse auto starters and magnetic contact controllers.

Type C, direct-current magnetic contact controllers are designed to meet every requirement of general crane service. Sturdiness of construction, reliability in operation and simplicity of design are marked characteristics of these controllers. The operator has complete control of starting and stopping the motor, but cannot damage the equipment by careless or incorrect manipulation of the master switch. This protection is afforded by the automatic acceleration of the motor obtained by the use of accelerating relays, making the acceleration of the motor dependent upon the amount of the load.



Type S Drum Contactor Controller for Crane or Hoist Service.

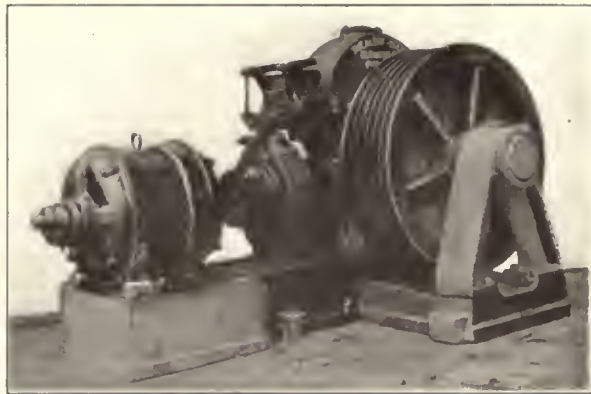

Squirrel Cage A. C. Motor, Type CS Operating Freight Elevator.

SK are designed especially for this service. Some of the characteristics fitting them for driving elevators are high starting torques, sparkless commutation, rugged and substantial construction and good performance. They can be furnished in sizes from 5 to 100 H. P. and to operate on 115, 230 or 550 volts.

For moderate and high speed direct-current freight elevators Westinghouse full magnetic controllers are used. These controllers are operated by means of a switch in the elevator car, but the actual connections are made by a series of automatically operated magnetic contactors. The operator has full control over the movement of the car but no control over the magnetic contactors which always make the proper connections at a rate that insures safety acceleration regardless of how the car switch is operated.

For freight elevators with car speeds not exceeding 150 feet per minute, the Westinghouse type CS squirrel cage elevator motor forms an ideal drive. This motor is the simplest type of alternating current motor made. It consists of a steel frame, which carries a set of windings, and a practically indestructible rotating part.

The motor is connected directly to the line in starting, only a simple drum switch being necessary. The motor starts at low speed without a jerk and comes quickly and smoothly up to full speed.

The Westinghouse type CI slip-ring elevator motor is well adapted, both mechanically and electrically to meet the severe requirements of freight elevator service. They can be furnished in single or two-speed designs as the service demands. The two-speed motors permit higher operating speeds of the elevator car with smooth acceleration and accurate handling. The single

Westinghouse Elevator Motors and Control

The Westinghouse Electric & Manufacturing Company make a complete line of elevator motors and control apparatus. They are applicable to slow, medium or high speed freight

elevators as well as all types of passenger elevators. Their service record includes over 20,000 installations.

Westinghouse direct-current elevator motors, type

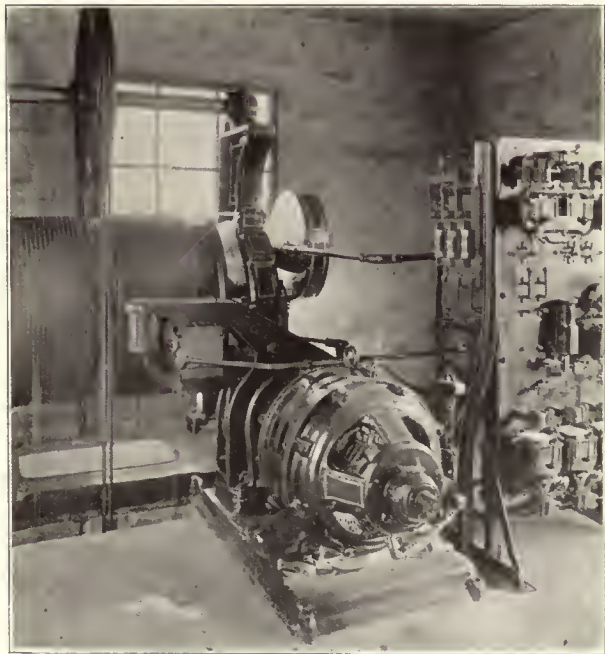

25 H. P. Slip Ring A. C. Motor, Type CI Operating 12,000 Pound Freight Elevator.

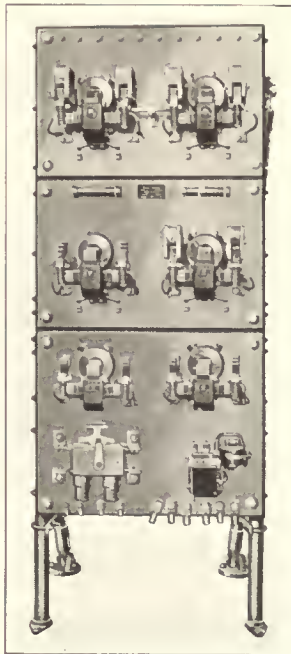

Full Magnetic Control Panel for A. C. Elevator Motors.

WESTINGHOUSE ELECTRIC & MFG. CO.

EAST PITTSBURGH, PA.

Address nearest office. For list of offices see page 758.

MOTORS AND CONTROL FOR SHOVELS, CONVEYORS AND WINCHES

speed motor can be furnished in sizes up to 100 H. P. and the two-speed up to 50 H. P.

The Westinghouse Company manufactures A. C. elevator controllers for both single and two-speed squirrel-cage and wound rotor motors in ratings from 3 to 100 H. P. The controllers are furnished for either car switch or automatic push button control.

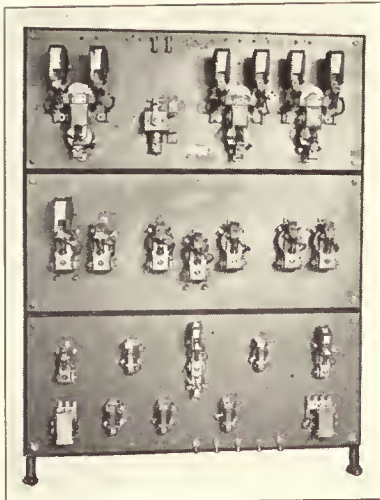

Full Magnetic Control Panel for D. C. Elevator Motors.

Irrespective of the method of control the acceleration of the car is exceptionally smooth and is accomplished automatically by accelerating relays which depend for their time of operations upon this load on the motor. All parts of these controllers are rugged and simple in construction, being designed to operate practically without attention other than the occasional inspection.

Motors and Control for Electric Shovels

The Westinghouse Company has developed a complete line of shovel and drag line equipment. Simplicity and rugged construction are features of the apparatus, giving it reliability in operation without skilled and frequent attention.

Both alternating and direct-current equipments can be furnished. In general the location of the shovels makes alternating current equipment preferable because alternating current motors eliminate the necessity of converting alternating current to direct current at the shovel, resulting in simpler equipment.



Electric Shovel Digging Power Canal at Niagara Falls, Canada, Operated by A. C. Type MA Motors.

Westinghouse Motors for Conveyors

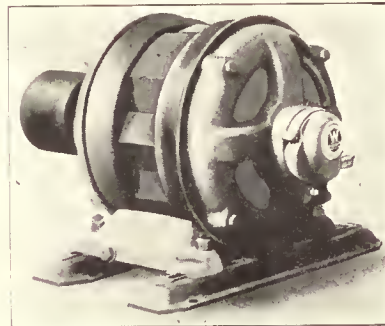

Squirrel Cage Type C S Motor Used for Conveyor Drive.

The Westinghouse alternating current, type CS motor is well adapted to conveyor drive. Its simplicity makes it easy to start and stop, and its reliability assures the operator that the material will be moved without interruption due to motor trouble. Wound rotor motors, type CW, are furnished where the conveyor must start under a heavy load or where different operating speeds are demanded. Where direct-current power is available the type SK motor is used.

Westinghouse Motors and Control for Winches

The use of motor driven winches is rapidly growing in marine work. If a boat can be unloaded in half the time by use of machinery, the total time for the trip is cut down with a corresponding larger return on invested capital. Types K. and HK series wound Motors give a reliable and eco-

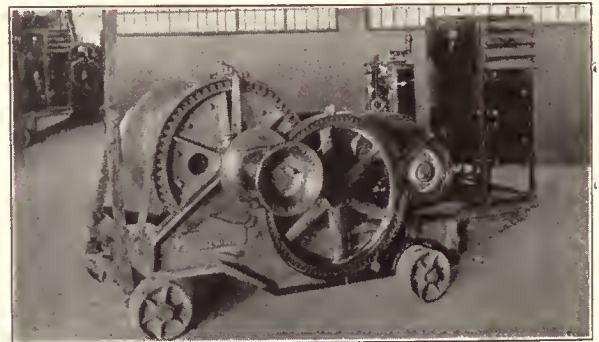

Portable Winch Used for Loading Ships, U. S. Army Supply Base, Boston, Mass.

nomical drive for winches and are built to stand the severe service imposed on them by operation by stevedore labor. Type S. drum controllers with vertical handles are especially suited as they allow the operator to work the controller all day without becoming fatigued. The complete equipment, motor, control and winch is compactly mounted on a single base, allowing easy moving from one point to another.

WESTINGHOUSE DISTRICT OFFICES

Atlanta, Ga.
Baltimore, Md.
Birmingham, Ala.
Bluefield, W. Va.
Boston, Mass.
Buffalo, N. Y.
Butte, Mont.
Charleston, W. Va.
Charlotte, N. C.
Chattanooga, Tenn.

Chicago, Ill.
Cincinnati, Ohio.
Cleveland, O.
Columbus, O.
Dallas, Texas.
Dayton, O.
Denver, Colo.
Des Moines, Ia.
Detroit, Mich.
Duluth, Minn.

El Paso, Tex.
Houston, Tex.
Indianapolis, Ind.
Jacksonville, Fla.
Joplin, Mo.
Kansas City, Mo.
Louisville, Ky.
Los Angeles, Cal.
Memphis, Tenn.
Milwaukee, Wis.

Minneapolis, Minn.
New Orleans, La.
New York, N. Y.
Philadelphia, Pa.
Pittsburgh, Pa.
Portland, Ore.
Rochester, N. Y.
St. Louis, Mo.
Salt Lake City, Utah.
San Francisco, Cal.

Seattle, Wash.
Syracuse, N. Y.
Tucson, Ariz.
Toledo, O.
Washington, D. C.
Wilkes-Barre, Pa.
The Hawaiian Elec.
Co., Ltd., Honolulu,
T. H. Agent.

WESTINGHOUSE ELECTRIC & MFG. CO.

EAST PITTSBURGH, PA.

Address nearest office. For list of offices see above.

HASLETT SPIRAL CHUTES AND CONVEYORS

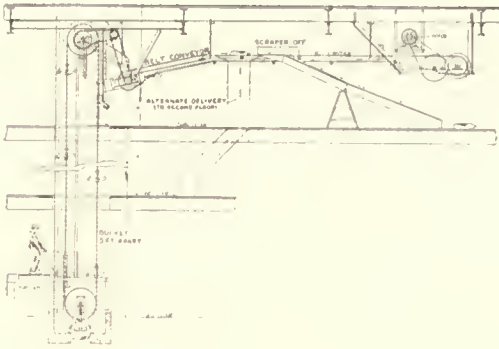

Tray Elevator and Belt distributing sacks of flour from cars through warehouse, Baltimore.



Triple Haslett Spiral for handling baskets of unpacked crockery and glassware.

Haslett Power Driven Conveyors

purchasers. We can advise wisely as to the most economical solution of handling problems and the best machines for various purposes.

Each piece of machinery we build is designed with special reference to the kind of work it must do, and the conditions under which it will operate.

Power driven machines are made either vertical, inclined, or horizontal and we manufacture several designs of each with necessary auxiliary equipment such as automatic and selective feeds and discharges, etc.

Our line of conveying equipment is complete.

Long experience in adapting the various forms of equipment illustrated here to an infinite variety of uses has taught our engineering force much that makes it useful to prospective



Inclined elevator taking delivery from gravity roller conveyor.

Haslett Spiral Chutes

gravity so as to control speed has permitted of a remarkable development of this form of equipment and its adaptation to many seemingly impossible uses, such as handling unpacked glassware and crockery in baskets, bottled medicines, bath tubs, eggs and 1,200 lb. barrels.



Combination of multiple spiral chute and power driven conveyor.

Haslett Spiral Chutes have been known for about fifteen years, and the engineering principle used whereby a concave bottom properly varied balances friction, centrifugal force and gravity so as to control speed has permitted of a remarkable development of this form of equipment and its adaptation to many seemingly impossible uses, such as handling unpacked glassware and crockery in baskets, bottled medicines, bath tubs, eggs and 1,200 lb. barrels.

Spiral Chutes readily combine with other types of conveyors delivering to or receiving from them.

Chutes of double, triple or quadruple construction permit of using each trough for a special purpose so that packages from various floors can be sent to the desired destination without rehandling.



200' c. to c. 30" Belt distributing cases in warehouse of well known paper manufacturer.

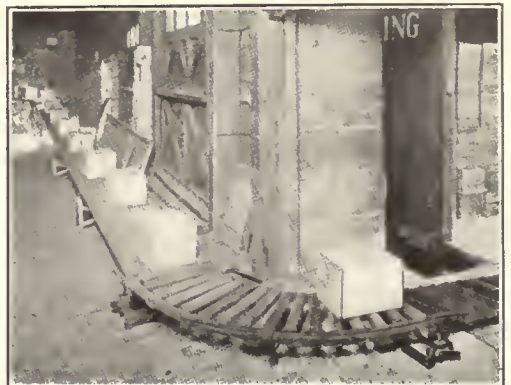

Portable Gravity Conveyor from Spiral Chute to cars without rehandling.

HASLETT SPIRAL CHUTE CO., PHILADELPHIA, PA.

NEW YORK

BALTIMORE

CLEVELAND

SAN FRANCISCO

LAMSON MECHANICAL CONVEYORS



In every Lamson conveyor system the types of conveyors are selected for the particular work they have to do. This picture shows how a Lamson gravity conveyor, spiral conveyor, belt conveyor and booster are combined into one automatic conveying system. Carlton & Hovey Co., Lowell, Mass., Manufacturers of Father John's Medicine.

Field for Lamson Conveyors

The field covered by the Lamson Company is the application of conveyors and conveying systems for handling materials and products in factories, mercantile plants, wholesale and retail establishments, docks, terminals, etc. With the exception of bulk materials such as grain, coal, ashes, and ore, Lamson conveyors are used to solve practically any industrial handling problem.

The service we offer includes an analysis of all the factors which affect the design of the conveying system—the location and output of machines and departments, the routing and storage of materials, questions involving timed movements of products, the speedy handling of peak loads, etc.

As the design of a Lamson system is based on such a preliminary investigation, the completed system carries out a comprehensive plan for the movement of materials and merchandise through a plant. Even in the case of small installations our experience shows that a thorough analysis of the work to be done is the only satisfactory basis on which to plan a conveying system.

As Lamson conveyors are built in many types, practically any kind of material or product can be handled economically under a wide variety of plant conditions. Standard Lamson conveyors can usually be installed without the necessity of designing and building costly special machinery. They can ordinarily be erected unit by unit, department by department, so that when applied in a plant that is already in operation, production is seldom interfered with. Each unit begins paying for itself as soon as installed.

Gravity Conveyors

A complete line of straight sections, curves, switches, spiral chutes, boosters, and elevators make Lamson gravity conveyors adaptable for solving a wide variety of conveying problems. They are designed for lightness, combined with strength to withstand the hardest kind of continuous service. The steel rollers are very lively, as they are mounted on large, easy running ball bearings, with case hardened ball races and cones. They are supported through shafts and are easily removable. The Lamson patented differential roll makes curves as easy to negotiate as straight runs.

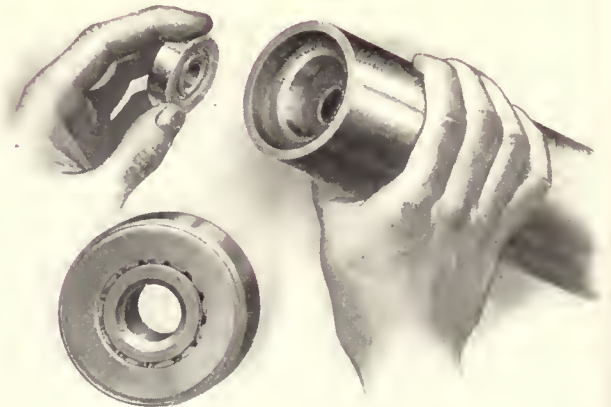

By simply removing one split pin the through spindle is released and the gravity roll head and self-contained bearing are readily accessible.

THE LAMSON CO., BOSTON, MASS.

Address nearest office. For list of offices see page 762.

Power Conveyors

Belt conveyors, slat and apron conveyors, drag bar conveyors, chain conveyors, overhead or telfer conveyors, vertical conveyors, selective conveyors and bucket elevators are a few of the more important types of Lamson power conveyors. They carry practically anything from delicate watch parts up to whole train loads or ship loads of heavy, bulky materials. They convey products in straight lines, around corners, horizontally, up and down inclines, and vertically. They are so carefully constructed and nicely balanced that they operate with minimum power.



Lamson heavy duty slat conveyors are built in different types to carry barrels, cases, castings, bales, and other heavy loads. Revere Sugar Refinery, Charlestown, Mass.

elevator is made to deliver the load at any one of a number of floors at will, or a conveyor delivers automatically at any one of a number of machines, processes or storage points.

Portable Conveyors

Lamson power and gravity conveyors are mounted on easy running swivel wheels to form portable conveyors which may be moved wherever wanted. They are useful in loading and unloading freight cars and ships, in piling and shipping out in warerooms, and for other miscellaneous occasional conveying about the plant or yard.

A portable conveyor of great general utility is the Lamson piler, a standardized universal service unit consisting of a belt or slat conveyor set at an inclination, the angle of which can be varied at will. It is often used in combination with horizontal units, to form extensive portable conveying systems.

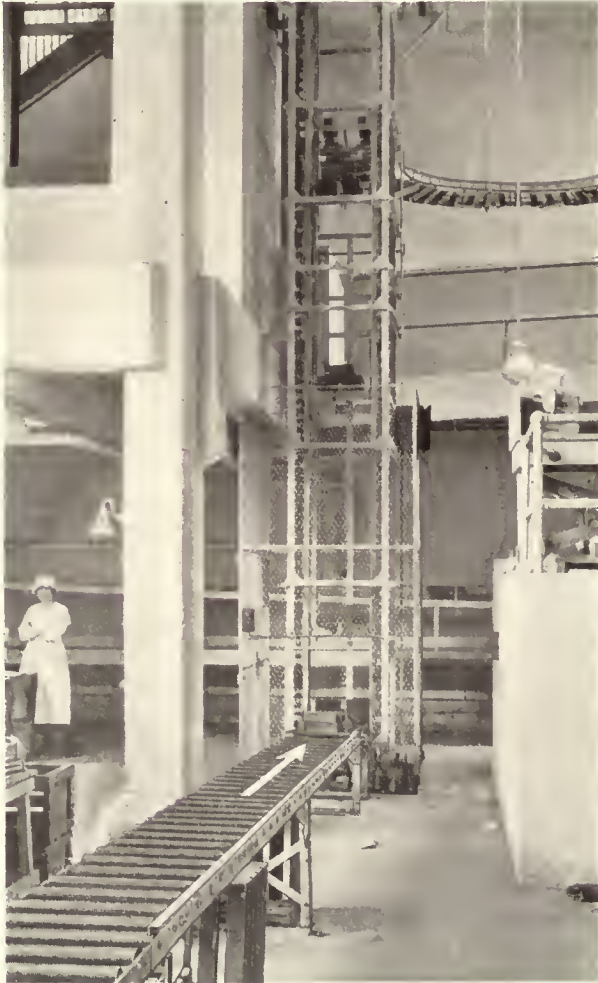

This Lamson vertical elevator loads and unloads automatically. Fleischmann Yeast Co., Cambridge, Mass.

Elevators and Chutes

For carrying products vertically between floors and levels we build a number of different types of elevators, pneumatic lifts, automatic vertical conveyors, bucket elevators, chutes, spiral chutes, spiral conveyors, etc.

Both Lamson conveyors and elevators are built where desired, with a selective feature which enables the dispatcher to send the load to any one of a number of stations without further attention. For example, an



This Lamson spiral chute carries products from a number of floors to a delivery point on first floor. Note hinged fire door which also serves as deflector when goods are delivered at intermediate floors. Army Base Warehouse, Boston, Mass.

THE LAMSON CO., BOSTON, MASS.

Address nearest office. For list of offices see page 762.

LAMSON PORTABLE CONVEYORS



Lamson chain conveyor for carrying boxes of hobbins in textile mills. This type of conveyor is also used for carrying tote boxes, hampers, and other containers. National Spun Silk Co., New Bedford, Mass.

Lamson Service for Factories

Lamson systems of conveying properly applied in factories increase production ten, twenty-five, or even fifty per cent with the same machine capacity and the same man power. The time interval of manufacture is cut often fifty or even seventy-five per cent, through careful routing, planning, and conveying of materials. This in turn makes similar economies in the use of floor space, which is utilized for production, not storing and moving stock which never should stop, when once in production. Great savings are made in assembly, packing, and boxing processes. In place of the work bench the articles pass by the operators in orderly procession on conveyors, making new records for speed and economy.

In Mercantile Plants

Lamson conveyors make great savings in mercantile plants such as wholesale and mail order houses, dairies, bottling plants, and distributing plants of all kinds where merchandise is received, classified, put in new containers or packages, and shipped. From the time products enter the receiving room door until they pass out through the shipping room door into the waiting cars or trucks they are moved by a system of Lamson conveyors. In addition to the savings in labor, much greater savings are effected in floor space released for storage, in time saved in delivery, in breakage avoided, etc.

In Retail Stores

Lamson conveyors and chutes carry merchandise and parcels from the selling counters to the delivery room, and Lamson sheet writer's and delivery men's bins simplify classification and sorting. In receiving rooms, stock rooms and marking rooms, Lamson conveyors and storage bins cut down the expense of handling, simplify the routine and speed up the work.

Docks and Terminals

Lamson automatic conveying systems are coming into general use for loading and unloading ships and freight cars. The saving of even a day in the time that a ship is in dock discharging and taking on its load will pay for a large investment in conveying machinery. The Lamson Company stands ready to discuss this subject with shipping companies, railroads, boards of trade, commercial organizations, and others interested.

Lamson Service

A Lamson representative will be glad to call on you and study your problems with the view of demonstrating how Lamson conveyors will best serve you. We are also ready to co-operate with architects, engineers, and others in planning a new plant or rearranging an existing plant to secure the maximum benefits from proper routing and automatic handling of materials and products. It incurs no obligation to talk over your conveying problems with a Lamson representative, and may lead to results of the greatest value.



Lamson overhead or telpier conveyor. Harrison Radiator Co., Lockport, N. Y.

Lamson Branches and Service Stations

BOSTON	CLEVELAND	LOS ANGELES
NEW YORK	CINCINNATI	ST. LOUIS
PHILADELPHIA	INDIANAPOLIS	DALLAS
PITTSBURGH	CHICAGO	SEATTLE
BALTIMORE	MINNEAPOLIS	WASHINGTON, D. C.
ROCHESTER	OMAHA	ATLANTA
DETROIT	SAN FRANCISCO	
TORONTO	VANCOUVER, B. C.	

Additional Service Stations

DENVER	BUFFALO
NEW ORLEANS	KANSAS CITY
ALBANY	

THE LAMSON CO., BOSTON, MASS.

Address nearest office. For list of offices see above.

LAMSON LIGHT DUTY CONVEYORS



The Lamson wire line conveyor carries letters, folders, orders, requisitions, and all kinds of papers between desks, departments and offices.

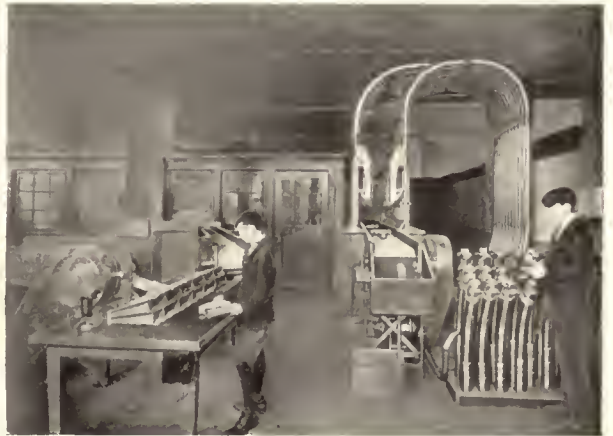

This Lamson pneumatic tube system transmits orders in a few seconds to any department in the large wholesale warehouse of Lehn & Fink, Inc., New York.

Lamson Pneumatic Tubes

Lamson pneumatic tubes, wire line conveyors, and light elevators are now standard equipment wherever speed in carrying papers and light loads of merchandise is important.

Lamson pneumatic tubes carry the load at a speed of about 30 miles an hour over distances up to a half mile in a carrier or cartridge, which is propelled through a tube by a current of air. The tubes can be installed practically anywhere along walls and ceilings, through partitions, around corners, indoors and out, or even underground.

They carry loads varying from a small message in the 1 1/4" system up to large volumes of papers, or tools, laboratory samples, and other light materials in the 4" and oval tube systems. The following tube diameters and sizes are standard—1 1/4"—2 1/4"—3"—4"—3" x 6" oval—4" x 7" oval.

The propelling air pressure is usually created by a small electrically driven blower, the power consumption being economized by power saving devices. Small systems may be operated by foot bellows and where compressed air is available this may often be utilized through the use of suitable reducing valves.



Lamson tubes in factories carry time tickets, job tickets, work orders, etc., in a few seconds from office to plant departments.

Lamson Light Elevators

Lamson light elevators are built in a standard series to cover virtually the entire range of light duty service. They vary in type from the message lift for carrying cash and papers between floors to the elevator or dumb-waiter which raises with ease loads up to 200 pounds. They are handsome in design and finish and are well adapted for installation without enclosures in banks, offices, and wherever attractive appearance is important.

Lamson Service

A Lamson representative will be glad to investigate the movement of your products about your factory or store house. If Lamson conveyors would save you money, he will recommend a system to meet your requirements. Architects, engineers and others planning new buildings are invited to confer with us in regard to the most economical and efficient layout of a carrier or conveyor system. This service incurs no obligation; moreover, it may lead to results of value to you.

Lamson Wire Line Conveyors

Lamson wire line conveyors operate without power and furnish an inexpensive system for the speedy carriage of papers and other light materials up to 20 pounds in weight, over lines

up to 200 feet in length. The load is carried in a basket which is propelled along a wire track by a pull on a convenient handle. Horizontal curves and bridges enable this carrier to pass around obstructions and serve rooms or buildings of irregular shape.



Lamson wire line conveyors in shoe factory carrying dies from die room to operators. They also carry tools, job tickets, time tickets, small parts, laboratory samples, etc. Weinbrenner Co., Milwaukee, Wis.

THE LAMSON CO., BOSTON, MASS.

Address nearest office. For list of offices see page 762.

NATIONAL TOP AND BOTTOM SEALING MACHINES

A Sealing Machine for Corrugated or Fibre Containers

National Top and Bottom Sealing Machines will seal the top and bottom of corrugated, double-wall corrugated or solid fibre shipping containers, regardless of size or kind, more

rapidly, more economically and more solidly than any other known method.

Fibre board is fabricated by gluing three or more pieces of chip-board together under constant and instant pressure, with silicate of soda as an adhesive. By this same method the National Top and Bottom Sealing Machines adhere the several flaps of the case in a solid mass. Using silicate of soda as an adhesive, the machine exerts pressure of such a sort upon the case, both top and bottom, as to make a solid mass of the outer and inner flaps.

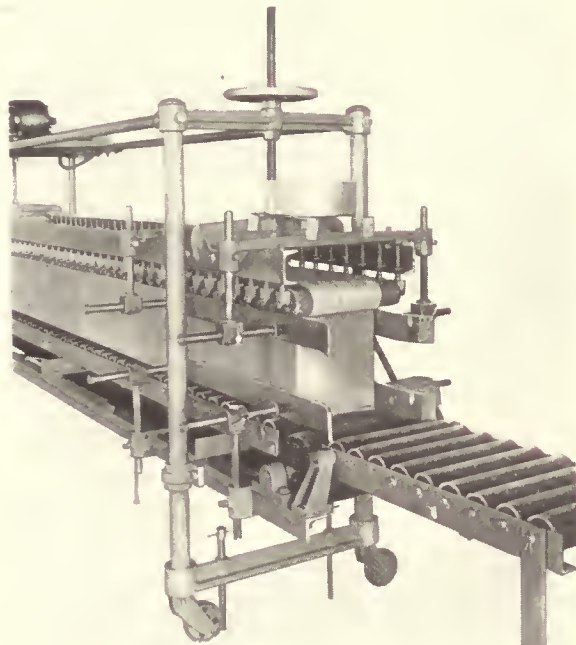

End View of Portable Top and Bottom Sealing Machine.

Only One Operator Needed

The operation of this machine is simple. The operator applies the silicate and moves the case into the machine. The guides bring the flaps of the case closely together, both top and bottom, thus starting the case through the machine in rectangular form. These guides can be easily and quickly adjusted to any size case.

The upper rollers shown below apply a strong, flexible pressure against the top of the case. This pressure adapts itself to any irregularities in the surface of the case during its travel through the machine, whereas a fixed weight would press merely upon the high spots. Each roller is spring free at each end and all rollers are independent of each other. Any bumps or depressions in the case are reached by each roller.

The thick canvas belts, both top and bottom, are of such width as to lie between the side walls of the case.

Consequently there is no crushing force exerted on the side walls and the case emerges from the machine

retaining all the original strength of the side walls plus the additional stiffness of a perfectly sealed top and bottom.

An automatic starting and stopping device controls the application of power in such a way that each case is only carried into the machine its own length. Power is thus shut off and the machine stops until the next

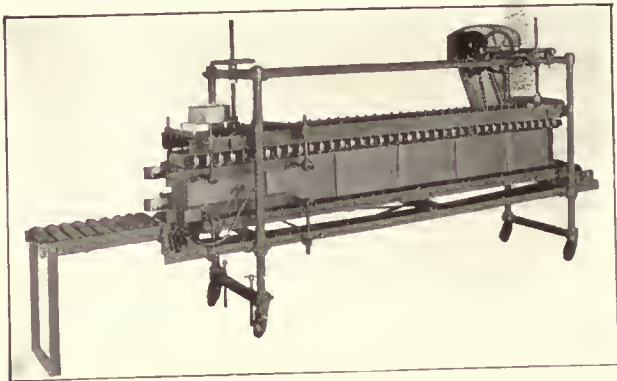

Side View of Portable Top and Bottom Sealing Machine.

box is started by the operator. By this device the speed of the machine is controlled by the speed of the operator and there is no waste of power nor space between cases while the cases are in transit.

The time of travel through the machine is so regulated that exactly the right amount of time is allowed for the crystallization of the silicate of soda.



Showing the Flexible Pressure on the Top of the Case.

Construction Details

Only the finest workmanship and materials enter into National top and bottom sealing machines. They are substantially built and have a long life under the most severe conditions of service. Each machine is completely erected in the company's shops before being shipped.

As an example of the extremes to which the National Binding Machine Co. has gone to make the machines the best possible, the rollers of the upper unit run in phosphor-bronze bearings cast integral with the steel pins which pierce the frame of the upper unit. The rollers of the bottom unit are equipped with ball bearings. All other bearings are either ball bearings or phosphor-bronze.

STANDARD CONVEYORS

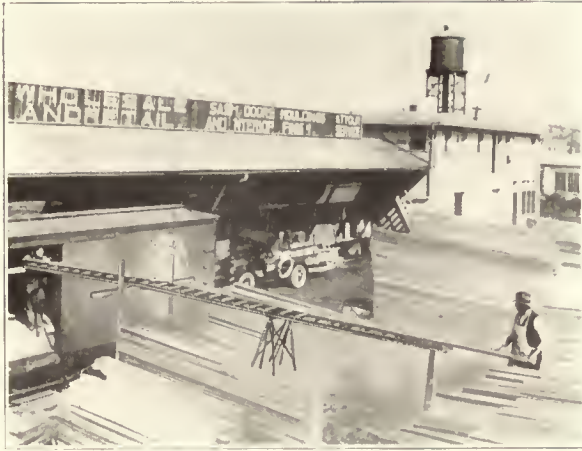

Types

Standard Conveying Systems are built to meet the specific needs of every industry. They include the Standard Gravity Spiral Chutes, with single, double or triple runways; Spiral Fire Escapes; Gravity Roller Spirals; Gravity Roller Conveyors; Portable Slat and Inclined Slat Conveyors; Straight-lift Elevators, and Power Belt Conveyors.



Principal Features of Each

The runway of the Standard Spiral Chute is constructed of wings of steel pressed to spiral shape in a power-driven press. The pitch of the chute is accurately determined to give uniform speed to any loading. Unit construction, automatic fire-doors, and adjustable diverters are the outstanding features.

The heart of the Gravity Roller Conveyor is the bearing, which is exceedingly sensitive and at the same time substantial and lasting. The stud is of the very best cold rolled shafting around which revolve nine steel balls. The rollers are of steel tubing. These conveyors are made in standard 10 ft. sections.

The Portable Slat Conveyors are castor mounted, motor driven, reversible, and can be used in horizontal or inclined position. Made in standard lengths of ten, fifteen and twenty feet.

The Automatic Inclined Elevator receives boxed or cased goods, lifts and discharges from and to gravity conveyor lines without jar at top or bottom.

The Straight Lift Elevator is continuous in operation, is automatically loaded and discharged, and has a detecting device insuring safe loading and unloading.

The Belt Conveyor is constructed to eliminate all drag and reduce friction to a minimum.



Utility

The Spiral Chute lowers merchandise direct from upper to lower floors.

Open Type Fire Escapes afford a non-crowding and protective means of escape.

Gravity Roller Conveyors offer profitable means of transfer for boxed or cased goods.

Merchandise of regular or irregular shapes and sizes is successfully conveyed by Portable Slat Conveyors.

The Inclined Slat Conveyor is adapted for elevating bulky packages of irregular shape.

The Inclined Elevator is used extensively in all industries.

Belt Conveyors are adapted to serve a large variety of industries and constructed to fill their individual requirements.



Flexibility of Standard Conveying Systems

Constructed on the unit plan, built to meet every specific need—it is remarkably flexible.

The company engineers will examine your problem and assist you to plan a system of

conveyors. This service is offered gratis.

Branch offices—New York, Chicago, Milwaukee, Cleveland, Cincinnati. Representatives in all principal cities.



Inclined apron conveyor. One of many units in Hydrox Co.'s plant, Chicago, Ill.



Patented automatic elevator about to discharge to lower run of belt conveyor. Part of American Can Co.'s system, Maywood, Ill.

**Value of
Conveying
Systems**

Samuel Olson & Company have made thorough surveys of almost every industry. These surveys have revealed the fact that conveying systems are an absolute necessity. They are the nucleus of any plant and often regulate entire organizations, for with them more can be accomplished with a smaller amount of help.

Production, the objective of industry, is dependent upon conveying systems. With a well regulated conveying system careless methods of handling materials are eliminated. Raw materials are distributed, products routed to stock rooms and the loading of cars and trucks materially assisted. The installation of a conveying system should be given the same serious consideration that is given to the selection of the plant, equipment, etc.

Samuel Olson & Company make a specialty of designing conveying systems to conform to individual requirements. The service that this company places at the disposal of manufacturers is three fold—designing conveying systems consistent with data secured in making a survey of a handling problem—manufacturing the necessary equipment—and completely installing the machinery. This service is significant inasmuch as the responsibility for the functioning of the conveying system is undivided.

**Scope of
Conveying
Systems**

Samuel Olson & Company manufacture a complete line of conveying and elevating machinery. This enables the company to cope with almost any handling problem. Apron conveyors, package belt and trough conveyors, pivoted tray, patented automatic, bucket and barrel elevators, gravity conveyors, spiral chutes and subveyors, a special

SAMUEL OLSON & COMPANY

2414 BLOOMINGDALE AVE., CHICAGO, ILL.

FIFTH AVE. BLDG., NEW YORK



Combination of spiral chute and gravity conveyor.

patented machine which will handle the most fragile articles with the utmost safety, are included in the line which this company manufactures.

There is a necessity for some type of conveying system in all manufacturing establishments. In some instances the extent of the installation may be limited, depending entirely upon conditions. Apron conveyors are used to handle bulky materials, either horizontally or on an incline. Packing boxes, baled merchandise sacks and pianos are conveyed to advantage on this type of a conveyor. Loose packages of most every description can be handled on package type belt conveyors. Department stores and mail order houses are the largest users of package type belt conveyors. Coal, grain, ashes, sand, gravel, etc., should be handled by means of trough type belt conveyors. Pivoted tray elevators elevate to any desired height articles such as bags, bales, boxes, etc.

Manufacturers having to elevate standard size boxes and tote boxes can reduce their costs by using patented automatic elevators as this is the only elevator manufactured which discharges on the elevating side. Bucket elevators are used principally to elevate sand, gravel, grain, coal, ashes and chemicals. Gravity conveyors are adaptable to certain conditions. Boxes, crates and building materials are the logical commodities to convey with this type of equipment. Spiral chutes lower boxes, bags and bales at a low cost. They afford an economic means of distribution as delivery of merchandise is practically immediate. No attendants are necessary, hence labor costs are lower. The company manufactures standard sizes suitable for the handling of commodities of all types.

The subveyor carries vertically or horizontally discharging automatically from one to the other. It is the ideal equipment in plants having certain standard sized boxes or trays to be carried from one floor to another.

**Engineering
Service**

Samuel Olson & Company maintains a service department which is at the disposal of any industry, architect or engineer. Suggestion or advice is available. Should a survey of a handling problem be required, Samuel Olson & Company will, without obligation, have one of their conveyor engineers make a study of the conditions. Furthermore, they will submit in layout form a solution of the problem, incorporating in it suggestions for equipment which their vast experience dictates as the most appropriate for the requirement.

Write to Samuel Olson & Company giving the type of products to be handled and the space which can be used and the company will submit plans and quotations.

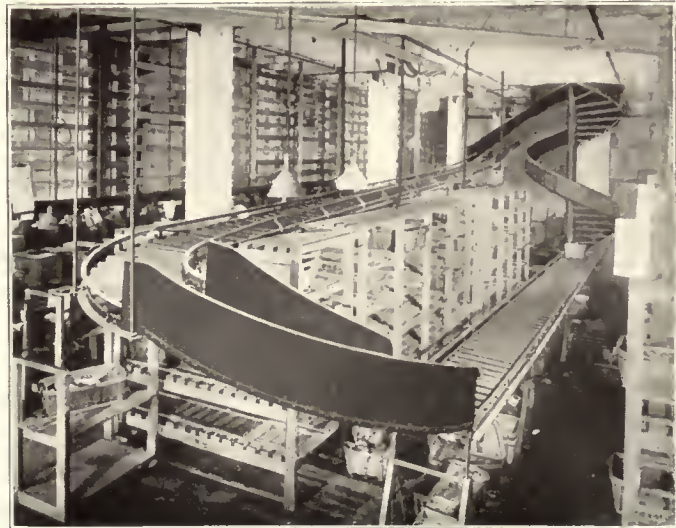

Part of gravity conveyor system installed in Fuller-Morrison Company's warehouse.

(Wholesale Druggists)

SAMUEL OLSON & COMPANY

2414 BLOOMINGDALE AVE., CHICAGO, ILL.

FIFTH AVE. BLDG., NEW YORK

McKINNEY-HARRINGTON PILERS AND CONVEYORS

Standard Type Portable Piler

The McKinney - Harrington, standard type, portable piler is a combination car and truck loader, and piler. Installations in practically every field where material handling machinery is used have proved its value as a labor saving device. It is designed for handling packed materials in any form



Standard Type Piler with Drop Axles Loading Barrels Into a Truck.

of container. The illustrations show the piler loading barrels and piling bags, but boxes, bales or miscellaneous packages can be handled with the same efficiency.

Operation of Piler

The piler is driven by an electric motor in most cases, but if desired, a gasolene engine can be substituted for the motor. The motion of the piler is reversible so that material can be

lowered as well as elevated.

The height of the delivery end is governed by a raising and lowering device. This is composed of a worm at the lower end of the crank rod which rotates the drum shaft. This worm gear does away with the pawl and is operated from the front of the machine. The raising and lowering device on large machines is operated by power.



Standard Type Piler at Work in a Rice Mill.

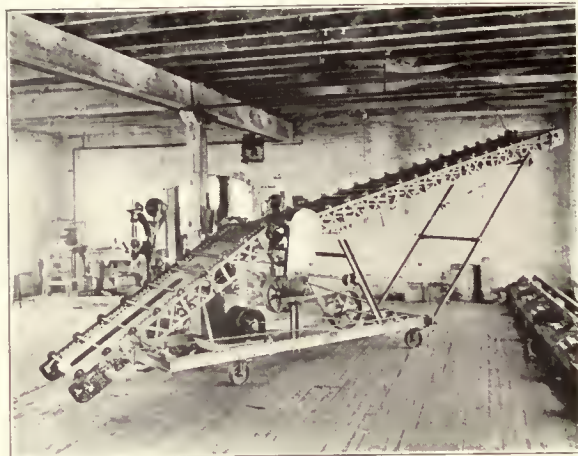

The steel axles are straight for work with packages, boxes or bales. Wooden slats may be fitted between the axles forming a continuous wooden apron. In handling barrels drop or bent axles are used. This keeps the barrel centered, preventing any tendency to roll off the piler. When both boxes and barrels have to be moved, a combination of the two axles is used. Drop axles are inserted for a space of about five feet, then straight axles for the same distance.

The pilers are mounted on small wheels or casters for indoor use and on a wagon frame for use outside.

Combination Piler

For use in connection with a conveyor or for piling and loading, the McKinney-Harrington Company manufacture the combination piler shown at the top of the page. It is better suited to some locations as the long section lowers a little nearer the floor.



Floor Type Conveyor Installed, Showing Three Power Units.

Standard Sectional Conveyor

The conveyors manufactured by the McKinney-Harrington Company are portable machines. They are built in sections enabling the user to lay out or change the entire conveying system at will.

McKINNEY-HARRINGTON COMPANY

NORTH CHICAGO, ILL.

McKINNEY-HARRINGTON LOADERS AND PILERS

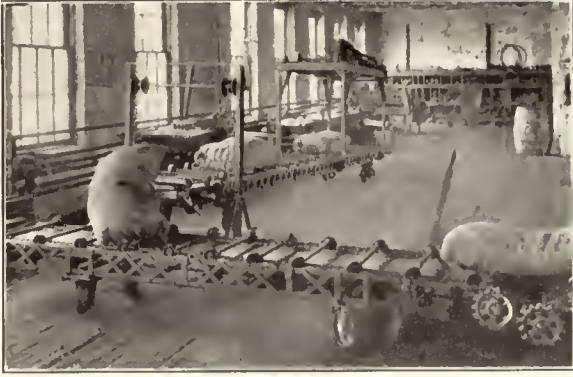

Electric motors furnish the power for operation. Small motors are used and a power unit installed for every two or three sections of the conveyor. This adds to the ease with which a conveyor system can be re-arranged to suit changing conditions. The illustration on the opposite page shows a conveyor installation in which three power units are visible.

The cut above gives a close-up view of one of the conveyors arranged for a right angle turn. It shows the angle stand used for raising one end of the conveyor section high enough to deliver onto the other section as applied to actual use.

These conveyors can be supplied with anyone of the axles used in the piler.

Portable Coal Unloader and Loader

The McKinney - Harrington portable coal loader, unloader and piler is designed to meet nearly all conditions. It needs no overhead track to unload from the top of a car. It is so constructed that it will elevate from dump bottom cars

into a bin, pit, or truck; or from a pile into a car, bin or truck.

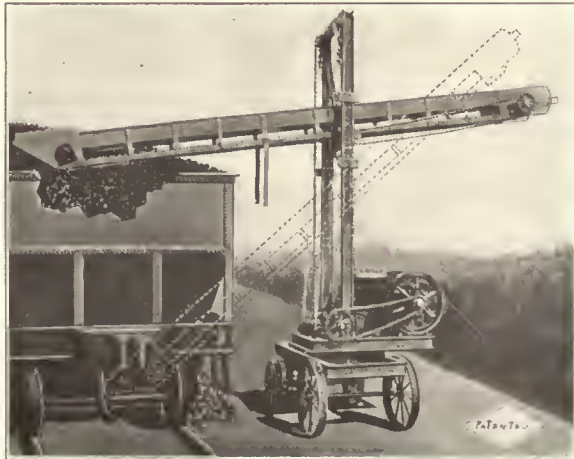

Portable Coal Unloader and Loader.

into a bin, pit, or truck; or from a pile into a car, bin or truck.

The uprights are hinged to allow passing through a door. It is operated with an electric motor or gasoline engine, the power unit being mounted in the base. The

elevator sections are built in different lengths to meet varying conditions. The elevator swivels so that it can be turned and operated in either direction.



Portable Coal Unloader and Loader Handling Coal from Gondola to Trucks.

The illustrations on this page plainly show some of the various uses of this machine. In the first illustration the full lines show the elevator placed on top of a gondola car when the machine is in the swiveled position. The dotted lines show the position of the elevator for use under dump bottom cars or from a pile into trucks or onto a car or bin.

The second illustration shows the machine in use unloading from a gondola car. The variety of heights at which the elevator can be placed are shown by comparing this illustration with the first.

In the third illustration the machine is shown unloading a box car. The elevator enters the car door. No overhead trolleys, hoists or dismantling is necessary.

This company also builds a continuous bucket elevator that mounts on this same frame for handling sand, gravel, crushed stone, minerals, etc., and is operated by the same power.

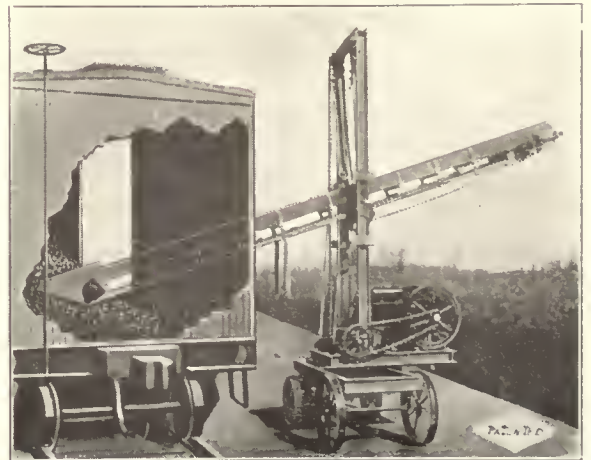

Portable Coal Unloader and Loader Operating in Box Car.

McKINNEY-HARRINGTON COMPANY
NORTH CHICAGO, ILL.

**Inclined
Portable
Elevators**

The Brown Portable Inclined Elevator is a Standard way of piling packed materials. Continuous in motion, readily portable and easily adjustable in height, it is made in any size, to pile to any desired maximum height and to handle practically any kind of package in form to be handled. The Brown Portable Elevator elevates to second floors, loads trucks and can be used for many other purposes. It elevates the highest tier as quickly and cheaply as the lowest, eliminates all the labor usually between floor and top of pile, speeds up the men and makes hard work easy. It is equally successful in reclaiming from piles or tiers. Bulletin 220-A.



Made in Any Size. Height Is Adjustable.

**Horizontal
Conveyors**

Brown Portable Conveyors ("Interveyors") are made in sections of any length desired, to handle bags, boxes, barrels, bales and bundles. These sections may be readily detached or attached, making the system longer or shorter, as required. The entire system may also be operated in conjunction with a Brown Portable Inclined Piling Machine, thus conveying the commodity any distance and elevating it directly to the top of the pile without a man controlling it in transit. The "Interveyor" has many applications and is built to fit conditions. All sections are portable, and the entire system is instantly reversible. Bulletin 220-B.

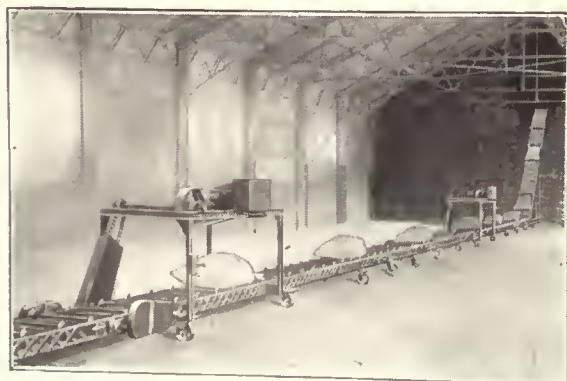

Any Number of Sections May Be Used. Note Means of Propulsion and Accessibility of All Parts. Power May Also Be Underslung.

**Portable Belt
Conveyors**

The Brown Portable Belt Conveyor "Portabelt" is a sturdy, readily portable conveyor designed for the handling of loose material. The "Portabelt" loads 5-ton trucks, with two men, in 10 minutes, whereas 3 men require 40 minutes by hand. The "Portabelt" unloads a 50-ton car, with 2 men, in 4 hours, whereas 4 men require 8 hours by hand. The "Portabelt" is provided with a low receiving "nose" which is placed under the hopper of cars in unloading, or completely buried in the pile in loading.

In unloading cars with a "Portabelt," the material need not be shoveled from in under the car to the conveyor, for as the car doors are opened, the material will fall onto the belt. In a stock pile the material can be scraped onto the conveyor. In either case the labor of feeding is reduced 50%. The "Portabelt" is made in various sizes and widths to suit all common conditions. Bulletin 220-C.



Handles All Bulk Materials.

**Vertical
Tiering
Machines**

Brown Portable Vertical Tiering Machines are made in both hand and power-operated types. They pile heavy, bulky goods to the ceiling as cheaply as to the first tier and as easily as if they weighed but a few pounds. Hand-operated type has scientific arrangement of gears by which even a 1000-lb. load is elevated without strenuous labor. Electrically operated type is a revelation in this type of machine. It embodies the utmost in simplicity, strength and adaptability.

To enable this machine to pass through doors, it is built with the frame hinged, so that the upper part of the frame can be folded down and back. This does not weaken the machine for the joint is a rigid connection when the machine is erected. Made in all sizes and capacities. Bulletin 220-D.



Made in Both Hand and Power-Operated Types.

LINK-BELT ELEVATING AND CONVEYING MACHINERY

Scope of Link-Belt Material Handling Machinery

The Link-Belt Company is the pioneer in the development of the elevating and conveying art, and manufactures practically all types of material handling equipment.

A list of the lines of industry in which Link-Belt Machinery is employed comprises practically the entire



Inclined Apron Conveyor Delivering Automobile Parts from Basement Storage to First Floor Conveyor.

range of industrial activity, because wherever labor is used there is a type of Link-Belt machinery equipment which makes that labor more effective—and more contented.

That equipment includes all types of elevators and conveyors for handling all materials, portable loaders, locomotive cranes, electric hoists, coal and ashes handling systems, loading and unloading machines, crushers, screens, chains, wheels, buckets, etc.

A Machine for Every Purpose

Link-Belt equipment is always built to fit the conditions. Practically every material handling problem is different, requiring individual attention and study.

By that, however, it is not meant that there are no standard Link-Belt machines. There are, such as Link-Belt locomotive cranes, electric hoists, portable

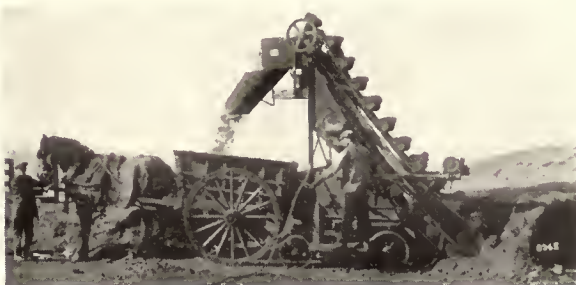

Link-Belt Portable Loader.



Link-Belt Belt Conveyor.

loaders, etc., etc., which are recognized standard types of machines the country over. Such machines often form part of a larger general plan.

The question to determine is: what plan will accomplish the results with the greatest effectiveness and economy.

Link-Belt Engineering Service

It is not practicable for us to give information in this publication which would enable the buyer to pick out such machinery as he might feel would solve his problem. It is to his advantage to let Link-Belt experienced engineers study his problems and recommend conveying equipment which will accomplish the results in the most economical way. The Link-Belt Company makes no charge for advice, layouts or estimates. Link-Belt engineers are prepared to give prompt service in the solution of elevating and conveying problems based on their years of experience in this work.

Catalogs will be sent on request.



Link-Belt Apron Conveyor Handling Boxes.

LINK-BELT COMPANY

PHILADELPHIA

CHICAGO

INDIANAPOLIS

PALMERBEE MANUFACTURING CONVEYORS

Manufacturing Conveyors

A PALMERBEE Manufacturing Conveyor speeds up production—lowers cost of production—maintains uniformity—improves quality—saves floor space—makes labor more contented. On a PALMERBEE Manufacturing Conveyor, you can assemble—heat-treat—enamel—bake—dry or freeze.

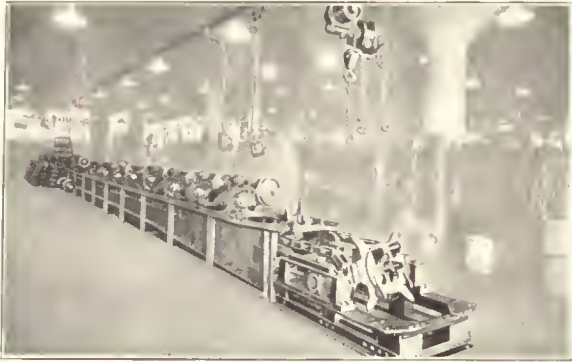

Motor Assembly.

Motor Assembly

In manufacturing automobile motors the cylinder castings move forward on a PALMERBEE Progressive Assembly Conveyor approximately 3 feet per minute, on 4 foot centers.

Each operator performing his own individual task as the motor comes to him.

Progressive assembly of motors means simplified operation—increased efficiency—a floor space saving of from 50 to 100 per cent—and, with a working force of 60 men, there can be produced 60 complete motors an hour. One motor per man per minute.

Enameling, Painting and Drying

Washing — dipping — baking—cooling. No stop to put on—no stop in ovens—no stop to take off.

Pressed steel bodies, fenders, hoods, radiators, splash guards, sheet metal parts, camera metal parts, electrical metal parts, handled mechanically by PALMERBEE methods eliminates scratching or jamming.

Approximately 100 per cent production—better quality.

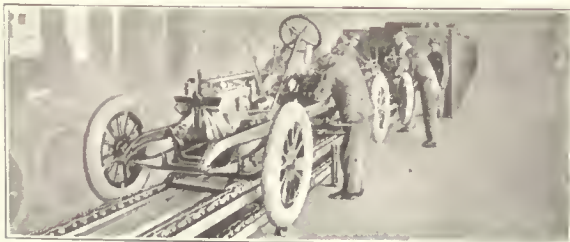

Chassis Assembly.

Chassis Assembly

The net result of chassis assembly on a PALMERBEE Progressive Assembly Conveyor is one complete automobile in 3 hours, or 22 automobiles per hour with 56 men.

The frame comes to the conveyor equipped with

springs and axles. On the conveyor, going constantly forward, the frame picks up the motor, the transmission, steering gear, gas tank, muffler, battery boxes, etc. The chassis is sprayed with paint and, still on the conveyor, moves into a drying oven. After leaving the oven the wheels are added, then the body and accessories.

The automobile leaves the Progressive Assembly Conveyor a finished product ready to run.

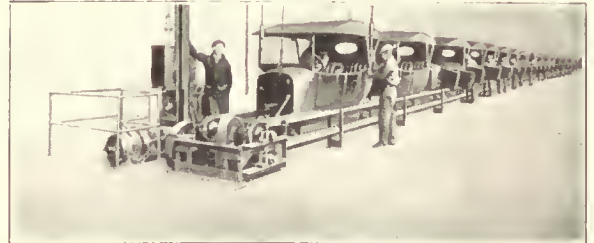

Body Assembly.

Body Assembly

Automobile body manufacturers get more and better production with PALMERBEE Progressive Assembly Conveyors. Bodies trimmed and wired, the windshield and top mounted, while in motion.

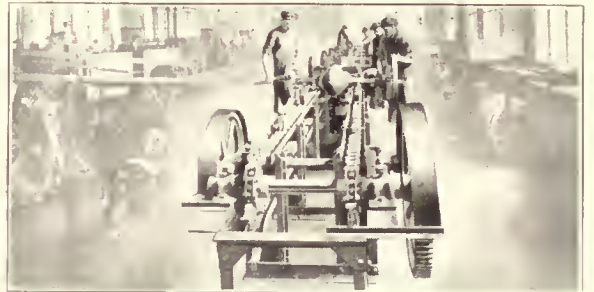

Axle Assembly.

Washing Machines

On PALMERBEE Manufacturing Conveyors washing machines can be assembled, painted, dried and crated progressively. This is but one of the many places where conveyors are used.

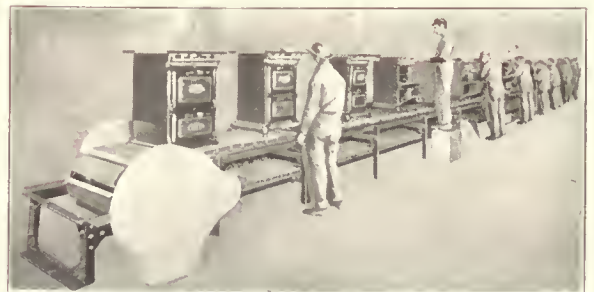

Gas Stove Assembly.

Gas and Electric Stoves and Ranges

For the assembly of stoves and ranges PALMERBEE Manufacturing Conveyors offer proven economies. 30% increase in output—100% less labor—improved quality—simplified inspection—easier work—congestion minimized—floor space saved.

—floor space saved.

PALMER-BEE COMPANY, DETROIT, MICH.

Coal

PALMERBEE Coal Conveyors deliver coal to bunkers via track hopper, feeder, crusher, bucket elevators, screw conveyors, belt and flight conveyors.



Conveying Coal from Hopper to Power House.

Overhead Track Trolleys and Hoists

“Do your trucking on the ceiling”—the PALMERBEE way—and have clear floor spaces. Overhead Trolley and Track systems adaptable over a wide range of industries, store-houses, repair shops, etc.

An electric, air or chain hoist in combination with trolley and track system permits one man to do the work of five.

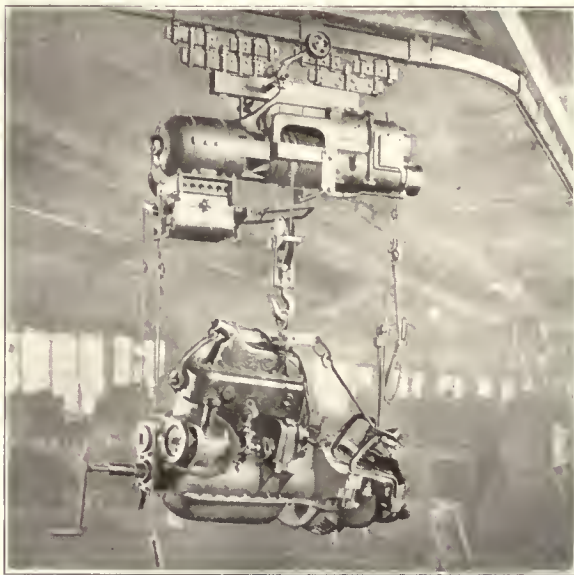

Overhead Track and Trolley.

PALMERBEE overhead trolley track systems are not limited to propelling by hand. The application of a sprocket chain will propel the load over the track system.

PALMERBEE Portable Coke Loaders

The PALMERBEE Company furnish portable coke loaders to gas plants, retail coal dealers, foundries—anywhere where the loading of coke or separation from breeze is required.



Portable Coke Loader.

Belt Conveyors

PALMERBEE Belt Conveyors provide a mechanical means for conveying loose material such as coal, coke, crushed rock, stone, ore, gravel and sand; also package goods, bags, etc.



Palmer-Bee Belt Conveyor.

Cranes

PALMERBEE Traveling Cranes are specially designed to lift and transport heavy loads within a given area.

Hand or power propelled, with electric, air or chain hoist.

1 to 10 tons capacity—roller bearing equipped—crane ends requiring minimum head room.

PALMERBEE Service

The PALMERBEE Company offers a complete Engineering, Designing, Building and Erecting service to all who would be relieved of, or need assistance in, their material handling problems. Their engineering department is maintained for the express purpose of designing special or adapting standard appliances to suit requirements for the economical handling of your products.

PALMERBEE Service is made possible by specially trained engineers—long practical experience.

Results are guaranteed.

FORD CHAIN HOISTS

The Ford Tribloc

Because of its rugged, yet simple construction and its speed and efficiency in handling loads, the Ford Tribloc is particularly adapted for handling material of all kinds. It lowers

smoothly and rapidly; it holds the load securely.

A distinctive feature is the Patented Loop Hand-Chain Guide, standard equipment of Ford Triblocs in all sizes from 1/4 to 20 tons. This guide is an endless malleable iron loop having fixed guiding strips adjacent to the flanges of the wheel, extending from one guide to the other and conforming to the circumference of the wheel.

The Loop Hand-Chain Guide has many advantages over the old style strap guide. It prevents injury to the block by protecting the hand wheel and preventing the hand chain from buckling in the guide, even when the hoist is operated at very high speed. It permits rapid travel of the hand chain without overriding the flange of the hand wheel.

Durability is still further insured by making all working parts of steel and covering the cut gears by a dust proof pressed steel case. Hooks are of drop-forged steel.



Ford I-Beam Trolleys

The Ford Chain Block Co. carry in stock roller-bearing, steel plate, I-beam trolleys, in both the plain and geared types. Standard sizes are given in table below. Trolleys may be

widened to suit larger than the standard I-beam without extra charge.

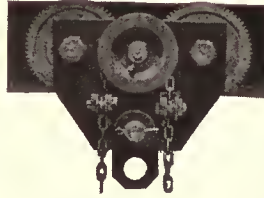

CAPACITIES, I-BEAM DATA, ETC., FOR FORD TROLLEYS

Capacity in Tons	Standard Size of I-Beam in Inches*	Diameter of Wheel in Inches		Smallest Radius for I-Beam Curve	
		Plain	Geared	Plain	Geared
1/4	4	3	--	18	--
1/2	5	3 3/4	--	21	--
1	6	4 1/2	4 3/4	21	21
1 1/2	7	5 1/2	5 1/2	30	30
2	8	6 1/2	6 1/2	36	36
3	9	7 1/4	7 1/4	42	42
4	10	8 1/4	8 1/4	48	48
5	12	10	10	54	54
6	15	10	10	60	60
8	20	12	12	60	60
10	24	13	13	60	60
12	24	13	13	60	60
16	24	18	18	96	96
20	24	18	18	120	120

* Can be altered to suit larger beams.

Widely Used

This chain hoist is the ultimate development of many years' experience. Its wide use, in all industries, demonstrates conclusively its superiority for quick and efficient service.

It is particularly adapted to work in machine shops where heavy pieces must be placed in accurate position before production can be started. One Ford Tribloc will save the cost of two and sometimes three laborers and soon pay for itself in reduced wages.

Screw and Differential Hoists

Where the highest speed and efficiency are not required, the Ford screw gear hoist is frequently used. Because of its lighter weight, this type is well adapted for portable use.

Simplest of all chain hoists is the Ford Differential Hoist. It is recommended for work where a hoist is used but occasionally, and high efficiency and speed are not essential.

CAPACITIES, WEIGHTS, ETC., OF FORD TRIBLOCS

Capacity in Tons	Regular Hoist in Feet*	Reach in Feet and Inches	Min. Distance Between Hooks in Inches	Net Weight in Pounds	Chain Pull in Pounds to Lift Full Load	Feet of Chain Handled to Lift Load One Foot
1/2	8	9' 3"	13	53	62	21
1	8	9' 5"	16	80	82	31
1 1/2	8	9' 7 1/2"	18	124	110	35
2	9	11'	21	188	120	42
3	10	12' 8"	32	200	114	69
4	10	13' 1"	37	290	124	84
5	12	15' 9"	45	380	110	126
6	12	15' 10"	46	390	130	126
8	12	16' 3"	49	470	135	168
10	12	16' 9"	54	570	140	210
12	12	16' 9"	54	800	130†	126†
16	12	17' 1"	62	1000	135†	168†
20	12	18' 5"	70	1375	140†	210†

32) Prices and full particulars upon request.

* Figures denote height in feet which blocks with regular lengths of chain will hoist above level on which operator stands.
† For each hand chain.

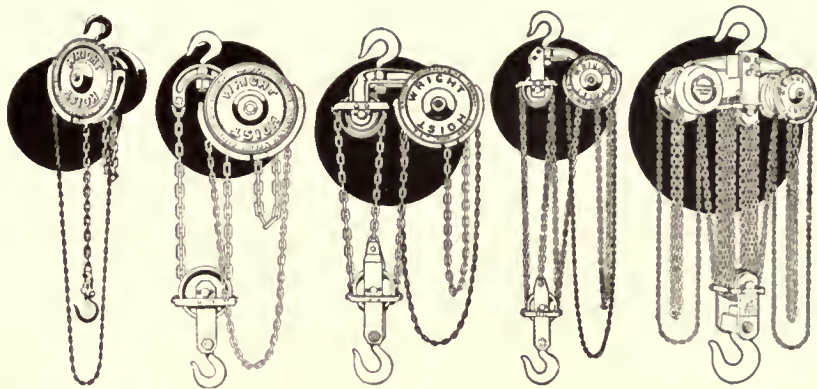

Design

The design of the Wright hoist is wrapped around a single word "dependability." Ever since the days when this plant of specialists—for here the whole thought of every member of the organization is devoted to hoists—was first organized—the one predominating thought has been the perfection of a hoist that would not fail in action, one that when the load was hoisted the operators would know perfectly well that there would be no danger of injury and the manufacturer that his product upon which he had spent so much time and money would not slip and fall through failure of the hoist.

Features

In the construction of the Wright hoist many unusual features are found. This is the case because every condition the hoist may encounter in service is anticipated—including downright abuse. For example, in the nickel, carbon-steel driving shaft and pinion a strength of four times the hoist's rated capacity is found. Then, the load chain wheel, the heart of any hoist, is a steel casting that is guaranteed not to break, and the load chain itself will work at from three to four times the rated capacity of the hoist. Add to these the facts that the hook will safely carry up to six times the rated capacity without bending and that the locking device for holding

the load suspended is absolutely positive and dependable, and the features of this hoist have become known.

Types of Hoists

The high-speed hoist is the last word in hoist construction. By its use human effort in the handling of materials is actually reduced to a minimum.

The screw hoist is good for general repair work, where the hoist must be continually shifted about and the differential is suitable where a hoist is needed only occasionally.

With a one-ton high speed hoist, a pull of only 80 lbs. on the hand chain is needed to lift the load.

Another type of Wright Hoists is the "Twin-Hook" in which a single hand wheel and chain operates two mechanisms. By its use, one man can raise evenly long pieces, motor truck bodies, etc., etc.

Still another variation is the hoist with a hand wheel extension which is especially valuable when the heat from a furnace or the size of the work to be lifted is such that the operator cannot stand directly underneath the hoist.

The Wright High-Speed Trolley Hoist is another form. It is designed especially for use in buildings where head room is limited—in cellars, warehouses, etc.

Wright hoists are made in sizes ranging from ¼ ton to 30 tons.

Our new book on hoists will be sent upon request to the readers of this Cyclopedia.



This Foundry's Right Arm. The Wright High-Speed Hoist.



One Man Easily and Safely Lifts the Load.



Speeding Up Production with a Wright Hoist.

READING ELECTRIC HOISTS

Distinctive Features

The Gears are cut from solid blanks of high-tensile steel and are enclosed in an oil-tight, dust-proof casing, in which they



Must Make Good
—or We Will

Geared Positive Automatic Limit Stop for lifting and lowering. Adjustable to any height of lift.

Every Reading Hoist is equipped with a double brake—one automatic self-adjusting, the other controlled by operating cords.

Either will hold the load independently of the other.

operate in a bath of oil.

This provides Automatic Lubrication and insures high efficiency and low cost of maintenance.

Unit Plan of Construction

Each part is an independent unit, readily accessible for inspection, and can be removed without disturbing any of the other units.

The motor and controller are mounted separately on one end of the main frame, gear case and limit stop mounted at the opposite end.

Winding drums are in the center of main frame.

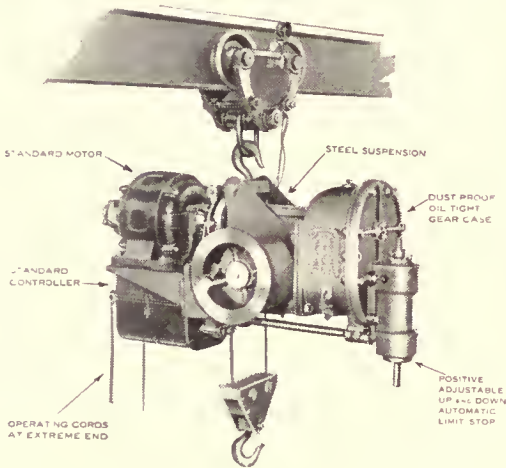

Reading Electric Hoist.

Perfect Balance at all times, with or without load, insured by the use of two drums, the lower hook remaining always central with point of suspension.

Variety of Types

These hoists are built for 110, 220 or 500 volts, direct current, and alternating current, 220, 440 or 550 volts, 2 or 3 phase, 60 cycles.

For Hook Suspension.

With Plain Trolley.

With Hand Operated Geared Trolley.

With Motor Driven Trolley—floor control.

With Motor Driven Trolley—traveling cage control.

There are 24 types ranging from 1/2 to 10 tons capacity and suitable for all requirements.

Write for Catalog No. 48 and supplement.

A. C. ELECTRIC HOISTS

Type	Capacity, lbs.	Max. Lift in Feet	Speed in ft. per min.	Net Weights			
				Hook Type	With Plain Trolley Std. Type	With Geared Trolley Std. Type	With Motor Drive Trolley
A	1000	20	17½	400	450	475	700
AA	1500	20	14	400	450	475	700
A	2000	10	8¾	420	500	525	720
B	2000	30	17	685	765	790	985
BV	2000	30	15	735	815	840	1035
AA	3000	10	7	420	545	540	720
BB	3000	30	14	685	780	805	985
BBV	3000	30	15	735	830	855	1035
B	4000	15	8½	715	835	860	1015
C	4000	30	16½	765	885	910	1065
CC	4000	30	24	1150	1250	1275	1430
BV	4000	15	9	1160	1280	1305	1460
CV	4000	30	17	1180	1300	1325	1480
CCV	4000	30	24½	715	860	890	1030
BB	6000	15	7	765	910	940	1080
C	6000	30	10	1165	1310	1340	1480
CC	6000	30	16½	1195	1340	1370	1510
BBV	6000	15	7½	1195	1340	1370	1510
CV	6000	30	10	1170	1295	1430	1575
C	8000	30	17	1200	1425	1460	1615
CC	8000	15	8¾	1220	1415	1450	1605
CCV	8000	15	12	1760	1925	1960	2215
CCV	8000	15	8½	1750	1975	2010	2265
DV	8000	15	12¾	1180	1435	1500	2028
C	8000	32	16	1210	1465	1530	2058
CC	10000	15	9½	1250	1485	1550	2078
CV	10000	15	9½	1720	1975	2040	2268
CCV	10000	15	6½	1760	2015	2080	2268
CCV	10000	15	9¾	1210	1585	1635	2058
DV	10000	32	14½	1240	1625	1675	2090
C	12000	15	5	1250	1425	1475	2100
CC	12000	15	8¾	1740	2115	2165	2500
CV	12000	15	5	1775	2150	2200	2625
CCV	12000	15	8½	1785	2285	2335	2635
DV	12000	30	12½	1795	2265	2345	2645
DV	16000	16	8	1805	2405	2480	2655
DV	20000	16	7¼	1825	2425	2500	2675

D. C. ELECTRIC HOISTS

Type	Capacity, lbs.	Max. Lift in Feet	Speed in ft. per min.	Net Weights			
				Hook Type	With Plain Trolley Std. Type	With Geared Trolley Std. Type	With Motor Drive Trolley
A	1000	20	19½	400	450	475	700
AA	1500	20	15½	400	450	475	700
A	2000	10	9½	420	500	525	720
B	2000	30	19	685	765	790	985
BV	2000	30	19	735	815	840	1035
AA	3000	10	7¾	420	515	540	720
BB	3000	30	15½	685	780	805	985
BBV	3000	30	15½	735	830	855	1035
B	4000	15	9½	715	835	860	1015
BV	4000	15	9½	765	885	910	1065
CV	4000	30	19	1130	1250	1275	1430
CCV	4000	30	21	1160	1280	1305	1460
CCV	4000	30	26	1180	1300	1325	1480
BB	6000	15	7¾	715	860	890	1030
BBV	6000	15	7¾	765	910	940	1080
CV	6000	30	12	1165	1310	1340	1480
CCV	6000	30	15½	1195	1340	1370	1510
CCV	6000	30	19	1195	1340	1370	1510
CV	8000	15	9½	1170	1395	1430	1575
CCV	8000	15	10½	1200	1425	1460	1615
CCV	8000	15	13	1220	1445	1480	1635
DV	8000	32	16½	1700	1925	1960	2215
DDV	8000	32	21	1750	1975	2010	2265
CV	10000	15	7¾	1180	1435	1500	2028
CCV	10000	15	9½	1210	1465	1530	2058
CCV	10000	15	10½	1230	1485	1550	2078
DV	10000	32	15	1720	1975	2040	2268
DDV	10000	32	16½	1760	2015	2080	2268
C	12000	15	6	1210	1585	1635	2058
CCV	12000	15	7¾	1240	1625	1675	2090
CCV	12000	15	9½	1250	1625	1675	2100
DV	12000	30	12½	1740	2115	2165	2500
DDV	12000	30	15	1775	2150	2200	2625
DV	16000	16	8¼	1785	2285	2335	2635
DDV	16000	16	10½	1795	2265	2345	2645
DV	20000	16	7½	1805	2405	2480	2655
DDV	20000	16	8¼	1825	2425	2500	2675

READING TRAVELING CRANES AND CHAIN HOISTS

Design and Construction

The design of the Reading Traveling Cranes is the result of 20 years practical experience in the manufacture of hoisting

machinery.

Their cranes are of the most rigid, All Steel Construction, built for severe service.

End trucks so connected to crane beam, that it is impossible for the crane to get out of square.

Truck wheels run on steel roller bearings and have chilled and ground treads.



Reading Single I-Beam Crane.

Types and Capacities

Single I-Beam type, standard or suspended, plain or geared, 1 to 10 tons capacity up to 40 feet span.

Double I-beam type, 3 to 30 tons capacity up to 60 feet span.

Double Girder Type—bridge built of riveted steel plate girders; 5 to 30 tons capacity, up to 100 feet span.

Write for catalog No. 49.

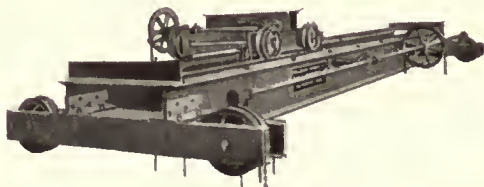

Reading Double I-Beam Crane.

Reading Hoists and Cranes

The hoists used in connection with these cranes are the Reading Multiple Gear Type or Reading Electric Hoists.

Double I-Beam Cranes can be equipped with one or two

READING
C AND B
PRODUCTS

Must Make Good
—or We Will

Multiple Gear Hoists, as desired, and also with an auxiliary hoist suspended from a separate trolley, running on the lower flange of one of the crane bridge beams.

The main trolley on Double I-Beam cranes can also be mounted between the crane bridge beams (Submerged Type), when overhead room is limited.

Plain Differential Type

For handling small loads occasionally, the Reading Differential Chain Hoist is a very useful and desirable appliance.

It is light and easy to handle; it has no parts to wear out; it holds the load stationary at any point, unless the hand chain is pulled.

For garage work, or in any place where men are available, and where a Multiple Gear Hoist would be uneconomical, the Reading Differential Chain Hoist will fully meet the requirements.

A complete line ranging from $\frac{1}{4}$ to 2 tons capacity.

Write for bulletin D-1 for further information.



Differential Hoist.

Multiple Gear High Speed Type

Distinctive Features are:

Gears and pinions are cut from solid steel blanks, and are enclosed in an oil-tight, dust-proof casing, in which they operate in a bath of oil.

This provides Automatic Lubrication of all parts and insures free and easy movement, quickest performance, the least wear and the longest service.

The brake consists of but four parts, is self-adjusting, and takes up its own wear. It holds the load stationary at any point.

The Chains are made in their own chain plant from material of their own special analysis. Each link is carefully blocked to insure correct pitch and accurate fit, and every chain is subjected to a rigid inspection and test before being put on a hoist.

All hooks are drop forged and will hold safely a load of five times the capacity of the hoist.

Each Chain Hoist guaranteed against defective material or workmanship for its life.

A complete line ranging from $\frac{1}{4}$ to 20 tons capacity. Write for catalog No. 47 for further information.

Quality, high grade workmanship and efficiency are distinctive features of all Reading products. Protection to life and property is the first consideration in all products of the Reading Chain and Block Corporation.

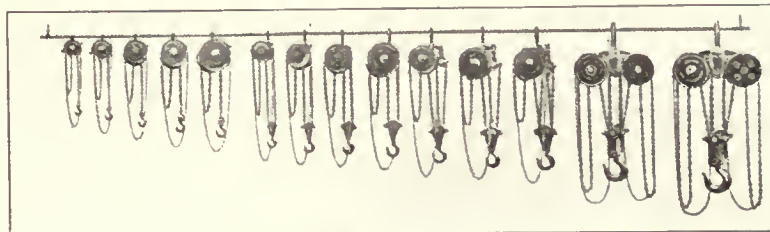

Reading Multiple Gear Hoists.

C-M HOISTS, TROLLEYS AND CRANES

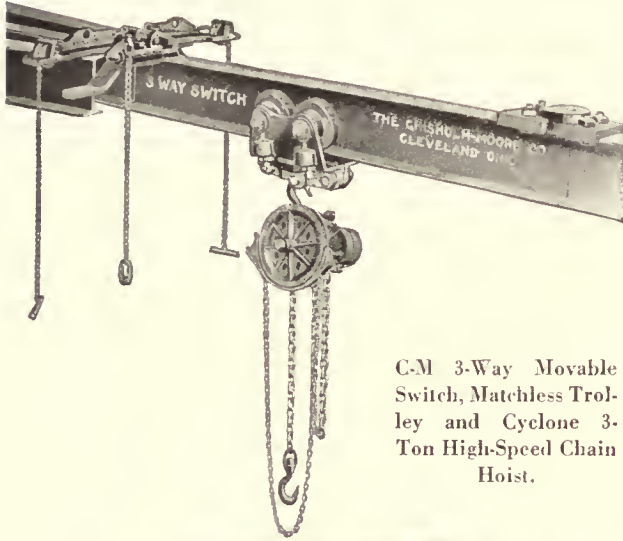

C-M 3-Way Movable Switch, Matchless Trolley and Cyclone 3-Ton High-Speed Chain Hoist.

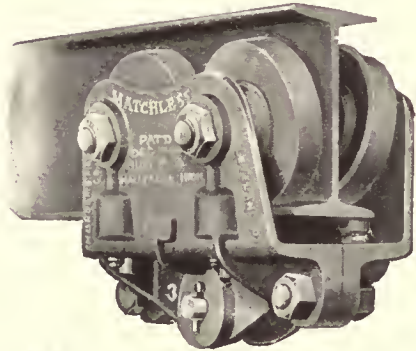

C-M Matchless Adjustable Frame Trolley (also built in geared type). Hoist hook reaches within 1½" of I-Beam.

Chisholm-Moore Material Handling Equipment

Chisholm - Moore Material-Handling Equipment includes: Cyclone High-Speed Chain Hoists, "Moore" Anti-Friction Chain-Hoists, Standard Screw chain-hoists, and Direct differ-



C-M Overhead Trolley System Serving Shears and Saws in Knife and Forge Plant.

ential pulley blocks; Matchless Adjustable Malleable Frame Trolleys, plain and geared in single and tandem styles, C-M Geared and Plain Yoke Trolleys and C-M Detachable Trolleys; C-M 2-way, 3-way and 4-way movable switches; also automatic switches; C-M Traveling Cranes, Wall Bracket and Mast Jib Cranes; C-M Trolley Hoists, Ammunition and Gun Hoists, Hand and Power Winches and complete C-M Overhead Systems.

For more than a quarter-century Chisholm-Moore engineers have specialized in the design and manufacture of material-hoisting and handling equipment. This extended and widely-varied experience is at your disposal in the study of your problems and in the planning of systems exactly fitted to your individual needs. The illustrations on this page merely suggest the wide scope of C-M equipment; complete descriptions and illustrations can be obtained by writing for a catalog, which gives you an abundance of hoisting and handling information.

Cyclone Hoists

The secret of Cyclone speed, durability and efficiency lies in the gyrating yoke. This mechanism gives the user three advantages: (1) it produces a higher gear ratio in less space; (2) it supports the load at all times on 2/3 of all the teeth (not on one tooth only); (3) the presence of two yokes means that the pull is always carried at two points directly opposite, thus reducing friction to a minimum. This gives a hoist with no small delicate



Cyclone Shock Absorber Hoist Suspended from Matchless Trolley Serving a Trip Hammer.

parts to break or require frequent adjustment, a powerful drive with remarkably small frictional loss, least possible exertion to lift the load and high speed with smooth, positive action free from vibration.

A multiple disc brake automatically holds the load in any position and releases without jerk or jar, the handwheel spinning freely in either direction when there is no load. Malleable iron frame. All gears machine-cut. Three main bearings are steel roller-bushed, all others fitted with graphite bronze bearings. Chain is made in our own plant from special analysis steel, and tested to 50% overload strain. Built in ¼, ½, 1, 1½, 2, 3, 4, 5, 6, 8, 10, 12, 16, 20, 30 and 40 ton capacities.

C-M HOISTS, TROLLEYS AND CRANES

C-M Matchless Trolleys

Built of malleable iron carefully proportioned to provide great strength, the use of Matchless Trolleys insures a large factor of safety. The load is carried equally on all four wheels. The trolley is adjustable to varying sized I-beams by means of small vertical guide rollers mounted on an eccentric shaft opposite each track

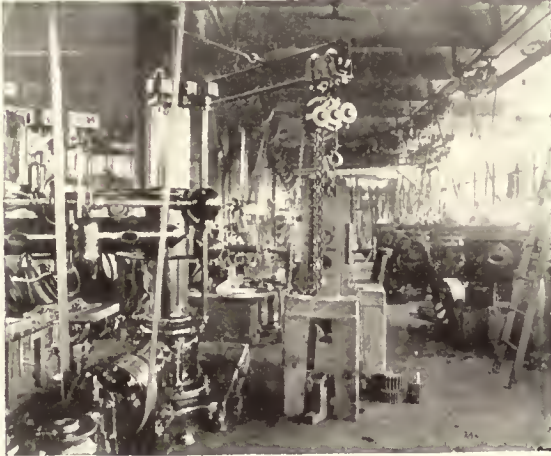

Handling Heavy Castings with a C-M Jib Crane, Cyclone Hoist and Matchless Trolley.



Piling Castings with C-M Crane, Cyclone Hoist and Matchless Trolley.

wheel. Track wheels are flangeless so that trolley may pass freely on track curved to an 18" radius. Matchless Trolleys are built in both plain and geared types, in the latter all gears being machine-cut. Roller bearings, axles and rollers are made of hardened steel.

C-M Traveling Cranes

C-M Traveling Cranes are furnished in many standard and special types to meet the demands of the user. They are built with single or double bridge, overhead, transfer and underhung types. On receipt of requirements as to length of span, maximum load and distance from track to floor the company will forward blue-prints showing construction and clearance and submit prices.

C-M Complete Hoisting and Conveying Systems

C-M Complete Hoisting and Conveying Systems (see typical installation photo in first column) are remarkable time and labor-savers wherever installed. Composed of items which are each distinct leaders in their respective classes—Cyclone Hoists, Matchless Trolleys and C-M two, three and four-way switches—the result is an overhead system of the greatest efficiency.

Correspondence in regard to prices or specifications for such systems will be given prompt attention.

Branch Offices of the
CHISHOLM-MOORE MFG. CO.,
CLEVELAND, O.

30 Church St., New York
Peoples Gas Bldg., Chicago
Henry W. Oliver Bldg., Pittsburgh

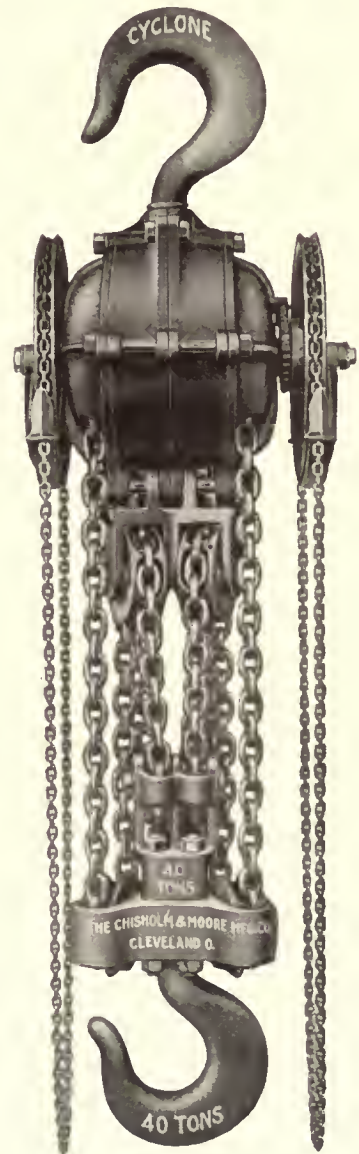

Cyclone 40-Ton High-Speed Chain Hoist. Cyclone Hoists are the only single-unit hoists built for capacities above 3 tons.

CHISHOLM-MOORE MFG. CO., CLEVELAND, O.

MORRIS CRANES AND HOISTS



Worm-Gear Mechanism



Spur-Gear Mechanism



Triple-Gear Mechanism

Morris Products

As specialists in the design, manufacture and application of lifting machinery, Herbert Morris Incorporated manufacture the following products:

Portable Chain-Blocks, Overhead Runways, Trolleys, Traveling Chain-Blocks, Hand-Operated Overhead Traveling Cranes, Crane-Ways, Gantry Cranes, Hand-Operated Jib-Cranes, Telescopic Ash Hoists, Various Hand-Operated Lifting Equipment such as Winches, Rope Blocks, Eye Hooks, Tripods, Slings, Clamps, Trays, Buckets, and Jacks.

Morris electric equipment includes Portable Hoists, Overhead Runways, Trolley-Hoists, Overhead Traveling Cranes and Friction Hoists.

Herbert Morris Incorporated are, furthermore, in a position to consult with you concerning specially designed equipment to meet your particular requirements. Large catalog will be sent on request.

Morris Geared Chain-Blocks

The three models of Morris Geared Chain-Blocks are fitted with an automatic brake, actuated by the reaction due to the load. They are further equipped with machine-cut gears, reliable load-chain, accurately made pocket-wheels and forged hooks.

The worm gear chain block is adapted to capacities from 1/8th ton to 60 tons. The double-thread high angle machine-cut worm gives a remarkably small friction loss.

For regular day-in and day-out service, under good conditions, such as in a modern machine shop, the Morris spur-gear chain-block with its high efficiency is selected by discriminating users.

In an atmosphere of dust or steam a Morris triple-gear chain-block should be used; its gears are well protected by a close-fitting, pressed steel cover. The compact, balanced mechanism allows a close, high lift.

Morris Traveling Worm-Gear Chain Blocks

In purchasing a chain-block it is advisable to consider the advantages offered by the traveling type. This type consists of a Morris chain block built into a trolley, arranged to

run on the lower flange of an I beam. By such a trolley, heavy loads may be easily moved and accurately placed.

Overhead I-Beam Runways

The Morris system of overhead runways is designed to overcome the handicaps of narrow doors, irregular floors, pipes, shafting, wiring, etc.

To eliminate the troubles of poorly working switches, such as getting out of adjustment, binding, jerking, and so on, specify Morris Q.E.F. junctions. This junction has no moving parts. There are no open ends. Each trolley is fitted with steering gear by which it may be guided through the switches. No stop, no hesitation.

Morris runways are being used in machine shops, foundries, biscuit factories, chemical plants, tanneries, glass works, warehouses, freight sheds, textile mills, lead works, automobile plants, power houses and both indoors and out-of-doors. Ask for Bulletin 311.

Jib-Cranes

Morris jib-cranes are standardized in a great variety of types: they may be attached to a wall or post, or they may be arranged self-supporting or "independent."

The hoist may be fixed at the end of the jib, or it may be suspended from a trolley of the I-beam or top-running type.

Component parts are standard, and are carried in stock. The structure is designed to meet varying requirements. Ask for Bulletin 521.

Hand-Operated Overhead Cranes

Morris hand-operated overhead cranes are similarly standardized in a wide range of styles. Stock parts, produced in quantities, facilitate prompt shipment and insure a uniformly reliable product. Machine cut lifting gears, automatic load-brakes and roller-bearing travel-wheels are outstanding features of all Morris hand cranes. Ask for Bulletin 401.

Canada

For prompt service and the best of lifting machinery in Canada, consult The Herbert Morris Crane & Hoist Co., Ltd., at Niagara Falls, Ont.



20-Ton Crane in a Pumping Plant.

HERBERT MORRIS INCORPORATED

BUFFALO, N. Y.

Saving Money with Euclid Hoists

The cost of handling material by hand is much higher, and the saving that could be effected by installing an electric hoist much greater, than is generally understood.

The speed of an electric hoist requiring only one man to operate it is from ten to twenty times that of a hand hoist requiring from one to three men. The labor saved by installing only one 2-ton electric hoist in place of one 2-ton chain block (assuming that there are 25 lifts of 2 tons per day to an average of 7 feet) is enough to pay for the electric hoist in four months. Multiply this by the number of men handling material in your plant and you will have some conception of the saving to be effected. The cost of current is negligible. In the example given above, it would be less than 5 cents per day.

Euclid hoists are all electrically operated. The frame is in one piece. The motor platform is substantial and so arranged that any standard hoist motor can be used, while the various standard types of suspension yokes and trolleys are all interchangeable and all fit the standard hoist casings.

Accessibility of All Parts

The accessibility of all parts can be seen from the illustration above. A Euclid hoist can be disassembled in two or three minutes by any workman. After removing the cover on the casing

end, all the shafts and gears can be taken out without in any way interfering with anything else. The armature of the hoist motor can be removed separately or the motor can be taken off without interfering with any other part.

Details of Construction

Spur gearing is used on all types of Euclid hoists. There are three reductions. The first two, with the mechanical brake, run in an oil tight casing. This is a feature of great importance

in foundries and other plants where the hoist is constantly exposed to dirt. As the motor is at one end of the hoist frame and the gear case at the other, it is impossible for oil to reach the motor and cause trouble.

All the hoist bearings are of ample size to prevent heating or rapid wear under the hardest service. The brake is of the disc type and so designed that on the smaller sizes no motor brake is required.

A limit attachment of the lever type is furnished on all floor controlled hoists, which acts on the controller, returning it to the neutral position or automatically reversing before the hook block can run up high enough to do any damage. A lower limit can also be furnished as an extra when required.

The hoisting drum is a heavy iron casting, with machine cut grooves, of sufficient size to take all of the hoist cable without overwinding. The cable is fastened to the drum in such a way that it cannot get loose, but can be very quickly replaced by a new one when worn out.

Variety of Types and Sizes

for any set of conditions.

The basic features of design and construction are the same for all types of Euclid electric hoists. The sizes and details of equipment however vary, making a number of types sufficient

the single suspension type to be used in place of a chain block; hoists with either plain or geared hand power trolleys; hoists with motor driven floor control trolleys; cab operated trolleys; and electric derrick hoists in capacities from 1/2 to 15 tons.

With such a variety of types and sizes it is little wonder that Euclid hoists have found their place in such a variety of industries. They are already installed in ice plants, warehouses, rolling mills, forge shops, foundries and bridge and machine shops. Their flexi-

bility and adaptability to conditions makes them a valuable addition to any shop.

Other Euclid Products

In addition to electric hoists and trolleys the Euclid Crane and Hoist Co. manufacture a complete line of one, two and three motor overhead traveling cranes, both single and double girder types, floor or cab controlled; also electric and hand driven transfer bridges; I-beam switches and hoist units for storage battery trucks.

The overhead traveling cranes can be supplied varying in capacity from one-half to 15 tons, in spans not exceeding 70 feet. They are particularly adapted for all machine shop and foundry service, or any work of similar nature.

Repair Parts in a Day

The service to the buyer does not stop with his purchase, however. In any hoist or crane, parts will eventually wear out or break, and at times this may cause a severe loss in time and money. All the parts of the standard Euclid electric hoists and cranes are carried in stock and shipments can be made promptly. Under ordinary conditions, 90 per cent of all orders are filled the same day that the order is received.

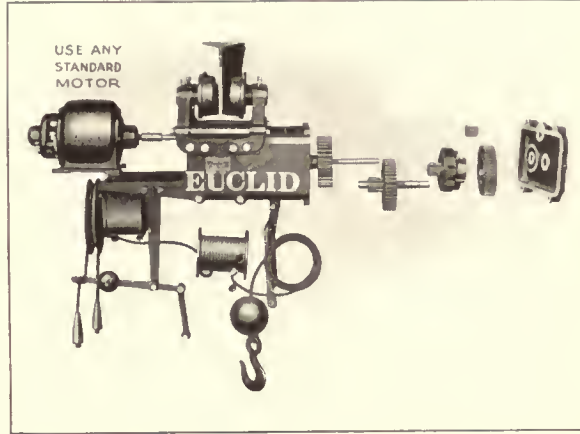

Euclid Electric Hoist

MARIS "I" BEAM TROLLEY—ELECTRIC HOIST

Easy Movement of Maris "I" Beam Trolleys

are faced to a double cone. This feature brings the bearing in a line with the center of the tread, and central with the roller bearing. The double cone face has a further advantage in greatly reducing friction while passing around curves.



Plain "I" Beam Trolley.

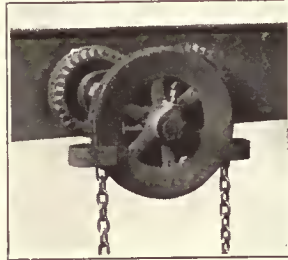

Geared "I" Beam Trolley.

The Way a Maris "I" Trolley Is Made

one side by a large nut and by a shoulder on the other. The shackle for hanging the hoist is of steel. Hard steel roller bearings in grease retaining cages are used throughout. This feature in conjunction with the lateral movement of the wheels on the studs, reduces friction and prevents binding against the face of the stud.

With the exception of the wheels all parts of a Maris trolley are of steel. The sides are thick steel plates. The wheel studs are forced into the plates, under heavy pressure, held on the other.

Maris trolleys have as few parts as possible, thereby reducing the breakage risk to a minimum. The large size and correct proportions of roller bearings, the special hardness of chilled treads combined with the all steel construction, renders the Maris trolley practically indestructible.

Maris Ice Handling Crane

The usual method of handling ice in cans is by means of a light crane with a suitable hoist. Except for continuous and particularly rapid work, where a motor traveling drive may be advantageous, a crane moved by pushing on the suspended can fills all requirements at a very moderate cost.

The Maris totally enclosed electric hoist designed especially for this work, enables one man quickly to raise and remove the ice.

Maris ice cranes have the easy running features of all Maris cranes.

Hoists have either direct or alternating current motors, as required. All parts are enclosed in an oil tight case from which no oil can escape to contaminate the ice.

Operation

Hoisting or lowering is done by pulling on the cords attached to the controller lever. An automatic limit switch prevents the can being raised too high. All parts are readily accessible for inspection and repairs.

When writing for information state the weight to be carried, the span of the crane, the kind of current—whether A.C. or D.C., and if the crane is to be equipped with electric traveling drive.



Maris Hand Push Crane with Enclosed Electric Hoist in Can Ice Plant.

Electric Hoist for General Duty

In shops, warehouses and mills having sufficient use for an electric hoist, the Maris electric hoist will justify its cost in labor saving. The Maris electric hoist embraces all the latest features in safety, clearances, brakes and gears, ease of renewals, etc.

The safety features of the Maris hoist results from various factors. Simplicity in design, lowest possible number of parts, and the main frame casting with the suspension lugs of steel and surrounding the rope drum are all safety features of Maris hoists. Steel wire rope is wound on a grooved drum. The automatic limit switch is operated directly from the running block.

The distance between the hook and top of hoist is designed to be as small as possible with hook at highest point.

The brake and gearing run in a bath of oil. The brake serves the double purpose of holding the load and bringing the armature to a prompt stop.

The motor being a complete unit can easily be removed. All bearings are of bronze and of the removable type.

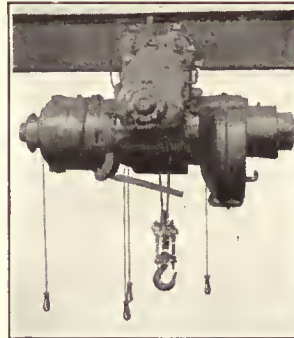

Electric Hoist with Geared Trolley.



Electric Hoist with Plain Trolley.

Hoists of similar design and of all capacities up to 7½ tons can be furnished to suspend from a geared trolley, operating along a runway. Both the hoist and the geared trolley are operated by pendant cords, reaching to a position where they can be controlled from the floor. Maris trolleys are also furnished driven by an electric motor and controlled in a similar manner.

Maris electric hoists are made for direct current standard at 115 and 230 voltage, and for alternating current at 110 and 220 volt, 3 phase, 60 cycle. Special voltage and cycles can be furnished as desired.

MARIS BROS., PHILADELPHIA

**Cranes
Trolleys
Hoists**

Into every modern system of material handling some forms of cranes, trolleys or hoists usually enter. A selection of the proper type of overhead transportation is important and

to insure economical handling it is equally important that the equipment be of the most modern design.

Hyatt Roller Bearings are essential parts of overhead handling equipment if real economy of power, lubricant, and maintenance are to be secured. By reducing friction and thereby reducing the power required to operate, by operating for long periods of time without additional lubricant and by standing up under the severest service conditions for years without appreciable wear, Hyatt Roller Bearings make cranes, trolleys and hoists economical and dependable.

Many manufacturers of overhead handling equipment are prepared to furnish Hyatt Roller Bearings either as standard on their equipment or when specified.

**Advantages
on Trolleys**

One man can quickly handle the heaviest loads on a Hyatt equipped trolley without fatigue because the bearings begin to revolve just as soon as he exerts any effort. A test shows that a

pull of 95 pounds was required to move a load of 4,000 pounds on a brass bearing trolley, where only 50 pounds was required to move the same load on a

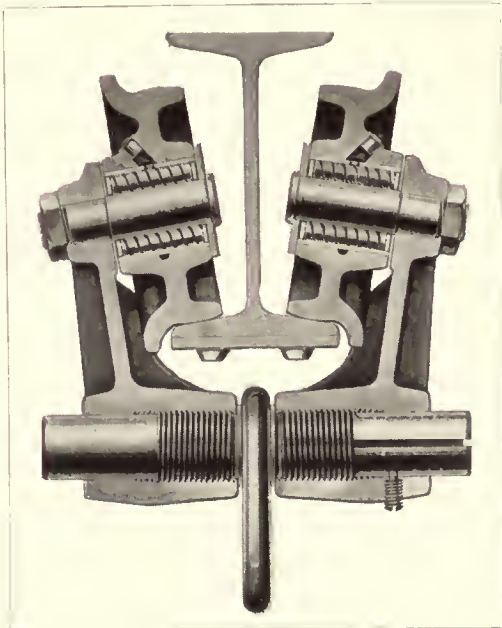

Hyatt equipped I-beam trolley manufactured by Curtis Pneumatic Machinery Company, St. Louis, Mo.

Curtis-Hyatt equipped trolley. On comparing a Hyatt equipped trolley with a plain cast iron bearing trolley the ratio was three to one in favor of the Hyatt trolley.

**Hyatt
Equipped
Hoists**

Electrically and hand operated hoists attain their highest efficiency when equipped with Hyatt Bearings. A test of Barber-Foster Hyatt equipped electric hoists showed that they

require 22% less power to operate at a speed 21% greater than similar hoists with ordinary bearings.

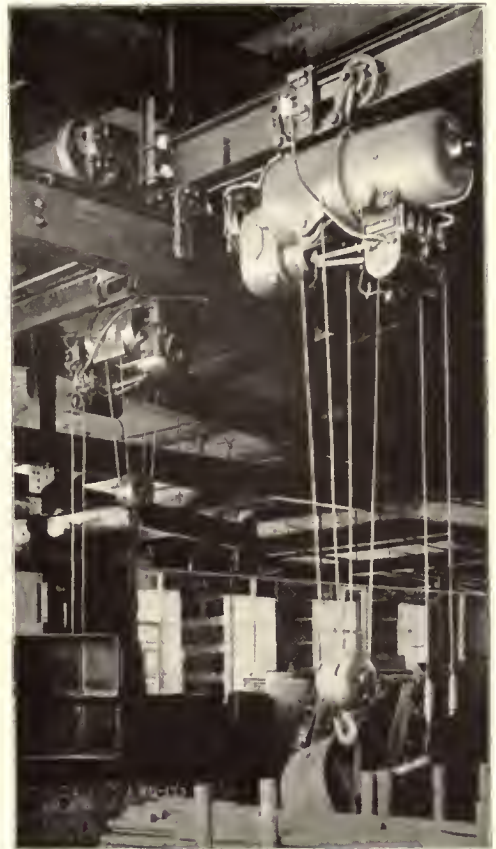

Hyatt equipped electric hoist and trolley manufactured by the Barber-Foster Engineering Company, Cleveland, Ohio

Thus a Hyatt equipped hoist is able to do the same work quicker and with less power with a smaller, lighter, and less costly motor than a plain bearing hoist.

**Cranes with
Hyatt
Bearings**

Cranes in ordinary every day use are subjected more than any other type of machinery to neglect and abuse. They are frequently overloaded and only in exceptional circumstances are they properly lubricated. Ordinary plain bearings will not stand up under such treatment for any length of time. A plain bearing crane is bound to be out of service more or less frequently for bearing repairs, often when it is most needed to speed up the work.

Because of their sturdy chrome vanadium steel rollers Hyatt Roller Bearings are capable of operating properly under the worst conditions of use and abuse, and therefore insure years of dependable crane service.

A recent test of two 10-ton bridge cranes, one equipped with plain bearings and the other with Hyatt Roller Bearings showed a power saving during acceleration of 22.1% and an average saving in power required at normal traveling speed of 48.5% in favor of the Hyatt equipped crane.

**Hyatt
Engineering
Service**

Our engineers are bearing specialists and are often able to present designs for the use of Hyatt Roller Bearings that are of real value to manufacturers and users of cranes, trolleys and hoists. Get in touch with us regarding any bearing problem without obligation.

SPRAGUE ELECTRIC HOISTS

**Suitable
for Unlimited
Uses**

The uses of Sprague Electric Hoists are unlimited. They have already been installed in foundries, machine shops, pressrooms, warehouses, abattoirs, power houses and all

kinds of factories, outside as well as indoors; they have seen service on the docks, in brick yards and mines, and in all places exposed to the elements. They have been used for handling bales of cotton, rolls of paper, safes, boilers, rails, ammunition, automobiles, and numerous other commodities.

The small electric hoist has become an important

work is brought to it and taken away from it. The use of a small electric hoist over each tool enables the

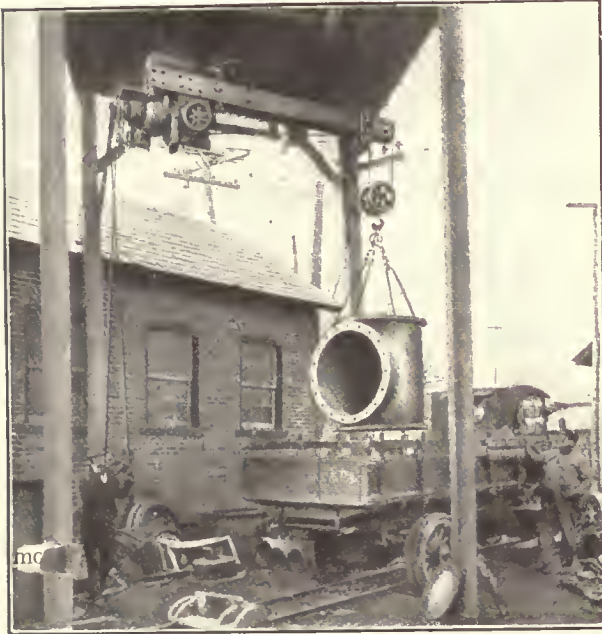

Type W Loading Pipe Tees

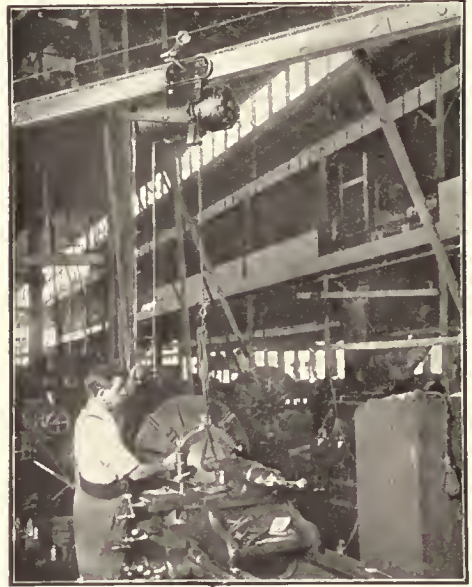

500 Pound Hoist in Machine Shop

operator to avoid all unnecessary delays, thus increasing the output of the tool.



Electric Hoist Cage Control

factor in the modern foundry equipment. For the successful handling of copes, cores and flasks in foundry work a very delicate speed regulation is required. The foundry hoists built by the Sprague Electric Works are equipped with special "Foundry" controllers which particularly adapts them to this class of work.

Sprague electric hoists are especially adapted to service in machine shops. The output of a machine tool is dependent upon the facility with which the

TABLE OF WEIGHTS AND CAPACITIES FOR TYPES W-1 AND W-2

Capacity Pounds	Speed Feet Per Min.	Max. Ht. of Lift Feet	No. of Tropes	Type of Hoist	Hoist Motor		Trolleys						Net Weights					
					Frame	H.P.	Plain		Hand-Geared		Motor-Driven		Motor		Hoist Only	Hoist With Plain Trolley	Hoist With Hand-Geared Trolley	Hoist With Motor-Driven Trolley
							Size I-Beam in Inches	Min. Radius of Curve in Feet	Size I-Beam in Inches	Min. Radius of Curve in Feet	Size I-Beam in Inches	Min. Radius of Curve in Feet	Frame	H.P.				
					DIRECT CURRENT HOISTS													
2000	20	40	2	W-1	M-1	3	8-15	8	8-15	8	10-15	8	M-1	2	540	800	870	1100
2000	40	40	2	W-1	M-2	6	8-15	8	8-15	8	10-15	8	M-1	2	660	920	990	1220
4000	10	20	4	W-1	M-1	3	8-15	8	8-15	8	10-15	8	M-1	2	590	850	920	1150
4000	20	20	4	W-1	M-2	6	8-15	8	8-15	8	10-15	8	M-1	2	710	970	1040	1270
3000	26	50	2	W-2	M-2	6	8-15	8	8-15	8	10-15	8	M-1	2	870	1140	1210	1610
4000	30	50	2	W-2	M-3	9	8-15	8	8-15	8	10-15	8	M-1	2	970	1240	1310	1710
6000	13	25	4	W-2	M-2	6	12-18	10	12-18	10	12-18	10	M-2	4	930	1200	1270	1700
8000	15	25	4	W-2	M-3	9	12-18	10	12-18	10	12-18	10	M-2	4	1030	1300	1370	1800
12000	10	16	6	W-2	M-3	9	---	---	15-18	10	15-18	8	M-3	6	1460	---	1960	2860

SPRAGUE ELECTRIC WORKS OF GENERAL ELECTRIC CO.

527-531 W. 34th St., NEW YORK, N. Y.

**Sprague
Electric
Monorail Hoists**

The Sprague Electric Works of the General Electric Company manufactures and markets through its own district sales organization the specialties described in the four following pages.

following pages.

Sprague electric hoists fill the gap between hand chain blocks and large three motor traveling cranes. They give from six to eight times the speed of hand chain hoists and their cost is only a small part of the cost of traveling cranes. They are built in a variety of styles, with floor or cage control, and with capacities varying from 1/4 to 6 tons.

**Type I-6
500 Pounds
Capacity**

The Sprague Electric Type I-6, 500 pound hoist is a light hoist which is primarily for use over tools such as lathes, planers, boring mills, etc.

It has a factor of safety throughout of not less than 5. An upper limit of the lever type is provided which automatically turns the

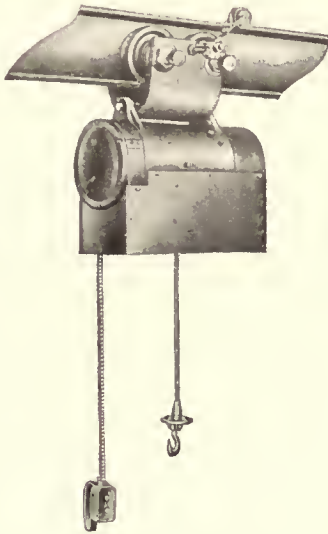

Type I-6

current "off" when the hook has reached its highest safe position.

RATING OF I-6 HOIST					
Capacity in Pounds	Speed in Ft. Per Min.	Lift in Ft.	Horse-Power of Hoist Motor	Max. No. of Lifts Per Hr.	Weight in Pounds
500	25	15	1	15	250

**Type S-1
One Half and One
Ton Capacities**

The Sprague Electric Type S-1 Hoist is a spur-gear hoist built to handle loads of one-half or one ton. Both sizes may be equipped with a trolley or if desired, the one-ton size

may be equipped with a top hook. The control may be either from the floor or from a cage.



Type S-1

Capacity in Pounds	Speed F.P.M.	Max. Ht. or Lift-Ft.	No. of Ropes	H.P. Rating	Weight Hoist Only	Wt. of Hoist & Trolley		
						Plain	Hand Geared	Motor Driven
1000	30	28	1	1.5	480	600	630	1015
2000	15	13	2	1.5	505	825	655	1040

**Type W
1-2-3-4-6 Ton
Capacities**

Sprague Electric Type W Hoists are worm-gear hoists, having lifting capacities from one to six tons.

These hoists are built to operate with direct or alternating current. The ratings and weights for D.C. hoists will be found in the table on the following page. The A.C. hoist ratings and weights are approximately the same.

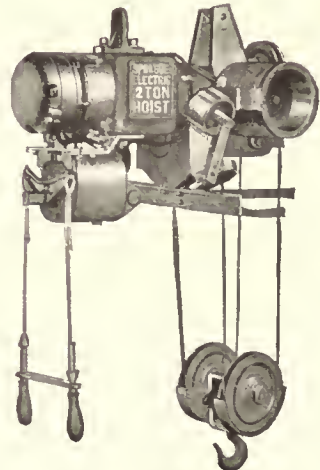

Type W

SPRAGUE ADJUSTABLE LOOP AND GRAB-BUCKET HOIST

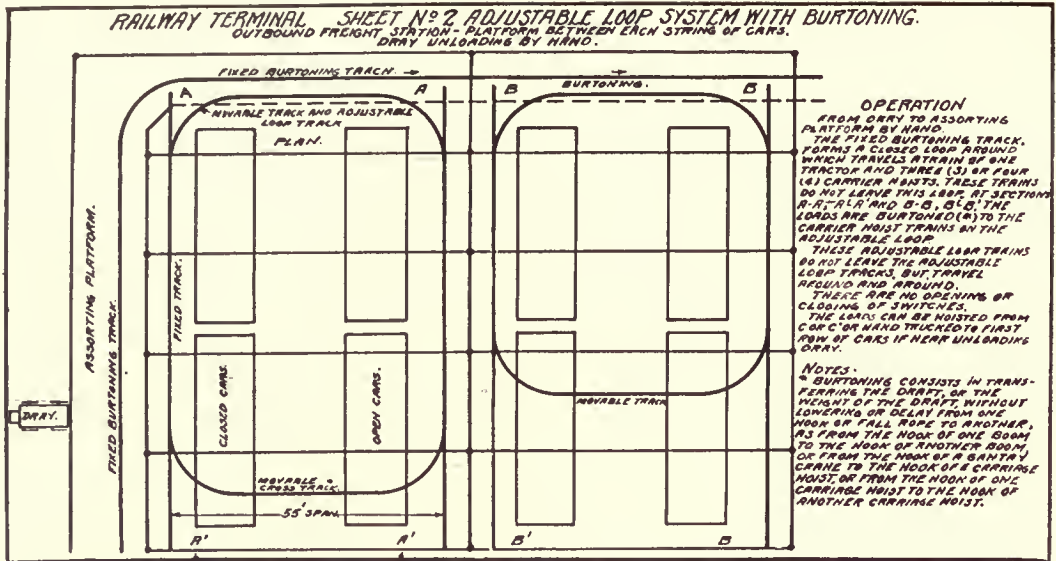

Railway Terminal with Inbound and Outbound Tracks and Two Overhead Adjustable Loop Systems for Movement of Goods Between Freight Cars and Platform.

Sprague Adjustable Loop System

The Sprague adjustable loop system is a movable section of track for overhead material handling machinery in terminal sheds. With this addition the overhead track takes the shape of a continuous unbroken loop which is adjustable in length.

For satisfactory operation in a terminal shed the overhead system must cover the middle area as efficiently as it does the sides and ends.

The Sprague adjustable loop system meets these requirements by providing a track consisting of two T-rails laid on I-beams running along either side of the shed and two sets of rails running across the shed on bridges. The rails on the bridges are curved in such a manner as to meet the side rails and form with

trol is from the cage. The Sprague electric patented control leaves nothing to the judgment of the operator. The hoisting controller is so constructed that the operations must follow one another in proper sequence as the operator turns the handle.

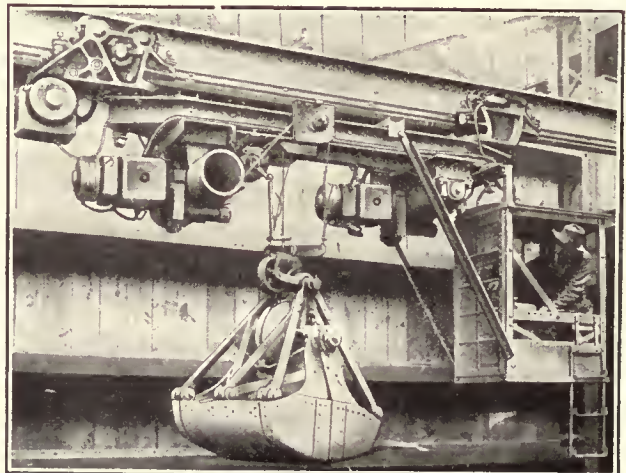

Grab-Bucket Hoist

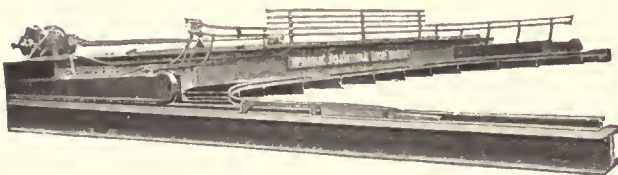

Adjustable Loop

them a continuous closed loop. The bridges which carry the cross tracks are capable of being moved back and forth by means of motors controlled by operators in the hoisting trains. By moving the bridges, the loop is made adjustable in length and the entire floor area is covered.

Sprague Monorail Grab-Bucket Hoists

Sprague Grab-Bucket Monorail Hoists may be had in two types G.B.-11 with a capacity of $\frac{1}{2}$ cu. yd., and G.B.-7 with a capacity of $\frac{3}{4}$ to $1\frac{5}{8}$ cu. yds. The buckets are operated by a lacing rope and two holding ropes. The motors are either alternating or direct current type, of high starting torque and mechanical strength. All con-

Performs All Handling Operations

Sprague Grab-Bucket Monorail Hoists were designed primarily to handle coal in manufacturing plants, but they are equally efficient when handling other bulk material, such as iron pyrites, sand, ashes and cement. The I-beam runway can be of any length and have as many switches as are required. A complete monorail system is capable of taking coal from a barge or car, and by the use of a single machine, delivering it to the furnace, making all the intermediate stops for storage, crushing and weighing and also be available for carrying out the ashes.

A table of capacities, weights and speeds follows:

SPRAGUE ELECTRIC WORKS OF GENERAL ELECTRIC CO.

527-531 W. 34th St., NEW YORK, N. Y.

SPRAGUE VERTICAL WINCH AND HORIZONTAL WINDING DRUM

TABLE OF RATING OF GRAB-BUCKET HOIST

Capacity	Net Weight in Lbs.						
	Machine With Empty Bucket	Empty Bucket	Coal	Shipping Wt. Complete Mach. With Empty Bucket	Lift Feet	Hoisting Speed Feet Per Minute	Traversing Speed Feet Per Minute
½ cu. yd.-----	*6600	2100	680	8500	50	100	350
¾ cu. yd.-----	12000	2500	1020	17000	50	150	350
1 cu. yd.-----	12200	2700	1350	17200	50	150	350
1½ cu. yd.-----	14000	3500	2030	20400	50	150	350
1¾ cu. yd.-----	14200	4600	2200	20600	50	150	350

* With enclosed cage.

Sprague Vertical Winch

The construction of the Sprague Vertical Winch is strong and simple. The motor is of the direct current, series wound or polyphase induction type and is geared to the winch

head through a triple reduction gearing. For pulling loads on level tracks a single speed controller of the cyl-



Vertical Winch Pulling Coal Barge

Lbs. Pull on Rope	H. P. A. C. Motor	H. P. D. C. Motor	Speed of Rope Feet Per Min.	Approximate Weight of Winch
12000	10	12	25	2600 Lbs.
6000	10	12	50	2600 Lbs.
4000	10	12	75	2600 Lbs.
3000	10	12	100	2600 Lbs.
2000	10	12	150	2600 Lbs.

inder type is used, which is operated by a foot lever, but where the track is on a grade a variable speed controller and a holding pawl are furnished. Both types of controller are retained in the running position by a pawl and star wheel, thus permitting the operator to use both hands on the rope.

These machines are designed for all kinds of hauling. They have been used with great success in spotting railroad cars, in helping teams up grades, for pulling heavy trucks into and out of shop, in drawing heavy articles

on and off drays, in warping vessels through draw-bridges and along docks, and for dragging heavy material along the ground.

Sprague Winding Drums

Sprague Winding Drums have a smooth flanged drum mounted horizontally and designed to exert a pull either horizontally, vertically or at any angle. The drum shaft is carried on pedestals attached to the same base frame as the motor and gear bearings, thus providing a simple

method of mounting. The drum shaft is carried on pedestals attached to the same base frame as the motor and gear bearings, thus providing a simple

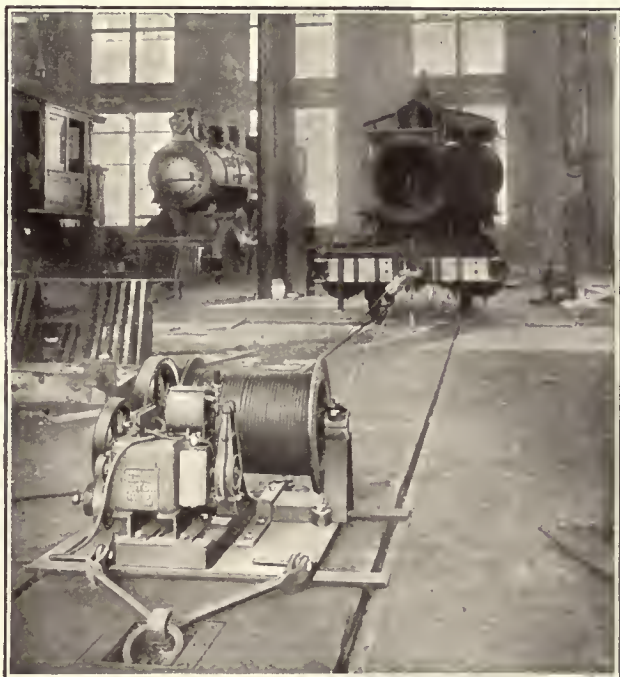

Winding Drum in Car Shed

but rigid construction. Either direct or alternating current motors, and single or variable speed controllers, can be furnished. Two types of machines are offered.

Type W-3 winding drum has one spur gear and one worm gear reduction, between the motor and the drum. The worm gear allows loads to be lowered without the addition of a load brake. However all machines have a service brake attached to the motor.

Type D-11 winding drum is similar to type W-3 except that it has spur gears only. Consequently a load brake is necessary if loads are to be lowered. The winding drum is built in larger capacities than the W-3 and is suitable for more severe service.

A table of loads, speeds and weights follows.

Lbs. Pull on Rope	H. P. A. C. Motor	H. P. D. C. Motor	Speed of Rope Feet Per Min.	Approximate Weight of Winch
1000	5	6	100	2200 Lbs.
2000	10	12	100	2200 Lbs.
3000	15	15	100	2200 Lbs.
4000	20	20	100	2200 Lbs.

SHEPARD ELECTRIC FLOOR CONTROL HOISTS

Floor Controlled Electric Hoists

To meet the various handling requirements of more than 70 industries many types and capacities of floor operated electric hoists have been developed.

Type 23 is a floor operated, foundry control, direct current, monorail hoist. It may have a two part single or two part double hoisting cable, and geared or motor driven trolley. For dimensions and capacities see the table below.

Type 2 X S is a floor operated, single speed, direct current, electric hoist with capacities ranging from 1/4 to 1 ton. It is built for operation by 110 and 220 volt current only. Dimensions and capacities are given in the table below.

Types 1 and 1X are floor operated foundry control, direct current, monorail hoists. It has 2, 3 and 4 parts and single drum driven trolleys. Type 1 has the winding drum mounted parallel to the direction of travel and on type 1X it is at right angles. Capacities and dimensions are given in the table below.

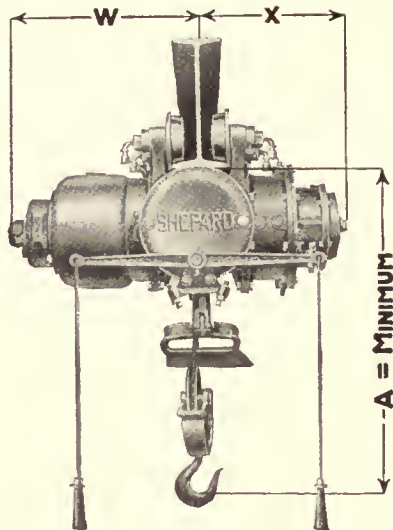

Form 2 X S Hoist.

CAPACITIES AND DIMENSIONS OF 2 X S HOISTS									
Class or frame size	Capacity tons	Hoisting speed, f.p.m.	No. of ropes	Height of lift.	Dimensions				Weight lbs.
					A	X	W	Extreme width	
H1 1/2	1/4	25	2	14'	2' 1"	1' 3"	1' 6"	2' 6"	520
H1	1/2	23	2	14'	2' 1"	1' 3"	1' 7"	2' 6"	520
I2	1	20	2	18'	2' 5 1/2"	1' 5"	1' 8"	2' 8"	580

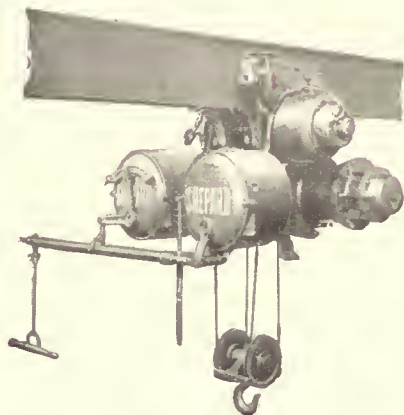

Form 23 Hoist with Motor Driven Trolley.

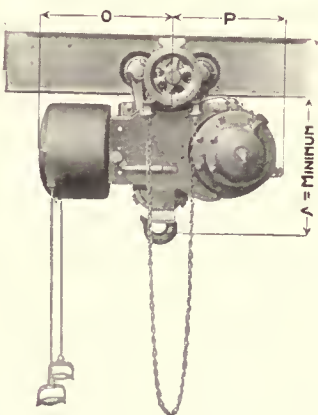

Form 23 Hoist with Geared Trolley.

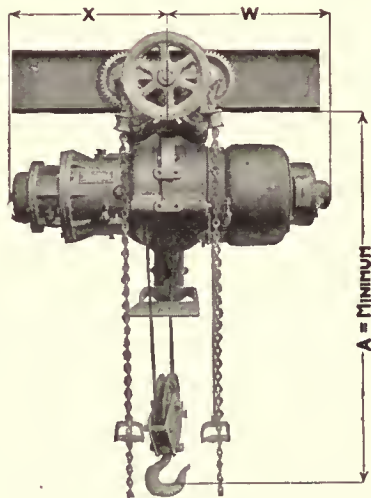

Form 1 Hoist with Geared Trolley

CAPACITIES AND DIMENSIONS									
Class or frame size	Capacity, tons	Hoisting speed, f.p.m.	No. of ropes	Height of lift	Dimensions				Weight, lbs.
					A	O	P	Extreme width	
A2	1/2, 1, 2	40, 20, 10	2	20'	2' 7"	1' 8 7/8"	1' 6 1/4"	3' 10"	1170
A4	1, 2, 3	40, 20, 13	2	20'	2' 7"	1' 8 7/8"	1' 6 1/4"	3' 10"	1220
B6	3, 4, 5	20, 15, 12	2	25'	3'	2' 4 3/4"	1' 11"	5' 4"	2470
B10	4, 5, 6	25, 20, 17	2	33'	3'	2' 8 3/4"	1' 11"	5' 4"	2770

CAPACITIES AND DIMENSIONS									
Class or frame size	Capacity, tons	Hoisting speed, f.p.m.	No. of ropes	Height of lift	Dimensions				Weight, lbs.
					A	X	W	Extreme width	
A2	1/2, 1, 2	40, 20, 10	2	20'	3' 4 1/2"	1' 9 3/4"	1' 7 1/4"	3' 1 1/2"	1090
A4	1, 2, 3	40, 20, 13	2	20'	3' 4 1/2"	1' 9 3/4"	1' 10"	3' 1 1/2"	1140
B6	3, 4, 5	20, 15, 12	2	22'	4' 2 1/2"	2' 5 7/8"	2' 1"	1' 11 1/2"	2350
B10	4, 5, 6	25, 20, 17	2	22'	4' 3 3/4"	2' 5 7/8"	2' 2 1/4"	2' 3 3/4"	2650
C12	5, 7 1/2, 10	26, 17, 13	2	23'	5' 5 3/4"	3' 2"	2' 5 3/4"	2' 6 1/4"	4220
C20	7 1/2, 10, 12 1/2, 30	24, 20, 2	2	23'	5' 5 3/4"	3' 2"	2' 7 3/4"	2' 6 1/4"	4470

SHEPARD ELECTRIC CRANE & HOIST CO.

MAIN OFFICE AND WORKS MONTAUR FALLS, N. Y.

SHEPARD BRACKET CRANES AND CAGE CONTROL HOISTS

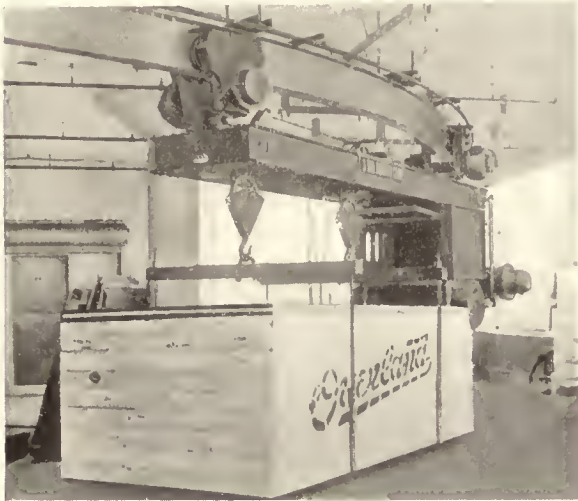

Form 18 Hoist.

Shepard Cage Control Hoists

The Shepard electric cage operated monorail hoist consists of an electric hoist and cage suspended from trolleys traveling a single I-beam and operated by electricity. It can be run in either direction at a wide range of speeds. The entire operation is controlled by the man in the cage.

Shepard Bracket Cranes

The bracket crane above is a simple, efficient apparatus for many foundry and machine shop locations, and ably assists the main crane. For transferring work from one job to another, and for jobs which tie up for long periods, this is a most profitable piece of apparatus.

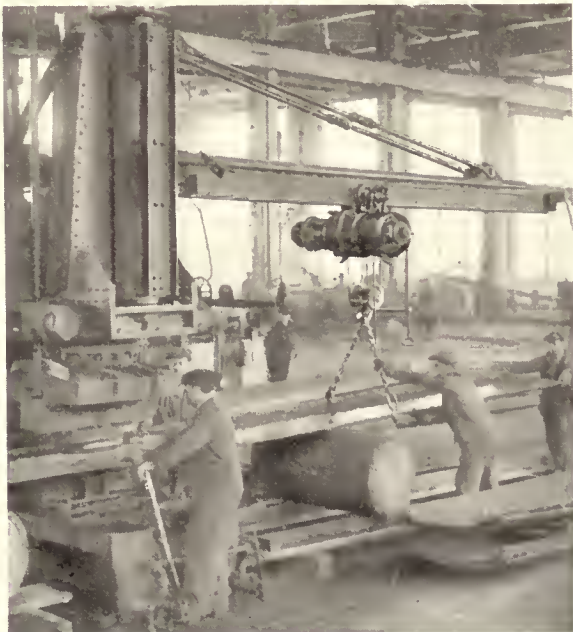

Bracket Crane with Form 1-X Hoist

Form 18, 1 to 6 Tons Capacity

The Shepard Form 18 hoist is equipped with two hooks which are operated from the same winding drum. The hoisting unit is at the back of the cage, the cables being conveyed over sheaves to the two hooks and fastened to the frame. The absence of hoisting apparatus in the lineal vision assures safety and ease of control. Both trolleys may be motor driven and pivoted to negotiate sharp curves.

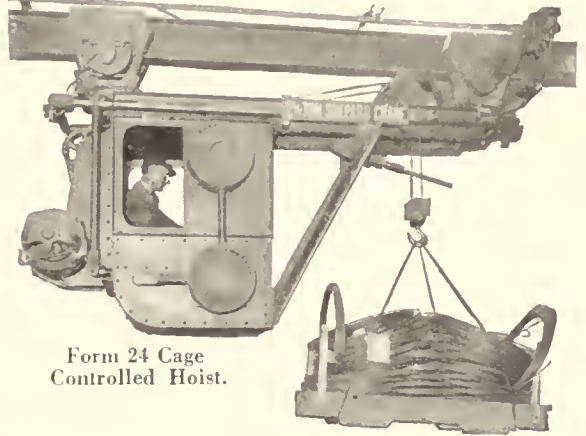

Form 24 Cage Controlled Hoist.

Form 24—½-6 Tons Capacity

The Shepard Form 24 hoist is of short over-all dimensions and is equipped with a single hook. The hoisting unit is mounted on the back of the cage, permitting a clear range of vision for the operator. Two parts of cable can be used. These pass over parallel sheaves on the hoisting frame and connect with the hook through a block, preventing all twisting or side swinging.

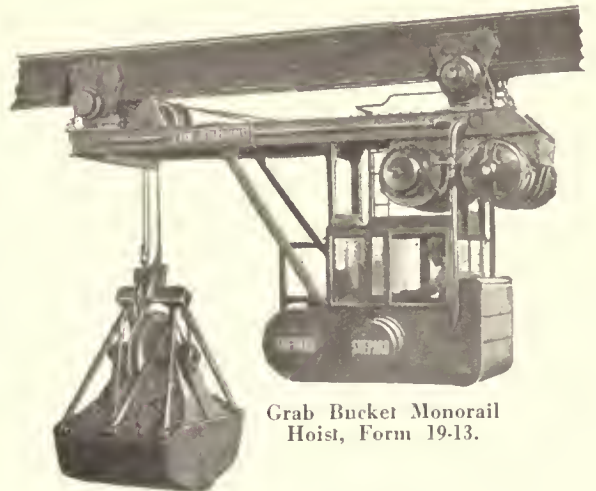

Grab Bucket Monorail Hoist, Form 19-13.

Form 19-13 Grab-Bucket Hoist

In the Shepard Form 19-13 grab-bucket hoist two hoisting units are provided: One to close the bucket and the other to hold it. These are mounted close to the under side of the hoist frame, thus permitting a clear line of vision for the operator.

SHEPARD ELECTRIC CRANE & HOIST CO.

MAIN OFFICE AND WORKS MONTGOMERY FALLS, N. Y.

SHEPARD CAGE CONTROL HOISTS AND WINCHES

Form 25 Cage Control Hoist

By the simple addition of a trailer cage, in which are placed the controllers, any Shepard monorail hoist equipped with a motor driven trolley, is easily converted into a cage controlled hoist. This equipment is recommended for normal duty. The hoist can be supplied with the winding drum placed either at right angles to or parallel with the line of travel.

The following is one example of the saving that can be accomplished by this method of handling material. Large lumber yard using Shepard hoists cut cost of unloading lumber \$20.00 a car or \$30,000 a year, and pile and handle lumber in yard at a 50 per cent saving.

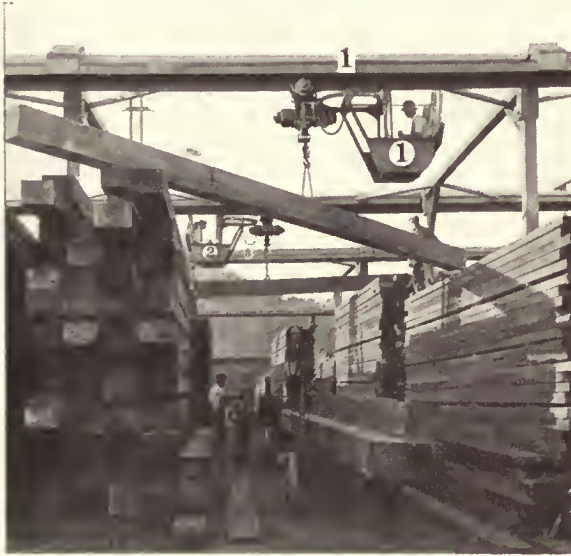

Form 25 Hoist Handling Heavy Timbers.

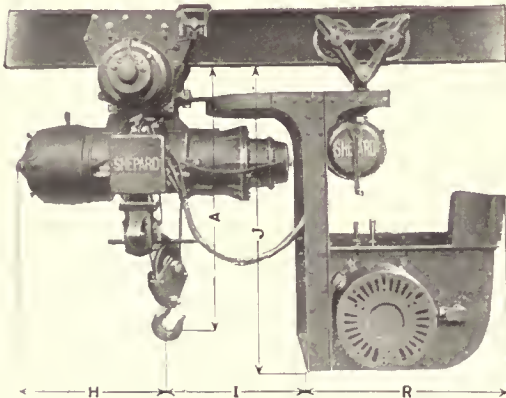

Form 25-1 D. C. Monorail Hoist.

CAPACITIES AND DIMENSIONS												
Class or frame, size	Capacity, tons	Hoisting speed, f.p.m.	Trolley speed, f.p.m.	Height of lift	No. of ropes	Dimensions					Weight, lbs.	
						A	J	H	I	R		Extreme width
A2	1/2	2, 40, 20, 10	225, 35'	20'	2	7 8 1/2"	7"	1' 5 1/4"	7 2 1/2"	7"	26"	2580
B6	3	5, 20, 15, 12	225, 35'	22'	2	4' 8 1/2"	5' 6"	11 1/4"	3' 3"	3' 6"	3'	4550
C12	5	11, 26, 17, 13	225, 35'	23'	2	5' 11 1/2"	7"	3' 2 1/2"	4' 3"	3' 9"	3'	7580

Electric Cargo and Back Geared Winches

Because of its closed-in construction on electric cargo winch is especially desirable for use on ships and piers. As shown in the illustration, the pier winches are mounted on wheels to make them portable. They can be furnished for direct or alternating current.

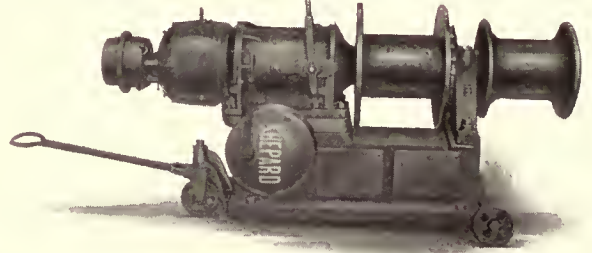

Electric Cargo Winch.

The electric back geared winch shown below is a compact weatherproof winch, with running parts completely enclosed. Its uses in and about industrial plants are manifold.

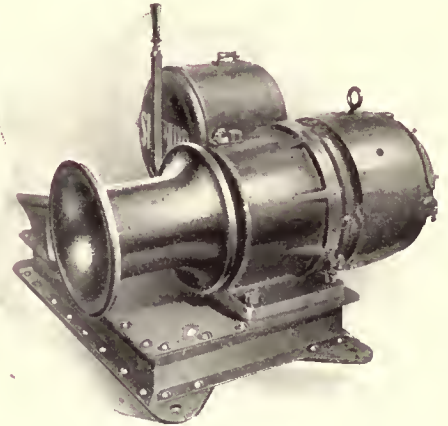

Electric Back Geared Winch.

Class or frame, size	Pull on single line, lbs.	Speed of overhaul, f.p.m.	Proper size manila rope	Shipping wgt., lbs	
				With base	Without base
A4	800	125	7/8"	820	650
B10	1800	140	1 1/4"	1890	1630
C20	3500	140	1 5/8"	3300	3010

Shepard Double Monorail Track

T-rails may be provided for the hoist to run upon, thus giving a hard steel wearing surface, rather than the soft steel of which I-beams are made.

The track is attached to the I-beams by means of bolts and spreader castings which make it unnecessary to drill the beam for the reception of this track. It also permits of using larger area bearings in the trolley wheels, thus insuring greater durability and longer life.



SHEPARD ELECTRIC CRANE & HOIST CO.

MAIN OFFICE AND WORKS MONTAUR FALLS, N. Y.

SHEPARD OVERHEAD TRAVELING CRANES

Overhead Traveling Cranes

The original Shepard crane design has proved so satisfactory that, during their 17 years of crane manufacture, no fundamental changes have been made.

This design, when introduced, was entirely unique in its provision for dirt exclusion, thorough automatic lubrication and permanence of alignment. All this is

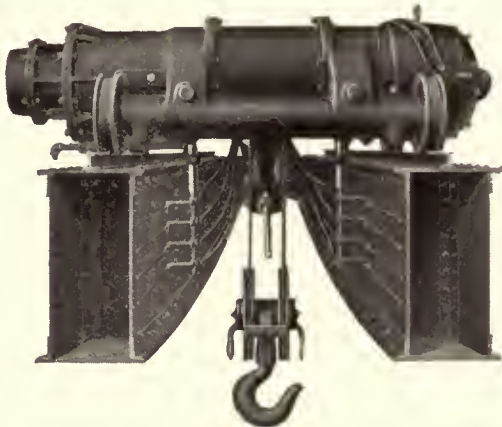

Standard Type Crane Trolley.

secured by locating the steel gearing and multiple disc type brakes within cylindrical frames. By this means not only the working parts but the operators and the workmen are completely protected.

The Shepard Electric Crane and Hoist Company specializes on fully developed cranes of the highest quality in capacities of from 1 to 50 tons. The one ton capacity is as complete in every detail as any heavier crane, proving that groups of small units can be handled as profitably as heavy single units.



Cage-Controlled Crane

Single I-Beam Crane with Hoist

Shepard single I-beam cranes with latticed outrigger construction combine double girder rigidity with single I-beam lightness. These cranes are widely used over foundry and machine shop side floors for capacities of 1 to 5 tons, and for medium and short spans.

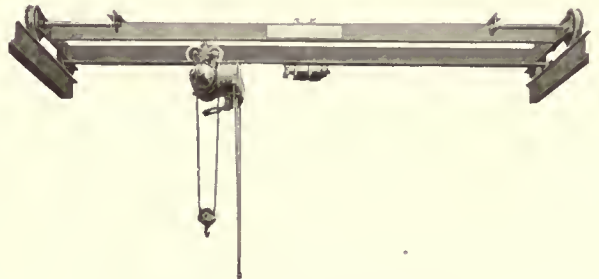

Single I-Beam with Form IX Hoist.

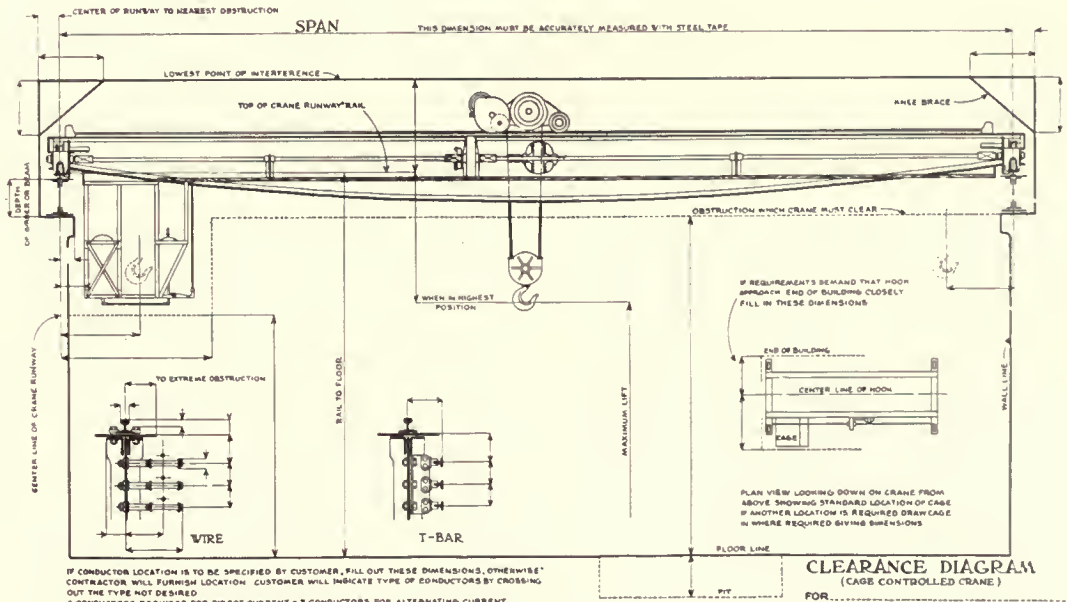

Clearance Diagram of Cage-Controlled Crane.

Time may be saved in making quotations if the above indicated dimensions are given, together with available electric current (voltage), phase and cycles if alternating.

SHEPARD ELECTRIC CRANE & HOIST CO.
 MAIN OFFICE AND WORKS MONTAUR FALLS, N. Y.

CLEVELAND ELECTRIC TRAMRAIL

Trucking on the ceiling with the Cleveland Electric Tramrail.

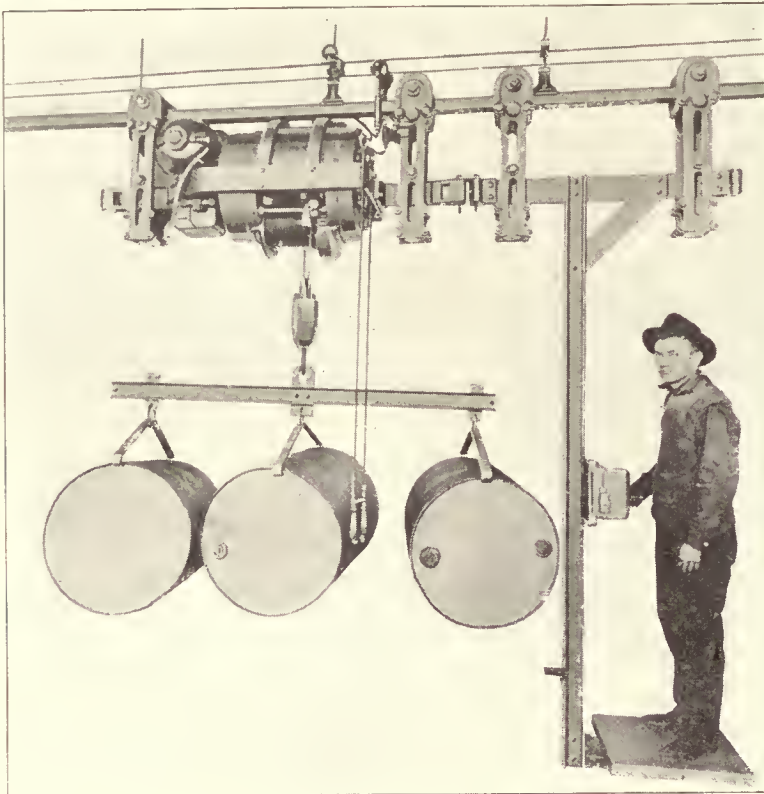

The Cleveland Electric Tramrail keeps the floor clean.

"Versatility" is its middle name.

Who It Was Made For

Have you hoisting and conveying problems that for their effective solution require an equipment so flexible that to all appearances it is invisible (because being out of the way you see it only when you are working with it) and yet capable of reaching into every corner of your plant?

You are the man for whom we built the tramrail. In the car foundry it carries the ladle of hot iron,

direct from the cupola, and empties it into the mold without further handlings. In the brass foundry, by its use, the operator empties the brass into the ladle while keeping out of reach of the heat and fumes. Whether it be stock room, pipe mill, drop-forge plant, warehouse, there is a Cleveland Tramrail that will prove the means of eliminating manual labor and remove the disagreeable from manufacturing.

Installed Like a Pipe Line

The Cleveland is an engineering accomplishment. In fact, so simple—yet rugged—is this latest achievement of our engineering department that it is actually installed with no more effort and no more skilled labor than is required in the installation of an ordinary pipe line. The complete track assembly is but a combination of rails, fittings and carriers maintained in stock at all times.

How do you like the idea?
Ask us to tell you more about it.

An Engineering Service Without Cost!

The men who designed and perfected the Cleveland are expert transportation engineers. We offer you their services without cost.

Allow us to arrange for one of them to call and study your problem, draw up blueprints, and then make their recommendations.

It will not obligate you in the least.

At any event, ask for our latest book on the Tramrail. It's free to the readers of this Cyclopedia.

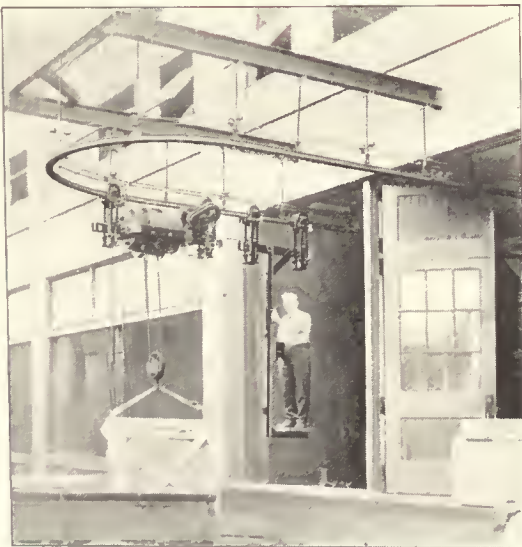

Installed Like a Pipe Line.

CLEVELAND ELECTRIC TRAMRAIL DIVISION OF
THE CLEVELAND CRANE & ENGINEERING CO.

WICKLIFFE, OHIO (Near Cleveland)



10-Ton Crane Lifting Fertilizer.



10-Ton Crane in Foundry.

Cranes Equipped With Buckets

Bucket Cranes, $\frac{1}{2}$ yard to 6 yards capacity, for handling coal, coke, ashes, slag, lime, cement, crushed rock, fertilizer or any material that can be handled with a shovel.

This Crane with a 4 yard bucket handles fertilizer materials at the rate of 150 tons per hour.

Single Leg Gantry Cranes

Single Leg Gantry Yard Cranes save a runway and provide additional storage space without the cost of a new building.

These cranes are also built with two legs, with and without cantilevers.



20-Ton Crane in Yard. 1 Leg Gantry.

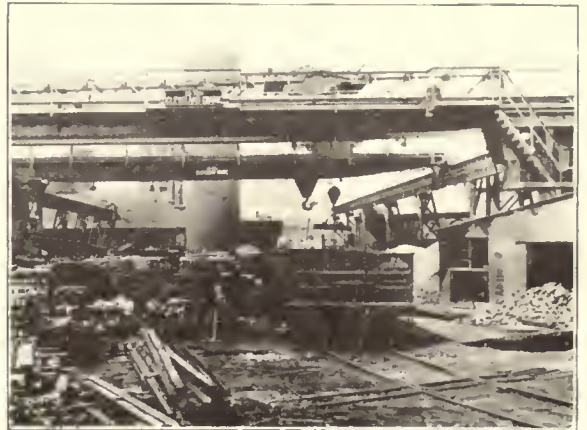

10-Ton Crane in Yard Unloading Freight Car.

Cranes for Foundries and Machine Shops

Cranes for Foundries and Machine Shops for quickly handling and setting flasks; shaking out molds; pouring hot metal and transferring material to and from machines, saving

the time of men and machines.

Cranes Equipped With Magnets

Cranes with magnets for handling steel, castings, scrap borings and turnings, etc., or miscellaneous material about the yard with the standard hook.

The installation of this type of Crane dispenses with the services of a great many laborers.

Sizes and Capacities

Cranes in all types and sizes from 250 pounds to 500 tons for industries of all descriptions are the product of this firm that has as many as twenty-five installations in a single plant. For

when a Cleveland is once installed, the service rendered is of such a high order that none but a Cleveland is good enough thereafter.

Cleveland Service

Cleveland Cranes are adapted for inside and outside service, and so efficient and economical is the service rendered by them that freedom from the losses that follow slow and wasteful handling is the natural result. Your crane problems when submitted to our engineers will receive the personal attention of men who understand how to forestall the worries of improper installations.

THE CLEVELAND CRANE & ENGINEERING COMPANY

New York Office
50 Church St.

WICKLIFFE, OHIO

Pittsburgh Office
First Nat'l Bank Bldg.



P & H 15-ton crane with 3-ton auxiliary. Chain Belt Co., Milwaukee.

**P & H Cranes
and Hoists**

The outstanding feature of P & H Electric Traveling Cranes and Hoists is the service provided. The extreme accuracy of all fits, the cut steel gears, the quiet operation, the enclosed motors, and the extra precaution in straightening all steel plates are mechanical features.

In details, the important features of P & H cranes are: Accessibility of all parts; each shaft lifting out independently; durability obtained by liberal design; no overhung gears or pinions; all trolley bearings bronzed bushed; M.C.B. type bearings on both trolley and bridge; through bolts throughout and all gears running in oil tight cases.

Further, P & H cranes have drums and running sheaves of not less than thirty times the diameter of the rope; dynamic brakes for D.C. cranes; motor and bridge brakes of heavy clam shell type.

New safety crane cabs have also been recently developed that have all electric control parts and wiring connections enclosed in steel cabinets. Operating levers placed at the front of the cab give complete control and allow the operator to have a clear view of the hook and space below.

Cranes for every industry, for indoor and outdoor service are made, standard capacities ranging from one to 150 tons.

Hoists and Monorail Conveying Systems for all kinds of material handling are also included in the standard P & H line.

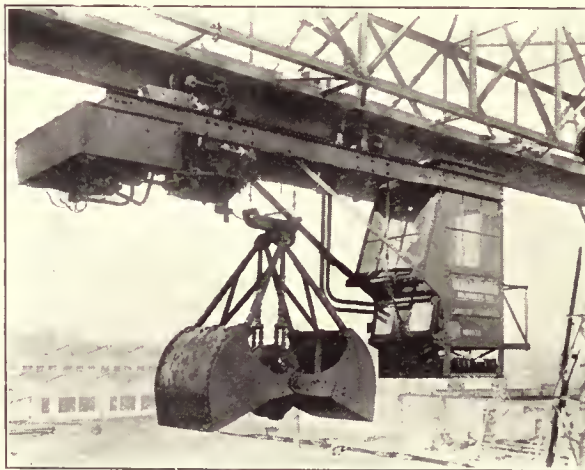

P & H Hoist.



P & H 10-ton single leg double traveling gantry crane handling structural steel material.

PAWLING & HARNISCHFEGER CO.
MILWAUKEE, WIS.



Two Chesapeake Electric Traveling Cranes Operating in a Railroad Yard.

Chesapeake Cranes

The Chesapeake Crane is an electrically operated overhead traveling crane, built for service either on alternating or direct current power circuits. It is equally efficient for all types of service from heavy, rough duty in rolling mills, to the most delicate operation in setting cores in the foundry.

These cranes range in capacity from 1 to 35 tons and are built for any span.

Construction

Chesapeake Cranes are of the most rugged construction throughout. Every care has been taken to make this crane a "Safety First" crane. The proper distribution of material in the strained parts and the liberality of surfaces in wearing parts insure strength, long life and low cost of maintenance.

All parts are standardized as far as possible. This not only improves the design and construction but also facilitates quick shipment.

Alternating Current cranes are equipped with an electric brake and a mechanical Load Brake.

Direct current cranes usually are equipped with electric brake only but can be also equipped with load brake in addition to electric brake if so desired.

The Electric Brake, which is of the iron-clad solenoid band type, is fully capable of holding the full load. The brake is always "on" when the hoist motor is not running, and is entirely released when the motor is running in either direction.

The Mechanical Load Brake, which is of the multiple disc type, has ample capacity to sustain the full load, without the use of the electric brake. It will not allow the load to run down, except when operated in the lowering direction by the hoist motor.

The Chesapeake Trolley is built to meet the most exacting requirements of heavy duty crane service. The framing consists of two heavy cast channel section side frames, rigidly connected by a heavy structural

steel girt which supports the hoist motor, brakes, and upper hoist sheaves. All gears and pinions are of steel with teeth cut from solid stock, and are either fully enclosed or are suitably guarded.

Chesapeake Service

Large quantities of standardized crane parts are carried in stock and are always ready for immediate shipment. This relieves the crane user of the trouble and expense of carrying a large stock of repair parts.

The services of a competent corps of engineers are always available to aid the prospective crane user in the solution of material handling problems.

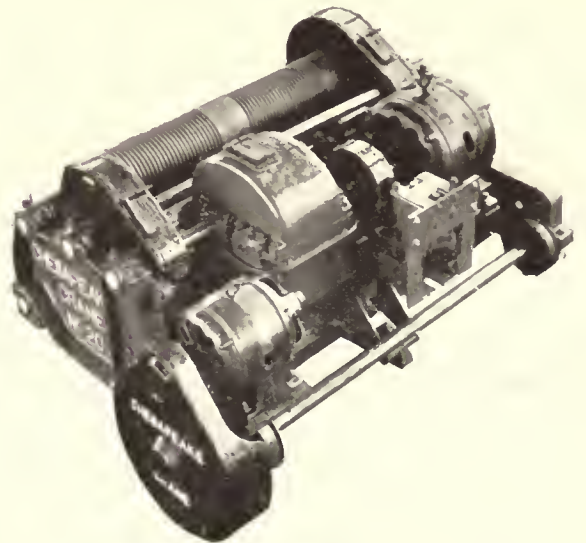

Two-Motor Trolley—With Load Brake

The company also fabricates and erects steel structures of all descriptions, including bridges and does general machine work.

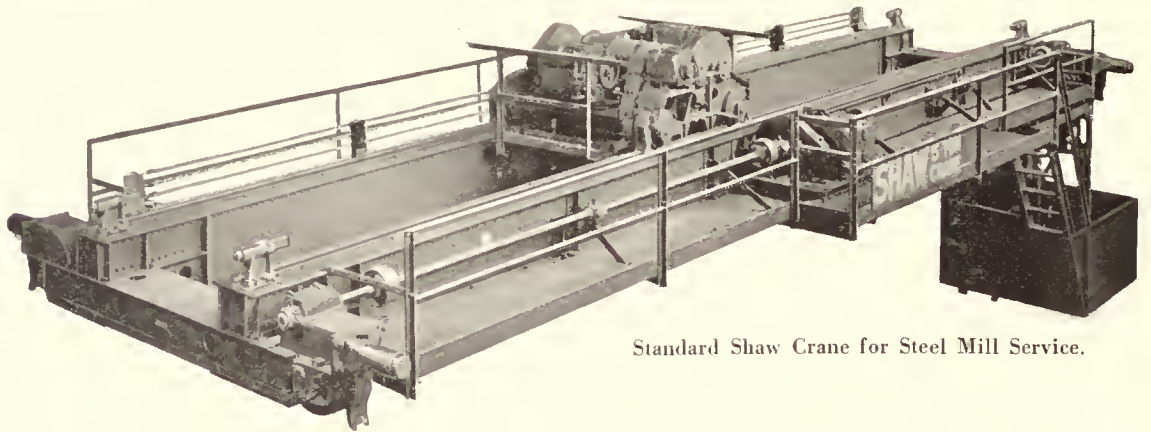

Standard Shaw Crane for Steel Mill Service.

The Primary Factors in Crane Selection

In purchasing an electric traveling crane, two factors primarily are to be considered. First is the design and construction of the crane itself and second, and equally important, is the application of the crane to the requirements of the installation.

For example, consider the requirements and the responsibility of a crane for foundry service. For the handling and pouring of molten metal the crane must be, above all, sturdy and reliable; safety demands these qualities. Yet the same crane must have the steadiness and the delicacy of control, required for lifting copes and drawing large patterns from the sand.

So in the forge shop, the steel mill, the locomotive shop—in every installation—there is a specific combination of qualities which must be built into the crane to assure the maximum degree of satisfactory service.

Adapting Every Shaw Crane to Its Work

Every Shaw Crane installation is an individual project and an engineering service backed by 30 years' experience is applied to the adaptation of each Shaw Crane to the type of service in which it is to work.



The Shaw Crane Works was established in 1890 and Shaw, in fact, built the first three-motor electric traveling crane, with a separate motor and individual control for each motion. While practically all of the early Shaw Cranes, built 20 to 30 years ago, are still in regular service, this fact is cited chiefly as evidence of the sound basis from which the present-day Shaw Crane, through many years of experience, has been developed.

The Range of Shaw Bridge Cranes

Shaw Bridge Cranes have been installed for indoor and outdoor service; in railroad shops and yards, in round houses, in shipyards, in quarries, in steel mills, in foundries, in cement mills and in practically every type of industrial plant. And it is this range of experience in adapting Shaw Cranes to the widest diversity of uses, which injects an exceptional "factor of safety" into the purchase of a Shaw Crane.

The capacities of Shaw Cranes range from two tons to 250 tons, with spans up to 100 feet or more. They can be supplied with single lift or with main hoist and a fast auxiliary hoist for light loads, or with double-lift for handling pipe or structural shapes, or with two independent trolleys—as required for the service.



60 Ton Shaw Crane in Foundry.

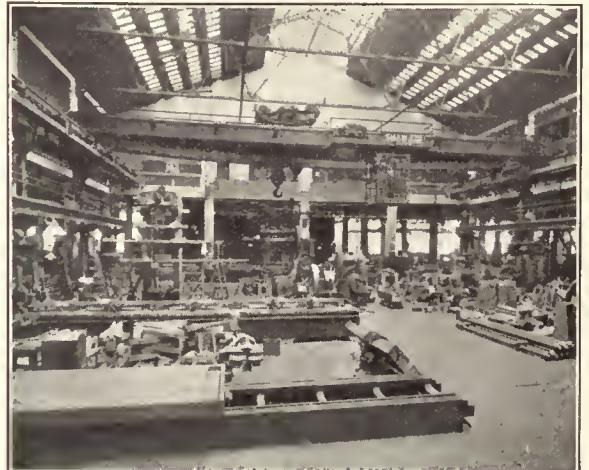

30 Ton Shaw Crane in Machine Shop.

MANNING, MAXWELL & MOORE, INC.

NEW YORK

SHAW CRANES

For special conditions, features of construction for improving the service rendered are frequently incorporated. For instance, in the case of a crane for grab-bucket service, it is sometimes advantageous to attach the operating cage to the trolley so that the operator may more directly observe the operation of the bucket.

So, in every Shaw Crane installation, the conditions of operation are given full consideration in developing the utmost of service.



30 Ton Shaw Yard Crane Outside of Shop.



Shaw Wall Crane in Machine Shop.

Shaw Wall Cranes

The illustration above shows a Shaw Wall Crane serving a row of tools in a machine shop. In a case like this, where the overhead traveling cranes are busy all the time, the wall crane

—operating on an entirely separate runway—affords an independent local service along the side of the shop. The wall crane is especially well adapted for serving planers, boring mills or similar tools doing heavy work and requiring a more localized crane service than it would be practicable to furnish with the main overhead shop cranes.



Shaw Wharf Crane Loading Barges.

Shaw Wharf Cranes

The illustration above shows a type of wharf crane designed for transferring canal-barge cargo with a maximum of ease and despatch.

The crane travels on tracks carried above the roof of the shed. The boom in working position stands with the outer end projecting over the boat and the inner end extending into the shed. When the crane is not in service, the boom can be raised to a nearly vertical position, allowing free travel from one end of the pier to the other.

This construction permits the carrying of freight to and fro between the hold and the inside of the shed at a single handling. It carries the freight in a straight line and avoids moving a great mass of structural work or machinery whenever a draft of freight is transferred.

Detailed information on the application of this type of crane to any specific pier will be supplied on request.

Estimates and Preliminary Information

Descriptive bulletins covering the design and construction of Shaw Cranes will be sent on request. Preliminary cost estimates, clearance diagrams or any other desired information regarding the proper crane for any specific service, will be supplied without obligation.



Shaw Wharf Gantry Crane.

MAIN OFFICE:—119 West 40th St., New York, N. Y.

DISTRICT SALES OFFICES:—Chicago, Philadelphia, Boston, St. Louis, Pittsburgh, Cleveland, New Haven, Cincinnati, Buffalo, Syracuse, Detroit, Milwaukee, San Francisco, Seattle

MANNING, MAXWELL & MOORE, INC.

NEW YORK

LABRIDE BRIDGES FOR HANDLING COAL, SAND, ETC.

Products

The Lakeside Bridge & Steel Co. are prepared to design, fabricate and erect LABRIDE Bridges for handling Coal, Coke, Ore, Sand, Limestone, etc., Steel Buildings, Coal Tip-ple, Monorails, Jib Cranes, Whirleys, Wharf Cranes, Cargo Conveyors, etc.



LABRIDE Bridge for Retail Yard.

Handling Coal With One Man

The "LABRIDE Coal Bridge" is a Gantry Type Crane operated by one man. Moving under its own power it completely covers the entire yard, and is the ideal equipment for the Retail Coal Yard. Capacity varies from 30 to 100 tons per hour. Cost from \$10,000 to \$35,000, erected complete.

The fact that it is a one man type, permits the handling of coal from the car to the pile or from pile to the truck at a very low cost per ton. A LABRIDE operator need not necessarily be a skilled mechanic. This, in itself, allows such a range for selecting operators, that labor troubles are minimized.

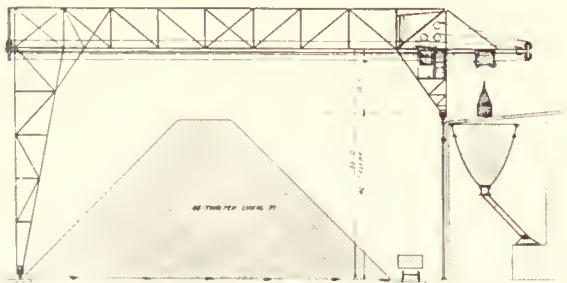

Typical Power Plant Installation.

Eliminating Conveying Machinery in the Boiler Room

To eliminate all conveying machinery in the boiler room of Power Plants and reduce the handling cost to a very low mark, numerous "LABRIDE Bridges" have been installed. For this purpose one leg of the bridge runs on the ground rail, the other either on the ground or on an

overhead girder adjacent to the wall. The bridge has an extension which reaches over the bunkers. At a rate of 100 tons per hour, this bridge will not only unload cars to pile, but at the same rate will move the coal from the pile to the fireroom hopper. Under ordinary conditions one man can operate a "LABRIDE Bridge" to keep the hoppers full of coal at all times.



LABRIDE Bridge for Power Plants.

Material Handling Capacities

The working capacity of the "LABRIDE Bridge" depends upon the size of the bucket, the material to be handled, and the travel. "LABRIDE Bridges" have been installed with capacities from 30 to 350 tons per hour, the larger amounts being used in Dock installations where it is necessary to move 8,000 tons in less than 36 hours or pay demurrage.

A "LABRIDE Bridge" of 100 tons capacity can unload a coal car in thirty minutes and load a truck in two minutes.



Bucket With Auxiliary Hook.

Where the nature of the material handled requires rather frequent use of a hook with a sling or a lifting magnet, at a small additional cost an extra drum may be installed. The use of a lifting magnet is very economical in handling metal scrap, etc.

LAKESIDE BRIDGE & STEEL CO.
407 VILLARD AVE., NORTH MILWAUKEE, WIS.

LABRIDE BRIDGES FOR HANDLING COAL, SAND, ETC.

Range of Operations

In supply yards, retail coal yards, docks, power plants, mills, factories, etc., the "LABRIDE Bridge" has proved its economical value.

In supply yards, handling stone, sand, gravel or other building materials from boat or car to stock pile or truck, the "LABRIDE Bridge" minimizes the labor question and avoids de-

boat, and by means of the "LABRIDE Bridge" unloaded to the storage pile. This same "LABRIDE" then moves the coal to a hopper for loading trucks. To get the greatest amount of storage as in this particular case, one leg runs upon an elevated track.

The results of this installation have been to double the capacity of the yard and reduce the men required to two or three.

The cost saving is evident.

One "LABRIDE" is so successful at the dock of the United Coal and Dock Company at Milwaukee, Wis., that the Lakeside Bridge & Steel Co. are now installing a second one. An independent screening plant has been erected which can be used by either bridge.

The new Johns-Manville plant at Waukegan, Ill., is using a "LABRIDE Bridge" in connection with their power plant.



LABRIDE equipped with extra drum and hook. Handles both coal and steel.

murrage on cars or boats. A "LABRIDE Bridge" acts in the same capacity in retail coal yards, moreover it eliminates the erection of costly elevated car runs, overhead bins or silos, an alternate to overcoming the labor question in coal yards.

About mills and factories, "LABRIDE Bridges" are used to unload cars or boats of coal or other materials and to make stock piles of the same, also to rehandle the material in the stock piles, in power plants, direct to the fire-room hopper.

What Some "LABRIDE Bridges" Are Doing

At their retail yard at Milwaukee, the Callaway Fuel Co. use a "LABRIDE Bridge" with a three ton bucket having an unloading capacity of 250 to 300 tons per hour. Since in

this yard there is no siding, all coal is brought in by

Cargo Conveyors for Wharfs

Thirty-two LABRIDE Portable Conveyors were furnished the United States Government for use at the Supply Bases in Philadelphia and Charleston.

Their lengths were 30 and 60 feet. The conveyors will stack boxes, bales of cotton, bags, etc., up to thirty-five feet and utilize the entire capacity of the warehouse. The Lakeside Bridge & Steel Co. specializes in conveyors of this length which are especially adapted to wharfs, and do not manufacture the small portable conveyors.

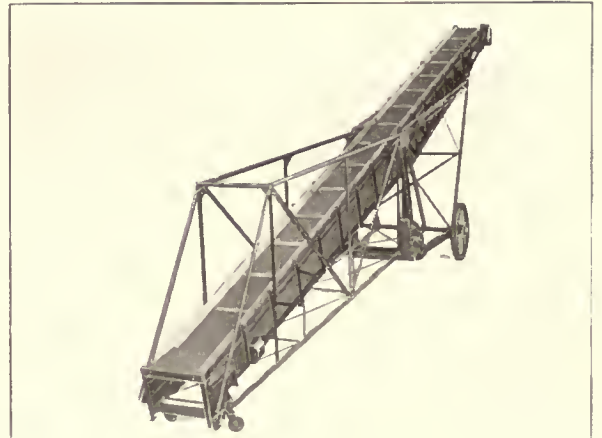

Sixty-Foot Conveyor.

A Lakeside Engineer at Your Service

If you will send to the Lakeside Bridge & Steel Co. a general outline of your yard, accompanied by a statement of the nature and amount of material you must move an hour;

also the voltage and whether alternating or direct current, they will submit an accurate proposition to you.

For this purpose the Lakeside Bridge & Steel Co. maintain a corp of engineers and specialists. It is their object to solve your storage and rehandling problem by adapting "LABRIDE Bridges" to your yard and their services are at the disposal of prospective purchasers without charge. In some cases a LABRIDE Bridge is not adaptable, and the Lakeside Bridge & Steel Co. will install other ways of handling your materials.

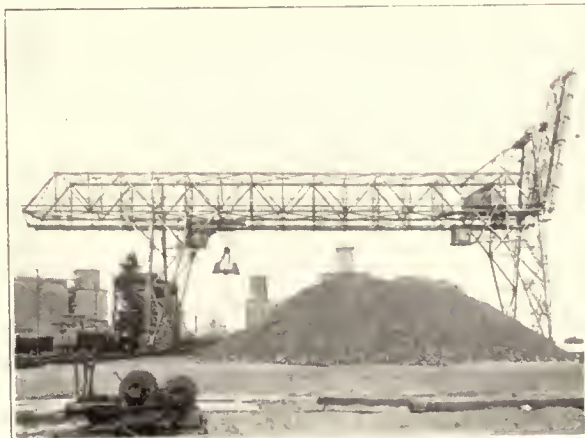

LABRIDE Bridge Installed at a Dock on the Great Lakes.

LAKESIDE BRIDGE & STEEL CO.

407 VILLARD AVE., NORTH MILWAUKEE, WIS.

NORTHERN CRANES AND HOISTS

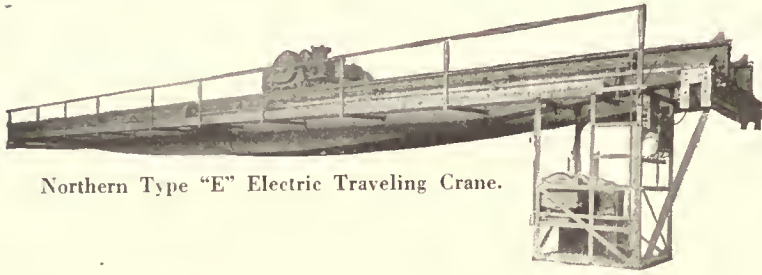

Northern Type "E" Electric Traveling Crane.

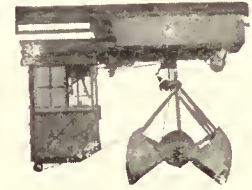

Grab-Bucket Mono-Rail Hoist.

Northern Type E Electric Traveling Cranes

This crane is designed as a general standard service crane and has all modern features of safety and efficiency, using a heavy substantial trolley; all steel gearing cut; mechanical and electrical brakes or dynamic brake; automatic limit stop; all gearing enclosed for bath lubrication; bronze bearings; no gearing overhung. It is made for either alternating or direct current and in capacities from 1 ton to 150 tons.

Made for plain control or variable speed control, as desired. The type D is for single hook suspension and type DQ for rigid two point suspension. Type DQV has grooved drum—the other types have spool drum.

Northern Grab Bucket Mono Rail Hoists

This hoist is made in several forms for either single or multiple line bucket and for either moderate or high speed current. The usual capacities run from one-half cubic yard bucket to 2 cubic yard bucket and it can be made in either the 2, 3 or 4 motor form depending upon service and speeds. Estimates furnished on receipt of particulars giving full conditions of service and character of material to be handled.

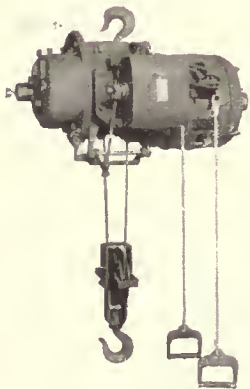

"Type D"

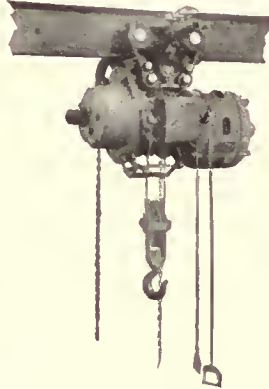

"Type DQ"

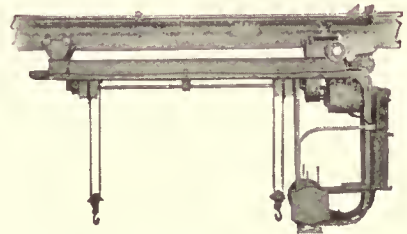

Special P-L Double-Hook Cab Hoist.

Northern Special PL Double Hook Cab Hoists

This cut shows the double form of cab PL hoist. A hoist designed for heavy service. It is also made in single hook form and in same sizes as D hoists, but is of much heavier design and higher speeds.

Frame No. D	Capacity in Pounds	Hoisting Speeds Feet Per Minute Approximate		Lifts		Code Words	
		Direct Current	Alter. Current	Standard Lifts	Max. Lift Possible Special	Direct Current	Alter. Current
B $\frac{1}{4}$	500	20 to 40	20 to 22	12	60	Deho	Dehoac
B $\frac{1}{2}$	1,000	10 to 20	10 to 11	12	30	Dehope	Dehopac
F $\frac{1}{2}$	1,000	25 to 50	25 to 27	12	20	Dehise	Dehica
B1	2,000	5 to 10		12	15	Dehold	Deholdac
F1	2,000	20 to 50	20 to 22	12	20	Dehorn	Dehoac
F $\frac{1}{2}$	3,000	12 to 25	12 to 13	12	12	Dehast	Dehastac
F2	4,000	10 to 25	10 to 11	12	12	Dehort	Dehorea
G2	4,000	20 to 40	20 to 22	12	25	Deify	Deica
G3	6,000	17 to 40	17 to 18	12	25	Delate	Delaca
G5	10,000	9 to 20	9 to 10	12	12	Delight	Delica
G6	12,000	8 to 20	8 to 9	12	12	Delphic	Delfica
J8	16,000	9 to 20	9 to 10	12	12	Delatin	Delanca
J10	20,000	8 to 20	8 to 9	12	12	Delexus	Delimea

Northern Type D Electric Hoists

This series of electric hoist comprising type D, DQ and DQV ranges from capacity of one-quarter ton to 10 tons and are made for either alternating or direct current. Hardened, cut, enclosed and bath-lubricated steel gears are used; all bronze bearings; a very substantial limit stop.

Northern EPL Mill Hoists

This hoist is practically a monorail application of our type E standard crane trolley, and is made for extremely heavy mill service, in capacities from 3 tons to 10 tons. The working parts are enclosed frames of cast steel. It is made for alternating or direct current.



E-P-L Mill Type Hoist. Patented. For Heavy Mill Service.

NORTHERN ENGINEERING WORKS

221 CHENE STREET, DETROIT, MICHIGAN

Twenty-eight Years of Experi- ence and Growth

The Dravo Contracting Company, for the past twenty-eight years, has been engaged in river improvement work, including dredging and the construction of dams, locks, river walls,

bridge substructures and wharves. Early in their experience it became evident that available equipment was inadequate and unsuited to existing conditions and in response to the insistent demand of their Operating Department for better and still better machines, their Engineering Works Department was organized and a plant erected to supply this demand.

While the Engineering Works Department was originally organized solely for the purpose of designing and building equipment for the company's own use, the quality of their line has brought customers to the company in a steadily increasing number. The Dravo shops have grown from the first single building to the present plant comprising machine, forge, boiler, structural and plate shops with three boat yards for fitting and launching hulls.

Dravo Whirlers

The company has been building and using Dravo Whirlers for over twenty years on their own work. During this time all of the weak points have been eliminated, new features have

been added—with the result that the Whirler produced today is a machine rugged and powerful, one which they know from personal observation and experience will stand up under every condition and respond to every demand made upon it. The fact that these Whirlers are now giving unequaled satisfaction and service on their contracts should be conclusive evidence of their ability to serve others in a similar capacity.

Quick action, long reach, full swing and large capacity insure efficiency and unusually low handling costs. In its manufacture the best of materials obtainable are used throughout. Forged shafting, cut steel gearing and ample friction and braking surfaces to meet the conditions of bucket service and reduce upkeep to a minimum.

The company also builds special whirlers for special purposes and are always glad to place the experience and knowledge of their engineers at a customer's disposal in the selection of the best equipment for his particular requirements.

Further information can be had by writing for Bulletin 111.

Dravo Drag Line Excavators

The Dravo Dragline excavator represents the last word in the design and construction of this type of equipment. The ruggedness of design, high class construction, power, ability to

stand up under the most severe service and efficiency characteristic of all Dravo products are fully embodied in these machines.

The best of materials are used throughout. Forged shafting, cut steel gearing and ample friction surfaces to meet the conditions of service reduce upkeep to a minimum.

Rotation is accomplished by means of gearing an independent swinging engine to a pinion and cast steel circular rack with vertical teeth, giving unlimited

swing. The revolving platform is held in place by a central steadiment. Vertical loads are carried on heavy open hearth steel circular rail tracks with a large flanged steel roller held in relative position by means of a live ring. Overloads are provided for by means of a steel retaining ring. Stability is assured by the large diameter of the circular rail track.

Standard Dravo Draglines can be furnished up to three cubic yard capacity with a 100' boom.

This equipment is fully described in Bulletin 112.

Dravo Dredges

Dravo Dredges have been produced in response to a demand for equipment that is sturdy, practical and efficient, that moves the yardage without interruption at a minimum of

operating and upkeep cost.

The hulls are especially designed and constructed for the purpose. The machinery throughout is the best of its kind available and is thoroughly adapted to the severe service it is called upon to perform.

Dravo Dredges, of both the Dipper and Bucket Types, are giving unusual service and are making remarkable performance records wherever installed. Many satisfied customers testify to the quality and all around efficiency of Dravo Dredges.

The company will be glad to design a Dravo Dredge particularly adapted to any purchaser's requirements.

Complete data will be found in Bulletin 114.

Dravo Steel Towboats and Barges

Dravo steel towboats and barges form a wide variety of steel floating equipment and include: twin screw tunnel, stern wheel and gasolene propelled towboats; barges for coal, sand

and gravel, oil, package freight and miscellaneous freight; New York State Barge Canal self-propelled and non-self propelled cargo barges and galvanized barges for South America. We are, therefore, in position to handle any class of inland waterway floating equipment.

Bulletin 115 gives complete information on this type of equipment.

Dravo Service to the Buyer

It is well to bear in mind that all of the Dravo Company's equipment was originally designed and constructed so that it would pay dividends on their own contracting jobs. Buyers of

Dravo equipment, therefore, reap the benefits of Dravo experience and are assured of sturdy, efficient equipment that has proven its worth through years of practical operation.

The company is prepared at all times to furnish standard or special equipment in any of the above lines and will be glad to send copies of any or all of the descriptive Bulletins referred to above upon request.

The experience of the Dravo Engineering and Operating Departments has proven valuable to many of their customers and the company is glad to place this knowledge at the disposal of their clients. They will welcome an opportunity of furnishing complete information on any of their products and will be glad to co-operate with any prospective customer in working out his particular problems.

THE DRAVO CONTRACTING COMPANY

New York City
39 Cortlandt Street

ENGINEERING WORKS DEPARTMENT
Pittsburgh, Diamond Bank Bldg.

Philadelphia
1630 Real Estate Trust Bldg.

TERRY DERRICKS AND CRANES



5-Ton Self Slewing Derrick.



5 to 30-Ton Guy Derricks.



2-3.5 and 6-Ton Jinniwink Derricks.

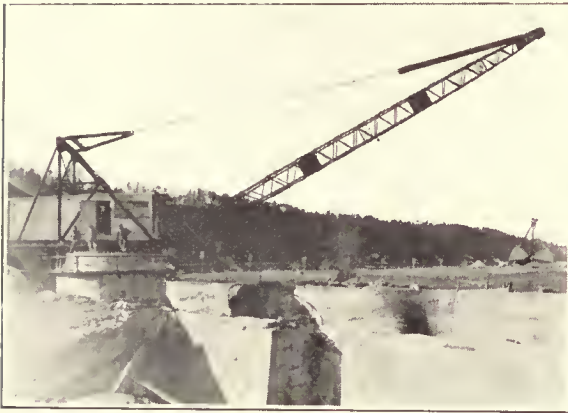

Full Circle Derrick, mounted on concrete base. Capacity up to 4 yd. bucket.

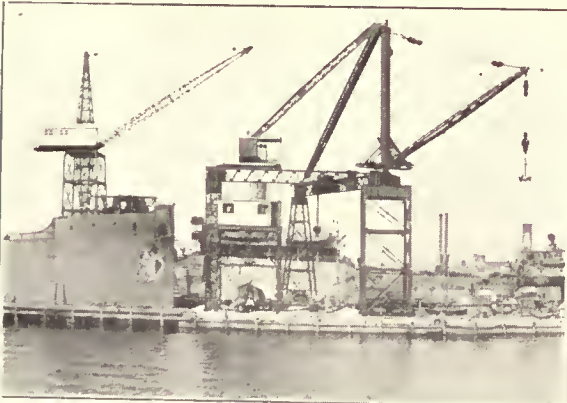

Hinged Boom Tower Cranes Up to 50 Tons Capacity—
Stiff Leg Derricks Up to 150 Tons Capacity.



"A" Frame Barge Derricks, 5 to 150 Tons Capacity.

Terry Design and Development Dept.

The Terry Manufacturing Company, during the past 23 years, have been designers and manufacturers of Steel and Timber Stiff Leg, Guy and Barge Derricks and Jinniwinks, also various types of Hinged Boom Revolving and Traveling Tower and heavy duty Pedestal Cranes. These cranes have booms up to 110' long and will handle up to a 4 yd. bucket. A versatile development department is maintained for the working out of material handling problems.

Application of Terry Derricks

Terry Derricks are extensively used in industrial plants, quarries, lumber yards, and for the handling of sand, gravel, broken stone, coal and all other bulk materials. Terry Derricks are also extensively used in the erection of steel structures. Barge Derricks are built for general wrecking or lighterage work. Cranes are used in cement plants, shipyards, dry docks and industrial plants.

Terry Derricks Fittings

All Terry Derricks, Travelers and Jinniwinks are pin connected, making for inexpensive and speedy dismantling or erection. All goose necks are forged from soft steel billets. The mast step and foot block is a highly finished ball and socket joint with a simple yet effective oiling system. The mast head unit on the stiff leg derricks is self contained and attached by bolts; the gudgeon pin and lead sheaves being carried therein.

Terry Timber Derricks are carried in stock, and are sold with or without timbers.

Information to Accompany Inquiries

To avoid delay in making quotations, your inquiries should state—

1. Type of equipment desired.
 2. Heaviest load to be lifted, giving class of material.
 3. The distance from the center line of rotation at which the load is to be lifted.
 4. Boom length.
 5. Whether hoisting engine is required.
 6. Type of power used, whether gasoline, steam or electricity.
 7. If electricity used, give type of current available.
- For special conditions, a rough layout of the handling problem should be furnished.

TERRY MANUFACTURING CO.
GRAND CENTRAL TERMINAL, NEW YORK CITY

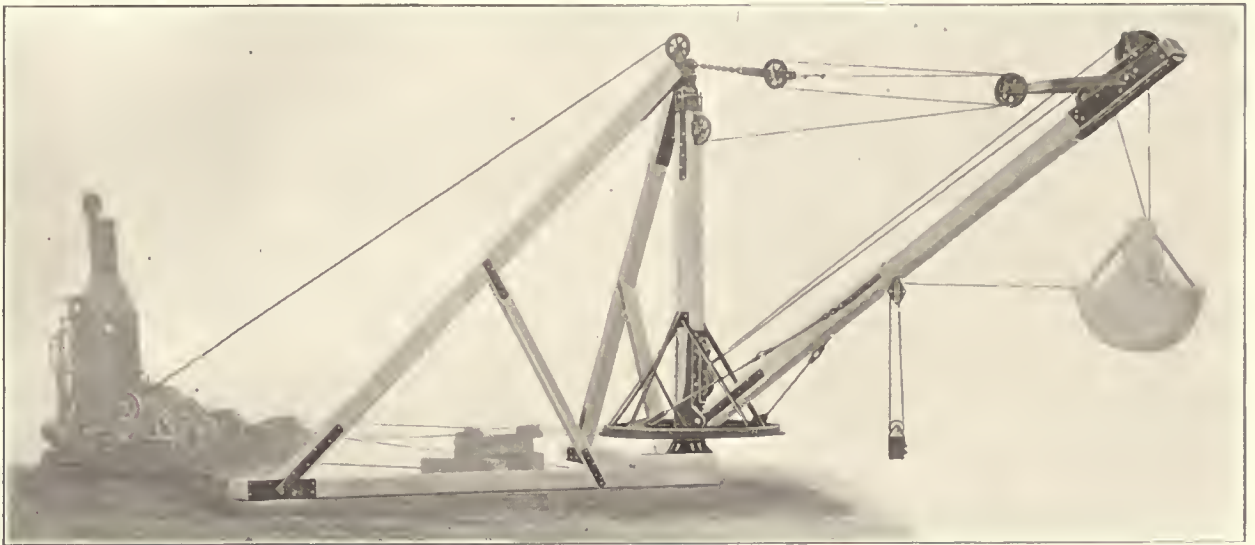

Stiff Leg Derrick for Clam Shell Bucket Work

Products

The Clyde Iron Works designs and manufactures a complete line of hoisting engines and derricks. Included are such types as stiff leg, and guy timber derricks, many classes of steel derricks, barge, jib boom and cane derricks; steam, electric, gasoline and belt driven hoisting engines, excavators, logging machinery and supplementary equipment.

For material handling derricks any of these hoists are applicable. If it is desired to swing the boom, a swinging gear may be coupled to the hoist, or independent swinging engine used.

Some of the standard types of equipment are illustrated on this page, but specifications and prices on machinery to meet special conditions will be furnished on receipt of the necessary information.

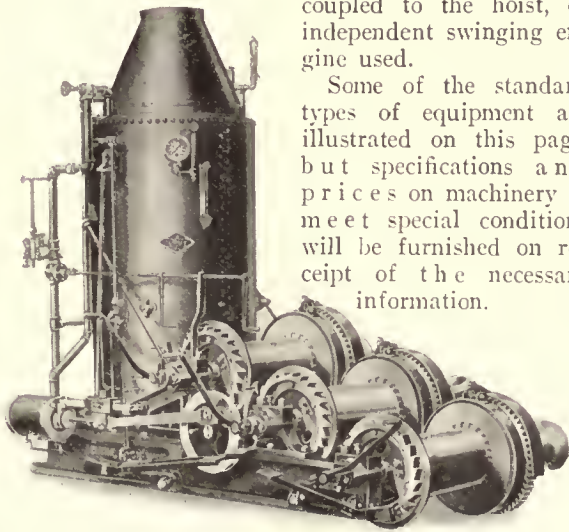

Three Drum Hoisting Engine With Boiler

Steam Hoists

Clyde steam hoists can be supplied with a boiler or, where steam or compressed air is available, without the boiler. The hoists are all of the double cylinder type and are made with one, two or three drums in tandem. Other combinations, such as parallel drum hoists, two-speed dragline excavator hoists and dock winches are also manufactured.

Electric Hoists

The Clyde one, two or three drum electric hoists are operated by a motor specially designed for crane and hoist service. Besides the three standard electric hoists just mentioned there are Clyde electric concrete tower hoists of one and two drums. The drums on these hoists are geared to deliver the high speed desirable for this work.

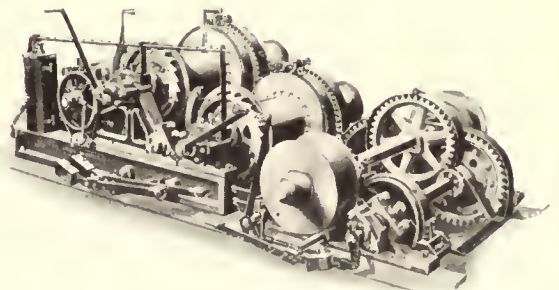

Two Drum Electric Hoist, With Derrick Swinging Gear

Gasoline Hoists

The motive power of the Clyde gasoline hoists is supplied by multiple, vertical cylinder, tractor type gasoline motors. The hoists are built similarly to the electric, and consist of one, two and three drum standard hoists, a gasoline concrete tower hoist and a gasoline builder's hoist. This last hoist is specially designed for handling material elevators, either single or double cage.

Derricks

Derricks are built for power or hand operation; are stationary or portable; may be equipped with bull wheel or bull gear for swinging; may be rigged for a straight lift or for a clam shell bucket; with a foundation for use on land or on a barge. The fittings for all derricks are strong castings and forgings secured with steel bolting straps.

LINK-BELT LOCOMOTIVE CRANES AND ELECTRIC HOISTS



Link-Belt Locomotive Crane

The general utility of the locomotive Crane is well established for handling coal, stone, logs, pig iron, and structural steel, packages, boxes, etc., weighing from one to 25 tons.

In fact such a machine is practically indispensable in the modern industrial establishment.

A Locomotive Crane combines in one machine a portable hoisting engine, swinging derrick, grab-bucket unloader, and switch engine.

The Link-Belt Crane represents the highest achievement in locomotive crane design. It is built throughout for hard and continuous service. Reliability, the most desired quality in any locomotive crane, will be found in the Link-Belt Crane, coupled with speed and ease of operation.

DISTINCTIVE FEATURES.—Steel gears and bronze bushings throughout; one-point adjustment on clutches; few parts, every one accessible; large roomy platform for operator, everything handy; exceptionally large factor of safety used; the only crane with foolproof safety device on swinging mechanism.

Send for Catalog No. 370.

Link-Belt Electric Hoist

Equally useful in industrial plants for handling miscellaneous light loads, is the Link-Belt Electric Hoist. It can be easily, quickly and inexpensively installed in old or new buildings. Monorail tracks can be attached to ceilings or girders anywhere. Little head room required. All parts are fully enclosed in dust proof, weather proof casings. Can be operated outdoors as well as indoors. Made in various capacities—floor or cage operated.

Let our engineers suggest quicker, easier, more economical ways of accomplishing hoisting and transporting service in your plant.

Send for our Electric Hoist Book No. 380.

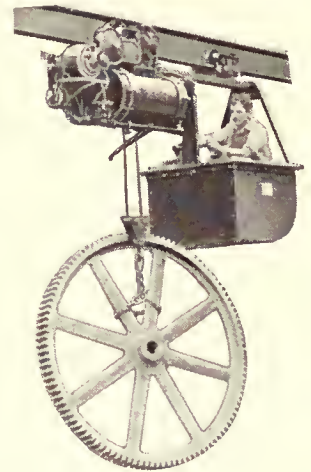

LIST OF SALES OFFICES

PHILADELPHIA

New York299 Broadway
 Boston 949 Federal St.
 Pittsburgh1501 Park Bldg.
 St. LouisCentral National Bank Bldg.
 Buffalo547 Ellicott Square
 Wilkes-Barre2nd National Bank Bldg.
 Huntington, W. Va.Robson-Prichard Bldg.
 Cleveland429 Kirby Bldg.
 Detroit4210 Woodward Ave.
 In CanadaCanadian Link-Belt Co., Ltd., Toronto and Montreal

CHICAGO

Kansas City, Mo.306 Elmhurst Bldg.
 Seattle820 First Ave. S.
 Portland, Ore.First and Stark Sts.
 San Francisco168 Second St.
 Los Angeles163 N. Los Angeles St.
 DenverLindrooth, Shubart & Co., Boston Bldg.
 Louisville, Ky.F. Wehle, Starks Bldg.
 New OrleansC. O. Hinz, 504 Carondelet Bldg.
 Birmingham, Ala.S. L. Morrow, 720 Brown-Marx Bldg.

INDIANAPOLIS

LINK-BELT COMPANY

CHICAGO

INDIANAPOLIS

PHILADELPHIA

See list of sales offices on this page.

BROWNHOIST LOCOMOTIVE CRANES



Brownhoist No. 4 Steam Locomotive Crane, Mounted on Standard M. C. B. Trucks, Handling a Bundle of Rails at a Steel Mill.



Brownhoist No. 2 Steam Locomotive Crane, Mounted on Brownhoist Creeper Trucks and Equipped with a Brownhoist 27 cu. ft. Grab Bucket for Handling Coal

Types

Brownhoist Locomotive Cranes are made in the following sizes, Nos. 2, 3, 4, 5 and 6, and there are several types of each size. These range in capacity from 5 to 40 tons. They may be operated by steam, electricity or internal combustion engine. The small models, Nos. 2 and 3, are equipped with four wheel trucks, and the Nos. 4, 5 and 6 are mounted on two MCB standard four wheel trucks. The No. 2 Crane may also be equipped with Brownhoist Creeper trucks or traction wheels. Various lengths of boom can be used on the various types, depending on the work to be handled.

Uses

Brownhoist cranes are being used for practically all kinds of hoisting work and for handling many kinds of materials. Some of these uses are handling coal, ore, cinders, gravel, stone, etc., with grab bucket; erecting structural work and handling all kinds of sling loads with bottom block; excavating with drag-line or orange-peel buckets; driving piles; pulling piling, and handling scrap, bars, etc., with lifting magnet. Switching cars is also an important part of the work of most locomotive cranes.

Capacities

Capacities vary for the different types, larger or smaller capacities being obtained with different type cranes and different lengths of booms. Brownhoist crane capacities are figured with a large factor of safety and will handle their loads freely with no danger of tipping. These loads may be increased over the regular rated capacities of the cranes by the use of outriggers.

Operation

The Cranes can be operated and fired by one man. Operating levers and brakes are arranged for the rapid and convenient operation of the crane, at the same time giving the operator a full view of his work at all times.

Advantages

Brownhoist cranes are unusually fast in operation. In starting and stopping, they develop full power quickly. As this is an almost constant operation in locomotive crane work, this feature is an important item to consider. They are a quality crane, designed and built to stand up under hard, continuous service. And they have earned a wide reputation for fast operating speeds, increased tonnage which they handle and low cost of upkeep.

Other Brownhoist Products

Brownhoist products include: Grab Buckets; Dragline Buckets; Electric Hoists; Grab Bucket Cranes, Trolley and Tramrail systems; Car Loaders and Unloaders; Bridge Trams; Fast Plants; Cantilever Cranes, Overhead Traveling Cranes, Jib Cranes, Pillar Cranes, Bridge Cranes, etc.

All of these products are built to the high standard of quality which has been maintained by Brownhoist ever since the founding of this company over 40 years ago. Handling machinery is usually subjected to hard service and our experience has proved that high quality is necessary in a crane or hoist for it to last and deliver a low operating cost over a long period of years.

We will gladly furnish information and catalogs on any of the above equipment to anyone who is interested.

Branch offices in New York, Pittsburgh, Chicago, San Francisco and New Orleans

BROWNHOIST

European representative: H. E. Hayes,
12 Rue de Phalsbourg, Paris.

THE BROWN HOISTING MACHINERY COMPANY

CLEVELAND, OHIO

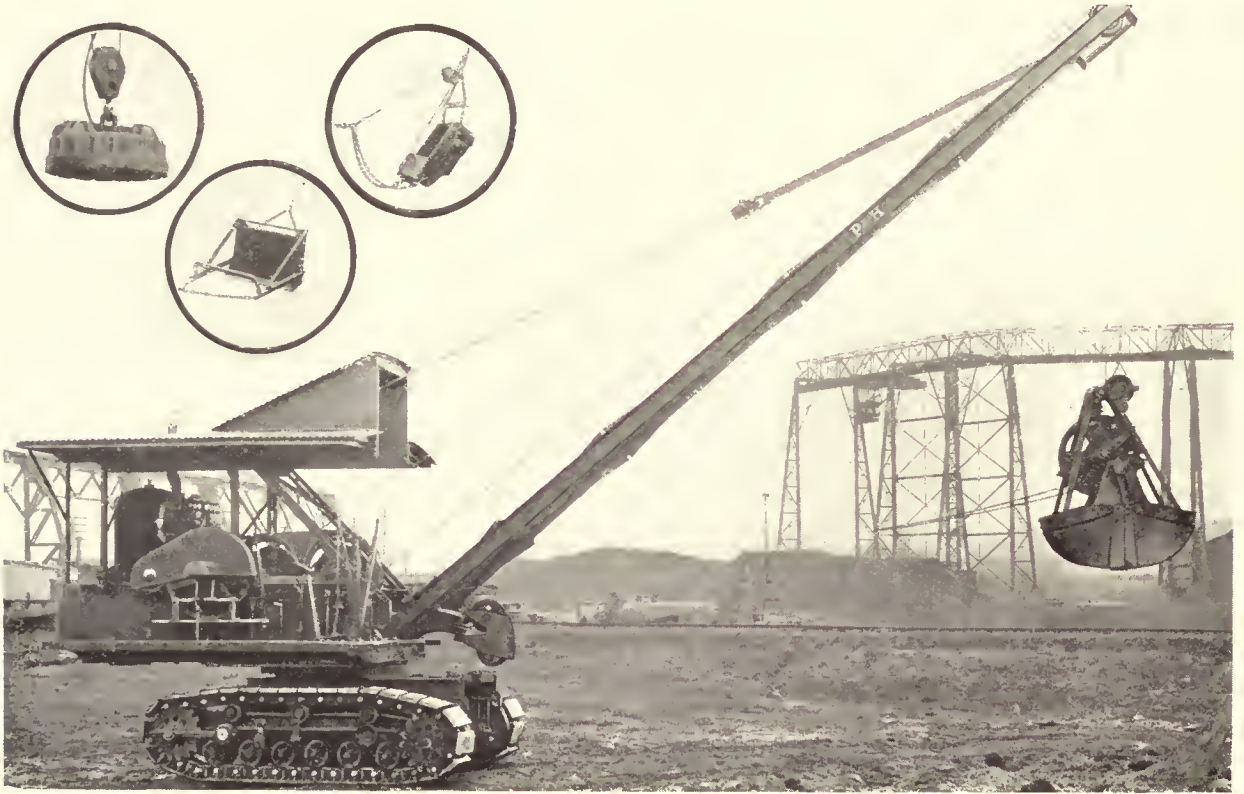

P & H Type 206 Excavator and Material Handling Crane showing some of the other attachments besides the bucket.

P & H Excavating and Material Handling Cranes

For the handling of coal, ashes, earth, pig iron, scrap, sand, gravel, sugar cane, and for excavating purposes, P & H types 205 and 206 Excavator-Cranes have been designed.

These general utility cranes do the work of a steam shovel, locomotive crane and dragline excavator. The 205 has corduroy traction with flat leading wheels, while the 206 has full corduroy mounting and is for use where soil conditions are uncertain and the country very hilly. This crane is also of large capacity.

It is of all steel construction, correct design, and is entirely a complete operating unit, requiring no accessory equipment except bucket.

The standard boom is 30 feet, swings in a full circle and may be used with grab bucket, sling chains, electro magnet, digging bucket, grapple, or scraper.

In place of the standard boom a shovel attachment may be provided and the machine then does the same work as a steam shovel of equal weight.

Heavy duty four cylinder 5" x 6 1/4" motors are used.



P & H Type 205 Crane with magnet unloading pig iron.



P & H Type 205 Excavator-Crane with Shovel Attachment.

A complete stock of wearable parts is constantly maintained, assuring prompt forwarding of parts when required.

Other products bearing the symbol of "P & H" are: Traveling Cranes, Hoists, Monorail systems, Single Line Grab Buckets, Drilling and Boring Machines.

OHIO LIFTING MAGNETS



Ohio Lifting Magnet.
Note Protection of Terminals and Leads

Coil leads are of flexible braided copper ribbon which rises in individual terminal cavities through a protecting ring of heavy impregnated asbestos. The copper terminal stud is brought out through a heavy unbreakable bakelite insulator, securely held and water-proofed by means of packing rings and a gland nut. The outside leads are flexible, having a rubber hose covering clamped to case, to avoid pulling strains on the terminal. Screw connectors are provided permanently insulated so that taping is unnecessary.

Magnet Controller

This controller saves space yet operates continuously. It further protects the magnet from heavy inductive kick strains.

It makes circuit for lift; opens circuit with magnetic blow-out and with resistance shunted across magnet terminals to reduce arc and kick strain; and reverses through limiting resistance for quick drop of load.

All hinged joints are shunted; resistance is enameled, set in clips and mounted in case back of controller slate. Resistance may be inspected and replaced by opening the box without disturbing the wiring or mounting.

The operator's master switch is strong and compact. It has three positions, forward for magnet on, center for magnet off, and reverse for dropping the load quickly.

Specifications

Case of soft annealed cast steel is in three parts to insure solid casting and high magnet efficiency. All internal electric joints are double braze-welded, eliminating the possibility of

open ends. All insulation is hard pressed impregnated asbestos, mechanically strong, unaffected by heat, age or moisture.

The Ohio outer ring construction provides an unbreakable wearing section good for 10 to 20 years. The weight of the magnet is materially reduced by having the magnetic diameter equal the physical diameter.

As a permanent water proofing, the Ohio Magnets after assembly are filled with hot asphaltum compound under pressure.

Construction

All coil insulation is impregnated; the coil therefore is a hard, solid mass clamped between the top and bottom members of the steel case. Steel spacers are provided to take

the shock of impact. This construction results in a rapid radiation of heat and maximum all-day lifting efficiency.

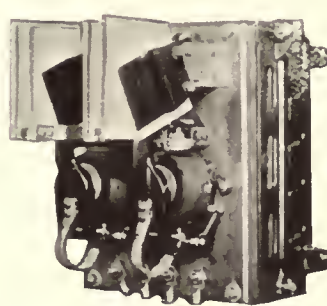

Magnetic Switch.



Master Switch.

COST OF OWNING AND OPERATING AN OHIO MAGNET IN HARD CONTINUOUS SERVICE

Size	No. 2	No. 3	No. 4	No. 5	No. 6
	20 inch	30 inch	40 inch	50 inch	60 inch
Interest at 6%	29.10	65.40	101.58	141.90	213.00
Depreciation at 10%	48.50	109.00	169.20	236.50	355.00
upkeep at 2%	9.70	21.80	33.86	47.30	71.00
Current for 10 hours per day 300 days at 2¢ p.r. kw. hour	29.04	79.20	178.20	264.00	429.00
Total per year.....	116.34	275.40	482.94	689.70	1068.00
Cost per day, Total÷300.....	.39	.92	1.61	2.30	3.56

ARE YOUR MATERIAL HANDLING COSTS COMPARABLE?

DIMENSIONS, WEIGHTS, ETC.

Size No.	D2	D3	D4	D5	D6
Diameter	20 (51)	30 (77)	40 (102)	50 (127)	60 (153)
Headroom required	13.5 (35)	29.5 (75)	39 (99)	40 (102)	45.5 (116)
Amperes required at 220 volts D.C.	6	13	30	45	71
Weight of magnet	460 (213)	1300 (590)	3100 (1406)	4500 (2041)	7100 (3220)
Shipping weight, export	618 (280)	1510 (685)	3400 (1545)	4920 (2240)	7700 (3500)
Space occupied, export	7.8 (0.22)	17 (0.48)	31.6 (0.89)	47 (1.33)	68.5 (1.94)
Magnet and controller	RIVER	LAKE	WOOD	FOREST	CAPE

* (See Note).

LIFTING CAPACITY

Thick billets or slabs	3500 (1600)	15000 (6800)	30000 (13000)	40000 (18000)	50000 (23000)
Steel ingots	3000 (1360)	10000 (4500)	15000 (6800)	18000 (8000)	22000 (10000)
Skull cracker balls	3000 (1360)	10000 (4500)	15000 (6800)	20000 (9000)	20000 (9000)
Pig iron	220 (100)	600 (270)	1300 (570)	2000 (900)	2900 (1330)
Heavy scrap	250 (115)	600 (270)	1300 (570)	2000 (900)	2900 (1330)
Light scrap	125 (57)	350 (160)	600 (270)	800 (450)	1200 (540)

* Controllers:—Operating controller, packed for export or domestic shipment in a separate case, weighs 140 lb. (64 kg.) and occupies 4. cu. ft. (0.113 cub.m.).

THE OHIO ELECTRIC & CONTROLLER CO.
CLEVELAND, OHIO

HAYWARD ELECTRIC MOTOR BUCKETS

Construction and Operation

The Hayward Electric Motor Bucket is similar in general design to the Hayward Two-line Clam Shell Bucket with ore-bowl described on the page opposite. This Bucket, as the name indicates, has, as an integral part, a motor-operated dust-proof, winding mechanism, which opens and closes the jaws of the bucket, making it an electrically operated unit. It has a wide field of usefulness wherever bulk material is to be handled.

The movement of a handle—as simple as turning a door knob—controls the opening and closing of the Hayward Electric Motor Bucket. Throw the controller handle over a few inches and the bucket digs a ton or more of coal, or sand, or gravel; throw the handle back a few inches and either the whole load or only a part of it may be dumped where wanted.

An important feature of the Hayward Motor Bucket is the introduction into the transmission of a Multiple Disc Clutch, its function being to slip and permit the motor to continue to run in case the edges of the bucket come together or are held apart by some obstruction, while the controller is in the closing position. This eliminates the necessity of limit switches, circuit breakers or similar devices, and makes the bucket practically "fool-proof" in the hands of the ordinary crane operator and greatly simplifies its construction. The bucket is controlled entirely by one man and may be operated near workmen without danger, as it is under full control at all times—accidental discharge of the load is impossible.

Application

Although introduced but a little more than eight years ago, Hayward Electric Motor Buckets are now in daily use handling all kinds of loose materials in bulk, in many Industrial Plants, Foundries, Steel Plants, Boiler Rooms

Railroad Terminals, Fertilizer Plants, etc.

No special machine is required to operate a Hayward Electric Motor Bucket. Any type of machine having a hoisting drum and powerful enough to safely lift the bucket and its load may be employed. It is being used in connection with Traveling Cranes, Electric Monorail Hoists, Derricks, Locomotive Cranes, Incline Boom Unloaders, Skull Crackers, Yard and Stock Room Cranes, etc. The fact that the crane which handles the bucket does not have to be specially designed for bucket service, is of great advantage. The Crane may be used for transferring sling loads or for other work and changed over for handling bulk loads, by attaching the bucket to the Crane Hook and plugging in the conductor cable—an operation which takes but a minute or two.

As the bucket works within its own height, no additional clearance need be allowed for operating lines, a particular advantage where head-room is limited.

Sizes, weights and dimensions of the most-called-for Type of Hayward Electric Bucket are listed below.

Special Buckets, varying in weights and dimensions, are built to suit the individual needs of the user.

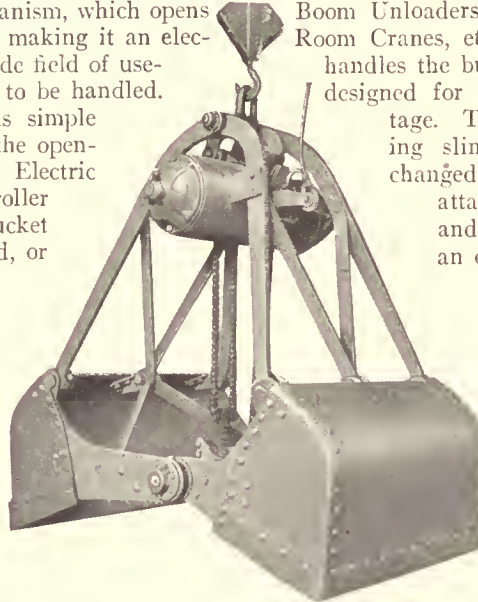

Illustration A-2716
Hayward Electric Motor Bucket.

Bowl Capacity	Ap'rx Wt. in Lbs.	Closed						Open			
		H'ght		L'ng'b		Width		H'ght		L'ng'h	
		Ft.	In.	Ft.	In.	Ft.	In.	Ft.	In.	Ft.	In.
7½ cu. ft.-----	1200	4	9	3	4	2	9	5	5	4	3
¾ cu. yd.-----	2600	5	9	4	1	3	10	6	5	5	5
¾ cu. yd.-----	3200	6	10	4	1	3	10	7	6	5	8
1 cu. yd.-----	3700	7	7	4	8	4	0	8	4	5	4
1 cu. yd.-----	4600	6	7	4	8	4	0	7	4	6	4
1¼ cu. yd.-----	4700	7	5	5	1	4	3	8	1	7	4
1½ cu. yds.-----	4900	7	5	5	1	4	11	8	1	7	4
2 cu. yds.-----	9000	9	0	6	1	5	7	10	0	8	9
2½ cu. yds.-----	10000	9	4	7	0	5	0	10	5	9	9
3 cu. yds.-----	10500	9	4	7	0	5	10	10	5	9	9

Service and Catalogs

The advice of Hayward Engineers is freely given on all problems calling for the speedy and economic digging and re-handling of materials with Automatic Buckets. We have a very comprehensive line of catalogs and pamphlets describing Hayward Buckets in great detail, and covering specific applications of the many uses for automatic buckets. Copies of catalogs and pamphlets are sent promptly upon request.

Hayward Clam Shell Buckets

Hayward Clam Shell Buckets are built in several standard and special types, each designed for some particular kind of digging, dredging, or rehandling work. Each type is of rugged construction throughout and will stand up to the hardest kind of bucket usage. All wearing parts are replaceable and may be renewed on the job, without loss of time, as wear develops. Hayward Clam Shell Buckets are built in capacities ranging from one and five-eighths cubic feet to ten cubic yards.

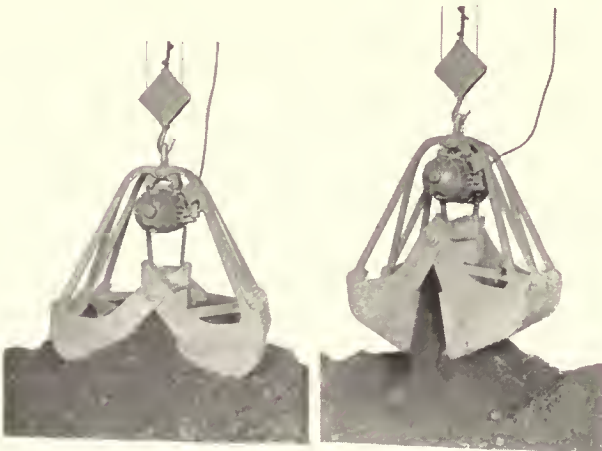

Hayward Electric Motor Bucket.
Digging.

Dumping.

HAYWARD CLAM SHELL AND ORANGE PEEL BUCKETS

Hayward Class "E" Clam Shell Buckets

Hayward Class "E" Clam Shell Buckets are most commonly used for all around contractors' work and for rehandling coal, sand, gravel and similar bulk materials in and

around industrial plants. They are operated by two lines, one for opening and closing, the other for holding the bucket while it is discharging its load. Practically any type of machine may be used for operating the Class "E" Buckets, provided it is equipped with a double drum hoist.

Class "E" Buckets are built either with Regular Bowls or Ore Bowls. Regular Bowl Buckets are used principally for handling coal and other light loose materials, and for dredging. The blades of this bucket are made with curved backs extending from the top to almost the cutting edge, making it a quick acting bucket—the whole load being discharged before the bucket is entirely opened.

The Ore Bowl Bucket is made with a tray-like shell or bowl, resembling a shovel

which allows the material to slide more easily into the shell while crossing. In proportion to size Ore Bowl Buckets carry larger loads and will dig harder materials than the Regular Bowl Buckets.

We recommend the Class "E" Clam

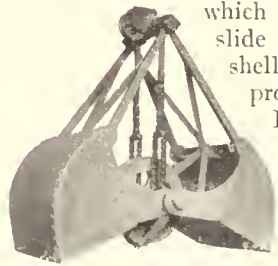

Illustration A-2564. Hayward Class "E" Regular Bowl Clam Shell Bucket.

Shell Bucket with Ore Bowl for digging and rehandling bulk materials such as sand, gravel, crushed stone and many other similar materials. When fitted with teeth it may be used for digging the harder materials from their natural state.

It is used on Traveling Cranes, Monorail Cranes, Guy and Stiff Leg Derricks, Skid Excavators, Traveling Derricks, Railroad Excavators, or on any type of machine rigged for bucket work.

Hayward Orange Peel Buckets

For over thirty-five years we have been developing automatic buckets and of the Orange Peel Type we build all classes, from buckets of almost limitless digging power and capacity down to the Dwarf Orange Peel Bucket, the smallest of which has a capacity of 100 cubic inches, and may be operated inside of a 12-inch pipe.

The Hayward Standard Orange Peel Bucket shown in illustration A-837 is generally recommended for all classes of dredging, excavating, and rehandling work. It is an all around Contractors' Bucket used principally for sewer work—in gravel banks, removing overburden, dredging, excavating, and rehandling material generally. Like the Clam Shell Bucket it is a two-line bucket and may be operated by almost any type of machine equipped with a double drum hoist. On Orange Peel Buckets as on all other types of Hayward Buckets every wearing part is fitted with removable and replaceable

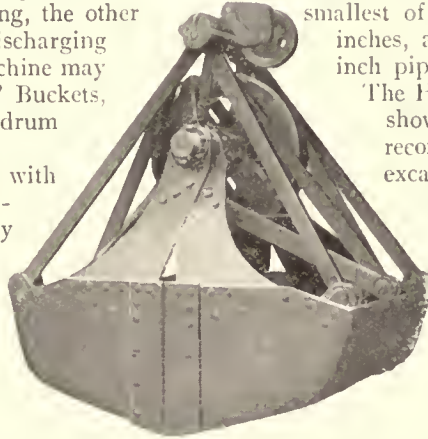

Illustration A-719. Hayward Class "E." Ore Bowl Clam Shell Bucket.

bushings and bearings.

Other types of Hayward Orange Peel Buckets are Extra Heavy, Multi-Power, Three-Sided, Rope-Reeved and Dwarf Buckets.

Most of these buckets are recommended for classes of work requiring buckets of heavy construction that will stand up to the hardest kind of bucket usage, as canal digging, digging out old rip rap and cribbing, pulling piles and stumps, cylinder sinking and foundation work, sand and gravel banks, digging clay and other compact material, handling rocks and large boulders, dredging and an endless variety of work requiring buckets of the strongest construction throughout.



Illustration A-837. Hayward Standard Orange Peel Bucket.



Illustration A-2595. Hayward Three-Sided Orange Peel Bucket.

HAYWARD CLASS "E" CLAM SHELL BUCKETS ORE BOWLS

Bowl Capacity	Approximate Weight in Pounds	Closed						Open						
		Height		Length		Width		Height		Length				
		Ft.	In.	Ft.	In.	Ft.	In.	Ft.	In.	Ft.	In.	Ft.	In.	
1/2 cu. yd.	1850	5	5	2	4	1	3	4	5	5	5	11		
3/4 cu. yd.	2600			10	5	0	3	4	6	5	7	3		
1 cu. yd.	2900	6	8	5	7	3	4	4	7	4	8	5		
1 1/4 cu. yds.	3200	6	8	5	7	3	11							
1 1/2 cu. yds.	4000	7	4	6	3	4	3	3	9	0				
1 3/4 cu. yds.	4200	7	4	6	3	3	3	3	9	0				
2 cu. yds.	5000	7	4	6	3	3	3	3	9	0				
2 1/2 cu. yds.	5800	8	6	7	0	5	3	3	9	7	10	0		
3 cu. yds.	6500	8	6	7	0	6	0	9	7	10	0			

HAYWARD STANDARD ORANGE PEEL BUCKETS

Capacity Cu. Ft. and Cu. Yds.	Approximate Weight in Pounds	Closed				Open			
		Diameter		Height		Diameter		Height	
		Ft.	In.	Ft.	In.	Ft.	In.	Ft.	In.
2 cu. ft.	500	2	2	3	7				
2 1/2 cu. ft.	550	2	7	3	10	3	3	3	4
3 cu. ft.	950	3	0	4	8	3	3	3	4
5 cu. ft.	1000	3	2	4	8	3	3	3	7
7 cu. ft.	1100	3	6	3	9	3	3	3	7
9 cu. ft.	1200	3	10	3	9	4	3	3	10
12 cu. ft.	2200	4	3	3	4	3	3	3	7
15 cu. ft.	2350	4	7	3	4	3	3	3	7
21 cu. ft.	3800	5	1	3	3	3	3	3	4
3 cu. yd.	4200	5	8	3	3	3	3	3	6
1 1/4 cu. yds.	4600	6	0	3	3	3	3	3	6
1 1/2 cu. yds.	5350	6	4	3	3	3	3	3	6
1 3/4 cu. yds.	7750	6	4	9	6	7	10	10	6
2 cu. yds.	8500	7	0	10	0	5	6	11	3
3 cu. yds.	12500	8	10	11	0	10	6	12	8

OWEN CLAM SHELL BUCKETS

Owen Buckets

The new Owen Bucket, refined and improved through 15 years of specialized experience, is more durable and digs even better than previous models, although there is no increase in weight. The combined improvements result in: (1) an increase in durability to the extent of making it practically foolproof; (2) an increase in digging power by utilizing its great closing power to the maximum extent, and (3) the use of larger, grit proof, well lubricated bearings which reduce the upkeep cost and lengthen the life of the bucket.

Owen Buckets are generally acknowledged to embody unequalled digging ability, a reputation they have earned by virtue of a superior principle, the operation of which is explained below.



All Owen buckets, when fully reeved, have five parts of closing line, which exert a closing power of approximately 5 to 1—or five times greater than required to close the bucket—which is ample for the hardest digging. This closing principle furnishes undiminished power from the start to the finish of the closing operation.

Lever Type Brackets

Owen Lever Type Brackets (C) apply the thrust exerted via the arms, at the point where the least force is required to close the bucket. Leverage is applied at the very beginning of the closing operation which constantly increases as the bucket closes. (Distance between (D) and (E) indicates the amount of leverage at the start of the closing operation.)

Quick Opening and Closing Action

Speed of handling is afforded in easy digging materials as the number of sheaves and length of line to be reeved is optional. This adjustable feature enables the Owen to speed up where quick action is desired and give efficient service in a wide range of work.

Cost Less to Operate

The non-chafing feature minimizes the cost of cable replacements. This design causes the cable to lead "fairly" from groove to groove and permits the off-running and on-running portions of the cable to function in the center plane of the bucket.

Cross head and counterweight do not tip when bucket is opened. Guide sheaves and rollers prevent the cable from chafing against the crosshead regardless of digging angle. Sheaves are of large diameter. No "S" bends are necessary in the cable, which can be lubricated if desired as it rarely comes into contact with the material. Sheaves will readily clear themselves should material cave in on blocks.

Grit-Proof Lubricated Bearings

Closing sheaves are bronze bushed and revolve on hollow sheave pins of large diameter which contain grease and distribute it at the center of each bearing. Arm pins and main-shaft are also lubricated and protected.

The main shaft (A) is keyed to the outside hinges and has a bearing the width of the bucket in a heavy perforated bushing to which the inside hinges are keyed. Grease is supplied automatically from a large reservoir counterbored at the center and above the bearing.

This method preserves rigidity and outlasts the old type of bearing five to one.

Cutting Edges Hit First

The cutting edges of the Owen Bucket hit first when the bucket drops, forcing the lips into the material far enough to give the needed start in hard "digging."

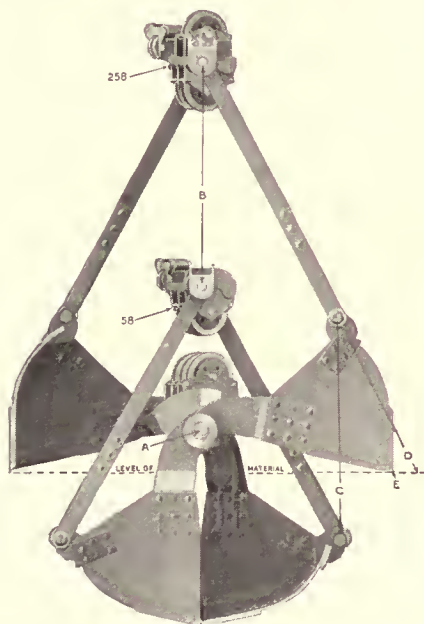

Correct Distribution of Weight

Digging ability depends upon a ample, undiminished closing power and a sufficient amount of properly distributed weight.

The lifting tendency, present in all buckets at point (A), cannot be completely overcome but in the Owen the majority of weight centers here. As a result (A) is held practically stationary and the maximum downward pull is exerted at point (B), forcing the jaws into the material and affording maximum digging ability.

Thus weight concentrated at point (A) converts closing power into digging power.

Closing and Digging Power

As the gain in digging power obtained through concentrating weight at point (A) is in proportion to the increase in weight, provision is made in Owen Buckets for additional

weight in the form of counterweight jackets which may be quickly bolted in place.

Lifting tendency is in proportion to the amount of leverage or purchase exerted, which varies greatly in different buckets.

THE OWEN BUCKET CO., CLEVELAND, O.

OWEN CLAM SHELL BUCKETS

Three Types of Owen Buckets

Owen Buckets are made in three types which differ mainly in weight, dimensions and shell construction to give the greatest strength and rigidity with minimum deadweight and without detracting from the penetrating ability of the shell.



Type "O" Buckets

The ideal contractors' and industrial plant bucket, recommended for general excavating and dredging, handling crushed stone, slag, sand, gravel, coal, etc.

Equipped with renewable, heavy, high carbon steel cutting plates or blades, re-enforced with renewable manganese steel corner lips to retard wear at the corners of the cutting edge.

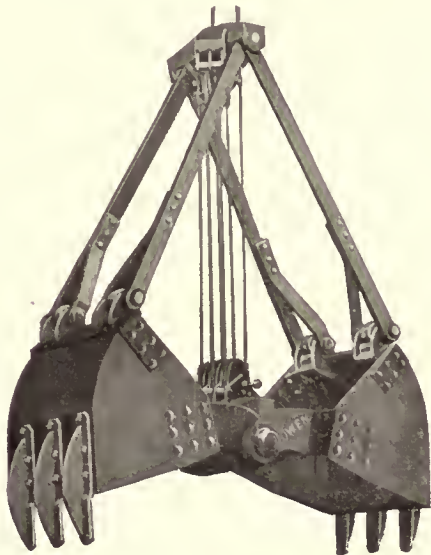

Size	Weight	Width	OPEN		CLOSED	
			Length	Height	Length	Height
1/2 Yd.	3200 Lbs.	2' 6"	6' 3"	7' 0"	5' 2"	6' 7"
3/4 Yd.	3750 Lbs.	3' 2"	6' 6"	8' 4"	5' 7"	7' 2"
1 Yd.	3950 Lbs.	3' 2"	6' 10"	8' 0"	6' 2"	7' 6"
1 1/4 Yds.	4750 Lbs.	3' 2"	7' 0"	10' 0"	6' 10"	8' 6"
1 1/2 Yds.	6000 Lbs.	4' 2"	8' 0"	10' 0"	6' 9"	8' 3"
2 Yds.	6500 Lbs.	4' 2"	8' 10"	10' 9"	7' 3"	8' 16"
2 1/2 Yds.	7200 Lbs.	5' 0"	8' 10"	10' 9"	7' 3"	8' 16"
3 Yds.	7700 Lbs.	5' 0"	9' 9"	12' 0"	8' 3"	9' 8"

Type "S" Buckets

A transfer or rehandling bucket of the scraper type particularly adapted for handling material thinly distributed, in small piles or in shallow bins.

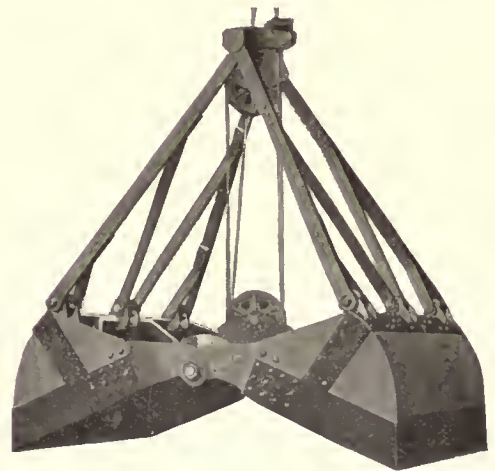

Size	Weight	Width	OPEN		CLOSED	
			Length	Height	Length	Height
1/2 Yd.	2250 Lbs.	2' 6"	6' 3"	7' 0"	5' 2"	6' 3"
3/4 Yd.	2550 Lbs.	2' 6"	6' 3"	7' 0"	5' 2"	6' 3"
1 Yd.	2300 Lbs.	2' 6"	6' 10"	8' 0"	5' 7"	7' 6"
3/4 Yd.	3000 Lbs.	3' 1"	6' 6"	7' 8"	5' 3"	6' 4"
3/4 Yd.	3250 Lbs.	3' 1"	6' 6"	7' 8"	5' 3"	6' 4"
1 Yd.	3500 Lbs.	3' 1"	7' 0"	8' 0"	6' 0"	7' 6"
1 1/4 Yds.	3750 Lbs.	3' 1"	7' 6"	9' 9"	6' 10"	7' 5"
1 1/2 Yds.	5000 Lbs.	4' 2"	8' 0"	9' 8"	6' 9"	7' 10"
2 Yds.	5300 Lbs.	4' 2"	8' 10"	10' 9"	7' 3"	8' 16"
2 1/2 Yds.	6000 Lbs.	5' 2"	8' 10"	10' 9"	7' 3"	8' 16"
3 Yds.	6400 Lbs.	5' 2"	9' 9"	12' 0"	8' 3"	9' 8"

Size	Weight	Width	OPEN		CLOSED	
			Length	Height	Length	Height
1 Yd.	3200 Lbs.	4' 2"	7' 2"	8' 4"	5' 3"	7' 2"
1 1/4 Yds.	3500 Lbs.	5' 2"	7' 2"	8' 4"	5' 3"	7' 2"
1 1/2 Yds.	4600 Lbs.	5' 2"	8' 6"	9' 3"	5' 7"	8' 6"
2 Yds.	5100 Lbs.	5' 2"	9' 6"	9' 11"	6' 6"	8' 16"
2 Yds.	5800 Lbs.	6' 2"	9' 0"	9' 11"	7' 0"	8' 10"
2 1/2 Yds.	6500 Lbs.	6' 2"	9' 6"	10' 7"	6' 6"	9' 5"
3 Yds.	6800 Lbs.	6' 2"	10' 0"	11' 6"	7' 0"	9' 8"

Type "D" Buckets

A heavy duty bucket, re-enforced for great strength and durability. It is recommended for the heaviest kind of excavating and dredging work, also for rehandling ore, blast furnace slag, limestone, rocks and other rough materials.

One piece, renewable, high carbon steel lips extend completely around the jaws and are exceptionally deep at the cutting edge, insuring great penetrating power without sacrificing wearing qualities.

The Owen Bucket Catalog which contains complete information regarding the various types and numerous illustrations of them in operation under different conditions, will be sent upon request.

VULCAN GRAB-BUCKETS

Vulcan Aims



ESTB. 1848

Fifty years of experience are behind the grab-buckets manufactured by the Vulcan Iron Works. For fifty years it has been the aim of the company to build buckets that will operate successfully, with the greatest ease and with the least possible wear.

To the man who is interested in buckets or to the man with bucket troubles the Vulcan Iron Works offers the benefit of this half century of experience.



The above bucket has been in constant use for 17 years and can be seen at any time at the plant of the Engineering Supply Co., at Jersey City, N. J.

Vulcan Grab-Buckets

The output of the Vulcan Iron Works includes both clam and orange-peel buckets, and each in several different sizes. As far as possible the different parts of these buckets are inter-

changeable. If repairs are necessary they can usually be taken care of on the job by inexperienced labor.

Every Vulcan clamshell bucket is capable of digging and rehandling but each size and type has certain uses for which it is most suitable. The lighter and



Vulcan Orange-Peel Dredging.

smaller types work most advantageously when handling coal, sand, gravel and similar substances. The heavier types are better adapted to handling broken stone, slag, shale, etc.

Vulcan orange-peel buckets will work in anything penetrable, from clay to hardpan. They will pull up sunken piles and tree stumps. They will lift boulders, cribwork, etc. One five yard orange-peel bucket which has been on the job for fifteen years can be seen at any time on the Riker Island improvement work in New York City.

General Repair Work

In addition to the shops which are building Vulcan buckets, this company has a large repair shop capable of repairing any type, size or make of bucket. The Vulcan Iron

Works will pay the freight one way on all repair work. Estimates are submitted for the customer's approval before work is started in all cases.



CLAM SHELL BUCKET

Cap. Yd.	Closed			Open			Weight	CODE Word
	Width	Height	Depth	Width	Height			
1/2	4' 1 1/4"	5' 8 3/4"	3' 2 1/2"	6' 2"	6' 2"	2000	BANCY	
3/4	4' 0 1/4"	6' 2 3/4"	3' 4 7/8"	7' 3"	6' 7 1/2"	2300	BAHDY	
1	5' 0 5/8"	6' 8 3/4"	3' 9 1/4"	7' 6"	7' 4 1/2"	3200	BAHEZ	
1 1/2	5' 0 5/8"	7' 4 3/4"	4' 2 1/4"	7' 6"	7' 4 1/2"	3400	BAHEP	
2	6' 0 5/8"	7' 9 3/4"	4' 8 3/4"	9' 3 1/2"	8' 1"	4000	BAHGP	
2 1/2	6' 0 1/2"	8' 8"	4' 10 3/4"	10' 3"	9' 4 1/2"	5000	BAHHC	
3	7' 0 1/2"	9' 6 1/4"	5' 0 7/8"	11' 1"	10' 3 1/2"	6400	BANLG	

The above sizes in stock for immediate shipment.

ORANGE PEEL BUCKET-4 BLADES

Cap. Yd.	Closed		Open		Weight	Code Word
	Dia.	Height	Dia.	Height		
1/2	4' 4"	6' 2"	5' 0 1/2"	6' 10 3/4"	2000	ABAUZ
3/4	4' 10"	6' 11"	5' 4 1/2"	7' 10 1/2"	3000	ABAUT
1	5' 4 1/2"	7' 6"	6' 0 1/2"	8' 6 1/2"	4200	ABAUU
1 1/4	5' 6 1/4"	8' 1 3/4"	6' 1 1/2"	9' 1 1/2"	4800	ABAUX
1 1/2	5' 11 3/4"	8' 8"	6' 8 1/2"	9' 11"	5800	ABAUZ
2	6' 6 3/4"	9' 1"	7' 4 1/2"	10' 4"	6600	ABAVA
2 1/2	7' 4 1/2"	10' 3"	8' 4"	11' 6 1/2"	9400	ABAVI
3	7' 9"	10' 3"	8' 10"	11' 6 1/2"	12180	ABAVY

The above sizes in stock for immediate shipment.

VULCAN IRON WORKS, INC., JERSEY CITY, N. J.

LAKEWOOD CLAM-SHELL BUCKET

Speedy Handling with Lakewood Buckets

Speed in handling sand, stone, gravel, coal, cinders or other loose material has made Lakewood Clam-Shells popular for this work.

What a Few Users Say

How well the Lakewood Clam-Shell serves its users is evidenced by these typical quotations from letters.

"We used your bucket for removing stone, and as the work was practically the same as steam shovel work you can easily see that it was a severe test."

WOODVILLE LIME PRODUCTS Co., Toledo, O.

"The bucket is quick acting and very easy on the cables on account of the sheaves and their arrangement. The size ¾-yard which you have rated the bucket is rather under its capacity, since in the digging which it has been doing, consisting of earth, sand and boulders it fills itself up to the counterweight and practically every time digs nearly a full yard."

BAKER - DUMBAR - ALLEN COMPANY, Pittsburgh, Pa.

"Very few days we have operated it at capacity on account of material coming in slowly, and our operator has been inexperienced in using the machine. Yesterday he unloaded six cars of about 35 cubic yards each, with only one helper in the car."

BRYANT PAVING COMPANY, Readland, Ark.

The closing power increases as the shells come together. The Lakewood Clam-Shell digs down as it closes—gets all it can hold and comes up filled to overflowing.

Short cable overhaul speeds operation of bucket. Weight of counterweight can be adjusted to suit material to be handled. Upper sheaves on the closing arms give maximum digging force.

A flexible plow-steel cable is most durable on Lakewood buckets. All Lakewood buckets can be reaved with 4 or 6 part line. Working line has complete roller bearing action on rollers regardless of angle at which bucket is working.

Bigger loads mean cheaper digging. Full loads every time cut digging costs to the minimum.

Lakewood Clam-Shell Buckets are designed and built to get full loads every time.

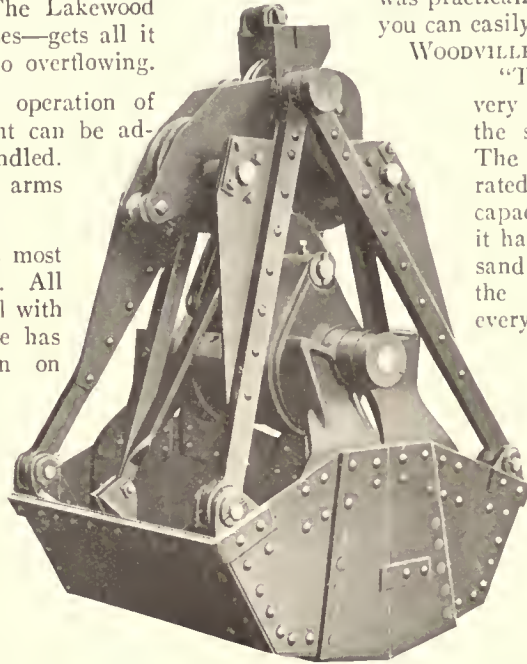

LAKEWOOD HANDLER

Size	Code	Average Load Cubic Feet	Water Level Cubic Feet	Thickness of Shells	Weight Pounds	Diameter of Sheaves	Cable Size Recommended	Amount of Cable Overhauled	Lifting Speed Per Minute	I. P. Required
½ yd.	Dado	15	10	¼" plate	2170	16"	½"	13'	100'	10 to 12
¾ yd.	Darius	22	13	¼" plate	2530	16"	½"	20'	94'	14 to 16
1 yd.	Dorcus	32	19	¾" plate	3350	12"	5"	15'	90'	18 to 20
1½ yd.	Dagon	40	27	¾" plate	3900	12"	5" or 5½"	18'	83'	20 to 22
1½ yd.	David	1½ yd. oversize		¾" plate	4550	14"	5" or 5½"	25'	71'	24 to 28

LAKEWOOD DIGGER

¾ yd.	Dab	22	13	¾" plate	2750	16"	1½"	20'	94'	14 to 16
1 yd.	Doubt	32	19	½" plate	3830	12"	5"	15'	90'	18 to 20
1 yd.	Desert	Extra Heavy		¾" plate	4300	12"	5"	15'	90'	18 to 20
1½ yd.	Daper	42	27	½" plate	4500	12"	5" or 5½"	18'	83'	20 to 22
2 yd.	Dart	59	41	½" plate	6100	14"	5" or 5½"	25'	71'	24 to 28
2½ yd.	Dean	74	54	½" plate	7100	14"	7"	27'	63'	28 to 32

OVERALL HORIZONTAL DIMENSIONS

Size	Type	Capacity	Height Open	Open	Closed	Horizontal Dim. Closed	Width
½ yd.	641	½ cu. yd.	6' 3"	5' 1"	5' 8¼"	3' 9¼"	2' 11¾"
¾ yd.	641	¾ cu. yd.	7' 1"	6' 2½"	6' 0"	3' 0"	2' 11¾"
¾ yd.	640	¾ cu. yd.	7' 1"	6' 2½"	6' 0"	3' 0"	2' 11¾"
1 yd.	640	1 cu. yd.	8' 1"	7' 0¼"	7' 1"	3' 1"	3' 1"
1 yd.	641	1 cu. yd.	8' 1"	7' 6"	7' 1"	3' 4¾"	3' 6¾"
1½ yd.	640	1½ cu. yd.	8' 1"	7' 0½"	7' 1¾"	3' 7¼"	3' 4"
1½ yd.	641	1½ cu. yd.	8' 1"	7' 0¼"	7' 1¾"	3' 7"	3' 3¾"
2 yd.	640	2 cu. yd.	8' 11¼"	8' 0½"	7' 7½"	3' 6"	3' 10¼"
2½ yd.	640	2½ cu. yd.	8' 4¾"	8' 5½"	7' 11½"	6' 10½"	4' 3½"

641 is bucket for handling; type 640 is digging bucket.

THE LAKEWOOD ENGINEERING CO., CLEVELAND, U. S. A.

For District Offices See Page 725.

BLAW CLAM SHELL BUCKETS—2 LINE TYPES

Blaw Dreadnaught Buckets

A Dreadnaught bucket will dig earth, bank sand and gravel, plastic and tough clay in the dry or under water. It is very efficient in handling granular materials, acid phosphate, broken stone, heavy ores, etc. A complete range of sizes covers all requirements for operation on derricks, cranes, monorails, dredges and special hoists.

The mechanism of the Dreadnaught is extremely

simple. It consists of unusually few parts, with the very minimum of wearing parts, all well out of the material being handled. Simple, direct rope reeving with no "S" bends or bad leads, and leading-in guide rollers at the head of the bucket makes for long life of the closing cables. All sheaves are of cast steel, bronze-bushed—with provision for easy lubrication.

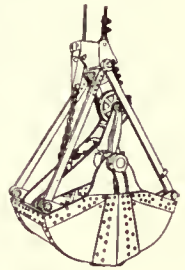

Size No. Rating, cu. yds.	610 ¾	611 ¾	615 1	616 1	620 1½	621 1½	625 2	630 2½	635 3	640 4	645 5
Scoop Capacity	22.5	30.5	30	40.7	45	61	60	75	90	120	150
Capacity	19.5	24.2	25.75	32.3	38.6	48.4	51.5	64.25	77.25	103	128.8
Line of plate	15.5	19.9	20.75	26.5	31	38.7	41.5	51.75	62.25	83	103.8
Water level	6' 10"	7' 2½"	7' 6"	7' 10"	8' 7"	9' 0"	9' 9"	10' 3"	10' 10"	11' 11"	13' 0"
Height, closed	7' 11"	8' 4"	8' 9"	9' 1"	10' 0"	10' 5"	11' 1"	11' 11"	12' 9"	13' 10"	15' 1"
Height, open	5' 6"	5' 4½"	5' 6"	5' 10"	6' 3"	6' 8½"	6' 11"	7' 6"	7' 11"	8' 8"	9' 5"
Spread, closed	5' 16"	6' 10"	6' 6"	7' 5"	7' 5"	8' 6½"	8' 3"	8' 10"	9' 4"	10' 3"	11' 2"
Spread, open	2' 11¼"	3' 1"	3' 3"	3' 4"	3' 8½"	3' 10"	4' 0¾"	4' 5"	4' 8¾"	5' 6"	5' 6¾"
Length of line to reeve open bucket—4 parts	33'	33' 3"	36'	36' 2"	41'	41' 7"	45'	49'	52'	57'	62'
Line pulled in closing	21' 6"		23' 10"	24' 6"	27' 3"	28' 4"	36' 3"	32' 6"	34' 5"	37' 10"	42'
With counterweight slug box filled—without teeth	2600	2600	3600	3400	5250	4750	6950	8450	10600	ON APPLICATION	
With counterweight slugs and with teeth	2850	2700	3720	3520	5370	4870	7100	8000	10870	ON APPLICATION	

Blaw Speedster Buckets

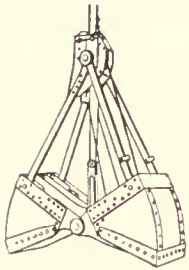

Size No.	Weight	Weight—Lbs. Average Load Picked Up	
		Sand Loose	Lump Coal
100	2675	5475	3775
105	3160	6760	4500
110	3350	7350	5000
115	4300	9700	6550
120	4650	10650	7000
125	5000	12700	8650
130	5580	13680	8780

The Speedster is a lever arm bucket especially designed for rehandling bulk materials such as coal, sand and gravel. As its name implies, it is noted for its quick and effective dumping and closing action.

It is the most highly developed of clamshell buckets embodying all modern requirements of speed, durability and maintenance. Suited to all types of hoists.

Many difficult rehandling problems can be solved with Blaw Speedster Buckets.

Blaw Power-Wheel Buckets

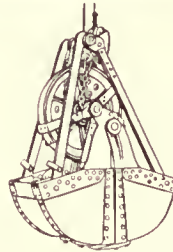

Size No.	Weight Pounds*	Rated Size Cu. Yds.	Open Height	Width
206	2290	1½	6'6½"	2'4"
211	2825	¾	7'2½"	3'5"
216	3750	1	8'4"	3'3"

* With 4 pr. c'tr. w'ts.—no teeth.

The Blaw Power Wheel Bucket is an improvement over the ordinary "bull-wheel" bucket in that the unusually large power-wheel is mounted on a shaft of its own, above the axis of the main hinge. This arrangement keeps the wheel well out of the material being handled, enables the bucket to open out wider and gives greater closing power. A variety of sizes adapted to all types of small portable cranes—suitable for all around usage on contracting work, which involves rehandling and light excavating.

Blaw Bulldog Buckets

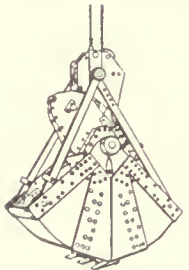

Size No.	Weight With Teeth Pounds	Usual Rated Size Cu. Yds.	Open Height	Width
500	3350	¾	7'7"	3'6"
505	3900	1	8'1"	3'3"
510	5000	1½	9'5"	3'9"
515	5800	2	10'3"	4'1"
520	13600	3	11'8"	4'8"

Data on larger sizes on request.

The Blaw Bulldog Bucket is a lever arm bucket of greater weight and greater closing power than the Speedster. It is especially adapted for use on overhead cranes, as it has exceptionally great closing power for the head room that it requires.

For work in skull cracker pits it is unequalled.

Blaw Collier Buckets

The Blaw Collier is a power-wheel bucket with a very wide scoop, intended for rehandling slack and anthracite coal. Very light for its scoop capacity, yet will pick up its rated load of run of mine, bituminous or semi-bituminous coal, culm, crushed coal, ashes, etc. This bucket is especially suitable for handling coal on mast and gaff rigs, as it requires a minimum of head room.

Size No.	W't.	Usual Rated Size	Height		Width	Spread		Line Pulled to close
			Open	Closed		Open	Closed	
250	2600	1 cu. yd.	7' 7"	5' 9"	4' 3"	6' 7"	5' 2"	15' 9"
255	3500	1½ cu. yd.	8' 9"	6' 7"	4' 9"	7' 6"	5' 10"	18'
260	4400	2 cu. yd.	9' 7"	7' 3"	5' 3"	8' 4"	6' 6"	20'
265	5300	2½ cu. yd.	10' 4"	7' 10"	5' 8"	8' 11"	7' 0"	21' 3"
270	6200	3 cu. yd.	11' 1"	8' 4"	6' 0"	9' 6"	7' 5"	22' 9"

BLAW-KNOX COMPANY, PITTSBURGH

616 FARMER'S BANK BLDG., PITTSBURGH, PA.

New York—Chicago—Boston—Baltimore—Detroit—Birmingham—San Francisco—Kansas City

BLAW CLAM SHELL BUCKETS—SINGLE LINE AND SPECIAL TYPES

Blaw Single-Line Buckets



A "hook-on" type bucket completely operated by a single hoisting drum. The yoke of the closing line can be thrown over the crane hook when the bucket is needed and it is ready for service immediately. The yoke is thrown off the hook when the bucket work is finished and the crane is ready for other uses.

Operating clearances required for various Standard "hook-on" Type buckets and other particulars are given in Tables I and III.

Table II lists standard buckets which are reeved up direct to hoist. The head-room clearance required is merely the open height of the bucket.

TABLE I.—HOOK-ON TYPE BUCKETS—GENERAL DIMENSIONS

All buckets equipped with guide sheaves at top—except "Open Head Types."

Size No.	Rated Size Cu. Yds.	Weight Pounds	Height Open	Length Open	Width	Operating Head Room* when reeved internally		DESCRIPTION OF BUCKET
						2	3	
305	1/2	2600	6' 4 1/2"	5' 0"	2' 11 1/2"	12' 8 1/2"	15' 7"	Standard Type
310	3/4	2700	7' 6"	6' 6"	3' 2"	14' 5"	18' 2"	Standard Type
310W	1	3200	7' 6"	6' 6"	4' 2 1/2"	14' 5"	18' 2"	Extra Wide Type
311	3/4	2675	6' 10"	6' 6"	3' 2"	9' 0"	12' 9"	Open Head Type
311W	1	3350	6' 10"	6' 6"	4' 2 1/2"	9' 0"	12' 9"	Op. Hd.—Ex. Wide
315	1	3700	8' 10"	7' 5"	3' 5"	16' 3"	20' 6"	Standard Type
316	1	4050	8' 10"	7' 5"	3' 5"	16' 3"	20' 6"	Ex. Heavy Scoops
325	1 1/2	4250	9' 2"	9' 2"	3' 5"	16' 7"	20' 4"	Narrow Type
320	1 1/2	5250	9' 2 3/4"	8' 0"	4' 0"	19' 4"	24' 3"	Standard Type
321	1 1/2	6100	9' 2 3/4"	8' 0"	4' 0"	19' 4"	24' 3"	Ex. Heavy Scoops
323	1 3/4	5600	9' 4 3/4"	8' 0"	4' 0"	11' 7"	16' 6"	Open Head Type
327	1 3/4	5900	9' 2 3/4"	8' 0"	4' 0"	7' 1/2"	19' 4"	Standard Type
328	2	10500	10' 10"	9' 0"	4' 8"	21' 3"	26' 0"	Ex. Heavy Scoops
330	1 3/4	6400	8' 4 3/4"	8' 0"	4' 7 1/2"	11' 7"	16' 6"	Open Head Type
333	2	9200	10' 10"	9' 6"	4' 8"	21' 3"	26' 0"	Standard.

TABLE II.—BUCKETS FOR REEVING DIRECT TO HOIST—EQUIPPED WITH TAIL SHEAVES

Size No.	Rated Size Cu Yds.	Weight lbs.	Height		Width	Spread		Description of Bucket
			Open	Closed		Open	Closed	
304	1/2	2100	5' 10"	5' 4"	3' 5"	4' 6"	4' 0"	Bridge type
307	1/2	2100	6' 4 1/2"	5' 9"	3' 11 1/2"	5' 0"	4' 1 1/2"	Cableway type
308	1/2	2000	6' 4 1/2"	5' 9"	3' 11 1/2"	5' 0"	4' 1 1/2"	Standard type
312	3/4	2850	7' 6"	7' 1"	3' 2"	6' 6"	4' 8"	Standard type
312W	1	3350	7' 6"	7' 1"	4' 2 1/2"	6' 6"	4' 8"	Extra wide
313	3/4	2950	7' 6"	7' 1"	3' 2"	6' 6"	4' 8"	Cableway type
313W	1	3450	7' 6"	7' 1"	4' 2 1/2"	6' 6"	4' 8"	Extra wide
314	3/4	2900	6' 8 1/2"	6' 1 1/2"	3' 11"	5' 2"	4' 7 1/2"	Bridge type
317	1	3800	8' 10"	8' 0"	3' 5"	7' 5"	5' 7"	Standard type
318	1	4250	8' 10"	8' 0"	3' 5"	7' 5"	5' 7"	Ex. hvy scoops
326	1 1/2	4470	9' 2"	8' 6"	3' 5"	9' 2"	6' 10"	Narrow type
322	1 1/2	5300	9' 2 3/4"	8' 3 3/4"	4' 0"	8' 0"	5' 10 1/2"	Standard type
324	1 1/2	6200	9' 2 3/4"	8' 3 3/4"	4' 0"	8' 0"	5' 10 1/2"	Ex. hvy. scoops
329	1 3/4	6600	9' 2 3/4"	8' 3 3/4"	4' 0"	7 1/2"	8' 0"	Standard type
332	2	9300	10' 10"	10' 0"	4' 8"	9' 0"	7' 1"	High power

TABLE III.—SCOOP CAPACITY AND APPROXIMATE QUANTITY MATERIAL PICKED UP AT EACH GRAB

Bucket size No.	Scoop capacity Cubic feet			Cubic Feet Picked Up—Bucket Reeved			
	Heaped	Line of Plate	Water Level	2 Parts	3 Parts	Lump Sand	Lump Coal
304	18.3	15.5	11.7	16	13	-	-
305, 307, 308	18.	15.5	12.75	14	10	21	14
310, 311, 312, 313	27	21	17	21	16	27	21
310W, 311W, 312W, 313W	36	28	23	28	21	34	28
314	27.5	21.5	17.5	24	20	-	-
315, 317	36	36	18.5	30	22	36	28
316, 318	36	36	18.5	36	23	36	33
320, 322, 323	40	42	34	40	33	46	45
321, 324	46	42	34	46	38	46	45
325, 326	54	54	28	34	26	42	33
327, 328, 329	54	49	40	47	39	54	49
330, 332	85	85	43	76	62	86	77
333	86	85	43	64	54	72	70

Blaw Foundry Type Single-Line Buckets

The foundry bucket is a single line "hook-on" bucket requiring a minimum of head room. The closing power is sufficient to enable it to pick up its rated capacity in molders' sand.

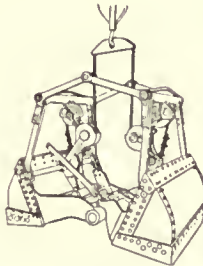

Size No.	Rated Size Cu. Yds.	Weight Pounds	Length Open	Width	Operating Head Room Needed
309F	3/4	3600	6' 2"	4' 11"	6' 11"
319F	1 1/4	5000	7' 3"	5' 9"	8' 1"
329F	2	6800	8' 6"	6' 9"	9' 6"
339F	3	9200	9' 9"	7' 9"	10' 8"
349F	4	11600	10' 8"	8' 6"	11' 8"

Four-Line and Special Buckets

Blaw-Knox Company manufactures four-line buckets in sizes up to 8 cu. yd. capacity—the leads can be arranged to meet almost any conditions required by a crane or trolley.

SPECIAL BUCKETS are also designed and built for individual requirements, where the hoisting equipment or the work required does not permit the use of a standard bucket.

Blaw Automatic Single Rope Cableways

Blaw Automatic Single Rope Cableways furnished for operating Blaw Single Line Buckets or with special Hook Block for handling skips, dump buckets, etc.—operated entirely by a single drum non-reversing hoist on spans up to 500'—digging, hoisting, transporting and dumping under the control of the operator at all times.

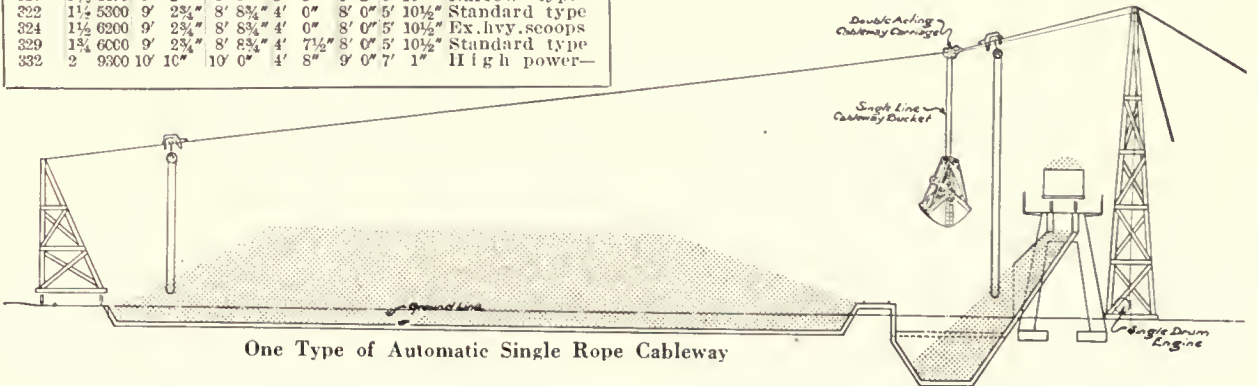

One Type of Automatic Single Rope Cableway

BLAW-KNOX COMPANY, PITTSBURGH

616 FARMER'S BANK BLDG., PITTSBURGH, PA.

New York—Chicago—Boston—Baltimore—Detroit—Birmingham—San Francisco—Kansas City

General Information

The G. H. Williams Company manufactures a complete line of grab buckets for dredging or excavating, and for the rehandling of bulk materials, such as coal, ore, coke, sand

gravel, crushed stone, and rock.

Years of experience and specialized study insure to their customers the selection of buckets suitable for their requirements. Wherever standard equipment will not serve the purpose, buckets of special design can be furnished promptly.



Williams "Favorite" Bucket.

Design and Construction

Williams buckets are so designed and constructed as to embody great digging power, speed and economy in operation, and durability. Application of the lever principle,

which furnishes the closing power directly to the scoops, together with triangular principle, requires few parts and insures rigidity and perfect alignment, while



Williams "Hercules" Bucket.

long life is secured by the use of large bearings and massive construction, which is entirely of steel.

The "Favorite" Bucket

The "Favorite" Bucket is an all around contractor's and material handler's bucket. It is operated by a four-part closing line applied to power arm or lever, which enables it to handle

economically and efficiently coal, ore, sand, gravel, crushed stone, and like bulk material; and when fitted with teeth, it will do excavating and dredging, where

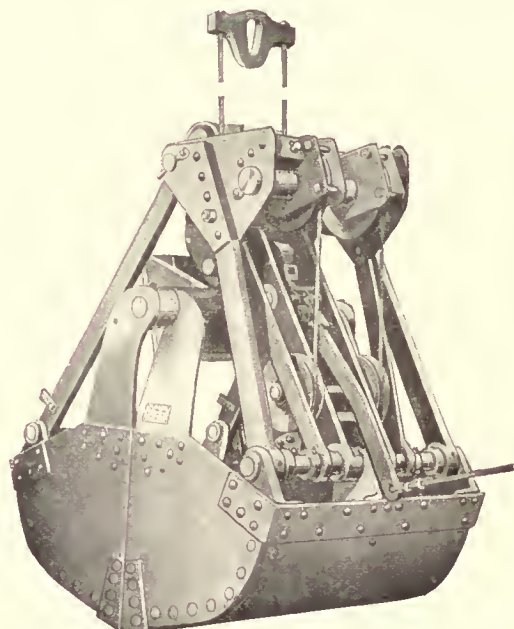

Williams No. 3 Single Hook Foundry Bucket.

the work is not of the most severe nature. See the "Hercules" and special dredging buckets for this class of work.

The "Hercules" Bucket

This bucket is built for severe conditions and will handle hardpan, loose rock, compact gravel, boulders, and clay. It has a four-part closing line which gives it extra digging

power, and together with its heavy construction enables Bucket to dig and operate under the severest conditions. Each scoop of this bucket is made of one heavy plate bent to shape, and is fitted with steel lip having chamfered cutting edge. High carbon steel teeth to be bolted or riveted in place are provided. By unbolting, the teeth may be removed to make the bucket available for ordinary rehandling from flat cars or boats.

No. 3 Single Hook Foundry Bucket

The No. 3 Bucket is built to meet the needs of foundries, steel mills, and power plants in handling with economy, sand, coal, ashes, roll scale, slag, mill cinders, or similar material.

This bucket may be used on any crane or derrick, especially where the distance between the hoist block and the ground is limited. In rigging the bucket the hook of the hoist block is slipped into the holding yoke of the bucket. The outfit is then ready for use.

SAUERMAN DRAGLINE CABLEWAY EXCAVATORS

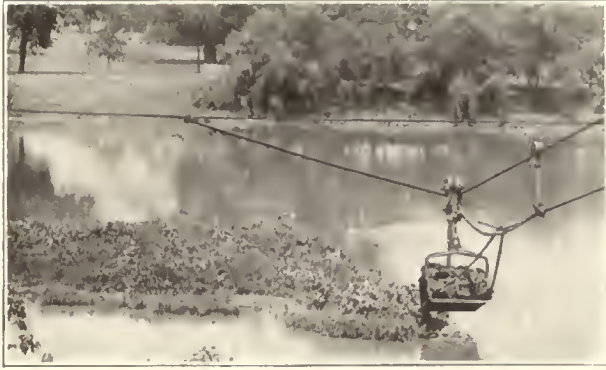

Removing Silt Deposits from Intake Channel.



Excavating Gravel from Under Water and Conveying to Screening Plant.

Advantages of Sauerman Type of Cableways

Due to its ability to span a distance of 200 to 800 feet or more and dig, convey, elevate and dump in a continuous movement under control of one operator, a Sauerman Dragline

Cableway Excavator will serve as complete excavating and conveying equipment for the average gravel-mining, dirt-moving or clay-handling proposition. By acting as a combined digger and conveyor, it handles material at a lower cost per ton than other types of excavators requiring an auxiliary conveying system.

Adapted to Wide Range of Uses

While Sauerman Dragline Cableway Excavators are best known for their economical service as the standard excavating and conveying equipment for commercial sand and gravel

plants, they have also been found suitable for a variety of other uses. The different material-handling work successfully handled by these excavating cableways is as follows:

Excavating sand and gravel. Loading ballast from pit to cars. Building levees and embankments. Making reservoirs. Digging tail-race and placing ballast in cribbing of dam. Removing earth dams, sand bars and

islands. Cleaning out intake channel supplying boiler water to power plant. Backfilling retaining walls. Removing silt and debris from log-ponds. Cleaning and enlarging reservoirs. Deepening and widening rivers. Mining placer gold. Taking marl from lake bottoms. Stripping overburden from clay beds and stone quarries. Reclaiming tailings, ore or coal from storage piles. Excavating peat and humus. Gathering clay for brick and tile plants. Digging hard materials.

Sauerman Engineering Service

We invite everybody who has a proposition similar to any listed above to avail themselves of the expert suggestions of our engineers. You will also profit by sending for our printed matter. Pamphlets Nos. 12 and 14 describe installations for mining gravel; Pamphlet No. 15 for handling clay and sticky materials.

If your problem pertains to the storage or rehandling of coal it will be turned over to a separate engineering staff. Sauerman equipment for coal-handling is of special design and one of the important items is a patented type of power drag scraper. For description of this equipment, send for our Pamphlet No. 11.



Loading Concrete Aggregate from Pit to Trucks.

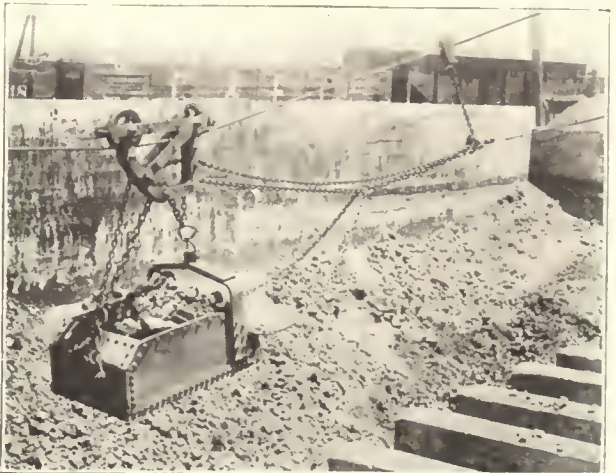

Reclaiming Coal from Storage Pit.

SAUERMAN BROS., 330 S. DEARBORN ST., CHICAGO, ILL.

WIRE ROPE AND FITTINGS

Sales Offices and Warehouses

The American Steel & Wire Company manufactures wire rope for all purposes and carries a full line of wire rope fittings and accessories, such as thimbles, clips, clamps, sockets, hooks, turnbuckles, shackles, sheaves, etc. It also manufactures aerial tramways, supplying the supporting and transporting equipment as well as the cable, and maintains engineering bureaus to advise and assist in solving hoisting and transmission problems. Its sales offices and warehouses are located in the following cities:

SALES OFFICES

Chicago.....	208 So. La Salle Street
New York.....	30 Church Street
Worcester.....	94 Grove Street
Boston.....	120 Franklin Street
Cleveland.....	Western Reserve Building
Pittsburgh.....	Frick Building
Buffalo.....	337 Washington Street
Detroit.....	Foot of First Street
Philadelphia.....	Widener Building
Baltimore.....	32 So. Charles Street
Wilkesbarre, Pa.....	Miners Bank Building
Cincinnati.....	Union Trust Building
Oklahoma City.....	First National Bank Building
St. Louis.....	Liberty Central Trust Company Building
St. Paul, Minn.....	Pioneer Building
Kansas City.....	417 Grand Avenue
Denver.....	First National Bank Building
Salt Lake City.....	Walker Bank Building

EXPORT DEPARTMENT

The United States Steel Products Company	
New York City	Portland, Ore
Seattle, Wash.	Los Angeles, Calif.

WAREHOUSES

Baltimore, Md.	Los Angeles, Calif.	San Francisco, Calif.
Buffalo, N. Y.	New Haven, Conn.	Savannah, Ga.
Birmingham, Ala.	New Orleans, La.	Seattle, Wash.
Chicago, Ill.	New York, N. Y.	St. Louis, Mo.
Cleveland, Ohio	Philadelphia, Pa.	Trenton, N. J.
Denver, Colo.	Pittsburgh, Pa.	Worcester, Mass.
Detroit, Mich.	Portland, Ore.	
Kansas City, Mo.	Salt Lake City, Utah	

Grade of American Wire Rope

The American wire rope is carried in established sizes and designs, and for material handling purposes, is made in the following grades:

Swede Iron—A soft and ductile material having a tensile strength of approximately 85,000 lbs. per sq. in. For wire rope manufacture it has been largely superseded by steel but is still generally used for elevator hoisting. For this purpose it is amply strong.

Crucible Cast Steel—A material now made by the open hearth process, which has a tensile strength ranging from 150,000 to 200,000 lbs. per sq. in. It is tough and pliable and aside from having about twice the strength of iron is harder and more resistant to wear. These properties, together with a moderate cost, have given it a general use for all material handling purposes of moderate severity.

Extra Strong Crucible Steel—A material of like manufacture, but somewhat stronger than crucible steel, and tougher. Its tensile strength is 180,000 to 220,000 lbs. per sq. in.

Plow Steel—A high grade open hearth steel having a tensile strength ranging from 229,000 to 260,000 lbs. per sq. in. It is somewhat less flexible than crucible steel but combines lightness with great strength and as such is largely used for heavy mine hoist-

ing, on derrick dredges, incline cable ways, etc., being particularly an economical material where the weight of rope is an important item or where it may be desired to increase the loading without enlarging sheaves and drums.

Monitor Plow Steel—A material having a tensile strength ranging from 220,000 to 280,000 lbs. per sq. in. and especially resistant to abrasion. Size for size it is somewhat less flexible than the other steels but equally flexible with sections having equal strength.

Transmission and Haulage Rope

Transmission and Haulage rope derives its name from the comparatively large size and small number of wires composing it. This construction detracts from the flexibility of the rope but presents an increased resistance to abrasion and corrosion. For this reason it is particularly adapted for use where the abrasion is severe and the element of flexibility of minor importance as in mine haulage work, gravity hoist systems and coal and ore dock haulage road operating grip cars, also in well drilling. The American Steel & Wire Company makes two types of this wire. The Standard Transmission and Haulage rope is composed of 6 strands of 7 wires each, laid on a hemp core, the individual wires in each strand being wound in the opposite direction to that of the strand on the rope. The Flattened Transmission and Haulage rope, of which there are three styles, is composed of flattened strands made up of a combination of different sized wires, both individual wires and strands being wound in the same direction. This type of rope presents about 150 per cent more wearing surface than the round strand rope.

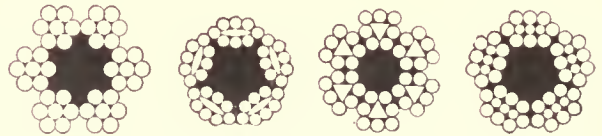

Standard Haulage

Type C Flattened Haulage Rope

Type D Flattened Haulage Rope

Type E Flattened Haulage Rope

STANDARD TRANSMISSION AND HAULAGE ROPE—6 STRANDS, 7 WIRES EACH—HEMP CORE

Diameter in Inches	Approximate Weight, Lbs. per Foot	Crucible Cast Steel		Extra Heavy Crucible Steel		Plow Steel		Monitor Plow Steel	
		Proper Working Load in Tonst	Min. Dia. Sheaves or Drum, in Feet Advised	Proper Working Load in Tonst	Min. Dia. Sheaves or Drum, in Feet Advised	Proper Working Load in Tonst	Min. Dia. Sheaves or Drum, in Feet Advised	Proper Working Load in Tonst	Min. Dia. Sheaves or Drum, in Feet Advised
1 1/2	3.55	12.6	11	14.6	11	16.4	11	18	11
1 3/8	3	10.6	10	12.6	10	14.4	10	16	10
1 1/4	2.45	9.2	9	10.8	9	12	9	13	9
1 1/8	2	7.4	8	8.6	8	9.4	8	10	8
1	1.58	6.2	7	7.6	7	7.6	7	8.4	7
3/4	1.20	4.8	6	5.6	6	6.2	6	6.6	6
5/8	.89	3.7	5	4.2	5	4.6	5	5	5
7/8	.75	3.1	4 3/4	3.3	4 3/4	3.6	4 3/4	4	4 3/4
1 1/8	.62	2.6	4 1/2	2.9	4 1/2	3.2	4 1/2	3.5	4 1/2
1 1/4	.50	2.2	4	2.2	4	2.4	4	2.6	4
1 1/2	.39	1.5	3 1/2	1.8	3 1/2	2	3 1/2	2.2	3 1/2
1 3/8	.30	1.1	3	1.25	3	1.4	3	1.5	3
1 1/4	.22	.92	2 3/4	1.05	2 3/4	1.2	2 3/4	1.3	2 3/4
1 1/8	.15	.70	2 1/4	.79	2 1/4	.88	2 1/4		
3/4	.12 1/2	.50	1 3/4	.59	1 3/4	.68	1 3/4		

†Based on a factor of safety of 5.

AMERICAN STEEL & WIRE COMPANY

For List of Offices See Above.

HOISTING AND HAULAGE WIRE ROPE

FLATTENED STRAND HAULAGE OR TRANSMISSION ROPE

Diameter in Inches	Crucible Steel					Extra Strong Crucible Steel					Monitor Plow Steel				
	Type C		Types D and E			Type C		Types D and E			Type C		Types D and E		
	Working Load in Tonst	Approx. Wt. per Foot in Pounds	Working Load in Tonst	Approx. Wt. per Foot in Pounds	Minimum Dia. Sheave or Drum in Ft. Advised	Working Load in Tonst	Approx. Wt. per Foot in Pounds	Working Load in Tonst	Approx. Wt. per Foot in Pounds	Minimum Dia. Sheave or Drum in Ft. Advised	Working Load in Tonst	Approx. Wt. per Foot in Pounds	Working Load in Tonst	Approx. Wt. per Foot in Pounds	Minimum Dia. Sheave or Drum in Ft. Advised
1½	12.6	3.65	13.6	4.00	8½	14.6	3.65	15.8	4.00	8½
1¾	10.6	3.10	11.4	3.45	8	12.6	3.10	13.6	3.45	8
1½	9.2	2.55	10	2.80	7½	10.8	2.55	11.6	2.80	7½	13.4	2.55	14.6	2.80	9½
1¼	7.4	2.05	8	2.30	6¾	8.6	2.05	9.2	2.30	6¾	10.4	2.05	11.2	2.30	8¾
1	6.2	1.65	6.8	1.80	5¾	7.0	1.65	7.6	1.80	5¾	8.4	1.65	9.2	1.80	6¾
¾	4.8	1.24	5.2	1.38	5	5.6	1.24	6.0	1.38	5	6.6	1.24	7.2	1.38	6
¾	3.72	.92	4	1.00	4½	4.2	.92	4.54	1.00	4½	5.0	.92	5.4	1.00	5½
¾	2.6	.64	2.8	.72	3½	2.9	.64	3.14	.72	3½	3.5	.64	3.8	.72	4½
½	1.54	.40	1.66	.45	2½	1.77	.40	1.92	.45	2½	2.2	.40	2.38	.45	3½
½	.92	.23	1.00	.25	2	1.05	.23	1.14	.25	2

†Based on factor of safety of 5.

HOISTING ROPE DATA

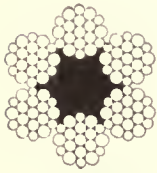

Standard Rope

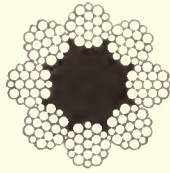

Extra Flexible

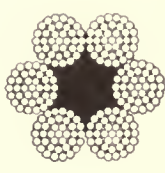

Special Flexible

Hoisting Rope

Several different types of rope are made for hoisting purposes. The Standard Rope is composed of 6 strands of 19 wires, regular lay. The iron grade of

this rope is regularly used for elevator counterweight ropes, while the other grades have a general application to hoisting work, logging, dredging and skipping, cable ways, conveyors, etc. Extra Flexible Steel Hoisting Rope is composed of 8 strands of 19 wires. This rope, having a greater flexibility than the Standard Rope, is better adapted for use over the comparatively small sheaves and drums of derricks. Special Flexible Hoisting Rope is composed of 6 strands of 37 wires. It has even greater flexibility than the Extra Flexible Rope and is particularly adapted for use on cranes, etc.

Flattened Strand Hoisting Rope is composed of a combination of different sized wires forming a flattened strand of the Lang's lay. This type of rope corresponds in flexibility with the Standard hoisting rope and presents a great deal more wearing surface.

Steel Clad Hoisting Rope is made in three styles, each style being constructed similarly to the Extra Flexible Steel, Special Flexible, and Extra Special Flexible hoisting rope, respectively, excepting that each strand is enclosed in a casing consisting of strips of steel wound spirally around it. Where the conditions are suited to its use this rope is capable of a much more extended life by reason of this protection, often 50 to 150 per cent.

Non-Spinning Hoisting Rope is composed of an inner layer of 6 strands of 7 wires Lang's lay and an outer layer of 12 strands of 7 wires regular lay. By reason of this construction a free load on the rope suspended on the end of a single line of the rope is prevented from rotating.

Diameter in Inches	Approximate Wt., per Foot in Lbs.	Iron		Crucible Steel		Extra Strong*		Plow Steel*		Monitor Steel*	
		Proper Working Load in Tonst	Min. Dia. Sheave or Drum, in Feet Advised	Proper Working Load in Tonst	Min. Dia. Sheave or Drum, in Feet Advised	Proper Working Load in Tonst	Min. Dia. Sheave or Drum, in Feet Advised	Proper Working Load in Tonst	Min. Dia. Sheave or Drum, in Feet Advised	Proper Working Load in Tonst	Min. Dia. Sheave or Drum, in Feet Advised

STANDARD ROPE—6 STRANDS, 19 WIRES EACH HEMP CORE

2¼	11.95	22.2	12	42.2	11	48.6	55	63
2½	9.85	18.4	15	34	10	40	46	53
2¾	8	14.4	14	26.6	9	32	37	42
3	6.3	11	12	21.2	8	24.6	28	33
1¾	5.55	10	12	19	8	22.4	25	30
1¾	4.85	8.8	11	17	7	19.8	22	27
1¾	4.15	7.6	10	14.4	6.5	16.6	19	22
1½	3.55	6.6	9	12.8	6	14.6	16	20
1½	3	5.6	8.5	11.2	5.5	12.8	14	17
1¼	2.45	4.56	7.5	9.4	5	10.6	12	14
1¼	2	3.72	7	7.6	4.5	8.6	9.4	11
1	1.58	2.9	6	6	4	6.8	7.6	9
¾	1.2	2.36	5.5	4.6	3.5	5.2	5.8	7
¾	.89	1.7	4.5	3.5	3	4.04	4.6	5.3
¾	.62	1.2	4	2.5	2.5	2.8	3.1	3.8
½	.5	.94	3.5	2	2.25	2.24	2.4	2.9
½	.39	.78	3	1.68	2	1.84	2	2.4
½	.3	.58	2.75	1.30	1.75	1.45	1.6	1.9
½	.22	.48	2.25	.96	1.50	1.06	1.15	1.35
½	.15	.3	2	.62	1.25	.7	.76	.9
¼	.1	.22	1.5	.44	1	.49	.53	.63

†Based on factor of safety of 5.
*For Sheave diameter see Crucible Steel.

EXTRA FLEXIBLE ROPE—8 STRANDS, 19 WIRES EACH HEMP CORE

1½	3.19	11.6	3.75	13	14.8	16
1¾	2.7	10.2	3.5	11	12.8	13
1¾	2.2	8.4	3.2	9.4	10.4	11
1¾	1.8	6.8	2.83	7.6	8.6	9.2
1	1.42	3.1	6	5.2	2.5	5.9	6.6	7.2
¾	1.08	2.6	5½	4	2.16	4.6	5.2	5.6
¾	.8	1.9	4½	3.06	1.83	3.5	4	4.4
¾	.56	1.4	4	2.18	1.75	2.5	2.8	3
½	.45	1.2	3½	1.74	1.51	2	2.32	2.4
½	.35	1	3	1.46	1.33	1.6	1.74	1.9
¾	.27	1.14	1.16	1.26	1.38
¾	.284	1	.93	1.02
¾	.1355	.83	.61	.67
¾	.0936	.75	.40	.45

SPECIAL FLEXIBLE ROPE—6 STRANDS, 37 WIRES EACH HEMP CORE

2¼	11.95	40	47	53	55
2½	9.85	32	37	43	45
2¾	8	25	30	35	37
3	6.3	21	23	26	27
1¾	5.55	18.8	21.2	23.8	25
1¾	4.85	17	19	22	23
1¾	4.15	14	16	18	19
1½	3.55	12	3.75	14	16	17
1½	3	11	3.5	12	14	14
1¼	2.5	9	3.20	10	11	11
1¼	2	7	2.83	8	9	9.2
1	1.58	6	2.5	6.4	7	7.4
¾	1.2	5	2.16	5	5	5.8
¾	.89	3.5	1.83	3.8	4	4.6
¾	.62	2.3	1.75	2.5	3	3.2
½	.5	1.9	1.5	2.1	2.3	2.5
½	.39	1.45	1.33	1.65	1.85	1.9
½	.3	1.1	1.16	1.27	1.4	1.5
¼	.2284	1	.93	1	1.06

HOISTING ROPE AND AERIAL TRAMWAY CABLE

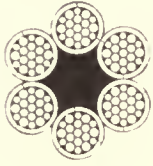

Steel Clad

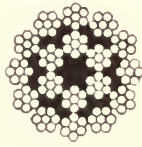

Non-Spinning

Track Cable
for
Aerial Tramway

The American Steel & Wire Company makes three kinds of cable for use as track in aerial tramway systems. Of these the Locked Wire and Locked Coil Cable are similar in that the outer wires interlock with each other forming a smooth surface. They differ in the number of wires composing them, the Locked Coil Cable having fewer and larger wires. It possesses sufficient flexibility, however, to allow shipment in 5 or 6 ft. coils. The smooth coil cable is adapted for conditions requiring

HOISTING ROPE DATA

Diameter in Inches	Approx. Weight per Ft. in Lbs.	Min. Diameter Sheave or Drum in Feet Advised	Proper Working Load in Tons on Factor of Safety 5				
			Iron	Crucible Steel	Extra Heavy Crucible Steel	Plow Steel	Monitor Plow Steel
2 1/4	8.45	8	21.2	24.6	28	33	
2	6.7	7.5	19.2	22.4	25	30	
1 3/4	6.02	7	17.0	19.8	22	27	
1 1/2	5.25	6.5	14.4	16.6	19	22	
1 1/4	4.62	6	12.8	14.6	16	20	
1 1/2	3.95	5.5	11.2	12.8	14	17	
1 1/4	3.3	5	9.4	10.6	12	14	
1 1/2	2.8	4.5	7.6	8.6	9.4	11	
1 1/4	2.12	4	6.0	6.80	7.6	9	
1 1/2	1.72	3.5	4.6	5.20	5.8	7	
1	1.3	3	3.5	4.04	4.6	5.3	
3/4	1	2.5	2.5	2.80	3.1	3.8	
5/8	.7	2	1.68	1.84	2.0	2.4	

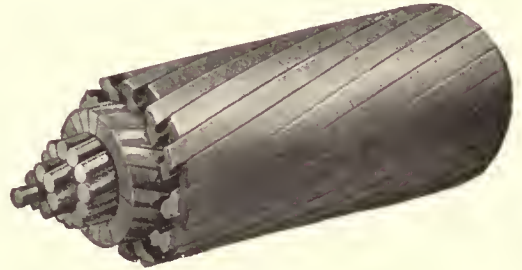

Locked Coil Tramway Cable.

NON-SPINNING- 18 STRANDS, 7 WIRES EACH HEMP CORE

Diameter in Inches	Approx. Weight per Ft. in Lbs.	Min. Diameter Sheave or Drum in Feet Advised	Iron	Crucible Steel	Extra Heavy Crucible Steel	Plow Steel	Monitor Plow Steel
1 1/4	5.5	7	9.1	17.1	20.2	22.3	24.04
1 1/2	4.9	6.5	7.9	14.8	17.5	19.2	21.1
1 3/4	4.32	6	6.8	12.7	15.0	16.5	18.1
1 1/2	3.6	5.5	5.6	10.4	12.4	13.7	15.5
1 1/4	2.8	5	4.6	8.7	10.3	11.3	12.5
1 1/2	2.34	4.5	3.9	7.3	8.6	9.5	10.4
1 1/4	1.73	4	2.9	5.6	6.6	7.2	7.8
1 1/2	1.44	3.5	2.3	4.5	5.3	6.3	7.0
1 1/4	1.02	3	1.7	3.3	3.9	4.9	5.4
3/4	.70	2.50	1.1	2.2	2.6	3.1	3.4
5/8	.57	2.25	.97	1.8	2.1	2.5	2.8
1/2	.42	2	.73	1.3	1.6	1.9	2.1
3/4	.31	1.75	.52	.98	1.1	1.3	1.5
5/8	.25	1.5	.42	.78	.92	1.1	1.2

CABLE FOR AERIAL TRAMWAYS

Diameter in Inches	Locked Coil Type		Locked Wire Type		Smooth Coil Type		
	Lbs. Weight per Lineal Foot	Breaking Load in Tons	Lbs. Weight per Lineal Foot	Breaking Load in Tons	Lbs. Weight per Lineal Foot	Crucible Steel Breaking Load in Tons	Plow Steel Breaking Load in Tons
2 1/4	15.60	240	13.1	285.0	335.0
2 1/4	12.50	190	10.3	233.0	266.0
2 1/4	10.00	160	9.35	204.0	240.0
2	7.65	120	8.40	185.0	218.0
1 3/4	6.60	103	7.28	161.0	189.0
1 3/4	5.70	89	6.59	145.0	171.0
1 3/4	6.30	103	4.75	75	5.63	124.0	146.0
1 1/2	5.30	89	3.80	62	4.88	108.4	127.5
1 1/2	4.40	75	3.15	50	4.01	88.8	105.0
1 1/2	3.20	62	2.50	40	3.23	71.8	84.6
1 1/4	3.00	50	1.88	30	2.70	60.0	70.7
1	2.35	40	1.30	22	2.20	49.2	58.0
3/4	1.80	30	.90	15.5	1.69	37.6	44.4
5/872	12.5	1.24	27.6	32.5
5/857	10	8.6	19.2	22.3

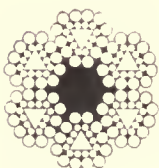

Type A

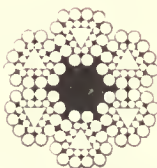

Type B

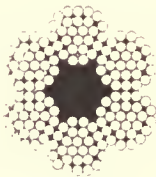

Type H

FLATTENED STRAND HOISTING ROPE

Diameter in Inches	Crucible Cast Steel					Extra Strong Crucible Steel					Monitor Plow Steel				
	Type A		Types B and H			Type A		Types B and H			Type A		Types B and H		
	Proper Working Load in Tonst	Lbs. Weight per Lineal Foot	Proper Working Load in Tonst	Lbs. Weight per Lineal Foot	Min. Diameter Sheaves or Drums in Ft. Advised	Proper Working Load in Tonst	Lbs. Weight per Lineal Foot	Proper Working Load in Tonst	Lbs. Weight per Foot	Min. Diameter Sheaves or Drums in Ft. Advised	Proper Working Load in Tonst	Lbs. Weight per Lineal Foot	Proper Working Load in Tonst	Lbs. Weight per Lineal Foot	Min. Diameter Sheaves or Drums in Ft. Advised
2 1/4	26.6	8.00	29.2	9.20	8 1/2	32	8.00	35.2	9.20	8 1/2	42	8.00	46.2	9.20	12
2	21.2	6.30	23.4	7.25	8	24.6	6.30	27	7.25	8	33.2	6.30	36.6	7.25	11
1 3/4	17.0	4.85	18.8	5.60	7 1/4	19.8	4.85	21.8	5.60	7 1/4	26.6	4.85	29.2	5.60	9
1 3/4	14.4	4.15	15.8	4.75	6 3/4	16.6	4.15	18.2	4.75	6 3/4	22	4.15	24.2	4.75	8 1/2
1 1/2	12.8	3.55	14.0	4.00	5 3/4	14.6	3.55	16	4.00	5 3/4	19.6	3.55	21.6	4.00	8
1 1/2	11.2	3.00	12.4	3.45	5 1/2	12.8	3.00	14	3.45	5 1/2	16.8	3.00	18.4	3.45	7 1/2
1 1/4	9.4	2.45	10.4	2.80	5	10.6	2.45	11.6	2.80	5	13.8	2.45	15.2	2.80	7
1 1/4	7.6	2.00	8.4	2.30	4 1/2	8.6	2.00	9.4	2.30	4 1/2	11.2	2.00	12.4	2.30	6
1 1/2	6.0	1.58	6.6	1.80	4	6.8	1.58	7.4	1.80	4	9	1.58	10.0	1.80	5
3/4	4.6	1.20	5.0	1.38	3 1/2	5.2	1.20	5.8	1.38	3 1/2	7	1.20	7.8	1.38	4 1/2
5/8	3.5	.89	3.86	1.00	3	4.04	.89	4.44	1.00	3	5.26	.89	5.8	1.00	4
1/2	2.5	.62	2.76	.72	2 1/4	2.80	.62	3.08	.72	2 1/4	3.8	.62	4.2	.72	3 1/2
3/4	1.8	.50	2.2	.58	1 3/4	2.24	.50	2.46	.58	1 3/4	2.9	.50	3.2	.58	3
5/8	1.68	.39	1.86	.45	1 1/2	1.84	.39	2.02	.45	1 1/2	2.42	.39	2.7	.45	2 1/4

†Based on factor of safety of 5.

AERIAL TRAMWAYS

The Trenton System

The American Steel & Wire Company manufactures two standardized designs of aerial tramways and is prepared to design such special equipment as may be required to meet unusual conditions of operation or location. Of its two systems, the Trenton is the principal one, thus far over 3,000 of these systems, representing over 1,800 miles of line and an annual



Trenton Aerial Tramway Transporting Slate in Mountains.

capacity of about 200 million tons, having been built. This is a system comprising two stationary cables, one of lighter weight than the other, from which a series of detachable buckets or other carrying devices are suspended and along which they are moved in a continuous circuit by an endless and comparatively light weight traction rope, the loads travelling along the heavier cable and the empties returning by way of the lighter one.

It is primarily a system for long haul between stations and as such finds its widest application in mountainous localities as a means of transporting material to and from mines, quarries, etc.; one of these lines, the largest on record and a system carrying 40 tons of ore hourly, extending a distance of 21 miles, during which it makes a descent of 11,000 feet and spans distances in excess of half a mile. The system is not limited to this application however, and is being extensively used in various parts of this and foreign countries over comparatively level stretches, around industrial sites, docks, etc. As a system of transportation it is capable of handling capacities up to 200 tons per hour at an operating cost per mile of from 2 to 5 cents per ton. It permits a speed of operation of from 5 to 6 miles per hour and accommodates a program of loading and unloading the carriers at other points than the terminals. It can be operated around angles without manual assistance and up steep slopes without difficulty.

The track cables used are the Locked Wire or Locked Coil types as described in the preceding pages. The traction rope is a special six strand

wire rope with a hemp core. The buckets, where buckets are used, may be self-dumping or both self-dumping and righting, the dumping in either case being effected automatically by a tripping bar attached to the track cable or station rail. The tramway stations occur at the terminals and at breaks in the direction of the line or at other points where it is desired to load or unload buckets, the carriers upon arriving at these stations being detached automatically from the cable and shunted to overhead rails, after which they may be moved to various points, detached from the hangers, or even switched on other tramway lines. Once loaded or unloaded, as the case may be, they are again attached to the traction rope for movement to other points.

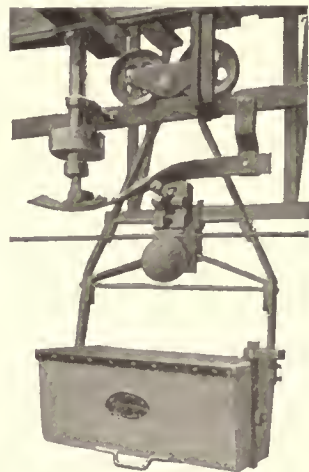

Self Dumping Bucket.

Reversible Systems

Where the length of haul is comparatively short and the work of a light nature it often happens that materials can be handled satisfactorily and at less expense for the initial installation by a reversible tramway system whereby one or more buckets are carried on separate lines and propelled back and forth for load-



Trenton Aerial Tramway on Dock Haulage Work.

ing and unloading by reversing the traction rope. For such conditions the American Steel & Wire Company manufactures the Single and the Double-Cable Reversible Tramways, the Double-Cable system consisting of two cable tracks each supporting a bucket, the one returning empty while the other is moving out loaded. These systems are usually provided with self-dumping buckets capable of carrying a ton each and similarly to the carriers of the Trenton systems, may be designed for shunting the track cable at station. With them materials may occasionally be handled up to amounts of 25 tons per hour.

AMERICAN STEEL & WIRE COMPANY

For List of Offices See Page 818

LESCHEN WIRE ROPE FOR MATERIAL HANDLING

Standard of Quality

Wire Rope is a highly important part of all material handling systems on which it is used, for the actual working efficiency of the entire equipment is no greater than the efficiency of its wire rope.

The standard for every grade of Leschen Wire Rope is exceptionally high, and strength alone is not the controlling factor, for there are also exacting requirements as to flexibility, elasticity and toughness.



Fig. 1. This is the standard Round Strand hoisting construction. Its use is quite general on conveying machinery, cranes, cableways, derricks, elevators, grab buckets, mine hoists, steam shovels, etc.

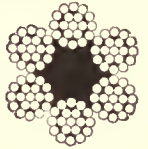

Fig. 1

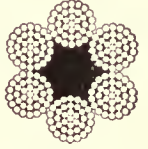

Fig. 2

Kinds of Material

Leschen Wire Rope for material handling is furnished in the following grades: Hercules Wire Rope, Special Steel, Cast Steel and Plow Steel, the particular grade recommended depending upon the equipment and requirements of the work.

"Hercules"

(Reg. U. S. Pat. Off.)

This is a rope of the very highest quality in material, design and workmanship. It is the best that can be bought for any price, and because of its durability and dependability it is the most economical for heavy work. It is recommended for cranes, cableways, derricks, excavators, grab buckets, mine hoists, steam shovels, etc. It is furnished in Round and Patent Flattened Strand constructions. It is always made with one red strand, which is our guarantee of its high quality.

is the most economical for heavy work. It is recommended for cranes, cableways, derricks, excavators, grab buckets, mine hoists, steam shovels, etc. It is furnished in Round and Patent Flattened Strand constructions. It is always made with one red strand, which is our guarantee of its high quality.

"Special Steel"

(Trade Mark Registered)

A rope of but moderate cost but it possesses high efficiency in a wide variety of operating conditions. Its flexibility is equal to that of lower strength ropes, and its trust-worthiness within its working limit is exceptional. Furnished in Round and Patent Flattened Strand constructions.

within its working limit is exceptional. Furnished in Round and Patent Flattened Strand constructions.

Cast Steel Plow Steel

Cast Steel Rope is standard for ordinary work, being of moderately high tensile strength and quite flexible. Furnished in all constructions.

Plow Steel Rope is of high tensile strength and one that is used successfully for heavy work where sufficiently large drums and sheaves are practicable. Made in Round Strand Construction only.

Constructions

Leschen Wire Ropes are made in Round Strand, Patent Flattened Strand, and Locked Coil Constructions, as illustrated. Special constructions can be furnished to meet unusual conditions of wire rope service.

We shall be glad to furnish catalog giving breaking strength and correct working load for every size of rope in all grades of our manufacture.

Fig. 2. An extra flexible Round Strand construction for use where sheaves and drums are necessarily small. Especially recommended for cranes.

Fig. 3. A Patent Flattened Strand construction, and an ideal rope for conditions requiring unusual strength and resistance to wear. Highly recommended for heavy duty cranes, cableways, excavators, mine hoists, steam shovels, etc.

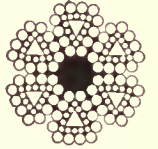

Fig. 3

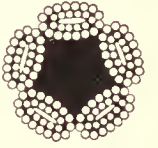

Fig. 4

Fig. 4. Extra flexible Patent Flattened Strand construction. While its use is limited, it is a very efficient rope on equipment to which it is adapted.

Fig. 5. Standard Round Strand haulage rope for inclines, and it is also used as track and traction rope on Aerial Tramways.

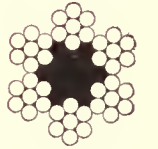

Fig. 5

Fig. 6. Patent Flattened Strand haulage rope. This is a heavy duty rope for haulage purposes, because of its exceptional ability to withstand surface wear. It is also used for track rope on Aerial Tramways.

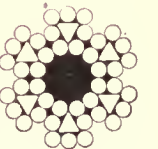

Fig. 6

Fig. 7. This Patent Flattened Strand construction of haulage rope is an ideal traction cable on Aerial Tramways. It is used with remarkable success for this class of service.

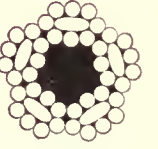

Fig. 7

Fig. 8. Locked Wire Rope is an ideal rope for main line on cableways. Its smooth surface minimizes wear and friction, and reduces vibration.

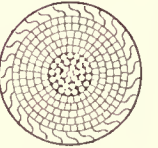

Fig. 8

Fig. 9. Locked Coil Cable is designed and recommended for track rope on Aerial Tramways. It offers the same advantage for this service as Locked Wire Rope for cableways.

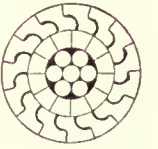

Fig. 9

A. LESCHEN & SONS ROPE CO.
ST. LOUIS—NEW YORK—CHICAGO—DENVER—SAN FRANCISCO

LESCHEN AERIAL WIRE ROPE TRAMWAYS

Application and Advantages

Leschen Aerial Wire Rope Tramways are the practical and economical solution of many transportation problems. Today they are being used successfully in various parts of the world for transporting apples, ashes, bananas, cement rock, coal, lumber, ore, stone, supplies, waste from mines and mills, and other materials.

As they take the "air route," they are not affected by weather conditions; surface irregularities do not increase cost of installation or operation; both maintenance and operating costs are low, and their efficiency is high.

Systems

In order to correctly meet all conditions of aerial transportation, Leschen Tramways are designed and furnished in various systems. The following are the most commonly used:

The Leschen Heavy Duty Friction Grip system is designed particularly for long distances and heavy capacities, yet its economical use is not limited by these conditions. From five tons per hour to several hundred tons, and from a few hundred feet to many miles are all within its range as to capacity and length. Hundreds of tramways equipped with this screw type friction grip are in use, some under the most severe conditions of loading, grades, etc. Its superior in this field is yet to be found.

The Leschen Automatic system, as its name implies, is automatically loaded and discharged. The main feature here is a saving in labor, as but one man is required. Its capacity is limited and the terminal bins must be located parallel to the tramway line.



The Leschen Two-Bucket or Oscillating system, sometimes called Jig-back, is used extensively for short lines. Although sometimes built as a power driven tramway, its more general use is where gravity operation is possible. The Leschen Single Span Gravity Two-Bucket Tramway, as developed for coal handling in the mountain regions of Pennsylvania, West Virginia and Kentucky, is a really remarkable machine, being so simple in design and so sturdy in construction that its operation is a real pleasure. The cost of handling coal with one of



Handling gold and silver ore in the mountains of California with a Leschen Heavy Duty Friction Grip Tramway.



Leschen Single Span Heavy Capacity Two-Bucket Tramway handling coal in West Virginia.

these tramways is exceedingly small. For example, with a span of about 1,000 feet, a thousand tons of coal per day can be transferred at a cost for operation and maintenance of between one and two cents per ton.

A highly important factor in the successful operation of an Aerial Tramway is the wire rope with which it is equipped. Leschen Wire Ropes for such service are illustrated and described on opposite page. There is a Leschen rope for every tramway requirement.

Preliminary Estimate

Our Engineering Department will be glad to advise with you as to the practicability of an Aerial Tramway for your particular work and to submit an estimate to you, if you will furnish us information as suggested below:

1. Give length of tramway in straight line. If horizontal curves cannot be avoided, give angle of each curve.
2. Give difference in elevation between terminal points, and state which terminal is at higher elevation. If possible, send rough sketch showing profile of ground.
3. State material to be handled and give its weight per cubic foot in the form to be carried over tramway.
4. State how many tons (2,000 lbs.) you wish to transport per hour.
5. A profile made from an accurate survey is required if final price is wanted.



Leschen Automatic Tramway disposing of waste at an asbestos mine in Canada.

A. LESCHEN & SONS ROPE CO.

ST. LOUIS—NEW YORK—CHICAGO—DENVER—SAN FRANCISCO

HARRINGTON ROCKING CABLEWAY

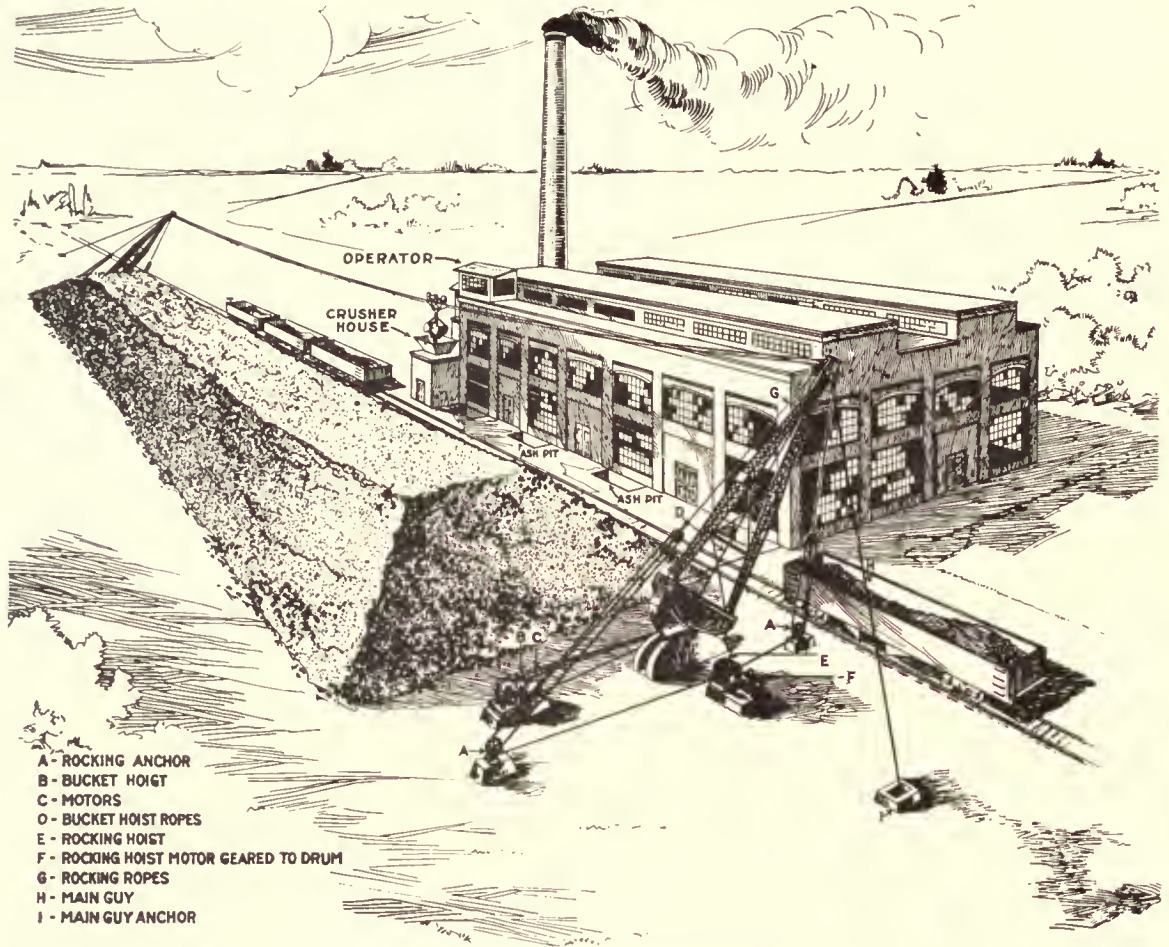

- A - ROCKING ANCHOR
- B - BUCKET HOIST
- C - MOTORS
- D - BUCKET HOIST ROPES
- E - ROCKING HOIST
- F - ROCKING HOIST MOTOR GEARED TO DRUM
- G - ROCKING ROPES
- H - MAIN GUY
- I - MAIN GUY ANCHOR

The Harrington Rocking Cableway

The Harrington Rocking Cableway is an improved cableway for giving crane service over storage yards. It consists of a balanced rocking cableway in which the supporting towers rock in unison through 120°. It combines crane service with cableway speed in storage yards.

This cableway is built on sound scientific principles that have been proven through years of practical experience. It reclaims all it can pile without the need of retaining walls and requires no supports, trestles, or other obstructions in storage space.

Universal Application

The Harrington Rocking Cableway will carry any kind of bulk material handled by grab bucket, or, materials that can be lifted by a crane hook or in a packet. It will cover an area of any length up to 500 feet, and widths as high as 100 feet. Or the cableways can be arranged with one rocking tower serving a fan shaped area.

It is particularly applicable to blast furnace yards, coal storage, crushed rock storage, storage for cement mills, lumber yards, structural steel storage, foundry yards, in fact wherever materials are stored in selective piles, or moved to and from cars, pockets, mills or storage yards.

One Man Operation

The Harrington System can be operated either by steam or electricity and requires only one operator. It has been the aim of the designers of this system to eliminate the handling of material to the conveyor or car by providing for a high longitudinal speed along the pile, making it possible to travel a considerable distance from the plant, pick up a load and convey it rapidly to the plant or vice versa. This has been accomplished by adopting the cableway principle, furnishing a very high longitudinal speed with light weight of operating parts. The lateral motion is provided by means of a rocking motion given to the terminal towers. The entire arrangement is so simple that the towers are rocked in unison and the main track cable transferred laterally by one man.

Power House Installation

The illustration above shows the installation of this Rocking Cableway for a powerhouse coaling problem. Note the area of the storage pile, all of which can be piled, and reclaimed, and delivered, direct to the crusher by this machine. It guarantees the prompt unloading of cars and consequent lack of demurrage and provides for the disposal of ashes.

RAILWAY AND INDUSTRIAL ENGINEERING CO.

GREENSBURG, PA.

ROTARY CAR-DUMPER

Application

Although the Rotary Car-Dumper is capable of handling 400 cars per day, it has been developed to a point where it offers a paying investment for handling as few as 4 cars per

day, for the following reasons:

1. Can be operated by one unskilled laborer.
2. Power requirements, one Kilowatt-hour per car.
3. Maintenance negligible.
4. Initial cost low—approximately that of one good locomotive crane.

Since the Rotary Car-Dumper unloads standard railroad cars rapidly and economically in the simplest manner possible—turning the car upside down—it offers a profitable solution of the car unloading problems in almost every type of plant.

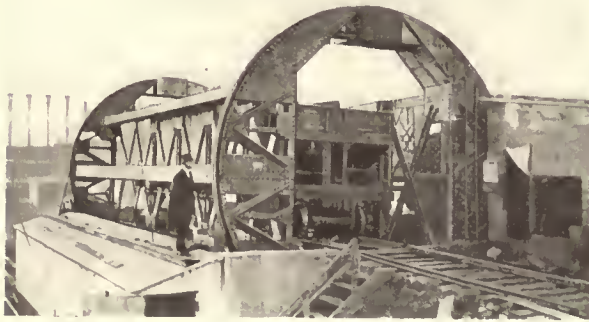

Upright Position—Receives and Clamps Any Size Car.

In the small plant, where the usual procedure is to dump the material from hopper cars into track hoppers, it eliminates the serious problem of securing the delivery of the material in hopper cars and also eliminates the excessive labor cost of thoroughly cleaning even the hopper cars. Where the unloading capacity of a plant is relatively small a heavy demurrage charge may often result when the supply of railroad cars is irregular.

In the larger plants, the Rotary Car-Dumper is not only adapted for unloading railroad cars to track hoppers which are served by feeders, but is also very suitable for unloading cars at any storage plant where material is stored in stock piles. Where cranes are used to place the material in the stock piles, the Rotary Car-Dumper can unload the cars rapidly into a large pit, which is always kept full, making it possible for the crane to readily secure the maximum load in each bucket. Such an arrangement will more than double the capacity of the crane storage system.

Material can also be put into stock piles from a Rotary Car-Dumper in a very simple and economical manner by means of a conveyor system which takes the material from the pit and delivers it to storage over a traveling tripper.

In cement mills, the Rotary Car-Dumper can unload railroad cars directly into the crushers.

The Rotary Car-Dumper reduces the cost of unloading railroad cars by

- Reducing Labor Charges,
- Reducing Demurrage Charges,

Reducing Car Injury Expense,
Eliminating the Difficulties of Unloading Flat-bottom Cars and the labor expense of thoroughly cleaning Hopper-bottom Cars.

Simplicity

The ease of operation and maintenance of the Rotary Car-Dumper is made possible by the simplicity of design which includes no elaborate or complicated machinery. There are no gears, clutches nor elaborate electrical control—in fact, no costly or expensive mechanism.

The large rotating cage is supported on four heavy trunnion wheels and is rotated by means of hydraulic cylinders or by an electric hoist. The railroad cars are engaged and held in the Rotary Car-Dumper automatically and in such a manner that it is impossible to injure the cars.

The Rotary Car-Dumper turns each car upside down and insures the perfect cleaning of each car that is delivered to your plant.

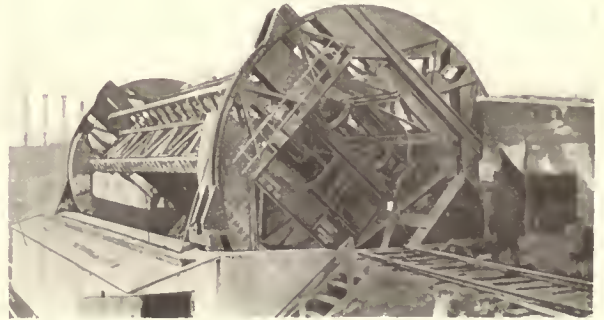

Completely Overturns Car, Assuring Perfect Discharge of Contents.

Economy

The low cost and low power requirements of the Rotary Car-Dumper for Standard Gauge Railroad Cars makes it available for the smallest as well as the largest plants. One man can control the cars and unload them in the Rotary Car-Dumper at the rate of ten cars per hour, and with an extra man to drop in the cars, a capacity of twenty cars per hour can be obtained. The maximum capacity of the equipment is approximately forty cars per hour and requires the services of three or four men.

The gross cost of unloading ten cars per hour, ten hours per day including interest, depreciation, repairs, supplies, power and labor is less than $\frac{3}{4}$ of a cent per ton.

Other Products

The Car-Dumper & Equipment Co. also manufactures Rotary Car-Dumpers for mining, stripping and industrial cars, Gravity, Electric and Pneumatic Drive, "Solidcar" Self-Dumping Cages, Car Control and Caging Equipment, and Hydraulic Trip Controls.

CAR-DUMPER & EQUIPMENT CO.

GRAND CROSSING, CHICAGO, ILL.

Bartlett & Snow Experience

Organized in 1884, Bartlett and Snow have been building mechanical carrying equipment — conveyors, elevators, skip hoists, larries—for 37 years.

During this time a great deal of knowledge and experience has been gained which is built into the equipment and which forms the basis of every suggestion offered by Bartlett and Snow engineers.

Although Bartlett and Snow build nearly every known type of conveyor and elevator, they have devoted most of their efforts to the construction of equipment for conditions which are unusual or exacting. When such conditions present themselves Bartlett and Snow can offer particularly valuable suggestions.

Cooperation is the essential work of the men in this organization. They will be glad to have requirements put up to them and will take pleasure in investigating the conditions thoroughly and offering specific suggestions which are backed up by their many years of experience. By putting your mechanical carrying requirements up to Bartlett and Snow equipment, you insure minimum operating costs and dependable operation.

Inquiries are invited from those who have requirements involving the handling and preparation of sand in foundries, the handling of coal and ashes in power plants, the handling of ores and coal at mines and preparation plants, and the handling of machines and articles in industrial plants.

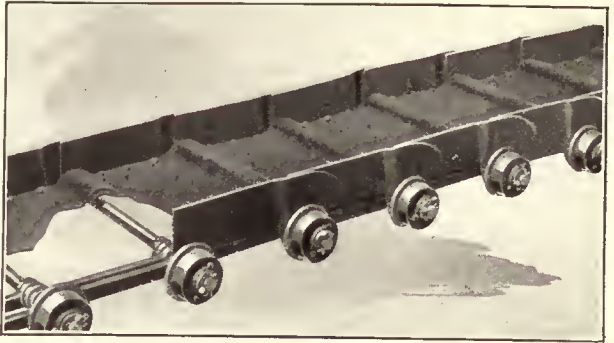

Double Beaded Apron Conveyor.

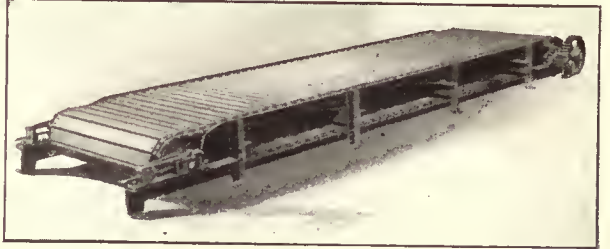

Wood Apron Conveyor for Boxes, Packages, Castings, Etc.

Bartlett & Snow Skip Hoists

Bartlett and Snow Semi-Automatic Skip Hoists are started by pushing a button. Once started, the bucket rises to the dumping position, stops long enough to dump and then automatically

returns to the bottom and comes to rest ready for the next load.

Bartlett and Snow Fully-Automatic Skip Hoists operate in a similar cycle, but it is not necessary to start them. They start automatically as soon as there is sufficient material to load the bucket, operate continuously as long as there is material to lift, and then automatically stop. They require absolutely no human aid. Power plants, steel mills, mines, chemical plants, and other industrial works can use Bartlett and Snow Skip Hoists to good advantage.



Belt Conveyor Carrying Coal. Belt Conveyor Carrying Sand.

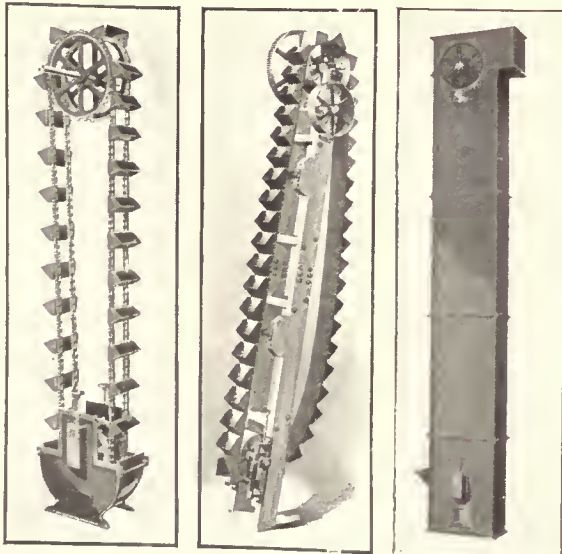

Three Standard Types of Bucket Elevators.

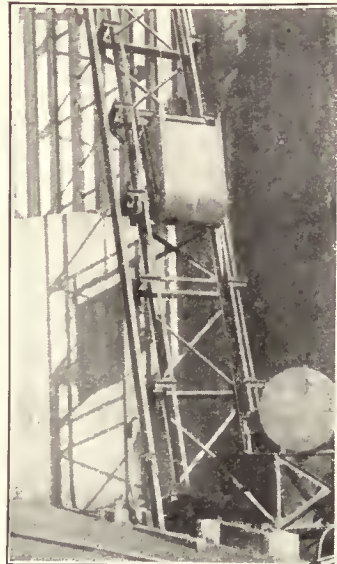

Ash Skip Hoist.

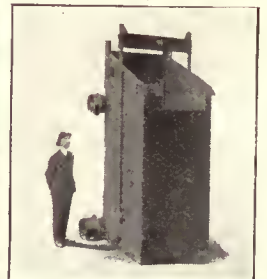

Skip Bucket for Coal.

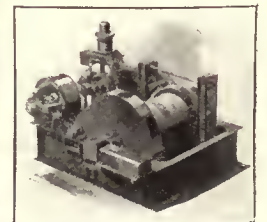

Skip Hoist Engine.

THE C. O. BARTLETT & SNOW CO.
CLEVELAND, OHIO.

OTIS AUTOMATIC SKIP HOISTS

Otis Automatic Skip Hoists

The Otis Automatic Push Button Skip Hoist meets a growing demand for high grade reliable apparatus for raising various material in bulk, such as coal, ashes, etc., and automatically delivering them at a higher level.

To meet the exacting requirements of such apparatus, standard hoisting machines, which have been developed and refined for elevator service and thoroughly standardized, are used. The control system is nearly identical with that used on certain classes of regular freight and passenger elevator installations.

Since standard elevator apparatus is used and because of the fact that Otis Service offices are located in all important cities and towns, it is always possible to secure promptly any renewal parts which may be required.

Otis Automatic Skip Hoists are made to run vertically or at any desired angle and may be divided into two classes, single skips and double skips.

Both vertical and incline hoists may be equipped with a single hoisting bucket, which may or may not require a counterweight, or, in the case of double skips with two buckets running on separate tracks, in balance.

Operation

The usual operation is by means of three push buttons marked "Up," "Down" and "Stop." These are mounted in a box as illustrated, and can be located wherever most convenient.

When the bucket has received its load the attendant presses the "Up" button which causes the machine to start, and from this point the operation is entirely automatic. The machine accelerates to full speed, the bucket rises to the upper level, and at the proper point the machine slows down and the bucket travels into the dumping position, where it stops and automatically remains for a pre-determined interval which is sufficient to allow the material to be entirely discharged from the bucket. With the single skip the machine then automatically starts in the "down" direction and continues in operation until the bucket reaches the lower level and automatically stops in the loading position. In the case of the double skip hoist, when the ascending bucket reaches the dumping position

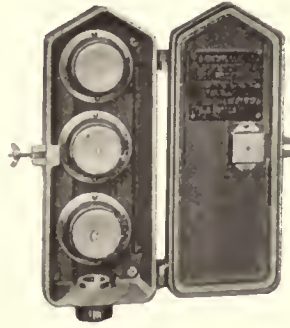

Push Button Box showing Up, Down, and Stop Control Buttons.

tion the machine remains stationary until it is again started by the operator, he having in the meantime attended to the loading of the other bucket. A pressure of the "Stop" button at any time during the travel of the bucket will cause the machine to come to rest.

The Otis Automatic Skip Hoists employing standard elevator apparatus as described are used in manufacturing plants for handling material in

bulk; in coal and coke plants, gas, electric light and power stations, for handling coal, ashes and similar material.

Otis Automatic Skip Hoists for Blast Furnaces

Otis Skip Hoists for heavier duties than those which employ standard elevator machines are those used for blast furnace skips, large incline railways and other installations where heavy duty hoists with automatic control are required. The machine used is of the Herringbone Gear type. An illustration of the direct current machine is shown herewith. This machine is also made to operate with alternating current.

Commercial Incline Railways

Otis Commercial Incline Railways are used in handling materials such as stone in quarries or cement plants to be dumped into crushers or cars; the hoisting of ore, coke and limestone in blast furnaces, roasting furnaces or coke plants; and for transferring baggage and freight; also in manufacturing plants for carrying heavy loads from one level to another. Standard elevator machines are used for inclines where the duties are within their capacities. For duties beyond the capacity of the standard elevator apparatus the larger types of machines above described are used.

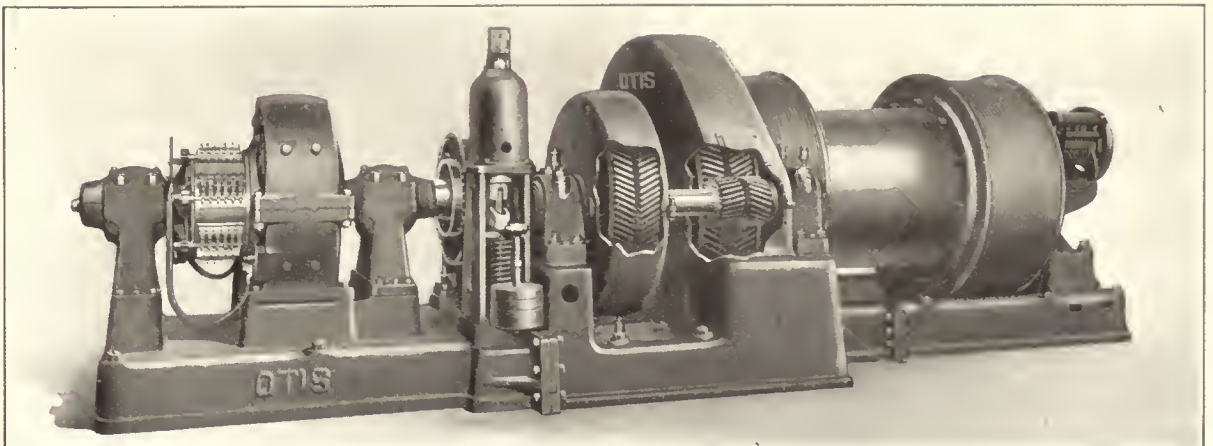

Otis Direct Current Herringbone Gear Type Hoisting Machine; Gear Case cut away to show Herringbone Gears.

OTIS ELEVATOR COMPANY

For List of Offices, See Page 750

MEAD-MORRISON COAL, ORE AND ASH HANDLING MACHINERY



10-Ton Coal Unloader and Bridge and 11-Ton Ore Bridge.

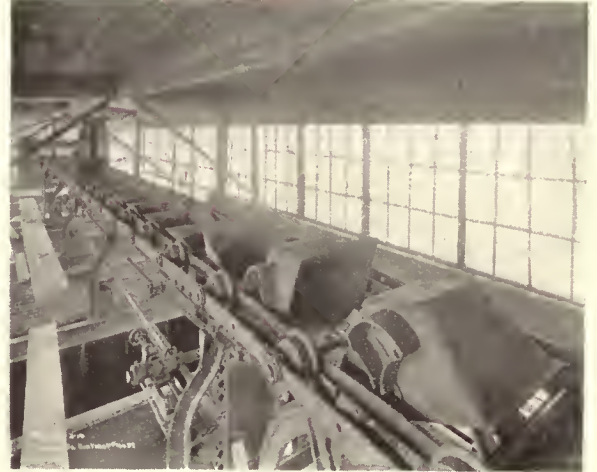

McCaslin Overlapping Pivoted Bucket Conveyor.

Mead-Morrison Aims and Service

The products of the Mead-Morrison Manufacturing Co. comprise two distinct lines of machinery, contractors' machinery and coal, ash

and ore handling machinery.

These two lines of machinery have been brought to their present high degree of perfection by improvements made from time to time when found desirable, and by sparing no expense in construction to reduce the liability of break-down and increase the efficiency and durability.

It has always been the endeavor of the company to give the requirements and interests of its customers the most careful and conscientious study, in order that it may be in a position to supply them with machinery



which will prove most economical, reliable and satisfactory.

The Mead-Morrison Manufacturing Co. maintains an engineering department whose services are at the disposal of any one with hoisting or handling problems for coal, ashes, ore or like materials.

A written request to the nearest district office will bring one of the engineers from this department to discuss the problem and offer solution.

Coal and Ore Handling Machinery

The illustrations on this page showing the ore bridge, tower, conveyor and car dumper will give the reader some idea of the variety of the coal and ore handling machinery manufactured by the company.



Electrically Operated Tower Unloading Bulk Material.

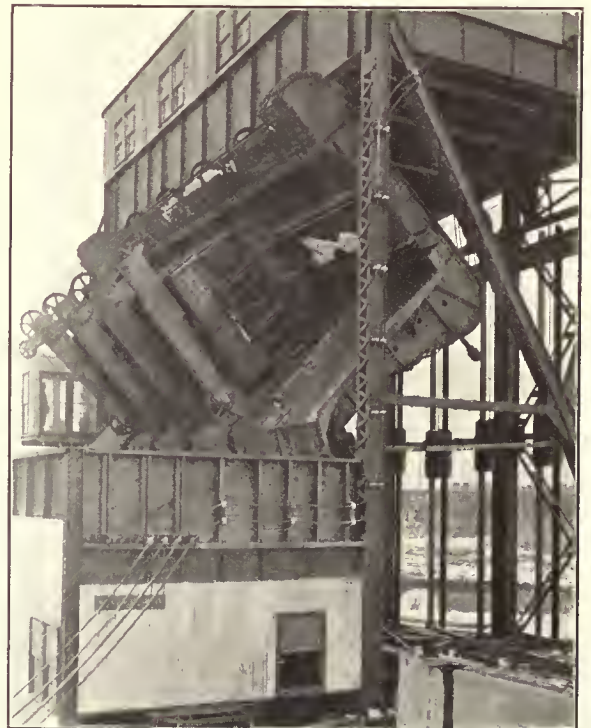

Electrically Operated Car Dumper.

MEAD-MORRISON MFG. CO., EAST BOSTON, MASS.

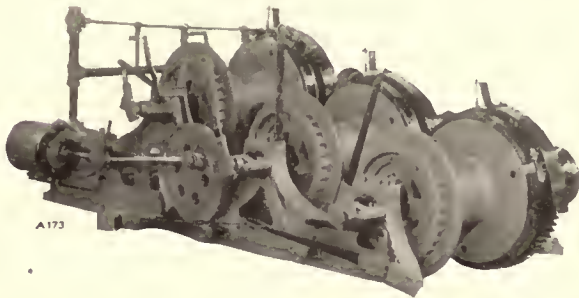

Three-Drum "Standard" Hoisting Engine.

Steam and Electric Hoists

Mead-Morrison steam and electric hoists follow the same general design, the chief difference being that in the former the frame is extended to properly support the boiler and cylinders, while in the latter the motor, controller and resistance are similarly mounted.

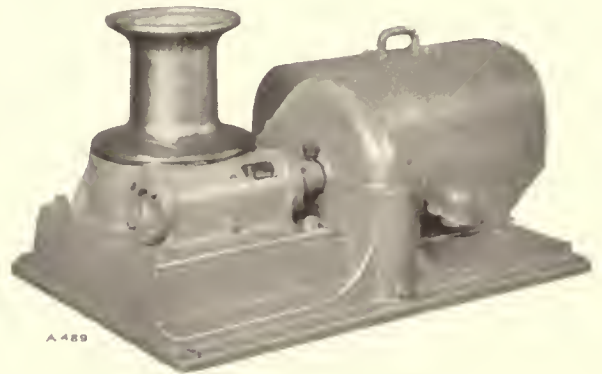

Electric Car Puller.

Mead-Morrison Products

The following list of products manufactured and sold by the Mead-Morrison Manufacturing Co. will picture to the reader the wide range of material handling machinery which they make.

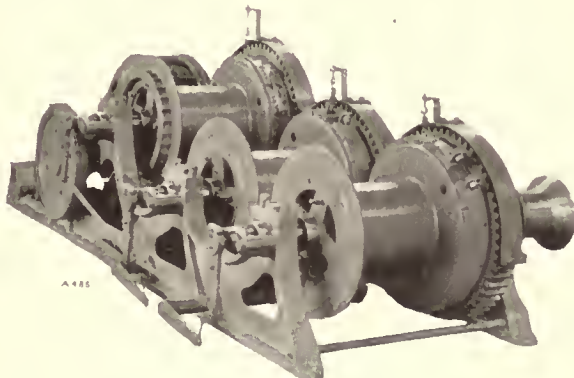

Three-Drum Electric Hoist with Automatic Brake on Boom Drum.

Grab Buckets of All Sizes

Mead-Morrison grab buckets are of superior design and substantial construction. They differ in design, shape and arrangement, depending on the particular duty, but all are of improved and patented construction. In size they range from 2 cu. ft. to 17½ tons capacity.

With this variety in details and wide range of size the Mead-Morrison Co. is in a position to fill the bucket needs of any purchaser.



6-Ton Type "C" Grab Bucket.

COAL, ORE AND ASH HANDLING MACHINERY

- | | |
|--------------------|-----------------------|
| Towers | Crushers |
| Car Dumpers | Coal Screening Plants |
| Bridges | Cable Railways |
| Mast and Gaff-Rigs | Automatic Railways |
| Conveyors | Transporters |

STEAM, ELECTRIC AND GASOLINE HOISTS

- | | |
|---------------------|----------------------------|
| Contractors' Hoists | Pile Driving Hoists |
| Mine Hoists | Quarry Hoists |
| Derrick Swingers | Slack Line Cableway Hoists |

GRAB BUCKETS (CLAM SHELL AND ORANGE PEEL)

For excavating and for handling coal, ore, sand, broken stone, gravel, etc.

MARINE EQUIPMENT (ELECTRIC AND STEAM)

- | | |
|-------------------------|--|
| Cargo Unloading Winches | Capstans (Horizontal and Vertical) |
| Trawler Winches | Steering Gears (follow-up and non follow-up) |
| Anchor Windlasses | |

MOTOR TRUCK WINCHES

- | | |
|-----------------|-----------------------|
| Capstan Winches | Friction Drum Winches |
|-----------------|-----------------------|

LIST OF DISTRICT OFFICES

- New York—Singer Building
 Montreal—265 Beaver Hall Hill
 Chicago—53 West Jackson Boulevard

HUNT SKIP HOISTS AND PIVOTED BUCKET CONVEYORS

General

The C. W. Hunt Company, Inc., West New Brighton, N. Y., is a manufacturer of industrial railways and coal handling machinery. Its line of products includes Industrial Railway Tracks, Switches, Motor Operated and Push Cars, Scales, Electric Mine and Industrial Locomotives, Automatic Railways, Cable Railways, Conveyors, Coal Crackers, Skip Hoists, Bin and Hopper Gates, Weighing Larries, Coal Tubs, "Stevedore" Manila Transmission and Hoisting Rope, Transmission Rope Couplings and Drilling Cable.

Use and Economy of Skip Hoists

Where material is to be elevated, a skip, in most cases, is the ideal unit. It is simple and rugged in design. Its operation is most economical, as power is only used when the material is being hoisted. The upkeep is minimum, as practically the only part subject to destructive wear is the wire hoisting rope. A single unit, the bucket is the carrier and keeps the abrasive action of the material on the machine, and breakage of the material by the machine at a minimum.

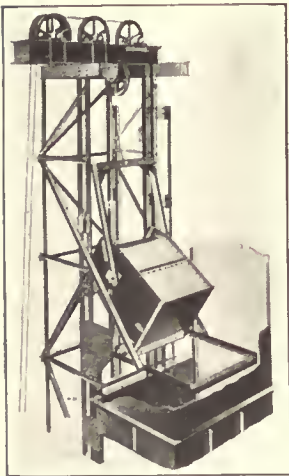

Head Frame and Loading Chute of Hunt Skip Hoist.

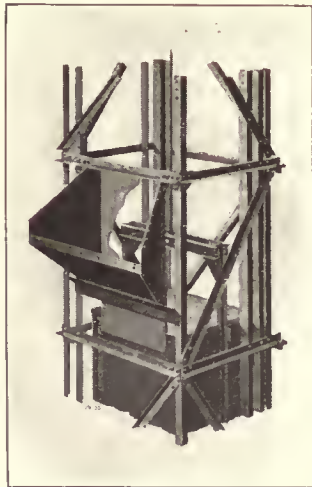

Hunt Standard Skip Hoist

The Hunt Standard Skip Hoist consists essentially of the load-carrying bucket, the wire hoisting rope, the head and leading sheaves, the electric single drum hoisting engine with motor, the traveling cam control, the electrically operated brake, the bucket guides, the loading pit valve or the loading chute, the control panel, and the push button station for operating the machine.

The single bucket skip is counterweighted and the guides constructed for properly guiding the counterweight and bucket. Electric skips with drum type controller and steam hoist, friction operated, skips of high speed can be furnished if desired. These two types require experienced operators and much more power. Unless warranted by exceptional conditions, they are seldom used.

The operator fills the bucket by dumping the car load into the deflecting chute or if a receiving hopper is used, by opening the pit valve. Either one of these operations insures a loaded bucket. The time required for loading the bucket varies from five to twelve seconds under normal conditions, depending on the size of bucket and the material handled. To operate, a button is pushed which releases the brake and starts the hoist, which then automatically accelerates, hoists at speed, decelerates, stops, bucket discharging, reverses, accelerates, lowers at speed, decelerates and stops. The bucket is again loaded and the cycle repeated.

Hunt Pivoted Bucket Conveyor

In designing or operating a power house the advantages and savings possible with a properly arranged coal and ash handling plant are obvious. The most economical way of operating this branch of work is by means of a continuous pivoted bucket conveyor.

The Hunt pivoted bucket conveyor consists essentially of a number of buckets so pivoted that they always maintain an upright position, no matter in what direction the conveyor is traveling. The buckets are driven by chains supported on automatically lubricated wheels running on T rails. The chain is driven by pawls which provide smooth operation even should the pitch of the chain vary. The buckets are filled by a special filler which prevents overloading and spilling of material.



Pivoted Bucket in Operation.

Dumping Attachment

The buckets of the Hunt Conveyor are made of open-hearth steel, malleable, or cast iron. A dumping cam is located on each side of the bucket. It is so designed that it will engage the dumper without shock and tilt the bucket, emptying all the material by gravity.

The dumping device consists of a bracket, which can be affixed to the rail at any point. This bracket supports a shaft to which is attached a hand lever, and a cam, at each end. When the hand lever is thrown forward the tripper cams engage those of the bucket, tipping each bucket as it passes the discharge point. The dumping cams bear on the axle, relieving the strain on the buckets and increasing their durability.

C. W. HUNT COMPANY, INC.

WEST NEW BRIGHTON, N. Y.

HUNT INDUSTRIAL AND AUTOMATIC RAILWAYS

Hunt Industrial Railways

The Hunt Industrial Railway is constructed for every industry and service where the reliable movement of material is essential. With cars operated by electric storage battery, trolley, or third rail locomotives, the loads that can be carried are limited only by the strength of the cars and track.

Tracks and Cars

The standard gauge of the tracks is 21½ inches measured from outside to outside of rail heads, loaded cars of standard width require a passage of only 4 ft. clearance. The track sections, switches, frogs, cross-overs, etc., are shipped in units assembled with the ties, and all ready to lay. An extremely important feature of the Hunt Industrial Railway is the ability of the cars to run around curves of very short radius. A standard four-wheel car runs around a curve of 12 ft. radius with ease.

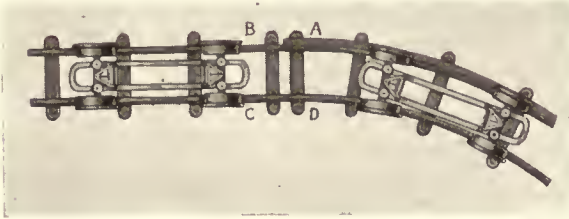

Hunt Flexible Wheel Base on Curve.

The action of the axles and wheel flanges on Hunt cars in rounding curves is illustrated above. As the car on a straight track approaches the curve, the wheel B runs on its flange on the special outer curve rail A and the wheel C runs on its tread on the inner rail D. Thus as the axle assumes a radial position there is no slipping on the rails and no sliding friction.

Locomotives

The Hunt Storage Battery Locomotive is well equipped to haul several cars in a train. In case it is desired to equip one car with power, this, too, can be done, enabling the car to travel under its own power.



View of Thirteen Hunt Automatic Railways in Locomotive Coal Storage Yard.

Hunt Automatic Railway

The Hunt Automatic Railway was designed primarily for transporting bulk materials from railroad cars and vessels to storage bins where the run does not exceed 600 feet.



Coal Hoisting Towers.

Inclined Boom Hoisting Tower

The Hunt Towers are especially adapted for the rapid unloading of vessels. Furnished steam or electrically operated, one-man control; with hoisting capacity of from 100 to 300 tons per hour. Tubs can be used as well as grab buckets with this type of tower, the change being made in a few minutes.

Hunt Bin and Hopper Gates

These gates are unsurpassed for controlling coarse, wet and hot material; are ruggedly constructed, and have a positive shut-off, due to the powerful and easily operated mechanism. There are no gears or small parts to get out of order and all working parts are simple and easily replaced when worn out from long service. Hunt Gates are used at most of the large plants in the country, and are highly recommended.



Bin and Hopper Gate.

The C. W. Hunt Co. specializes in gates for coal, ashes, sand, stone, gravel, fertilizer material, etc. All sizes from 6" to 36" x 36" carried in stock.

Hunt Service and Branch Offices

This organization includes an engineering staff prepared to furnish estimates and to render co-operative service to interested parties. The works are tributary to the Baltimore & Ohio tracks, and include a wharf capable of accommodating lighters of every railroad centering in New York City, thus assuring prompt service to all purchasers.

The company maintains a branch office in New York City, and is represented in Chicago, Boston and Washington, D. C., by Phillips, Lang & Co., Inc., Day, Baker Co., Inc., and James P. Mewshaw, respectively.

C. W. HUNT COMPANY, INC.

WEST NEW BRIGHTON, N. Y.

BEAUMONT SUPER-CENTRAL COAL AND ASH HANDLING SYSTEM

Handling Coal, Ashes and Coke

The entire organization of the R. H. Beaumont Co. is devoted exclusively to the building of equipment for handling coal and its two by-products, ashes and coke. By twenty years' concentration in this field they have developed certain machines as being the best for the purpose intended. A description of these standardized machines follows. Besides the machines shown the company also builds bunkers, gates, crushers, hoppers and feeders to complete an installation.

The work of the company includes the erection of the equipment. One contract covers everything—design, construction and installation of the complete plant, including the necessary bunkers and structures.

The experience of the company is at the disposal of anyone contemplating a new boiler house or considering coal and ashes handling equipment in an existing one.

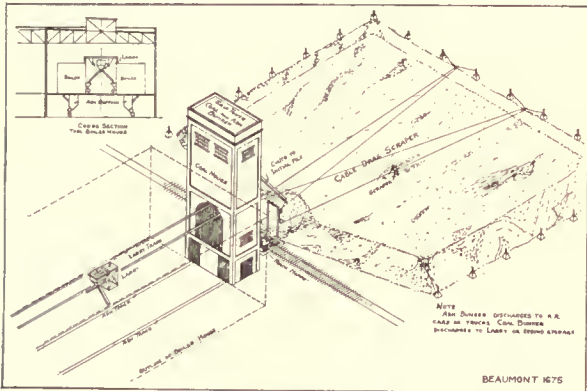

The Beaumont super-central coal and ash handling system

Beaumont Skip Hoists, Larries, Drag Scrapers

These three devices form the nucleus of the Beaumont Super-Central Coal and Ash Handling System.

In this system the coal and ashes are centralized in external bunkers. The materials are elevated to the bunkers by the Beaumont Skip Hoist.

Coal is taken from the bunker and distributed to the stokers by the Beaumont Larry.

Ashes are brought to the ash skip hoist by an ash car or train of cars.

Only a few days' run of coal is kept in the bunker, reserve coal is stored on the ground and reclaimed when required by the Beaumont Cable Drag Scraper.

Machinery is thus reduced to its simplest form, the equipment consisting only of a few self-contained massive units. In moderate size boiler houses, two winding machines are used, placed side by side in a clean, well lighted, accessible room in the coal house; one for the skip hoist and one for the drag scraper.

The advantages claimed for this system are as follows:

Advantages of the Beaumont Super-Central

1—Lowest First Cost—A bunker where all coal and ashes are concentrated at one spot is the most economical to build. The usual distributing conveyor is eliminated, thus further reducing the cost. On account of concentration and

the fact that all construction is outside the boiler room the cost of construction is less.

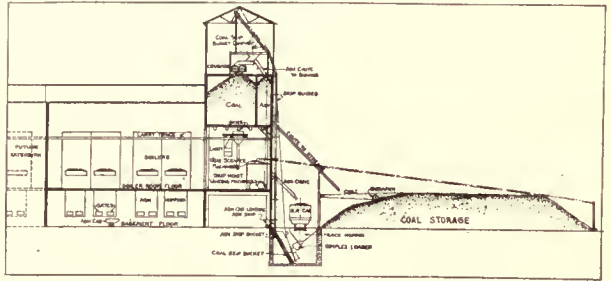

2—Lowest Maintenance Expense—Because the machinery is reduced to a minimum, and that used is of rugged design. Having no distributing conveyor reduces maintenance charges.

3—Lowest Power Consumption—Because distributing conveyor is eliminated, and this (when used) consumes more power than the elevator.

4—Ease of Construction—Since all work is done outside the boiler house, there is no interference with the men operating in the case of existing boiler houses, and in new boiler houses with the men erecting the building, boilers, stokers, piping, etc. This means that not only the coal and ash handling system, but the boiler house and all equipment in the boiler house will be erected at less cost.

5—Simplest Type Building—May be built (in case of new boiler house) consisting merely of four walls and roof of standard building construction.

6—Construction Expedited—Building does not have to wait for data from company furnishing bunker and machinery. Construction of the building and bunker takes place simultaneously, instead of the latter waiting until the building is finished.

7—Maximum Light and Ventilation—Is gained in the boiler house, there being no overhead bunkers to obstruct light and ventilation.

8—Eliminates Chain Elevators and Conveyors—Which are always subject to wreck and must be renewed more frequently and at a greater cost than skip hoists.

9—Machinery Operates with Minimum Noise—Some systems are extremely noisy and are especially undesirable in built up districts. The skip hoist is as quiet as a freight elevator.

10—Pleasing Architectural Appearance—The bunker is blended with the building, making a very pleasing architectural appearance.

Catalog 40 is an encyclopedia of Coal and Ash Handling Systems. Write for your copy.



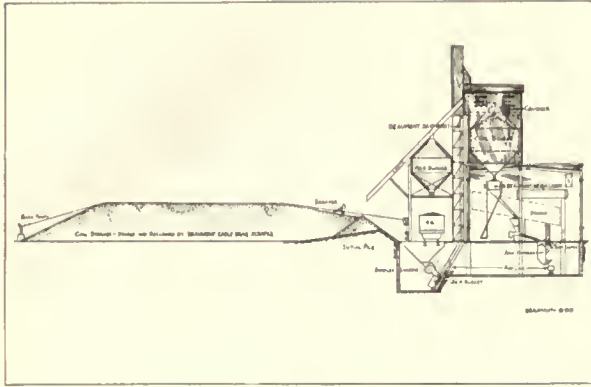

Beaumont Cable Drag Scraper

Beaumont Skip Hoist

The skip hoist consists of a bucket running on inclined or vertical tracks and hoisted by means of a steel cable attached to a winding machine. The bucket consists merely of a rectangular steel box open at the top and fitted with guide rollers and hoisting bale. The winding machine is driven by an electric motor. The skip is started upward by pushing a button. The skip reciprocates continually and is automatically filled by the Simplex Loader. The Skip is the best and most commonly used coal, ashes and coke hoisting system. It is built in standard sizes to hoist 10 to 300 tons of coal per hour at 50 ft. lift; larger sizes have been built.

Skip Hoist advantages are:

1. Not affected by grit, heat or water.
2. Skip hoist has high capacities.
3. High lift is no objection to a skip.
4. Operating costs are low.
5. Installation cost is low.
6. Power consumption is at a minimum.
7. Freedom from breakdown.
8. Repair parts are at a minimum.
9. The skip will handle lumps, fines, etc.
10. The skip hoist is quiet in operation.

Write for separate Skip Hoist Catalog No. 50.

Beaumont Drag Scraper

Coal is received at the plants in railroad cars and discharged into a hopper below the tracks. From here it is elevated and delivered down a chute to form an initial pile, adjacent to the railroad track. A machinery house contains the driving drums to which are attached the ends of a steel cable. The cable extends across the storage yard and the opposite end is attached to any two of a series of steel posts which surround the yard. A scraper is attached to the cable and pulled back and forth over the coal. By reversing the scraper or changing the location of the outermost end of the cable, coal can be moved in any direction, as desired.

When reclaiming, the coal is scraped back to the reclaiming hopper and delivered to the elevator, which will discharge the coal either to railroad cars or to the boiler house bunker.

Drag scraper advantages are:

1. Coal storage area any shape.
2. Hourly capacity high, up to 600 tons.
3. Can be operated by ordinary labor.
4. Maintenance is low.
5. System will fight fire.
6. Stores coal in layers, not piles.
7. Will handle lump or crushed coal.
8. No trestle is required.
9. The salvage value is high.

Catalog 45 describes the Beaumont Cable Drag Scraper System. Send for a copy if interested in coal storage.

Beaumont Larries

A larry is a plate hopper suspended on scales and mounted on a truck which runs on overhead tracks.

The larry takes coal from any part of the overhead coal bunker and delivers to any stoker. Accurate weight of coal burned is kept. Larries built from 1/2 to 25 tons capacity.



BRANCH OFFICES

- | | | |
|-----------------------|-----------|------------|
| 50 Church St. | - - - - - | New York |
| 1406 S. Michigan Ave. | - - - - - | Chicago |
| 1201 Kresge Bldg. | - - - - - | Detroit |
| 618 National Bldg. | - - - - - | Cleveland |
| 230 Fifth Ave. | - - - - - | Pittsburgh |
| 261 Franklin St. | - - - - - | Boston |

STEARNS CONVEYORS

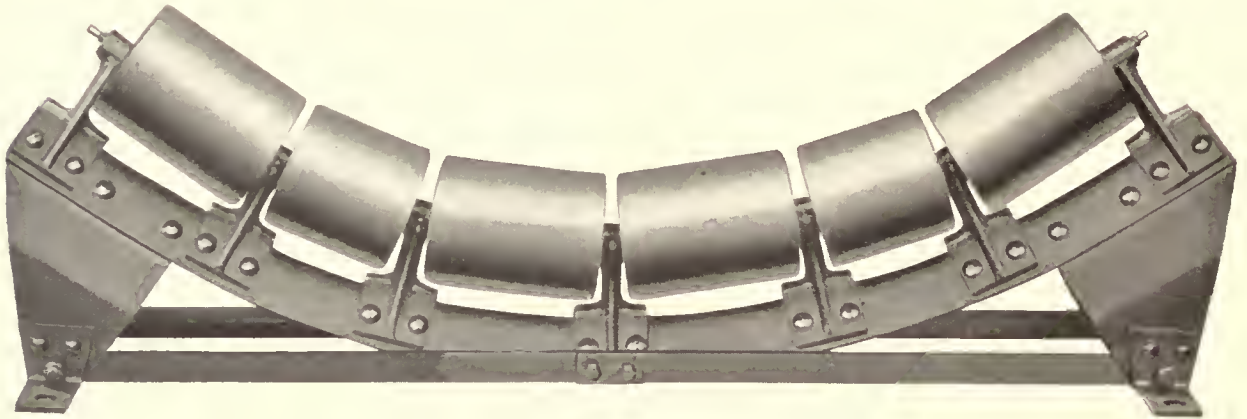

Gradual Troughing Type Belt Conveyor Idler equipped with Alemite Lubricating Plugs

Equipment

Stearns material handling equipment includes a complete line of elevating and conveying machinery for handling materials in both bulk and packages. The principal types are, belt and bucket elevators, belt, pivoted bucket, pan, screw, and apron conveyors; complete screening plants, coal and ash handling equipment, in fact, conveyors for every service are designed and manufactured in our factory.

Standardization

It is the policy of The Stearns Conveyor Company to standardize wherever possible on conveyor units and duplicate sections applicable to the greatest number of installations, thereby making it possible to manufacture on a quantity production basis, affording superior quality at no greater cost to consumer.

Salient Features

The mechanical construction and method of lubrication of the Stearns belt conveyor idler is unusual. The common faults of disalignment and improper lubrication have been eliminated. Perfect alignment is assured by mounting Hyatt Roller Bearings on a single piece of seamless tubing. The outer race for the roller bearing is another piece of seamless tubing which carries the pulley itself. Thus the two roller bearings are always perfectly aligned.

Upon proper lubrication depends the life of any machine. All Stearns conveyor idlers are equipped with the well known Alemite Lubricating System that is in use on many automobiles. The upper bearings on the inclined pulleys in all common forms of idlers suffer from lack of proper lubrication because gravity pulls the grease away, allowing the bearings to run dry. The Stearns pulleys are provided with a grease chamber with floating plungers to force the grease up to the Hyatt Bearings. The Lubricant is thus forced from the center out, providing a seal against grit and dirt. It is only necessary to lubricate once or twice a year, which can be done while the conveyor is in operation, by means of an Alemite grease gun.

The three principal causes for shortening the life of the idler have been improper lubrication, grit, and dis-

alignment. With these difficulties eliminated the life of the equipment is greatly prolonged. The cost of maintenance, expense of repairs, and inconvenience are reduced to a minimum.

The case of the belt conveyor is typical of the mechanical refinements of all Stearns products.

Cut Production Costs

The use of Stearns equipment cuts production costs two ways. First your material handling costs are reduced by supplying mechanical means for human labor. Second, your mechanical handling costs are lessened by reducing maintenance and repair expense of the equipment to a minimum.

Service

Stearns engineers will gladly investigate your material handling problems and report to you the most efficient solution regardless of who manufactures the equipment that is best suited to handling your product most economically. Stearns service does not stop with your purchase.

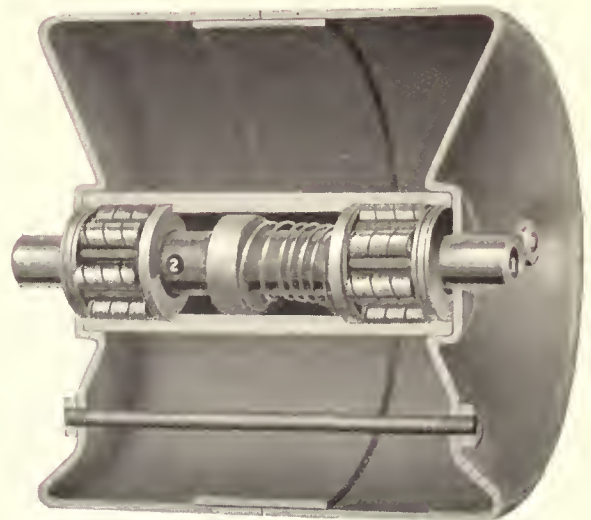

Single Idler Pulley

Grease enters at 1 and passes through 2 filling grease reservoir and pressing back plunger

THE STEARNS CONVEYOR CO., CLEVELAND, O.

OFFICES AND FACTORY: EAST 200th ST. and ST. CLAIR AVE.

MERRICK CONVEYOR WEIGHTOMETER

Weighing Materials in Transit

The Merrick Conveyor Weightometer is an adaptation of a platform scale designed for the automatic weighing of conveyor handled materials while in transit. Where time as well

as accurate weight is an important factor in the loading, unloading or transporting of materials by conveyors, the weightometer meets the requirements. It records the weights with a guaranteed accuracy of 99%, without hindering in any way the handling of the materials.



Merrick Conveyor Weightometer Weighing Material in Transit on a Belt Conveyor.

The Merrick Method

The Merrick Weightometer is designed for use with any size or style of belt or pan conveyor. It will weigh successfully any material which can be carried by the conveyor.

The illustration below is a sketch of a typical weightometer installation on an inclined belt conveyor. A section of the conveyor belt is supported on a floating platform. This platform is hung on compound levers and balanced by an iron float in a cylinder of mercury. The movement of the float is a direct measure of the weight on the conveyor belt. An integrator multiplies this weight by the speed of the conveyor. The sprocket chain drive to the integrator from the return belt of the conveyor is clearly shown in the illustration below.

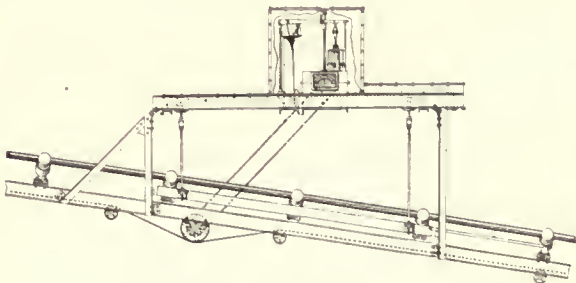

Typical Weightometer Installation with Inclined Belt Conveyor.

The method of recording the weight can be seen in the illustration of the integrator. Rollers are mounted around the periphery of the disc (1), and the belt (2), which is driven by the conveyor, rubs against these disc rollers at the right and left. The disc is carried on a swinging frame. When it is in the "no load" position and perpendicular to the plane of the belt, the rollers revolve and exert no turning effort on it. But when the disc is tipped by a system of levers a com-

ponent of the motion of the belt acts to turn it. As the weight increases the angle of tipping increases and the speed at which the disc is revolving increases. A

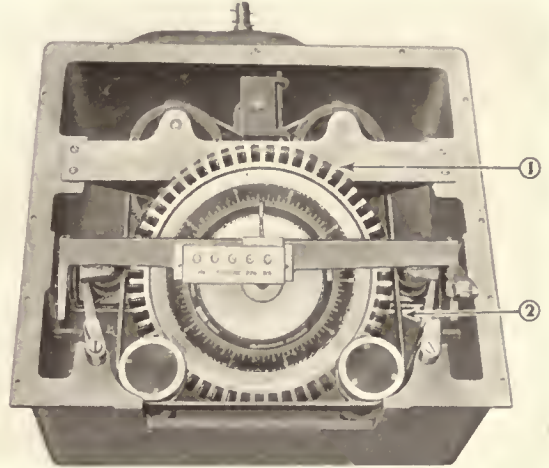

Detail of Integrator Box.

simple mechanism records this motion and furnishes an accurate record at all times.

Troughing Idlers and Weighted Take-Ups

With continual operation the end pulley of the average idler might sag, thus giving a variable trough. As this is detrimental to accurate weighing, the Merrick Troughing Idler was

built. They are made in two styles—3 pulley and 5 pulley and are intended for use only at the weighing section. All parts are accurately machined and the ends buttressed against end sag. Holes to admit the passage of an aligning cord are jiggged in the buttress ends so that the alignment can be checked while the conveyor is in motion.

The Merrick "Easy Slide" Weighted Take-Up for belt conveyors is designed to keep the belt tension constant automatically. A bill of material with an installation drawing will be furnished by the company when conveyor conditions and necessary dimensions are known.

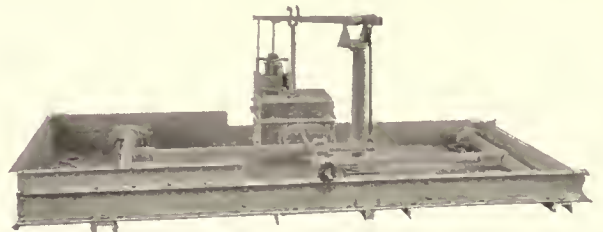

Mounting of the Weighing Levers with Connection to the Weigh Beam and Integrator Box. Casing Covers Removed.

Consult the Manufacturer

"The Merrick Scale Mfg. Co. invites correspondence from any readers with conveyor handled materials desirous of easily but accurately determining the weight of such materials. Coal, coke, stone, cement, ore concentrates, gravel, fish, phosphate rock, pebbles, are representative of the materials handled."

LINK-BELT COAL AND ASHES CONVEYORS

The Peck Overlapping Pivoted Bucket Carrier

The Peck Overlapping Pivoted Bucket Carrier is the recognized standard machine for handling coal and ashes in the modern power plant. It is the highest development of the

conveying art.

Constructed as it is with few wearing parts and these of the best design to resist wear; the cost of maintenance and power is very small. But even of greater importance is its reliability. In this feature the Peck Carrier is unrivaled.

We believe it will be but a short time before the use of this type of Carrier, for all but short conveyors—and in all cases where material is to be both conveyed and elevated—will be the most generally accepted means of conveying.

Send for catalog No. 220.

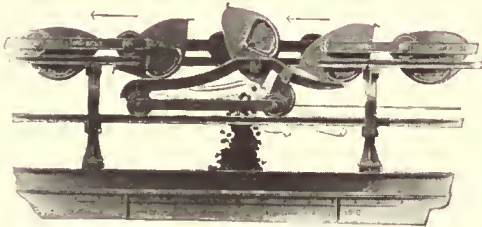

Peck Carrier Discharger in Operation.

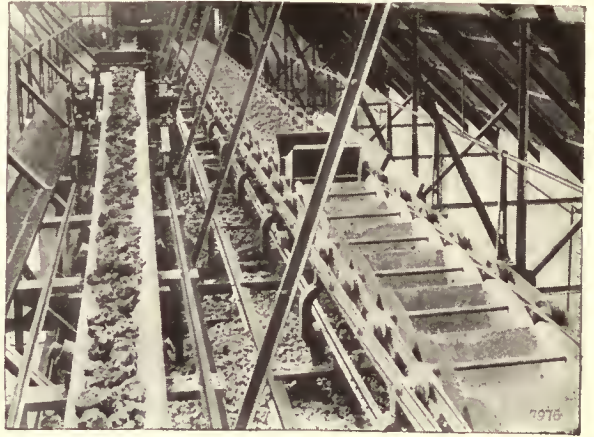

Peck Carrier and Belt Conveyor.

Other Link-Belt Coal and Ashes Handling Equipment

Link-Belt Engineers have specialized in the solution of coal and ashes handling problems in power plants. Our equipment for power plants includes a complete line of accessories;

belt conveyors, bucket carriers, feeders, crushers, track hoppers, coal bins, ashes pockets, stoker spouts, bin and hopper gates, cars, locomotive cranes, grab buckets, unloaders, and loaders, electric hoists, water intake screens, transmission machinery, etc.

Like all Link-Belt Equipment it is ruggedly constructed for hard continuous service.

Let us suggest a coal and ashes handling installation for your boiler house.

Send for Book No. 353-A, "Economical Handling of Coal and Ashes and Reserve Coal Storage."

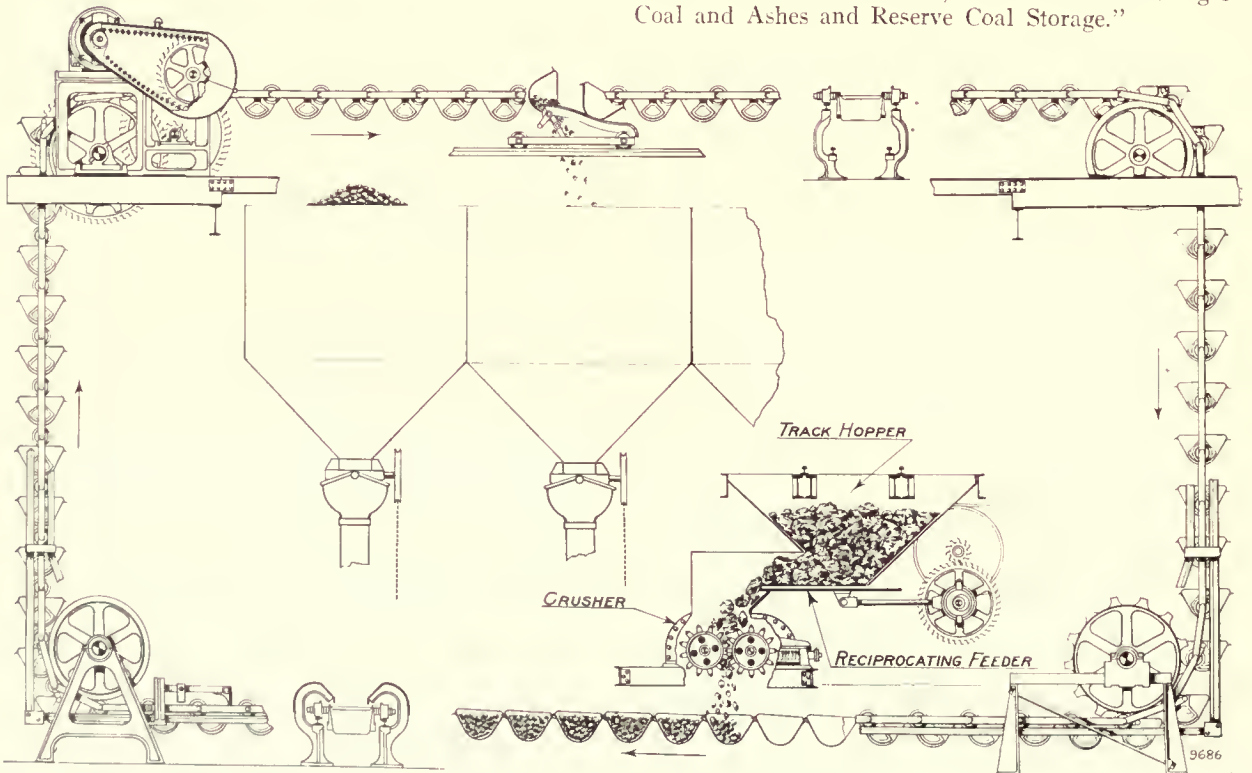

Diagram Showing the Operation of the Peck Overlapping Pivoted Bucket Carrier.

LINK-BELT COMPANY

PHILADELPHIA

CHICAGO

INDIANAPOLIS

B-G PORTABLE CONVEYORS AND BUCKET LOADERS

Standardization

B-G machines are standardized in design. This means quick delivery of machines to meet any problem and service for the user in quick delivery of parts. No waits or charges for special equipment. The line consists of Portable Belt Conveyors, Permanent Belt Conveyors and Self-Feeding Bucket Loaders.

B-G Portable Belt Conveyors

Below is shown the B-G type of portable belt conveyor. Strength, light weight, a low receiving hopper, swivel wheels, variety in lengths, and standardization are the essential advantages embodied in this conveyor.

Strength and light weight are gained by using steel angles and pipe in the form of a Warren Truss. By

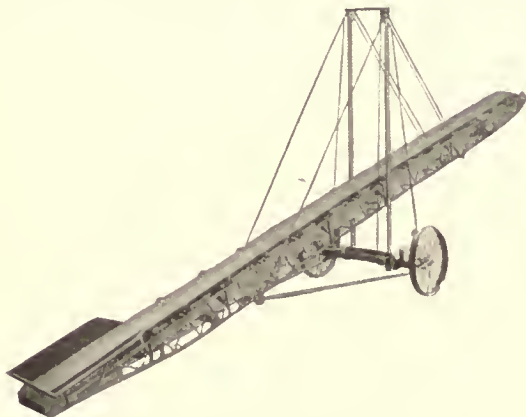

B-G Standardized Portable Belt Conveyor.

placing the motor at the discharge end, it is possible to build a low receiving hopper. Axles are so constructed that the wheels may be set at right angles for "fanning" or spreading the pile.

Portable conveyors are furnished in length from 15 ft. to 60 ft. Permanent conveyors are furnished in any greater lengths up to 200 ft. Belt widths are either 18" or 24". Gasoline or electric drive as desired.

Standardization means adherence to one general design, reasonable costs from quantity production, and



Type U, the Conveyor with the Digging End.

interchangeability of parts. For the user it means quick delivery of machine and repairs, and a machine which will serve a number of needs besides the one for which it is purchased.

One conveyor model departs radically from the general B-G design. This is a one-man machine for universal use, the type "U." It is made in only one

length, 22 feet, with 12" or 18" belt, cupped steel cleats, overlapping side clips, and continuous skirt boards. The receiving end is exposed so that the cupped flights passing around the lower pulley dig into the pile when the conveyor is pushed into any loose bulk material. For this reason it is called "The Conveyor With the Digging End."

Specifications B-G Self-Feeding Bucket Loader

Self-Feeder—Two 36" flat steel discs set nearly horizontal rotate toward the center continually bringing material to the buckets. Patented.

Crawler Traction — Full length continuous treads, 58" long by 8" wide.

Transmission—Truck type with cut gears, enclosed running in oil. Differential. Machine can turn around in its own length.

Elevator—Buckets mounted on two strands of chain, motor and sprockets protected from dust and spillage.

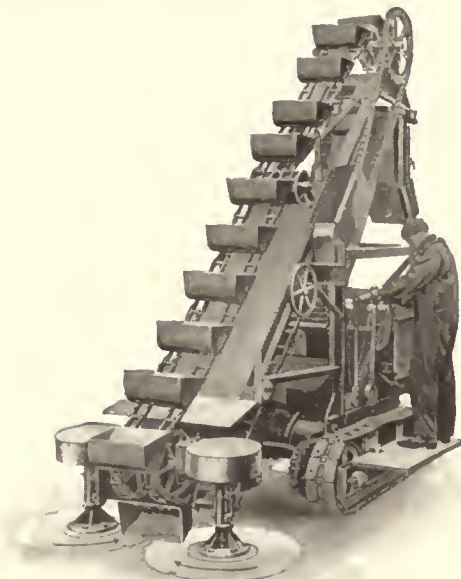

B-G Self-Feeding Bucket Loader (Patented).

Power—Buda 4-cylinder, 25 H.P. gasoline engine or 15 H.P. electric motor. Ample power.

Control—Only one operator needed. All controls within easy reach.

Discharge Spout—Pivoted to permit discharging in any direction with ample clearance. Measuring hopper provided if desired.

Capacity—1¼ cu. yds. per minute.

Safety—Discs perfectly safe. Other moving parts protected.

Dimensions—Length overall 11 ft. 1 in.; digging width 6 ft. 4 in.; width of crawlers overall 61 in.; discharge height 10 ft.; weight 8,800 lbs.

BRANCH SERVICE AND SALES OFFICES:

New York	Utica	Chicago	Kansas City
Philadelphia	Cleveland	Milwaukee	Denver
Norfolk	Detroit	Minneapolis	Salt Lake City
Worcester	Indianapolis	St. Louis	Portland
Buffalo	Pittsburgh	Omaha	San Francisco
	Los Angeles	Seattle	

Canadian agents: Mussels Limited, Montreal, Winnipeg, Toronto, Vancouver

EXPORT DEPARTMENT:

ALLIED MACHINERY COMPANY OF AMERICA
51 Chambers Street, New York City

BARBER-GREENE COMPANY

AURORA, ILLINOIS, U. S. A.

AUSTIN SELF-FEEDING WAGON LOADER

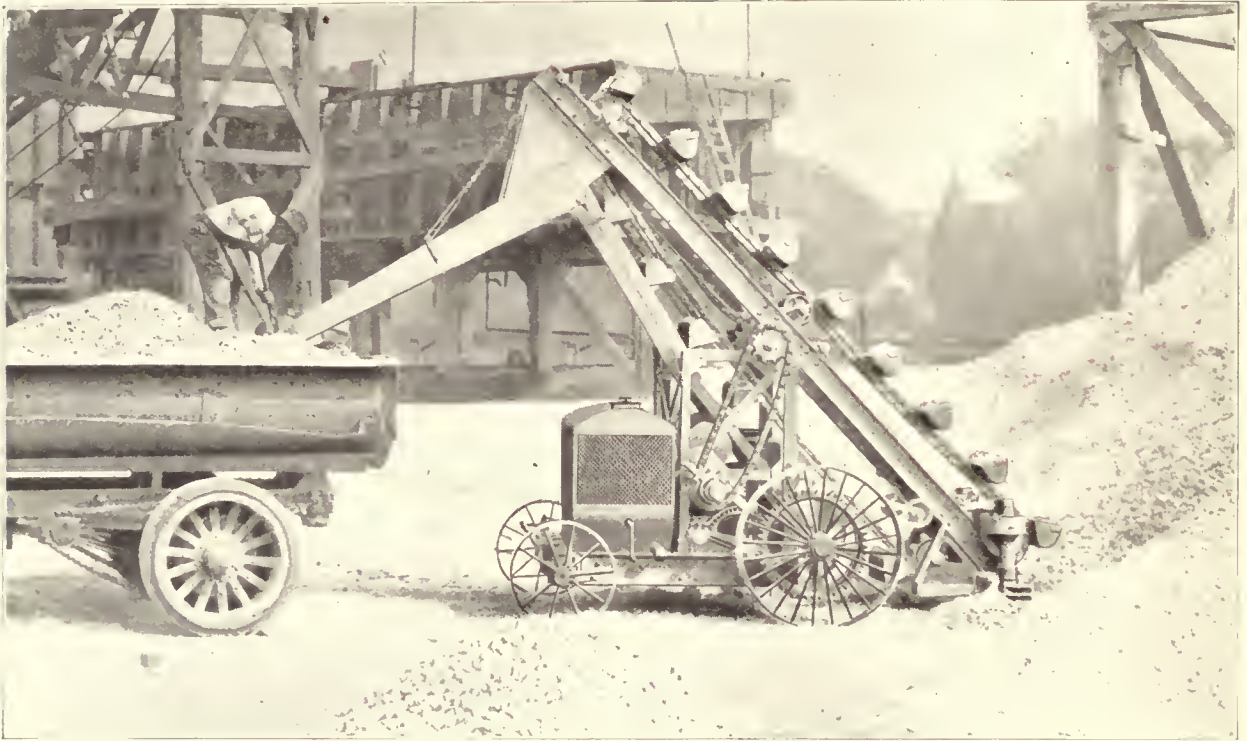

Austin Wagon Loader Loading Four Yards of Crushed Rock in a Truck in Six Minutes

Purpose

Since the cost of labor has become such an important factor in the handling of crushed rock, gravel, sand, coal, grains, etc., the Austin Self-Feeding Wagon Loader was designed to reduce the use of man power to a minimum as well as to make possible the saving of time in the loading of materials of all sorts in wagons and automobile trucks.

The Self-Feeding Device is a distinct advance in the multiple-bucket type of wagon loader. Its greatest economy of operation is due entirely to this attachment, which eliminates the necessity of two men to feed the buckets. This self-feeding device, which is more fully described and illustrated on the opposite page, actually sweeps the material into the bucket path and automatically withdraws in preparation for the next cut. The steel feeding arms, or digging arms, of which the self-feeding device is composed, will cut a swath wide enough for the machine to follow into or through the bank so that every bucket can be filled completely to the brim.

The twenty-two buckets, each holding one-third of a cubic foot, which complete $3\frac{3}{4}$ cycles per minute, give the Austin Self-Feeding Wagon Loader a capacity of 28 cubic feet or 1.02 cubic yards per minute. This work is all done by one man.

The efficiency of this one-man control is due to the fact that all equipments are controlled from the operating platform. From this point the operator can govern the vertical movement of the elevator as well as its travel along the road when folded back for shipping.

Value

The Austin Self-Feeding Wagon Loader materially reduces the cost of handling such material as coal, gravel, sand, etc., in two distinct ways—by reducing the number of men required to load the trucks, and by keeping the trucks working instead of waiting.

The comparative costs of loading trucks by man power and by means of an Austin Self-Feeding Wagon Loader are shown in the following tables:

COST OF LOADING TRUCKS BY MAN POWER

8 Laborers—5 yards—20 min.—at 55c per hr.....	\$1.47
Cost of truck for 20 minutes at \$2.50 per hour.....	.83
Cost of loading 5 yards of material in truck.....	\$2.30
Cost of loading 1 yard of material in truck.....	.46

COST OF LOADING TRUCKS BY MEANS OF AUSTIN SELF-FEEDING WAGON LOADER

One Laborer—5 yards—6 min.—at 55c per hour.....	\$0.06
Cost of truck for 6 min. at \$2.50 per hour.....	.25
Power at 1 cent per cubic yard.....	.05
Oil, grease, interest on investment, etc.....	.01
Cost of loading 5 yards of material in truck.....	.37
Cost of loading 1 yard of material in truck.....	.074

In addition to the saving in the cost of loading trucks, the Austin Self-Feeding Wagon Loader also brings about a saving in investment. Since this wagon loader makes the truck stand idle only six minutes while being loaded, one truck can do the work of three trucks which are loaded by laborers. This saving of the investment for only one truck enables the Austin Self-Feeding Wagon Loader to pay for itself at the start due to the fact that the cost of the Austin Loader is approximately the same as the cost of one good truck.

AUSTIN MACHINERY CORPORATION

RAILWAY EXCHANGE BUILDING, CHICAGO, ILL.

AUSTIN SELF-FEEDING WAGON LOADER

Construction

In order that the Austin Self-Feeding Wagon Loader may have sufficient reserve power to give good service under all conditions it is equipped with a 22-horse power four-cylinder marine type gasoline engine.

If electric power is preferred an electric motor can be furnished. These motors are either A. C. or D. C. current and are rated at 15 H. P.

The front wheels are knuckled to the axle, on the same plan so successfully used in automobile truck construction.

The operating machinery consists of a direct drive chain and gear transmission, giving elevator operation, and two-speed and reverse traction. The low or feeding speed is provided for use under working conditions while the high is for traveling.

The rear axle is fitted with a differential so that the machine can be turned practically within its own length. All of the gears, castings and sprockets are made of cast steel. The shafts are of steel, the main frame of structural and the bucket chains are Ley bushed.

The following table covers the specifications for the Austin Self-Feeding Wagon Loader.

SPECIFICATIONS

Frame—Structural Steel
Elevator Chain—Double Strand No. 823 Ley bushed chain.
Drive Chain—SS—525 link belt.
Buckets—18 x 8 x 8½ in. buckets spaced 20 in. on chain. Capacity, ½ cu. ft.
Drive—22 H.P. four-cylinder gasoline engine or 15 H.P. Electric Motor.
Traction—Working speed 70 ft. forward and 28 ft. into pile per minute.
Traveling—140 ft. per minute forward, 70 ft. reverse.
Controls—All operations under friction clutch control.
Wheels—Rear, 42 x 6 in.; Front, 27 x 4 in.
Gauge—5 ft. 2 in.
Height of Discharge—8 ft. or 9 ft. 6 in.
Capacity—1¾ cu. yd. per minute under proper operating conditions.
Weight—8,300 lbs.

Operation

The operation of the Austin Self-Feeding Wagon Loader is extremely simple when it is on the road traveling from job to job as well as when it is loading trucks. A platform is provided for the operator from which the steering wheel and all the levers are readily accessible. The elevator is raised when traveling to give ample clearance. A speed of seven-eighths of a mile per hour is attained in traveling under its own power.

The upper illustration in the opposite column on this page shows the Austin Wagon Loader with the elevator in the normal position for operation. The steel feeding arms are shown in this view extended to the extreme open position—a distance of six feet. When the Loader is in operation these steel feeding arms sweep inward, carrying the material into the bucket path and automatically withdrawing in preparation for the next cut. The second illustration on this page shows the steel feeding arms in the closed position.

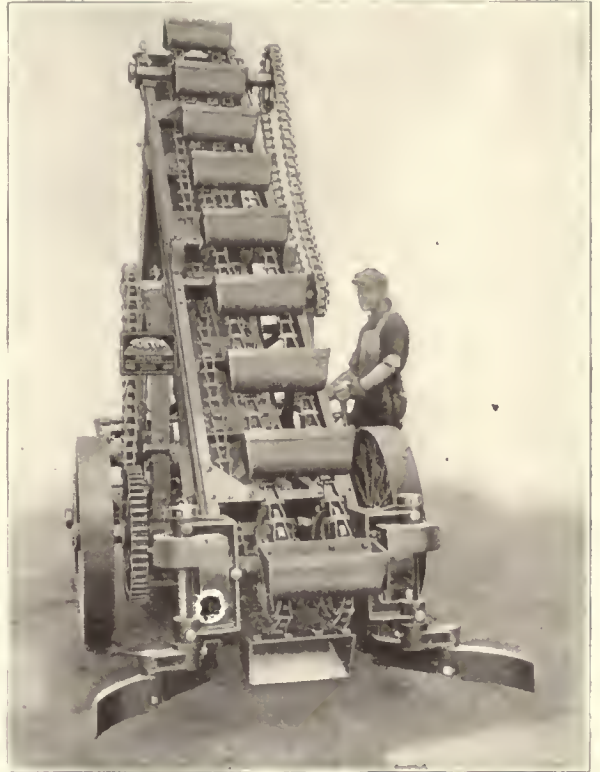

Austin Wagon Loader with Steel Feeding Arms Open

The continuous sweeping operation of the steel feeding arms and the automatic backing of the machine into the bank makes possible the filling of each bucket to the brim. Furthermore, the feeding arms will cut a path wide enough for the machine to follow as it works back into the pile. This self-feeding device takes the place of two men who would otherwise be required to feed the buckets.

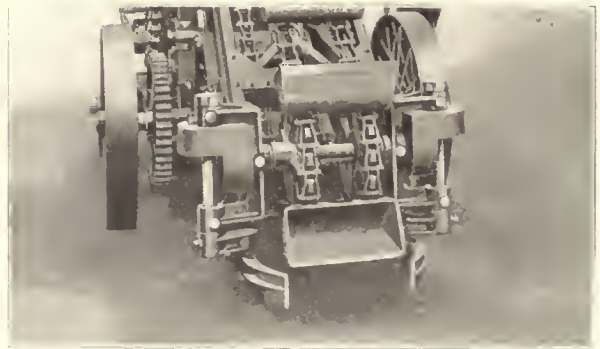

Showing Steel Feeding Arms Closed

Attachments

The Austin Self-Feeding Wagon Loader is usually equipped with a spout for loading wagons and trucks, as shown in the illustrations on the preceding page. However, it can be furnished with a bin, of one cubic yard capacity or with a spout and gate for loading wheelbarrows. A discharging spout is also made with a dust screen for catching the dust when loading hard coal.

AUSTIN MACHINERY CORPORATION
RAILWAY EXCHANGE BUILDING, CHICAGO, ILL.

THE SCOOP CONVEYOR

The Scoop Conveyor

An original "belt type" of portable material handling conveyor designed to be moved and operated by one man.

Its predominating distinctive feature is the feed end which can be pushed and completely buried into the material to be conveyed, thus allowing the material to be scraped on to the carrying belt instead of being lifted by shovel into a feed hopper. This saves 50% labor in feeding.

Our experienced organization, together with our financial and moral responsibility, stand back of every machine we produce. All parts, except the motor, belt and drive chain, are manufactured in our own spacious factory under modern standardization and quantity production methods.

The scoop conveyor is used for moving loose materials, such as coal, coke, crushed stone, ashes, sand, gravel, etc.; also, sacks, packages, boxes and manufactured products. Adapted for service in retail coal yards: for unloading cars direct into trucks, bins, etc.; for loading cars, barges or holds of vessels from trucks, storage piles or ground; for filling in or extending embankments: for moving material from place to place.

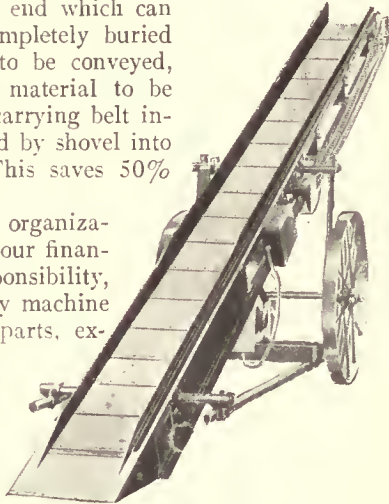

The Scoop Conveyor



Unloading and Storing Coal.

general use in limited space. The 20 ft. and the 24 ft. sizes are suitable for loading and unloading trucks or cars, and for stacking material. The size most suitable is controlled by the height and reach required to meet operating conditions.

The nature of the material and the height to which it must be raised govern the kind of a belt required. There are two kinds of belts, the low cleat and the high flight.

Guarantee

All parts guaranteed against defects in workmanship and material. In addition, we guarantee that scoop conveyor repair costs through wear, including belt renewals will not exceed 1c per ton of material handled when conveying coal, coke, ashes, sand or similar material.

A reputation founded on years of experience and reflected by the confidence of thousands of users absolute dependability.

When Writing or Ordering

State operating conditions; kind of material to be handled; power available; where material is received and delivered, etc.



Loading Truck from Storage.

Some Construction Details

The "Scoop" conveyor can be furnished either with gasoline engine or electric motor as power. If the purchaser supplies the motor, a motor support and drive from the motor shaft is supplied with the conveyor. Drive reductions are carried in stock for any motor speed from 700 r.p.m. to 1,800 r.p.m.

The capacity of a "Scoop" conveyor is 1 ton per minute; the weight ranges from 800 to 1,600 lbs.; horsepower 2 and 3 h.p. The following table gives the general dimensions of the "Scoop" conveyor.

The 14 ft. size conveyor is suitable for loading and unloading box cars, or loading industrial cars and for

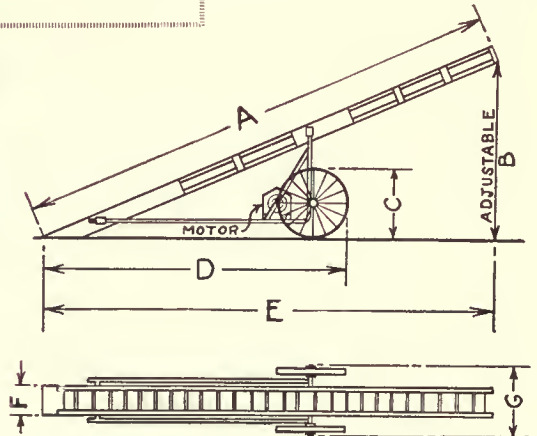

DETAILS AND DIMENSIONS, SCOOP CONVEYORS

Size	A	B	C	D	E	F	G
12" x 14'	14'	4' to 6'	42"	9' 6"	12' 5"	17"	43"
16" x 14'	14'	4' to 6'	42"	9' 6"	12' 5"	21"	47"
12" x 20'	20'	6' to 9'	42"	12' 0"	18' 3"	17"	43"
16" x 20'	20'	6' to 9'	42"	12' 0"	18' 3"	21"	47"
12" x 24'	24'	9' to 12'	42"	13' 3"	22' 6"	17"	43"
16" x 24'	24'	9' to 12'	42"	13' 3"	22' 6"	21"	47"
12" x 30'	30'	12' to 15'	42"	16' 6"	27' 0"	17"	43"
16" x 30'	30'	12' to 15'	42"	16' 6"	27' 0"	21"	47"

TRADE NAME INDEX

- BERQUIST** Coal Bins—Link-Belt Co.
B-G Portable Conveyors and Bucket Loaders—Barber-Greene Co.
BROWNHOIST Locomotive Cranes—Brown Hoisting Machinery Co.
BULLDOG Buckets—Blaw-Knox Co.
- C-M** Cranes and Hoists—Chisholm & Moore Mfg. Co.
CATERPILLAR Tractors—Holt Mfg. Co.
COLLIER Buckets—Blaw-Knox Co.
CYCLONE Hoists—Chisholm-Moore Mfg. Co.
- DODGE** System Coal Storage—Link-Belt Co.
DREADNAUGHT Buckets—Blaw-Knox Co.
- EASY SLIDE** Weighted Take-Up for Belt Conveyors—Merriek Scale Mfg. Co.
ELECTROMOBILE Industrial Trucks and Tractors—Koppel Industrial Car and Equipment Co.
EWART Friction Clutches—Link-Belt Co.
EXIDE-IRONCLAD Storage Batteries—Electric Storage Battery Co.
- FAVORITE** Buckets—G. H. Williams Co.
FLINT-RIM Wheels—Link-Belt Co.
- G-E** Electric Equipment and Locomotives—General Electric Co.
- HARRINGTON** Rocking Cableways—Railway & Industrial Engineering Co.
HERCULES Buckets—G. H. Williams Co.
HERCULES Wire Rope—A Leschen & Sons Rope Co.
HUGGER Belt Conveyor Drive—Link-Belt Co.
- IDEAL** Industrial Trucks and Tractors—Binghamton Electric Truck Co.
INTERVEYORS, Portable Conveyor—Brown Portable Conveying Mach'y. Co.
- LABRIDE** Cranes, Bridges for Handling Coal, Etc.—Lakeside Bridge & Steel Co.
LETTGO Mechanical Overload Release—Link-Belt Co.
LUHRIG Elevators—Link-Belt Co.
- MATCHLESS** Trolleys—Chisholm & Moore Mfg. Co.
MICRO Leveling Elevators—Otis Elevator Co.
MULTIROLL Idlers (for Belt Conveyors)—Link-Belt Co.
- P. & H.** Cranes and Hoists—Pawling & Harnischfeger Co.
PECK Pivoted Bucket Carrier—Link-Belt Co.
PORTABELT Portable Conveyors—Brown Portable Conveying Mach'y. Co.
PRATT Box Car Loaders—Link-Belt Co.
- RED BAND** Electric Motors—Howell Electric Motors Co.
ROCHLITZ Automatic Water Still—W. M. Laler Co.
- SCOOP** Conveyors—Portable Machinery Co.
SERVICE Brand Conveyor Belt—Link-Belt Co.
SHAW Cranes—Manning, Maxwell & Moore, Inc.
SOLIDCAR Self Dumping Cages—Car-Dumper & Equipment Co.
SPECIAL STEEL Wire Rope—A. Leschen & Sons Rope Co.
SPEEDSTER Buckets—Blaw-Knox Co.
STEVEDORE Manila Rope—C. W. Hunt Co., Inc.
STROM Ball Bearings—U. S. Ball Bearing Mfg. Co.
SUBVEYORS Conveyors—Samuel Olson & Co.
- TIERLIFT** Industrial Truck—Lakewood Engineering Co.
TRACKLESS TRAIN Tractors and Trailers—Mercury Mfg. Co.
TRENTON-BLEICHERT Aerial Tramway Systems—American Steel & Wire Co.
TRIBLOC Chain Hoists—Ford Chain Block Co.
TWYNOCONE Friction Clutches—Link-Belt Co.
- UNIROLL** Idlers (for Belt Conveyors)—Link-Belt Co.
- WEIGHTOMETER** Automatic Conveyor Scales—Merriok Mfg. Co.

DIRECTORY OF PRODUCTS

ADJUSTABLE LOADING CHUTES
(See Chutes)

AERIAL TRAMWAYS
American Steel & Wire Co.
Chisholm-Moore Mfg. Co.
Ford Chain Block Co.
Lakeside Bridge & Steel Co.
A. Leschen & Sons Rope Co.
Link-Belt Co.
Herbert Morris, Inc.

AIR COMPRESSORS
(See Compressors, Air)

AIR HOISTS
(See Hoists, Pneumatic)

APRON CONVEYORS
(See Conveyors, Apron)

ARM ELEVATORS
(See Elevators, Arm)

ASH CONVEYORS
(See Conveyors, Ash)

ASH HOISTS
(See Hoists, Ash)

AUTOMATIC ELEVATORS
(See Elevators, Automatic)

AUTOMATIC RAILWAYS
(See Railways, Automatic)

AUTOMOBILE TRUCKS
(See Trucks, Motor)

BACKFILLERS
Austin Machinery Corpn.
Pawling & Harnischfeger Co.

BAGGING DEVICES FOR COAL, ETC.
Link-Belt Co.

BARREL ELEVATORS
(See Elevators, Barrel)

BARROWS
Geo. P. Clark Co.

BATTERIES, STORAGE
Edison Storage Battery Co.
Electric Storage Battery Co.

BATTERY CHARGING APPARATUS
General Electric Co.
W. M. Lator Co.

BEARINGS, BALL
U. S. Ball Bearing Mfg. Co.

BEARINGS, ROLLER
Hyatt Roller Bearing Co.

BEARINGS, THRUST
U. S. Ball Bearing Mfg. Co.

BELT CONVEYORS
(See Conveyors, Belt)

BELTS FOR CONVEYORS
Haslett Spiral Chute Co.
Link-Belt Co.
Samuel Olson & Co.
Palmer-Bee Co.

BINS, COAL
(See Bunkers, Coal)

BLAST FURNACE HOISTS
C. O. Bartlett & Snow Co.
R. H. Beaumont Co.
C. W. Hunt Co.
Link-Belt Co.
Otis Elevator Co.

BLOCKS
(See Tackle Blocks)

BLOWERS
General Electric Co.

BODIES, DUMP, ETC., FOR MOTOR TRUCKS
White Co.

BOX CAR LOADERS
(See Loaders, Box Car)

BRIDGES, COAL
Brown Hoisting Machinery Co.
C. W. Hunt Co.
Lakeside Bridge & Steel Co.

Link-Belt Co.
Mead-Morrison Mfg. Co.

BUCKETS, BOTTOM DUMP
Blaw-Knox Co.
C. W. Hunt Co.
Lakewood Engineering Co.
Link-Belt Co.
Herbert Morris, Inc.
Vulcan Iron Works, Inc.

BUCKETS, CLAM SHELL
Austin Machinery Corpn.
Blaw-Knox Co.
Brown Hoisting Machinery Co.
Hayward Co.
C. W. Hunt Co.
Lakewood Engineering Co.
Link-Belt Co.
Mead-Morrison Mfg. Co.
Northern Engineering Works
Owen Bucket Co.
Vulcan Iron Works, Inc.
G. H. Williams Co.

BUCKETS, DRAG LINE
Austin Machinery Corpn.
Blaw-Knox Co.
Brown Hoisting Machinery Co.
Hayward Co.
Lakewood Engineering Co.
Sauerman Bros.
Vulcan Iron Works, Inc.
G. H. Williams Co.

BUCKETS, ELECTRIC MOTOR
Blaw-Knox Co.
Hayward Co.

BUCKETS FOR ELEVATOR—CONVEYORS
Austin Machinery Corpn.
C. O. Bartlett & Snow Co.
Brown Portable Conveying Machinery Co.
C. W. Hunt Co.
Lakewood Engineering Co.
Link-Belt Co.
Samuel Olson & Co.
Palmer-Bee Co.
Fowell Pressed Steel Co.
Stearns Conveyor Co.

BUCKETS, ORANGE PEEL
Austin Machinery Corpn.
Blaw-Knox Co.
Hayward Co.
Lakewood Engineering Co.
Mead-Morrison Mfg. Co.
Vulcan Iron Works, Inc.
G. H. Williams Co.

BUNKERS, COAL
C. O. Bartlett & Snow Co.
R. H. Beaumont Co.
Brown Hoisting Machinery Co.
C. W. Hunt Co.
Lakeside Bridge & Steel Co.
Link-Belt Co.
Mead-Morrison Mfg. Co.
Vulcan Iron Works, Inc.

CABLE
(See Wire Rope)

CABLE CONVEYORS
(See Conveyors, Cable)

CABLE EXCAVATORS
Blaw-Knox Co.
Clyde Iron Works
Hayward Co.
Link-Belt Co.
Mead-Morrison Mfg. Co.
Sauerman Bros.

CABLE RAILWAYS
(See Railways, Cable)

CABLEWAYS
American Steel & Wire Co.
Blaw-Knox Co.
Clyde Iron Works
Sauerman Bros.

CABLEWAYS, ROCKING
Railway & Industrial Eng. Co.

CARS, ANNEALING FURNACE
Easton Car & Construction Co.
Koppel Industrial Car & Equipment Co.

CARS, CABLE
Easton Car and Construction Co.
Hunt Co., C. W.
Koppel Industrial Car & Equipment Co.
Mead-Morrison Mfg. Co.

CARS, CHARGING
C. O. Bartlett & Snow Co.
George P. Clark Co.
Easton Car & Construction Co.
C. W. Hunt Co.
Koppel Industrial Car & Equipment Co.
Lakewood Engineering Co.

CARS, CREOSOTING
Easton Car & Construction Co.
Koppel Industrial Car & Equipment Co.

CARS, DUMP
Easton Car & Construction Co.
C. W. Hunt Co.
Koppel Industrial Car & Equipment Co.
Lakewood Engineering Co.

CARS, FLAT
Easton Car & Construction Co.
Koppel Industrial Car & Equipment Co.

CARS, FOUNDRY
George P. Clark Co.
Easton Car & Construction Co.
C. W. Hunt Co.
Koppel Industrial Car & Equipment Co.
Lakewood Engineering Co.

CARS, HOPPER
Easton Car & Construction Co.
Koppel Industrial Car & Equipment Co.
Lakewood Engineering Co.

CARS, INDUSTRIAL
Austin Machinery Corpn.
George P. Clark Co.
Easton Car & Construction Co.
C. W. Hunt Co.
Koppel Industrial Car & Equipment Co.
Lakewood Engineering Co.
Link-Belt Co.
Herbert Morris, Inc.
Northern Engineering Works

CARS, LOGGING
Easton Car & Construction Co.
C. W. Hunt Co.
Koppel Industrial Car & Equipment Co.

CARS, MINE
Easton Car & Construction Co.
C. W. Hunt Co.
Koppel Industrial Car & Equipment Co.

CARS, ORE
Brown Hoisting Machinery Co.
Easton Car & Construction Co.
C. W. Hunt Co.
Koppel Industrial Car & Equipment Co.

CARS, PLANTATION
Easton Car & Construction Co.
Koppel Industrial Car & Equipment Co.

CARS, PLATFORM
Easton Car & Construction Co.
C. W. Hunt Co.
Koppel Industrial Car & Equipment Co.
Lakewood Engineering Co.

CARS, QUARRY
Easton Car & Construction Co.
Koppel Industrial Car & Equipment Co.

CARS, SCOOP
Easton Car & Construction Co.
Koppel Industrial Car & Equipment Co.

CARS, SKIP
Easton Car & Construction Co.
C. W. Hunt Co.
Koppel Industrial Car & Equipment Co.

CARS, STEEL MILL
C. O. Bartlett & Snow Co.
George P. Clark Co.
Easton Car & Construction Co.
C. W. Hunt Co.
Koppel Industrial Car & Equipment Co.
Lakewood Engineering Co.

CARS, TRANSFER
Easton Car & Construction Co.
C. W. Hunt Co.
Koppel Industrial Car & Equipment Co.

CAR HAULS AND PULLERS
C. O. Bartlett & Snow Co.
Clyde Iron Works
Easton Car & Construction Co.
C. W. Hunt Co.
Link-Belt Co.
Mead-Morrison Mfg. Co.
Herbert Morris, Inc.
Northern Engineering Works
Sprague Electric Works

CARRIERS, PNEUMATIC
Lamson Co.

CARRIERS, WIRE LINE
Chisholm-Moore Mfg. Co.
Lamson Co.

CARTS, HAND
George P. Clark Co.
Lakewood Engineering Co.
Mercury Manufacturing Co.

CASTERS
Brown Portable Conveying Machinery Co.
George P. Clark Co.
Mercury Manufacturing Co.
Terry Manufacturing Co.

CENTRIFUGAL DISCHARGE ELEVATORS
(See Elevators, Bucket)

CHAIN FOR CONVEYORS
C. O. Bartlett & Snow Co.
Brown Portable Conveying Machinery Co.
C. W. Hunt Co.
Samuel Olson & Co.
Palmer-Bee Co.
Standard Conveyor Co.
Stearns Conveyor Co.

CHAIN BLOCKS
(See Hoists, Chain)

CHAIN HOISTS
(See Hoists, Chain)

CHUTES, ADJUSTABLE LOADING
C. O. Bartlett & Snow Co.
Haslett Spiral Chute Co.
C. W. Hunt Co.
Lamson Co.
Link-Belt Co.
Standard Conveyor Co.

CHUTES, SPIRAL
Haslett Spiral Chute Co.
C. W. Hunt Co.
Lamson Co.
Samuel Olson & Co.
Otis Elevator Co.
Palmer-Bee Co.
Standard Conveyor Co.

CLAM SHELL BUCKETS
(See Buckets, Clam Shell)

COAL BRIDGES
Brown Hoisting Machinery Co.
C. W. Hunt Co.
Lakeside Bridge & Steel Co.
Link-Belt Co.
Manning, Maxwell & Moore, Inc.
Mead-Morrison Mfg. Co.
Shepard Electric Crane & Hoist Co.

COAL BUNKERS
(See Bunkers, Coal)

COAL CRUSHERS
C. O. Bartlett & Snow Co.
R. H. Beaumont Co.
C. W. Hunt Co.
Link-Belt Co.
Mead-Morrison Mfg. Co.

COAL HOISTING TOWERS
C. W. Hunt Co.
Link-Belt Co.
Mead-Morrison Mfg. Co.

COAL TIPPLES
C. O. Bartlett & Snow Co.
Lakeside Bridge & Steel Co.
Link-Belt Co.
Stearns Conveyor Co.

COMPRESSED AIR LOCOMOTIVES
(See Locomotives, Compressed Air)

COMPRESSORS, AIR
General Electric Co.

DIRECTORY OF PRODUCTS

CONTAINERS, MACHINES FOR SEALING

National Binding Machine Co.

CONTINUOUS BUCKET ELEVATORS

(See Elevators, Bucket)

CONTROLLERS, ELECTRIC

General Electric Co.
Ohio Electric & Controller Co.
Westinghouse Elec. & Mfg. Co.

CONVEYORS, APRON

C. O. Bartlett & Snow Co.
Brown Portable Conveying Machinery Co.
Haslett Spiral Chute Co.
C. W. Hunt Co.
Lamson Co.
Link-Belt Co.
McKinney-Harrington Co.
Samuel Olson & Co.
Palmer-Bee Co.
Standard Conveyor Co.
Stearns Conveyor Co.

CONVEYORS, ASH

C. O. Bartlett & Snow Co.
C. W. Hunt Co.
Link-Belt Co.
Mead-Morrison Mfg. Co.
Samuel Olson & Co.
Palmer-Bee Co.
Portable Machinery Co.

CONVEYORS, BELT

Barber-Greene Co.
C. O. Bartlett & Snow Co.
Brown Portable Conveying Machinery Co.
Haslett Spiral Chute Co.
C. W. Hunt Co.
Lakeside Bridge & Steel Co.
Lamson Co.
Link-Belt Co.
McKinney-Harrington Co.
Samuel Olson & Co.
Palmer-Bee Co.
Portable Machinery Co.
Standard Conveyor Co.
Stearns Conveyor Co.

CONVEYORS, CABLE

C. O. Bartlett & Snow Co.
R. H. Beaumont Co.
Lamson Co.
Link-Belt Co.
Mead-Morrison Mfg. Co.
Samuel Olson & Co.
Palmer-Bee Co.

CONVEYORS, FLIGHT

C. O. Bartlett & Snow Co.
Brown Portable Conveying Machinery Co.
Haslett Spiral Chute Co.
C. W. Hunt Co.
Lamson Co.
Link-Belt Co.
Palmer-Bee Co.
Standard Conveyor Co.
Stearns Conveyor Co.

CONVEYORS, GRAVITY ROLLER

Haslett Spiral Chute Co.
Lamson Co.
Mead-Morrison Mfg. Co.
Samuel Olson & Co.
Palmer-Bee Co.
Standard Conveyor Co.

CONVEYORS, HAULAGE

C. O. Bartlett & Snow Co.
Clyde Iron Works
C. W. Hunt Co.
Lamson Co.
Link-Belt Co.
Samuel Olson & Co.
Palmer-Bee Co.
Standard Conveyor Co.

CONVEYORS, PAN

C. O. Bartlett & Snow Co.
Haslett Spiral Chute Co.
C. W. Hunt Co.
Lamson Co.
Link-Belt Co.
Samuel Olson & Co.
Palmer-Bee Co.
Stearns Conveyor Co.

CONVEYORS, PIVOTED BUCKET CARRIER

C. O. Bartlett & Snow Co.
Haslett Spiral Chute Co.
C. W. Hunt Co.
Link-Belt Co.
Mead-Morrison Mfg. Co.
Samuel Olson & Co.
Palmer-Bee Co.
Stearns Conveyor Co.

CONVEYORS, PLATFORM

C. O. Bartlett & Snow Co.
Brown Portable Conveying Machinery Co.
Haslett Spiral Chute Co.
C. W. Hunt Co.
Lamson Co.
Link-Belt Co.
Palmer-Bee Co.
Standard Conveyor Co.
Stearns Conveyor Co.

CONVEYORS, PNEUMATIC

Lamson Co.

CONVEYORS, PORTABLE

Austin Machinery Corp.
Barber-Greene Co.
Brown Portable Conveying Machinery Co.
Link-Belt Co.
McKinney-Harrington Co.
Samuel Olson & Co.
Portable Machinery Co.

CONVEYORS, PUSH BAR

Haslett Spiral Chute Co.
Samuel Olson & Co.
Palmer-Bee Co.
Standard Conveyor Co.

CONVEYORS, RETARDING

C. O. Bartlett & Snow Co.
Haslett Spiral Chute Co.
Link-Belt Co.
Samuel Olson & Co.
Palmer-Bee Co.

CONVEYORS, SCREW

C. O. Bartlett & Snow Co.
Link-Belt Co.
Samuel Olson & Co.
Palmer-Bee Co.
Stearns Conveyor Co.

CONVEYORS, WIRE LINE

(Chisholm-Moore Mfg. Co.
Lamson Co.

CORRUGATED CONTAINERS, MACHINES FOR SEALING

National Binding Machine Co.

CRANE TRUCKS, ELECTRIC

(See Trucks, Crane, Electric)

CRANES, FULL CIRCLE

Dravo Contracting Co.
Terry Manufacturing Co.

CRANES, GANTRY

Brown Hoisting Machinery Co.
Chisholm-Moore Mfg. Co.
Cleveland Crane & Eng. Co.
Clyde Iron Works
C. W. Hunt Co.
Lakeside Bridge & Steel Co.
Herbert Morris Crane & Hoist Co.
Manning, Maxwell & Moore, Inc.
Mead-Morrison Mfg. Co.
Northern Engineering Works
Pawling & Harnischfeger Co.

CRANES, JIB

Brown Hoisting Machinery Co.
Chisholm-Moore Mfg. Co.
Clyde Iron Works
Lakeside Bridge & Steel Co.
Manning, Maxwell & Moore, Inc.

Herbert Morris, Inc.
Northern Engineering Works
Palmer-Bee Co.
Pawling & Harnischfeger Co.
Shepard Electric Crane & Hoist Co.
Terry Manufacturing Co.

CRANES, LOCOMOTIVE

Austin Machinery Corp.
Brown Hoisting Machinery Co.
Herbert Morris, Inc.
Link-Belt Co.
Pawling & Harnischfeger Co.

CRANES, MOTOR TRUCK

Mead-Morrison Mfg. Co.

CRANES, OVERHEAD TRAVELING, BRIDGE, ELECTRICALLY OPERATED

Brown Hoisting Machinery Co.
Chesaapeake Iron Works
Chisholm-Moore Mfg. Co.
Cleveland Crane & Eng. Co.
Euclid Crane & Hoist Co.
C. W. Hunt Co.
Lakeside Bridge & Steel Co.

Manning, Maxwell & Moore, Inc.
Herbert Morris, Inc.
Northern Engineering Works
Shepard Electric Crane & Hoist Co.
Sprague Electric Works

CRANES, OVERHEAD TRAVELING, BRIDGE, HAND OPERATED

Brown Hoisting Machinery Co.
Chisholm-Moore Mfg. Co.
Cleveland Crane & Eng. Co.
C. W. Hunt Co.
Lakeside Bridge & Steel Co.
Manning, Maxwell & Moore, Inc.
Maris Bros.
Herbert Morris, Inc.
Northern Engineering Works
Palmer-Bee Co.
Reading Chain & Block Corp.
Shepard Electric Crane & Hoist Co.

CRANES, PILLAR

Brown Hoisting Machinery Co.
Chisholm-Moore Mfg. Co.
Clyde Iron Works
Lakeside Bridge & Steel Co.
Herbert Morris, Inc.
Northern Engineering Works
Pawling & Harnischfeger Co.

CRANES, PILLAR JIB

Brown Hoisting Machinery Co.
Chisholm-Moore Mfg. Co.
Lakeside Bridge & Steel Co.
Herbert Morris, Inc.
Northern Engineering Works
Pawling & Harnischfeger Co.

CRANES, STATIONARY REVOLVING TYPE

Brown Hoisting Machinery Co.
Clyde Iron Works
Dravo Contracting Co.
Lakeside Bridge & Steel Co.
Herbert Morris, Inc.
Northern Engineering Works
Pawling & Harnischfeger Co.
Terry Manufacturing Co.

CRANES, TRACTOR

Austin Machinery Corp.
Pawling & Harnischfeger Co.
Terry Manufacturing Co.

CRANES, WALL

Brown Hoisting Machinery Co.
Chisholm-Moore Mfg. Co.
Clyde Iron Works
Euclid Crane & Hoist Co.
Lakeside Bridge & Steel Co.
Manning, Maxwell & Moore, Inc.
Herbert Morris, Inc.
Northern Engineering Works
Pawling & Harnischfeger Co.
Terry Manufacturing Co.

CROSSINGS, RAILROAD (INDUSTRIAL RAILWAY)

Easton Car & Construction Co.
Koppel Industrial Car & Equipment Co.
Lakewood Engineering Co.

DERRICK FITTINGS

American Steel & Wire Co.
Clyde Iron Works
Dravo Contracting Co.
C. W. Hunt Co.
Herbert Morris, Inc.
Terry Manufacturing Co.

DERRICK SWINGERS

Clyde Iron Works
Dravo Contracting Co.
Mead-Morrison Mfg. Co.
Terry Manufacturing Co.

DERRICKS

Clyde Iron Works
Dravo Contracting Co.
C. W. Hunt Co.
Lakeside Bridge & Steel Co.
Mead-Morrison Mfg. Co.
Herbert Morris, Inc.
Northern Engineering Works
Terry Manufacturing Co.

DERRICKS, BARGE

Dravo Contracting Co.
Terry Manufacturing Co.

DERRICKS, GUY

Clyde Iron Works
Dravo Contracting Co.
Terry Manufacturing Co.

DERRICKS, STIFF LEG

Clyde Iron Works
Dravo Contracting Co.
Terry Manufacturing Co.

DERRICKS, TRAVELING

Clyde Iron Works
Dravo Contracting Co.
Hayward Co.
Lakeside Bridge & Steel Co.
Manning, Maxwell & Moore, Inc.
Mead-Morrison Mfg. Co.
Terry Manufacturing Co.

DISTILLING APPARATUS

W. M. Lalor Co.

DRAG LINE SCRAPERS

R. H. Beaumont Co.
Sauerman Bros.

DUMP BODY INDUSTRIAL TRUCKS

(See Trucks, Industrial, Dump Body)

DUMP BODIES, MOTOR TRUCKS

White Co.

DUMP CARS

Easton Car & Construction Co.
C. W. Hunt Co.
Koppel Industrial Car & Equipment Co.
Lakewood Engineering Co.

DUMPERS, CAR

Brown Hoisting Machinery Co.
Car-Dumper & Equipment Co.
Link-Belt Co.
Mead-Morrison Mfg. Co.

ELECTRIC FREIGHT ELEVATORS

(See Elevators, Freight)

ELECTRIC LOCOMOTIVES

(See Locomotives, Electric)

ELECTRIC MOTORS

General Electric Co.
Howell Electric Motors Co.
Sprague Electric Works
Westinghouse Elec. & Mfg. Co.

ELEVATING TRUCKS, INDUSTRIAL

(See Trucks)

ELEVATORS, FREIGHT, AUTOMATIC

Otis Elevator Co.
H. J. Reedy Co.
Watson Elevator Co.

ELEVATORS, BARREL

C. O. Bartlett & Snow Co.
Brown Portable Conveying Machinery Co.
Haslett Spiral Chute Co.
Lamson Co.
Link-Belt Co.
Samuel Olson & Co.
Palmer-Bee Co.
Standard Conveyor Co.
Stearns Conveyor Co.

ELEVATORS, BUCKET

C. O. Bartlett & Snow Co.
R. H. Beaumont Co.
Haslett Spiral Chute Co.
C. W. Hunt Co.
Lamson Co.
Link-Belt Co.
Mead-Morrison Mfg. Co.
Samuel Olson & Co.
Palmer-Bee Co.
Stearns Conveyor Co.

ELEVATORS, FREIGHT

Otis Elevator Co.
H. J. Reedy Co.
Watson Elevator Co.

ELEVATORS, INCLINED BUCKET

C. O. Bartlett & Snow Co.
Brown Portable Conveying Machinery Co.
Haslett Spiral Chute Co.
C. W. Hunt Co.
Lamson Co.
Lakeside Bridge & Steel Co.
Link-Belt Co.
McKinney-Harrington Co.
Samuel Olson & Co.
Palmer-Bee Co.
Standard Conveyor Co.
Stearns Conveyor Co.

DIRECTORY OF PRODUCTS

ELEVATORS, PORTABLE

Barber-Greene Co.
C. O. Bartlett & Snow Co.
Brown Portable Conveying Machinery Co.
Haslett Spiral Chute Co.
Lamson Co.
Link-Belt Co.
McKinney-Harrington Co.
Samuel Olson & Co.
Palmer-Bee Co.

ELEVATORS, SIDEWALK

Otis Elevator Co.
H. J. Reedy Co.
Watson Elevator Co.

ENGINES, HOISTING

(See Hoisting Engines)

ESCALATORS

Otis Elevator Co.

EXCAVATORS, CABLEWAY

Clyde Iron Works
Hayward Co.
Link-Belt Co.
Sauerman Bros.

EXCAVATORS, DITCH AND TRENCH

Austin Machinery Corpn.
Clyde Iron Works
Pawling & Harnischfeger Co.

EXCAVATORS, DRAGLINE

Austin Machinery Corpn.
Dravo Contracting Co.
Hayward Co.
Link-Belt Co.
Pawling & Harnischfeger Co.
Sauerman Bros.

FIBRE CONTAINERS. MACHINES FOR SEALING

National Binding Machine Co.

FIRELESS LOCOMOTIVES

(See Locomotives, Fireless)

FLIGHT CONVEYORS

(See Conveyors, Flight)

FREIGHT ELEVATORS

(See Elevators, Freight)

FROGS, FOR INDUSTRIAL RAILWAYS

Easton Car & Construction Co.
Koppel Industrial Car & Equipment Co.
Lakewood Engineering Co.

GANTRY CRANES

(See Cranes, Gantry)

GASOLINE HOISTING ENGINES

(See Hoisting Engines, Gasoline)

GASOLINE TRUCKS AND TRACTORS

(See Trucks and Tractors)

GENERATORS FOR LIFTING MAGNETS

General Electric Co.
Westinghouse Elec. & Mfg. Co.

GRAB BUCKETS

(See Buckets)

GRAPPLES

Blaw-Knox Co.
Hayward Co.
Lakewood Engineering Co.
Mead-Morrison Mfg. Co.
Owen Bucket Co.
Vulcan Iron Works, Inc.
G. H. Williams Co.

GRAVITY ROLLER CONVEYORS

(See Conveyors, Gravity Roller)

GRAVITY SPIRAL CONVEYORS

Haslett Spiral Chute Co.
Lamson Co.
Otis Elevator Co.
Samuel Olson & Co.
Palmer-Bee Co.
Standard Conveyor Co.

HAND HOISTS

(See Hoists)

HAND LIFT TRUCKS

(See Trucks, Hand Lift)

HAND TRUCKS

(See Trucks, Hand)

HAULS, CAR

(See Car Hauls)

HAULAGE CONVEYORS

(See Conveyors, Haulage)

HOISTING ENGINES, ELECTRIC

Clyde Iron Works
C. W. Hunt Co.
Mead-Morrison Mfg. Co.
Northern Engineering Works
H. J. Reedy Co.
Vulcan Iron Works, Inc.

HOISTING ENGINES, GASOLINE

Clyde Iron Works
Mead-Morrison Mfg. Co.

HOISTING ENGINES, STEAM

Clyde Iron Works
C. W. Hunt Co.
Mead-Morrison Mfg. Co.
H. J. Reedy Co.

HOISTS, AIR

(See Hoists, Pneumatic)

HOISTS, CHAIN

Chisholm-Moore Mfg. Co.
Ford Chain Block Co.
Herbert Morris, Inc.
Palmer-Bee Co.
Reading Chain & Block Corpn.
Wright Manufacturing Co.

HOISTS, ELECTRIC, CAGE OPERATED

Brown Hoisting Machinery Co.
Cleveland Crane & Eng. Co.
Lakeside Bridge & Steel Co.
Link-Belt Co.
Manning, Maxwell & Moore, Inc.
Pawling & Harnischfeger Co.
Reading Chain & Block Corpn.
Shepard Electric Crane & Hoist Co.
Sprague Electric Works

HOISTS, ELECTRIC, FLOOR OPERATED

Brown Hoisting Machinery Co.
Cleveland Crane & Eng. Co.
Enclid Crane & Hoist Co.
Herbert Morris, Inc.
Lakeside Bridge & Steel Co.
Link-Belt Co.
Manning, Maxwell & Moore, Inc.
Maris Bros.
Palmer-Bee Co.
Pawling & Harnischfeger Co.
Reading Chain & Block Corpn.
Shepard Electric Crane & Hoist Co.
Sprague Electric Works

HOISTS, MONORAIL

Brown Hoisting Machinery Co.
Chisholm-Moore Mfg. Co.
Cleveland Crane & Eng. Co.
Enclid Crane & Hoist Co.
Link-Belt Co.
Manning, Maxwell & Moore, Inc.
Northern Engineering Works
Pawling & Harnischfeger Co.
Shepard Electric Crane & Hoist Co.
Sprague Electric Works.

HOISTS, PNEUMATIC

Chisholm-Moore Mfg. Co.
Herbert Morris, Inc.
Northern Engineering Works
Palmer-Bee Co.

INCLINE RAILWAYS

Otis Elevator Co.

INDUSTRIAL CARS

(See Cars, Industrial)

INDUSTRIAL LOCOMOTIVES

(See Locomotives, Industrial)

INDUSTRIAL RAILWAYS

(See Railways, Industrial)

INDUSTRIAL TRAILERS

(See Trailers)

INDUSTRIAL TRUCKS

(See Trucks)

LARRIES

C. O. Bartlett & Snow Co.
R. H. Beaumont Co.
C. W. Hunt Co.
Link-Belt Co.
Mead-Morrison Mfg. Co.

LIFTING MAGNETS

Ohio Electric & Controller Co.

LIFT TRUCKS

(See Trucks)

LIMIT SWITCHES, SAFETY

General Electric Co.
Ohio Electric & Controller Co.
Westinghouse Elec. & Mfg. Co.

LOADERS, BOX CAR

Barber-Greene Co.
Brown Portable Conveying Machinery Co.
Haslett Spiral Chute Co.
Lamson Co.
Link-Belt Co.
McKinney-Harrington Co.
Portable Machinery Co.

LOADERS, TRUCK AND WAGON

Austin Machinery Corpn.
Barber-Greene Co.
Link-Belt Co.
McKinney-Harrington Co.
Portable Machinery Co.

LOCOMOTIVE CRANES, ELECTRIC

Brown Hoisting Machinery Co.
Link-Belt Co.

LOCOMOTIVE CRANES, GASOLINE

Brown Hoisting Machinery Co.
Pawling & Harnischfeger Co.

LOCOMOTIVE CRANES, STEAM

Brown Hoisting Machinery Co.
Link-Belt Co.
Herbert Morris Crane & Hoist Co.

LOCOMOTIVES COMPRESSED AIR

H. K. Porter Co.

LOCOMOTIVES, ELECTRIC

Automatic Transportation Co.
Baker R & L Co.
Binghamton Electric Truck Co.
General Electric Co.
C. W. Hunt Co.
Koppel Industrial Car & Equipment Co.
Mead-Morrison Mfg. Co.
Westinghouse Elec. & Mfg. Co.

LOCOMOTIVES, FIRELESS

H. K. Porter Co.

LOCOMOTIVES, GASOLINE

Easton Car & Construction Co.
Lakewood Engineering Co.

LOCOMOTIVES, MINE

General Electric Co.
C. W. Hunt Co.
H. K. Porter Co.
Westinghouse Elec. & Mfg. Co.

LOCOMOTIVES, STEAM

Easton Car & Construction Co.
Koppel Industrial Car & Equipment Co.
H. K. Porter Co.

LOCOMOTIVES, STORAGE BATTERY

Automatic Transportation Co.
Baker R & L Co.
Binghamton Electric Truck Co.
General Electric Co.
C. W. Hunt Co.
Westinghouse Elec. & Mfg. Co.

MAGNETIC BRAKES

General Electric Co.
Westinghouse Elec. & Mfg. Co.

MAGNETS, LIFTING

(See Lifting Magnets)

MANUFACTURING CONVEYORS

Palmer-Bee Co.

MAST AND GAFF RIGS

Dravo Contracting Co.
C. W. Hunt Co.

Mead-Morrison Mfg. Co.
Terry Manufacturing Co.

MICRO LEVELING ELEVATORS

Otis Elevator Co.

MOTOR TRUCKS

White Co.

PILING MACHINES, PORTABLE

Barber-Greene Co.
Brown Portable Conveying Machinery Co.
Haslett Spiral Chute Co.
Link-Belt Co.
McKinney-Harrington Co.
Portable Machinery Co.

PIVOTED BUCKET CARRIERS

C. O. Bartlett & Snow Co.
Haslett Spiral Chute Co.
C. W. Hunt Co.
Link-Belt Co.
Mead-Morrison Mfg. Co.
Palmer-Bee Co.
Stearns Conveyor Co.

PLATFORM CONVEYORS

(See Conveyors, Apron)

PLATFORMS FOR LIFT TRUCKS

Automatic Transportation Co.
George P. Clark Co.
Cowan Truck Co.
Elwell-Parker Electric Co.
Lakewood Engineering Co.
Powell Pressed Steel Co.

PNEUMATIC HOISTS

(See Hoists, Pneumatic)

PNEUMATIC TUBES

Lamson Co.

PORTABLE BELT CONVEYORS

Barber-Greene Co.
Brown Portable Conveying Machinery Co.
Haslett Spiral Chute Co.
Lamson Co.
Link-Belt Co.
McKinney-Harrington Co.
Samuel Olson & Co.
Palmer-Bee Co.
Portable Machinery Co.
Standard Conveyor Co.
Stearns Conveyor Co.

PORTABLE BUCKET CONVEYORS

Austin Machinery Corpn.
Barber-Greene Co.
C. O. Bartlett & Snow Co.
Brown Portable Conveying Machinery Co.
Link-Belt Co.
McKinney-Harrington Co.
Palmer-Bee Co.

PROGRESSIVE ASSEMBLY CONVEYORS

Palmer-Bee Co.

PORTABLE ELEVATORS

(See Elevators, Portable)

PULLERS, CAR

(See Car Hauls and Fullers)

RAILS, INDUSTRIAL RAILWAY

(See Track, Industrial Railway)

RAILWAYS, AUTOMATIC

C. W. Hunt Co.
Link-Belt Co.
Mead-Morrison Mfg. Co.

RAILWAYS, CABLE

Clyde Iron Works.
C. W. Hunt Co.
Link-Belt Co.
Mead-Morrison Mfg. Co.

RAILWAYS, INDUSTRIAL

Easton Car & Construction Co.
C. W. Hunt Co.
Koppel Industrial Car & Equipment Co.
Lakewood Engineering Co.

ROLLER BEARINGS

Ilyatt Roller Bearing Co.

ROPE, MANILA

C. W. Hunt Co.

DIRECTORY OF PRODUCTS

ROPES, WIRE

American Steel & Wire Co.
A. Leschen & Sons Rope Co.

ROTARY CAR DUMPERS

Car-Dumper & Equipment Co.

SCALES, AUTOMATIC CONVEYOR

Merrick Scale Manufacturing Co.

SCALES

C. W. Hunt Co.
Merrick Scale Manufacturing Co.

SCREW CONVEYORS

(See Conveyors, Screw)

SEALING MACHINES FOR FIBRE AND CORRUGATED CONTAINERS

National Binding Machine Co.

SHIP BUNKERING EQUIPMENT

C. W. Hunt Co.
Link-Belt Co.
Mead-Morrison Mfg. Co.

SHOP BOXES

Geo. P. Clark Co.
Powell Pressed Steel Co.

SHOVELS, ELECTRIC (POWER OPERATED)

C. W. Hunt Co.

SHOVELS, GASOLINE (POWER OPERATED)

Austin Machinery Corpn.
Brown Hoisting Machinery Co.
Pawling & Harnischfeger Co.

SHOVELS, STEAM (POWER OPERATED)

Austin Machinery Corpn.
C. W. Hunt Co.
Vulcan Iron Works, Inc.

SIDEWALK ELEVATORS

(See Elevators, Sidewalk)

SKIDS

(See Platforms for Lift Trucks)

SKIP HOISTS

C. O. Bartlett & Snow Co.
R. H. Beaumont Co.
Clyde Iron Works.
C. W. Hunt Co.
Link-Belt Co.
Otis Elevator Co.
Stearns Conveyor Co.

SKIPS

C. O. Bartlett & Snow Co.
R. H. Beaumont Co.
Blaw-Knox Co.
Easton Car & Construction Co.
C. W. Hunt Co.
Koppel Industrial Car & Equipment Co.
Link-Belt Co.

SLAT CONVEYORS

(See Conveyors, Apron)

SPIRAL CHUTES

(See Gravity Spiral Conveyors)

STEAM ENGINE GENERATING SETS FOR LIFTING MAGNETS

General Electric Co.
Westinghouse Electric & Mfg. Co.

STEAM LOCOMOTIVES

(See Locomotives, Steam)

STILLS, WATER

W. M. Lalor Co.

STORAGE BATTERIES

Edison Storage Battery Co.
Electric Storage Battery Co.

STORAGE BATTERY LOCOMOTIVES

(See Locomotives, Storage Battery)

STORAGE BATTERY TRACTORS, INDUSTRIAL

(See Tractors, Industrial Storage Battery)

STORAGE BATTERY TRUCKS, INDUSTRIAL

(See Truck, Industrial Storage Battery)

SWITCHES, INDUSTRIAL RAILWAY

Easton Car & Construction Co.
Koppel Industrial Car & Equipment Co.
Lakewood Engineering Co.

TACKLE BLOCKS

American Steel & Wire Co.
Clyde Iron Works
C. W. Hunt Co.
Terry Manufacturing Co.

TAPE, GUMMED, FOR SEALING FIBRE AND CORRUGATED CONTAINERS

National Binding Machine Co.

TIPPLES, COAL

(See Coal Tipples)

TOTE-BOXES

Geo. P. Clark Co.
Powell Pressed Steel Co.

TRACK, INDUSTRIAL RAILWAY

Easton Car & Construction Co.
C. W. Hunt Co.
Koppel Industrial Car & Equipment Co.
Lakewood Engineering Co.
Northern Engineering Works.

TRACTORS, GASOLINE

Holt Manufacturing Co.
Palmer-Bee Co.
The White Co.

TRACTORS, INDUSTRIAL STORAGE BATTERY

Automatic Transportation Co.
Baker R & I Co.
Binghamton Electric Truck Co.
Cowan Truck Co.
Crescent Truck Co.
Elwell-Parker Electric Co.
Lakewood Engineering Co.
Mercury Manufacturing Co.

TRAILERS, INDUSTRIAL

Automatic Transportation Co.
Binghamton Electric Truck Co.
George P. Clark Co.
Cowan Truck Co.
Crescent Truck Co.
Easton Car & Construction Co.
Lakewood Engineering Co.
Mercury Manufacturing Co.

TRAMWAYS

R. H. Beaumont Co.
Brown Hoisting Machinery Co.
Cleveland Crane & Engineering Co.
A. Leschen & Sons Rope Co.
Link-Belt Co.
Palmer-Bee Co.

TRAVELING CRANES

(See Cranes)

TROLLEYS

Chisholm & Moore Mfg. Co.
Cleveland Crane & Engineering Co.
Euclid Crane & Hoist Co.
Ford Chain Block Co.
Lakeside Bridge & Steel Co.
Maris Bros.
Herbert Morris, Inc.
Palmer-Bee Co.
Reading Chain & Block Corp'n.
Shepard Electric Crane & Hoist Co.
Sprague Electric Works.
Wright Mfg. Co.

TRUCKS, CRANE, ELECTRIC

Automatic Transportation Co.
Baker R & I Co.
Elwell-Parker Electric Co.

TRUCKS, ELEVATING PLATFORM, POWER DRIVEN

Automatic Transportation Co.
Baker R & I Co.
Binghamton Electric Truck Co.
Cowan Truck Co.
Elwell-Parker Electric Co.
Lakewood Engineering Co.

TRUCKS, HAND

George P. Clark Co.
Lakewood Engineering Co.

TRUCKS, HAND LIFT

George P. Clark Co.
Cowan Truck Co.

TRUCKS, INDUSTRIAL, DUMP BODY

Automatic Transportation Co.
Baker R & I Co.
Cowan Truck Co.
Crescent Truck Co.
Elwell-Parker Electric Co.
Lakewood Engineering Co.

TRUCKS, MOTOR

The White Co.

TRUCKS, STORAGE BATTERY, INDUSTRIAL

Automatic Transportation Co.
Baker R & I Co.
Binghamton Electric Truck Co.
Cowan Truck Co.
Crescent Truck Co.

Elwell-Parker Electric Co.
Lakewood Engineering Co.
Mercury Manufacturing Co.

TRUCKS, TIERING

Automatic Transportation Co.
Baker R & I Co.
Elwell-Parker Electric Co.
Lakewood Engineering Co.

TUBES, PNEUMATIC

Iamson Co.

TURBO GENERATOR SETS FOR LIFTING MAGNETS

General Electric Co.
Westinghouse Elec. & Mfg. Co.

TURNTABLES, INDUSTRIAL RAILWAY

Easton Car & Construction Co.
C. W. Hunt Co.
Koppel Industrial Car & Equipment Co.
Lakewood Engineering Co.
Link-Pelt Co.

WAGON LOADERS

Austin Machinery Corp.
Barber-Greene Co.
Link-Belt Co.
Palmer-Bee Co.
Portable Machinery Co.

WALL CRANES

(See Cranes, Wall)

WEIGH LARRIES

(See Larries)

WHEELS, CAR

Eastern Car & Construction Co.
Koppel Industrial Car & Equipment Co.

WINCHES, ELECTRIC

Clyde Iron Works.
Dravo Contracting Co.
C. W. Hunt Co.
Mead-Morrison Mfg. Co.
Herbert Morris, Inc.
Northern Engineering Works.
Palmer-Bee Co.
H. J. Reedy Co.
Shepard Electric Crane & Hoist Co.
Sprague Electric Works.
Terry Manufacturing Co.

WINCHES, GASOLINE

Clyde Iron Works.
Dravo Contracting Co.
Palmer-Bee Co.
Terry Manufacturing Co.

WINCHES, MOTOR TRUCK

Mead-Morrison Mfg. Co.

WINCHES, STEAM

Clyde Iron Works.
C. W. Hunt Co.
Mead-Morrison Mfg. Co.

WIRE ROPE

American Steel & Wire Co.
A. Leschen & Sons Rope Co.

WIRE LINE CARRIERS

(See Conveyors, Wire Line)

ALPHABETICAL INDEX OF CATALOGS

A		Lamson Company.....760-763, inc.
American Steel & Wire Co.....818-821, inc.		Leschen & Sons Rope Co., A.....822, 823
Austin Machinery Corp.....838, 839		Link-Belt Co.....771, 804, 836
Automatic Transportation Co.....745		
B		M
Baker R & L Co.....743		McKinney-Harrington Co.....768, 769
Barber-Greene Co.....837		Manning, Maxwell & Moore, Inc.....796, 797
Bartlett & Snow Co., C. O.....826		Maris Bros., Inc.....782
Beaumont Co., R. H.....832, 833		Mead-Morrison Manufacturing Co.....828, 829
Binghamton Electric Truck Co.....741		Mercury Manufacturing Co.....734, 735
Blaw-Knox Co.....814, 815		Merrick Scale Co.....835
Brown Hoisting Machinery Co.....805		Morris, Incorporated, Herbert.....780
Brown Portable Conveying Machinery Co.....770		
C		N
Car-Dumper & Equipment Co.....825		National Binding Machine Co.....764
Chesapeake Iron Works.....795		Northern Engineering Works.....800
Chisholm-Moore Manufacturing Co.....778, 779		
Clark Co., George P.....748		O
Cleveland Crane & Engineering Co.....792, 793		Ohio Electric & Controller Co.....807
Clyde Iron Works.....803		Olson & Co., Samuel.....766, 767
Cowan Truck Co.....732, 733, 747		Otis Elevator Co.....750-753 inc., 827
Crescent Truck Co.....739		Owen Bucket Co.....810, 811
D		P
Dravo Contracting Co.....801		Palmer-Bee Co.....772, 773
E		Pawling & Harnischfeger Co.....794, 806
Easton Car & Construction Co.....722, 723		Portable Machinery Co.....840
Edison Storage Battery Co.....719, 742		Porter Co., H. K.....720
Electric Storage Battery Co.....736, 737		Powell Pressed Steel Co.....746
Elwell-Parker Electric Co.....744		
Euclid Crane & Hoist Co.....781		R
F		Railway & Industrial Engineering Co.....824
Ford Chain Block Co.....774		Reading Chain & Block Corp.....776, 777
G		Reedy Co., H. J.....749
General Electric Co.....706-717, inc.		
H		S
Haslett Spiral Chute Co.....759		Sauerman Bros.....817
Hayward Co.....808, 809		Shepard Electric Crane & Hoist Co.....788-791 inc.
Holt Manufacturing Co.....704, 705		Sprague Electric Works.....784-787 inc.
Howell Electric Motors Co.....755		Standard Conveyor Co.....765
Hunt Co., C. W.....830, 831		Stearns Conveyor Co.....834
Hyatt Roller Bearing Co.....731, 783		
K		T
Koppel Industrial Car & Equipment Co.....721		Terry Manufacturing Co.....802
L		U
Lakeside Bridge & Steel Co.....798, 799		U. S. Ball Bearing Manufacturing Co.....740
Lakewood Engineering Co.....724-730, inc., 813		
Lalor Co., W. M.....738		V
		Vulcan Iron Works.....812
		W
		Watson Elevator Co.....754
		Westinghouse Electric & Mfg. Co....718, 756-758 inc.
		White Co., The.....702, 703
		Williams Co., G. H.....816
		Wright Manufacturing Co.....775

INDEX TO THE CATALOG SECTION

In the pages preceding, the Catalog Section is indexed by three methods.

1. Alphabetical Index of Catalogs.

In this the names of the firms represented in the Catalog Section are listed alphabetically, with the page numbers on which their catalogs appear.

2. Directory of Products.

In this index there is given, alphabetically arranged, a list of the products of the firms whose catalogs appear in the Catalog Section. Beneath each product are given the names of the firms manufacturing it.

Where it does not conflict with usage, the article is listed under the main noun. For example, Electric Hoists are listed under Hoists, Electric. Numerous cross-references are also included to facilitate the use of this directory.

3. Trade Name Index.

Here are listed, in alphabetical order, the distinctive Trade Names of the various products shown in the Catalog Section. After each name is given the manufacturer of the product.

Many products are better known by their Trade Names than by the firm name of the manufacturer. The purpose of this Trade Name Index is to identify such products, where the manufacturer is not immediately identified by the Trade Name.

The Definition Section also serves as a combined index to the Text and Catalog Sections. Because of the fact that it gives simultaneously references to both application and detailed information on specific equipment, the Definition Section will usually be the most convenient index.

The General Table of Contents, appearing first in the book, will also aid in finding quickly the desired information.

UNIVERSITY OF CALIFORNIA LIBRARY
BERKELEY

Return to desk from which borrowed.
This book is DUE on the last date stamped below.

ENGINEERING LIBRARY

JUL 14 1948

MAY 22 1950

JUN 3 1950

DEC 18 1950

AUG 27 1959

SENT ON ILL

FEB 28 1957

U. C. BERKELEY

TJ1350
M3
1000

646138

UNIVERSITY OF CALIFORNIA
DEPARTMENT OF CIVIL ENGINEERING
BERKELEY, CALIFORNIA

UNIVERSITY OF CALIFORNIA LIBRARY

