



This is a digital copy of a book that was preserved for generations on library shelves before it was carefully scanned by Google as part of a project to make the world's books discoverable online.

It has survived long enough for the copyright to expire and the book to enter the public domain. A public domain book is one that was never subject to copyright or whose legal copyright term has expired. Whether a book is in the public domain may vary country to country. Public domain books are our gateways to the past, representing a wealth of history, culture and knowledge that's often difficult to discover.

Marks, notations and other marginalia present in the original volume will appear in this file - a reminder of this book's long journey from the publisher to a library and finally to you.

### **Usage guidelines**

Google is proud to partner with libraries to digitize public domain materials and make them widely accessible. Public domain books belong to the public and we are merely their custodians. Nevertheless, this work is expensive, so in order to keep providing this resource, we have taken steps to prevent abuse by commercial parties, including placing technical restrictions on automated querying.

We also ask that you:

- + *Make non-commercial use of the files* We designed Google Book Search for use by individuals, and we request that you use these files for personal, non-commercial purposes.
- + *Refrain from automated querying* Do not send automated queries of any sort to Google's system: If you are conducting research on machine translation, optical character recognition or other areas where access to a large amount of text is helpful, please contact us. We encourage the use of public domain materials for these purposes and may be able to help.
- + *Maintain attribution* The Google "watermark" you see on each file is essential for informing people about this project and helping them find additional materials through Google Book Search. Please do not remove it.
- + *Keep it legal* Whatever your use, remember that you are responsible for ensuring that what you are doing is legal. Do not assume that just because we believe a book is in the public domain for users in the United States, that the work is also in the public domain for users in other countries. Whether a book is still in copyright varies from country to country, and we can't offer guidance on whether any specific use of any specific book is allowed. Please do not assume that a book's appearance in Google Book Search means it can be used in any manner anywhere in the world. Copyright infringement liability can be quite severe.

### **About Google Book Search**

Google's mission is to organize the world's information and to make it universally accessible and useful. Google Book Search helps readers discover the world's books while helping authors and publishers reach new audiences. You can search through the full text of this book on the web at <http://books.google.com/>

UC-NRLF



QB 32 195

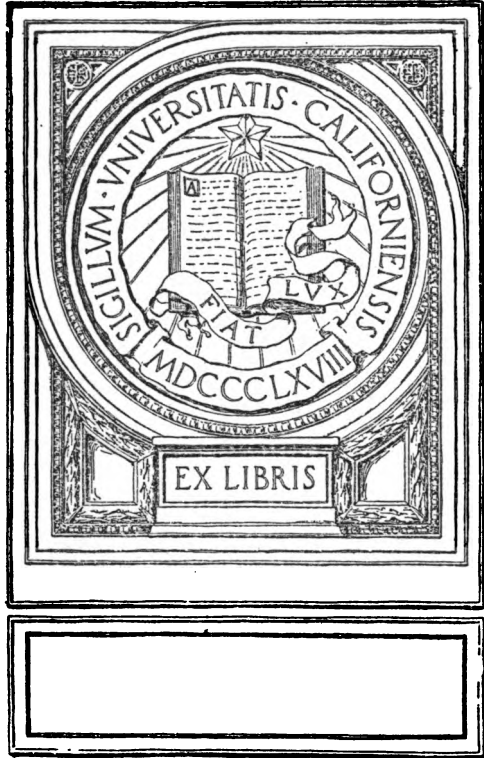









# MECHANICAL DEVICES IN THE HOME

by

EDITH ALLEN, M. A.

*Assistant Editor, U. S. Department of Agriculture*

*Formerly*

*Specialist in Home Economics in Kansas State Agricultural  
College, University of Texas, and Oklahoma  
Agricultural and Mechanical College*



THE MANUAL ARTS PRESS  
PEORIA, ILLINOIS



T. 11

THE  
STORY OF  
THE  
WORLD

Copyright 1922  
Edith Allen  
12 C 22

*Printed in the United States of America*

## PREFACE

**I**N WRITING this book, my aim has been (1) to give information which will guide householders in selecting and installing the best cooking and heating devices, and in using them with the greatest economy of fuel and safety against accidents; (2) to explain the construction of lighting fixtures and how to determine the amount of light for health needed in various places; (3) to explain the principles of cooling; (4) to show how to make small repairs which save plumbers' bills; (5) to guide in the choice and care of laundry appliances and cooking utensils; (6) to familiarize women with the construction of electric, acetylene and gas plants and engines, and (7) to furnish tables of measure often needed for reference.

There is a lack of material of this type which is non-technical enough for the use of home economics students and housewives. The material which I have organized applies directly to the appliances with which women work and is of a nature to fill their need in this field.

The book is designed as a text for senior-high school and junior-college classes, as well as for the needs of home-demonstration agents, housewives and other women.

EDITH ALLEN

## ACKNOWLEDGMENTS

The author is particularly indebted in the preparation of this book to John G. Thompson, professor of economics, University of Illinois; J. K. T. Ekblaw, instructor of farm mechanics, University of Illinois, and editor of *Farm Power*; Andrey A. Potter, professor of steam and gas engineering, Kansas State Agricultural College; J. M. Bryant, professor of electrical engineering, University of Texas; Harrison E. Howe, National Council of Research; Miss Minna C. Denton, home economics specialist, United States Department of Agriculture; Miss Marie Dallas, Washington, D. C.; F. F. Good, instructor in applied physics, Teachers' College, Columbia University, New York.

The following is a list of companies furnishing illustrations, data and other information:

American Blower Company.	Consolidated Gas, Electric Light and Power Co.
American Ironing Machine Co.	Cyphers Incubator Co.
American Lava Co.	Dangler Stove Co.
American Radiator Co.	Davis Acetylene Co.
American Stove Co.	The DeLaval Separator Co.
Automatic Electric Washer Co.	Delco Motor Co.
Baltimore Gas Appliance Co.	The Deming Co.
Bates & Edmonds Motor Co.	Detroit Heating & Lighting Co.
Bissel's Carpet Sweeper Co.	Detroit Stove Works.
Blake Mfg. Co.	Detroit Vapor Stove Co.
C. Brown Mfg. Co.	A. B. Dick Co.
B. Bryan Co.	W. S. Dickey Clay Mfg. Co.
Central Construction & Supply Co.	The Durham Mfg. Co.
Central Oil & Gas Stove Co.	Eagle Generator Co.
Chambers Fireless Cooker Stove Co.	Fuller, Warren & Co.
Geo. M. Clark & Co.	General Electric Co.
Cleveland Metal Products Co.	Hammond Typewriter Co.
Coleman Lamp Co.	Hart & Crouse Co.

## ACKNOWLEDGMENTS

5

Herrick Refrigerator Co.  
Huenfield Co.  
Humphrey Co.  
Hurley Machine Co.  
Kalamazoo Stove Co.  
Kewanee Water Supply Co.  
Klau-Van Pietersom-Dunlap.  
Landers, Frary, Clark & Co.  
Laundryette Mfg. Co.  
Manning, Bowman & Co.  
Mantle Lamp Co. of America.  
H. G. McFadden & Co.  
The Monitor Stove Co.  
National Electric Supply Co.  
Northwestern Steel & Iron Works.  
Pacific Flush Tank Co.  
Potomac Power & Lighting Co.  
Rathbone, Sard & Co.  
Reliable Stove Co.  
Remnert Mfg. Co.  
Rhineland Refrigerator Co.  
Ringen Stove Co.  
Rochester Rotary Washer Co.  
Rochester Stamping Co.  
Sears, Roebuck & Co.  
Sharples Separator Co.  
Singer Sewing Machine Co.  
L. C. Smith & Bros. Typewriting  
Company.  
Standard Oil Co.  
Edward L. Stock.  
Thatcher Furnace Co.  
The Torrington Co.  
Toledo Cooker Co.  
Trenton Potteries Co.  
United Electric Co.  
United Pump & Power Co.  
United States Dept. of Agricul-  
ture.  
United States Radiator Co.  
Voss Bros. Mfg. Co.  
Walker Bros. Co.  
Welsbach Co.  
Western Electric Co.  
White Frost Refrigerator Co.  
White Mop and Wringer Co.  
Wilcox & Gibbs Sewing Machine  
Co.  
The Yale & Towne Mfg. Co.



# TABLE OF CONTENTS

## PART I. COOKING STOVES

### CHAPTER I. WOOD AND COAL STOVES . . . . . 15

1. Air supply of fire. 2. The grate. 3. Drafts or dampers. 4. Starting the fire. 5. Keeping a fire. 6. Heating the oven. 7. Ashes. 8. Ash chutes.

### CHAPTER II. GAS STOVES . . . . . 23

9. Burners. 10. Simmerers. 11. Air mixer. 12. Regulating the gas. 13. Lighting the stove. 14. Cleaning the stove. 15. Accidents with gas stove. 16. Pilot light. 17. Pilot for top burners. 18. Gas-stove lighter. 19. Amount of gas used. 20. Cold-process gasoline gas stoves. 21. Acetylene stoves.

### CHAPTER III. OIL STOVES . . . . . 31

22. Purpose of oil stoves. 23. Mechanical parts of kerosene stove. 24. The burner. 25. The chimney. 26. Lighting the stove. 27. Management of the flame. 28. Adjustment and care of the stove. 29. When the stoves gives trouble. 30. Construction of gasoline stoves. 31. To light the stove. 32. Filling the gasoline stove. 33. When a burner blazes and cannot be controlled. 34. Changing fuel in vapor stoves. 35. Operation of vapor stoves.

### CHAPTER IV. ELECTRIC STOVES . . . . . 42

36. Heating unit of electric stove. 37. Wiring of stoves. 38. Operation of electric stoves. 39. Care of electric stoves. 40. Utensils for electric stoves. 41. Detachable cooking devices.

### CHAPTER V. ALCOHOL, ACETYLENE, AND CANNED HEAT 47

42. Alcohol stoves. 43. Vapor stoves. 44. Wickless stoves. 45. Canned heat. 46. Acetylene gas stoves.

### CHAPTER VI. FIRELESS AND STEAM COOKERS . . . . . 50

47. The fireless cooker. 48. The stoves of fireless cookers. 49.

Heating the stones. 50. Care of the cooker. 51. Other devices belonging to cookers. 52. Directions for using the cooker. 53. Time of cooking food. 54. Gas cookers. 55. Steam cookers.

## PART II. HEATING DEVICES

### CHAPTER VII. WARM-AIR FURNACES . . . . . 57

56. Principle upon which a furnace works. 57. The stove part. 58. The cold-air shaft. 59. Hot-air pipes. 60. Location of the furnace. 61. Air. 62. Pipeless furnaces.

### CHAPTER VIII. HOT-WATER SYSTEM OF HEATING . . . . . 64

63. Equipment for hot-water heat. 64. Heating unit. 65. The management of the fire. 66. The pipes. 67. Expansion tank. 68. Water. 69. Radiators.

### CHAPTER IX. STEAM-HEATING SYSTEMS . . . . . 69

70. Equipment for steam heat. 71. Steam gages. 72. Safety valve.

### CHAPTER X. FIREPLACES AND HEATING STOVES . . . . . 74

73. Construction of fireplace. 74. Management of fireplace. 75. Operating heating stoves. 76. Care of the stove.

### CHAPTER XI. GAS, ELECTRIC AND KEROSENE HEATERS 77

77. Kinds of gas heaters. 78. Bunsen burner and asbestos-back heater. 79. Lighting gas stoves. 80. Care of gas stoves. 81. Illuminating flame and bright metal reflector heaters. 82. Gas radiator heaters. 83. Management of gas radiator. 84. Kerosene heaters. 85. Electric heaters. 86. Acetylene heaters.

## PART III. LIGHTING DEVICES

### CHAPTER XII. ELECTRIC LIGHTS . . . . . 82

87. Kinds of electric lamps in use. 88. Electrical measurements. 89. Carbon lamps. 90. Mazda or tungsten lamps. 91. Selecting lamps for a room. 92. Effect of color schemes upon illumination. 93. Distribution of light.

## CHAPTER XIII. GAS LIGHT . . . . . 88

94. Construction of mantles. 95. Care of mantles. 96. Fixtures for burning gas. 97. Adjustment. 98. Care of lamps. 99. Lighting a gas light. 100. Cold-process gasoline gas. 101. Acetylene lamps. 102. Care of burners of acetylene lamps.

## CHAPTER XIV. KEROSENE LAMPS . . . . . 93

103. Construction of kerosene lamps. 104. Management of kerosene lamps. 105. Lighting a kerosene lamp. 106. To extinguish a lamp. 107. Care of lamps. 108. Kerosene mantle lamps.

## CHAPTER XV. ALCOHOL AND GASOLINE LAMPS . . . . . 96

109. Classification of lamps. 110. Gravity lamps. 111. Lighting the gravity lamp. 112. Pressure lamps. 113. Gasoline lamps with wicks. 114. Alcohol lamps with wicks. 115. Lighting alcohol or gasoline lamps.

## PART IV. COOLING DEVICES

## CHAPTER XVI. REFRIGERATORS . . . . . 100

116. Principles of refrigeration. 117. The construction of refrigerators. 118. Lining refrigerators. 119. Insulation of refrigerators. 120. Circulation in refrigerators. 121. Drip from melting ice. 122. Arrangement of food in the ice box. 123. Filling and care of the ice box.

## CHAPTER XVII. ICELESS REFRIGERATORS; WATER COOLERS . . . . . 105

124. Comparative efficiency of iceless refrigerators. 125. Iceless refrigerator. 126. Small cooler. 127. Covered pail. 128. Unglazed earthenware. 129. Cooling with running water. 130. Refrigerating plants. 131. Water coolers. 132. Care of water coolers.

## CHAPTER XVIII. FANS AND VENTILATORS . . . . . 110

133. Selecting a fan. 134. The construction of the fan in common use. 135. Ventilator.



**PART V. WATER SUPPLY AND SEWAGE DISPOSAL****CHAPTER XIX. PUMPS AND WATER FILTERS . . . 112**

136. Suction pumps. 137. Care of pumps. 138. Force pumps.  
139. Compressed-air pumps. 140. Water filters.

**CHAPTER XX. PRESSURE TANKS; PLUMBING FIXTURES 117**

141. Pressure tanks. 142. Construction of the pressure tank.  
143. Care of pressure tanks. 144. Hot-water kitchen tank.  
145. Instantaneous water heaters. 146. Heaters for tanks. 147.  
The elevated water tank. 148. Faucets. 149. Valves. 150. Over-  
flows. 151. Traps for bath tubs and basins.

**CHAPTER XXI. CESSPOOLS, SEPTIC TANKS AND CITY****SEWER SYSTEMS . . . . . 124**

152. Relative value of cesspool and septic tank. 153. Construc-  
tion of the septic tank. 154. The size of tank. 155. Disposal of  
waste in cities.

**CHAPTER XXII. WATER CLOSETS . . . . . 128**

156. Construction of water closets. 157. Siphoning the trap. 158.  
The flushing tank. 159. Repairing the flushing tank.

**PART VI. LAUNDRY EQUIPMENT****CHAPTER XXIII. WASHING MACHINES . . . . . 132**

160. Kinds of washing machines. 161. Suction machines. 162.  
Cylinder washers. 163. Rotary washers. 164. Machine with  
an oscillating washing device. 165. Oscillating washers. 166.  
Locomotive washer. 167. Centrifugal washer. 168. Care of  
washers.

**CHAPTER XXIV. WRINGERS . . . . . 138**

169. Roller wringer. 170. Care of wringers. 171. Centrifugal  
wringer or drier. 172. Care of the machine. 173. Combination  
washer and wringer.

**CHAPTER XXV. MANGLES AND IRONS . . . . . 141**

174. Construction of mangles. 175. Cold mangles. 176. Heated mangles. 177. Care and use of mangles. 178. Flat, or sadirons. 179. Charcoal irons. 180. Electric irons. 181. Gas irons. 182. Acetylene irons. 183. Alcohol irons. 184. Gasoline irons.

**PART VII. HOUSE-CLEANING EQUIPMENT****CHAPTER XXVI. VACUUM CLEANERS AND CLEANING TOOLS . . . . . 147**

185. Principle upon which vacuum cleaners work. 186. Different kinds of vacuum cleaners. 187. Nozzle of vacuum cleaner. 188. Cautions in using vacuum cleaners. 189. Difference between hand and power cleaners. 190. Carpet sweeper. 191. Mop wringers.

**PART VIII. DEVICES FOR PREPARATION AND CONSERVATION OF FOOD****CHAPTER XXVII. POTS, PANS AND OTHER DEVICES 155**

192. Materials from which utensils are made. 193. Aluminum alloy. 194. Cast-iron utensils. 195. Earthenware. 196. Aluminum and graniteware. 197. Mixing spoons.

**CHAPTER XXVIII. PARERS, SEEDERS, GRINDERS, SLICERS, ETC. . . . . 159**

198. Fruit and vegetable parers and knives. 199. Parers which grate off skins. 200. Seeders and stoners. 201. Cherry stoner. 202. Grinders. 203. Choppers or meat grinders. 204. Choppers. 205. Slicers. 206. Lard and fruit presses, sausage stuffers.

**CHAPTER XXIX. MIXERS, BEATERS AND CHURNS; COFFEE POTS . . . . . 165**

207. Use of mixers, beaters and churns. 208. Care of these devices. 209. Freezers. 210. Care of freezers. 211. Churns. 212. Drip coffee pots. 213. Percolator coffee pots.

**CHAPTER XXX. DISH-WASHERS, CANNERS AND DRYERS . . . . . 170**

214. Dish dryer. 215. Cleaning silver. 216. Canners. 217. Water seal. 218. Pressure canners. 219. Use of the canner. 220. Dryers. 221. Care of dryers.

**CHAPTER XXXI. SEPARATORS AND EMULSIFIERS . . . . . 178**

222. Cream separators. 223. Different types of separators. 224. Washing the machine. 225. Oiling. 226. Whey separator. 227. Emulsifier.

**PART IX. SUNDRY DEVICES**

**CHAPTER XXXII. DUMBWAITERS AND OTHER HOUSE FURNISHINGS . . . . . 183**

228. Dumbwaiters and window adjustments. 229. Check valves. 230. Door fastener. 231. Window shades. 232. Hinges. 233. Sliding doors.

**CHAPTER XXXIII. SEWING MACHINES . . . . . 186**

234. Different types of sewing machines. 235. Lock-stitch sewing machine. 236. Feed plate. 237. Bobbins. 238. Shuttle bobbins. 239. Chain-stitch machine. 240. Cautions for all machines. 241. General instructions.

**CHAPTER XXXIV. AUTOMOBILES . . . . . 192**

242. Starting the motor. 243. Driving the automobile. 244. Care of car.

**CHAPTER XXXV. LAWN MOWERS; INCUBATORS . . . . . 195**

245. Operation and care of lawn mowers. 246. Storing mowers. 247. Scissors and shears. 248. Principles upon which incubator works. 249. The body of the incubator. 250. Incubators heated by a lamp. 251. The wick. 252. Thermostat. 253. The thermometer. 254. Operation of incubator. 255. Egg tester.

## CHAPTER XXXVI. TYPEWRITERS . . . . . 202

256. Construction of typewriter. 257. Special features of typewriter. 258. Interchangeable-type typewriters. 259. Care of typewriters. 260. The hectograph. 261. Mimeograph and multigraph.

## PART X. MOTORS, FUELS AND GAS PLANTS

## CHAPTER XXXVII. TREADLES AND WATER MOTORS 209

262. Definition of motor. 263. The treadle. 264. Water motors. 265. Selecting a water motor. 266. Two types of water motors.

## CHAPTER XXXVIII. ENGINES; MOTORS AND BATTERIES; FUELS . . . . . 212

267. Gasoline engines. 268. Figuring speed of pulleys. 269. Operating the engine. 270. Points in caring for engine. 271. Generating electricity for homes. 272. Batteries. 273. Liquid batteries. 274. A dry-cell battery. 275. Storage batteries. 276. Some uses for electric motors. 277. Definition tables.

## CHAPTER XXXIX. GAS PLANTS . . . . . 220

278. Gasoline gas plants. 279. Acetylene-gas plant. 280. Directions for operating acetylene plant. 281. Cautions to be observed in using acetylene gas. 282. Compressed gases and oils.

## PART XI. MEASURING DEVICES

## CHAPTER XL. SCALES FOR WEIGHING . . . . . 225

283. Equal-arm balances. 284. Unequal-arm balances. 285. Spring scales.

## CHAPTER XLI. DEVICES FOR MEASURING VOLUME . . . . . 227

286. Graduate and measuring cup. 287. Tablespoons. 288. Teaspoons. 289. Standard measuring spoons. 290. Liquid and cooking measures. 291. Dry measures. 292. Cubic, square and linear measures.

**CHAPTER XLII. GAS, WATER AND ELECTRIC METERS 230**

293. Different kinds of meters. 294. Construction of a gas meter.  
295. Reading the gas meter. 296. Water meters. 297. Prepayment meters. 298. The electric meter.

**CHAPTER XLIII. THERMOMETERS AND THERMOSTATS 233**

299. Mercury thermometers. 300. Oven thermometer. 301. Maximum thermometers. 302. Thermostats.

**CHAPTER XLIV. HYDROMETERS AND BAROMETERS . 237**

303. Hydrometer. 304. Hygroscopes. 305. Barometers.

# PART I

## COOKING STOVES

### CHAPTER I

#### WOOD AND COAL STOVES

A brief explanation of stoves is given in this chapter to help the woman with a new stove or with an old one which she does not understand so that she may manage it without wasting fuel and nervous energy.

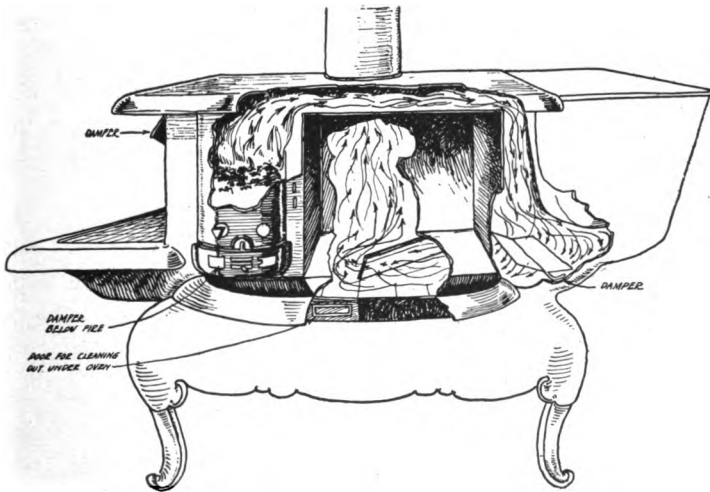

FIG. 1. Cross-section of cooking stove.

Cooking stoves (Fig. 1) were invented as a convenient means for holding pots and pans in close proximity to the fire. They include a device for regulating the supply of air to the burning fuel.

2—Nov. 22.

**1. Air Supply for Fire.** A proper amount of air must be supplied to the fuel to produce a hot fire. A smoky or yellow flame indicates a lack of sufficient air to produce complete combustion of the fuel. Smoke is unburnt fuel. A smoky fire does not produce as much heat as one which burns with a blue or almost colorless flame. It is usually not the fault of the fuel, but the way it is being used that causes a smoky fire.

**2. The Grate.** Cooking stoves may be constructed for burning either wood or coal. In both cases, the operation is similar, except that more air should be passing thru the stove while wood is being burnt. For burning coal, the grate should be less open in order to prevent the coal from falling thru.

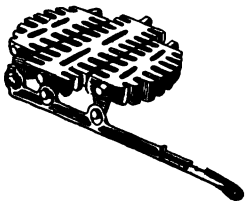

FIG. 1-a. Grate.

Some modern stoves are made with double grates. These may be turned so that the more open part of them is used for supporting the wood, and the less open part for coal.

These grates are usually reversed by a stove shaker. (Fig. 1-a shows a detailed drawing of a grate.) The housekeeper must understand how this is done in order to avoid reversing them when she shakes down the ashes. Two difficulties arise in reversing the grate when the stove is filled with fuel. The coal may be wasted by falling thru the part intended for wood, or pieces of fuel may fall between the parts so that they cannot be moved. When this happens, it is best to let the fire go out, take out the fuel, adjust the grates as they should be and rebuild the fire.

**3. Drafts or Dampers.** There are from three to six dampers on a stove (Figs. 1 and 2), as follows:

1) The draft below the fire box, found on all stoves, is to let in air to the burning fire.

2) The draft above the fire box, not found on all stoves, when slightly opened, lets in air which completes the combustion of the gases arising from the top of the fire. When opened too wide, it checks the burning of the fire.

3) The oven damper, found on all cook stoves, is placed at the point where the flame naturally enters the stove pipe. When this damper is closed, the flame must go around the oven instead of directly up the chimney.

To see the oven damper, take off the lid nearest the stove pipe and watch the direction of the flame. The handle to the oven damper may be at the side of the pipe on top of

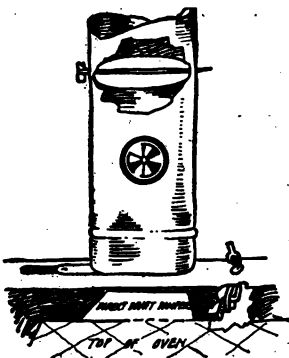

FIG. 2. Drafts and dampers in stove-pipe.

the stove or at the front of the stove under the top near the reservoir. Closing this damper causes the hot gases from the fire to go back over the top of the stove down behind the oven, turn under the oven and come up the chimney. Good stoves are constructed so that the hot gases come in contact with every part of the oven. This makes a longer journey for the gases, but, if the drafts in the front of the stove and chimney are properly adjusted, the gases will make the circuit without forming soot.

4) A damper in the stove pipe (Fig. 2) for letting air from the room into the pipe serves to check the burning of the fire by taking the place of the draft thru the stove.



5) A damper, or shutter, found in the pipe or chimney of most stoves, when closed, checks the draft up the chimney, and, when open, lets it pass freely.

6) The reservoir damper, found on some stoves having reservoirs, lets the hot gases pass next to the reservoir when open and prevents this when closed.

**4. Starting the Fire.** If the stove has a reversible grate, see that it is adjusted to suit the fuel before building the fire; then adjust the drafts. Open the draft below the fire box, the oven damper, and the shutter in the chimney; close the draft above the fire box, and the draft which lets air from the room into the pipe, so that the air may pass up thru the fire box and directly up the chimney. Some chimneys produce such strong drafts that the shutter in the chimney has to be kept closed most of the time, even when starting the fire. After the fuel has become ignited, the draft below the fire may be partly closed so that it burns less rapidly. If the fire is to be used for heating water or food on top of the stove, it is now ready for use. If it is still burning too rapidly, the draft may be entirely closed, or the shutter in the chimney partly closed. If at any time the stove smokes, the shutter or drafts above the fire may be closed too much and should be opened enough to let all the smoke pass. Adding too much fuel at one time and not spreading it in a thin layer over the entire surface of the fire may cause the stove to smoke.

**5. Keeping a Fire.** If, after a fire has been used, it is wanted for use later, close the draft below the fire box, open the one above the fire box, or, if there chances to be no draft here, tilt the lids on the stove to let in the air; close the shutter in the chimney and open the draft in the pipe that lets in

air from the room. With the drafts so adjusted, the fire should keep a long time, as it will burn very slowly.

**6. Heating the Oven.** When baking is to be done, wait until the fire is well started; then close the oven damper. The evenness of heat in the oven depends upon the even distribution of the hot gases below and on the sides of it. This is provided for in the manufacture of the stove itself. The heat in the oven may be regulated by the intensity of the heat from the fire as well as by the damper. Whenever a cooler oven is wanted, the flame may be permitted to go directly up the chimney. Since hot air is always seeking a higher level than cold air, opening the oven door cools the oven, but it will not prevent food set on the bottom of the oven from burning on the bottom. In a closed oven, the greatest degree of heat is at the top, excepting sometimes the surface of the bottom of the oven. Many stoves require the placing of a thin grating on the bottom of the oven to prevent food from burning on the bottom. If food does not brown sufficiently on the bottom, remove the grating so that the dish comes in closer contact with the heating unit.

The insulation of the oven door helps to hold heat in the oven, but the amount lost here is so small that many housekeepers prefer the convenience of the glass door, which, in turn, saves heat by doing away with the necessity of opening the oven door to watch the cooking food.

Some housewives adjust the dampers for heating the oven and then never change them. They heat the kitchen in summer more than is necessary and use more fuel than they need for cooking. It has been estimated that where the careful manager of a stove uses one pound of fuel, the careless manager uses three and a half pounds.

One experiment station estimated that the household coal range is used on an average of six hours a day, and, if used carefully, seven pounds of coal is consumed. Careless management, then, makes the waste of coal quite an item in the course of a year, as it is not unusual for the careless manager to use twenty-four pounds of coal per six-hour day.

There is always some soot formed, even in the best-managed stoves, and the flame often carries ashes with it. These in time fill the narrow space about the oven and cut off or check the passage of the hot gases about the oven. When this happens and the oven damper is closed, the stove will smoke and not bake well. No stove should be allowed to get in this condition. The housewife can watch the accumulation of ashes in the stove and remove them before they become one-fourth inch thick. If this is not done, the oven will not heat well and some parts may be considerably cooler than others.

**7. Ashes.** Ashes allowed to accumulate in the fire box will cause the lining of the stove to burn out. Ashes will also interfere with the heating of the rest of the stove. To lengthen the life of a stove, keep the ash pan empty. If a full pan of ashes becomes hot, it will keep the grate of the stove so hot that it will warp and burn out, and sometimes cause the oven to warp.

If a housewife tries to build a fresh fire in a stove with a full ash pan, she will have to wait for the ashes to become heated thru before she can get satisfactory use of the oven. She will be unable to regulate the temperature of the oven if it becomes too hot. It is a great waste of fuel to heat a large pan full of ashes.

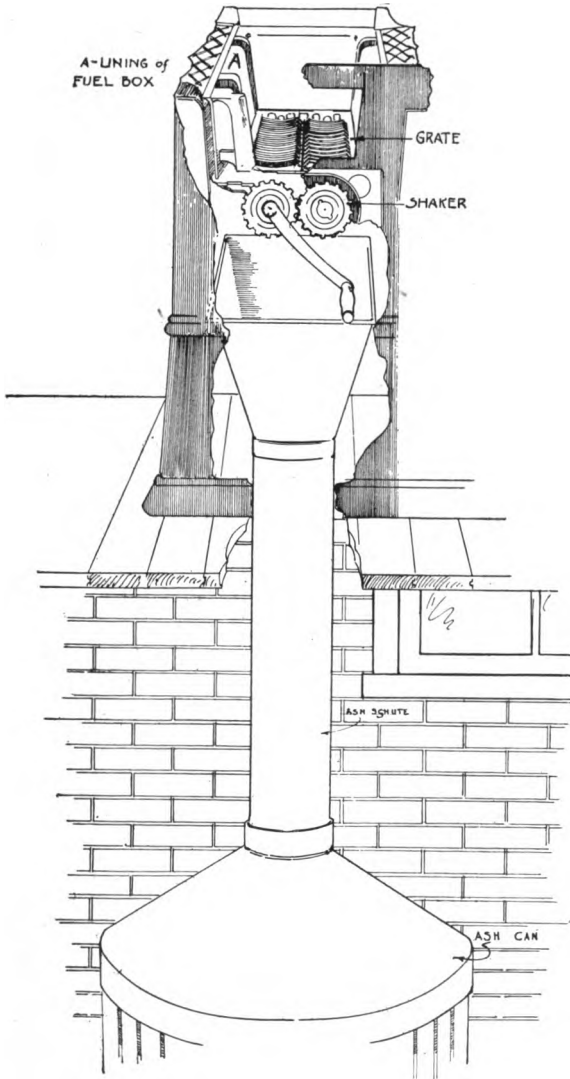

FIG. 3. Ash chute.

**8. Ash Chutes.** In some modern houses, there are ash chutes which carry the ashes directly from the kitchen stove to a receptacle in the basement (Fig. 3). These have to be installed with care. If there is a draft of air which cannot be regulated from the basement up thru the fire box, the fire will burn too fast. There should be a damper to regulate drafts here. An ash chute saves much dirt in the kitchen.

## CHAPTER II

### GAS STOVES

The gas stove is the simplest stove made. It consists of a burner or burners of different shapes mounted on a suitable frame. The best example of a gas burner is a pipe with holes punched in it, where the gas flows out and is set on fire. This pipe may be coiled into a circle and make a round burner, or the holes may all come at the end, which is arranged to spread the gas into a disc shape.

**9. Burners.** Stoves are usually made with different sizes of burners. One manufacturer states that the gas stoves made by his firm consume per top burner per hour fourteen to eighteen feet of gas, and the oven burners consume eighteen to twenty feet when the gas is turned on full. Simmerers consume much less than this.

**10. Simmerers.** Every gas range should have a simmerer on it. This is a small burner, usually about an inch in diameter. After a large kettle full of food has been heated to boiling, this burner may keep it simmering for hours, using very little gas. This burner will keep small kettles of food boiling.

**11. Air Mixer.** Gas escaping from any pipe will burn, but it will burn with a yellow flame. To make gas burn with a blue flame—that is, to secure complete combustion—air must be mixed with it. This is done in the air mixer (Fig. 4). The blue flame is desirable for cooking because it is hotter than the yellow flame and does not blacken the cooking utensils.

Gas passes thru the air mixer before entering the burner. Sometimes the air inlet is only a hole put in the under side of the pipe. The opening for entrance of air is shielded so that the gas will not escape from the mixer, but will go on into the burner. A gas pipe looks about half an inch in diameter, but the stream of gas which is allowed to flow into the burner is

very small, in some cases being about the diameter of a darning needle. The opening for air is so large, that a person's finger may be put into it.

Too much air interferes with the burning of the gas; in fact, there can be so much air mixed with gas that it will not burn. The air mixer regulates the amount of air which flows into the pipe. Once this is adjusted for the kind of gas to be used, it seldom needs to be changed. The air shutter has to be changed, however,



FIG. 4. Part of gas stove showing air mixers.

if the gas pressure varies markedly from time to time. Re-adjustment may be required if the stove is moved and connected with a different supply of gas. When adjusting the mixer for high pressure, artificial or natural gas, close the shutter until the flame will not blow away from the cone, but will burn with a blue, almost colorless, flame.

**12. Regulating the Gas.** The amount of gas which passes into the stove is also regulated, first, by adjustment of the size of the small opening thru which the gas must flow. Once this is adjusted, it does not need to be changed so long as gas comes from the same source. Second, the flow of gas

is regulated by the lever valve. As the valve is turned, the flow of gas is restricted so that it flows less swiftly. The size of the stream of gas going into the stove always looks the same regardless of its speed. When the rate is not so fast, the fire burns lower because less gas comes to it during every unit of time.

**13. Lighting the Stove.** Light the top burners by first striking a match, and then turning on the burner so that there will be an unrestricted flow of gas. Count three before applying the match. This gives time for the burner to fill with gas. If the match goes out, shut off the gas and try again. If it burns back into the air hole, also turn off the gas and begin again. Probably the match was applied too

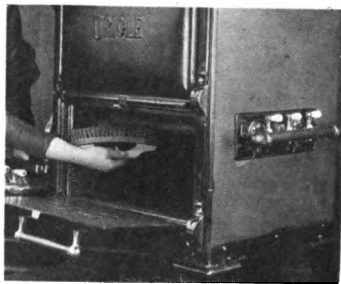

FIG. 5. Cleaning gas stove.

soon. Gas stoves get out of order because of carelessness in lighting them. The force of the explosions caused in burning back loosens connections and may disturb the adjustment of the mixer and valve.

**14. Cleaning the Stove.** Housekeepers should keep their gas stoves clean. Dirt interferes with the passage of the gas thru the burners. Gas stoves should be cleaned thoroly once a month. Scrub the burners with a stiff brush (Fig. 5), and wash all greasy parts with soap and water. If the holes should be clogged, remove the stoppage with a wire hair-pin (Fig. 6). Clean the drip sheet every day, or as often as it becomes soiled. (Fig. 4.)



**15. Accidents with Gas Stove.** Accidents with gas stoves are the result of mismanagement. The odor of gas in a room indicates a leak in the gas fixtures, such as stoves or pipes. When such an odor is noticed, open windows and extinguish all fires in the room or building. Next search for the leak. It may be due to an open valve. See that these are all shut tight. If no valves are open, send for a plumber who looks after gas fixtures. Leave the windows open and do not



FIG. 6. Cleaning burner of gas stove.

carry lighted matches or lamps into the room until the leak has been stopped. Many accidents happen at the time the oven is being lighted. Sometimes gas escapes into a closed oven, so that its odor is not noticed in the kitchen. This gas catches fire or explodes when the oven burner is lighted, blowing the oven door open or off the hinges, flashing out of the oven, and burning any person near the stove. To avoid such accidents, always open the oven and broiler doors a few minutes before lighting the oven. Fig. 7 shows construction of gas-stove oven. If any odor of gas is noticed on opening the doors, fan this out. Leave the oven and broiler doors open a while after extinguishing the fire and removing the cooked food. Gas may get into the oven at the time the flame is extinguished.

**16. Pilot Light.** Most stoves are constructed so that there is a pilot light for the oven. Always use it when light-

ing the oven. It is put there for the safety of those using the stove. There is no need for alarm when a pilot burns back, no matter how much noise it makes, since so little gas flows thru the opening. One of the functions of a pilot light is to prevent people from being burnt in case of an explosion in the oven. For this reason, they should be at the side of the stove.

If the pilot burns back, close it; wait a minute, and then try lighting it again. The regular burners of the stove should not burn back if properly lighted by the pilot. Be careful to see that every part of the oven burner

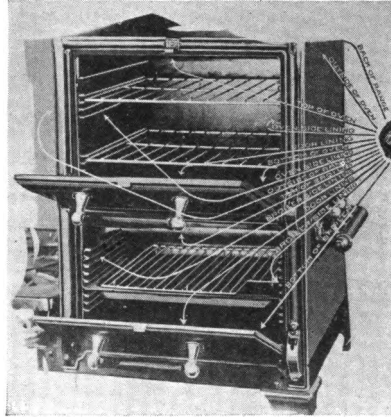

FIG. 7. Gas ovens.

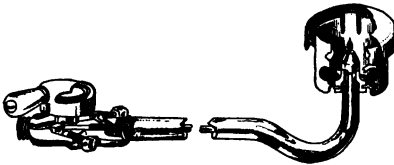

FIG. 8. Pilot light for gas stove.

becomes lighted. Turn the burners on full while lighting them. After they are once lighted, turn them as low as desired.

**17. Pilot for Top Burners.** A pilot made for top burners (Fig. 8) burns continuously with a very tiny flame. Its purpose is to save gas, patience, dirt and matches. The saving comes because the housekeeper can so easily re-light the burners that she will turn them out whenever she is not needing the fire. Sometimes when the gas pressure is low,

the pilot light will go out. It can be re-lighted by pressing the valve as for lighting the burners and touching a match to it. If the pilot goes out, the odor of gas will be noticed in the kitchen until it is re-lighted.

**18. Gas-Stove Lighter.** There are two kinds of gas-stove lighters. These differ from the pilot in that they do

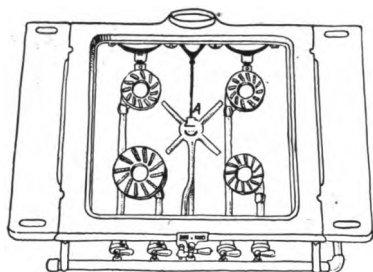

FIG. 9. Top view of gas stove, showing lighter.

not burn constantly. One of these is so constructed that it is first necessary to apply a match to any one of the top burners. The other burners can then be lighted by opening the valve in the regular manner and pressing down on the lighter

knob. As soon as pressure on the lighter knob is removed, the gas supply to the lighter is automatically cut off (Fig. 9). The other lighter is made of metal which gives sparks easily when subjected to friction. The lighter is held over the stove, the gas turned on and the friction produced by rubbing one part of the lighter across the other, making a spark which ignites the gas.

**19. Amount of Gas Used.** It is claimed that 1,000 feet of illuminating gas produce as much heat as 50 or 60 pounds of anthracite coal or 4-1/2 gallons of kerosene oil. (See table on page 219.)

The difference in gas bills, due to management of gas stoves, is considerable. It is very easy for one woman to use three times as much gas as another in doing the same amount of

work. Some women do not realize when they are wasting gas.

Water boils in an uncovered vessel at 212 degrees Fahrenheit, and no amount of heat applied to it will make it any hotter. When a pot of food has reached the boiling point, a smaller flame will keep it boiling. Turn the gas as low as it may be safely turned and still keep the pot boiling, and the food will cook as rapidly as when the gas is turned on full.

Gas is a safe fuel in most hands; it saves the housekeeper much labor because it makes so little dirt. When properly managed, it is the cheapest fuel to be had at the present time.

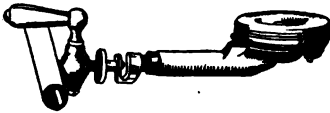

FIG. 10. Single top burner and valve.

**20. Cold-Process Gasoline Gas Stoves.** Cold-process gasoline stoves require a burner fitted with valves in which the gas orifice can be enlarged or diminished. The best of these for using cold-process gasoline gas can be adjusted by a turn of the finger.



FIG. 10-a. Oven burner.

The adjustment of the valve is to compensate for the neglect upon the part of users of these plants. Very frequently they will allow the supply of gasoline in the carburetor to run nearly out before they replenish it, in which case the gas comes to the burners in a thinner quality, and in order to provide the same volume of heat, it is necessary to adjust the burner valves and throw a larger stream of gas into the burner. They are sometimes fitted with burners having side-sawed caps (Figs. 10 and 10-a). These seem to expose the burning gas to the air in a way to make it burn better than in

other burners built for gas forced into them by greater pressure than is this gas. The opening for air must be adjusted from time to time so as to keep the proportion of gas and air such that it will produce a blue flame.

**21. Acetylene Stoves.** Stoves for the burning of acetylene are similar in construction to gas stoves. Tho acetylene furnishes a satisfactory and economical light, it is not an economical fuel when compared with kerosene, gas, wood or coal. For this reason, it is not much used. It requires two and three-tenths units of acetylene gas to equal one unit of natural gas for heating.

## CHAPTER III

### OIL STOVES

**22. Purpose of Oil Stoves.** Oil stoves are designed for the comfort of the woman who cannot have a gas or an electric stove. They consist of tank, feed pipe and burners (Figs. 11-*a* and 11-*b*). As they are portable, they can be moved to a summer kitchen or sheltered back porch on hot summer days.

Oil stoves are not fool-proof and should never be used by those who are afraid of them and who do not understand them. Manufacturers have done much to make accidents avoidable, and they send detailed instructions with each stove. These should be followed exactly.

**23. Mechanical Parts of Kerosene Stove.** The kerosene oil stove consists of a tank of oil with a pipe leading to a hollow ring-like cup below the burner (A, Fig. 11). When the burner is lighted, the oil passes down this pipe into the ring, where it becomes heated and is vaporized. As the vapor rises, it is mixed with air and burns with a blue flame. The small holes in the chimney of the burner and at the base of the burner are to admit air. They must be kept open.

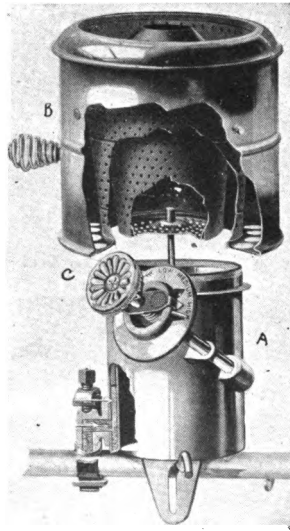

FIG. 11. Parts of oil stove burner.

If the burner is dirty or not properly adjusted, the right amount of air may not reach the vaporized oil to mix with it and the stove will burn with a yellow flame, making soot and smoke.

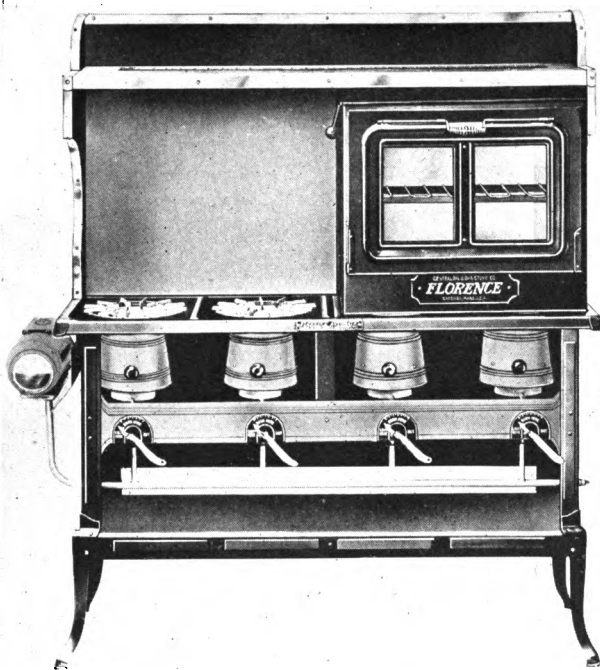

FIG. 11-a. Large oil stove with oven.

**24. The Burner.** The burner consists of a chimney, a wick or ring of asbestos, a valve or a lever, and a ring-like cup at the base of the burner. There are three distinct types of burners known as long chimney, short chimney and wickless.

The wickless stoves are equipped with a ring of asbestos which serves the purpose of a wick.

The burners on one oil stove are usually all alike. The burners on various makes differ. Those in which the flame comes nearest the kettle or cooking food produce the most heat for cooking (Fig. 12). Those with the blaze farther away from the food seem to be

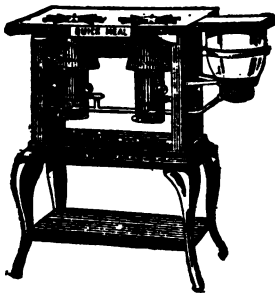

FIG. 11-b. Oil stove without oven.

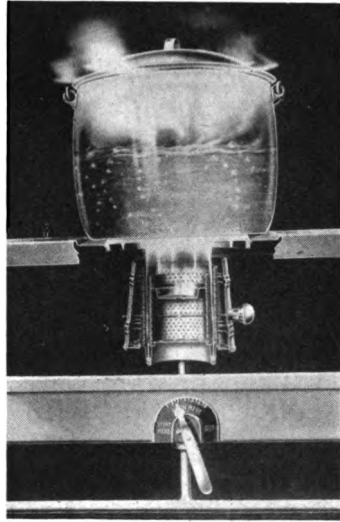

FIG. 12. Oil stove burner, showing fire close to utensil.

easier for the excitable woman to manage (Fig. 13).

**25. The Chimney.** Kerosene stoves are furnished with metal chimneys. A device for mixing air with the burning fuel forms a part of short chimneys (*B*, Fig. 11). The chimney must set on the burner properly, or the stove will not burn with a blue flame. After lighting a burner, give the chimney a turn or two to make sure that it is in place. There is usually a groove into which it fits.

**26. Lighting the Stove.** When lighting a stove, turn the valve which permits the oil to flow (*C*, Fig. 11) into the



cup below the burner, or lower the lighter into the oil. Wait a moment, if need be, for the wick or ring to become saturated with oil. Raise the chimney and touch the lighted match to the ring or wick at several places. (Fig. 14, and Fig. 11, also,

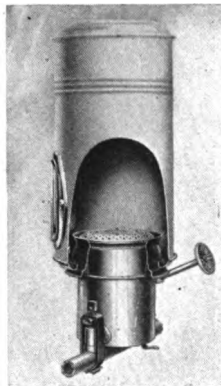

FIG. 13. Burner for oil stove.

show the position of the chimney and wick for lighting.) Lower the chimney, seeing that it fits back into place. Adjust the wick to the proper height to get a blue flame (Fig. 15). Do not turn very high at first, for, while the stove is becoming heated, the flame burns higher and higher, and may begin to smoke.

#### 27. Management of the Flame.

Turn the flame no higher than is needed to keep the pot boiling. Some stoves do not burn well when turned very low. Do not have the flame so high or so low that it gives off smoke or gas. When turning out the fire, be sure to turn the wick clear down, or turn the valve or lever (Fig. 12) to the point indicated as *out* on stoves which lift the ring above the oil. If this precaution is not taken, most stoves leak oil when not in use, because the wick or rings carry oil to the upper part of the burner where it spreads over the stove.



FIG. 14. Lighting oil stove.

**28. Adjustment and Care of the Stove.** To prevent

trouble with uneven flames, set the stove perfectly level, particularly the wickless one. Keep the tank filled, but not too full. Stoves are made so that it is difficult to fill them too full. An oil stove cannot explode unless gas has formed in some part, like the tank, and becomes ignited by heat or a spark. Gas is more likely to collect in the tank when it is almost empty.

When the tank is removed for filling, any gas forming passes out into the room and mixes with so much air that it is harmless. If it is filled before the oil burns out of the pipe above the level of the burners, no gas will be formed.

Stoves must be kept clean. A clean stove means one with a clean framework, clean burners, clean chimney, clean oil and a clean wick or ring.

If a stove has not been in use for some time, replace the old wick with a fresh one (Fig. 16). Clean the stove by wiping off all the parts with a cloth. Keep the charred edges of the wick trimmed level. The wick with a crust of char on top does not burn well. Use a match or small stick in removing the char. Light the wick to see if it is even. If any point burns with a yellow flame, trim this place until the wick burns even. The tank can easily and quickly be lifted off modern oil stoves. Do not re-fill near a lighted stove.

**29. When the Stove Gives Trouble.** In case the stove

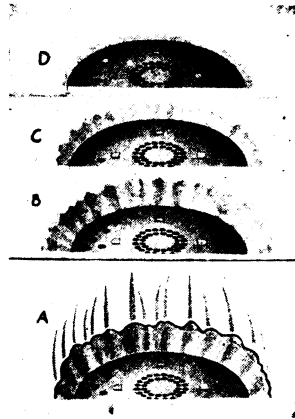

FIG. 15. Different types of flames.

begins to blaze and cannot be controlled by the valves, remove the tank and carry it to some safe place where the kerosene in it cannot catch fire. When this is done, there is less than a pint of oil left in most stoves, and this will soon burn out without doing much harm, if clothing and water are kept

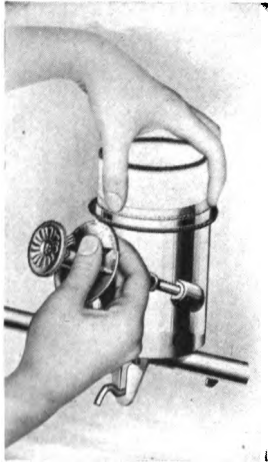

FIG. 16. Inserting new wick.

away from the blaze. Open windows and doors to let out gases and smoke. If necessary, move the stove away from walls or furniture. Do not attempt to smother out the flame. There is too much danger of clothing catching fire when this is done. It is far safer to let the small amount of oil left in the stove burn up. Oil stoves cannot explode when the tank is removed.

As soon as the oil has burnt out of the pipes and the wicks are burning with a dull glow, extinguish the smoldering fire on the wicks by

patting them with the blade of a knife or a piece of woolen cloth.

If a burner has been blazing beyond control, remove the chimney. Brush out any soot which has formed. Examine the burner, taking it apart, if possible. Blazing may come from wicks not fitting, or from their getting so short that the screw on the lever fails to move them up or down. The ring in wickless stoves may not be thick enough, or they may have slipped out of place, or become broken. Replace with new wicks or rings.

Notice if any part of the burner shows evidence of melting. If it does, do not use this burner until inspected and mended by an expert. If the lever has become worn so that it fails to work, it must be replaced or a new burner put on the stove.

**30. Construction of Gasoline Stoves.** The gasoline stoves consist of a burner and an oil tank connected by a pipe (Fig. 17). The tank is elevated for the purpose of forcing the gasoline into the burner. The pipe may be any length. The danger from a gasoline stove comes from the fact that gasoline vaporizes at a low temperature. If the tank becomes heated, producing gas, and then becomes mixed with the proper proportion of air, it may explode if it comes in contact with a spark. (Fig. 17-a is an illustration of the cross-section of the Red Star gasoline or vapor stove. See page 38.)

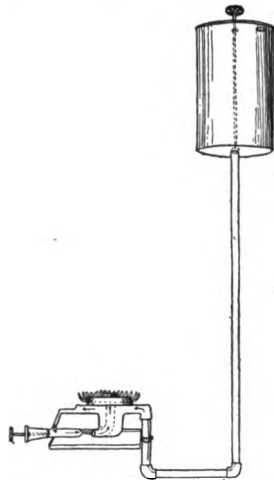

FIG. 17. Simple gasoline burner.

From the pipe to the burner is a very small opening, so that a stream of gasoline little larger than the diameter of a needle flows into the burner proper, when the valve is open. The valve may be partly closed so that the stream will not flow so fast.

Below the burner is a small cup. When the stove is cold, the gasoline flowing into the burner collects here.

**31. To Light the Stove.** The way to light the stove is to turn on the gasoline until it fills the cup below the burner.

When this is full, close the valve. Set this gasoline on fire. As it burns, it will heat the burner.

The burner is heated so that when more gasoline is turned on, this heat will change the gasoline to gas. If the burner is not hot enough to do this, the gasoline flowing from the pipe

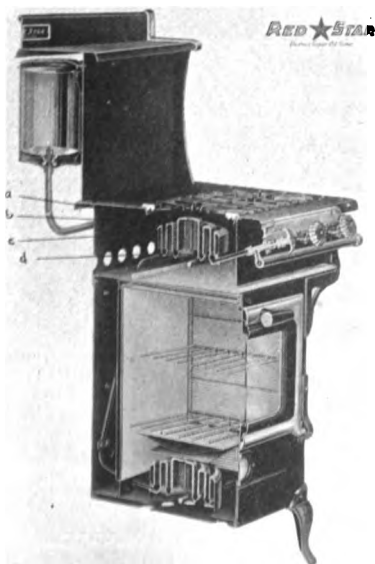

FIG. 17-a. Cross-section of gasoline stove showing burner.

will flow down into the cup and the stove will burn with a smoky flame which becomes higher and higher and looks very alarming.

When this happens, the valve should be closed, and the fire permitted to burn all the gasoline which has collected in the cup. This may be sufficient to heat the burner. Test after the fire has gone out, by lighting a match, turning on the gasoline and touching the lighted match to the burner. If all right,

it will burn with a blue flame; if not, it will burn with a yellow flame. If the yellow flame is noticed, turn out the fire by closing the valve, and let the burner get cold before attempting again to light it. See that the burner has not become clogged with soot or dirt. Then proceed to re-light the stove.

Air must be mixed with the gasoline to make it burn with a

blue flame. The air enters the burner through the same tube that the gasoline flows into the cups when the burner is cold. In the burner are small holes for the escape of the gas mixed with air, and here the blue flame should appear, and nowhere else. If it appears elsewhere, the burner is not working properly. Sometimes the gas ignites at the point where the air is mixed with it. The fire should then be turned out and the stove re-lighted immediately.

If the little holes where the flames should be, or if any other part of the stove is clogged with soot, it will not burn as it should. It must be cleaned. *A dirty gasoline stove is dangerous.*

**32. Filling the Gasoline Stove.** Never get oil on the tank or any part of the stove while filling it. If oil is spilled, wipe it up before igniting the stove. Do not fill the tank when the stove is lighted or when there is a fire anywhere near the tank. If the fire has been burning, close all the valves and wait until it goes out before opening the tank. Close the valve from tank to pipe before filling. Fill the tank and cover it before lighting the stove again.

Keep the tank filled. As soon as the indicator, which is attached to a cork which floats on top of the gasoline, shows that the oil is low, turn out the fire and refill the tank. Do not fill the tank to overflowing. Gases from the stove can only get into the tank when it is empty and while there is gasoline in the pipe to feed the stove. Gasoline gas is very inflammable and will cause an explosion if it becomes ignited. The tanks from gasoline stoves cannot be removed, as all the joints must be tight to prevent the escape of gasoline fumes as well as the oil itself. The opening to the tank must never

be left uncovered, except for the few minutes while the tank is being filled. The greatest care is required in using a gasoline stove; in fact, they are so dangerous, that they should not be highly recommended for household use. The description and care of them are given here because some persons persist in using them when they desire a quick, hot fire in cases where fuel gas is not available.

### **33. When a Burner Blazes and Cannot Be Controlled.**

When a gasoline stove burner blazes and cannot be controlled, first close the valve leading from the tank into the pipe. There will then be little gasoline to burn, and no gases can get back into the tank.

*Keep clothing and water away from the blaze.* Remember that the stove is set on a metal frame which is not inflammable. Shield walls and other objects so that the burner may blaze high without doing damage. Clothing catches fire easily, but the metal stove will not be consumed.

If the valves are shut, the blaze will cease when the gasoline has burnt out of the burner and pipe. If the gasoline continues to flow out of the burner in spite of turning the valve and there is a danger of its spreading to the floor or table, set a shallow pan under the stove to catch the gasoline. It can burn in this way with considerable safety. Do not attempt to carry a burning stove. Simply protect floor, walls and furniture from catching fire, and let the gasoline burn.

### **34. Changing Fuel in Vapor Stoves.**

There are some stoves which are interchangeable, in that they may be adjusted to burn kerosene, gasoline or distillate. These are of the type called "vapor" because they change the oil to gas before it is ignited. A change from one kind of fuel to another

should never be made without thoroly cleaning the stove and adjusting it to the fuel that is to be used.

**35. Operation of Vapor Stoves.** It is safest to use kerosene in these stoves. Distillate is a name given to a different mineral oil product from kerosene or gasoline. To work well, these burners must be kept clean. (Fig. 17-a.)

The operation of the stove is simple. Put enough fuel, such as alcohol, into a burner to heat it hot enough to change the oil to be used to gas and ignite it.

After the burner has heated for three or four minutes, turn on the fuel valve in the pipe which leads from the tank to the burner. The fuel will light from the burning alcohol already in the burner. Adjust the height of the flame by valve, which regulates the amount of fuel flowing into the burner.

If anything boils over, put out the fire. Close the valve. Remove the parts of the burner. Clean and wipe them dry. Replace the parts of the burner, and, if not cool, turn on the fuel and light. If cool, heat as for first lighting, and turn on the fuel.

Extinguish the fire by closing the valve which stops the flow of oil to the burner.



## CHAPTER IV

### ELECTRIC STOVES

Electric stoves consist of frame, heating unit and switches to regulate the flow of current. Some are equipped with oven, thermometers and special utensils (Fig. 18).

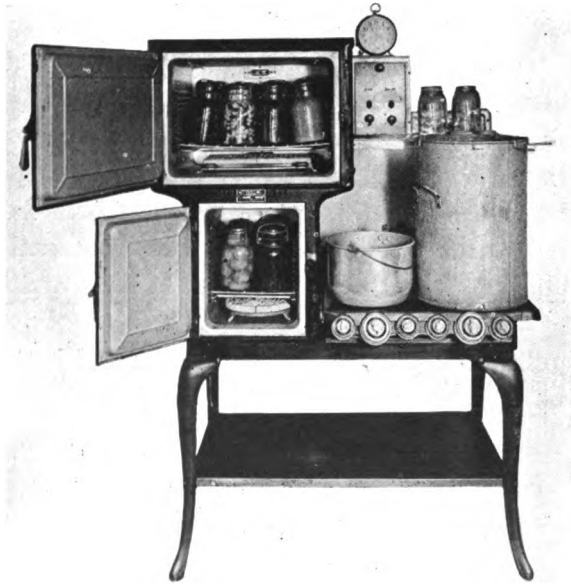

FIG. 18. Stove equipped with utensils.

**36. Heating Unit of Electric Stove.** The heating unit consists of coils of wire or a plate of metal thru which the current flows, meeting resistance and producing heat. If the

current flowed freely thru the wires, little heat would be generated (Figs. 19 and 20).

**37. Wiring of Stoves.** It is advocated that a separate circuit of heavy wire be put into all houses where current is used for purposes other than lighting, to provide for cooking and power connections.

Too heavy loading of wires with electric appliances causes the burning of fuses and sometimes damages the electric system. Find out how much current the wiring of the house will carry before attaching new devices. There is danger of fire if too much current is allowed to pass over a wire of too small size.

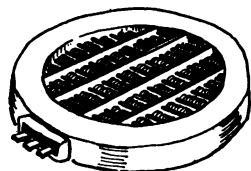

FIG. 19. Heating unit of electric stove.

**38. Operation of Electric Stoves.** Many stoves are equipped with a switch which permits different amounts of



FIG. 20. Heating unit of electric stove.

current to pass thru the stove according to the way the device is set. At one point it gives low heat; another, medium, and a third, high heat, and, lastly, no heat.

The cooking of food on an open burner should be started

with high heat turned on so that the food may cook quickly. If a large amount of food is cooking, there will be so much radiation from the vessel that it may require all the current to keep it cooking. After food has started cooking, the switch can be turned to medium, and, later, to low, depending upon the amount of food and the temperature desired. Low will keep an ordinary pan of water boiling, once it has started.

A few minutes before the food is to be removed from the open burner, the current should be turned off, as the heat in the stove will continue the cooking for several minutes. From tests of electric stoves, it appears that in most of them the food will continue to cook after the switch is turned off for about the same number of minutes that it requires to raise the heating unit to a temperature sufficient to boil water in a small shallow pan. A housekeeper who is using electricity for cooking can soon learn how long the open burners and oven of her stove will keep food cooking after the current is turned off, and by putting this information to use, she can save many dollars in a year.

**39. Care of Electric Stoves.** When thru with a stove, always turn off the current. Great care should be taken that the stoves do not become overheated. This shortens the life of the stove.

Sudden cooling of the coils of wire caused by liquids spilling on them, and corrosion of the wires caused by dampness, wear out stoves faster than need be. Do not wash or brush dirt from burners having open coils of wire. Burn all dirt from the burners.

**40. Utensils for Electric Stoves.** The most economical use of electricity can be secured with utensils built around the

heating units (Figs. 20 and 21), and the next most economical use with utensils built especially to fit the heating units. This means that there would be a heating unit for each utensil, or size of utensil, and the expense of equipment would be considerable. Also, more care would be needed in washing the utensils and in preventing them from becoming bent. Such facts must be considered in choosing between stoves with special devices and those on which any pan may be set. After installing an electric stove, start with new utensils because they will not blacken on an electric stove, and so can be washed with the other dishes.

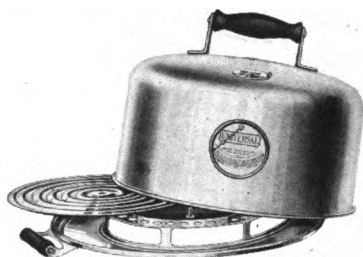

FIG. 21. Utensil with heating unit.

When ordinary household utensils are used, they should be of such shape that they stand flat, as they also should on a coal range. The most economical use of heat is secured when the area of heat is smaller than the area of the bottom of the kettle and is concentrated on the utensil. Care should be taken when stoves are installed, that they are properly grounded so that they cannot burn any one. A light bulb is attached to some stoves so that when the current is on the light burns, and when it is off, the light goes out. Such a light should be on all large stoves.

**41. Detachable Cooking Devices.** Cooking and heating devices should have larger wires than those for lighting alone. Consequently, the attachment of a heating device in

a common light socket may cause burning out of fuses or other damage.

One danger in using detachable electric devices occurs in not turning off the current when the stove is not in use, thus permitting it to become overheated. This shortens the life of the stove.

Any tendency of a stove or other electric device to give people a shock when being used should be taken as a warning to have the device examined by an expert and the trouble corrected. Have the wires repaired as soon as the insulation breaks or burns off. Uninsulated wires, such as cables and cords, are unsafe.

## CHAPTER V

### ALCOHOL, ACETYLENE, AND CANNED HEAT

**42. Alcohol Stoves.** Alcohol stoves are made only in small sizes for light housekeeping. There are three general types of these—those which burn with a wick, those which generate gas, and those which permit the alcohol to burn off of the top surface of the container.

Alcohol does not produce much smoke in burning, even when no provision is made for mixing air with it. The ordinary alcohol lamp, having a wick, may be used as a heating stove. Stoves with wicks draw the alcohol up by capillary attraction to the point of ignition, and the metal jacket about the wick prevents the fire burning back into the bowl containing the alcohol. The char from the top of the wick must be brushed off from time to time. No other care is needed for these stoves or lamps. Some of them are provided with devices for checking the burning of the alcohol in order to regulate the heat. This is desirable since a small flame of alcohol produces much heat.

Extinguish the fire by covering the wick with a metal cup.

**43. Vapor Stoves.** Alcohol vapor stoves which generate gas hold the alcohol in a tank slightly raised above the level of the burner. A pipe leads from this to the burner, where a small stream of alcohol is permitted to enter when the valve is open.

When starting these stoves, the valve is first opened and enough alcohol allowed to flow out to fill a cup which is below

the burner. This generally holds about a tablespoonful of alcohol. When the cup is full, the valve is closed and the alcohol in the cup ignited.

This heats the burner enough to vaporize the alcohol. When the burner is heated, open the valve and ignite the gas. If all the alcohol is not vaporized, the burner has not been heated hot enough. Close the valve until all the alcohol in the cup is burnt.

**44. Wickless Stoves.** Wickless alcohol stoves are used commonly on chafing dishes. The burner of one type consists of a metal dish packed with a porous material which is non-inflammable, but a good conductor of liquids by capillary attraction, and the top is covered over by a wire screen. The alcohol is poured into the dish. The packing and screen prevent air from entering the bowl with sufficient rapidity to let the fire burn below the screen so the flame stays above it, burning off any alcohol which is conducted to the surface.

The only possible way to control these stoves is by a device which can cut off air. One of these is a plate-like device with a handle. This fits over the stove and only that portion of the top burns which is exposed to air thru the hole in the plate. Making the hole larger or smaller makes the burning surface larger or smaller.

To extinguish the fire, cover the entire top with a solid plate to cut off all air.

**45. Canned Heat.** Canned heat is alcohol combined with other substances into a cake about the consistency of hard soap. The cover to the can is used to extinguish the fire. It should not be fitted into the top of the can until the flame has been extinguished for two or three seconds. Then

it should be fitted on as tight as possible to prevent waste alcohol by vaporization.

**46. Acetylene Gas Stoves.** By adjustment of the amount of air that enters the burner, acetylene may be burnt in a gas stove. Usually a cap is placed over the air hole while the gas is being ignited. This is removed as soon as the gas is lighted, so that it will burn with a blue flame. The use of the cap prevents burning back. It is best, however, to use stoves especially designed for burning acetylene.



## CHAPTER VI

### FIRELESS AND STEAM COOKERS

**47. The Fireless Cooker.** The fireless cooker is a box or can having a diameter somewhat larger than that of the largest vessel to be placed in it. The space left around the vessel is packed with some insulating material to keep in the heat (Fig. 22). In home-made cookers, this material may be hay, feathers, pillows, shredded newspapers, wood shavings or sawdust. In commercially-made cookers, it is felt, asbestos wool, cork, or other insulating material. Because most insulating material will not stay in place and readily absorbs moisture and odors, some kind of lining is put between it and the vessel holding the food. This makes a little nest, into which the vessel fits. In the better made cookers, this lining is made of metal, and the seams are water-tight.

The steam from the cooking food is absorbed by the insulating material if this lining is not impervious to water. Enameled or earthen linings, if well glazed, would also serve this purpose as long as they did not chip or crack.

The cover, as well as the sides, of the fireless cooker has to be padded with the insulating material. The cover must also fit well so that the steam and heat will not escape thru cracks between it and the body of the cooker.

**48. The Stones of Fireless Cookers.** The stones for fireless cookers are usually made of soapstone or some composite which will absorb considerable heat. They should be slightly smaller in diameter than the nest. They can only be used with safety in cookers which are metal-lined and insu-

lated with material which will not ignite at a low temperature. Stones should not be put in home-made cookers which are not insulated with asbestos or other fireproof material. Hot stones can be used with safety in any of the commercial cookers which come fitted with them.

The temperature in a fireless cooker is below boiling most

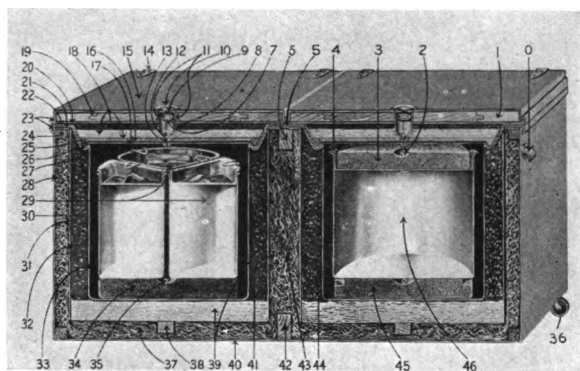

FIG. 22. Section of fireless cooker.

of the time. It is, therefore, a device for simmering food, and should be used for cooking meats, fruits, vegetables and cereal dishes which require or are improved by long, slow cooking.

Since the food has to be shut in a fireless cooker to keep in the heat, fireless cookery is a method of steaming of food. For this reason, it has a slightly different flavor from food baked in the oven, much as fried food differs from roasted food. Hot stones (Fig. 22) are put in most fireless cookers. The heat from these brown the food and give to the otherwise steamed food a flavor similar to that developed in baking, roasting and frying.

**49. Heating the Stones.** Moisture given off by the cooking food is absorbed by the stones. They must be dried or heated very slowly to prevent this moisture from cracking them. When the stones have been removed from the cooker, wash them, because they absorb odors from the food. Keep them in some warm, dry place while they are not in use, such as in the warming oven of the cook stove or on a radiator. When wanted for use, they will then be dry enough to be placed over the gas-stove burner if it is not turned too high at first. Drying thus saves time when the stones are needed.

**50. Care of the Cooker.** The cooker should be left open to air while not in use. As soon as the food and stones are removed from it, the moisture should be wiped out and the inside washed with soap and water, wiped dry and left to air. Such care is needed to prevent the cooker from taking on the odor of dishes previously cooked and transmitting some of them to those cooked later.

**51. Other Devices Belonging to Cookers.** In most commercial cookers there are wire devices to raise the dishes of food from the stone (Fig. 23). This prevents scorching and boiling over when the stones are heated very hot. These devices are also used to hold a hot stone above the food to make a brown crust on it. Some cookers are furnished with valves, permitting the escape of steam when it becomes too abundant. The pressure of the steam automatically opens the valve. This device insures the cooking of certain vegetables, cereals or doughs without their becoming too soggy to be palatable (A, Fig. 23).

**52. Directions for Using the Cooker.** Put the stones on to heat. Prepare the food as for cooking in any other way.

Then heat it, either in the oven or on top of the stove. It is preferable to heat the food in the same vessel in which it is to be cooked in the fireless cooker. Transferring food to a cold

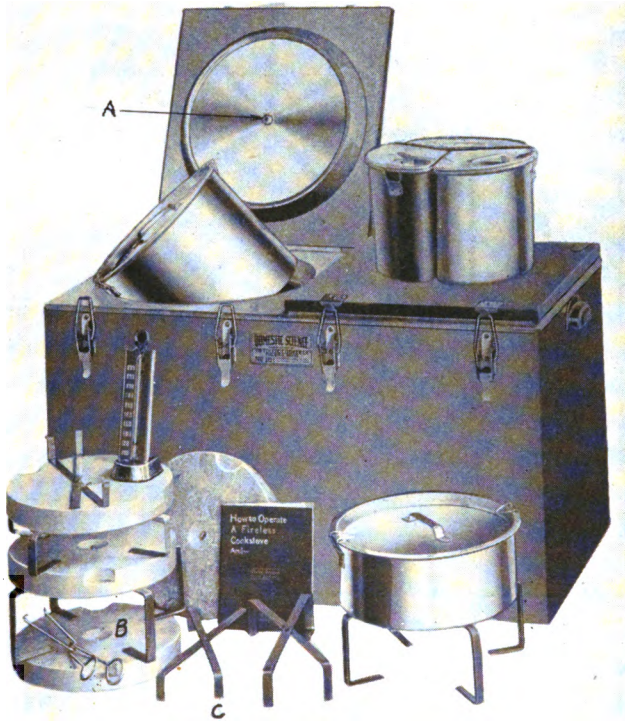

FIG. 23. Devices for fireless cooker.

vessel entails a loss of heat, since the first vessel is already heated.

When the stones and food are hot, place the stone in the bottom of the cooker. Put in any asbestos mats or other

devices which are needed to protect the food. The stone should be hot enough to respond to the test for flat irons. It should make the snappy noise of a good hot iron when the finger is moistened and touched to it. Place the food in the cooker. Place another stone above the utensil if it is desirable to have

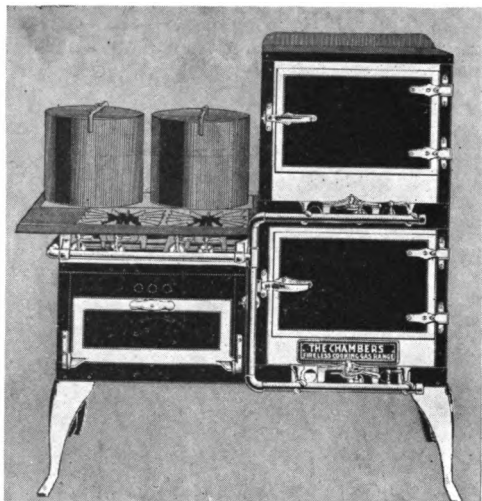

FIG. 24. Gas cookers.

the food brown on top. Close the fireless cooker, and let it stand until ready for use.

**53. Time of Cooking Food.** Six hours or over night should be allowed for the cooking of cereals. Stews should be given two to three hours' time for cooking.

Large roasts and hams require five to six hours. It is sometimes necessary, when they are large, to remove them and heat the food and the stones on the stove once during the process of cooking. Dumplings and angel cakes cook well in a fireless cooker. So do all dried peas and beans.

It is profitable to cook foods requiring more than forty minutes' heating in a fireless cooker. The heating unit is a part of some cookers.

Electric cookers, instead of being furnished with stones to be put inside the nest, have a heating unit and plate for holding heat in the cooker. Cold food may be put into this cooker, the current turned on, and the heating and cooking all be done inside the cooker. The electric oven which is well insulated answers the purpose of a fireless cooker when the current is disconnected. Either a thermometer, which the housewife may watch, or thermostat, which controls the current, must be attached to electric cookers to prevent burning the food or injuring the cooker with too much heat.

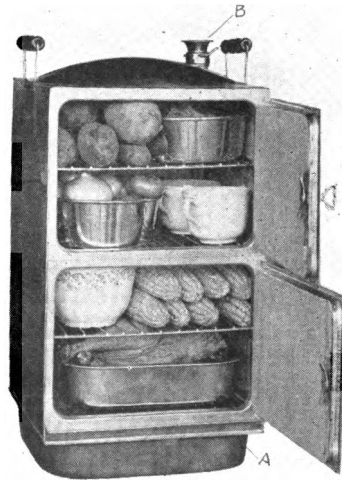

FIG. 25. Steam cooker.

**54. Gas Cookers.** Since heated air rises, special cookers in the form of insulated caps are made to put over dishes of food heated on gas burners (Fig. 24).

The inside of the cap must be kept clean. Get the dishes hot with the cap suspended over the food, but leaving about an inch space for the escape of gases from the heating unit. As soon as the food and cap have been sufficiently heated

over the fire, turn off the gas and lower the cap so that it will retain the heat. After the cooker has been used, it should be wiped out clean; otherwise it will retain some of the odors of the cooked food.

**55. Steam Cookers.** There are several steam cookers in use in homes. The simplest of these is a covered pan which has a perforated bottom, which is set over another pan (A, Fig. 25), in which water is placed for forming steam. One of the difficulties of this cooker is that the water in the lower pan cannot be watched and may boil dry. On the more improved cookers a whistling device (B, Fig. 25) is attached to the pan, and when the water becomes low and steam ceases to flow thru it, air begins to come in, and the device makes a whistling noise.

### QUESTIONS FOR PART I

1. What is smoke? Under what conditions is the greatest amount of heat for cooking or other household purposes produced from fuel?
2. How is an oven made to heat evenly?
3. Explain the purpose of each draft and damper on a stove.
4. Observe the amount of fuel used in a coal stove from day to day. Make the same kind of observation for a gas or electric stove. How was the stove managed when the least fuel was used?
5. Describe the construction of a gas stove. Find the vent thru which the gas enters the burner. Is this large or small?
6. Where is the air regulator? For what is it used?
7. What has happened when the gas in a burner "burns back"?
8. How should a kerosene stove be regulated? How should it be cared for?
9. What precautions should you take against fire from kerosene and gasoline stoves?
10. Describe the heating unit of an electric stove.
11. How may electric current be saved in the operation of an electric stove?
12. How does a fireless cooker cook food?
13. How may one determine when it is economical to use a fireless cooker?

## PART II

### HEATING DEVICES

#### CHAPTER VII

##### WARM-AIR FURNACES

**56. Principle Upon Which a Furnace Works.** The success of warm-air heating depends on a natural circulation of air thruout all the rooms which are to be heated. The air is the vehicle of transmission of the heat from the fire to the rooms to be warmed.

A warm-air furnace is simply a large stove encased in a sheet-metal jacket (Figs. 26 and 27). The jacket is usually insulated with asbestos, since the stove is set in the basement where radiation of heat is not desired. The air entering the casing is warmed by the stove. As the air is warmed, it expands and becomes lighter, so rises to the top of the furnace; from here it is conducted to the rooms above. The warm air which has passed upward must be replaced by cooler air entering at the bottom of the jacket. In the rooms above, there must be outlets for the cold air, already in them, so that it may be replaced by the incoming warm air. Cold-air shafts from the floor leading downward serve as outlets. Sometimes they return the cooled air to the base of the furnace jacket.

**57. The Stove Part.** The stove part of the hot-air furnace consists of a fire pot supported above a place where the ashes may fall and a chimney to carry off smoke. The draft



below the grate in the fire pot lets in air which is essential to the proper burning of the fuel. In this respect, it is similar to a cook stove. A draft above the fire when opened a little lets in air which aids in the complete combustion of the gases

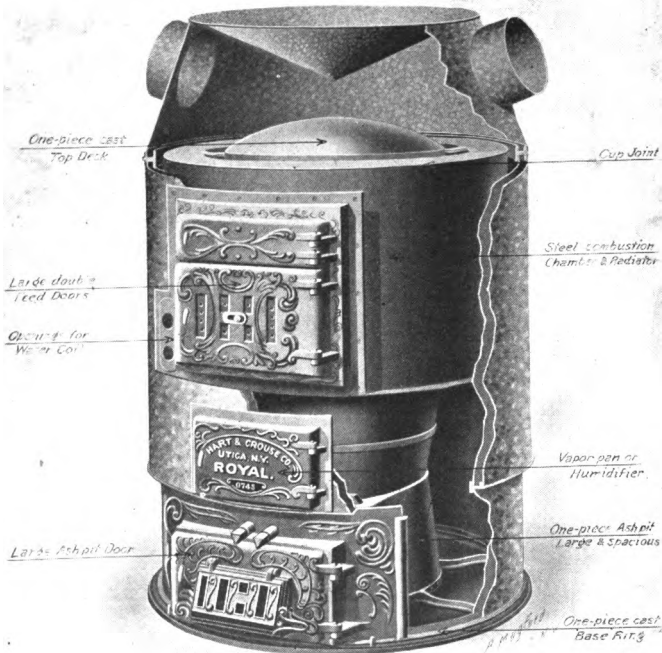

FIG. 26. Warm-air furnace.

given off by the fuel. Burning these gases adds to the amount of heat secured from the fuel. Opening the draft wider checks the burning of the fire. There should be a damper in the smoke pipe. When this is closed, it checks the draft up the

chimney. This is needed because some chimneys often draw up air too fast to make the fire burn well. When checking the fire, close the draft below, open the one above the fire box, and close the one in the pipe. To make the fire burn fast, open the draft below, close the one above the fire box, and

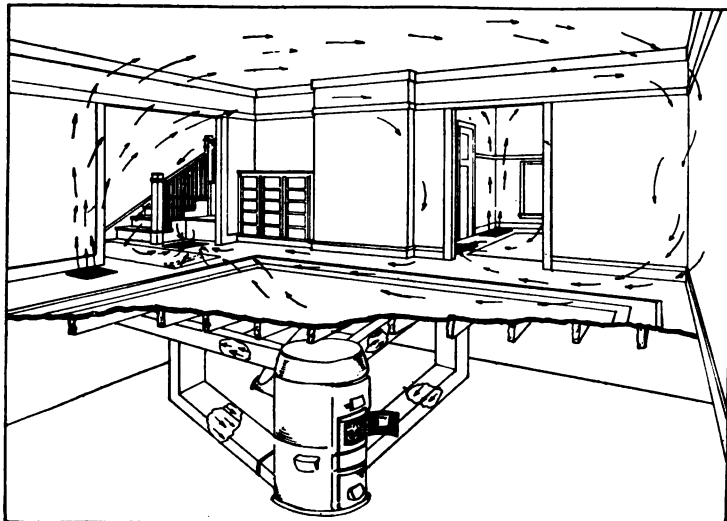

FIG. 27. Circulation of warm air.

open the one in the pipe. Remember that a fire will not burn well if there is too much draft. Adjust the drafts until the fire burns with a clear, bright flame without giving off smoke. After a fire is built, the manner of adding fuel makes a difference in the efficiency of the furnace. When using coal, add it in rather small amounts, spreading it in a layer over the entire fire. Do not make this layer so thick that the fire smokes. The fuel will not burn with a clear flame if the fire is being smothered. Much fuel is wasted by ignorant and careless management of furnaces.

**58. The Cold-Air Shaft.** It is thru a cold-air shaft that the cooler air comes into the furnace. Some furnaces have this built so that it draws the cooling air from the rooms above down into the furnace to be heated again. This is an economical arrangement. Some others draw fresh air from out of doors into the furnace, letting the cold air from the rooms above drain into the cellar and out of doors. This is more expensive, as the air to be heated is usually colder, but it has the advantage of helping ventilate the rooms by bringing a constant supply of fresh air.

The cold-air shaft leading from out of doors should have the outer end covered with wire mesh, and a cloth which should be washed or renewed often.

Never sweep dirt down a register or cold-air shaft. It comes back into the room in time. Dust the registers occasionally.

In older heating systems, there was but one large cold-air shaft to drain the cold air from the rooms above. In more modern houses, a cold-air shaft is placed in every room that may be shut off from the others. This does away with the old difficulty of heating a closed room, for it is as important that the colder air gets out as that the warm air gets in.

**59. Hot-Air Pipes.** The hot-air pipes lead from the top of the jacket about the furnace to the floor above. In most houses, one pipe goes to each room. This is unnecessary if the rooms are not closed off, but if they are, they need the pipe entering the room. To economize with heat and regulate the amount of air passing up these pipes, there must be a shutter in them, near the furnace, as well as in the register. This shutter is placed near the furnace so that no heat passes

into the pipe when not wanted in the room to which it leads. This saves waste in radiation from the pipe in the cellar. When a room is not in use, close this damper.

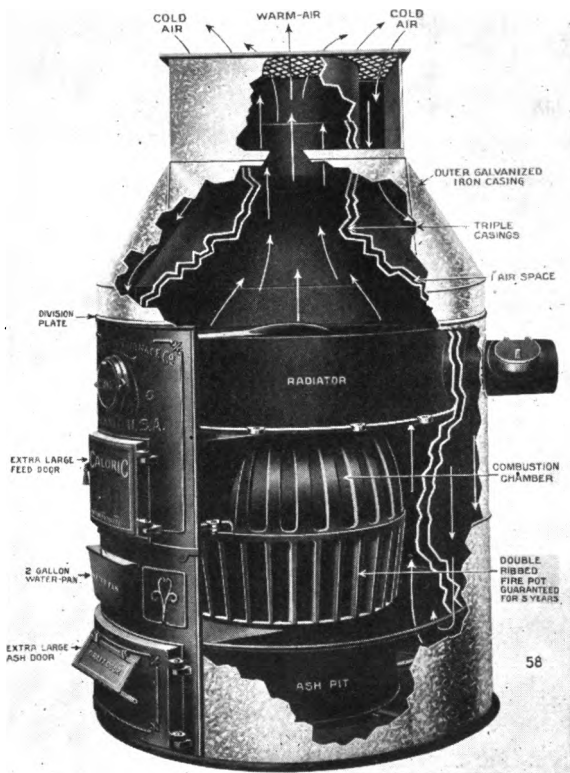

FIG. 28. Pipeless furnace.

Since warmed air will continue to travel upward so long as it stays warmer than the air above, it is important that the pipes have a continuous rise thruout their entire length, tho in some parts the rise may have to be only very slight. The

shorter the pipes, the better, for there will be less loss of heat from radiation on the way to the rooms.

**60. Location of the Furnace.** A central location for the furnace is best because the pipes may be shorter, and this

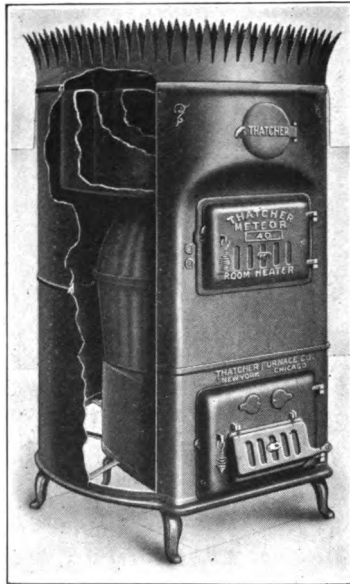

FIG. 29. One-room, hot-air heater.

makes possible a greater elevation per foot of each pipe, so that the air can flow thru it faster. A central location also permits a uniform distribution of pipes about the furnace, which, in turn, produces a more even flow of air to all the rooms.

The air from the hot register rises to the top of the room, or, if the way is open, to the top of the house. Here it spreads

over the upper area. As it cools or is displaced by still hotter air, it falls. When it reaches the floor, it flows down the cold-air shaft in the floor. If the cold-air shaft is not in the floor, there may be a layer of colder air there so the room will not be comfortable.

**61. Air.** There is a constant change of air in all houses, due to opening of doors and the fact that walls are not airtight. This may not be enough for comfort. If a room is not heating well, it has been found that opening the window to change the air in the room, even when the outside air is very cold, helps in the circulation of air in the room, and so with the warming of it. It is difficult to warm a room filled with stagnant air.

**62. Pipeless Furnaces.** The pipeless furnace works on the same principle as the one with pipes (Fig. 28). One large opening above the furnace lets the heat in to some central room, and from here it circulates into all other rooms not closed off from the central room. The cold-air shaft may be around the opening for heated air.

Stoves encased in a metal jacket that operate like hot-air furnaces (Fig. 29) are used in heating one-room schoolhouses and other small public buildings.

## CHAPTER VIII

### HOT-WATER SYSTEM OF HEATING

**63. Equipment for Hot-Water Heat.** The hot-water system of heating a house consists of a boiler in the basement or below the level of the lowest radiator. This boiler is designed to heat water as it circulates thru coils over the fire

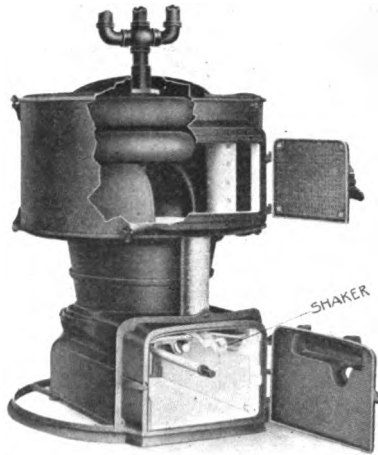
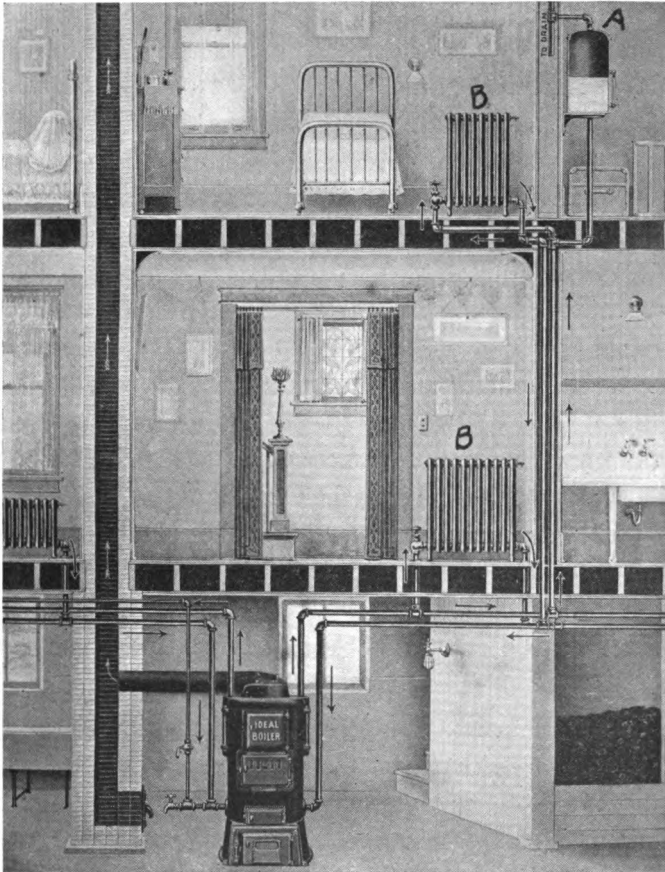

FIG. 30. Garland furnace with hot-water boiler.

(Fig. 30). From the boiler, pipes lead to radiators and an expansion tank, and return pipes bring the cold water back to the bottom of the boiler (Fig. 31).

The heat from the furnace fire causes the water to circulate thru this system of boiler, pipes, radiators and tank, due to the fact that hot water is lighter than cold water.

**64. Heating Unit.** The heating unit of a hot-water system is like any stove consisting of a fire pot and grate. Some are adjustable so that different kinds of fuel may be



**FIG. 31.** Hot-water heating system.



used. A gas burner is sometimes placed in the fire pot and used for heating a furnace, but this is one of the most wasteful ways of using gas. A real gas furnace is much more economical. The fire and heat from the fire circulate around the coils containing the water. If the coils are not constantly kept full of water, they will be injured by the heat.

**65. The Management of the Fire.** When burning coal, spread the coal all over the surface of the fire in a thin layer so as not to smother it and thus make it burn with a smoky flame. Keep the ashes cleaned out from underneath the fire and around the fire pot. Clean the flues every forty-eight hours. Soot on the coils is more effective than asbestos would be in keeping heat from penetrating to the water. Regulate the fire with the drafts. Open the one below the fire box to let in air to aid combustion. Open the one found in most furnace doors a very little. This aids in the combustion of gases, thus making more economical use of the fuel, while opening it wider checks the burning of the fire. Broken and warped doors and drafts let in too much air and destroy the efficiency of the heater. Open the chimney damper, shown in Fig. 2, Sec. 3, admitting air to check the draft. Close the chimney or pipe damper of the type of cook stove shown in Fig. 2, Sec. 3, to check the draft up the chimney.

**66. The Pipes.** The pipe carrying the hot water from the boiler out to the heating system leads to the expansion tank, tho sometimes separate pipes lead from the boiler to a radiator. Insulate each pipe, except the part in the room to be heated, with asbestos or some other covering, to keep the heat in it. Keep the pipes full of water. When they are installed, see that they are put in so that they gradually rise

upward. If they dip downward at any point, air will collect at these places and check the circulation of hot water thru pipes.

**67. Expansion Tank.** The expansion tank (A, Fig. 31, and Fig. 32), placed somewhat higher than the top of the highest radiator, is fitted with an overflow, for water expands as it is heated. If the expansion tank is closed so that the overflow pipe will not open except under pressure after the air in the tank has become compressed by the expansion of the water, a higher temper-

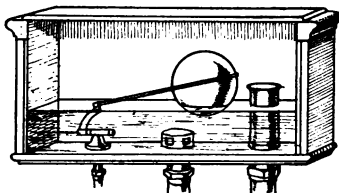

FIG. 32. Expansion tank.

ature in the pipes may be reached, but such a furnace must be given more careful attention than one with an open expansion tank. Learn to know the parts of a heating system and how they operate before trying to manage it.

**68. Water.** Fill the boiler and radiators full of water, and add enough more to partly fill the expansion tank. From time to time, note the height of water in the tank, to know if more must be added. Do not add water when unnecessary, as fresh water tends to rust pipes faster than water from which the carbon dioxide and air have been exhausted. To note the height of water, read the gage.

If there is much sediment in the water used, this must be drawn off from the bottom of the boiler to prevent its accumulating there. When this is done, fresh water must be added to replace the water drawn off. Loss of water from evaporation must also be replaced. No water should be put into the system except to replace such loss. Do not draw the

water out of the system, and refill it from time to time. The practice of changing the water in the furnace rusts it more than keeping the same water in it all the time.

**69. Radiators.** Radiators (*B*, Fig. 31) are made of rather complicated coils of pipe, so often an accumulation of air lodges in them. This interferes with the circulation of the water and the radiator does not get hot. There usually is a vent (*A* and *B*, Fig. 33) attached to each radiator to let out air which collects there. If a radiator does not heat well, open the air vent until the air ceases to flow from it and water comes; then close it.

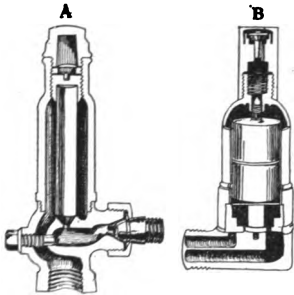

FIG. 33. Vents for radiators.

Valves should be placed at places where cold water collects in bad plumbing.

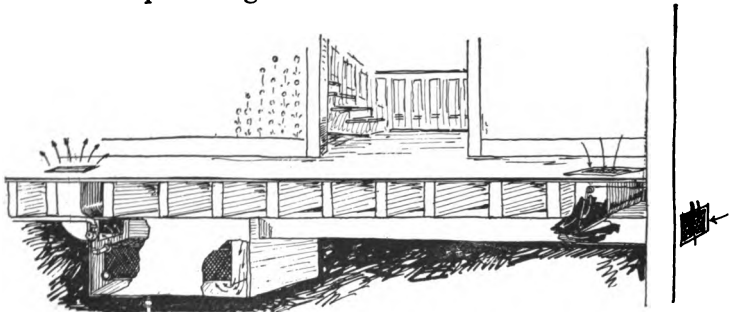

FIG. 34. Radiators under floor.

In very cold weather, do not entirely shut off the valve of the pipe leading to any radiator, as the circulation of a little warm water is needed to keep it from freezing. Radiators may be placed under the floor (Fig. 34) when so desired.

## CHAPTER IX

### STEAM-HEATING SYSTEMS

**70. Equipment for Steam Heat.** A steam-heating system consists of a boiler, a fire pot, pipes from the boiler leading to the radiators, and radiators (Fig. 35). On some

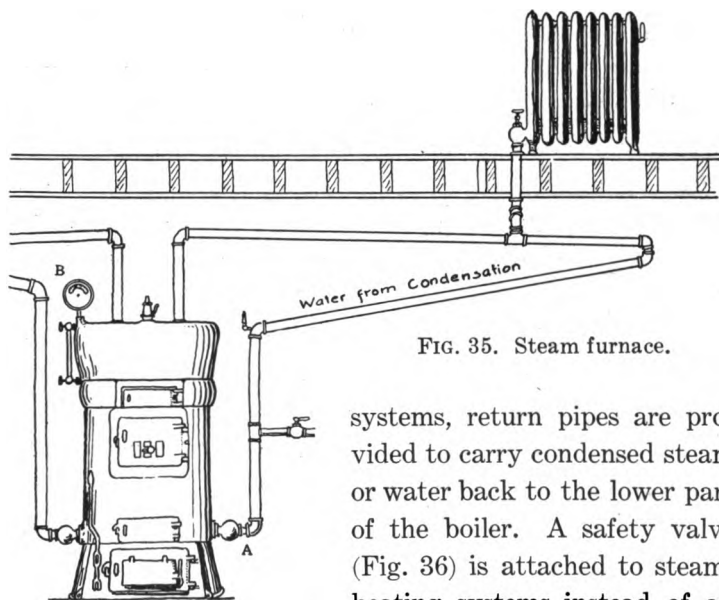

FIG. 35. Steam furnace.

systems, return pipes are provided to carry condensed steam or water back to the lower part of the boiler. A safety valve (Fig. 36) is attached to steam-heating systems instead of an expansion tank. This keeps the pressure of the steam in the boiler from becoming too great, and thereby prevents an explosion. The pressure gage (*B*, Fig. 35) must be set, and, when set, should only be changed by a person understanding it. Build and manage the fire for a steam boiler the same as

for any stove or furnace. Keep water in the boiler at 212 degrees Fahrenheit, so steam may form, for without it, the radiators will not be heated. Small valves are attached to most steam radiators. Their purpose is to let out air, which accumulates in the radiator. As soon as the steam begins to come into the radiator, it forces the air out of the valve. When it reaches the valve, the heat in the steam causes part of the valve to expand and close the outlet, which is small. When the radiator is hot, steam should not escape, provided the valves are in good working order. There is a gage (Fig. 37) furnished with each boiler which shows how much water is in it.

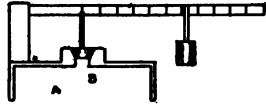

FIG. 36. Safety valve.

Keep enough water in the boiler to come within certain lines on the indicator. The top of one of these lines is usually six or eight inches from the top of the boiler. There is always some variation in the amount of water in steam furnaces on account of the formation and condensation of the steam in pipes and radiators. See that the boiler is never empty, but do not put in fresh water except when necessary.

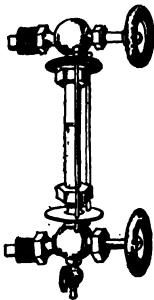

FIG. 37. Water gage for steam plant.

The space above the water in the boiler is left for steam. The loss of water from a boiler in good working order is thru the air valves in the radiators. If the furnace is properly managed, very little water should be lost during the course of a year, so there is little need for adding water.

Some furnaces have two pipes to the radiators. When steam is shut off from a radiator, the valve leading to the

pipe which carries off the water from condensed steam must be closed, also, to prevent the pressure of the steam in the boiler from forcing water from the boiler up this pipe. This may happen because the pipe draining the water from the radiators enters the furnace near the bottom of the boiler. The steam being retained in the furnace presses down on the water and so may force water up the drain pipe, if it is not closed, instead of raising the safety valve.

Carelessness of this kind may work much damage, for by this means all the water from the furnace can be forced up into the radiators, leaving the boiler empty. This makes it important that every woman should understand the steam-heating system in her home.

Some steam-heating systems have a check valve in the pipe which returns water to the boiler. This valve permits water to flow thru it in but one direction; that is, toward the boiler. This prevents a rush of water from the boiler to the radiators.

Steam furnaces, also, are often equipped with another safety-valve device, which is a plug of metal which melts at a rather low temperature and is placed in the boiler directly over the fire. If the water line in the boiler falls low, this plug melts and steam from the boiler puts out the fire, thus saving the furnace from damage.

However, melting out the plug makes much work both in replacing the plug and in cleaning the fire box to rebuild the fire, so that it should not be depended upon to regulate the heat in the boiler.

Knocking in steam radiators occurs most often in those systems using the inlet steam pipe for the return of the water

which has formed as a result of condensation. It is caused by water accumulating at some point and the steam coming up the pipe, violently forcing it back into the radiator. This only reaches a danger point in systems which do not have pipes of the proper size, or when the pipes do not slope gradually downward, so that all the water may flow back to the furnace. On cold days, there will be some knocking in a steam radiator when it is being heated in the morning. A two-pipe system, while it is somewhat more expensive, is less subject to this trouble.

**71. Steam Gages.** Steam gages (*B*, Fig. 35) are devices for indicating the pressure of steam within an inclosure. They are a kind of spring balance. When the pressure of the steam increases, it pushes up on the spring, and this turns the hand of the indicator, which shows the number of pounds of pressure that the steam is exerting on the inside of the boiler or container.

**72. Safety Valve.** A safety valve (Fig. 36 and *A*, Fig. 38) consists of a small opening to a boiler over which is a weight. When steam is developed until it makes enough pressure on the inside of the valve to raise this weight, some of the steam escapes, thus lowering the pressure on the inside until the weight falls back into place. Never let anything interfere with the action of safety valves.

Most safety valves have the weight attached to a lever which has a movable weight on it so that the position of the weight on the lever makes a difference in the number of pounds of pressure required to open the valve. By means of this device, the temperature of the inside of the boiler can be

kept at one heat or another as desired, since this temperature increases or decreases with the pressure under which the steam is held.

Thus, fifteen pounds pressure means a different temperature from ten pounds pressure. Be sure to adjust the weight for the temperature desired. Pushing the weight toward the valve lessens the amount of pressure needed to open the valve. There is usually a steam gage on boilers to indicate the temperature and pounds of pressure inside. When the indicator reaches the point desired, the safety valve may be set so that all steam in excess of the desired amount will escape. When this is done, the temperature will be held constant in the boiler so long as a good fire under it is maintained.

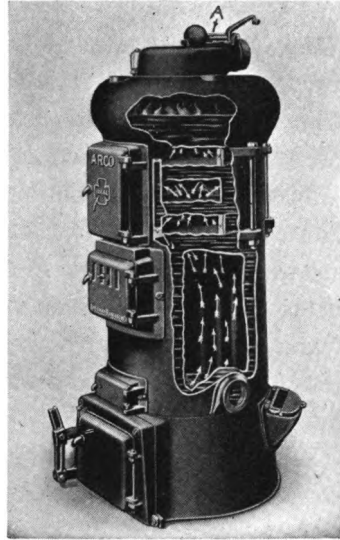

FIG. 38. Heating plant showing safety valve.



## CHAPTER X

### FIREPLACES AND HEATING STOVES

**73. Construction of Fireplace.** Fireplaces are an enlargement in the base of a chimney where fire is built. The upper part of the fireplace is sloped forward, and, in some cases, a damper is placed in the chimney to regulate the flow of air upward. The damper should not be so constructed that it will close entirely, for if it did, the smoke would come into the room. The fire in the fireplace burns best when the fuel is put in a grate or on andirons so that air can get under it and be drawn thru it by the draft of the chimney. A steady draft makes the combustion of the fuel complete and thus prevents smoking.

The hearth is made of fireproof material and should be wide enough to catch all sparks flying from the fire. A screen is often needed for safety from fire. Do not pile reserved fuel or put rugs on the hearth.

Fireplaces and chimneys should be built of fireproof brick, stone or concrete. Have them examined once a year for cracks, as these make them unsafe. The walls of the chimney and the fireplace should be thick enough to prevent danger from fire.

**74. Management of Fireplace.** The management of a fireplace is very simple. The draft up the chimney should be properly regulated so that the fire does not smoke. Sparks and bits of fuel should not be drawn up the chimney. The fire should be built so that it is not smothered. Air should circulate thru the fuel. Keep the ashes cleared away.

There are some fireplaces which are intended to heat rooms after the manner of hot-air furnaces. The heat and smoke from the fire pass upward thru a metal heater, encased by an air chamber. Much of the heat passes thru the metal, warming the air in the chamber. This warmed air passes thru pipes and registers into the rooms, while the smoke finds its way to the chimney. To complete the circulation of air, the cold air from the floor passes into the air chamber near the floor at the sides of the fireplace. Sometimes fresh air from the outside of the building is mixed with the air in the chamber.

If there is an opening in the floor of the fireplace, a damper should be put in this opening to regulate the flow of air. The heater in a fireplace must be kept free from soot and ashes. If the metal is covered with soot, heat will not readily pass thru it, and the soot will collect moisture and cause rusting.

One way to keep the heater clean is to regulate the draft up the chimney so that ashes and bits of burning fuel are not drawn into it. Also, the fire should be kept burning with a clear (not smoky) blaze. Soot is unburnt fuel.

**75. Operating Heating Stoves.** A stove is a device for holding the fuel and for permitting the heat to pass readily into the room. In the stove there is space below the fire for collecting ashes. There is an opening for fresh air to enter below the fuel, to aid combustion, and a damper above to act as a check draft when open, a chimney to carry off smoke, and one or two dampers in the chimney to regulate the draft.

When a fire is being built, close the draft over the fire box and open the one below; open the damper in the chimney—this allows the free passage of the air up the chimney.

**76. Care of the Stove.** Do not permit a large bed of ashes to accumulate in the bottom of a stove. A thin layer of ashes must be kept in the bottom of some wood stoves to keep the fire away from the metal bottom.

The polish or finish of the stove is a matter of taste. Some stoves are made of iron, which does not need blacking; some must be blacked. Blacking keeps them from rusting. All must be kept free from dust and dirt, as this accumulates moisture and causes the stove to rust.

Letting the stove get red hot warps it. It should not be permitted to get so hot.

The grate (Fig. 3) in stoves holds the fuel so that air can flow up thru it. If the grate is clogged with ashes, this cannot happen. The grate should be shaken to make the ashes drop thru. A clean grate is important to the complete combustion of the fuel. Shaking after glowing coals begin to fall is a waste of fuel.

When an attempt to shake the grate is made, it may suddenly refuse to move. In this case, something may have lodged between its parts, or it may have been shaken from its proper position. Shaking the stove too hard may displace the grate. The common remedy for a displaced grate is to let the fire go out, remove all ashes and cinders, and readjust the grate.

Some kinds of soft coal form "clinkers," and these catch in the grate. In burning fuel that makes clinkers, shake the ashes from the fire several times a day. Remove all accumulations in the fire box daily. Clinkers are made from substances which melt and recombine, forming a different material which is quite hard and does not burn. Constant attention to the fire prevents clinkers from forming in large masses.

## CHAPTER XI

### GAS, ELECTRIC AND KEROSENE HEATERS

**77. Kinds of Gas Heaters.** There are several types of gas heaters—those using an illuminating flame and reflector, those fitted with a Bunsen burner and an asbestos back, and those heating water in a device like a radiator. The last two

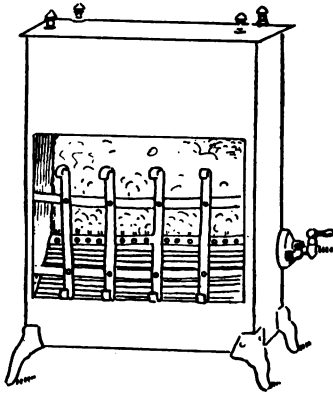

FIG. 39. Gas heater showing air mixer.

burn with a blue flame. All gas stoves ought to be fitted with a flue for discharging the products of combustion.

**78. Bunsen Burner and Asbestos-Back Heater.** The burner is a long pipe punctured with holes extending across the stove. There is an opening for mixing of air with the gas at the point where this pipe enters the stove, and a valve to regulate the flow of gas (Fig. 39).

**79. Lighting Gas Stoves.** To light the stove, open the valve, count three, and apply a lighted match to the burner. Counting three gives time for the pipe to fill with gas, so that the fire will not flash back and burn in the air mixer.

**80. Care of Gas Stoves.** The only care that this stove needs is to keep it polished so that it will not rust. Keep the burner clean of dust and soot. Be sure that the valve is entirely closed when the gas is turned off, and that the pipes fit tight at all connections so that gas cannot leak into the room.

**81. Illuminating Flame and Bright Metal Reflector Heaters.** These heaters are used with manufactured gas.



FIG. 40. Reflector gas heater.

They burn with an illuminating flame since there is no device for mixing air with the gas as it enters the stove. The bright metal reflector not only makes an attractive stove, but reflects the heat out into the room. Some stoves are made with tips of aluminum or other non-corrosive metal over the openings in the burner (Fig. 40).

Gas logs are a type of gas heaters used in fireplaces (Fig. 41).

**82. Gas Radiator Heaters.** Gas radiators (Fig. 42) are another type of gas heater. The radiator is a coil of pipe. The heating unit is below the coil and works like any other Bunsen burner. A small amount of water is kept in the pipes. There is a device attached to the radiator to automatically adjust the height of the gas fire (A, Fig. 42).

**83. Management of Gas Radiator.** Put enough water in the radiator or coil of pipe to fill it to the depth of one inch. Keep this amount of water in it at all times.

Light a match, turn on the valve which lets gas flow into the burner, wait for it to fill with gas, and touch the match to the burner.

Most of these heaters are fitted with thermostats.

In about thirty minutes after lighting the gas, the water will have formed enough steam inside the radiator to automatically turn the valve lowering the gas flame. If the steam pressure falls low, the thermostat will permit more gas to flow into the radiator by automatically opening the valve.

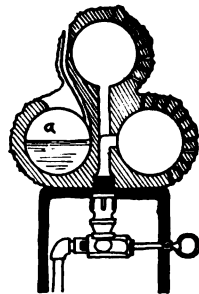

FIG. 41. Gas logs.

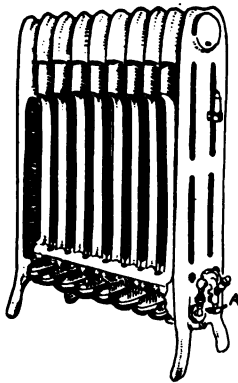

FIG. 42. Gas radiators.

There is a safety valve attached to the side of the radiator which opens if the automatic device fails to close off the gas before the steam pressure inside becomes too great.

**84. Kerosene Heaters.** Kerosene heating stoves have burners like those used on kerosene cook stoves. (See Chapter III.) Surrounding, or about, the burner is a jacketed air space. Here air is heated and rises to the upper part of the room while fresh air from the lower part of the room is drawn thru the jacket. Some heat is also given off by radiation. Fig. 43 shows a picture of an oil heater.

The burners of these stoves should be cared for the same way as the ones on cooking stoves. The stove should be kept polished and free from dust. This prevents it from rusting. Wipe off any kerosene which may accumulate on the outside, for it makes an unpleasant odor.



FIG. 43. Oil heater.

Take care in moving kerosene stoves not to jar the chimney or other parts

of the burner out of place; otherwise the stove will smoke.

When the stove is lighted, turn the burner quite low. The flame will become higher as the parts of the stove become heated.

### 85. Electric Heaters.

The electric heaters (Fig. 44) are composed of one or more coils of wire thru which the electric current flows with difficulty. This heats the coils so hot that they glow. A reflector throws the heat out into the room. The coil and reflector are attached to a pedestal. They are desirable for use in rooms which are not quite warm enough. Care must be

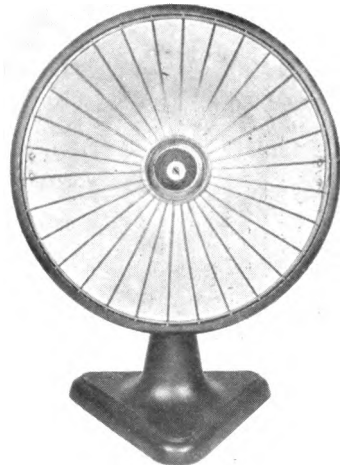

FIG. 44. Electric heater.

taken to avoid getting an electric shock from electric heaters, as from any other electrical appliances. If the stove seems to be out of order, have it put in order before using. Take care not to touch a water pipe or gas pipe at the same time when touching the heater in the bathroom, as there is a possibility of getting a shock.

**86. Acetylene Heaters.** Acetylene heaters are similar to the Bunsen burner and asbestos-back gas heaters. They are provided also with copper side reflectors. They are used only in localities where gas or electricity cannot be had.

#### QUESTIONS FOR PART II

1. What are the essentials in heating a house with a hot-air furnace?
2. How does the "pipeless" furnace differ from the other types?
3. Explain the circulation of water thru a hot-water heating system.
4. What is the purpose of the expansion tank? Where should it be located?
5. Describe a steam-heating system.
6. What care should be taken in managing a steam-heating system?
7. What precautions should be taken when using an electric heater?



# PART III

## LIGHTING DEVICES

### CHAPTER XII

#### ELECTRIC LIGHTS

**87. Kinds of Electric Lamps in Use.** The electric lamps on the market now are either tungsten (also called Mazda) or metallized carbon (called gem carbon) lamps. Of all lighting appliances, electric lamps and systems are most easily cared for. If properly selected, they make an excellent light from the standpoint of hygiene. It is important for every one to know enough about lighting to be able to select proper kinds and sizes of lamps.

**88. Electrical Measurements.** A volt is the unit of electric pressure which compares with the pound as the unit of water pressure.

An ampere is the unit of electricity flowing thru a wire which compares to the gallon as the unit of water per minute flowing thru a pipe.

A watt is the unit of electrical power. It is determined by multiplying the volts by the amperes.

A kilowatt equals 1000 watts.

A kilowatt hour equals 1000 watt-hours.

A watt-hour is the amount of energy needed by a device which uses one watt and is operated for one hour. For ex-

ample, a 25-watt lamp uses 25 watts, and if it is operated one hour, it uses 25-watt hours of electricity.

The cost of burning an electric lamp is the number of watts marked on the lamp multiplied by the hours the lamp is burned, and then translated into kilowatt hours and multiplied by the price per kilowatt hour.

**89. Carbon Lamps.** Few carbon lamps are being made now, but they may still be obtained in some stores. The carbon lamp can be distinguished from Mazda lamps (Fig. 45) by the appearance of the filament. The carbon lamp gives about 0.40 candles of light per watt of electricity consumed. Carbon lamps burn, making a yellow or reddish light, and consume fully twice as much current as Mazda lamps of the same candle power.

**90. Mazda or Tungsten Lamps.**

Tungsten lamps are the ones in common use. They give 0.80 to 1.00 candle of light to one watt of electricity used. They have a filament of tungsten and may now be used in any position. Less electricity is required to bring tungsten to a glowing white heat than other materials used in lamps.



FIG. 45. Direct light.

To compare the brightness of two lamps, do not look at the filament, but hold pieces of white material like paper at an equal distance from each lamp and compare the brightness of the surfaces; or put an opaque object in front of the light and

let a shadow be cast on another object. The brighter light will cast a heavier shadow.

When substituting a new tungsten lamp for a carbon lamp, select one about one-half the number of watts, unless more light is wanted. In houses, it is a common practice to substitute a 40-watt Mazda for a 50-watt gem carbon lamp, thus saving ten watts per hour and getting more light.

**91. Selecting Lamps for a Room.** There are so many possibilities for the use of electricity in lighting a house, that it becomes a fine art. When buying lights for a room, consider (1) the size of the room, (2) the use of the room, and (3) the color of walls, floors, ceilings, furnishings and decorations. For lighting purposes, lamps may be obtained ranging from 10 or less to more than 100-candle power.

There are colored, transparent and frosted globes. There are reflectors and shades of various colors and patterns. To obtain the same degree of illumination, smaller lamps are needed in small rooms than in large ones.

**92. Effect of Color Schemes Upon Illumination.** The color of the walls and furnishings makes a difference in the candle power required to give a certain amount of light. Those colors which absorb the most light require the higher candle power, and those reflecting the highest per cent of light require the lower candle power.

The frosted globes absorb some light, they diffuse the rest of it. They dispense with the annoyance of glare from lamps, and are useful in places where the full intensity of the lamps is not required.

The light absorbed by different colors varies considerably, as shown by the accompanying table:

TABLE SHOWING ABSORPTION OF LIGHT

COLOR	PERCENTAGE OF LIGHT ABSORBED
White.....	30
Chrome yellow.....	38
Orange.....	50
Clean pine wood.....	55
Yellow paper.....	60
Yellow paint (clean).....	60
Light pink paper.....	64
Dirty pine wood.....	80
Dirty yellow paint.....	80
Emerald green paper.....	82
Dark brown paper.....	87
Vermilion paper.....	88
Blue green paper.....	88
Cobalt green paper.....	88
Deep chocolate paper.....	96

**93. Distribution of Light.** Light in rooms for general use should be distributed as evenly as possible thruout the entire room. Avoid excessive contrasts of brightness and darkness. Have the lamps shaded to diffuse the light so that no one need look directly at the filament. When working by a light, do not put the lamp very close to the material, as this produces too strong contrasts of light and dark, or, when reading, it produces too much reflection from the white parts of the paper, which is trying on the eyes.

Direct lighting means that the rays from the lamp go directly into the room (Fig. 45). Indirect lighting means that the rays are all directed toward a reflecting surface such as the

ceiling (Fig. 46). From here they are reflected, giving an even amount of light to other parts of the room. When directed toward the ceiling, they make it the brightest part of the room.

A semi-indirect light avoids this difficulty (Fig. 47).

In diffused lighting, the lamp is covered, as by frosting, so that the rays of light are broken up and so scattered that no



FIG. 46. Indirect light.

direct ray shines into the eyes, and there is no bright spot of light in the room.

When costs must be limited, certain decorative effects must be weighed for their value, some being more expensive than others.

City lighting plants can provide current for any number of lamps in a house if it is properly wired. If more lamps are attached than the wiring will carry, and all are turned on, the fuses will burn out.

Electric plants for private homes (see Sec. 271) usually furnish current of a different voltage from city electric plants, so special equipment and lamps must be used with small plants.

Inquire of the company who installed the wiring or electric system, how many lights and other devices can be attached and for what voltage they should be made.

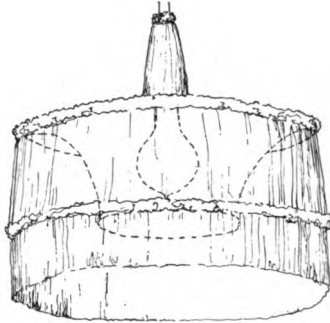

**FIG. 47. Semi-indirect light.**

## CHAPTER XIII

### GAS LIGHT

**94. Construction of Mantles.** A mantle is a device made of thread saturated with some fireproof material like a mixture of thorium and cerium which will glow, giving off a white light when heated hot. The mantle (*A* and *B*, Fig. 48) is placed over the burners of lamps

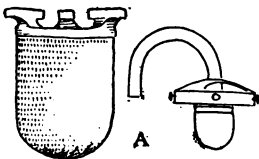
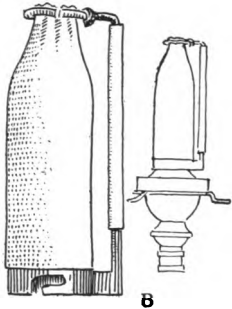

FIG. 48. Mantles.

using liquid or gaseous fuel. The gas is mixed with air so that it burns with a blue flame. The blue flame gives off little light, but it does not smoke and is much hotter than a yellow flame. When a mantle is placed over the blue flame, it is heated with less fuel consumption than is required to make a yellow illuminating flame. The light from the glow of the mantle is steadier and whiter than the light from an open flame, so that it is more hygienic.

Mantles are made in different patterns so that they may be used on upright and inverted burners. The inverted mantle throws more light downward than an upright mantle. This is advantageous in lighting a room, for most of the light is wanted in the lower part of the room. Mantles can be used on lamps burning gas, kero-

sene, gasoline, alcohol and acetylene if the burners are made to produce a blue flame. (See Figs. 48 and 52.)

**95. Care of Mantles.** Strong jars and drafts will break mantles, for they are very fragile. The explosion caused by burning back when the lamp is being lighted is most destructive to mantles. To save mantles, wait until the lamp has filled with gas before touching the lighted match to it.

**96. Fixtures for Burning Gas.** Gas will burn just as it escapes from a pipe. The flame of burning gas is yellow and makes considerable light. In order to secure more light for the

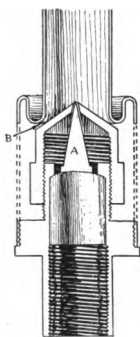

FIG. 49. Bunsen burner for gas light.

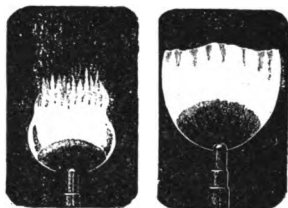

FIG. 48-a. Adjusting gas light.

amount of gas burned, put a tip on the end of the pipe, with a long, narrow slit in the top to spread the flame. These are usually lava tips. Natural gas gives very little light when burned in an open flame. Always burn it in mantle lamps. Its heating value is 1000 B. T. U. per cubic foot. When burned in a well-adjusted mantle lamp, natural gas will give about 15 candle hours per cubic foot. The heating value of manufactured gas is rated at 600 B. T. U. per cubic foot. It makes a fair light when used in an open flame burner. The yellow flame of burning gas makes considerable smoke, even when carefully adjusted. It gives four times as much light and no smoke when it is burned in a good mantle lamp.



In the special burner of the mantle lamp, the gas is mixed with air so that it will burn with a blue flame (Fig. 49). A blue flame is not good for lighting, but when a mantle is placed over the flame, it becomes heated, glowing hot. Since the mantle is made of a material which gives off a white glow, it lights the room with a steady light which is far better than the flickering light of the open flame (Fig. 48-a).

**97. Adjustment.** See that the ports thru which air is drawn into the lamp are open as wide as needed to give a clear, smokeless flame without firing back. Some lamps are fitted with a screw beside the cocks to regulate the amount of gas flowing into the lamp. It should be adjusted so that no more gas flows into the lamp than is needed to get as bright a glow as possible from the mantle. Regulate the gas flow by closing the valve attached to this screw until the mantle decreases perceptibly in brightness, and then slowly opening it until the mantle becomes bright. Gas companies often adjust lamps for their customers.

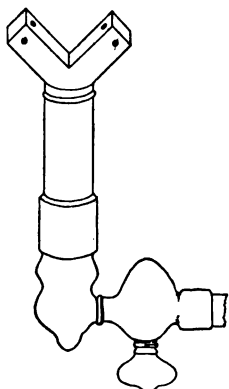

FIG. 50. Open-flame acetylene burner.

**98. Care of Lamps.** Clean the burners if they become sooted. Replace mantles if they are broken.

**99. Lighting a Gas Light.** When lighting a lamp, turn on the gas, count three, and then light the lamp. Counting three gives time for the burner to fill with gas and prevents burning back with an explosion. Mantles are very delicate

and easily broken by jars or strong drafts. Burning back may break the mantle.

Burning back means that the gas ignites at the opening where it should be mixing with the air instead of at the tip of the burner. This happens when the lamp is lighted before it becomes filled with gas, or when there is too much air mixed with the gas.

**100. Cold-Process Gasoline Gas.** It is more economical to use cold-process gasoline gas with a mantle lamp than an open-flame burner for lighting. Be sure to use the burners made especially for this kind of gas. The lamps are managed like all others.

**101. Acetylene Lamps.** Open-flame burners are used for acetylene gas because no mantle burner has been constructed which will operate reliably with this rich gas.

Acetylene gas gives about ten times as much light per cubic foot as manufactured gas burned in an open flame. The burners require little care. Sometimes the holes in burners become stopped, and they should be cleaned out with a fine pointed instrument like a needle. When they do not work well, it pays to replace the old tips with new ones.

Acetylene gas burners are constructed so that a very fine spray of gas strikes another fine spray, which, when ignited, makes a broad flame. This flame, which is almost white, gives off light. The burners appear as illustrated in Fig. 50.

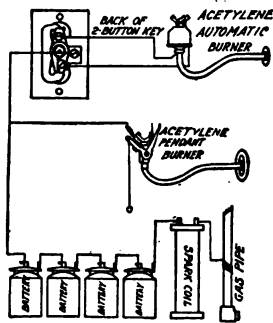

FIG. 50-a. Showing electric lighting device for acetylene burner.

**102. Care of Burners of Acetylene Lamps.** Keep the two holes open. Clean them with a large needle. See that there are no leaks about the burners or pipes. If these are found, fill with white lead or some similar substance, and tighten connections. If this does not suffice, the trouble should be referred to a plumber. Fig. 50-*a* shows an acetylene burner.

Acetylene lamp mantles can be used only with acetylene which is under high pressure. Therefore, they cannot be used with all plants. The special burner for mixing air with the acetylene to make it burn with a blue flame must be used with the mantle.

## CHAPTER XIV

### KEROSENE LAMPS

**103. Construction of Kerosene Lamps.** A kerosene lamp consists of a bowl, a burner, a wick and a chimney.

In the ordinary lamp, the bowl for holding the oil is placed below the burner (Fig. 51). The wick carries the oil from the bowl into the burner by capillary attraction — one end being in the oil and the other in the burner.

The burner, which has holes in it to let in air, holds the wick so that only the oil reaching the top burns. The area and shape of the flame depends upon the form of the top sur-

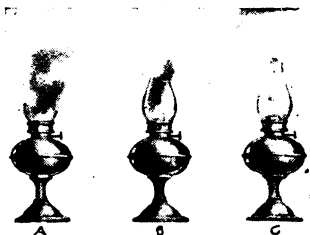

FIG. 51. Lamps and lamp chimneys.

face of the wick. The glass chimney is used to cause an air current thru the burner and to protect the flame from outside drafts. A screw moves the wick thru the burner. If the wick is too small, the fire may burn back thru the burner and ignite the oil in the bowl. It is important that a wick fit the burner. If the chimney is too short or broken, the lamp will smoke (A, B, Fig. 51).

**104. Management of Kerosene Lamps.** When the lamp smokes, it is wasting fuel. Smoke is incompletely burnt fuel. The oil in the lamp should be clean. It should never be mixed with gasoline or other more explosive oils.

Fill the bowl each day the lamp is used to within one-half

inch of the top. A full bowl helps to make a safe lamp.

Put the chimney on the lamp so that it fits in its holder. Keep it clean and bright. Keep the wick clean and trimmed evenly. See that it entirely fills the opening thru the burner. This prevents the fire from burning back down the burner and igniting the oil in the bowl.

Oil will not pass up a wick which fits too tight. Do not cut a wick to trim it, but keep the charred part scraped or brushed off even with the top of the slit in the burner. A burnt match is useful for this purpose.

**105. Lighting a Kerosene Lamp.** When lighting a lamp, be sure it is in order and that any openings to the bowl are closed. Lift the chimney, turn the screw to raise the wick about one-eighth inch above the slit. Touch a lighted match to the wick, adjust the chimney, and, lastly, move the wick up or down until it burns clear and bright without smoking. After the burner becomes warm, the flame may grow higher and smoke. Do not leave a newly-lighted lamp unwatched.

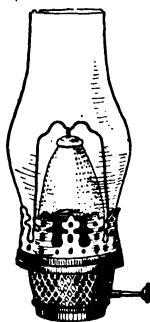

FIG. 52. Mantle for kerosene lamp.

After the burner becomes warm, the flame may grow higher and smoke. Do not leave a newly-lighted lamp unwatched. After the lamp is heated and adjusted, it should burn with a flame of even height.

**106. To Extinguish a Lamp.** Turn the wick down until it is slightly below the top of the slit. Do not turn too far. It will then go out of itself, or a slight puff of air will extinguish it. This is safer and will smoke the chimney less than attempting to blow out the full flame.

**107. Care of Lamps.** Keep the inside and outside of

bowl and chimney clean. Wipe all soot from the burners. Trim the wick each day the lamp is used. Fill the bowl with oil to within one-half inch of the top. Get new wicks when the old ones become dirty.

**108. Kerosene Mantle Lamps.** Kerosene mantle lamps (Fig. 52) give three to four times as much light per unit of oil as the ordinary kerosene lamp. Many mantle lamps on the market are unreliable. Care, therefore, should be taken to give the lamp a trial before investing so as to be sure to get a good one.

The care and lighting of mantle lamps differ so much that the directions must be furnished by the manufacturer and should be followed with exactness.

## CHAPTER XV

### ALCOHOL AND GASOLINE LAMPS

**109. Classification of Lamps.** Since the principle of operation is the same for most alcohol and gasoline lamps, they will be considered together.

These lamps may be divided into two classes—gravity lamps and pneumatic, or pressure, lamps.

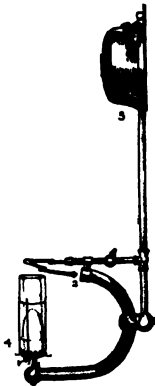

FIG. 53. Gasoline or alcohol lamp.

**110. Gravity Lamps.** Gravity lamps have the tank elevated above the burner so that the force of gravity brings the fluid to the burner. It is usually a little to one side of the burner so that it cannot become heated by it. A pipe from the tank leads downward and either over the chimney or under the burner, where it will be heated by the flame of the lamp. When heated, it changes the gasoline or the alcohol to gas. The pipe carries the gas on to a point where it is mixed with air before it

flows into the burner (Fig. 53).

**111. Lighting the Gravity Lamp.** In order to light these lamps, the generator must first be heated so as to make the gas. After this has once been done, the heat of the lamp keeps the generator hot. As soon as the gas is formed, light the lamp.

These lamps are furnished with mantles. The flame is blue and, consequently, gives out very little light, but much heat.

The mantle covering the flame is heated to glowing white heat and gives off much light of a white color.

**112. Pressure Lamps.** Pressure lamps (Figs. 54 and 55) have a strong tank which holds air and fuel, whether alcohol or gasoline. Air is pumped into the tank so that it presses on the fuel with force enough to push the fuel up the pipe

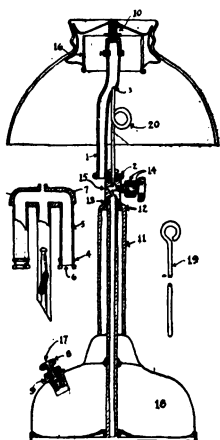

FIG. 54. Details of gasoline lamp.

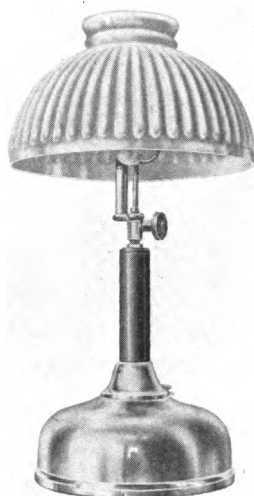

FIG. 55. Pneumatic gasoline lamp.

leading from the bottom of the tank to the generator. The air cannot get into the pipe so long as there is fuel which is heavier than air in the tank, because the pipe which leads to the burner starts from the bottom of the tank.

The generator for changing the liquid fuel to gas is placed between the burners of the lamp, of which there are usually two. After the generator has been heated, the lighted lamps keep the generator hot. The gas being very light, continues



to rise. It passes thru a place where it is mixed with air, and goes on into the burner, where it is ignited. If the lamp burns low, more air must be pumped into the tank to force up the gasoline or alcohol. When all the fluid has been burned, the lamp will go out, since, then, only the air which is under pressure in the tank will be coming into the burner.

Extinguish the lamp by turning off the supply of fuel to the generator. To light these lamps, first heat the generator, as directed for the particular lamp in use, and then light the burners. Detailed directions cannot be given here, as they differ with different lamps.

**113. Gasoline Lamps with Wicks.** There are some gasoline lamps made with wicks which help conduct the oil into the burner, where it is changed to gas by the heat from the lamp, mixed with air and burned in a mantle. The flame, from a mixture of alcohol or gasoline and air, is blue and gives off little light, but much heat. It is used with a mantle.

**114. Alcohol Lamps with Wicks.** The wick of one type of alcohol lamp conducts the alcohol up thru a round tube which it completely fills. The tube prevents the fire from burning down into the bowl of the lamp. Alcohol makes a very hot and almost smokeless flame, even when little air is present. The mantle is put over the flame, and, when heated, gives a good light. Other ordinary fuels cannot be used on so simple a lamp because they would smoke the mantle.

**115. Lighting Alcohol or Gasoline Lamps.** Heat the conducting pipe at the point where the fuel is to be changed to gas. (Directions for this come with each lamp, and they differ considerably.) After being heated sufficiently, the valve

leading to the burner is opened and the burner lighted with a match or torch. Use clean gasoline for these lamps, unmixed with water or other substances.

### QUESTIONS FOR PART III

1. Are there any differences in the electric light globes on the market? If so, in what ways do they differ? How do these differences affect the lighting power of the globes?
2. What influence has the size and decoration of the room on the brilliancy of light from a given lamp?
3. How should the light in a living-room be distributed?
4. What are the differences in direct, semi-direct and indirect lighting?
5. What is the purpose of a mantle for a gas or kerosene lamp?
6. What is the difference in burners to be used with and without mantles?
7. How is the light from a lamp measured?
8. Which lamp gives the greatest candle power of light for the amount of fuel used—the one with or the one without a mantle?

# PART IV

## COOLING DEVICES

### CHAPTER XVI

#### REFRIGERATORS

**116. Principles of Refrigeration.** Refrigerators (Fig. 56) are designed to prevent the rapid spoiling of food by keeping it too cool for the rapid growth of bacteria. They vary



FIG. 56. Refrigerator.

considerably in their efficiency, according to their construction and to the way in which they are managed. To preserve food and to save ice, the housewife must understand her refrigerator, and she must choose a good one. There is as much difference in the efficiency with which housewives manage their refrigerators as there are differences in refrigerators.

A series of experiments were conducted with a number of different makes of refrigerators. When the outside temperature was between 80 and 90 degrees Fahrenheit, and when the refrigerators were kept full of ice, it was found that the temperatures in different refrigerators varied between 45 and 60 degrees Fahrenheit. When the refrigerators were only partly full of ice, their temperatures rose several degrees.

The refrigerators which held a temperature of 45 degrees when filled with ice, or with 100 pounds, used 25 pounds of ice each in three days, while in the same three days, the ones which could maintain only a temperature as low as 65 degrees, used 50 pounds each. The warmer the inside of a refrigerator, the faster the ice melts.

In general, a refrigerator which maintains a low temperature is cheapest to operate. The refrigerator should be kept full of ice exposed so that it comes in contact with the air circulating within the refrigerator. The refrigerator which does not hold a low temperature will not only use more ice, but be less efficient in keeping food.

**117. The Construction of Refrigerators.** The construction of a refrigerator should be such that it may be kept clean. There should be no cracks and corners to catch dirt and make breeding places for molds and bacteria.

**118. Lining Refrigerators.** The best linings for refrigerators are porcelain, porcelain enamel, or glass for the more expensive ones, and galvanized iron or zinc for the less expensive ones. The shelves are usually made of heavy wire or of bent metal. The latter should be constructed so that they can be thoroly cleaned.

**119. Insulation of Refrigerators.** The more complete the insulation of a refrigerator, the more efficient it will be. Different kinds of material, as well as dead-air spaces, are

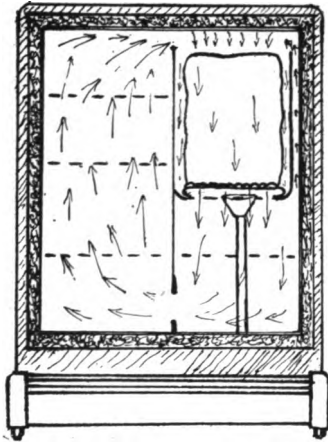

FIG. 57. Diagram showing circulation in a refrigerator.

used for this purpose. The top, as well as the bottom, must be insulated. Materials which are likely to crack or settle down and leave uninsulated spaces should not be used. Because sawdust settles, it is not satisfactory. There are felts, papers and other materials which are good. If the refrigerator is not water-tight and the insulating material absorbs water, it will lose its efficiency for insulation.

**120. Circulation in Refrigerators.** The better the circulation in a refrigerator, the more efficient it will be. The air in the refrigerator must be free to circulate over the ice. As it cools, it should drop to the bottom of the ice box. When it warms, it will rise and be displaced by fresh falling cold air. It should be free to rise to the top of the refrigerator and from there pass into the ice chamber and over the ice to be cooled again (Fig. 57). When the ice always melts unevenly and in the same relative place—that is, more on the side or bottom—it indicates poor circulation in the refrigerator.

**121. Drip from Melting Ice.** There should be a pan under the ice to catch the drip from the melting ice, and a drip pipe to carry it out of the refrigerator (Fig. 57). If the

drip pipe passes into a pan set under the refrigerator, the pan should be emptied so that it will not overflow. The water in the pan should not be allowed to become stagnant.

If this pipe passes to a drain, it should not be attached to the drain, but drip into it. The small amount of fresh air passing up the drip pipe from the room is advantageous. Because some air does flow thru here, the drip pipe and the drain pipe must be clean and free from gases and odors.

The drip pipe should be straight and free from places in which dirt may collect. It must be removable, so that it can be cleaned. The doors of the refrigerator must shut so tightly that frost or dew will not form about their edges on a hot day.

**122. Arrangement of Food in the Ice Box.** Ice boxes are usually cooler at the bottom than at the top. Do not put food in the ice chamber because this necessitates opening the door and wastes ice. Do not put papers or flat boxes on the shelves which will interfere with the circulation of air in the refrigerator.

**123. Filling and Care of the Ice Box.** The housewife must open the doors of the ice box as seldom as possible, and close them quickly. Do not cut off the circulation of air from the ice by wrapping it in a blanket or newspapers. It cannot do its work then. The ice box is kept cold by the gradual melting of the ice. The ice melts fastest as the temperature of the ice box rises. Covering the ice may keep it from melting, but it will also allow the refrigerator to get warm, and so, whatever is gained in saving ice at first, will be lost at the higher temperature and in cooling the box again. Steady melting does the most good.

The shelves and drain pipe should be removable; and these and the refrigerator should be washed and thoroly scalded once in every two weeks.

There is a saving in planning to open the refrigerator as little as possible. The filling of the ice box with a large piece of ice two or three times a week, rather than with a small piece every day, is more economical.

## CHAPTER XVII

### ICELESS REFRIGERATORS; WATER COOLERS

#### 124. Comparative Efficiency of Iceless Refrigerators.

In some localities, where it is difficult to get ice often enough to pay for having a refrigerator, other devices have to be depended upon for keeping food cool. Except when cold running water can be used in coolers, they do not take the place of refrigerators, because they cannot maintain the low temperature of a good refrigerator. As a rule, the best of the makeshifts are about on a par with the poorer refrigerators. They are very useful in emergencies.

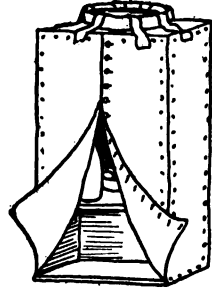

FIG. 58. Iceless refrigerator.

125. **Iceless Refrigerator.** One of these devices is called the iceless refrigerator (Fig. 58). It depends upon the evaporation of water to make it cool. Water will evaporate sufficiently fast to cool a refrigerator enough to be of value only in a dry, hot, breezy place. Under the most ideal condition, an iceless refrigerator may hold as low a temperature as 65 degrees Fahrenheit, when the thermometer is registering above 90 degrees.

This refrigerator consists of a cloth-covered frame and a device for keeping the cloth moistened with fresh water. Since wind or a good circulation of air helps in the evaporation of water, the iceless refrigerator must be placed where



breezes may reach it, and it should be anchored so that it will not blow away.

An iceless refrigerator may be made from a rectangular frame of wood, to which heavy canton flannel is buttoned or tacked. On the top of this should be placed a pan of water with strips of cloth extending from the water to the covering of the frame. This will conduct the water from the pan out onto the cloth. The number of strips of cloth regulate the

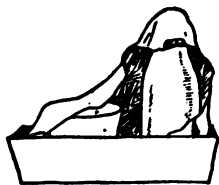

FIG. 59. Device for cooling food.

rapidity with which the water is carried to the sides of the refrigerator. The food is set inside (Fig. 58.) The refrigerator should be placed in a shady spot where the breezes can strike it. Iceless refrigerators must be kept clean, and the covering of cloth should be washed occasionally.

Some iceless refrigerators are enclosed in a chimney-like closet built on the house, the cold air coming in at the bottom and being drawn upward by the natural draft of the chimney-like structures. This draft hastens the evaporation of the water. Such refrigerators are expensive and less satisfactory than ice ones.

**126. Small Cooler.** A few things may be kept cool, like a bottle of milk and a small dish of butter, by setting them in a shallow pan of water and covering them with a flannel cloth which comes down into the water and so remains moist (Fig. 59). The evaporation of the water from the flannel cools the food somewhat below the temperature of the surrounding air.

**127. Covered Pail.** Another device is a metal pail (Fig.

60) covered with a heavy layer of cloth and a pan set on top of the cover. Into the pan is put some water and strips of cloth to conduct out the water. This may be hung in the kitchen window if it is shaded. The cover and the strips must be secured so that they will not blow off.

**128. Unglazed Earthenware.** Unglazed earthenware pitchers and jugs make excellent water coolers. The water is put in them, and, as the container is porous, a small amount filters thru the earthenware, and, as it reaches the surface and air, it evaporates, cooling the remaining water.

**129. Cooling with Running Water.** A very little stream of water from a faucet will cool the baby's milk and keep it from souring. The bottle should be set in a pan of water which is constantly renewed by the small stream running from the faucet. (Fig. 61.) This method of cooling should be used only in homes supplied with water from a spring or in an emergency. Under most circumstances, it is too extravagant a method of keeping food to be recommended. In cities it should be prohibited because it might cause too great a drain on the city water supply.

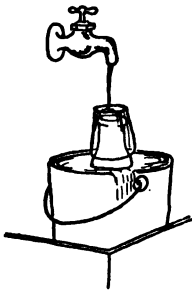

FIG. 61. Cooling with running water.

A larger device used for cooling milk is a tank of running water (Figs. 61-a-b). The water flowing thru this tank commonly flows into another tank used for the watering of

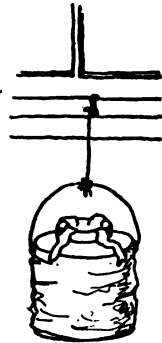

FIG. 60. Covered pail for cooling food.

stock. Cans with inverted covers like those illustrated are waterproof, because the air is caught inside them so that it cannot get out for the water to replace it. It does not require

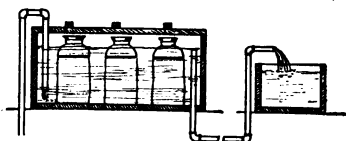

FIG. 61-a. Cross-section of cooling tank.

a large stream of water to renew that in the tank and keep it cool. The efficiency of this device depends entirely upon having a supply of cold water available.

**130. Refrigerating Plants.** Refrigerating plants are sometimes installed in private dwellings. These consist of a motor and a machine for compressing gas, a chamber which is to be cooled, and sometimes coils of pipe containing brine.

When the gas—for example, ammonia or carbon dioxide—is compressed, it heats the pump which compresses it. That is, when a liquid or gas is being compressed, it gives up heat. When a liquid or gas expands, it takes heat from somewhere. In refrigerating plants, the expanding gas is made to take the heat either directly from the refrigerator or storeroom, or from brine which is then used for cooling the refrigerator or room. Refrigerating plants require the same care as pumps, motors and refrigerators.

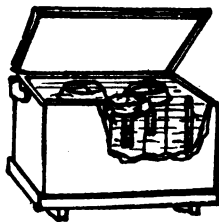

FIG. 61-b. Cooling tank.

**131. Water Coolers.** Since ice is not always pure, it is necessary to use cooling devices which do not permit it to come into direct contact with the water. One type of water cooler consists of a can set in an ice box with a pipe leading

to the outside so that the box does not have to be opened every time that water is wanted (Fig. 62). This can should be made so that it may be removed, washed and scalded.

Another cooler consists of a tank or water bottle placed on the outside of a refrigerator or box of ice with a pipe leading

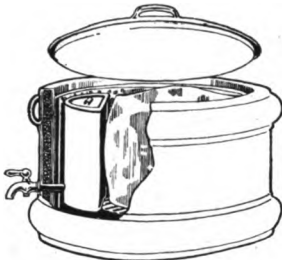

FIG. 62. Water cooler containing water tank.

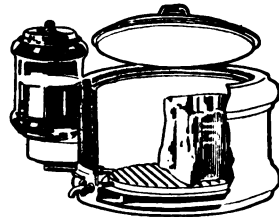

FIG. 63. Sectional view of water cooler.

thru the refrigerator or box of ice (Fig. 63). The water flowing thru the pipe is cooled. The pipe ends at the outside of the ice box with a faucet to let out the water. This cooler cools only the water flowing into the pipe instead of the entire tank of water.

**132. Care of Water Coolers.** Put only clean, pure water into the coolers, and keep them clean by flushing them out occasionally with boiling water.

## CHAPTER XVIII

### FANS AND VENTILATORS

**133. Selecting a Fan.** With the coming of electricity into the home, fans have become practical home devices. Do not buy a fan or other electrical device without ascertaining whether the current is direct or alternating, and what voltage is needed to run it. Most city homes are now supplied with current ranging between 105 and 115 volts, so most fans are

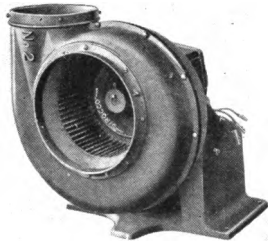

FIG. 64. Blower.

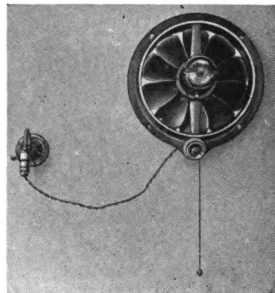

FIG. 65. Stationary fan.

made for that. Fans will run on a small wire like that used for lighting.

**134. The Construction of the Fan in Common Use.** A motor turns the fan. There is a regulator on some fans, so that they can be run at different rates of speed. Oil cups are important parts of fans. When a new fan is purchased, these cups are full of oil. The oil will last for many months, but if an old fan heats and sparks while being run, have an electrician examine it to see if all the parts are in order and there

is a supply of oil. Figs. 64, 65 and 66 show types of fans in common use.

**135. Ventilator.** A hood (Fig. 67) with a pipe leading into the chimney, placed over a cook stove, will conduct hot

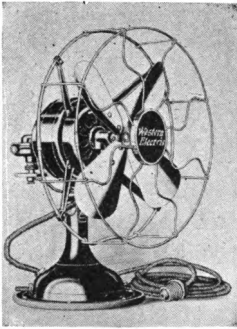

FIG. 66. Movable electric fan.

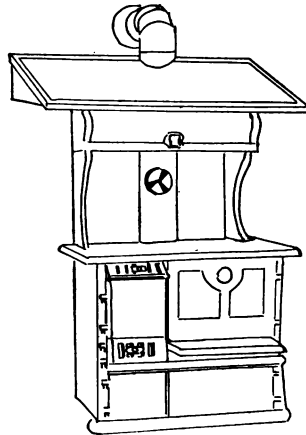

FIG. 67. Stove ventilator.

air and steam up the chimney. This is due to the fact that warm air rises and cold air comes in to take its place. An open skylight over a cook stove, also, makes an excellent ventilator and cooling device for kitchens.

#### QUESTIONS FOR PART IV

1. How may refrigerators be judged for efficiency?
2. What are the essentials of a good refrigerator?
3. How is an iceless refrigerator cooled? Under what conditions is it useful?
4. What may be the matter with an electric fan when it heats and sparks?

## PART V

### WATER SUPPLY AND SEWAGE DISPOSAL.

#### CHAPTER XIX

##### PUMPS AND WATER FILTERS

**136. Suction Pumps.** A pump is a device for lifting water. The pumps in common use work on the principle that water which is under the pressure of air will rise to fill a vacuum or a partial vacuum. The pump is composed of a combination of valves and a piston for forcing the air out of the pipe to allow the water from below to be forced into it. A valve catches the water as it starts to flow back. The weight of the water holds the valve closed.

An outlet above the piston permits the water to flow into a tank or sink when the piston is again lifted to make a new vacuum and draw more water (Fig. 68).

**137. Care of Pumps.** The leather or material forming the piston must be kept moist, or it will shrink and leak. When it becomes worn and old, it must be renewed. It is not a difficult task to put new packing on a small suction pump. To do this, remove the pin attaching the piston to the handle. Lift out the piston, unscrew the bolt which holds the leather packing in place; put on the new packing, and replace the bolt, piston and pin.

Always pump with a regular, even stroke—a jerky one tends to wear the working parts of the pump.

The cylinder and pipe containing water must not be allowed to freeze. There is usually a plug in the pipe which

may be removed to let out the water when there is danger of freezing. A cracked cylinder or pipe will leak air and not raise water.

Keep the bearings for the handle well oiled. When the pump gets old, the cylinder becomes worn and leaks. It can sometimes be replaced with a new cylinder, or more packing must be put on the piston.

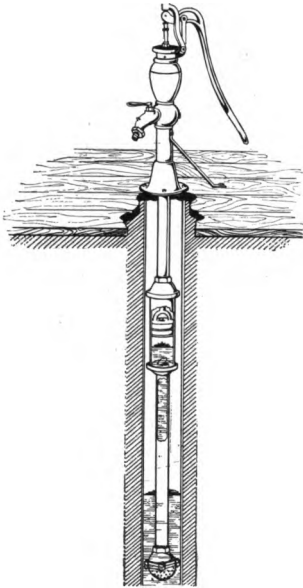

FIG. 68. Suction pump.

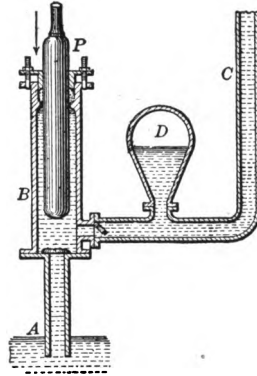

FIG. 69. Force pump.

**138. Force Pumps.** Force pumps are used on deep wells and in forcing water into storage tanks. They should be kept oiled; they should be operated with an even stroke, and the packing in them should be renewed if they leak air. In force pumps, the valves differ in their arrangement from suction pumps (Fig. 69).

**139. Compressed-Air Pumps.** Compressed-air pumps consist of a tank for storing the compressed air—a pump to force air into the tank and cylinders equipped with valves.



These act automatically. Whenever an outlet pipe is opened, the extra pressure of air from the storage tank raises the water from the well or cistern (Fig. 70). Air should be kept in the pressure tank.

When this arrangement is used, open and close faucets

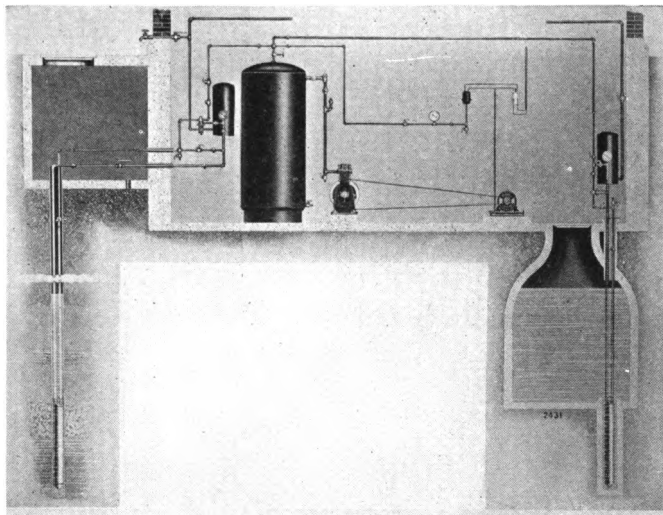

FIG. 70. Compressed-air pump system.

slowly, not with a jerk. Fig. 70-a shows plumbing where such a system is used.

**140. Water Filters.** Water filters are devices for straining minute particles out of water. They are made of sand, charcoal or porcelain, kieselguhr and other materials. They are without value unless they are kept clean. A dirty filter is worse than none. Almost the only way to clean them is to sterilize them or put new material in them. Only with expert care can filters be made effective for removing disease

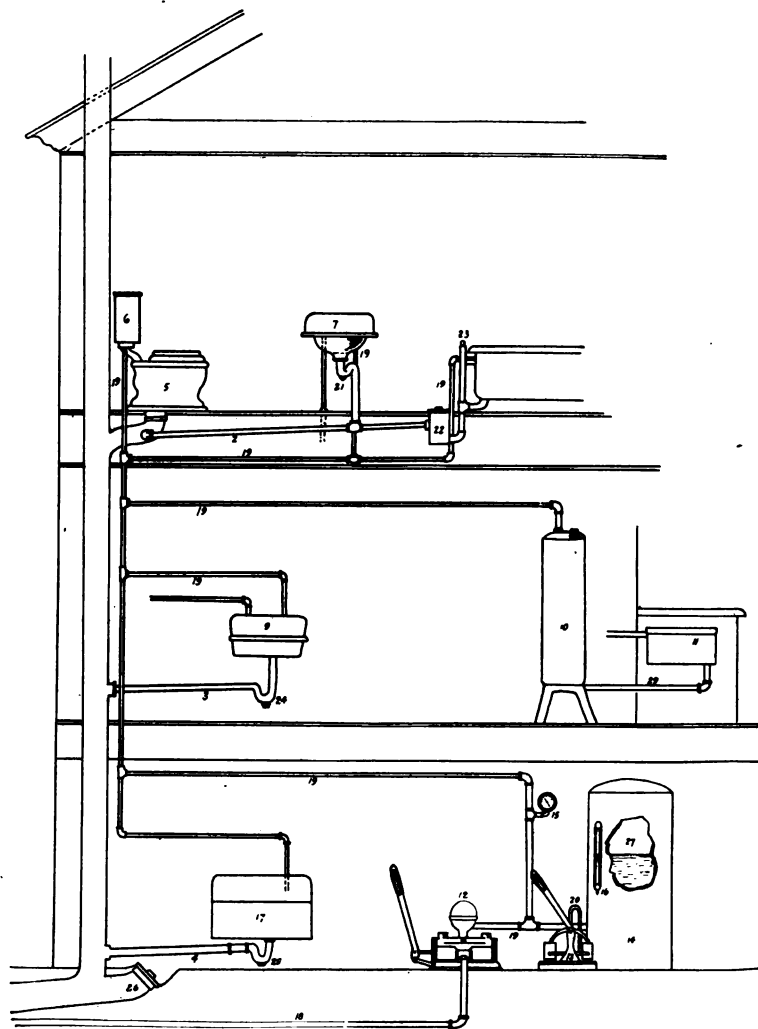

FIG. 70-a. System of plumbing with compressed-air tank.

germs. A dirty filter may prove a menace. Filters are valuable for removing coarse dirt from the water.

Filters on faucets should be cleaned or renewed every day. Large filters for rain water should be renewed every few months.

## CHAPTER XX

### PRESSURE TANKS; PLUMBING FIXTURES

**141. Pressure Tanks.** A pressure tank is a device for storing water under pressure. It is usually placed in the basement of dwelling houses.

**142. Construction of the Pressure Tank.** The tank is tight and strong, so that it will hold air and water under pressure. The tank originally has some air in it. When the water is pumped in, the air not being able to escape, is compressed. When there is a chance for water to escape from the tank which is connected to water pipes, the pressure of the compressed air on the water forces it to upstairs rooms and other points. To this tank is attached a pressure gage which indicates the amount of pressure; or, in other words, the amount of water in the tank, for when the water gets low, the pressure is reduced unless the air has escaped. A glass gage shows the height of water. Provision is made to let some air into the tank, for otherwise it may in time be all forced out of the tank or absorbed by the water. The water in a pressure tank may be used to pump water from a cistern into another tank.

**143. Care of Pressure Tanks.** A pressure tank must not be pumped up to the extent that the pressure becomes greater than the strength of the tank. A safety valve is used in controlling the pressure.

**144. Hot-Water Kitchen Tank.** A force pump is generally used for pumping water into kitchen tanks, except

when water from another tank, such as a city reservoir, flows into it.

**145. Instantaneous Water Heaters.** The instantaneous water heater (Fig. 71) is

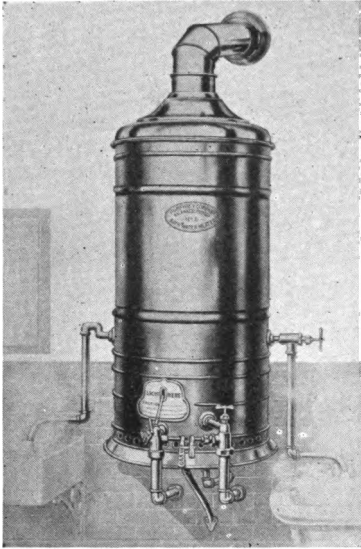

FIG. 71. Instantaneous water heater.

a device which heats water on its way to the outlet. It is composed of a heating unit and piping connected to the outlet pipes. In this type of heater, the pipes must always be kept full of water, and some device should be attached (Fig. 72) to the heater which will lower the heat as soon as, or

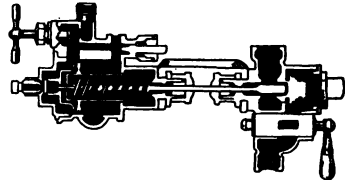

FIG. 72. Device for heating water automatically.

before, the water reaches boiling temperature. This will prevent steam from forming, which might injure the system.

**146. Heaters for Tanks.** Hot water is lighter than cold. A pipe from the bottom of the tank leads into the heater, passes thru the heating coils and up into the top of the tank (Figs. 73 and 74). Water from the tank circulates thru this pipe as the hot water rises and the cold water falls in the tank. As the heater is located on a level with the bottom of the tank, cold water seeking this level flows into the pipe and becomes heated (Fig. 76).

A booster is a device which keeps the water hot up to the faucet (Fig. 75). If there is a pilot on a gas water heater, be sure to use it. The burners should be cared for in the same way as on other heaters using the same fuel. Keep the tank full of water and the water free to circulate thru the pipes. Air-tight tanks may become so hot that steam is formed in large amounts. Tanks which are not connected with city water pipes may be fitted with safety valves which open when the pressure of steam inside the tank reaches a certain point, which is below the danger point.

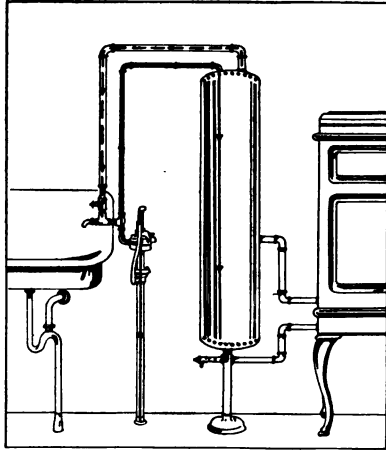

FIG. 73. Force pump and boiler.

Should the pipes or tank freeze, do not start the fire in the heater, but thaw the pipes with applications of hot water or other means until the water can circulate in them.

Electric heaters are usually incased in a waterproof covering and put in the center of the tank. Small electric heaters are in use for heating a glass or other small amount of water. These are called immersion heaters.

**147. The Elevated Water Tank.** In rural homes, water is sometimes stored in an elevated tank. This is usually placed in the attic. It is frequently filled by means of a force pump connected with a windmill or gasoline engine. If there is no overflow to this tank, which there should be, it must be

watched when being filled to prevent it from overflowing. It may be fitted with an automatic device similar to those used

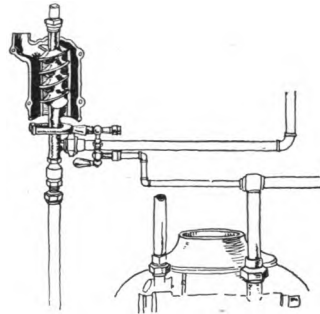
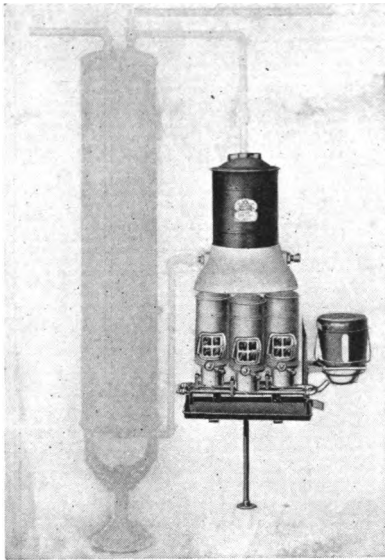

FIG. 74. Water heater and tank.      FIG. 75. Booster for hot water.

on the expansion tanks of hot-water furnaces or tanks to water closets for regulating the inflow of water.

· **148. Faucets.** Faucets are made in different patterns, but they need practically the same care (Fig. 77). The leather, or rubber, washer in a faucet must be renewed when it leaks. To renew the washer, unscrew the cap from the faucet. Remove the valve. Take off the ring of packing. Replace with a new ring, and put the faucet together again. The only tools needed for this repair work are a wrench and a screw-

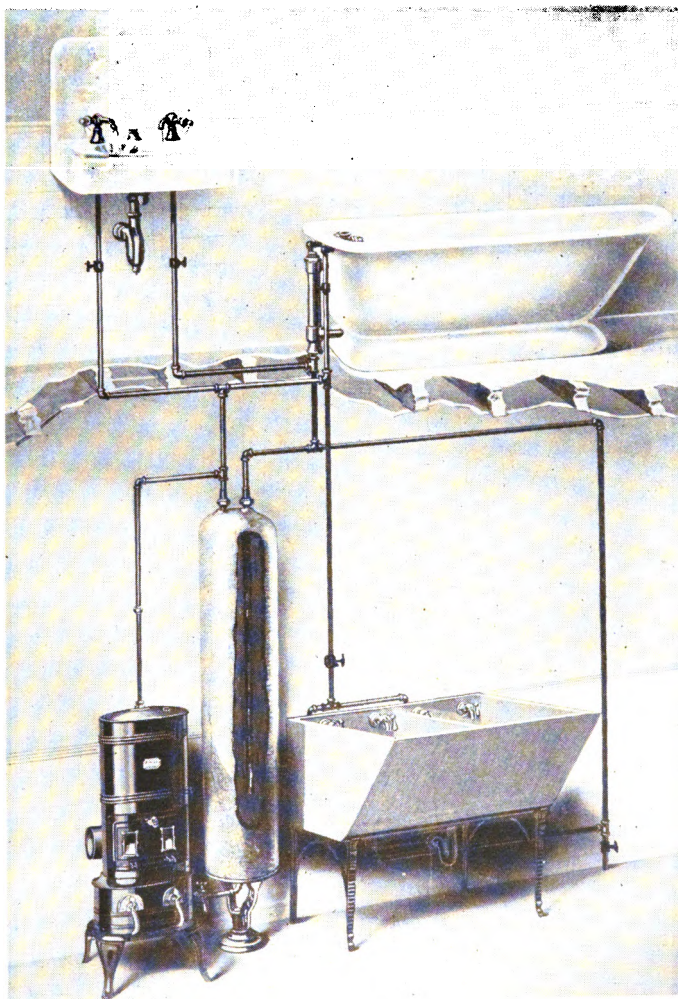
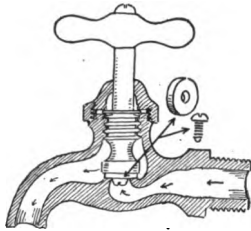

FIG. 76. Water tank and heater.



driver. Shut off the water from the pipe to the faucet before beginning to repair a leaking faucet.

**149. Valves.** Valves are constructed much like faucets.



**FIG. 77.** Faucet showing parts.

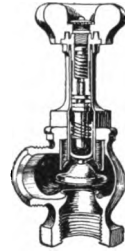

**FIG. 78.** Radiator valve.

They, too, sometimes need repacking. Follow the directions for repacking of faucet (Fig. 78).

**150. Overflows.** Keep overflows clean. When the plug

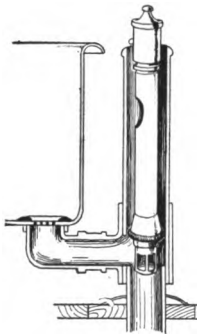

**FIG. 79.** Cross-section of overflow on bath-tub.



**FIG. 80.** Plumber's pump.

and overflow are combined, as they sometimes are, lift out the cylinder forming the plug and overflow and wash it. When it fails to hold water in the tub or basin, it may need

a new washer on the lower part. This may be replaced very easily. Fig. 79 shows one type of overflow.

It is more difficult to keep other overflows clean. They may be flushed or cleaned with a brush attached to a wire.

**151. Traps for Bath Tubs and Basins.** Dirt and slime collects in traps. Clean them frequently. Always leave clean water in the traps of bathroom fixtures and sinks. Only matter quickly soluble in water should pass into drain pipes. Keep matches, hair, sweepings, rags, fruit skins and stones out of the fixtures.

If the drain from a basin, sink or tub fails to carry away the water, the stoppage may be removed with a small plumber's pump (Fig. 80). This is a small rubber cone-like device which is placed over the outlet to the drain and moved up and down so that it sucks air, water and whatever may be movable up the pipe.

## CHAPTER XXI

### CESSPOOLS, SEPTIC TANKS AND CITY SEWER SYSTEMS

**152. Relative Value of Cesspool and Septic Tank.** Sewer pipes for private water systems usually drain into cesspools or septic tanks (Figs. 81, and 81-a). The waste goes thru a process of decomposition before passing out into the soil.

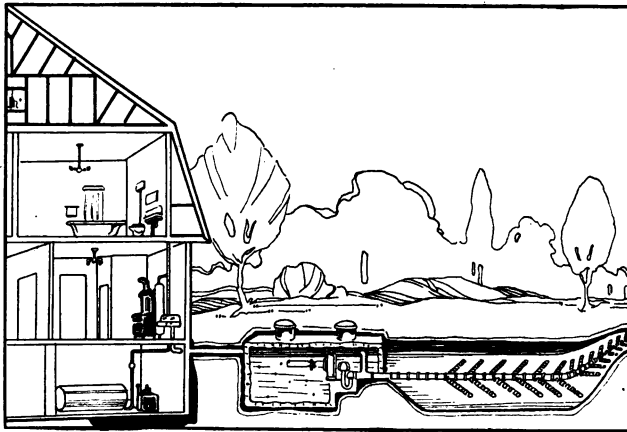

FIG. 81. Septic tank and tile.

Sewage should both liquify and oxidize before entering into the soil. Oxidation purifies liquid sewage so that it is not contaminating. If oxidation is not brought about in the cesspool or septic tank, sewage, which is fresh, should be run onto the surface of the ground where the air and bacteria for oxidation can be found. Cesspools are not as good as septic tanks because there is not the surety of sewage being oxidized in them, as there is in the septic tank. They lack oxidizing chambers.

Unoxidized liquid sewage being in a condition to flow readily thru the earth, is more dangerous than fresh sewage because it is more likely to seep into wells.

**153. Construction of the Septic Tank.** The septic tank is composed of two chambers—one the liquefying chamber and the other the oxidizing chamber. Both are water-tight (Fig. 82). The fresh sewage comes into the liquefying chamber thru a pipe placed near the top of the tank. Here it stands and liquefies, which is a process of decomposition. The solids fall to the bottom as they come into this chamber, and the liquid formed rises to the top and flows into the oxidizing chamber (B, Fig. 82), when it reaches a point a little below the height of the inlet pipe. It either does this by flowing over a partition or thru a pipe leading from one compartment to the other.

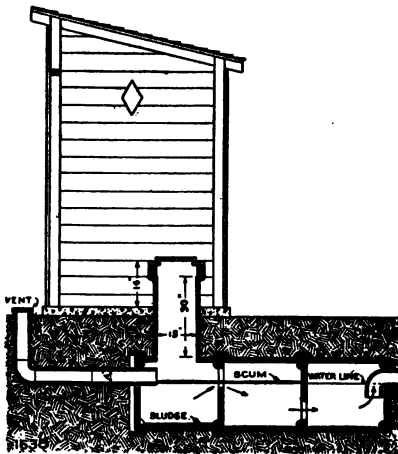

FIG. 81-a. Septic tank.

The second compartment is usually slightly smaller than the first. Here the sewage is held until the process of oxidation takes place, which renders it less dangerous. When the sewage in the second chamber reaches a certain height, it siphons out into a tile which distributes it over a plot of ground (Fig. 81).

Various kinds of siphons are used, the important feature of

them being that they are constructed so that they drain the tank often enough to remove the oxidized sewage and not so often as to remove it before it has become oxidized.

**154. The Size of Tank.** Because the liquid must be drained from the tank at certain intervals, it is important that

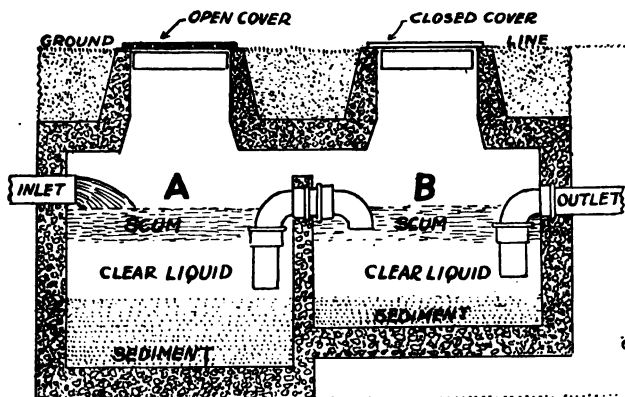

FIG. 82. Details of septic tank.

the size of the tank be adapted to the amount of waste it will receive.

Septic tanks are kept warm by the heat generated in the oxidizing process, which is simply slow burning of the waste, so that they rarely freeze in winter.

Run waste water from the kitchen sink and laundry tubs into a catch basin to collect the grease from the water, as grease or oil on the surface of the sewage of a tank will stop the action of the microbes in the tank by smothering them.

When too much grease does get into it, the tank must be thoroly cleaned.

Do not use lye, chloride of lime, carbolic acid and other chemicals in drains and septic tanks. Disinfectants of this

type put into pipes leading to a septic tank will kill the useful bacteria which decompose the sewage.

Use clear boiling water to clean the pipes. This will be cooled by the time it reaches the tank so that it will not kill the useful bacteria.

Insoluble mineral matter gradually accumulates in septic tanks, so that they must be cleaned once every few years. Care will postpone the times for cleaning.

Do not wash vegetables with much earth adhering to them in sinks leading to cesspools or septic tanks. Shake or rinse off the dirt before washing them.

**155. Disposal of Waste in Cities.** In some cities, householders are required by law to have catch basins connected to their sewer systems to remove leaves and dirt from storm water and grease from kitchen sinks and laundry tubs. The laws of other cities forbid the use of catch basins, but urge householders to help care for the city sewer system by not putting grease into sewer pipes.

Strong chemicals should not be put into the pipes. Use only boiling water in cleaning pipes. Do not wash vegetables on which there is much loose dirt in sinks.

## CHAPTER XXII

### WATER CLOSETS

**156. Construction of Water Closets.** The water closet is a device for the disposal of excrement. The closet includes a tank of water for flushing the waste from the bowl to the sewer or waste pipe. Between the bowl and the waste pipe is a device called a trap which holds water and seals the end of the waste pipe so that gases from the sewer or the septic tank cannot come into the house. (Fig. 83-*a*.)

The bowl of the newer models of water closets have the trap as a part of the bowl, which saves joints and connections likely to catch dirt and stop up the trap (Fig. 83). The water coming from the flushing tank is carried around the bowl so that it is flushed clean by the swift-flowing water. When the water reaches the bottom of the bowl, it rushes upward a few inches before it can turn downward to the waste pipe. This it does while flowing rapidly and cleansing the bowl; when the tank empties, water collects in the bowl to the level, where it can flow down the waste pipe (Fig. 83). As soon as all the water above this level has gone down the pipe, the remainder stays in the bowl, forming the seal until the next time the bowl is flushed. Fig. 83-*a* shows two kinds of traps.

If water flows at too rapid a rate thru the trap of the bowl, as in cases when there is too much pressure on the water or the tank is set too high so that gravity gives it too much force, or if an excessive suction is produced in the drain pipe, all the water may run out of the bowl, leaving the trap unsealed.

The remedy for this is a change in the flushing tank or in its position.

**157. Siphoning the Trap.** If rags or shreds of material are dropped into the bowl and lodge in the trap, only a part of them going over into the waste pipe, they may siphon the water, sealing the trap, over into the waste pipe. There was more difficulty of this sort with traps of older models than with the newer types. Always leave clean water in the trap.

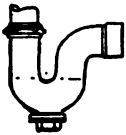

**158. The Flushing Tank.**

The flushing tank (Fig. 84) is a reservoir to hold sufficient

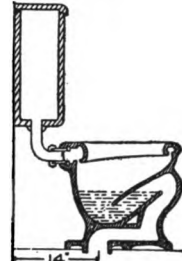

FIG. 83. Section of water closet.

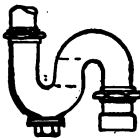

FIG. 83-a. Types of traps.

water to cleanse the bowl. In one type of tank, water is retained in the tank by a plug held in place by the weight of the water in the tank. By a lever on the outside of the tank, this plug is lifted when the bowl is to be flushed, and it stays open until all the water flows out of the tank. When the water has all left the tank, the plug falls back into the hole and fresh water flowing into the tank holds it in place, as there is nothing in the pipe below to make it float upward.

Working at the same time with the plug is a valve in the water supply pipe, attached to a large hollow float. The valve opens as the water flows out of the tank, and closes as the tank is filled. This valve is operated by the float floating on the surface of the water. As the water flows out of the tank, the float falls, opening the valve and letting in water. As the tank fills, the float rises to the top of the tank and



shuts off the valve. If the float catches so that it fails to rise and fall, or becomes disconnected from the valve, it will not operate the valve. There is an overflow pipe in the tank which carries off all water rising above a certain level in the tank. This prevents the tank from overflowing when the valve fails to turn.

**159. Repairing the Flushing Tank.** When the water continues to flow into the tank, take off the cover of the tank and examine the valve and ball to see why they are not working properly. If disconnected or caught, remedy the trouble. If the plug fails to stop the flow of water out of the tank, water will

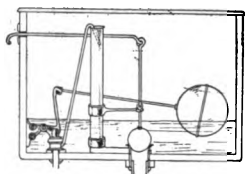

FIG. 84. Diagram of also continue to flow into the tank. To  
flushing tank. remedy this temporarily, push the plug

down over the outlet and also note the reason why it has not fallen back automatically. If worn, it may have to be replaced with a new one.

There should be a valve to close the pipe to the tank. With this valve, much water can be saved in time of trouble, and greater convenience may be had in remedying difficulties with the devices inside the tank.

#### QUESTIONS FOR PART V

1. How does a pump lift water from a well?
2. How do pumps differ in construction?
3. What care should be given a pump?
4. When is a water filter useful? When dangerous?
5. What is a pressure tank? How does it operate?
6. Describe two kinds of water heaters. What precautions should be taken with each kind of heater?

7. Describe a water faucet. Try to replace an old washer with a new one.
8. Have you ever cleaned the overflow to a tub or basin? Should they be cleaned?
9. What are traps? What may cause them to fail to work?
10. How would you select a good trap? How would you clean it?
11. Describe the construction of a septic tank. What is the action that takes place in a septic tank? What care should be given to it?
12. Examine the tank to a water closet. How does it operate?

# PART VI

## LAUNDRY EQUIPMENT.

### CHAPTER XXIII

#### WASHING MACHINES

**160. Kinds of Washing Machines.** Washing machines are tools to help remove dirt from clothes either by friction or by forcing water thru them. They are known by such names as suction, cylinder, rotary, oscillating, locomotive and cen-



FIG. 85. Washer to place in boiler.

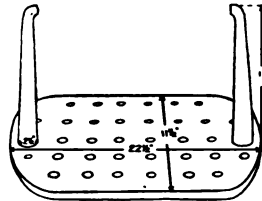

FIG. 86. Another type of washer for boiler.

trifugal machines. These names are used differently by various authorities.

Washing machines may be attached to any kind of motor, or they may be manipulated by hand.

**161. Suction Machines.** The suction machines are made to force water thru the clothes (Figs. 85 and 86). Some are operated by hand, some by mechanical power, and some are funnel-shaped devices to be placed in boilers.

Hand or mechanical suction machines have cones or funnels which are pushed down onto the clothes and then suddenly lifted, causing suction which draws out the dirt pre-

viously loosened by the moisture and pressure. Mechanical devices attached to the top are sometimes used to raise and lower the funnels (Figs. 87 and 87-a).

The suction washers for use in boilers are placed funnel side down. By means of these, the steam forming in the bottom of the boiler forces the water thru the clothes. Distribute the clothes evenly about the washer. Fill the boiler with water and add shaved soap. When set over a fire, the steam forming at the bottom raises the water in the funnel to the top and

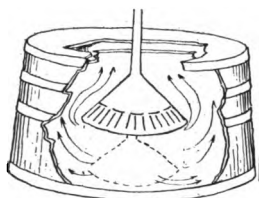

FIG. 87. Suction washer.

pushes it out thru the clothes, or raises the funnel and makes it beat upon the clothes.

Other machines combine the two methods of washing—forcing water thru clothes and rubbing them at the same time.

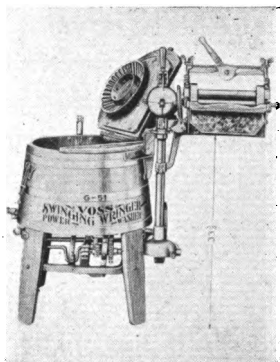

FIG. 87-a. Washing machine.

**162. Cylinder Washers.** Cylinder washers contain a perforated barrel-like device, into which the clothes are placed (Fig. 88).

This cylinder has cleats on the inside to raise the clothes as the cylinder turns and drop them when they reach the highest point in it, back into the water, thus pounding water thru them and rubbing them against the side of the cylinder as they are raised. This is the type used in most laundries. A cylinder turned by an electric motor is made which can be placed in the stationary wash

tub in small apartments. The tub then serves as the outer part of the washing machine.

**163. Rotary Washers.** In the rotary, or milk-stool, type of washer, sometimes called "Dolly" (Fig. 89), the stool-like contrivance which presses against the clothes must be turned half-way around in one direction, and then back the other way, to prevent twisting, tearing or otherwise injuring the clothes. The clothes are thus rubbed against the corrugated sides and bottom of the machine, and through the water. Never put too many clothes in this type of machine because too tight



FIG. 88. Cylinder washer.

packing causes the machine to tear them.

**164. Machine with an Oscillating Washing Device.** This washer contains an oscillating device for rubbing the clothes over the corrugated bottom. The rubbing device is also corrugated and is put on top of the clothes and moved backward and forward, thus rubbing them between two wash-boards (Fig. 90).

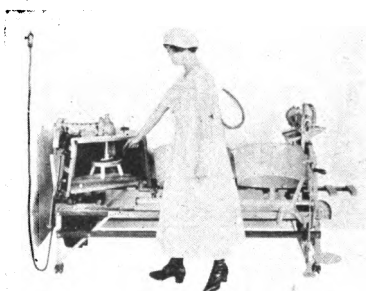

FIG. 89. Rotary washer.

**165. Oscillating Washers.** Oscillating washers have corrugated bottoms. The clothes are put into the machine with the wash water. The washer rocks, throwing the clothes backward and forward thru the water, loosening and squeezing out the dirt. This washer works easiest when the machine is well filled with water.

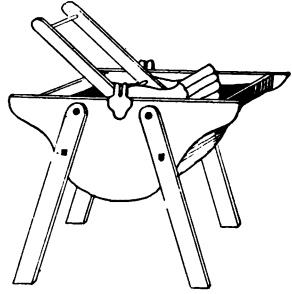

FIG. 90. Oscillating washing machine.

**166. Locomotive Washer.** The locomotive washer (Fig. 91) slides backward and forward, thus churning the water and clothes. It is operated only by power.

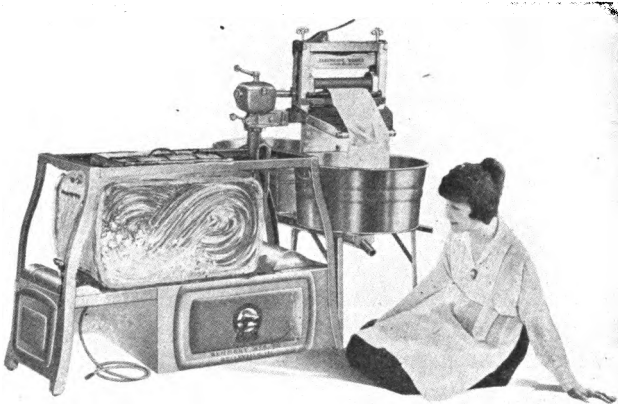

FIG. 91. Locomotive washing machine.

A heating unit, usually gas, in the base of the machine keeps the water hot.

**167. Centrifugal Washer.** A centrifugal washer (Fig.

91-a) contains a perforated basket which whirls in the water contained in the machine. The clothes are placed in the basket, rolled into bundles. The rapid whirling thru the water removes the dirt from the clothes.

**168. Care of Washers.** The bearings and other motor parts of a washing machine should be kept oiled. Keep belts

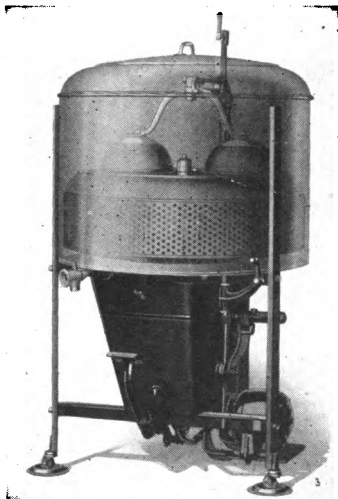

**FIG. 91-a.** Centrifugal washing machine.

tight. Run the machine about ten minutes each while the clothes are in the first wash water and the two sudsy waters, and five minutes each for the hot and the cold rinse waters. Blueing had better be done in a tub.

Wooden machines must dry out occasionally, or else they get slimy. Do not let them get dry enough to crack. Air the machines after use. Cover them when not in use to keep them clean.

When a gasoline engine is used in operating a washing machine, it must be set so that the belt will pull straight on the pulley wheel of the machine. The belt should be tight enough to prevent slipping. Stationary washers are set to avoid such troubles, but those which are moved from place to place must be adjusted by the operator.

The pulleys must be adjusted to turn at the number of revolutions per minute directed for the washer used. This usually does not exceed 150 revolutions of the motor wheel per minute.

Water motors must receive more than 25 pounds of water pressure to operate a washing machine.



## CHAPTER XXIV

### WRINGERS

**169. Roller Wringer.** The kind of wringer in most general use is the one made of two rollers rotating in opposite directions, the clothes being drawn in between the two by friction, and the water pressed out. (See Fig. 88.)

The rollers in modern wringers are made of a composition of rubber. They are adjusted so that they may be brought close together or moved apart. When wringing thin articles, the rollers should be set close together, and when wringing heavy articles, they should be set far apart. This adjustment of the wringer helps to do better work and save wear and tear on clothing and wringer.

**170. Care of Wringers.** The bearings should be kept oiled, but oil must be kept off the rollers, as it rots them. Keep the rollers washed clean. Soap and water will remove the dirt which collects on them. If this does not clean them, wipe the rollers in a weak solution of ammonia.

If the rollers get badly stained, wipe them with a cloth dipped in kerosene. Wash this off immediately, as kerosene dissolves the rubber as well as the dirt.

Never leave a wringer with the pressure on the rollers when not in use. The pressure is either adjusted by thumb-screws or by a clamp. Loosen these when thru with the wringer.

**171. Centrifugal Wringer, or Dryer.** The centrifugal wringer, or dryer, consists of a tub, inside of which is a smaller tub with perforated sides. There is a drain at the bottom of the outside tub. The wringer is attached to a device for

making the inside tub turn rapidly. The power used is either hand or machine (Fig. 92).

The rapid turning of the inner tub for three minutes throws the clothing and water in them to the outside of the revolving center. This tub being perforated, lets the water thru while retaining the clothing. Thus, the clothes are wrung as dry as

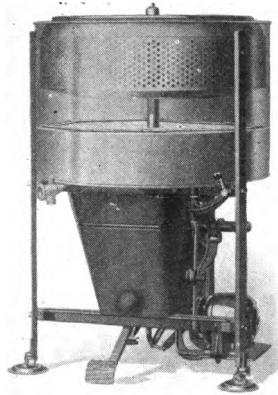

FIG. 92. Washer and dryer.

in a wringer of the roller type. If the machine is turned a longer time, the clothes can be wrung entirely dry.

**172. Care of the Machine.** When loading centrifugal wringers, put the heavy pieces at the bottom of the basket. Put articles in basket in bunches, and pack fairly tight. Do not have loose ends hanging out. Fold sleeves into garments. Load the basket full if there are clothes enough. A cover helps to hold the clothes in place. Load so that it runs even and does not wobble.

Never hold your hand on the extractor after it has started.

**173. Combination Washer and Wringer.** The centrifugal washer and wringer combined is built so that the basket can be lowered into a tub of water. The clothes rotating in water are washed. After this is accomplished, the cylinder is raised, and, when rotated, serves as a wringer of the centrifugal type.

Load the washer with fewer clothes than for wringing. Roll each garment into a bunch before putting it into the washer.

Centrifugal wringers are used also as dry-cleaning machines. For this use, they should be operated out of doors and at a slower speed than when water is used. Friction heats gasoline, causing it to evaporate rapidly. The friction between clothing, tub and gasoline when turned at a high speed may produce a spark which will ignite the gasoline.

## CHAPTER XXV

### MANGLES AND IRONS

**174. Construction of Mangles.** Mangles are made of rollers rotating in the same direction, one moving faster than the other, set close together so that they press the clothes smooth, or they consist of one roller rotating over a stationary surface called a shoe (Fig. 93).

**175. Cold Mangles.** When no heater is attached to the shoe or one roller, the mangle is a cold mangle. It smooths clothes, but does not do as good work as a heated mangle. There is almost nothing about mangles to get out of order. The only caution necessary is to keep the bearings oiled, have guards so as not to catch hands in the power machines, and loosen the roller so that it is not pressed onto any surface when not in use.

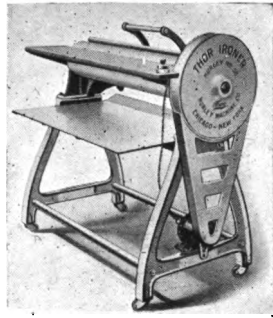

FIG. 93. Mangle.

**176. Heated Mangles.** The heated mangles have the heat applied to one of the rollers or to the shoe. They may be used cold. The heat may come from gasoline, gas, electricity or kerosene. The management of the heating unit is the same as for a stove using any of these fuels. The same care should be taken of the burners as of stove burners.

**177. Care and Use of Mangles.** (1) Have the clothes damp before putting them thru the mangle. (2) Protect the mangle from dust at all times. (3) See that belts are properly

adjusted on mangles. (4) The covering put on mangle rollers must be of even thickness, or they will not do good work. (5) Do not mangle starched garments, or those on which are many or large buttons. (6) Wax the steel roller while it is warm, and wipe it clean with a cloth (Fig. 94). (7) Always remove pressure when not using mangles.

**178. Flat, or Sadirons.** Irons are of two kinds—those which must be heated on a stove, and the self-heating ones.



FIG. 94. Waxing roller of mangle.

The weight of the iron governs the amount of heat it will absorb, and this is the amount that it will give up in ironing. Heat is needed to dry clothes, and as the cloth can be smoothed best when damp, but will wrinkle again unless dried while smooth, heat is essential to the ironing process.

The weight of the iron helps in the smoothing process. The heavy irons do the best grade of work, but are harder to manipulate. The most satisfactory iron for a woman of average strength to manage weighs six to eight pounds.

The following points should be remembered in using the iron: (1) Rub rusty irons with bees'-wax or paraffine and wipe with a cloth. (2) Wash irons frequently, and rub with sand soap, Dutch cleanser, ashes or salt to polish them. (3) Rinse in boiling water and wipe dry. Warm on the stove and rub with bees'-wax, and set away. (4) Before using, wipe with a cloth. (5) Do not wash electric irons—rub with wax

or paraffine. Wipe off with a clean cloth. (6) It has been found by tests that the time required in heating the self-heating iron usually equals the time required for the iron to cool after the heating has been stopped, but that an iron cools faster on wet, heavy cloth than on thin, dry cloth.

**179. Charcoal Irons.** Charcoal is no longer used for heating irons. It makes too much dirt. Difficulty is found, also, in keeping charcoal irons at a constant temperature.

**180. Electric Irons.** An electric iron (Fig. 95) is made up of a heavy nickel-plated base, a block of iron which holds the heat, and a heating unit of small wires, or a plate, thru which the current passes, meeting resistance. Since resistance

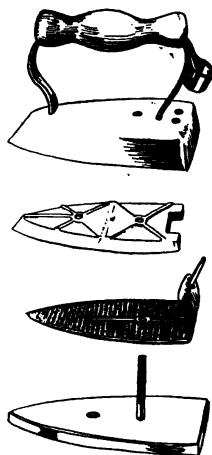

FIG. 95. Parts of electric iron.

against the flow of an electric current produces heat, the iron is heated. It has a handle and shell covering the heating unit to protect the hand and prevent loss of heat thru the top.

Getting electric irons too hot injures the heating unit, as electricity can heat metals so hot that they melt. Excessive heat may disconnect the circuit by burning the wires in the iron, or it may melt the metal so as to form a short circuit.

Always follow exactly the directions for connecting and disconnecting the iron with the current. Some say disconnect at the plug between iron and cord, or others the plug placed near the socket (Fig. 95-a). The weakest part in irons is likely to be in the attachment plug. When connecting the plug to the iron, be sure to get it back in place each time. A

- ✓ plug that does not fit well into place may cause sparking and develop sufficient heat to burn off the insulation from the cord, if not the fuses of the system to which the iron is attached.

Never attach an iron to a lighting system without making sure that the iron is made to be operated on the voltage of the current to which it is connected. If it is not the same, attaching the iron may either burn out the fuses of the lighting system, or ruin the iron.

Operate the iron at a good temperature for ironing, and take care to keep it from getting hotter than is required.

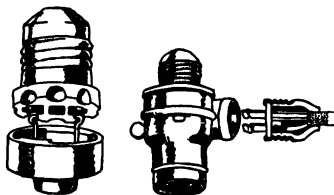

FIG. 95-a. Connecting plug for electric attachment.

**181. Gas Irons.** Gas irons are attached to a tube leading from a gas pipe. There is a burner inside the iron which is generally a straight rod with perforations in it for the escape

of the mixture of gas and air. The air mixes with the gas at a point near where the gas pipe enters the iron. The principle of heating an iron is the same as the heating of a gas stove (Fig. 96).

The burner in the iron is lighted, and as soon as it has heated the iron, the ironing can proceed. The only difficulties encountered in using this kind of an iron are that a quick, jerky stroke may blow out the flame, and if the work is being done in a drafty place, the iron may not heat evenly. These difficulties can be overcome, however. The person using the iron can learn to use a stroke which will be rapid and still not put out the flame. The ironing board may be pro-

tected from drafts. A gas iron is safe and practical. It is easily controlled by the valve admitting the gas.

**182. Acetylene Irons.** Acetylene irons are similar to gas irons, the difference in them being in the construction of the burner.

**183. Alcohol Irons.** Alcohol irons have a tank attached to them which holds about a half pint of alcohol. This iron is similar to the gasoline iron shown in Fig. 97. Some alcohol is turned into the iron, and then the valve is closed. This alcohol is lighted with a match and used to heat the generator

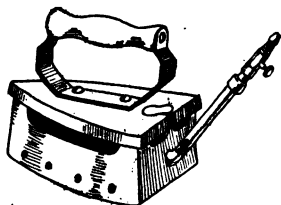

FIG. 96. Gas iron.

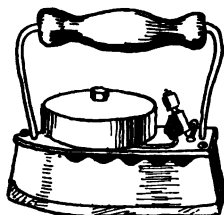

FIG. 97. Alcohol iron.

in the iron so that it will be hot enough to change the alcohol into vapor. As soon as this is done, the alcohol is again turned on and lighted. The burners in these irons should be kept free from dirt. Like gas irons, they should be used with a stroke which will not put out the fire. They cannot be operated in a strong draft. The heat in them can be regulated by the valve which controls the flow of alcohol.

**184. Gasoline Irons.** There are two kinds of gasoline irons. In one the tank is a part of the iron (Fig. 97), and in the other the tank is many feet away, where the gasoline is changed to gas by a cold-process gasoline gas machine and connected with the iron by a flexible tube. These latter operate like other gas irons.



Gasoline irons with the tank attached are operated the same as alcohol irons. The danger in these irons comes in the tanks becoming overheated. Alcohol is used first to heat the generator because it will not smoke the iron. The gasoline, when lighted, should burn with a blue flame.

The tank should be one which has been tested to stand a high gas pressure, as the gasoline in the tank may become heated and vaporize. The gas so formed must not escape into the room, where it might be ignited by a spark. If not allowed to escape, it exerts considerable pressure inside the tank. If the pressure becomes too great, it will break the tank, escape and ignite from the flame in the iron. The opening for filling must always be kept closed when the iron is in use.

#### QUESTIONS FOR PART VI

1. Explain the construction of various types of washing machines. What are the advantages of each?
2. What care should a roller wringer receive?
3. How does a centrifugal wringer dry clothes?
4. How does a mangle differ from a wringer?
5. What is the difference in care that should be given to a plain flat iron and an electric iron?

# PART VII

## HOUSE-CLEANING EQUIPMENT

### CHAPTER XXVI

#### VACUUM CLEANERS AND CLEANING TOOLS

##### 185. Principle Upon Which Vacuum Cleaner Works.

The principle of a vacuum cleaner is that, thru suction, dust and dirt are drawn from the floor or other surfaces into some container. If the power of the cleaner is sufficient, it may

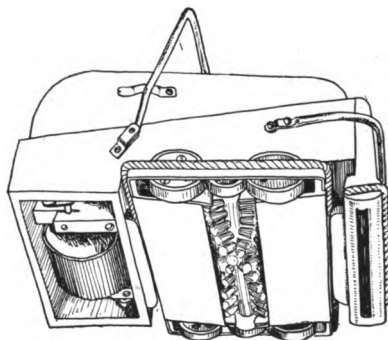

FIG. 98. Brush and vacuum cleaner combined.

pick up anything—but cleaners having a moderate amount of power are somewhat more discriminating. They do, however, remove the fine, greasy dirt that brooms, brushes and carpet sweepers fail to get. The coarser dirt and ravelings may be taken up by a carpet sweeper, with a brush, or picked up by hand. The brush is combined with the cleaner in many machines (Fig. 98).

**186. Different Kinds of Vacuum Cleaners.** There are cleaners with bellows, pumps or fans to draw in air and dirt. The ones with bellows in them work on the principle of a bellows which is reversed so that when the air is drawn in, it brings the dirt with it. The other kind works with a fan which draws or sucks air from the floor thru a nozzle into the machine. In the machine, the dust is filtered out of the air and collected in a pan.

The machines with fans in them are mostly power machines, as the fan must revolve very rapidly. The hand machines are mostly of the pump and bellows types. Some are combined with the carpet sweeper, making two machines in one. With this device once going over the floor is sufficient for removing both coarse and fine dirt. The hand machines do not have as much power of suction as the power machines, but they do very satisfactory work. They are more effective than a carpet sweeper in removing dirt, but they do not get as much of it as the stationary cleaner. Removing the sharp grit from rugs and carpets lengthens the life of them so that the more grit a cleaner can remove without tearing the carpet, the more valuable it is.

When the pump type is being used, the piston is drawn up, drawing with it air and the dirt which is present at the point from which the air comes. A cloth filters out the dust. The air escapes from the machine before the piston is lowered to draw in more air and dirt. If this were not true, the dust would be forced back as the piston was lowered.

**187. Nozzle of Vacuum Cleaner.** The nozzle, or point of entry of air into the machine, is an important part of a vacuum cleaner. This is constructed so that it fits the sur-

face from which the dirt is to be drawn, insuring the drawing up of dust as well as air.

The dirt is drawn from only a few square inches of surface at one time. The thoroughness and rapidity with which the dirt is removed depends upon the strength of the suction or the power of the machine. Thus, hand machines may have to be moved over a surface several times if it is very dirty in order to get all the dirt.

Plain solid nozzles work best on carpets and other surfaces of similar kind. They are not effective on hard floors, but this is not essential, as dirt can easily be removed from smooth surfaces with a brush.

**188. Cautions in Using Vacuum Cleaners.** The difficulties to be met with in vacuum cleaners are leaks. First of all, the machine must be fitted together perfectly; if not, the dust drawn into the machine escapes into the air of the room instead of into the collection pan or chamber.

Machines are made air-tight, but to be cleaned, they must be taken apart. In putting them together, the housekeeper must take pains to fit them together perfectly.

Never neglect to empty the dust chamber. Keep the machine properly oiled. A punctured bellows or a leaky dust strainer will cause dust to escape after being drawn into the machine. These have to be remedied with new parts. Some machines leak because of improper manipulation, such as a too-fast or too-jerky motion in operating them. The directions for each machine tell how to use it—such directions cannot be given here because they differ so much.

When the pan has become over-full of dirt, the machine will necessarily throw out dust as well as air. Letting the machine

get over-full of dust may ruin the machine by making some part leak continuously.

### 189. Difference Between Hand and Power Cleaners.

Power machines differ from hand ones in that they are run by motor power (Figs. 99 and 99-a). They may have larger

collecting chambers and may be stationary in the cellar and connected to the rooms by long pipes (Fig. 100). They must likewise not be over-full of dust. They must be kept properly adjusted. As the operation of the mechanism shakes the machine, it may loosen screws and nuts, so they must be kept tightened. The motor must also be kept in order. The motors used for vacuum cleaners are the same as those used on other power devices. They may



FIG. 99. Electric vacuum cleaner.

be small electric motors, forming a part of the machine, or large motors which operate several machines.

In any case, they must be given the same care as any other motor of the same type. (See Chapter XXXVIII.) If they become overheated, they will not work well. They must be kept lubricated to avoid friction, and they must be kept properly adjusted. Fig. 100-a shows a number of different attachments for vacuum cleaners.

**190. Carpet Sweeper.** A carpet sweeper is a combination of brush and dust pan. The advantage of this device is

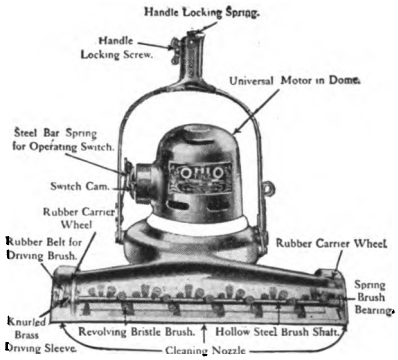
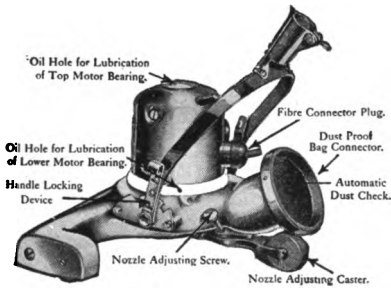
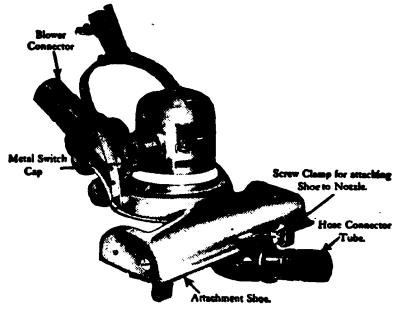
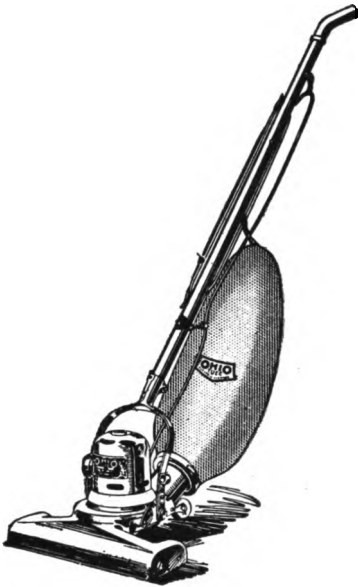

FIG. 99-a. Electric vacuum cleaner, showing parts.

that the dust is gathered into the machine as the brush rotates, due to the action of the wheels on which the machine moves. The dust is collected into pans at each side of the brush; these are covered so that the dust does not fly into the air as much as otherwise would be the case (Fig. 101).

Oil the sweeper regularly about once a month by putting

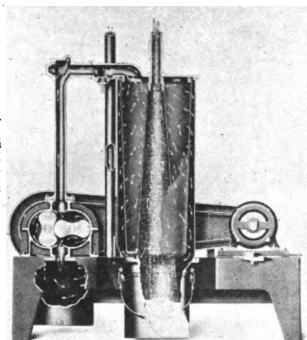

FIG. 100. Stationary vacuum cleaner.

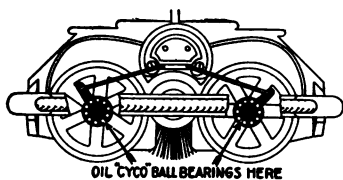

FIG. 101. Section of carpet sweeper.

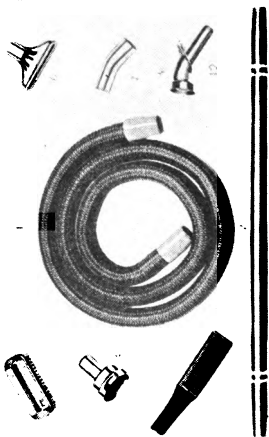

FIG. 100-a. Nozzles for vacuum cleaner.

one drop of oil on the ball bearing on the hub of each wheel. Failure to oil carpet sweepers causes them to wear

out quickly, to squeak, and to run hard. More oil than is needed only gathers dust and gums the sweeper.

Empty the sweeper (Fig. 102) each time it is used, even during the sweeping if necessary. Don't fill it to overflowing.

Always open the pans by pressing on the dump levers, not by taking hold of the pans. Don't let the brush get tangled with hair, ravelings, etc. Take it out occasionally and clean it (Figs. 103 and 103-a). Cut along between the spiral rows of



FIG. 102. Emptying sweeper.

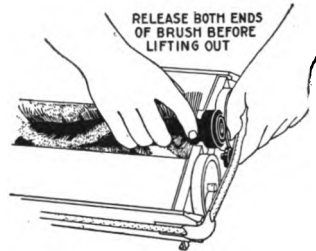

FIG. 103. Releasing brush in sweeper.

bristles with a sharp knife or shears, and the ravelings and hairs can be picked or combed out easily without injuring the brush (Fig. 104). Never try to pull them off whole. Also

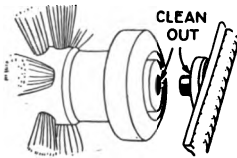

FIG. 103-a. Details of construction of carpet sweeper.

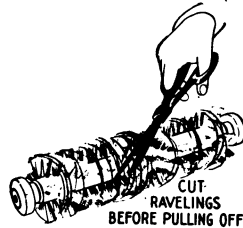

FIG. 104. Cut ravelings from brush.

remove any accumulation of dirt or ravelings which catch in the wheels or bearings. Don't let dirt collect in any part of the machine. Keep it clean. Good sweepers work best without extreme pressure on the handle. Never put oil, water or any liquid on the bristles. Don't keep a sweeper on a warm-air register—it takes the life out of the bristles.



**191. Mop Wringers.** There are two kinds of mop wringers to attach to pails. One is made of two flat surfaces which, when pressed together with the mop between (Fig. 105), squeeze the water out of it, and the other is made of two

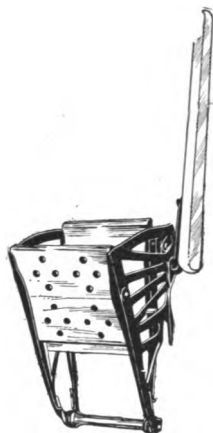

FIG. 105. Mop wringer.



FIG. 106. Another type of mop wringer.

wringer rollers which, when brought together by a lever after the mop is put between them, rotate as the mop is pulled upward and wring out the water (Fig. 106).

#### QUESTIONS FOR PART VII

1. How do vacuum cleaners pick up dust?
2. Describe some type of vacuum cleaner.
3. What care should be given a vacuum cleaner?
4. Tell how to clean a carpet sweeper.

# PART VIII

## DEVICES FOR PREPARATION AND CONSERVATION OF FOOD

### CHAPTER XXVII

#### POTS, PANS, AND OTHER DEVICES

**192. Materials from Which Utensils Are Made.** Since there is considerable choice in utensils made from different materials, the housekeeper may like to know something about these materials and about their care, and the effect of acids and alkalis upon them.

12- Russia iron is one of the older materials for pots and pans, and it still holds a place in cookery, for it makes bread, loaf cake and cooky pans, which give to the food a thin, brown crust, due, undoubtedly, to the way in which it conducts heat. (See tables on page 158.)

Tinned metal, which is well tempered, also, gives a thin, brown crust to layer cakes and pies. It makes good bread, loaf cake and cooky pans. Most of the cheap tin of today is iron-coated with very little tin. It does good work, but utensils made of it cannot be kept as well polished and as attractive in appearance as more heavily-tinned ones.

Sheet iron, heavy steel and cast iron make the most popular frying pans. The heavy iron, holding heat as it does, makes a desirable brown coating on most foods without the danger of burning experienced with frying pans of other

materials. This is due to specific heat and conductivity of the metal. Sheet-iron frying pans are useful in cooking foods which are wanted on short notice. The small-sized ones are most in use.

**193. Aluminum Alloy.** Satisfactory frying pans are made from aluminum alloyed with other metal and cast. Real aluminum frying pans warp. They do not brown the food as well as materials that conduct heat less rapidly.

**194. Cast-Iron Utensils.** Heavy cast iron finds special favor in the making of pot roasts, bread sticks and popovers. It browns the roast and makes a thick crust on bread sticks and popovers.

All iron or tin utensils give better service as they become tempered with use. They must be kept dry in order to prevent rust. Do not use them for cooking acid foods.

Granite, cast aluminum and Russia iron are the popular and satisfactory materials for roasting pans.

**195. Earthenware.** For casseroles and bean pots, earthenware is a favorite material, tho heavy glass gives equally good results. These materials are fitted for long, slow baking of food. They hold heat and conduct it to the food in such a way as to produce results which are difficult to duplicate with utensils of other materials.

**196. Aluminum and Graniteware.** Stew pans are proving satisfactory when made of aluminum and of high-grade graniteware. An assortment of pans and double boilers containing utensils of each material gives the best results, as the granite is most desirable for cooking some acid and very salty food, while aluminum is light and satisfactory for pre-

paring other dishes. Never let food stand in aluminum or granite dishes after being cooked. High-grade graniteware is not as readily affected by acids as the low, cheap grade. Enameled ware, which is roughened by a dilute solution of vinegar, is likely to contain substances injurious to health. Ink will not stain good enameled ware. Graniteware, like glass and earthenware, makes a heavy crust on the dishes being baked in them. Graniteware is metal, coated with a sort of glass. It must be treated like glass. It cracks when dropped. Never set it on a hot stove when empty or cold, as the heat of the stove will crack it as it will glass. When hot, do not set it on a cold marble or a metal table top, as sudden changes in temperature will crack it. With proper care, granite and enameled ware give good service.

Graniteware is proving desirable for making utensils for use on electric stoves, the conductivity of the glass coating being so low, that it conducts the heat to the top of the pan slowly so the food in it gets to cooking quicker than in utensils made of most of the other materials.

Aluminum is easily dented and warped by extreme heat. It is attacked by some strong acids and strong solutions of salt, soda and fruit juices. Aluminum may be hardened by the addition of six to seven per cent of copper so that it can be cast into utensils. Great care must be used not to use cleaning powders which contain strong alkalis for cleaning aluminum ware. It has light weight, and, when polished, is very attractive. With proper handling, it gives good service.

**197. Mixing Spoons.** The wooden mixing spoon gives best results, as it does not mar the utensils, and the handle does not become as hot as metal. Hard maple or orange

wood cut in a plain design makes the best spoon. Acids do not attack it. Plated silver or solid nickel spoons come next in usefulness. Softer metals wear off too fast to be satisfactory.

Nickel is a most desirable material for household utensils, but is very expensive. It is not in common use in this country.

TABLE SHOWING CONDUCTIVITY AND SPECIFIC HEAT OF METALS

METAL	CONDUCTIVITY	SPECIFIC HEAT
Silver.....	1.00	0.0559
Copper.....	.74	.0923
Aluminum.....	.48	.2022
Tin.....	.15	.0509
Iron.....	.12	.1098
Glass.....	.0017	.....
Silicon.....	.....	.159 at 10° C.
.....	.....	.2029 at 232° C.
Nickel.....	.....	.1084
Tungsten.....	.....	.035

## CHAPTER XXVIII

### PARERS, SEEDERS, GRINDERS, SLICERS, ETC.

**198. Fruit and Vegetable Parers with Knives.** Parers of the type with a knife have a fork-like device on which the fruit or vegetable is held while a knife blade, attached to a shaft governed by a spring, is pressed against the fruit or vegetable so that it cuts off a thin layer of the surface. Both the fruit and the knife are caused to rotate so that the whole surface of the sphere-like object will be covered by the blade of the knife during one or more revolutions of the wheel which operates them (Fig. 107). The knife is guarded so that it cuts only a thin layer from the outer surface of the fruit or vegetable. After the knife has made the complete journey over the surface, a device attached to the machine pushes the object from the fork so that a new one may be put in its place. Parers are quite complicated devices, but they have been perfected so that they are not clumsy, and some can core apples, stone peaches and slice the fruit.

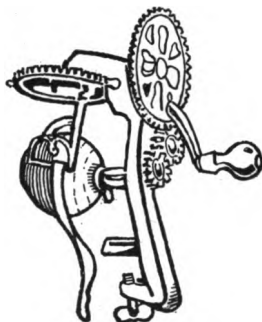

FIG. 107. Parer.

Keep this type of machine dry so that it will not rust. Do not put it into water. Wipe off the blade of the knife and the fork when thru paring, so that the acid of the fruit will not discolor them and dull the knife. Keep the other parts dry and oiled. In time the spring governing the knife becomes

weak and the machine will not do good work. This spring can be replaced on some machines. Parers are usually made of cheap material so that a new machine costs less than the repairs.

**199. Parers Which Grate Off Skins.** Another type of parer is a grater-like device. This is used in larger establishments than the ordinary home, but is useful where there is much canning of hard fruits or vegetables to be done at home. It consists of a container,

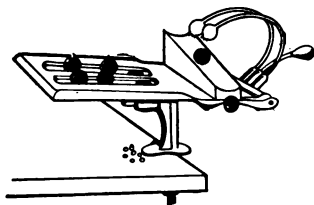

FIG. 108. Cherry stoner.



FIG. 109. Grinder.

the inside of which is rough like a grater. The vegetables or apples are put into the container with water enough to float and separate them, and the whole is agitated so that the vegetables coming against the sides have the outer surface removed or grated off. The water acts as the medium for moving the vegetables and for removing the bits of skin from the sides of the parer.

Keep this parer clean by scrubbing the inside with a stiff brush and rinsing well with water after using. Keep in a dry place.

**200. Seeders and Stoners.** Seeders and stoners are constructed to punch out the seeds which are contained in cherries, grapes, raisins, etc.

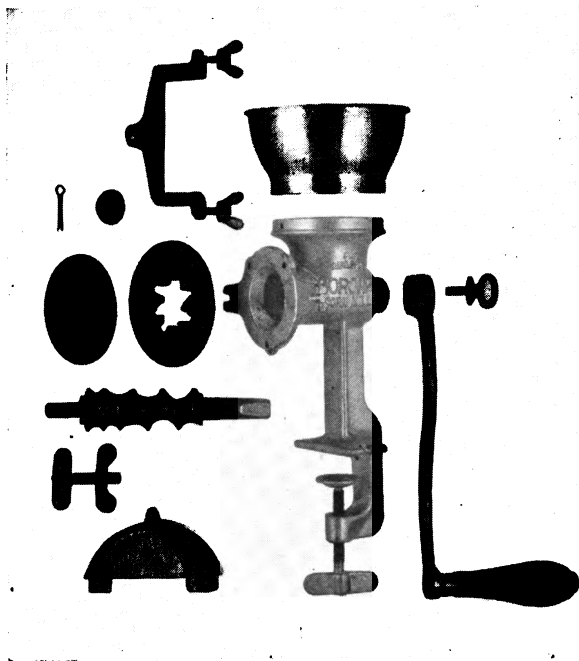

FIG. 110. Parts of Corona grinder.

**201. Cherry Stoner.** A simple cherry stoner (Fig. 108) consists of a small platform with a rod slightly smaller in diameter than a cherry stone. The cherry is put on an inclined plane so that it rolls over the hole. The cherry usually stays on the rod until this rod is lifted; then it passes between two guards which pushes the cherry off on another incline, where it rolls into a pan (Fig. 108).



There are several makes of stoners, but most of them work on this principle, whether the rod is lifted by hand or moved by a crank.



FIG. 111. Parts of Universal grinder.

**202. Grinders.** Grinders are of two principal types—the roller and the burr. Coffee and other hand mills are of the burr type (Figs. 109 and 110). The food passing between these rough surfaces is ground to a fine powder as one is turned on the other.

**203. Choppers or Meat Grinders.** Choppers or meat grinders, as they are sometimes called, consist of a spiral

channel, thru which the food is pushed along. Knives are placed in the sides of some machines to chop the food as it passes, while in others the knives are only at the outlet. Keep the fingers out of the hopper when the chopper is being operated. Keep the machine clean and dry when not in use (Fig. 111).

**204. Choppers.** Choppers have been made which really chop the food without crushing it, but these machines are so clumsy and noisy, that they have not come into common household use. They consist of chopping knives which are raised and lowered by levers and a crank.



FIG. 112. Vegetable slicer.

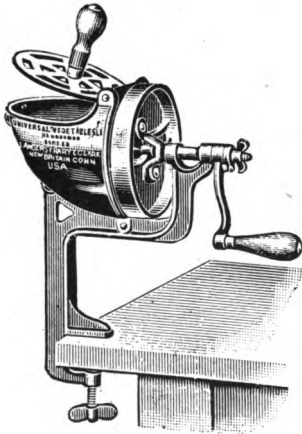

FIG. 113. Universal vegetable slicer.

**205. Slicers.** Slicers vary in design. The following illustrations (Figs. 112 and 113) show two different types. Care must be taken to guard the fingers when using slicers. Wash the knives and keep them dry when not in use. A soiled knife gets dull faster than a clean, dry one.

**206. Lard and Fruit Presses; Sausage Stuffers.** Presses and stuffers are of two types—the one which depends on the weight exerted on a long lever, and the other which depends on a screw to press the substances. The screw forces a flat board or surface down upon the food as it is turned. More pressure

for the size of the device can be secured with the screw than is practical with a weight on the long arm of a lever

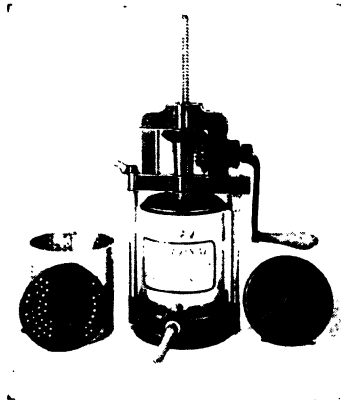

FIG. 114. Lard and fruit press.

(Fig. 114). The stuffer is like a press, except that the food is forced out one hole.

## CHAPTER XXIX

### MIXERS, BEATERS AND CHURNS; COFFEE POTS

**207. Use of Mixers, Beaters and Churns.** Mixers, beaters and churns are all devices for agitating or stirring food.

The simpler ones of these devices depend upon the motion of the hand (Fig. 115), while others have their velocity increased by means of cog wheels.

The turning of the large wheel turns the small wheel as many times as number of cogs on the small wheel is contained in the number on the large wheel (see Fig. 116). To get even more speed or to apply the

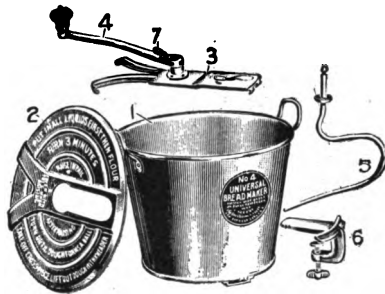

FIG. 115. Parts of bread mixer.

power at a different angle, a series of wheels are sometimes used. A few mixers, like the bread mixer, are simply machines which take the hands out of the food, thus tending to a higher degree of sanitation, and a change in the motion which may not be so tiring as kneading. They do not increase the speed of mixing.

Bread made in a mixer has a somewhat different texture than bread kneaded by hand, but this does not change its nutritive value.

**208. Care of These Devices.** The principal care needed by these devices is that they be kept clean and the cog wheels

dry. Very little oil should be used, as it would tend to get it into the food. Sometimes the rivet holding a wheel needs to be tightened, as, for example, when one becomes so loose that the wheel slips cogs. If it is too tight, the wheel may bind and work hard.

**209. Freezers.** The freezer is a mixer in a can which is in turn set in a freezing mixture of ice and salt.



FIG. 116. View showing internal arrangement of cake mixer.

Freezing can be done without stirring the cream. This makes a cream filled with crystals, while if stirred, it will be smooth and velvety because it freezes more evenly. The rapidity of freezing and the proportion of the ice and salt affect the fineness of the grain of the frozen dish.

A freezer is designed not only to stir the food, but to scrape it from the sides of the can. That which freezes first must be stirred into the middle of the can; otherwise, it would form a hard frozen layer of cream on the sides, leaving the middle unfrozen, and interfere with the turning of the paddle or beater.

In the bottom of the outside bucket, holding the ice and salt, is a socket into which the pivot on the bottom of the can fits. The can turns on this pivot in the direction opposite to which the paddle is turning. Some freezers are made so

that the can stays stationary. The function of the pivot is then to hold the can in the center of the pail so that the paddle will be in the proper position to turn easily.

**210. Care of Freezers.** The pail of wood should not be stored in a very dry place when not in use. The can and paddle must be kept clean and dry so that they will not rust. The bearings and wheels which turn the paddle and can must be kept dry and oiled.

There is a hole in the upper part of the tub or pail in which the can sets, and this should be kept open as it is placed slightly below the level of the top of the can so as to drain off any water from the melting ice which otherwise might get into the can and make the food salty.

Some freezers have another hole at the bottom of the tub. This should be kept closed while food is being frozen. It is useful to drain off the water from the tub when the freezer is to be repacked or emptied. It should not be opened at any other time.

**211. Churns.** Churning can be done with almost any device which agitates the cream, but the churns which are simplest are most easily cleaned and least wasteful of butter. They are barrels or other containers which revolve or swing backward and forward.

Keep churns clean and well aired so they will not give up odors and flavors to the butter. After a churn has been used, rinse it with cold water and then wash it in hot water, to which washing soda has been added. Lastly, rinse with scalding water. Leave open to air when not in use, but protect from dust and dirt.

**212. Drip Coffee Pots.** Drip coffee is made in a funnel

or a cup-shaped device which is suspended in a coffee pot (Fig. 117). This is made either of cloth or perforated metal. The coffee is pulverized and packed into the funnel. Cold water is poured on top of the coffee and slowly filters thru it, extracting flavoring substances. The water is heated after it has filtered thru the coffee.



FIG. 117. Drip funnel in percolator.

213. **Percolator Coffee Pots.** A coffee percolator is a device put in a coffee pot to hold the ground coffee above the water and pump some of the water to the

top of the pot so that it can seep back down thru the ground coffee (Fig. 118). A perforated cup with a perforated cover holds the coffee. Thru the center of this cup passes a small tube to the top of

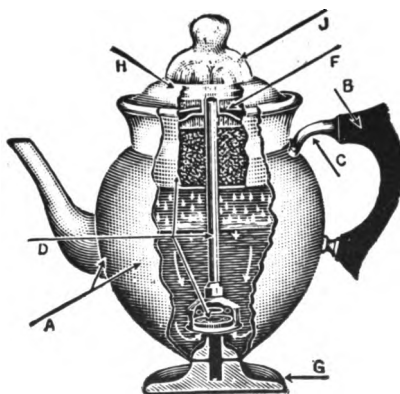

FIG. 118. Percolator.

the pot. At the bottom of the tube is a flat plate with turned-down edges or other device which supports the pipe and rests on the bottom of the pot. A small amount of water gets under this and into the pipe. The heat in the stove turns the

water next the bottom to steam, and this steam, in escaping, forces the water in the pipe to the top of the pot, and raises the device slightly so that more water flows under it and into the pipe, and again steam is formed and more water forced to the top of the pot. (See Sec. 161, Suction Washers.) After being forced out of the top of the pipe, the water falls in a spray on the cover of the cup and seeps down thru the coffee back into the main part of the coffee pot. The pumping devices in percolators may differ somewhat in design, but the working principle is the same—that steam is lighter than water and can be generated in amounts which will force water up thru the central tube.

Coffee grounds must not be allowed to get into the small tube, for they will hinder the flow of the water. The holes in the cup and cover must be kept open. There is less waste in using finely-ground coffee than the coarsely-ground in percolators. A small tube brush is needed for cleaning percolators. The coffee must not be ground so fine that it will sift thru the perforations in the cup.



## CHAPTER XXX

### DISH-WASHERS, CANNERS AND DRYERS

The dish-washers (Fig. 119) have found a place in hotels and large establishments, they are still in the experimental stage for general household use.

Small machines on the market, patterned after the hotel

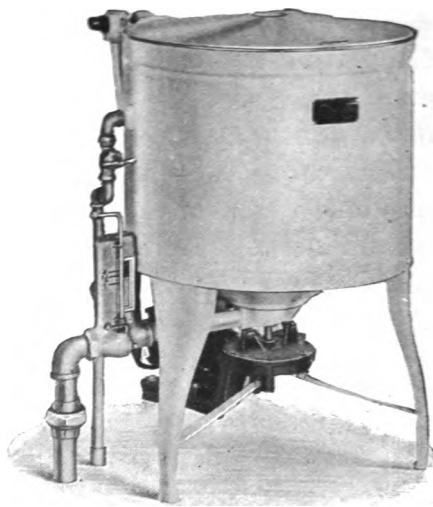

FIG. 119. Dish-washer.

type, are giving good results for home use. When using these machines, place the dishes in them in the manner directed and use as much water as is called for.

Some dish washers work on the plan of revolving the dishes in the water, some in forcing the water over the dishes, and others by agitation of both dishes and water.

Keep the pan washed clean. Keep all bearings properly oiled. Have the machine dry when not in use. There is least breakage in the washers which hold the dishes stationary (Figs. 119, -a, -b and -c).

One type of dish-washer has no motor; the force of the running water washes the dishes. This can only be used where the water supply is abundant and under considerable pressure. The washers equipped

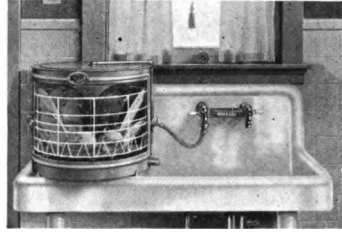

FIG. 119-a. Small dish-washer for household use.

with paddles for throwing the water over the dishes use about a dishpanful of water for washing the dishes, and as much more for scalding and rinsing them. When well scalded in the dish-washer, the dishes will dry if the cover to the washer is left open.

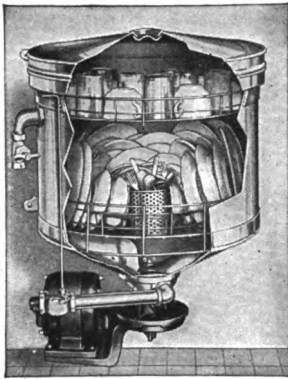

FIG. 119-b. Walker dish-washer.

**214. Dish Dryer.** There is a number of dish dryers on the market which hold the dishes separate from each other. Into these dryers, boiling hot water is poured, over the dishes. There is provision for the water being drained away immediately, and the heat it imparts to the dishes dries them. (Fig. 119-c.)

**215. Cleaning Silver.** Silver can be cleaned in an aluminum pan filled with water and soda. There are silver cleaners which are merely aluminum pans with which come

directions for proportioning the soda and the water. A mixture of salt and baking soda is sometimes used, combined with a piece of zinc in an aluminum pan. The salt, soda, zinc and

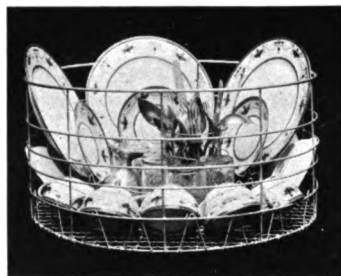

FIG. 119-c. Tray for holding dishes.

silver are put into the aluminum pan and set on the stove. The action of the salt and soda on the metals produces an electrolytic action which brightens the silver.

Do not use this method of cleaning on gray or colored silver.

**216. Canners.** Canners are devices for sterilizing fruit and other food which is being canned. The wash-boiler type

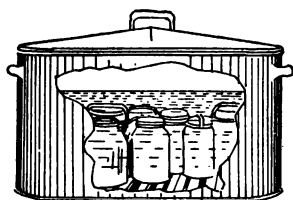

FIG. 120. Water bath canner.

consists of a boiler or kettle with a rack in the bottom to raise the jars an inch or so from its bottom to prevent the cracking

of the jars. It has a cover to keep the heat uniform. The water in the canner must entirely cover the jar. This is usually called a water bath, as the jars must be completely submerged in the water (Figs. 120 and 120-a).

**217. Water Seal.** Water-seal canners are like the water-bath canners, except that the cover has a flange on it, the depth of the boiler, and about two inches from the sides of it. This makes a jacket of water between the flange and sides of the canner. This causes the temperature inside to rise about two degrees above the ordinary temperature of boiling water. Food can be sterilized in a little shorter time in this canner than in the ordinary water bath. It is as important that the water entirely cover the jar in this canner as in the water bath.



FIG. 120-a. Small canning outfit.

**218. Pressure Canners.** Pressure canners are made very strong and have covers which fit tight, making it possible to raise the temperature in them considerably above the boiling temperature of water, so the food may be sterilized in a very short time.



FIG. 121. Pressure canner showing pet cock.

The pressure canner has either a rack or a perforated pail on the inside to raise the jars from the bottom as in other canners. It is also fitted with a steam gage which registers the pounds of pressure in the canner. Five to fifteen pounds pressure is

used for canning. The amount of pressure needed and the time of sterilizing depends on the organism present. A higher pressure is an indication of a higher temperature in the canner. After the jars are filled and put in the canner, the cover is fastened down tight by thumb-screws. There is a pet cock which is kept open when the canner is first heating, to let the air be forced out by the first steam which forms. As soon as the steam begins to escape, the pet cock is closed and the temperature inside of the canner begins to rise above the temperature of boiling water (Fig. 121).

On the canner is a safety valve which is set so that the instant a certain number of pounds of pressure is reached, it is lifted up by the steam. Some of the steam then escapes, thus preventing the pressure in the canner becoming so great that there is danger of its exploding.

**219. Use of the Canner.** Water is put into the canner to reach to the bottom of the rack. The jars are filled according to canning directions and are set in the canner. When the jars are in, the cover is adjusted to the canner and screwed on tight so that no steam will escape between the cover and the canner. The pet cock is left open until steam begins to escape thru it as the canner is heating on the stove. When steam begins to come, the pet cock should be closed, and the steam-gage hand then begins to turn, indicating that the pressure in the canner is rising.

When the steam gage reaches the point desired, the safety valve is adjusted so that the steam will escape should the pressure continue to rise. Until the operator knows where to set the weight to the safety valve, leave it well out to the end of the rod until the pressure in the canner has reached the de-

sired point. Then move the weight to the point on the arm of the valve which will just keep in the steam.

Be sure the cover is properly adjusted. Be sure to exhaust the air from the canner before closing the pet cock. Keep the fire so that the desired pressure will be maintained without the escape of steam from the safety valve. When steam escapes from the canner thru the pet cock at a rapid rate, it may cause liquid to flow out of the jars.

Be certain to let the canner cool until the indicator on the steam gage has reached zero before opening the canner. When the indicator points to zero, open the pet cock. If a heavy stream of steam starts to escape from it, close it again and wait a few minutes longer. Test again by opening the pet cock; if a very little stream of steam escapes, leave the pet cock open and wait until steam has stopped escaping from it. Now loosen the screws holding the cover in place. Partially loosen each screw. When this is done, fully loosen all and lift off the cover. These precautions are taken to prevent the operator from being burned by steam or getting hurt by the cover being lifted by the

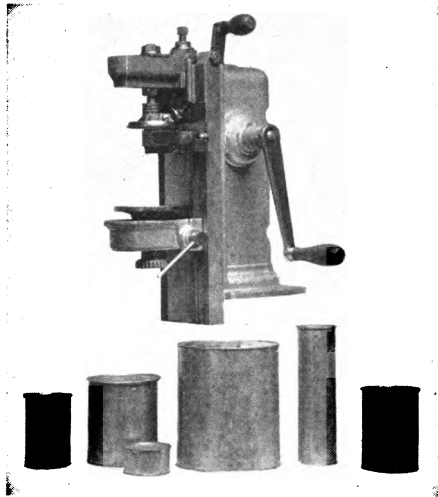

FIG. 122. Device for sealing tin can.

steam. It also prevents the breaking of glass jars due to sudden pressure changes.

Never let the canner cool so long before the pet cock is opened that air will rush into it, due to the vacuum which is sure to form when the steam is cooled if the pet cock is not opened. Such a condition may break the jars.

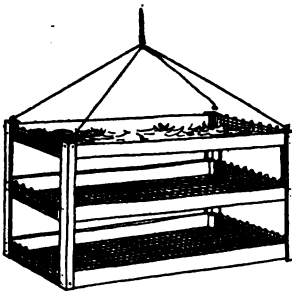

FIG. 123. Dryer.

Tin cans are sealed with a device (Fig. 122) which folds the edge of the cover over the top of the can so tightly it will not leak.

**220. Dryers.** Dryers are devices to hold the food being dried in a thin layer so that the air can be circulated thru it freely. Sometimes they are devised to direct currents of air thru the drying material. If the air is heated, the drying is hastened (Fig. 123).

A sieve on which food is spread hung above the stove is a simple drying device and one of the most practical for home use. The heat currents rising from the stove pass thru this and dry the food.

Many dryers are constructed on this same principle, having a heating unit below and trays of food above. These trays have to be shifted from time to time, as the moisture from the lower ones rises with the heat to the upper trays, thus retarding their drying. The top trays, if too numerous, are useless on this account. Two or three seem to be all that can be used with advantage at one time in home dryers, tho some machines are made with many more.

Another type of dryer has a fan device in it which forces the air thru at a faster rate than would be accomplished by heat alone. Such air should pass thru a strainer. Ordinary air, even when drawn from a clean room, carries much dust with it, and if the dust is not strained out previously, it is strained out by the food. This injures the quality of the product. Large commercial dryers provide such a strainer.

**221. Care of Dryers.** Dryers should be kept clean. They should not be heated enough to cook the food. Set them in a dry, airy place.



## CHAPTER XXXI

### SEPARATORS AND EMULSIFIERS

**222. Cream Separators.** A cream separator is a device for separating cream from milk. Separation can be done best while the milk is still warm (Fig. 124).

Separators should be set in a bright, dry, airy place free from dust and dirt. Near the separator should be a convenient place for airing and sunning the tin parts which come in contact with the milk.

The base for the separator should be solid enough so that it will not shake while the machine is being operated. If set on a wooden floor, see that the boards are nailed in place, and if the floor is thin, put heavy strips to cover several boards across it. Fasten the strips firmly to the floor and set the separator on them. When the machine is set up, be sure that it is set level.

**223. Different Types of Separators.** There are two types of separators—one which contains discs of metal (Fig. 125), and the other which depends upon a cylinder in which the milk rotates (Fig. 124) for the separation of the cream from the skim milk. Fig. 126 shows a sectional view of the DeLaval separator.

Cream is lighter than milk, and when milk and cream are whirled rapidly, the milk, being heavier, flies to the outside of the container, and the cream stays near the center. Two pails whirled rapidly made the first separator ever used, but that was clumsy and impractical.

Modern separators consist of a pan which holds the milk, and which lets it flow in a stream into the portion of the machine which is being whirled rapidly by the turning of the

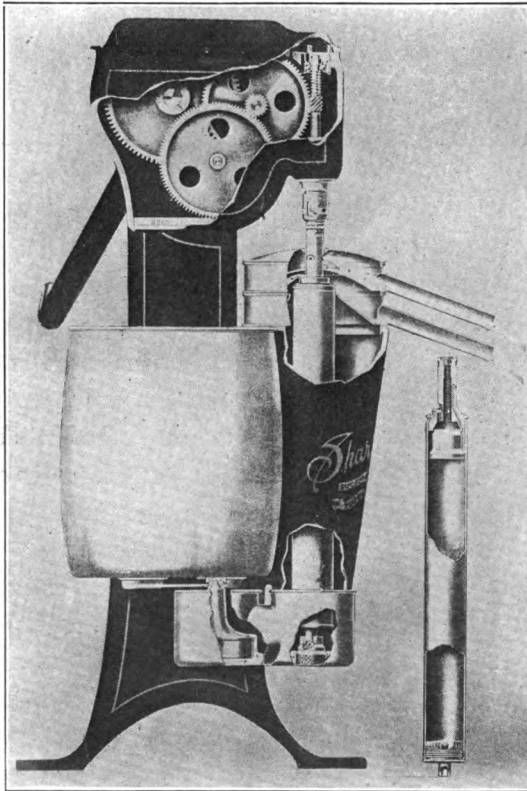

FIG. 124. Cream separator.

wheel at the side. There is a place in the rotating part which lets the cream flow from the center into one container, and the milk flow from the outside to another.

The parts of the machine must be fitted together properly; otherwise, it will fail to do good work.

Always turn the wheel at the speed indicated for the machine with discs. If there is no speed indicated, turn as fast as needed for good separation of milk and cream. Take care not to drop and dent any of the tin parts. Adjust for the density desired for the cream.

**224. Washing the Machine.** As soon as milk has been skimmed with the separator, pour some water into the bowl and run it thru the separator the same as the milk.

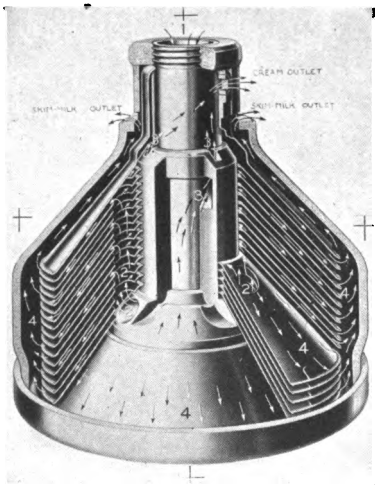

FIG. 125. Discs in DeLaval cream separator.

Wash the bowl and other parts in hot water in which washing soda has been dissolved. Rinse in clear water, and then scald with boiling water. Once a week give it a more thorough washing, scrubbing all parts with a brush. Sun the parts when not in use.

**225. Oiling.** The mechanical parts which whirl the separator should be kept oiled. In oiling, follow the directions which come with the machine. Use a good grade of oil.

**226. Whey Separator.** A whey separator is a machine very much similar to a milk and cream separator. It is

used in homes where much cheese is manufactured. It should be given the same care as other separators.

An homogenizer is a device used to give whole milk a consistency which is much like cream.

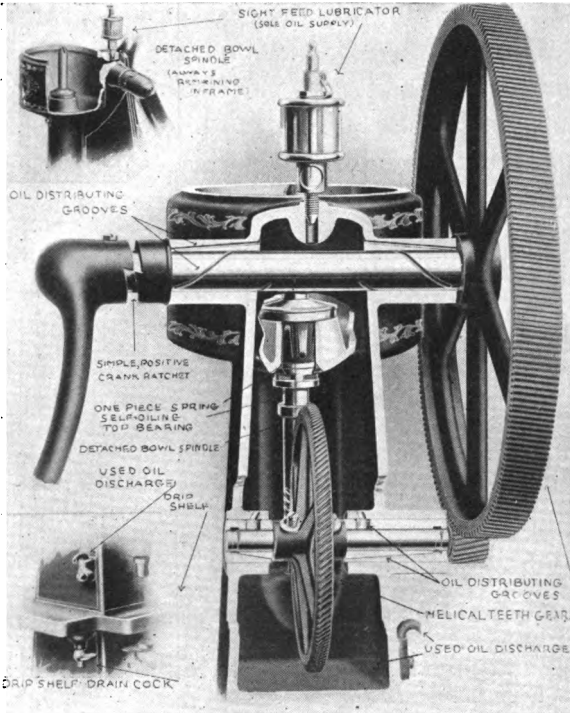

FIG. 126. Sectional view of separator.

**227. Emulsifier.** The emulsifier is a device for combining dried whole milk with water, or dried skim milk with water and butter fat so that they make a reconstructed milk of almost the same composition as new milk. An emulsifier

is of interest to the woman who lives in the city. Emulsifiers are used in large institutions. Some have been installed in settlement houses and public schools. They might be owned by communities where people might use a large amount of dried milk. In the emulsifier, the milk, water and sweet butter are warmed. After this, they pass thru a device looking much like a separator, but which mixes the ingredients together instead of separating them. From the mixer the milk passes over a cooling device, and is ready for use. This machine should be kept clean, and the parts which come in contact with the milk scalded out with hot water after being rinsed with cold water.

### QUESTIONS FOR PART VIII

1. What metals would you select for a pan to use when a thin crust is wanted? What materials produce thick crusts?
2. For what purposes would you choose aluminum? Granite? Cast iron? Glass? Earthenware? On what basis would you make a choice of utensils? Why wouldn't glass make a good ice-cream freezer?
3. What are the essentials of good parers, slicers and corers?
4. What kind of dish washers are proving the most helpful?
5. Describe a silver-cleaning device. Does the use of such devices harm the silverware?
6. What is a water-bath canner? How would you make one?
7. What may cause glass jars in pressure cookers to break?
8. How may the breakage be prevented?
9. Explain the ways in which cream may be separated from milk.
10. How do separators help?

# PART IX

## SUNDRY DEVICES

### CHAPTER XXXII

#### DUMBWAITERS AND OTHER HOUSE FURNISHINGS

**228. Dumbwaiters and Window Adjustments.** Dumbwaiters and elevators are used in homes where the kitchen is on a different floor from the dining-room.

The simplest ones are a set of shelves counterbalanced by weights. When the elevator is raised, the weights drop down, and when it is lowered, the weights rise.

Window weights hung over a pulley in the top of the window sash work on the same principle as dumbwaiters—the weights help in raising the window. The only care needed is to replace the rope when worn.

Another window pulley is made of metal like that in a clock spring (Fig. 127). The spring is drawn out when the window is lowered, and the weight of the window is just enough to hold it, so very little force is needed to raise the window, as the spring is pulling on it, too.

**229. Check Valves.** Check valves are made to prevent doors from slamming. They are used in offices and public buildings, and, occasionally, in homes (Fig. 128). One kind contains glycerine and castor oil, which move from one com-

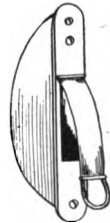

FIG. 127. Spring pulley for windows.

partment to another as the door is opened and slowly flow back as a spring pulls the door shut.

The other kind is operated by compressed air and a spring. The air causes the steady action of the door stop.

Another type of pneumatic hinge is attached to a door which is hung so that it would naturally swing shut. When the door is opened, the air is exhausted from part of the hinge. After it has been opened, the slow equalization of the air inside the door stop and outside allows the door to close slowly without slamming.

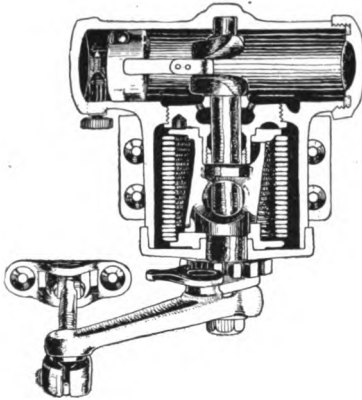

FIG. 128. Check valve.

strong spring on the inside. When the spring is released, it pushes down on a rod which is capped with rubber. When down, this comes in contact with the floor and holds the door in place. To change the position of the door, a small lever is used to lift the rod and compress the spring, thus releasing the door stop from contact with the floor.

**231. Window Shades.** Window shades are equipped with a spring in one end of the roller to aid in raising it. At the end of the spring is a flat bar which is held in position by the bracket on which the

**230. Door Fastener.** A door fastener (Fig. 129) is a small device which has a

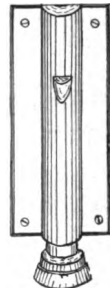

FIG. 129. Door holder.

shade is hung. Small catches hold the curtain when it is at the desired position (Fig. 130). If the spring becomes weak, draw the curtain down. This compresses the spring. Stop so that the clamps always fall into place to hold it. Then remove the curtain from the brackets and roll it up by hand.



FIG. 130. Spring in curtain roller.

Place it back on the brackets. It can then be raised or lowered as wanted, and will work with more power. Take care when doing this not to wind the spring so tight that it will draw the curtain clear around the roller, thus letting the spring unwind or breaking the spring.

**232. Hinges.** There are some hinges which should be of interest to women. These are the ones for doors which swing only one way, and for those which swing both out and in (Fig. 131).

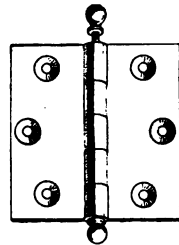

FIG. 131. Hinge.

**233. Sliding Doors.** When sliding doors slip off the slide, they may be replaced. They are hung like a barn door. There is a metal track above the door between the walls. The door is hung on this track by pulleys which slide along the track. Sometimes, by accident, these pulleys are slipped from the track. The door then must be lifted so that the pulley can be set back on the track. Usually the door needs to be lifted but a fraction of an inch and then pushed a little to one side or the other to get the pulley into place.



## CHAPTER XXIII

### SEWING MACHINES

**234. Different Types of Sewing Machines.** There are two types of sewing machines in use—the chain-stitch and the

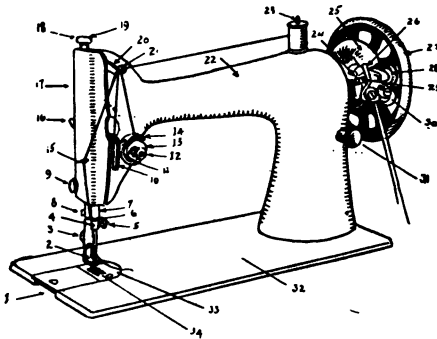

FIG. 132. Lock-stitch machine.

- |                                  |                                     |
|----------------------------------|-------------------------------------|
| 1. Bed Slide                     | 17. Face Plate                      |
| 2. Presser Foot                  | 18. Pressure Regulating Thumb Screw |
| 3. Presser Foot Thumb Screw      | 19. Presser Bar                     |
| 4. Needle Clamp                  | 20. Thread Take-up Lever            |
| 5. Needle Clamp Thumb Screw      | 21. Thread Guide                    |
| 6. Needle Bar Thread Guide       | 22. Arm                             |
| 7. Needle Bar Bushing            | 23. Spool Pin                       |
| 8. Thread Cutter                 | 24. Bobbin Winder Stop Latch        |
| 9. Face Plate Thumb Screw        | 25. Belt Cover                      |
| 10. Slack Thread Regulator       | 26. Bobbin Winder Thread Guide      |
| 11. Tension Spring               | 27. Balance Wheel                   |
| 12. Tension Regulating Thumb Nut | 28. Bobbin Winder Pulley            |
| 13. Tension Discs                | 29. Bobbin Winder Spindle           |
| 14. Thread Take-up Spring        | 30. Bobbin Winder Worm Wheel        |
| 15. Thread Guide                 | 31. Stitch Regulating Thumb Screw   |
| 16. Presser Bar Lifter           | 32. Bed                             |
| 34. Feed Plate                   | 33. Throat Plate                    |

lock-stitch. Sewing machines are made to run by hand, foot or mechanical motor power. This makes no difference in design or care of the stitching part of the machine. Motor and foot power run the machine faster than hand power.

The treadle of the foot-power machines swings on pivots. These should be kept oiled and clean from lint and thread. The large and the small wheels for the belt should be oiled at the axle.

**235. Lock-Stitch Sewing Machine.** A lock-stitch sewing machine (Figs. 132 and 133) consists of shafts and

wheels which move the needle, feed plate and bobbin. The top thread is guided from spool to needle thru a tension so that only the needed amount passes forward each time the needle is raised after the thread has caught in the cloth.

When there is a difference in the size of the thread used on the machine, the tension must be adjusted to fit the thread, unless the tension is automatic. If the tension is

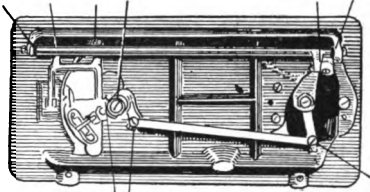

FIG. 133. Under part of machine using a vibrating shuttle.

not properly adjusted or the machine threaded properly, the thread will either break, tangle at the needle point, or draw the top thread tighter than the bottom one (Fig. 134).

A longer stitch is needed for coarse thread than for fine thread.

**236. Feed Plate.** A device below the needle called the feed plate (No. 34, Fig. 132) shoves the cloth faster or slower under the needle, according to its adjustment, thus making



FIG. 134. Diagram showing proper tension.

a longer or shorter stitch. This device is a rough plate which moves backward each time the needle is raised, and forward again when the needle comes down. While moving backward, the rough surface moves the cloth, but it drops slightly below the level of the table as it moves back into place, so does not affect the cloth. For short stitches, it moves with a short stroke, and for long stitches, with a long stroke. If the feed plate becomes gummed with lint and oil, the machine

will not make even stitches and may fail to move the cloth. Sometimes it will fail to stitch. Improper threading may break the needle thread. Too tight a tension may break it. Too coarse thread for the size of the needle may break the needle. A bent, blunt pointed or incorrectly set needle may break.

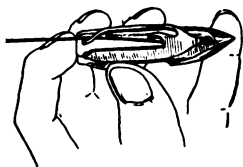

FIG. 135. Shuttle bobbin.

**237. Bobbins.** There are two styles of bobbins used on lock-stitch sewing machines—the shuttle bobbin (Fig. 135) and the round bobbin (Fig. 136), depending on the particular type of machine used.

**238. Shuttle Bobbins.** In shuttle bobbins, there is a long iron spool on which the thread is wound. This is put into the bobbin with the twist in the direction indicated in the book of directions for the

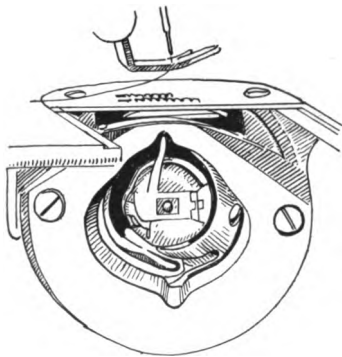

FIG. 136. Spool bobbin.

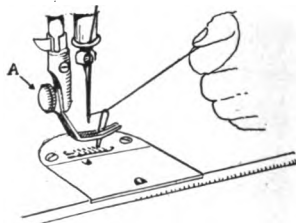

FIG. 137. Pulling up bobbin thread.

machine being used, and the thread is drawn thru the slits and holes in the bobbin which govern the tension of the lower thread (see Fig. 135).

Put the shuttle into place and draw the thread up over the feed plate (Fig. 137). The machine moves the shuttle back-

ward and forward, and as this happens, the needle is timed to drop down, leaving a loop of thread in such a position that the bobbin passes thru it. In rising, the needle pulls the loop up tight, and as it has passed thru the cloth, this cloth comes in between the thread from the bobbin on the under side and the thread from the spool on the upper side, which have been interlocked by the bobbin having passed thru the loop of thread from the spool as the needle carried it down below the cloth. This is called the lock-stitch (Fig. 134). The spool bobbins also pass thru the loop left after the needle has passed downward.

**239. Chain-Stitch Machine.** In the chain-stitch machine (Fig. 138), the shaft turns a device which draws a loop of thread thru each foregoing loop, thus making a stitch similar to crocheting, but having the cloth interlocked with the stitch. The needle carries the thread and makes it tight or loose as needed. The feed plate carries the cloth under the needle.

There is a tension to govern the thread. As a single thread is used in making this stitch, no bobbin is used. The tension must be tight enough to draw the loop of thread about the cloth, or else the thread will tangle.

**240. Cautions for All Machines.** Machines should be kept well oiled, and they must be kept free from thread and lint, for these are the things which give trouble in machines. Never try to draw the cloth under the needle any faster than it is pushed along by the feed plate under the presser foot. Pulling on the cloth bends the needle from the exact path which it should follow.

Move the treadle with a smooth, even motion—a jerky motion wears out operator and machine. Use only the best sew-

ing-machine oil. Poor oil gums the parts of the machine. Clean the machine every day it is in use. Take care to set the needle in its proper position, and fasten it firmly in place.

**241. General Instructions.** Thread the machine ex-

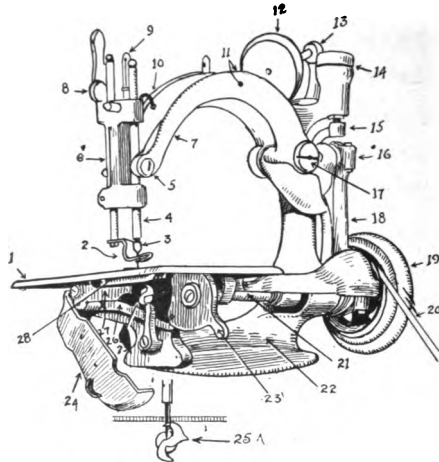

FIG. 138. Chain-stitch machine.

- |                     |                       |                      |
|---------------------|-----------------------|----------------------|
| 1. Cloth Plate      | 10. Embroidery Spring | 19. Small Wheel      |
| 2. Presser Foot     | 11. Pull Off          | 20. Belt             |
| 3. Needle-Bar Nut   | 12. Spool-Pin         | 21. Shaft            |
| 4. Needle Bar       | 13. Spool-Pin Holder  | 22. Frame            |
| 5. Needle-Bar Screw | 14. Automatic Tension | 23. Stitch Regulator |
| 6. Foot Bar         | 15. Tension Rod       | 24. Cap              |
| 7. Lever            | 16. Ball Stud         | 25. Looper           |
| 8. Liftee           | 17. Lever Stud        | 26. Link             |
| 9. Take Up          | 18. Connecting Rod    | 27. Feed Bar         |
|                     | 28. Feed Surface      |                      |

actly according to instructions. If not properly threaded, it will fail to stitch—the thread will tangle. If the bobbin is not properly threaded, it will not have the proper tension, and the machine cannot sew as it should. The bobbin thread will break if it is not properly threaded thru the bobbin case. It will also break if the bobbin tension is too tight (No. 14, Fig. 138).

Always regulate the stitch and the size of needle for each size and kind of thread used. A table for this usually comes with each machine, or is often stamped on the machine. Select the thread suitable to the material. The number of a needle is marked on the shank. Needles made for one kind of machine will not always work on another.

An automatic tension should not be changed or meddled with. Some tensions must be adjusted to the thread. Follow directions coming with the machine for adjusting tensions. Remove any thread which has become entangled in the mechanism of the machine.

Never use a bent needle. A bent needle drops stitches on a chain-stitch machine. Soaping the needle helps it to go thru goods difficult to penetrate.

When a machine runs hard, it needs oil or has become gummed up with poor oil. When gummed, clean with kerosene oil. Thread or ravelings wound about the axles of the wheels also makes the machine run hard. Learn to use the attachments of your machine—take care that they do not become bent.

The lock-stitch does not rip easily.

The ends of the thread of chain stitches should be carefully fastened. If started from the end where the seam was completed, the loop stitch may be easily unraveled and thus save time when mistakes are made in sewing or when garments are being made over.

## CHAPTER XXXIV

### AUTOMOBILES

No lengthy treatise on automobiles can be given here, but a few facts of general information are well in order.

Each car has its special features, but the basic principles of operation and control are the same for all makes. Let us consider, first, the control of the machine on the road.

**242. Starting the Motor.** Open the throttle from one-fourth to one-third way, to permit entry of plenty of gas into the motor. Set the time control about as far down as the throttle. Turn on the ignition switch and turn the motor with the starter.

A cold motor may demand use of the choker before starting, but, again, too free use of the choker floods the carburetor with a rich, non-explosive mixture which can be removed only by use of the starter. Should the motor flood too easily, or should it take too much choking, have the carburetor readjusted. Common mistakes in starting the motor are (1) too free use of the starter, which is injurious to the battery; (2) starting with the timer set too far down, causing back-fire. Occasionally, a novice attempts to start a car with the gears set and the brakes on. With the motor started and running smoothly, shift the gears into low and take off the brake. Let the clutch back gently to prevent the car from starting with a jerk. In shifting gears, the throttle should be kept down to prevent the motor from racing upon releasing the clutch. (3) A common mistake is the attempt to shift gears with the

clutch not entirely released. (4) Still another error is the failure to release the brake on starting, resulting in everything from a stalled motor to a stripped gear.

A difficult place to start a car is when stalled on a hill. This is done by holding the machine with the foot brake, throttling the motor with the hand lever, and slowly releasing brake and engaging clutch simultaneously.

**243. Driving the Automobile.** In driving, many things should be observed. The oil pressure gauge or indicator should be noted from time to time to see that the motor bearings are getting proper lubrication. The speed of the motor should be such that the battery is being charged rather than discharged, as is likewise shown by an indicator on the dash. This is especially important when using lights at night. Keep timer lever in correct place to prevent overheating.

The general rule for driving is—keep to the right side of the road, the only possible exception being when passing a vehicle going in the same direction; then go around on the left.

Stop before crossing railroad tracks, and drive slowly when approaching cross roads. In turning corners to the left, make the turn beyond the center of the cross road. Do not use brakes against the motor—release the clutch. Do not use the brake too forcibly; it will cause injury to rear tires and skidding. On slippery roads, make it a rule to use chains and drive slowly.

**244. Care of Car.** Under this heading, a few general rules may be given. Do not persist in running a machine when out of order. Never drive when the lubrication system is working imperfectly. Lack of cylinder oil will ruin a motor in a short time. Make it a rule to look at oil gauge before



starting. Care of the battery consists largely in keeping it charged and filled to the proper level with distilled water. Tires should be kept inflated at all times. In case of trouble, never run on a flat tire, as it will soon be worthless under such treatment. Never drive a machine while out of order—stop and have repairs or adjustments made.

## CHAPTER XXXV

### LAWN MOWERS; INCUBATORS

**245. Operation and Care of Lawn Mowers.** The wheels of the lawn mower permit it both to move easily over the ground and turn the knives which cut the grass (Fig. 139).

This means that they must be kept well oiled to work

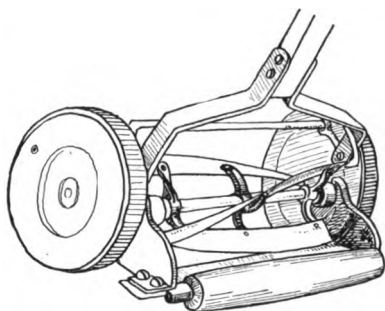

FIG. 139. Lawn mower.

easily—that the shaft of the wheel must not become wrapped with grass, weeds, string or wire. Most machines are made adjustable, and the knives are set to allow them to pass close enough to the plate at the bottom of the mower to clip the grass as if the machine were a pair of scissors. Keep the knives properly adjusted in relation to this plate. Do not let them come so close that they touch the plate but very lightly, nor be so uneven that one end cuts grass, while the other misses the plate so far that it will not cut.

If the knives are kept properly adjusted and the mower is not abused by trying to cut wires, stones, or by being stored where it becomes rusty, it will seldom need sharpening.

Keep all bolts tight.

**246. Storing Mowers.** When storing for the winter, grease the knives with a heavy coat of unsalted lard, or cover them with some other protective material.

**247. Scissors and Shears.** In popular language, there is no distinction made between scissors and shears. Technically defined, scissors are less than six inches in length. Any similar cutting device of greater length is called shears. Both are devices used for cutting cloth, paper, pruning trees, and many other purposes. They consist of two knives riveted together at some point between the handle and the point of the blade. The two blades are so adjusted that as the open scissors are closed, they touch lightly as they pass each other until the tip is reached. When the scissors are closed, the blades should touch only at rivet and tip. Scissors not so adjusted will not cut well, even tho the blades are very sharp. Dropping scissors often bends the blades. Blades may be straightened as well as sharpened, and thus make good metal scissors like new.

**248. Principles Upon Which Incubator Works.** A device for hatching chickens is called an incubator. In order to hatch chickens, the incubator must keep an average temperature of  $102\frac{1}{2}$  degrees Fahrenheit. The thermometer should be placed in the center of the tray and on a level with the top of the eggs. The temperature of  $102\frac{1}{2}$  degrees Fahrenheit must not vary greatly during the incubation of eggs.

The incubator must also permit of suitable ventilation and control of the moisture in the eggs.

There are incubators heated with hot water and others with hot air. The air or water in those commonly used in homes is heated with a kerosene lamp.

The device consists of a heating unit, a regulator or thermostat which, acting upon a valve or damper, regulates the admission of heat into the insulated box containing the trays of eggs, ventilators and a thermometer (Fig. 140).

**249. The Body of the Incubator.** The box-like body

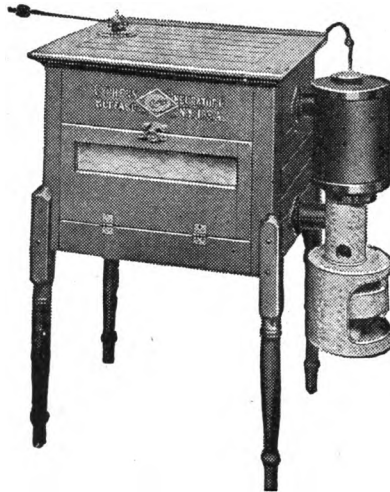

FIG. 140. Incubator.

of a good incubator is set on strong legs which raise it to a convenient height. The trays slide into the box on cleats about two or three inches from the bottom of the body. They fit so that a slit about two inches wide is left between for the chickens to drop down under the tray as they hatch. Usually this is near the door. If the door is furnished with a glass to admit light, the chickens are attracted toward light and fall thru the slit.

The walls of the incubator are usually double so that air can be let in without making a draft. Dampers in the side of the

machine regulate the admission of air. Ventilation both regulates the amount of air circulating in the incubator and the amount of moisture. Air from a damp room keeps the eggs moist. Air from a dry room dries them.

**250. Incubators Heated by a Lamp.** Choose a lamp which holds enough oil to last for twenty-four hours. Good lamps are usually made of metal and as plain as possible (Fig. 141).

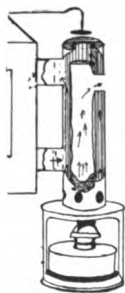

FIG. 141. Incubator lamp.

The burner furnished with them is an ordinary lamp burner carrying a straight, flat wick. Metal chimneys are used, there being enough mica in one side to permit the flame to be seen. The chimney extends into a metal chamber containing the hot-water pipes, or into a chamber thru which air is taken and heated by the chimney. The fumes from the burning oil pass out into the room and not into the incubator. The heated air passes thru ducts into the incubator. These are often constructed of wood.

**251. The Wick.** The wick most generally found practical is the cotton wick, such as is used in ordinary lamps. It should be kept clean and renewed often. The lamp should be kept filled regularly. The wick must always be kept trimmed even, to prevent smoking.

Incubators heated by electricity have the heating unit placed either above or below the trays of eggs. The current is controlled by a thermostat.

**252. Thermostat.** The thermostat also raises the damper over the top of the lamp and air heater (Fig. 142), when the incubator reaches the temperature for which it is set, and

lowers it when the temperature falls. When the damper is lifted, the heated air passes out into the room and not into the incubator. As soon as the incubator cools below this temperature, the thermostat contracts, letting the damper drop in place to retain the heat and direct it into the incubator. The thermostat works the same when a gas flame is used instead of a lamp. In electrical machines, the thermostat operates the switch, admitting much, little or no current, as is needed to maintain  $102\frac{1}{2}$  degrees Fahrenheit.



FIG. 142. Thermostat for incubator.

**253. The Thermometer.** A thermometer is placed in the incubator to guide the operator in regulating the temperature. It guides him in adjusting the thermostat and the heating device; that is, it shows him when to turn the wick of the lamp up or down.

Lamps should never be turned high enough to smoke. Smoke and gas in the room are likely to get into the incubator and harm the growing chicks.

**254. Operation of Incubator.** Set the incubator level; it is constructed to work on the level. Heated air rises—if the incubator is not level, the highest point will get most of the heat. It should be set in a dry room or dry cellar, which is well ventilated and well lighted. There should be no artificial heat in the room which is not regular. An uneven temperature gives difficulty in managing the heating of the incubator. The room should be free from dust.

Adjust the incubator and run it for two or three days to see that it is operating at a constant temperature before putting in the eggs.

Use only the best grade of oil, and use the same kind of oil all thru one hatch. Change in oil may necessitate a change in regulators which is not safe while the eggs are in the incubators.

Start the incubator with a good, clear, high flame in the lamp, so that it can be turned lower as the germs in the eggs begin to grow and generate heat.

Start the incubator at 100 degrees Fahrenheit, and by the second day, it will reach the temperature of 102 degrees.

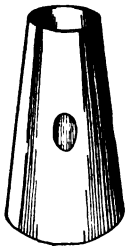

FIG. 143. Egg tester.

Violent fluctuations of temperature in the incubator are dangerous and should be avoided.

Accuracy in reading temperatures and in adjusting the thermostat and ventilators is essential. Fill the lamp and turn the eggs regularly. Cleanliness is important. Disinfect the incubator between hatches, and air it well.

Cresol soap and water make a good disinfectant for incubators. Turn and handle eggs with clean hands.

To know whether the incubator has the proper amount of moisture supplied, weigh the trays before filling, weigh after filling. At the end of the fifth day, weigh tray and eggs again, subtract the tray weight, which is constant, from the weight of the whole, and note the difference between this weight and the original weight of the eggs. If 100 eggs have lost 8.38 ounces, or 4.17 per cent of their weight, the moisture is correct.

If they have lost too much weight, give more moisture or less ventilation, but, remember, that pure air is essential to incubators, so do not shut off ventilation entirely.

If not enough weight is lost, open the ventilators, and, if necessary, for the next hatch, place the incubator in a drier place.

**255. Egg Tester.** An egg tester is a device for looking thru eggs to ascertain whether or not they are good. It consists of some device to keep all bright light away from the eyes except a few bright rays shining thru the egg. The hole should be about an inch long and three-fourths of an inch wide. A metal chimney with one such opening in the side used in a darkened room serves as an egg tester. A large piece of cardboard tacked over a sunny basement window is sometimes used, the hole being cut in the cardboard (Fig. 143).

Hold the egg between the finger and thumb before the opening. Look at the egg as the light shines thru it. Fig. 144 shows how good and bad eggs look when viewed in egg tester.

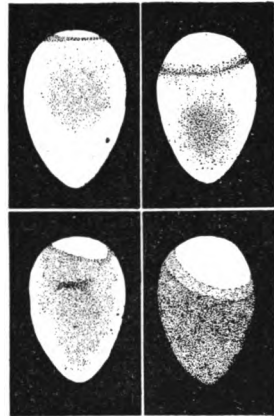

FIG. 144. Appearance of eggs when put in egg tester.



## CHAPTER XXXVI

### TYPEWRITERS

**256. Construction of Typewriter.** The typewriter is a machine for printing letters (Fig. 145). The letters making the imprint are attached to shafts which can each swing to one point. Care should be taken to strike one key at a time, as



FIG. 145. Typewriter, L. C. Smith.

they are all made to reach the same point, and contact with each other may cause bent shafts. If a shaft becomes bent, the letter attached to it will not swing to the desired point, so will be out of alignment, or will fail to leave a mark, since the imprint is made on a roller and the letter hits only the nearest part of the surface. The shaft may have one, two or three letters on it. This is made possible by the use of the shift key

which raises or lowers the framework to which the roller is attached, so that when the machine is in normal position, one set of type on the keys will be imprinted, and, upon the holding down of a shift key and simultaneously striking a letter, another set of type will make the imprint. On some typewriters there are two shift keys, allowing three sets of characters to be used. The motion of the keys turns a small wheel which shoves the roller from right to left, and, also, turns the spools of ribbons so that a new bit of ribbon comes under the letter each time a key is struck. If the ribbon did not move, the letters would soon cut a hole thru it. This ribbon carries the ink which reproduces the imprint of the letter. When the end of a ribbon is reached, most machines reverse its direction so that it again winds onto the spool from which it has just unwound. On other machines, it is necessary to release the bar which controls the spools to reverse the winding of the ribbon.

**257. Special Features of Typewriter.** Learn how to use the attachments on the typewriter to get the greatest service from it. If a machine is equipped with tabulating keys, much time is saved by using them for the indentations instead of working the space bar until the desired place is reached, or by using both hands to release the carriage and move it to its desired place. Some machines are equipped with a key marked "ribbon" key. This key, when pressed, lowers the ribbon so that no impression from it is made on the paper. When the ribbon is removed, stencils may be cut with the letters for mimeographic work. These are only two examples. There are many automatic aids on each make of machine.

**258. Interchangeable-Type Typewriters.** On these machines, the type is not placed at the end of a shaft, but the complete set of letters is put on a semi-circular plate which is attached to a wheel which brings the desired letter to the point wanted when the key is pressed (Fig. 146).



FIG. 146. Hammond interchangeable typewriter.

The change of type can be made very easily so that with the proper semi-circular plate any one of several languages may be written on this kind of typewriter regardless of the characters used to represent the letters.

Charts of the keyboard are furnished with each set of letters to guide the operator in writing. This machine requires the same general care as other typewriters.

**259. Care of Typewriters.**

1) Read the directions for cleaning and oiling the machine. Keep them for future reference.

2) Do not attempt to take the machine apart. Only re-adjust parts for which such directions are given.

3) Use only the best grade of typewriter oil, and oil only where indicated. The average machine does not require oiling oftener than from ten to fourteen days.

4) Brush the entire machine each day before using. This prevents the accumulation of oil and dust, which retards the free action of the machine, and rusts or clogs the bearings and other parts.

5) Use a stiff brush to clean the type. If the type has become gummed with ink from lack of care, moisten the brush with alcohol or gasoline, and brush it until clean. Avoid cleaning the type with a sharp instrument, if possible, as it mars the edges. However, in case of the letters having an enclosed parts, such as *o, d, e, b, g, p, a, s, c, q*, it may require the careful removal of the deposit with a pin. After this treatment, the type should be well brushed. Keep machine covered when not in use. With proper care, a machine should stay in good order indefinitely. If, in any way, any part of a machine is out of adjustment, have an expert read-just it.

**260. The Hectograph.** The hectograph is one of the simplest devices for obtaining duplicate copies of written work (Fig. 147). It is a sheet like heavy paper or pad of jelly-like substance on which a reversed copy of the writing can be made and from which copies can be taken. The original copy is written with hectograph ink on smooth paper by hand,

or on a typewriter, and allowed to dry. This copy is placed face downward on the hectograph pad, which has been moistened and rubbed to insure the contact at all places. It is allowed to remain here for three or four minutes. More time is required in cold weather, as the absorption of ink by the pad is slower. The paper is then removed, leaving a reversed impression on the hectograph plate. Copies are then made by placing dry paper on the impression and removing them instantly. Twenty copies may be taken. The plate should be washed in lukewarm water immediately after use. The hectograph plate should be about the temperature of an ordinary room; chilled plates produce faint prints. Never use cold



FIG. 147. Hectograph.

water on the plate. Keep pen flowing freely when writing the original copy, by wiping it frequently. Keep the hectograph

covered when not in use.

**261. Mimeograph and Multigraph.** The mimeograph (Fig. 148) is a more complicated device for reproducing duplicates than the hectograph, but more copies may be made at faster speed on this machine and the stencils may be saved for making more copies later. A stencil (tissue paper, usually blue, fastened to a sheet of equal size waxed cardboard) is cut by a typewriter. This is done by removing the ribbon and allowing only the outline of the type to cut thru the tissue which has been saturated with "Dermax," a liquid wax which is brushed over the surface of the waxed paper, and the tissue paper carefully smoothed out upon it. Some stencil paper or waxed sheets do not require this treatment of "Dermax"; instead a tissue or silk sheet is placed under the stencil pa-

per. When the desired wording is cut, the cardboard is torn off at the perforated line, leaving the four holes which attach the stencil to the roller of the mimeograph machine. First see that the pad on the machine is well inked, and then fasten the stencil to the pins at the top of the roller and with bar at the bottom, seeing that it is smooth.

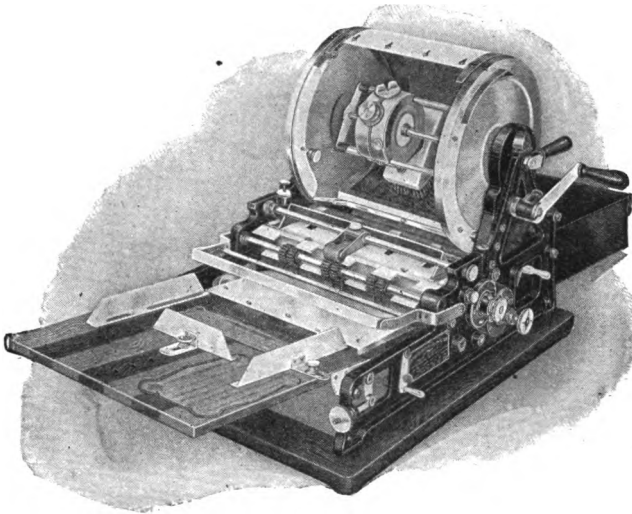

FIG. 148. Mimeograph.

Set the adjustment which indicates the number of copies turned out, so that it is not necessary to count them while printing. (Full directions are printed on this adjustment.) Place the paper on the feed board, far enough down for the sheets to come in contact with the rollers which feed them in, and turn the handle. If the proportion of space at top is greater or less than desired, set the attachment for regulating the space. Full directions are printed on each attachment of most machines. See that the ink tank which is located inside

the cylinder is kept full of the best ink. Ink the pad by pushing the brush across the inside of the perforated cylinder.

Multigraphs differ from mimeographs in that they print the copy from type instead of thru a stencil. The type is set in a cylinder that is covered by an inked ribbon. Manuscripts printed by a multigraph look more like typewriting than those printed by a mimeograph. When turning out less than a thousand copies, the mimeograph will be found more economical on account of the small amount of time required in preparing the stencil.

### QUESTIONS FOR PART IX

1. By what means are dumbwaiters operated?
2. Can you see any relation between the construction of door stops and force pumps?
3. What is the power for rolling up a window shade?
4. What does lock-stitch look like? How does chain-stitch differ from lock-stitch?
5. In what way do lock-stitch machines differ from chain-stitch machines?
6. What are the advantages of each? What are the disadvantages?
7. What is the tension? How is it adjusted? How is the length of stitch adjusted?
9. In what ways is an automobile engine like the gasoline engine and the electric motor used in rural homes for operating household machinery?
10. What is the shape of the knives on a lawn mower that makes it cut the same as a pair of scissors?
11. What may be the reasons for scissors not cutting as they should?
12. What are the essential features of a good incubator?
13. What is a thermostat? How does it work? Are thermostats of any use to the housewife on any other device than the incubator?
14. What mechanical factors are embodied in a typewriter? Find the pulley, the levers, the springs, etc.
15. What are the differences in a hectograph, a mimeograph and multigraph?

# PART X

## MOTORS, FUELS, AND GAS PLANTS

### CHAPTER XXXVII

#### TREADLES AND WATER MOTORS

**262. Definition of Motor.** A motor is a device for utilizing the power stored in gasoline, electricity or elevated water for doing work. The structure of the motor depends upon the source of its power, as does its name. Besides the

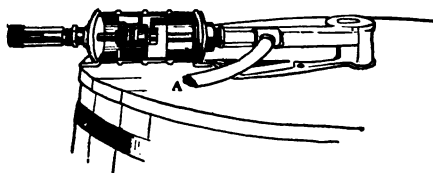

FIG. 149. Water motor.

motor, there is a treadle, or foot-power motor, used in the home.

**263. The Treadle.** The treadle is a small platform, which rocks on two pivots. As the treadle is rocked, it moves a rod attached to its outer edge, upward and downward. This rod is then attached to a wheel a short distance from the hub, so that the upward and downward motion of the shaft turns the wheel. When a belt is attached to the wheel, it will run a sewing machine or other small device.

**264. Water Motors.** Water motors are commonly used in the household on washing machines and pumps (Figs. 149



and 149-a.) At least twenty-five pounds of water pressure is required to run an average-size washer. More pressure is advantageous. The motor may be, and often is, attached to tanks in which water is held under pressure, and used to pump water from a cistern or well.

**265. Selecting a Water Motor.** Before purchasing any



FIG. 149-a. "Reliable" water motor.

device to be operated by a water motor, ascertain how much water pressure you have available. Under enough pressure, the water from a faucet will give power enough to a small-sized water motor to run a washing machine, sewing machine or small feed grinders. These motors are usually less than one-half horse power.

**266. Two Types of Water Motors.** One type of water motor is made up of a piston and valves in a cylinder (Fig. 150). The water pushes the piston to a certain point when a

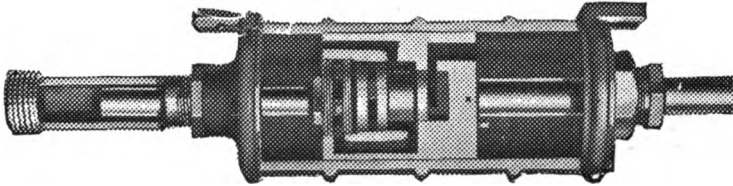

FIG. 150. Sectional view of water motor.

valve opens and lets out the water. The piston then moves backward until it automatically opens another valve, letting in more water, which, in turn, pushes the piston forward and again to the point where the first valve opens. The motion of the piston must be strong enough to do the work. About twenty-five pounds of water pressure is required in moving the piston forward when attached to a machine which might be operated by hand by a woman.

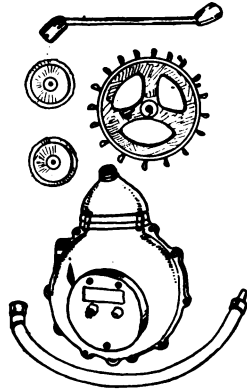

FIG. 150-a. Water motor assembled and in parts.

Another type of water motor consists of cups or fans on the rim of a wheel. As the water flows over the wheel, it pushes it around, thus giving it power to do work provided there is enough pressure behind the water (Fig. 150-a).

## CHAPTER XXXVIII

### ENGINES; MOTORS AND BATTERIES; FUELS

**267. Gasoline Engines.** A gasoline engine (Fig. 151) should be operated out of doors or in a well-ventilated room, except in cases where the exhaust pipe is carried thru the wall of the building to the outside. The fumes may cause illness, or even death, to any one staying in the room.

A gasoline engine should be mounted on a substantial base of concrete or heavy timbers, or on a well-built truck, and should be put in good order before the woman or girl begins to use it. The engine must be level. If more than one device is attached to it, be sure to use the right pulleys on the engine and the machine to be operated. An engine is usually equipped with pulleys of two or more sizes. The size of the wheel on the washing machine or vacuum cleaner must be of a size to make the desired number of revolutions per minute.

**268. Figuring Speed of Pulleys.** For example, if the speed of the engine is 425 revolutions per minute and the diameter of the pulley on the engine is 12 inches, and the machine is to be run at 150 revolutions per minute, have a pulley on the machine of a diameter which equals 425 times 12, or 5,100 divided by 150, or 34 inches.

It would be more convenient to have a smaller pulley on this machine. Since there is a smaller wheel on the engine which, we will say, is 6 inches in diameter, put the belt on the smaller wheel, and then a wheel only 17 inches in diameter will be needed on the machine.

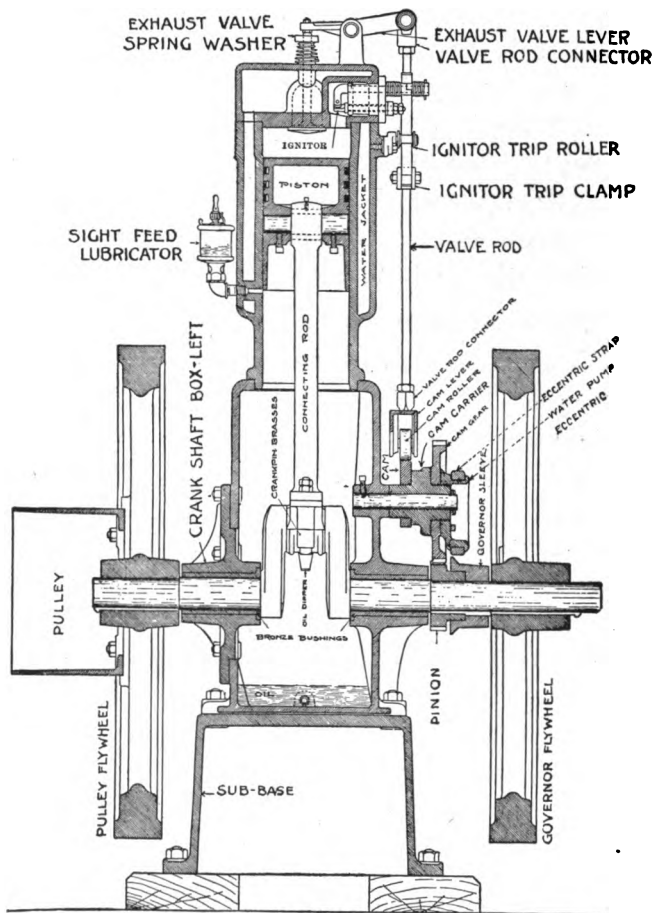

FIG. 151. Sectional view of gasoline engine.

**269. Operating the Engine.** One person should be responsible for the care of an engine. Starting the engine is usually too heavy work for most women. Since a man usually starts a gas engine which the women are to use, it is more important that they know how to stop the engine and to recognize when it is not running properly. A cold engine can be started easier if warmed with hot water.

Running an engine which is out of order may damage it seriously. Have some one show you how to operate your engine. Stop it when not running properly.

**270. Points in Caring for Engine.** The following are points to keep in mind when operating an internal combustion engine:

1) Black smoke issuing from the exhaust pipe means there is not enough air in proportion to fuel.

2) When an engine misses more explosions than it should, or backfires, the cause is likely to be too much air in the fuel.

3) If the mixture of fuel and air is in the proper proportion, but there is too little of it, the engine will have no power.

4) Premature ignition may be caused by deposition of carbon or soot on the walls of the cylinder; the compression being too high for the fuel used; overheating of the piston, or exhaust valve, or of some poorly-jacketed part.

5) Using too much or a poor quality of lubricating oil, or a mixture too rich in fuel, causes deposition of carbon on the cylinder.

6) The use of too much cylinder oil is indicated by a blue smoke issuing from the exhaust.

7) Pre-ignition, or a bearing out of order, or the engine not being securely fastened to its foundation, causes pounding.

8) Too much water in the oil used for fuel causes white smoke to issue from the exhaust pipe. This may be caused by a leaky jacket on gasoline engines.

9) Stop the engine by shutting off the supply of fuel. Open the switch to the ignition system. Close the lubricators and oil cups, and turn off the jacket water.

10) In cold weather, drain off the jacket water to prevent freezing.

11) Always leave the engine clean and in order to start again.

12) For safety, belts and wheels should be boxed in wherever possible.

Fig. 151 should be studied closely for a better understanding of the engine.

**271. Generating Electricity for Homes.** Water motors, kerosene, gas and gasoline engines are the sources of power commonly used to generate electricity for private homes. A device for generating electricity is called a dynamo (Fig. 152). The electricity generated is either used directly while the engine is running, or it is stored in storage batteries. From here it is conducted thru wires and used for lighting, heating and turning motors to do work.

**272. Batteries.** Batteries are used mainly where a small amount of current is needed, as on oil or gasoline engines, to make the spark to ignite the gasoline or oil, and in lighting gas and acetylene lamps, and for some door bells.

There are several kinds of batteries, as liquid, dry-cell and storage.

**273. Liquid Batteries.** In liquid batteries, electric current is generated by means of direct chemical action between

an acid and two other substances, one more easily attacked by the acid than the other (Fig. 153), such as zinc and copper. This forms a simple cell, one form of primary battery. When the chemicals and metals in a primary battery are exhausted, they can be replaced with new metal or solution.

**274. A Dry-Cell Battery.** A dry-cell is another form of

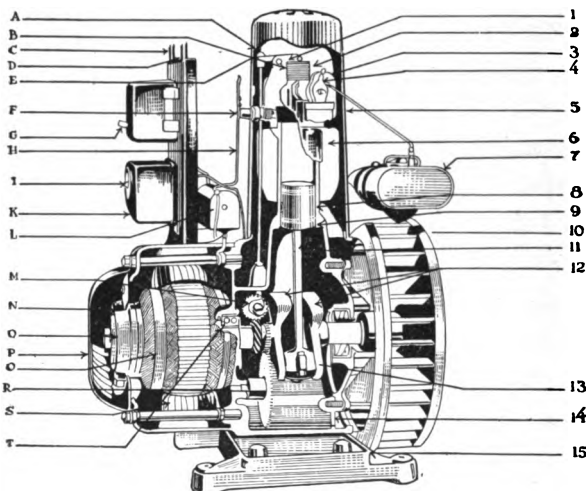

FIG. 152. Electric generator.

battery. In these, the moisture of the acid substance is absorbed by some material like plaster-of-Paris flour or blotting paper, so that it can act on the metals or carbon in the cell and still make a cell easily transportable. The absorbed moisture in dry cells slowly evaporates, and then they become worthless. These batteries are usually thrown away after they have been used and have ceased to generate electricity.

**275. Storage Batteries.** Storage batteries differ from primary batteries in that current must be supplied to them

from some outside source, such as a dynamo. They can be recharged again after the current in them has been used (Fig. 154).

The engines for private homes where a light plant is used are adjusted to charge batteries at the proper rate—but the

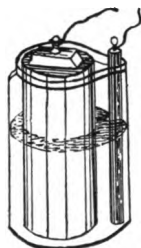

FIG. 153. Primary battery.



FIG. 154. Storage battery.

owner should charge these batteries at regular intervals. They can be charged only by direct current.

Never allow the storage battery to run down to a voltage lower than 1.15 per cell. This reading is taken from the voltmeter supplied with the plant.

Storage batteries should be tested by a hydrometer for the specific gravity of the electrolyte or liquids in them. Instructions for this and for correcting the specific gravity accompany the plant. Take care to preserve them.

Dynamos for home use are almost automatic. Run the dynamo to renew the batteries when using electric irons or other devices calling for more current than the lighting fixtures. Each plant is designed to carry a certain load of equipment. Exceeding this, damages the plant.

Place electric motors and dynamos in a dry, cool, clean place.



**276. Some Uses for Electric Motors.** Motors are now used on sewing machines, washing machines, dish washers, vacuum cleaners, wringers, fans, refrigerating systems, pumps, grinders, freezers, churns and separators. They are made either for direct or alternating current. When purchasing a motor, be sure to designate the type of current with which it is to be used. Select motors of the right size to operate the machine. It costs more to operate a large motor on a small device than a small motor.

**277. Definition Tables.** A British thermal unit is the amount of heat required to warm one pound of water one degree Fahrenheit.

The flash point of an oil is that temperature at which it will form an inflammable vapor. The accompanying table shows amount of heat generated from a number of sources.

The total heat in a gallon of kerosene is greater than that in a gallon of gasoline because the kerosene is heavier than the gasoline. A gallon of gasoline will give on an average but about five-sixths as much total heat as a gallon of kerosene. This is approximately true, whether the heaviest grades of kerosene are compared with the heaviest grades of gasoline, or the lightest grade of kerosene is compared with the lightest grade of gasoline.

Distillate is the refuse left from the distillation of petroleum.

The flash point of kerosene may be between 70 and 150 degrees Fahrenheit, depending upon the grade. For illuminating purposes, do not use kerosene with the flash point lower than 120 degrees Fahrenheit.

The flash point of gasoline is 10 to 20 degrees Fahrenheit;

that is, gasoline will form an inflammable vapor at temperatures as low as this.

Between 60 and 70 per cent of the common fuels are utilized in the generation of steam for heating purposes.

TABLE SHOWING GENERATION OF HEAT

AMOUNT	FUEL	B. T. U.
1 lb.	Anthracite coal	13,200-13,900
1 lb.	Bituminous coal	12,000-15,000
1 lb.	Lignite coal	8,500-11,400
1 lb.	Wood	8,200- 9,200
1 cu. ft.	Natural gas	900- 1,000
1 cu. ft.	Illuminating gas	500- 600
1 lb.	Kerosene	18,000
1 lb.	Alcohol	12,000
1 lb.	Gasoline	19,000
1 K.W.-hr.	Electricity	3,400

\*One pound ice in being melted will absorb 144 B. T. U .

## CHAPTER XXXIX

### GAS PLANTS

**278. Gasoline-Gas Plants.** Gasoline-gas plants are devices for generating gas from gasoline. The gas is a mixture of air and gasoline vapor. It is made by air being forced thru gasoline. There are small plants which can be installed in

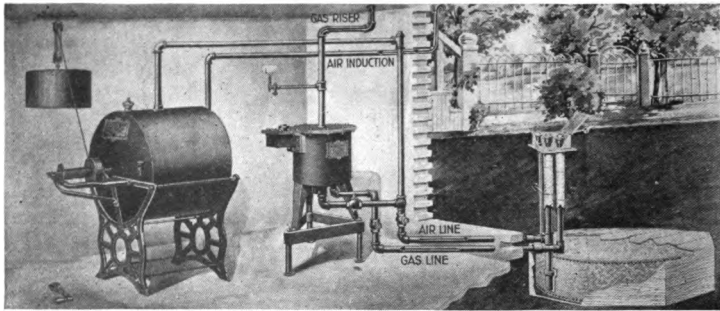

FIG. 155. Gasoline gas plant.

private homes (Fig. 155). Gasoline vaporizes at ordinary temperature. The vapor or gas produced can be used for heating, lighting and running gas engines.

One gallon of gasoline, when entirely vaporized, produces about thirty-two cubic feet of gas. Its heating power depends upon the character of the gasoline utilized and the temperature at which it is kept during vaporization.

The plant is a device for forcing air thru the gasoline to make it vaporize as fast as wanted. Combined with the carburetor is a storage tank for the gas. A weight, or water motor, furnishes the power most commonly used in forcing the

air thru the gasoline and forms a part of the plant. Air cannot flow thru the gasoline when the storage tank is full of gas so that the power is only in operation when the gas is being used or the tank is not quite full.

**279. Acetylene-Gas Plant.** Acetylene is often used in rural homes when gas or electricity are not available. The

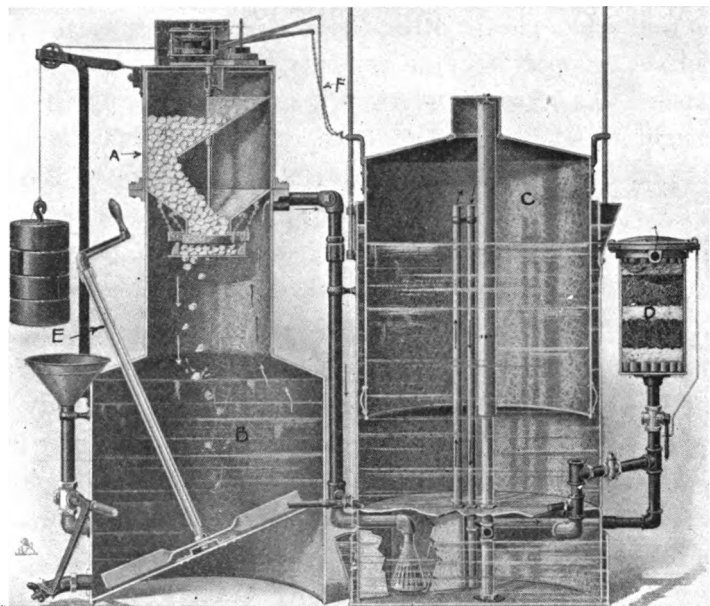

FIG. 156. Acetylene gas plant.

operation of the plant often has to be attended to by a member of the family. A capable woman can do this, but she must be careful and must thoroly understand the plant (Fig. 156).

The materials used in making acetylene are calcium carbide and water. Calcium carbide (A, Fig. 156) is made from lime

and coke fused together in an electrical furnace. It must be kept stored in a dry place.

The plants for making acetylene are inexpensive enough to be installed in individual homes of moderate means. Calcium carbide for making the gas can be transported without difficulty.

There are two types of machines. In one the water drips on the carbide; in the other, the more common type, the carbide is dropped into the water. As soon as the carbide touches the water, it gives off acetylene gas. The gas is caught in and fills a bell above the water. As it fills the bell, it raises it, and when the bell reaches a certain height, it trips a lever to the door which lets in the carbide and closes it. When the gas is used, the bell goes down and, passing the lever, opens the door to let in a small amount of carbide.

Improvements have been made in the plants and in installing them until there is less danger from explosions than formerly. Great care should be taken in operating them to avoid accidents. Since the gas is highly explosive, fire, lighted lamps and cigars must be kept away from the vicinity of all acetylene plants. Only one person should take the care of the plant, tho others should understand how.

#### **280. Directions for Operating Acetylene Plant.**

- 1) Charge by daylight—remove all residuum, and fill with fresh water before adding any carbide.
- 2) Follow exact directions for the machine used in the order directed.

#### **281. Cautions to Be Observed in Using Acetylene Gas.**

- 1) Do not apply a light to any opening that is not equipped with a regular acetylene burner tip.

2) See that any workman repairing a generator first removes carbide and drains all water out, and disconnects it from piping and removes it to the open air, where he then fills all compartments with water to force out gas before using soldering irons.

3) An open light should never be permitted nearer than ten feet from the generator. The generator should never be nearer than fifteen to twenty feet from furnace or stove. Do not hunt for gas leaks with a flame or light.

4) Do not use any artificial light except electric light when cleaning or repairing generator, or carry a lighted pipe or other fire about it, even when empty.

5) If water in any chamber should freeze, do not attempt to thaw it with anything but hot water.

6) Keep the motor oiled. Oil once in six months.

**282. Compressed Gases and Oils.** Gases, such as Blau gas, Pintsch gas, and prestolite gas which is compressed acetylene gas, are compressed in strong tanks and sold for use in lighting and light housekeeping. Gasoline and alcohol also are occasionally stored in very strong tanks under enough pressure to make them flow thru very small pipes to the point where they are wanted for use. These are frequently used for lighting isolated public buildings, such as rural school-houses.

As the gas or oil is used, the pressure diminishes. There is usually a pump attached to the tank to pump in air in order to keep up the pressure. The pump is similar to a bicycle pump (Fig. 157).



FIG. 157. Pressure tank for gas.

## QUESTIONS FOR PART X

1. What is the difference between the treadle and a motor-power machine?
2. How is power secured from water in a water motor? Or what is the source of power utilized by a water motor?
3. How do you determine the size of pulleys to use on the gasoline engine and on the device it is to operate?
4. What are some indications that a gasoline engine or automobile motor is not running properly?
5. What are the kinds of batteries, and to what uses is each best suited?
6. Do batteries need care? If so, what care?
7. How is acetylene gas made? Describe the device for making it.
8. How is gas for household use made from gasoline?

# PART XI

## MEASURING DEVICES

### CHAPTER XL

#### SCALES FOR WEIGHING

**283. Equal-Arm Balances.** Scales are devices for determining the weight of objects. Balances—one form of scales—are made of two arms of equal lengths and supplied with discs of metal of a known weight to be placed on one arm of the balance while the material to be weighed is put on the other. When the two arms are in equilibrium, the weight of the material is equal to the weight of the metal. Since the weight of the metal is known, or can be determined, by adding together the weights of the discs used, the weight of the material is known to be the same.

**284. Unequal-Arm Balances.** Equal-arm balances are not convenient for weighing large objects. For this reason, scales are made with one arm of the balance much longer than the other. The metal discs are then marked with the weight of the material on the short arm which they can balance when placed on the long arm. This is the usual form of counter and household balances. On these scales is also a weight which slides along the arm and is used to determine weights smaller than five or ten pounds. The arm of the balance is, therefore, marked at the point where this weight will balance certain amounts of material, such as half ounces, ounces and pounds.



**285. Spring Scales.** Spring scales depend on the action of a spring, to which an indicating pointer is attached. When there is no weight on the spring, the place to which the indicator points is marked zero. When these scales are manufactured, a pound weight is placed so that it pulls on the spring and the indicator is pulled down to another place, and this is marked one. Scales are thus marked for the number of pounds they are to weigh. The spaces between the pounds marked are divided into equal divisions, such as sixteenths which indicates ounces. These scales cannot be relied on for accuracy, for springs stretch or become weaker as they are used. Avoirdupois is the weight in common use for marketing, while many tables for calculating dietaries are in the metric system.

The housewife can have her balances corrected for weighing by the city or county sealer of weights and measures so that she can ascertain whether or not her food purchases are correctly weighed.

#### TABLE OF WEIGHTS

AVOIRDUPOIS	METRIC
16 oz.—1 pound	1 milligram— $1/1000$ .001 gram
100 lb.—1 hundred-weight	1 centigram— $1/100$ .01 gram
2000 lbs.—1 ton	1 decigram— $1/10$ .1 gram
0.035 oz.—1 gram (Metric system)	Gram—1 gram
	Dekagram—10 grams
	Hectogram—100 grams
	Kilogram—1000 grams
APOTHECARIES	
27-11/32 grams—1 dram	
16 drams—1 oz.	

## CHAPTER XLI

### DEVICES FOR MEASURING VOLUME

**286. Graduate and Measuring Cup.** Graduate holding up to four fluid ounces is helpful to use to check up liquids bought in bottles. The standard measuring cup referred to in modern cook books holds half a pint of liquid. It also holds about sixteen level tablespoonfuls of dry material such as sugar. The divisions on glass cups are less likely to be accurate than on metal ones, as the bottom may be thick or thin unless carefully made. In selecting a cup, see that the bottom section is equal to the other sections.

1 cup = 2 gills =  $\frac{1}{2}$  pint = 16 tablespoons =  
48 teaspoons = 8 fluid ounces.

1 cup is also  $\frac{1}{4}$  of a quart and about  $\frac{4}{17}$  of a liter.

**287. Tablespoons.** Tablespoons vary in size. The size chosen for measuring is the one in most common use and holds about three level teaspoonfuls of material like sugar or flour.

1 tablespoon = 4 drams of liquid = 3 teaspoons.

4 tablespoons =  $\frac{1}{4}$  cup = 2 fluid ounces.

**288. Teaspoons.** Teaspoons vary in size, but the spoon in common use is the one understood as the measure in cookery. It holds about one and one-third fluid drams.

**289. Standard Measuring Spoons.** Standard measuring spoons in sets can be purchased at a very moderate

price. They are particularly valuable for checking the capacity of the spoons more commonly used.

### 290. Liquid and Cooking Measures.

1 teaspoonful=	1-1, 3 fluid drams
3 teaspoonfuls=	1 tablespoonful= 4 drams
2 tablespoonfuls=	1 fluid ounce
1, 2 cup=	1 gill
2 gills=	1 cupful= 8 fluid ounces
16 tablespoonfuls=	1 cupful
2 cupfuls=	1 pint
2 pints=	1 quart= 4 cupfuls
4 quarts=	1 gallon
4.23 cupfuls=	1 liter
1000 cubic centimeters=	1 liter
1.06 liquid quarts=	liter
31-1/2 gallons=	1 barrel
1 milliliter=	one-thousandth (.001) liter
1 centiliter=	one-hundredth (.01) liter
1 deciliter=	one-tenth (.1) liter
Liter=	1 liter
1 dekaliter=	ten (10) liters
1 hectoliter=	one hundred (100) liters
1 kiloliter=	1 thousand (1000) liters

**291. Dry Measures.** It is wise for a housewife to have a set of dry measures, consisting of a pint, quart, gallon, peck and half-bushel measure. A quart or gallon liquid measure is not equal to the dry one. It holds less. The diameter of dry measures should be as follows:

#### DIAMETERS OF DRY MEASURES

MEASURE	*DIAMETER
1 pint	4 inches
1 quart	5-3/8 inches
2 quarts	6-5/8 inches
1/2 peck	8-1/2 inches
1 peck	10-7/8 inches
1 bushel	13-3/4 inches

\*These diameters allow for proper heaping.

**\*DRY MEASURE**

2 pints=1 quart  
 8 quarts=1 peck  
 4 pecks=1 bushel  
 1 sack of flour=24-1/2, 49 or 98 pounds  
 4 49-pound sacks of flour=1 barrel  
 1 barrel of flour=usually 196 pounds  
 60 pounds of potatoes=usually 1 bushel

\*State laws differ somewhat regarding the number of pounds in a bushel of various fruits and vegetables.

**292. Cubic, Square and Linear Measure.****CUBIC MEASURE**

1728 cubic inches=1 cubic foot  
 27 cubic feet=1 cubic yard  
 128 cubic feet=1 cord

**SQUARE MEASURE**

144 square inches=1 square foot  
 9 square feet=1 square yard  
 30-1/4 square yards=1 square rod  
 160 square rods=1 acre  
 640 acres=1 square mile

**LINEAR MEASURE**

12 inches=1 foot  
 3 feet=1 yard  
 5280 feet=1 mile  
 39.27 inches=1 meter

**METRIC MEASURES**

Millimeter=one-thousandth (.001) meter  
 Centimeter=one-hundredth (.01) meter  
 Decimeter=one-tenth (.1) meter  
 Unitemeter=1 meter  
 Dekameter=ten (10) meters  
 Hectometer=one hundred (100) meters  
 Kilometer=1 thousand (1000) meters

## CHAPTER XLII

### GAS, WATER, AND ELECTRIC METERS

**293. Different Kinds of Meters.** The housewife has need to be familiar with three kinds of meters—water, gas and electric. These are devices for measuring water, gas or electric current.

**294. Construction of a Gas Meter.** The interior of one type of gas meter (Fig. 158) is somewhat like a water

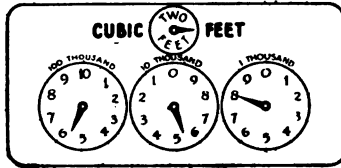

FIG. 158. Gas meter.

wheel—the pressure of the gas pushes the wheel around. Every time a compartment full of gas passes a certain point, the gas flows out and the flange on the wheel trips a lever which moves the hand of the dial ahead, thus counting the emptying of the compartment. The gas in the compartment back of this then moves to this place. The emptied compartment is filled with more gas as it passes the inlet.

**295. Reading the Gas Meter.** A gas meter is a device for measuring the number of cubic feet of gas which flows thru a pipe. Small dials with the numbers from one to ten and a hand for an indicator show the number of single feet, tens of feet, and thousands of feet, which have passed thru

the meter. The reading on any date is the total amount of gas which has passed thru. To tell how much has passed thru the meter during any period of time, take the reading of the meter on the first date, as indicated in Fig. 158, and then take the reading on the later date and subtract reading one from reading two—the resulting figure is the amount of gas passing thru the meter between these two dates. When buying gas, always keep the readings of meters at the time when the gas man takes them. Gas meters often register more or less gas than is actually consumed. Gas companies are allowed a variation or tolerance of one per cent fast or slow, to two per cent fast or slow. Gas is paid for at a stated rate per thousand feet in most places.

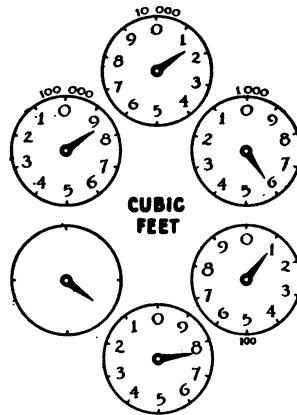

FIG. 159. Water meter.

**296. Water Meters.** The water meter (Fig. 159) is a device for measuring the number of gallons or cubic feet of water which pass thru a pipe. The reading of the meter indicates the total amount of water which has passed thru the pipe since the meter was installed. Water is paid for, unless purchased at a flat rate, at so many cents a thousand gallons or thousand cubic feet. One cubic foot is called in commercial transactions  $7\frac{1}{2}$  gallons.

**297. Prepayment Meters.** Prepayment meters are devices which will permit a certain amount of gas or water, as the case may be, to pass thru a pipe, and after this amount is

used up, the pipe is automatically closed so that no more flows until more money is put into the meter. The weight of the coin works the valve.

**298. The Electric Meter.** Electricity is usually purchased by the kilowatt hour, and measured by the watt-hour

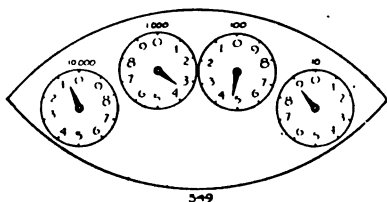

FIG. 160. Electric meter.

meter (Fig. 160). This measures the current passing thru it, and the number of kilowatt-hours is shown by the indicators on the little dials. Start from left and read the number on the dial, such as in the illustration, 3 hundreds 4 tens 9 units, making 349 kilowatt-hours; the total kilowatt-hours used since the meter was installed. To find the number used between two dates, take the reading of the meter on the first date and subtract it from the reading on the second date. The difference is the amount

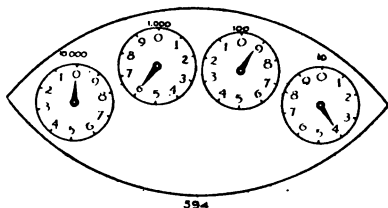

FIG. 160-a. Electric meter showing different readings.

used during the period. Good business women keep records of the readings of their meters. Care must be taken to read the meter correctly. The hand next higher than the one below may read too high. The higher hand may, if out of alignment, pass the figure when the lower hand approaches the ninth point in its dial, this causing the person to read the figures one, ten, hundred or thousand units too much. (Fig. 160-a.)

## CHAPTER XLIII

### THERMOMETERS AND THERMOSTATS

**299. Mercury Thermometers.** There are two kinds of thermometers in use—the Fahrenheit and the Centigrade. Since the thermometer is used now in cooking, the housewife often has to meet the problem of translating temperatures from one to the other.

The centigrade thermometer is marked on the assumption that the temperatures of boiling water and freezing water are constantly the same. The boiling point is marked 100, and the freezing point 0. The space in between is marked into even divisions and numbered 1 to 99.

The Fahrenheit thermometer was made on the assumption that a mixture of ice and salt was the coldest temperature that could be reached, so this temperature of a certain proportion of ice and salt was marked zero.

The hundred point was given to what was supposed to be the normal body temperature. The intervening spaces were marked into equal divisions, and these divisions were carried below 0 degree and above 100 degrees. The boiling temperature of water came at 212 degrees Fahrenheit, and the freezing point at 32 degrees. This makes 180 degrees difference between thawing and freezing and boiling. So 100 degrees Centigrade equal 180 degrees Fahrenheit. Therefore, 1 degree Centigrade equals  $\frac{9}{5}$  degrees Fahrenheit, and 1 degree Fahrenheit equals  $\frac{5}{9}$  degree Centigrade.



For example, if 40 degrees Centigrade is to be translated into Fahrenheit degrees, first multiply 40 by 9 = 360, then divide by 5 = 72, and add 32, because 0 degree Centigrade is the same as 32 degrees Fahrenheit, and the result is 104 degrees Fahrenheit equal 40 degrees Centigrade. If 41 degrees

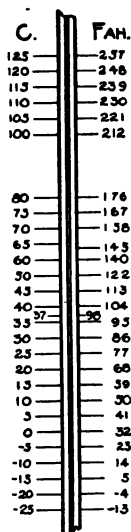

Fahrenheit is to be translated into Centigrade degrees, first subtract 32 from 41 = 9, then multiply by 5 = 45, and divide by 9, and the result is 5 degrees Centigrade = 41 degrees Fahrenheit. Fig. 161 is a diagram showing relative readings of Fahrenheit and Centigrade thermometers.

**300. Oven Thermometer.** Some oven thermometers depend on the expansion of metal to indicate the temperature. A hand on the clock-like face of these indicators shows the degree of heat. Few of these give the actual temperature, but they do indicate a slow, a moderate and a hot oven.

FIG. 161. Comparison of Centigrade and Fahrenheit.

**301. Maximum Thermometers.** A maximum thermometer is one in which the mercury rises to register the maximum amount of heat to which it has been subjected. It stays at this height when the temperature falls, until it is shaken back.

It is sometimes used in ovens to ascertain the temperature they have reached before the oven door is opened.

TABLE OF TEMPERATURES USEFUL TO HOUSEKEEPERS  
OVEN TEMPERATURES

	FAH.	CENT.
Slow oven.....	250-350	121-177
Moderate.....	350-400	177-204
Hot or quick.....	400-450	207-232
Very hot.....	450-550	232-287

## SYRUPS

	FAH.	CENT.
Thin.....	219-	104-
Medium—fondant.....	236-240	113-115
Thick—fudge.....	-240	115-
Heavy—taffy.....	-300	149-
Clear brittle.....	-310	150-
Carmel almond and nut brittle.....	-315	157-

## MISCELLANEOUS

	FAH.	CENT.
Incubators.....	103	39.4
Body temperature.....	98-99	37
Room temperature.....	-86	20-30
Refrigerator temperature.....	44-59	5-15
Churning.....	52-62	11-17
Growth of bacteria retarded.....	35-70	.....
Growth of bacteria most rapid.....	70-100	.....
Most bacteria are killed.....	212	.....
Downward, markedly. Growth of bacteria retarded.....	45	.....

**302. Thermostats.** Thermostats are devices which open or close valves or dampers in order to keep rooms, boilers, ovens, incubators, etc., at an even temperature. All metals expand on being heated, and contract on being cooled.

Some expand more than others. Two materials which expand at different rates are frequently used in making thermostats. Any certain temperature causes a given piece of metal to expand to a certain size, or to contract on cooling to a different size. Some thermostats are made of a straight rod of metal like copper which expands more than iron when heated. The rod is so placed that when cool it will allow fuel like gas or oil to pass thru a pipe, and when heated, it will expand enough to close the pipe, shutting off the fuel. They are placed so that they close the pipe at the temperature desired for an oven or supply of hot water.

Other thermostats are more complicated, as the expanding metal moves a series of levers. These thermostats are used to regulate dampers on coal and wood furnaces, when they are placed in the rooms to be heated. They are often used on other devices, such as incubators.

Still others control an electric current. When the metal expands, it closes the circuit, causing the electricity to do the work desired. When it contracts, it opens the circuit. Thermostats can be set to do work at different temperatures.

These are sometimes attached to clocks which, with a device similar to the alarm, will change the indicator of the thermostat so as to set it from one temperature to another at a stated time for which the clock is set and turn it back at another hour.

## CHAPTER XLIV

### HYDROMETERS AND BAROMETERS

**303. Hydrometer.** A hydrometer is used in gaging the density of liquid. This instrument consists of a closed glass tube which is enlarged at the lower end and filled with some heavy material like mercury or shot, to keep it in an upright position when in liquids.

The tube or stem contains a paper on which divisions called degrees are marked. The 0 mark is usually the point reached by the surface of distilled water when the hydrometer is placed in this liquid. The less the density of the liquid, the lower the hydrometer sinks, for it displaces an amount of liquid equal to its own weight. The density of the liquid then can be determined by observing the mark to which it sinks. Specific-gravity hydrometers used in the household show the ratio of the weight of a given volume of liquid to the weight of the same volume of water at a definite temperature. Arbitrary scale hydrometers are used to indicate the concentration or strength of syrup, brines or milk. These are defined as lactometers and Baume hydrometers. A brine hydrometer is called a saltometer, and a syrup gage a sacchrometer. A jellometer, especially for making jelly, is sometimes used instead of a sacchrometer. The scale on this tells how much sugar to use in proportion to the amount of solids in the fruit juice without having to refer to a table. Some hydrometers are constant-volume hydrometers, and on these weights are placed always, to sink the hydrometer to the same depth in the liquid.

**TABLES FOR BRIX AND BALLING HYDROMETERS WHEN  
USED AT 20° C.\***

READING ON THE HYDROMETER Degrees	SUGAR TO A QUART OF FRUIT JUICE TO MAKE JELLY	
	Pounds	Ounces
5.	.....	8.
5.5	.....	9.
6.0	.....	9.6
6.5	.....	10.7
7.0	.....	11.6
7.5	.....	12.4
8.0	.....	13.2
8.5	.....	14.1
9.0	.....	15.0
9.5	.....	15.8
10.0	1.	7.0

\*When the reading for the fruit juice is determined the table shows how much sugar is used for juice of that specific gravity.

**TABLE SHOWING AMOUNT OF SUGAR PER GALLON**

READING ON THE HYDROMETER Degrees	SUGAR TO A GALLON OF WATER	
	Pounds	Ounces
0.	.....	0.0
5.	.....	7.0
10.	.....	14.8
15.	1.	7.5
20.	1.	14.75
25.	2.	12.5
30.	3.	9.0
35.	4.	7.75
40.	5.	8.75
45.	6.	13.00
50.	8.	5.25
55.	10.	4.00
60.	12.	8.0

In the second table the readings show the specific gravity of the syrup, and from that may be ascertained the proportion of sugar to a gallon of water in it.

A 250 cc. cylinder, or other tall vessel deep enough to float the sacchrometer, is suitable for making the measurements. Be sure to have the eye on the level of the liquid when making the readings. If no sugar is in the water, the reading on the hydrometer will be near zero. If there is sugar in the proportion of seven ounces to a gallon of water, the reading will be at the line marked 5.

#### SYRUPS FOR CANNING

Berries	—30 degrees, or 3½ pounds of sugar to 1 gallon of water
Sweet cherries	—30 degrees
Sour cherries	—40 degrees
Peaches	—30 to 40 degrees
Pears	—20 to 30 degrees
Plums	—40 degrees

**304. Hygrosopes.** Hygrosopes are devices for measuring humidity. Forty-five to sixty per cent humidity is desirable in a house. This means forty-five to sixty per cent as much water as the air is capable of taking up at room temperature. Cold air is usually dryer than warmer air because cold air cannot take up as much humidity as warm air. This is analogous to the fact that warm water will dissolve more of some salts or of sugar than cold water.



FIG. 162. Barometer.

**305. Barometers.** Barometers (Fig. 162) are devices which show changes in pressure and currents of air. Changes in the barometer usually indicate changes in the weather, and

thus they are of interest to all persons. A decided fall in the mercury of a barometer usually precedes foul weather, while a rise indicates the approach of fair weather. When the pressure is low in any locality, air begins to rush toward that point as it would to fill a vacuum. So a fall in the barometer precedes the coming of a high wind or a rainstorm. A rise in the barometer precedes a calm, and since most rain is accompanied with wind, the calm is a time of fair weather.

# INDEX

	Page		Page	
<b>A</b>				
Absorption of heat and light	84, 85, 108	Baume hydrometer	237	
Acetylene	30, 49, 81, 91, 92, 145, 221, 222, 223	Bearing	152	
Acids	155, 156, 157, 159, 216	Beater	165	
Acre	229	Bell for storing gases	222	
Adjustment of burners, stove	24, 29, 30, 32, 34, 41, 49, 78, 79, 80	Bellows	148, 149	
Air, for circulation	57, 76, 101, 102, 103, 111, 198	Belts	136, 137, 141, 186, 215	
dead or stagnant	63, 102	Bituminous coal	219	
for combustion	16, 29, 31, 38, 39, 48, 66, 88, 93, 214	Blau gas	223	
for evaporation	105, 176, 220, 221	Bobbin	187, 188, 189	
for heating	19, 55, 60, 61, 62, 63, 73, 75, 79	Boiler	64, 69, 71, 73, 132, 133, 156	
in radiator	67, 68, 70	Booster	119	
mixer	23, 24, 25, 33, 77, 96, 144	Bracket, curtain	185	
moisture	239	Brine for cooling	108	
for pressure	97, 112, 113, 114, 175, 176, 184	British thermal unit	218, 219	
shaft	57	Brix hydrometer	238	
whistling	56	Broiler	26	
Alcohol	47, 48, 89, 96, 97, 98	Brush	147, 149, 150, 152	
145, 223		Bunsen burner	77, 78, 81	
Alkalies	155, 157	Burner	48, 96, 119, 141, 145, 198	
Alternating current	110	gas		
Aluminum	78, 156, 157, 158, 171, 172	23, 25, 27, 29, 77, 78, 88, 91, 144		
Ammonia	108, 138	kerosene	32, 33, 36, 37, 40, 80, 94	
Ampere	82	Burning back	27, 89, 90, 91	
Andiron	74	Burr grinder	162	
Anthracite coal	219	Bushel	228, 229	
Asbestos	32, 66, 77, 81	<b>C</b>		
Ash chute	22	Calcium carbide	221, 222, 223	
Ashes	20, 57, 66, 74, 75, 76	Candle power	84, 89, 91, 95	
Automobile	192	Canned heat	48	
<b>B</b>				
Back-fire	192, 214	Canner	172, 173	
Bacteria	100, 101, 127	Can sealer	175	
Balances	225	Capillary attraction	47, 48, 93, 106	
Balling hydrometer	238	Carbolic acid	126	
Barometer	239, 240	Carbon	82, 83, 84, 214	
Barrel	167, 228, 229	Carbon dioxide	67, 108	
Basin, catch	127	Carburetor	29, 192, 220	
Battery	192, 193, 194, 215, 216	Carpet sweeper	147, 148, 150	
		Cast aluminum	156	
		Cast iron	155, 156	
		Catch basin	127	
		Centigrade thermometer	233, 234	
		Centigram	226	
		Centimeter	228, 229	
		Centiliter	228	
		Centrifugal dryer	138, 139, 140	
		force	139	
		washer	135, 136	



	Page		Page
Cerium	88		
Cesspool	124		
Charcoal filter	114		
Chain stitch	186		
Cherry stoner	161, 162		
Check valve	71, 183		
Chimney	18, 31, 33, 57, 59, 74, 75, 80, 93, 94, 111		
Chloride of lime	126		
Choker	192		
Chopper	162, 163		
Churns	165, 167, 235		
Cistern	114		
Clamp	138		
Cleaning	25, 35, 127, 172		
Cleaning equipment	147, 148, 149, 150, 152, 153		
Clinkers	76		
Clock	236		
Clutch	192		
Coal	20, 28, 66, 76		
Coffee mill	162		
pot	167, 168		
Cog wheels	165		
Coils	64, 78, 80		
Coke	222		
Cold-process gasoline-gas	29, 91, 145		
Color and illumination	84		
Compressed-air pump	113, 115, 117		
Combustion	16, 17, 23, 24, 58, 66, 74, 76, 77		
Conductivity of materials	156, 157, 158		
Contraction of materials	235		
Cookers	50, 51, 55, 56		
Coolers	105, 106, 108, 109		
Copper	158, 216, 236		
Crank	163		
Cream separator	178, 179		
Cubic measure	229		
Cup, measuring	227, 228		
Current, electric	42, 46, 80, 83, 86, 110, 143, 144, 215, 218, 232		
Curtain roller	185		
Cylinder	112, 113, 211		
washer	133		
		<b>D</b>	
Dampers	16, 17, 18, 19, 20, 22, 58, 61, 66, 74, 75, 197, 198, 235, 236		
Decomposition of sewage	124, 125, 127		
Degree	233, 234		
Dekagram	226		
Dekaliter	228		
Dekameter	229		
Dermax	206		
Density of liquids	237		
Direct current	110		
Direct lighting	85		
Dish-washer	170, 171		
Disinfectant	126, 200		
Distillate	40, 218		
Dolly washer	134		
Doors	103, 183, 184, 185, 215		
Drafts	16, 17, 18, 19, 57, 58, 59, 74		
Drain	103, 104, 122, 138		
Dram	226, 228		
Drip pipe	102, 103		
Drip sheet	25		
Dryer	171, 176		
Dry-cleaning equipment	140		
Dry-cell battery	215, 216		
Dulling of edges	159, 163		
Dumbwaiters	183		
Dust	76, 78, 80, 148, 150		
Dynamo	215, 216		
		<b>E</b>	
Earthenware	107, 156		
Egg tester	201		
Electric appliances	42, 44, 46, 81		
heating	42, 43, 80, 119		
measurements	43, 82, 230, 232		
Electric motors	217		
Electricity	215, 219		
Electrolyte	217		
Enameled ware	157		
Engine, gasoline	137, 212		
Evaporation	67, 105, 106, 140		
Exhaust pipe	212, 214		
Expansion of materials	108, 234, 235		
tank	66, 67, 120		
valve	70		

	Page		Page
Explosions, prevented	25, 35, 37, 39, 69	Gasoline	
utilized	192, 214, 222	burner	37, 96
Extractor	139	engine	119, 137, 212, 215
		Gasoline-gas	29, 37, 91, 220
		Gears	192
<b>F</b>		Generation of heat and gas	219, 220
Fahrenheit thermometer	233, 234	Generator	96, 97, 145, 223
Fan	110, 148, 177	Gill	227, 228
Fastener, door	184	Glass utensils	156, 157, 158
Faucet	109, 114, 116, 119, 120, 122	Graduate	227
Feed plate	187, 188, 189, 207	Gram	226
Filament for lamp	83	Granite ware	156, 157
Filter, water	114, 116, 168	Grate	16, 58, 65, 74, 76
Fire	18, 19, 34, 41, 66, 75	Grater	160
Fireless cooker	50, 51	Gravity lamp	96
Fireplace	74, 75	Gravity, specific	217, 237, 239
Fire-pot	20, 57, 58, 65, 76	Grinder	159, 162
Flame	23, 35, 38		
Flame, blue	31, 38, 49, 96	<b>H</b>	
illuminating	77, 78, 88, 89, 93, 94	Heat	29, 48, 89, 156, 158, 218
Flash point	218	production of	42, 140, 143, 200, 219
Flat-iron	142	use of	45, 50, 57, 69, 78, 80, 140, 143, 176
Floot for flushing tank	129, 130	Heater	65, 77, 79, 80, 81, 118, 119, 135
Flue	66, 77		141, 143, 196, 197
Force pump	113, 117, 119	Hectograph	205, 206
Freezer	166, 167	Hectoliter	228
Freezing	68, 112, 126, 166, 233	Hectometer	229
Friction, danger from	140	Hinge	184, 185
Fuel	16, 58, 65, 76, 88, 119	Homogenizer	180
economical use of	19, 20, 28, 59, 66	Horse power	210
Funnel	133, 167, 168	Hot-water furnace	64
Furnace	57, 62, 63, 64, 75, 222	Hot-water tank	117
Fuses	43, 46, 86, 144	Humidity	239
		Hundred-weight	226
<b>G</b>		Hydrometer	217, 237, 238, 239
Gage	67, 69, 70, 73, 117	Hygroscope	239
Gage, steam	72, 173		
Gallon	228	<b>I</b>	
Gas		Ice	100, 101, 102, 103, 104, 166, 219
26, 34, 35, 36, 37, 38, 40, 58, 88		Iceless refrigerator	105, 106
108, 192, 199, 214, 215, 219		Incubator	196, 201, 235
221, 230		adjustment of	199
burners	77, 79, 90, 144	Ignition of gas	140, 214, 215
consumption	23, 28, 29, 66	Illumination	28, 77, 78, 82, 84, 85, 88, 218, 219
formation	96, 97, 98	Inch	228, 229
kinds of	29, 91, 220, 222, 223	Ink	205, 208
Gasoline		Insulation	19, 46, 50, 55, 57, 66, 102
89, 97, 99, 140, 219, 223			

	Page		Page
Iron	155, 156, 158, 236	Lock-stitch	186, 188
Ironing board	144	Lubrication	193
Irons	142, 144, 145, 146		
<b>J</b>			
Jars, fruit	176	Mangles	141
Jellometer	237	Mantles for lamps	
Jugs	107	88, 89, 90, 91, 95, 98	
<b>K</b>			
Kerosene lamps	93, 95	Manufactured gas	78, 89, 91
oil	28, 138, 219	Maximum thermometers	234
stoves	31, 79, 80	Mazda lamps	82, 83, 84
Kisselguhr filter	114	Measurements	225
Keyboard	202, 204	Melting ice	103
Kilogram	226	Metal, conductivity of	156, 158
Kiloliter	228	Meter	229, 230, 231, 232
Kilometer	229	Microbes, septic	126
Kilowatt	82, 232	Mile	229
Kneading machine	165	Millimeter	226
Knives	159, 163, 196	Milliliter	228
Knocking, cause of	71, 214	Milligram	226
<b>L</b>			
Lard press	163	Mimeograph	206
Lamp, adjusting burners		Mixer	165
89, 90, 93, 94		Moisture	200, 239
electric	82, 83, 84, 87	Mop wringer	154
gas or oil		Motor	
91, 92, 94, 95, 96, 196, 198, 199, 215		108, 110, 133, 150, 186, 192, 209	
Laundry tubs	127	care of	214, 217
Lawn mower	195	water	137, 209, 210, 211, 220
Lava tip	89	Mower	196
Leather, preventing shrinking of	112	Multigraph	206, 208
Lever	72, 154, 163, 190, 236	<b>N</b>	
Light	83, 84, 85, 86, 98	Natural gas	30, 89, 219
Lights	82, 88, 98	Needle	187, 188, 191
Lighters	28, 91, 215	Nickel	158
Lighting, lamps	89, 90, 94, 95	Nozzle	148, 149
stoves		<b>O</b>	
25, 27, 33, 34, 37, 38, 78, 79, 80		Oil	31, 93, 110, 200, 214, 218, 223
Lighting plants	86, 114	Oil cups	33, 35
Lime	221	Oscillating washer	134, 135
Lining refrigerator	101	Ounce	226, 228
Lignite coal	219	Oven	19, 20, 26, 27, 42, 235
Liquify, sewage	124, 125	Overflow	67, 119, 120, 122, 130
Liquids	237	<b>P</b>	
Liter	227, 228	Packing	112, 122
Locomotive washer	135	Pans	155, 156
Logs, gas	78	Parers	159, 160
		Peck	228, 229
		Percolator	168
		Pet cock	174, 175
		Pilot light	26, 27, 119

	Page		Page
Pint	227, 228, 229	Revolutions of motor wheels	137
Pintsch gas	223	Ribbon, typewriter	203, 208
Pipe, stove	58, 60, 61, 62, water or steam 64, 66, 69, 70, 72	Roller	138, 141, 142, 154, 162
Pipes	67, 78, 102, 103	Rotary washer	134
Pipeless furnace	63		
Piston	112, 148, 211, 214	<b>S</b>	
Pivot	166, 167, 209	Saccrometer	237, 239
Plate, mower	195	Sack, flour	229
Plug, electric	143, 144	Sadirons	142
Plumber's pump	123	Safety devices	45, 56, 71
Plumbing system	115, 117	Safety valve	72, 79, 117, 119, 174, 175
Pneumatic hinge	184	Salt	157, 166
lamp	96	Saltometer	237
Porcelain filter	114	Scales	226
Pots	155, 156, 167, 168	Scissors	196
Pound	72, 226	Screw	163
Power	82, 209, 210, 214	Seal for sewer pipe	123
Prepayment meter	231	Seeder	159, 161
Press	163	Semi-indirect light	86
Pressure		Separators, cream	178
72, 73, 78, 79, 82, 117, 137, 138		Septic tank	124, 125, 127
146, 164, 171, 173, 209, 223		Sewage	124, 125, 126
Pressure, air	96, 97, 176	Sewer	124, 127, 128
gauge	69, 117	Sewing machine	186, 191, 209
Prextolite gas	223	Shaft	159, 186, 187, 202, 204, 209
Pulley	137, 185, 212	cold-air	57, 60, 63
Pump		Shears	196
108, 112, 113, 117, 123, 148, 168		Sheet iron	155, 156
169, 209, 223		Shutter, furnace pipe	60
		Shuttle, sewing machine	188
<b>Q</b>		Silicon	158
Quart	227, 228	Silver	158, 171
		Simmerer	30
<b>R</b>		Siphon	125, 129
Rack for canner	172	Slicer	159, 163
Radiation of heat	57, 61, 62, 79	Smoke	
Radiator	64, 68, 69, 70, 71	16, 20, 32, 34, 36, 57, 59, 66, 73	
Radiator, gas	77, 78, 79	74, 80, 89, 146, 214, 215, 246	
Reading meters	231, 232, 238, 239	Socket, electrical	143
Reflector	77, 78, 80, 81	Soot	17, 20, 32, 39, 66, 75, 78, 214
Refrigerating plant	108	Sparks, electric	110, 144
Refrigeration, principles of	100	Specific gravity	217, 237, 239
Refrigerator		heat	156, 158
100, 101, 102, 103, 104, 105		Speed by use of wheels	165, 212
Register	60, 62, 75	Spiral	163
Regulation, heat and pressure		Spoons	157, 158, 227, 228
20, 60, 66, 70, 72, 73		Spring	59, 184, 185, 226
Regulation of stoves	24, 43, 44, 48	pulley	183
Regulator, temperature	198, 199	Steam	71, 79, 111, 133, 175, 219
Reservoir	18	pressure	69, 70, 72, 73, 174, 175
Resistance produces heat	143		

	Page		Page
Steam		Thumb-screw	138, 174
cooker	56	Time for cooking food	54
valves and gages	70, 72, 73, 173	Timer	193
Steel for cooking	155	Tin	155, 156, 158
Stencil	206	Ton	226
Stitch	187, 188, 189, 191	Trap	122, 128
Stones, fireless cooker	50, 54	Trays	176, 197, 200
Stoner	161	Treadle	186, 209
Storage tank	113, 220	Tungsten	82, 83, 158
Storage battery	215, 216, 217	Type	203, 204, 208
Stove		Typewriter	202, 203, 206
37, 47, 48, 49, 57, 58, 63, 65, 70			
electric	42, 44, 157	<b>U</b>	
gas	23 to 30, 144	Utensils for cooking	44, 155, 156
heating	75, 76, 78, 80, 141		
Stove, wood and coal	15, 22	<b>V</b>	
Stoves, care of	31, 34, 41, 44, 76, 78	Vacuum	112, 176, 240
Stuffer	163, 164	cleaner	147, 148
Suction pump	112, 113	Valve	
washer	132, 133, 169	25, 26, 29, 33, 37, 52, 68, 69, 70	
Sweeper, carpet	147, 148, 150	71, 72, 90, 112, 113, 119, 120, 122	
Switch, ignition	192	129, 130, 145, 174, 183, 197, 211	
Syrup, temperatures of	235	232, 235	
		Vapor	40, 41, 145
<b>T</b>		Vent, radiator	68
Tables		Ventilators	110, 111, 197, 198, 200
85, 158, 219, 226, 227, 228, 229		Volt	82
235, 238		Voltage	86, 110, 144, 217
Tablespoons	227, 228	<b>W</b>	
Tank		Warping	76
30, 31, 35, 37, 39, 40, 64, 67, 96,		Washboard	134
146, 220, 223		Wash boiler	172
septic	124, 125, 126, 127	Washers for valves, etc.	120
water		Washing equipment, care of	
107, 109, 113, 117, 119, 128, 129		136, 138, 139, 141, 142	
Teaspoon	227, 228	Washing machines	132, 133, 135, 136, 209
Temperature		Waste	76, 124
20, 51, 73, 101, 103, 105, 173, 196		Water	67, 102, 106
198, 200, 206, 220, 233, 236		closets	128
Tempering of metal	156	coolers	105, 108
Tension	187, 188, 189	filters	114
Tester, egg	201	for cooling	107, 215
Thawing	233	for furnaces	
Thermal unit	218	64, 66, 67, 68, 70, 71, 72, 81	
Thermometer	197, 199, 233, 234	heater	118, 119
Thermostat		meter	230
197, 198, 199, 200, 235, 236		motors	137, 209, 210, 211, 220
Thorium	88	tanks	119
Thread	187, 188	-bath canner	173
Throttle	192	-seal canner	173

# INDEX

247

	Page		Page
Watt.....	82, 84	Wire.....	43, 46, 110
Weight.....	220, 226	Wood.....	157, 219
Wells.....	113, 125	Wringer, clothes.....	138
Wheels.....	137, 165, 211, 230	mop.....	154
Whey separator.....	180		
Whistle.....	56	<b>Y</b>	
Wick... 32, 35, 93, 94, 95, 98, 198		Yard.....	229
Wickless burner.....	32, 33		
Window, adjustment of... 63, 183		<b>Z</b>	
shades.....	184	Zero.....	233

# INDEX OF ILLUSTRATIONS

	Page		Page		
<b>A</b>					
Acetylene burner . . . . .	90	Clean-out for cook stove . . . . .	15		
gas plant . . . . .	221	Cloth plate, sewing machine . . . . .	190		
Adjusting gas light . . . . .	89	Compressed-air pump . . . . .	114		
Air mixer . . . . .	24, 77	Cooker, gas . . . . .	54		
Alcohol iron . . . . .	145	steam . . . . .	55		
Ash chute . . . . .	21	Cooking stove . . . . .	15, 25		
Automatic devices for heating		Cooler for food . . . . .	106, 108		
water . . . . .	118	Crank shaft . . . . .	213		
tension . . . . .	190	Cream separator . . . . .	179, 180		
<b>B</b>					
Balance wheel . . . . .	186	Curtain roller . . . . .	185		
Ball bearings . . . . .	152	Cylinder washer . . . . .	134		
Barometer . . . . .	239	<b>D</b>			
Bath-tub overflow . . . . .	122	Dampers . . . . .	15, 17		
Battery . . . . .	217	Direct light . . . . .	83		
Blower . . . . .	110	Discs in separator . . . . .	180		
Bobbin shuttle . . . . .	188	Dish dryer . . . . .	172		
spool . . . . .	188	washer . . . . .	170, 171		
thread . . . . .	188	Door holder . . . . .	184		
winder . . . . .	186	check valve . . . . .	184		
worm wheel . . . . .	186	Draft . . . . .	17		
Boiler, washer for . . . . .	132	Dryer . . . . .	139, 176		
Booster . . . . .	120	<b>E</b>			
Bread mixer . . . . .	165	Egg tester . . . . .	200		
Brush, electric cleaner . . . . .	151	Egg, appearance when tested . . . . .	201		
carpet sweeper . . . . .	153	Electric fan . . . . .	111		
Bunsen burner . . . . .	89	generator . . . . .	216		
Burner, acetylene . . . . .	90	heater . . . . .	80		
Bunsen . . . . .	89	heating unit . . . . .	43		
cleaning . . . . .	26	iron . . . . .	143		
gasoline . . . . .	37, 38	lighter . . . . .	91		
gasoline-gas . . . . .	29	meter . . . . .	232		
oil stove . . . . .	31, 34	plug . . . . .	144		
<b>C</b>					
Cam . . . . .	213	stove . . . . .	42, 80		
Canner, pressure . . . . .	173	vacuum cleaner . . . . .	150, 151		
water-bath . . . . .	172	Embroidery spring . . . . .	190		
Can sealer . . . . .	175	Engine, gasoline . . . . .	213		
Cap, sewing machine . . . . .	190	Expansion tank . . . . .	67		
Carpet sweeper . . . . .	152, 153	Exhaust valve . . . . .	213		
Centigrade thermometer . . . . .	234	<b>F</b>			
Centrifugal washer . . . . .	136	Fahrenheit thermometer . . . . .	234		
Chambers' fireless cooker range . . . . .	54	Fan . . . . .	110, 111		
Check valve for door . . . . .	184	Faucet showing parts . . . . .	122		
Cherry stoner . . . . .	160	Feed bar, sewing machine . . . . .	190		
Chimneys, lamp . . . . .	93	pipe . . . . .	31, 32, 33		
Circulation in refrigerator . . . . .	102	Fireless cooker . . . . .	51, 53		
Cleaner, vacuum . . . . .	147, 150, 151, 152	Flames, clear and smoky . . . . .	35		
		Flushing tank . . . . .	130		
		Flywheel . . . . .	213		

	Page
Force pump	113, 119
Fruit press	164
Fuel box	21
Furnace, Garland hot-water	64, 65, 67
pipeless	61
steam	69, 73
warm-air	58, 59
Fuse on electric heating unit	43

**G**

Gage, water	70
Gas, acetylene plant	221
air mixer for	24, 77
burner	23
cooker	54
heater	77, 78
iron	145
light	89
logs	79
meter	230
oven	27
radiator	79
stove	25, 77, 78
tank	223
Gasoline burner	37
engine	313
-gas lamp	97
-gas plant	220
-stove	38
Generator	216
Governor	213
Grate	16, 21
Grinder	160, 161, 162

**H**

Heater, electric	80
gas	77, 78
hot-air	62
hot-water	65
oil	80
reflector	78
water	118, 120, 121
Heating unit	45
for electric stove	43
Hectograph	206
Holder, door	184
Hinge, door	185
Humidifier	58

**I**

Iceless refrigerator	105
----------------------	-----

	Page
Ignitor	213
Incubator	197
lamps	196
Indirect light	86
Instantaneous water heater	118
Insulation in cooker	51
Iron, alcohol	155
electric	143
gas	145

**K**

Kerosene lamp	94
oil heater	80
Knives, mower	195

**L**

Lamp	35, 93
electric	83
gasoline	97
incubator	196
mantle for	94
Lard press	164
Lawn mower	195
Lifter for fireless cooker stones	53
Light, adjusting gas	89
direct	83
indirect	86
pilot	27
semi-indirect	87
Lighter, gas stove	28
electric	91
Lining of fire box	21
Lock-stitch machine	186
Locomotive washer	135
Logs, gas	79
Looper, sewing machine	190

**M**

Mangle	141, 142
Mantle lamp	88, 94
Meters	230, 231, 232
Mimeograph machine	207
Mixer, bread and cake	165, 166
Mop wringer	154
Motor, water	209, 210, 211
Mower, lawn	195

**N**

Needle bar	186, 190
clamp	186
Nozzles	152



	Page		Page
<b>O</b>			
Oil heater	80	Separator	
stove	32	DeLaval	181
burner	31, 32	Sharpless	179
lighting	34	Septic tank	124, 125, 126
Oscillating washer	135	Sewing machine, chain-stitch	190
Oven burner, gas	29	bobbin	188
Overflow	123	lock-stitch	186
		under part	187
<b>P</b>			
Pail for cooking food	107	shaft	213
Parer	159	Shaft, crank	213
Pet cock	173	Shaker, stove	21, 64
Pilot light	27	Shuttle	187, 188
Pipes, hot-water	65	Siphon	126
steam	69	Slicer	163
Piston	213	Spool holder	186, 190
Plant, acetylene-gas	221	for bobbin	188
gasoline-gas	220	Spring in curtain roller	185
Plug, electric	144	Steam cooker	55
Pneumatic gasoline lamp	97	furnace	69, 73
Press, lard and fruit	164	Stoner	160
Presser foot, sewing machine	186, 190	Stones, fireless cooker	51, 53
Pressure canners	173	Storage battery	217
thumb-screw for	186	Stove, coal	15
tank	223	electric	42, 43, 80
Pump, compressed-air	114	gas	24, 25, 26, 27, 77, 78
force	113, 119	gasoline	37, 38
plumber's	122	grate	21
suction	113	heating	62, 77, 78, 80
Pulley wheel	213	oil	31, 32, 33, 34, 80
Pulley, window	183	pipe	17
		shaker	21, 64
<b>R</b>			
Rack for canner	173	ventilator	111
Radiator	65, 68, 79	wood	15
valve	122	Suction pump	113
vents	68	washer	133
Reflector gas heater	78	Sweeper, carpet	153
Refrigerator	100		
circulation of air in	102	<b>T</b>	
iceless	105	Tank	65, 121
Roller, mangle	142	cooling	108
wringer	133, 134, 135	expansion	67
Rotary washer	134	flushing	130
		gas	223
<b>S</b>			
Safety valve	69	septic	124, 125, 126
Sealer, fruit-can	175	Tension, sewing machine	186, 187, 190
Semi-indirect light	87	Thermometer, Fahrenheit	234
Separator, disc	180	Centigrade	234
		Thermostat	199
		Thread, bobbin	188
		cutter	186
		guide	186

INDEX

251

	Page		Page
Thread			
take-up.....	186, 190		
Traps.....	129		
Tray for dishes.....	172		
Typewriter, Hammond.....	204		
L. C. Smith.....	202		
<b>U</b>			
Universal grinder.....	162		
Utensils for electric stove.....	45		
for fireless cooker.....	51, 53		
<b>V</b>			
Vacuum cleaner.....	147, 150, 151, 152		
nozzles.....	152		
Valve, cooker.....	51		
door check.....	184		
safety.....	69		
radiator.....	122		
Vegetable slicer.....	163		
Vents.....	68, 122		
Ventilator.....	111		
		<b>W</b>	
		Washer, centrifugal.....	136, 139
		cylinder.....	134
		for boiler.....	132
		locomotive.....	135
		oscillating.....	135
		rotary.....	134
		suction.....	133
		Water-bath canner.....	172
		Water closet.....	129
		cooler.....	109
		heater.....	120
		meter.....	231
		motor.....	209, 210, 211
		tank.....	121
		for cooling.....	107
		Wheel.....	186, 190
		Wick.....	36
		Window pulley.....	183
		Wringer, centrifugal.....	139
		mop.....	154
		roller.....	133, 134, 135









**RETURN TO → CIRCULATION DEPARTMENT**  
**202 Main Library**

LOAN PERIOD 1	2	3
<b>HOME USE</b>		
4	5	6

**ALL BOOKS MAY BE RECALLED AFTER 7 DAYS**  
 Renewals and Recharges may be made 4 days prior to the due date.  
 Books may be Renewed by calling 642-3405.

**DUE AS STAMPED BELOW**

AUTO. DISC.		
DEC 20 1988		
CIRCULATION		
MAY 12 1994		
AUTO DISC CIRC MAY 01 '94		

FORM NO. DD6 UNIVERSITY OF CALIFORNIA, BERKELEY  
 BERKELEY, CA 94720

LD 21-100m-7,'33

YC 18586

U.C. BERKELEY LIBRARIES



C006731676

olor.- Salm  
d.  
CHEST

573690

TX298

A5

UNIVERSITY OF CALIFORNIA LIBRARY



