



To fill in these spaces, draw a fairly heavy line on either side of the space to be filled; go over all the spaces of any one portion of metal and allow these lines to become dry; then open the pen wider and fill in the central portions. These filling lines are drawn with the R. L. pen guided by the triangle. Never fill in with a writing-pen or use the R. L. pen as a brush.

This method of filling the spaces causes a loss of time, as the first lines drawn must be allowed to dry, but the method is a safe one. A more rapid method and a better one after sufficient experience has been acquired is to fill each of the spaces at once by drawing line after line until the surface of the space is covered with liquid ink. The ink will then dry evenly over the entire surface of the space. Also, this allows of continual advancement without waiting for lines to dry. Caution is necessary to keep the triangle well away from the liquid lines of ink or a bad blot will result.

Just as good ink-lines are required for hatching as for the other parts of the drawing. Do not attempt to make the lines of hatching too fine.

In doing hatching, glance back after drawing every ten lines

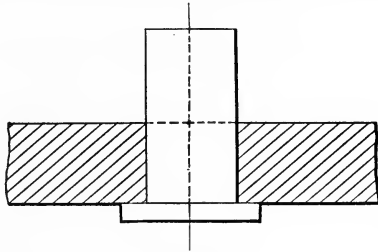

FIG. 37.

or so to see that the spacing continues regular; if irregular, gradually change the spacing until the exact amount is obtained.

In drawing sections where the plane passes through the center line of a cylindrical body, the cylinder is generally not

hatched, but is drawn in elevation, resting in the section. This refers to shafts, spindles, bolts, rivets, etc., as in Fig. 37.

Fig. 38 shows a Plan and Elevation of a steam-cylinder. The Plan is half in section, the section taken at the line *AB* of the Elevation. The upper half of the half-cylinder is removed and the section drawn, the lower flange of the

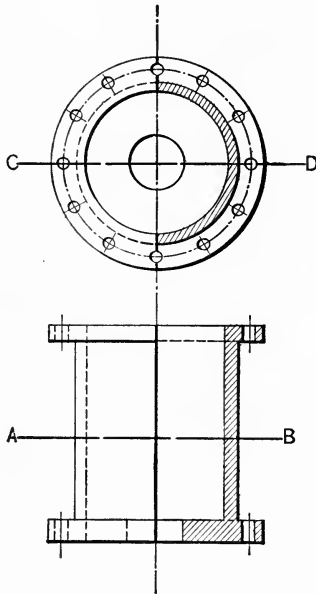
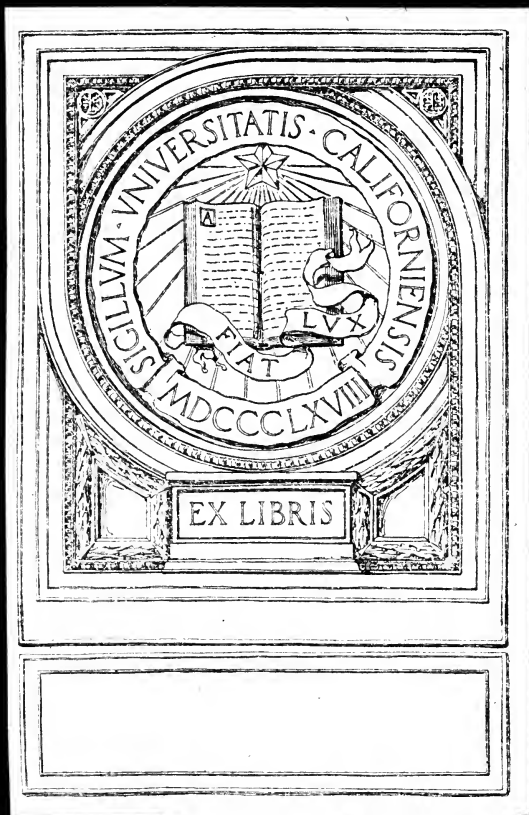

FIG. 38.

cylinder showing below the section. Each bolt-hole is drawn, and the centers marked, first by the circular center line and also by the short radial lines.

The elevation of the cylinder is also half in section, the section made at the plane *CD* in the Plan. In this case the front half of the half-cylinder is removed and the section drawn. The top and bottom lines of the flanges and the opening at the bottom are carried across to the center line. The lower line of the upper flange in the section is a broken line, as this rim of the flange is concealed behind the section.





MECHANICAL DRAWING.

WRITTEN FOR THE USE OF THE MIDSHIPMEN
AT THE UNITED STATES NAVAL ACADEMY.

BY

F. W. BARTLETT,
Captain, U. S. Navy

THIRD EDITION, REVISED

FIRST THOUSAND



NEW YORK:
JOHN WILEY & SONS.
LONDON: CHAPMAN & HALL, LIMITED.
1911.

T 353
B 3
1911

Copyright, 1901, 1911,

BY

F. W. BARTLETT.

TO THE
AUTHORS

THE SCIENTIFIC PRESS
ROBERT DRUMMOND AND COMPANY
BROOKLYN, N. Y.

PREFACE FOR THIRD REVISED EDITION.

THIS text-book has been in use for ten years at the United States Naval Academy, and the course in Mechanical Drawing has been very successful.

From the experience of these years the book is revised and the lately adopted methods of the Navy Department have been incorporated. The changes are particularly in regard to the adoption of Standard Lines for the different Bureaux. In addition the first two sheets have been combined in one, to reduce the time devoted to technique.

March, 1911.

F. W. BARTLETT,
Captain, U. S. Navy.
iii

PREFACE.

THE attempt is made in this treatise to find the methods of practical work in use in most drafting-rooms and to give these methods in detail for the use of those studying Mechanical Drawing.

The author has endeavored to eliminate any personal peculiarity of method, and has based the treatise on the methods in use in the United States Navy, as far as these methods could be determined. As general methods differ slightly, the drawings referred to for the general instruction have been those of the Bureau of Steam Engineering of the Navy Department, and the methods of that bureau have been followed. The special methods of the Bureau of Ordnance and of the Bureau of Construction are studied and used after the main course is completed. The differences are, however, slight and refer principally to center lines and dimension lines. The Bureau of Ordnance uses the decimal scale also.

All the minor points of method that are found only by experience cannot be given to a large class by a small corps of instructors, and the endeavor is made to place these methods where they may be found and studied. The instructor may then refer each one to the book instead of giving to each individual the same detail.

The system of instruction urged does away with copying. In fact, no copying is allowed and no drawings are available for copying.

The First Drawing is purposely full of detail, so that the eye, mind, and hand may be trained to accuracy together, each depending on the others. The instruction lessens as the figures follow each other, only the new and most important points being noticed. The attempt is made to have the triangular scale used so that it will be thoroughly understood.

No Geometry or Descriptive Geometry is given, as these branches are taught in the department by another textbook.

All but Sheet II has been carefully criticised by Mr. A. M. P. Maschmeyer, Chief Draftsman in the Bureau of Steam Engineering at the Navy Department, and the author is much indebted to him for his kindness and his thorough criticism.

The naval officers associated in this work have assisted materially with suggestions. I am particularly indebted to Lieut. Commander John L. Gow, U. S. Navy, for his unsparing and accurate criticisms.

F. W. BARTLETT,
Lieut. Commander, U. S. N.
(1901)

CONTENTS.

	PAGE
THE DRAWING COURSE.....	xi
USE OF INSTRUMENTS.....	I
Drawing-board.....	I
Thumb-tacks.....	2
Pencils and Pencilling.....	2
Sharpening the lead.....	3
Ink.....	5
Red Ink.....	6
T Square.....	6
Triangles.....	8
To Test Triangles.....	9
The Triangular Scale.....	10
To Use the Scale.....	13
Triangular-scale Guard.....	13
Right-line Pen.....	13
Use of the R. L. Pen.....	14
To Examine and Test the R. L. Pen.....	18
To Sharpen the R. L. Pen.....	18
Compasses.....	19
To Test the Compasses.....	20
To Use the Compasses.....	20
Extension-bar.....	21
Bow Spacers.....	22
Bow Pencil and Bow Pen.....	23
Dividers.....	24
To Use the Dividers.....	24
Irregular Curves.....	25
Protractors.....	26
To Use the Protractors.....	26
Erasers.....	27
Erasing Shields.....	28
Horn Center.....	28
Brushes.....	29
Pricker.....	29
Beam-compasses or Trams.....	29

	PAGE
Foot Rule.....	30
Calipers.....	30
Splines.....	31
Lead-wire.....	31
Paper-cutters.....	31
GENERAL DIRECTIONS.....	32
Stretching Paper.....	32
Profile Drawings.....	34
General Arrangement.....	34
Working Drawings.....	35
Views.....	36
Projections.....	38
Lines.....	40
Center Lines.....	41
Shade Lines.....	43
Shafts and Other Cylindrical Objects.....	49
Sections.....	50
Hatching.....	51
Breaks.....	56
Dimension Lines; Dimension Extension Lines.....	57
Threads.....	62
Square Threads.....	67
Bolts and Nuts.....	70
Jam-nuts.....	74
Tails.....	74
Working, Border, and Cutting Lines.....	75
Legend, Lettering, Scale, etc.....	76
Block Letters.....	79
Free-hand Lettering.....	83
Scales.....	83
Line Shading and Tinting.....	84
Flat Surfaces.....	84
Cylinder.....	85
Interior of Hollow Cylinder.....	88
Cone.....	88
Sphere.....	90
Tinting.....	91
To Prepare the Tint.....	91
To Lay on a Flat Tint.....	92
Tinting, Cylinder.....	94
Cone.....	94, 95
Sphere.....	95
Stippling.....	96
Tracing.....	96

	PAGE
Blue-printing	97
Sketches	98
Plan of Procedure in Making a Drawing	101
Pencilling the Drawings	102
Plan of Procedure in Inking	103
General Remarks	104
FIRST DRAWINGS.	106
General View of Sheet I.	106
Sheet I. Straight and Curved Lines	107
Fig. A. Horizontal Full and Broken Lines	109
B. Vertical Heavy Lines	110
C. 45° Triangle	112
D. 45° Triangle	113
E. 60° Triangle	114
F. 45° Triangle	115
G. 45° and 60° Triangles	116
H. 60° Triangle	117
I. Bow Spacers	118
J. Section Hatching	119
K. Compass	121
L. Compasses, Bow, Pencil and Pen	122
M. Bow, Pencil and Pen	123
N. Fillets	124
O. Two Arcs	126
P. Protractor, Arcs and Straight Lines	127
Q. Tangent Arcs	128
R. Connecting Arcs	129
S. Ellipses; Irregular Curves	131
T. Heavy Lines, Spaces between	133
U. Shading Circles; Hatching	134
Legend	135
Complete Drawing, Sheet I.	136, 137
Sheet II. Working Drawings	137
Description of Models	137
General Description of Sketching	138
General Directions for Drawing Sheet II.	141
Positions of the Views	142
Model I.	143
Sketching	143
Dimensions	145
Sections	147
Directions for Drawing	148
Model II.	149
Sketching	149

	PAGE
Sections.....	150-152
Dimensions.....	152
Directions for Drawing.....	153
Model III.....	154
Sketching.....	154
Sections.....	155, 157
Dimensions.....	156
Directions for Drawing.....	157
Legend.....	159
STANDARD DIMENSIONS OF BOLTS AND NUTS FOR THE UNITED STATES NAVY.....	160
STANDARD HATCHING.....	161
LINES TO BE USED ON DRAWINGS.....	162
INDEX.....	163

THE DRAWING COURSE.

IT is considered that the most important parts of the course are:

First. Instruction in the use of the instruments; in making clean, sharp lines; in connecting lines cleanly together; the technique generally.

Second. Instruction in quickly and accurately making a correct, dimensioned sketch of any piece of mechanism; and from the sketch making a working drawing so that the mechanism may be reproduced with certainty.

Third. Instruction in carefully and accurately making tracings and blue-prints from either the inked or pencilled working drawings.

Fourth. Instruction in quickly and accurately reading drawings.

Fifth. Special instruction in engineering, ordnance, and ship-building methods.

It is found by experience that the second and fourth parts of the course are much more important than the others and the instruction tends towards developing these two at the expense of the time previously allotted to the others.

MECHANICAL DRAWING.

USE OF INSTRUMENTS.

Drawing-board.—One edge only of the drawing-board is made a true plane. The accuracy of the drawings depends on this plane being true. This is the “working-edge” and is marked by a circular stamp along the middle of the upper face of the board. When in use, this “working-edge” is at the left, the stamped face upwards.

The “working-edge” of the board is considered for convenience as the W. side of the board, so that the side away from the position of the draftsman is the N. side of the board, etc.

The lines from E. to W. on the board are considered horizontal lines; those from N. to S. vertical lines.

When beginning a new drawing, take the drawing-board and T square to the pattern-maker to have them “trued up”; in other words, to make the “working-edge” of the board and the sliding-edge of the T square true planes. At the same time the T square is tested to make sure that the top edge of the blade is at right angles to the sliding-face of the head.

The drawing-board is to be kept horizontal or very slightly inclined at the height desired, the work done standing.

When first beginning work, swing the board around until the best light is obtained, the direction of the light to be from the left-hand top (N. W.) corner. Test this by placing the T square and triangle in position and noting if the edges to be drawn by are in light or shadow. While drawing, test often for light, as the work will be poor if the light is bad and the eyes will suffer.

Thumb-tacks.—These are used in securing drawing- and tracing-paper on the boards. When first inserted in the paper the heads may be tipped at an angle towards the center of the paper, so that when straightened up in pushing them into the wood they may slightly assist in stretching the paper.

They are always pushed down firmly when used.

To secure paper or tracing-cloth on the boards.—Place the paper in position as desired; put in a thumb-tack at the middle of the top line of the paper; slide the hand with a gentle, firm pressure from this tack down to the middle of the bottom line of the paper and, while firmly holding the paper as stretched, insert another thumb-tack; begin at the center of the board and slide the hand to the right with the same pressure and insert a tack at the middle point of the right-hand line of the paper; do the same to the left; begin again at the middle of the board and slide the hand with the same pressure towards a corner and insert a tack; repeat for the other corners. In each case, be sure to keep the pressure until the tack is fast. It may be necessary to insert tacks between those already placed. In each case press the paper as described.

Pencils and Pencilling.—The pencil-work of a drawing is most important. Good ink-work never hides defects of bad pencil-work. The accuracy of the drawing depends almost entirely on good pencil-work.

Make clean, sharp lines—not faint ones; it is difficult in

inking or tracing a drawing to find the faint lines, and the eyes are strained by the close vision required. Even though slight depressions are made in the paper by making firm lines, it is best to do this and save the eyes.

Draw all pencil-lines full and broken as required. It is a waste of time to begin and stop the pencil-lines at the exact points where the ink-lines will begin and end. Sweep through the terminal points of the line, but no farther than necessary. Pencil-lines are easily erased after the inking is completed.

The leads in the pencils used should be HHHHHH or HHHHHHH. These marks are found on the pencil or on the box of leads used with the artist's pencil.

Never use a soft lead for any purpose on a drawing-board. Sharpen the pencil-points frequently

The best point for the pencil is the long chisel-point narrowed to about one-third the thickness of the lead.

Fig. 1 shows the proper sharpening of the lead-pencil. The longer bevels are from 2'' to 3'' long, and the shorter ones from 1½'' to 2'' long, axially.

Fig. 2 shows the proper method of sharpening the lead for the artist's pencil. The length of the longer bevel along the axis of the lead is from $\frac{3}{8}$ '' to $\frac{1}{2}$ ''.

It is even advisable to make the point thinner as in Fig. 3, but there is more danger of breaking the lead through carelessness. For the compasses and bow pencil, narrow the flat edge still more and take care to place the flat edge of the pencil-point so that it is tangent to the arc drawn.

Another good point is made by sharpening the lead with a cut clear across at an angle, as shown in Fig. 4. This method is by many considered best, as the outer skin of the lead is hardest and wears better. Also, less time is required for sharpening, and the point is rounded. It is considered especially good for compasses and bow pencils.

Sharpening the Lead.—If a file is used, the lead is sharpened by rubbing it along the rougher side of the file until it is

shaped and then finishing on the smoother side of the file. Support the end of the file when sharpening the lead.

In the last sharpening, roll the lead a little on the file so



FIG. 1.

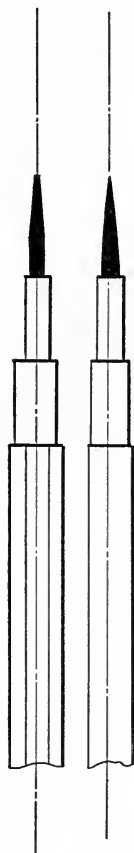

FIG. 2.

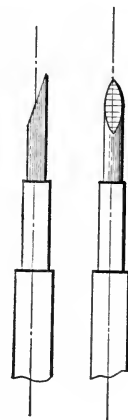

FIG. 4.



FIG. 3.

as to round the corners slightly. Finally, rub the flat edges on a piece of drawing-paper, rolling as before; this will remove the rough edges left by the file.

As files soon wear out, many prefer pads made of strips of sandpaper.

It is a good practice to have one end of the pencil sharpened with a chisel-edge and one with a round (needle) point for marking dimensions, both leads hard; but it is better for very accurate work to mark off dimensions with the sharp points of the dividers or bow spacers; or, better still, if such an article is at hand, the pricker.

In using the pencil, keep it nearly vertical and keep the arm away from the body. Do not hold the pencil so that the point is in the angle between the guiding-edge and the paper: keep it vertical.

Use the pencil with a free sweep, keeping the eye along the line of the T square or triangle if possible.

Always draw from left to right, and always away from the body.

Considerable practice will be required in order to draw a line accurately through two points when the pencil is guided either with the T square or the triangle. In the case of the triangle, for instance, if the two points are marked and it is desired to draw a line through the middle of each mark, place the triangle very near the points but not exactly up to them, as the pencil must be held vertical and not bent over to fit sharply into the angle between the triangle and the paper. Hold the pencil properly and draw a short line through the left-hand point; if it is not in the center of the mark, the triangle must be moved a little and the attempt repeated. After the line is correct, carry the hand along in the same position to the other point and again test by a short line. When the two short lines agree with the centers of the two marks, return to the left and sweep the line across, carefully holding the hand in the same position and resting the last two fingers on the triangle.

Ink.—The best drawings can be made only by using the best Indian or Chinese ink. This consists of carbon mixed with

some adhesive substance, and lies wholly on the surface when used on the drawing-board, and can be readily erased if necessary. It is furnished in blocks of varying sizes, and is ground in water in any convenient receptacle. Special forms of ink-saucers are made with glass covers to reduce evaporation and keep out dust.

As considerable time is required to mix the ink, and as ink must be freshly mixed to be good, it is often necessary to use one of the kinds of permanently mixed inks furnished in bottles. The results are not as good as can be obtained with the stick ink, but the time required for mixing the ink cannot always be spared.

Red Ink.—This is now seldom or never used. It flows more freely than the Indian ink, and greater care must be observed in its use, as it is much more likely to run out of the pens against the triangles and T squares. The outside of the pen must be carefully wiped after the pen is filled; the pen must not be filled as full as with the black ink; and care must be taken not to hold the pen too near the triangles or T square when making lines.

Whenever occasionally red ink is used, all red-ink lines are fine lines.

T Square.—On the working-edge of the drawing-board and on the T square depend primarily the accuracy of the drawings.

The T square consists of the head and the blade. Sometimes they are fixed at right angles to each other; and sometimes the blade is movable and may be clamped at any desired angle with the head. The fixed blade answers all practical purposes for general work.

The sliding-edge of the head of the T square is made a true plane, and this edge slides along the "working-edge" of the drawing-board, so that all lines drawn along the blade in the various positions of the head will be parallel. In the fixed-blade type, the top of the blade is accurately planed so

as to be at right angles to the head, so that all lines drawn along this top of the T square will be at right angles to the "working-edge" of the board. Since the triangles are accurately squared, the vertical lines drawn when the triangle rests on the T square in position will be parallel to the "working-edge" of the board.

Lines should of course be drawn with the upper edge of the T square only as a guide.

The T square is used for all horizontal lines. It cannot be depended upon for the vertical lines, as the bottom of the board is not planed at right angles to the "working-edge."

It is held with the head firmly pressed against the "working-edge" by the left hand, and is moved along that edge by the left hand. It must never be moved with the right hand on the blade or with both hands pushing the blade, or with the right hand assisting the left by pushing on the blade at the same time as the left hand moves the T square.

Stretch the first finger and the wrist of the left hand along the head of the T square equally on both sides of the blade, making the support as long as possible.

The vertical lines are drawn by using the triangles as guides. These are moved along the T-square as it is firmly held in position with the left hand. As both hands are required in using the triangles in this manner, after the triangle is nearly in the proper position, slide the left hand along the blade of the T square, always pressing to the right and downward, and hold the T square with some of the fingers and move the triangle along with the others. Often test the position of the T-square by moving the left hand back to the head of the instrument, again sliding it along the blade as before.

Never guide a knife in cutting paper with the upper edge of the T square. Use the lower edge; or, better still, use the knife with no guide but the eye and the line drawn for cutting.

Use no weights to hold the T square or triangles in position.

Triangles.—The triangles are 45° and 60° . The 45° triangle has equal angles at the ends. The 60° triangle has one 60° and one 30° angle. The other angles of both triangles are right angles and are very accurately constructed. In the case of the 45° triangle, the two shortest sides are equal in length; in the 60° triangle, the shortest side is half the length of the longest.

The triangles rest against the T square and are used in drawing the vertical lines of the drawings. These lines are then parallel to the "working-edge" of the drawing-board. In drawing these vertical lines always place the triangle on the T square so that the left side of the triangle will be the one vertical. In this manner the light will always come from the left.

To Draw Parallel Lines with the Triangles.—After one line is drawn with a triangle, to draw others parallel to it, place the triangle near the line and parallel to it, as if the line were to be drawn again. Do not attempt to place the triangle edge exactly on the line, as it will be found very difficult to get it exactly right, whereas it may be readily brought near and parallel. Hold this triangle firmly and bring the other triangle against one edge of it; then hold the second one firmly and move the first one along the edge of the fixed one until the desired point is reached, when the line may be drawn. This may be repeated for a number of lines parallel to the first one drawn. The left hand must hold both triangles when the lines are drawn, some of the fingers on each; generally the thumb and last two fingers hold the fixed triangle, and the first and middle fingers move along and secure the one moved.

Angles of 15° , 30° , 45° , 60° , 75° , and 90° may be drawn by the combination of the T square and the two triangles.

Never construct angles by drawing lines along adjacent sides leading from a vertex. It is even well to cut about $\frac{1}{4}''$ from all the corners of the triangles, as these corners are often bent and unreliable.

In drawing lines with the triangles as guides, always arrange so that the hand holding the R. L. pen rests on the triangle.

To Test Triangles.—For the straightness of the edges, an accurate steel straight-edge is generally a sufficient test; but if great care is required, the following method may be used: Push a very fine needle vertically into the paper; at a distance just less than the length of the edge to be tested, push another needle of the same kind into the paper vertically. Place the edge to be tested against the needles and draw a fine line, holding the pencil with great care and always in the same position relatively to the edge. Place the edge on the other side of the needles and draw another line. The errors are doubled.

To Test the Right Angle.—Place the triangle on the T square and draw a vertical line through a point chosen. Reverse the position and draw another line through the same point. The error is doubled.

To Test the 45° Angle.—Fig. 5. Draw accurately a large circle. Lay the 45° triangle in position on the T square and

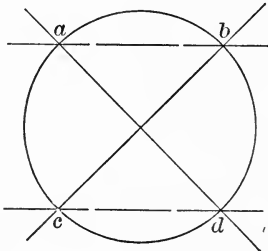

FIG. 5.

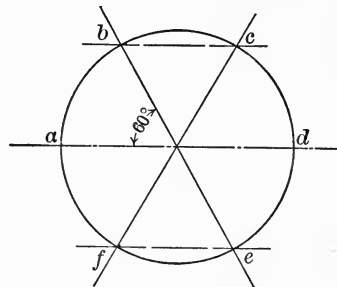

FIG. 6.

draw lines through the center as shown. Test with the T square the horizontal accuracy of the intersections a and b , c and d . An additional test may be made by spacing off ab with the dividers and comparing the length with bd , dc , and ca .

To Test the 60° Angle.—Fig. 6. Draw accurately a large

circle. Draw the horizontal center line. With the 60° triangle in position on the T square, draw the 60° lines as shown. Test with the T square the horizontal accuracy of the intersections b and c , f and e . Space bc and compare with cd , de , ef , fa and ab .

To Test the 30° Angle.—Use the above method, drawing also the vertical center line.

The Triangular Scale.—The triangular scale is used for all measurements on the drawing-board, and is an instrument of great accuracy and should be carefully treated.

This scale should never be used except on the drawing-board.

It should never be used for measuring any piece of mechanism, as it would soon have its edges battered and would be useless for accurate work. Lines should never be drawn along its edge; in other words, it should never be used as a ruler.

Distances should never be taken from it by compasses or dividers, as the points of these would ruin the scales; besides, this method of measuring is not as accurate as that of using the scale properly.

There are ten different scales on the rule furnished, so that drawings may be made from "full size" to $\frac{1}{32}$ size by using the different scales.

Small figures on the right or left indicate the scales.

The principal scale is marked 32 and is the only one on that flat of the rule. This is the "full size" scale where the foot is divided into inches and the inches into halves, quarters, eighths, sixteenths, and thirty-seconds; hence the 32 scale.

As most small measurements in engineering practice are given in these fractions of an inch, this scale is the common one—being like the ordinary one-foot or two-foot rule.

Another scale, marked 10, is also the only one on its flat of the rule, the foot being subdivided into inches and the inches into tenths. This scale is used in ordnance work in the U. S. Navy.

The other scales are for the purpose of making drawings of reduced sizes. The figures to the right or left indicate what number of inches or what portion of an inch represent one foot. Thus, to make a drawing of "one-fourth size" or "one-quarter size," instead of using the 32 scale and mentally calculating each dimension in order to draw it one-fourth its actual size, use the scale marked 3. This means that $3'' = 1$ foot, or that a distance of $3''$ is used to represent a foot of length and is divided up into twelve parts, each representing one inch. These representative inches are again divided into halves, quarters, and eighths. Then, instead of calculating a distance, it is taken directly from this scale, the calculation already made, so that the distance marked off will be exactly one-fourth of the true distance.

The other scales are for the same purpose for different fractions of full size.

Mark.	Size.	Stated on Drawings.
32	Full size	Scale, full size
10	Full size	Scale, full size, decimal
4	One-third	Scale, $4'' = 1$ foot
3	One-fourth	Scale, $3'' = 1$ foot
2	One-sixth	Scale, $2'' = 1$ foot
$1\frac{1}{2}$	One-eighth	Scale, $1\frac{1}{2}'' = 1$ foot
1	One-twelfth	Scale, $1'' = 1$ foot
$\frac{3}{4}$	One-sixteenth	Scale, $\frac{3}{4}'' = 1$ foot
$\frac{1}{2}$	One-twenty-fourth	Scale, $\frac{1}{2}'' = 1$ foot.
$\frac{3}{8}$	One-thirty-second	Scale, $\frac{3}{8}'' = 1$ foot.

Of course, as the fraction of full size is reduced, the number of divisions on the representative foot is lessened; for instance, on the scale of $\frac{3}{8}'' = 1$ foot the smallest division of the three-eighths inch represents one inch of the full size, and the inches are not marked with figures.

For all except the 32 and 10 scales there are two scales on the same flat, so that either may be used. As one of these

scales is always equal to twice the other, there is no difficulty in taking off any dimension.

For distances over one foot the scales are marked for feet, beginning from the 0 mark. For instance, using the scale of $1\frac{1}{2}'' = 1$ foot, the 0 mark is towards the center of the rule, and, looking towards the right, we find along the same line on which the 0 is placed a figure 2. This is 2 feet. Farther on is a figure 4 for 4 feet. The unmarked lines between 0 and 2 and 2 and 4 are 1 foot and 3 feet respectively.

Note that the inches and feet are always on the same line as the 0 mark.

If using the scale at the other end of the same flat, the $3'' = 1$ foot scale, we find that the 0 mark is below the flat surface and on the curved portion. Then, for using this scale for distances of over one foot, we must look along the line where the 0 is placed or in the curved portion. Here we find 1 and 2, only. In order then to measure 2 ft. $7\frac{3}{8}''$, we place the 2 mark at the starting-point and follow along to 0 and then find $7''$ and then the $\frac{3}{8}''$.

To measure 3 ft. $7\frac{3}{8}''$ on the scale of $1\frac{1}{2}'' = 1$ foot, we look along the flat portion in line with the 0 for that scale and find that the mark for three feet must be between 2 and 4. This is placed at the starting-point and the 3 ft. and $7\frac{3}{8}''$ found as before, only to the left.

It may be advisable to place the $7\frac{3}{8}''$ mark at the starting-point of the measurement and measure on to 0 and then to 3 feet.

For a "half-size" drawing, the 32 scale is used, the division by 2 made mentally.

For a "double-size drawing," "triple-size drawing," etc., use the 32 scale and perform the multiplication mentally.

For a drawing smaller than $\frac{1}{3}\frac{1}{2}$ size, use the smallest scale, the $\frac{3}{8}'' = 1$ foot, and mentally divide as for "half-size" above.

In a drafting-room flat scales are much used instead of the triangular scale.

To Use the Scale.—Lay the scale along the line to be measured so that the desired scale is away from the body and thus in good light. Adjust the position of the marks as described above and mark the ends of the dimension obtained either with a “needle-pointed” lead-pencil, a pricker, or the point of the bow spacers or large compass. The metallic points are best, as they are sharper. Mark the points distinctly; send the metallic points through, but do not make large holes in the paper. The point is marked distinctly to save the eyes when it is to be found and used later, but the paper must not be ruined by carelessness. When several dimensions are to be measured along the same line, do not shift the scale for each one; leave it in the first position and make all the marks. This lessens the danger of making errors.

In marking these points, the sharp pencil or metallic point should never mar the scale, but the instrument should be slid down along the scale—lying flat against it if possible.

Triangular-scale Guard.—This is of value when the same scale is used for any length of time; it is clamped on the triangular scale so that the desired scale may be readily found.

Right-line Pen.—The right-line pen is used for drawing all ink-lines that are not arcs of circles. It consists essentially of two sharpened steel points or nibs secured firmly together or made from one piece of steel. The steel nibs tend to separate and are kept in the desired position by means of the small screw.

The ink is introduced between the nibs of the pen by the rubber-topped ink-dropper or the quill pen attached to the cork of the bottle, if such are provided. If not provided, a steel pen is the best thing to use. In filling the R. L. pen in any of these ways, hold both the R. L. pen and the other implement nearly vertical and bring the points of the two instruments together with the point of the other instrument inserted between the nibs of the R. L. pen, when the ink will freely run into the R. L. pen.

A thin strip of paper is sometimes used, but it is a bad practice, as small portions of paper may be caught in the pen.

Another method is to dip the R. L. pen in the ink, in which case the outside of the pen must be very carefully wiped.

The ink is held in place by capillarity, and is drawn out as the pen is carried along the paper.

Ordinarily fill the pen only to a height of one-quarter of an inch, as the ink will probably dry before being used; when drawing heavy shade lines, fill the pen as full as it will hold with ink.

Never fail to wipe off the outside of the nibs of the pen after filling with ink.

Use of the R. L. Pen.—The pen is held vertical; the screw-head away from the guide; the middle finger against

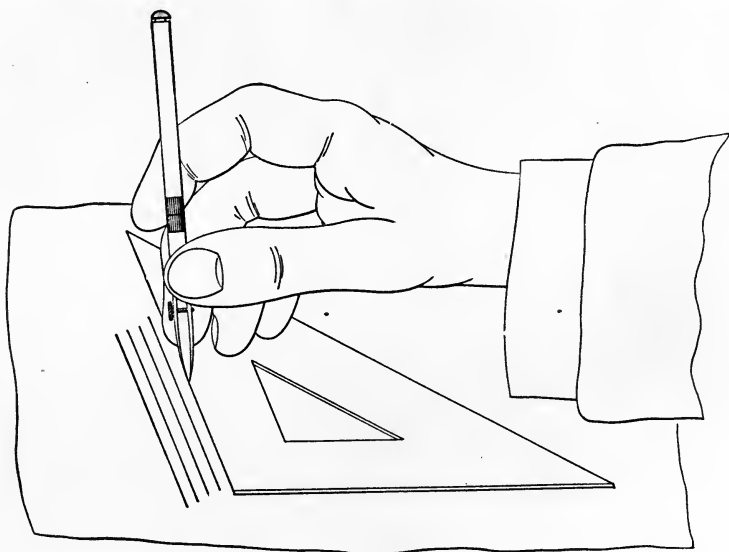

FIG. 7.

the opening of the nibs on one side and the thumb higher up and against the opening of the nibs on the other side; the upper part of the pen resting in the outer joint of the first finger; the last two fingers resting on the T square or triangle as a guide. Note carefully Fig. 7.

The reason for holding the pen as described is that there is no danger of changing the opening of the nibs by greater or less pressure put on them by the thumb and fingers.

If the thumb and fingers press on the top and bottom of the nibs, the least change of this pressure will cause a variation in the width of the line, as in Fig. 8.



FIG. 8.

By holding the pen properly, a line of equal width, as far as this liability to error is concerned, is secured.

The pen is guided by the T square, triangle, or irregular curve, and it must be carefully noted that these are for a *guide* only. The pressure against the guide must be light and *uniform*, as a variation of this pressure will produce a variation in the width of the line, as in Fig. 9.



FIG. 9.

The proper method of holding the pen will assist in preventing this defect, as the nibs are held more or less firmly in position by the fingers. The nibs of the pen must be kept parallel to the guide, as, if they are dragged along diagonally, a ragged line will be made. The pen must not be held too close to the guide, as the ink is likely to flow out suddenly and make a blot against the guide; if held vertical, the curvature of the nib will prevent this accident.

In drawing ink-lines a positive and constant pressure must be maintained directly downwards; this pressure varies with the sharpness of the pen and the smoothness of the paper. With a very sharp pen and very smooth paper an extremely light pressure is required; but with a dull pen and paper full of depressions and heights considerable downward pressure

must be maintained. This downward pressure is entirely distinct from the pressure against the guide (T-square, triangle, etc.). Each one by practice must determine for himself what downward pressure is required for the special pen and paper used.

Both nibs must rest on the paper equally and must be carried evenly along the guide; if one nib presses harder than the other, a ragged line is produced, as in Fig. 10.

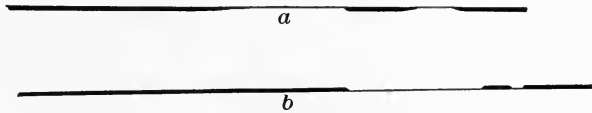

FIG. 10.

a shows where the upper nib has cut a clean, firm edge, and *b* where the lower one has been the only one cutting a sharp edge.

The body must be moved about as necessary when using the R. L. pen. The important thing is to make a good line. So the hand and arm must be first arranged and the body moved so as to leave freedom of movement to the arm. When holding the pen as described the body will have to be moved well to the left, so that instead of the eye being directly over the line drawn it will be looking along the line from above and to the left.

Always keep the arm free from the body.

Draw away from and not towards the body.

When drawing ink-lines with the use of irregular curves the pen must be constantly twisted in the fingers to keep the nibs parallel to the edge of the curve. Considerable practice is required before good work of this kind can be done.

The R. L. pen may also be used without a guide for drawing curves when it is not desired to take the time necessary to find the exact curved lines on the irregular curve. Rest the last two fingers on the board; carefully follow the curve drawn in pencil; twist the pen in the fingers to keep the

nibs parallel to the line at each point. This is especially valuable in making irregular breaks in metal, instead of using the writing-pen, which never makes clean work.

Always draw lines from left to right. If it should be necessary to go over a line a second time, go over it in the same direction as before. *Never* go backwards on a line.

In case the ink does not flow readily from the pen, a quick method, though an inadvisable one, is to run the point across one of the fingers of the left hand. A better way is to keep a small piece of moistened blotting-paper at hand and touch the point of the pen to that; if the ink fails to run then, clean the pen and refill it. On a dry day the pen must be frequently cleaned on account of the rapid evaporation of the dissolving liquid.

Sometimes the ink may be made to flow by pressing the pen with a blade flat on the paper, using enough pressure to cause the blades to slide on each other. This breaks the small clot of ink at the point.

Always test the R. L. pen by drawing lines against a guide, as it is never possible to tell surely what kind of a line will be made by testing the pen unguided.

Frequent cleaning of the pen is one of the secrets of making clear lines.

Especial care should be given to cleaning the R. L. pens; they should be cleaned after use, even if only five minutes will intervene before using them again; they should never be put away uncleaned.

A piece of cotton cloth or chamois-skin will thoroughly clean the pen; nearly close the nibs and insert the cloth between the nibs and draw it through. If the ink is fresh and this operation be repeated two or three times, the pen will be cleaned. It is well to dip the pen in water before cleaning.

Do not use too thick a piece of cloth or chamois-skin, as the nibs of the pens may snap off.

To keep all the lines of the same kind of the same width,

do not change the adjustment of the pen in cleaning; draw the cleaning cloth between the points carefully without moving the screw.

Do not use a bad pen. If one line is bad, find the cause at once. Sharpen the pen; clean it out; or get new ink, as necessary.

To Examine and Test the R. L. Pen.—Note the shape of the nibs of the pen when new, and always make them of that shape when sharpening the pen. The nibs should be of exactly the same shape and length. Look along the edges of the nibs, holding the pen-point towards the eye and turning the pen in the plane of the nibs, and note if any portions of the points are blunt. The bluntness will appear as a line of light along the point.

To Test.—Fill the pen with ink and open the nibs so as to make a wide line. Begin to draw the line along a T square or triangle and note whether the nibs cut equally. Effects like those in Fig. 11 will be observed as the nibs are opened and

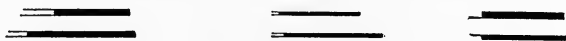

FIG. 11.

closed until the proper setting is found. Then if the marks of the nibs at the left are equally strong, the nibs are of equal length.

Test for sharpness by drawing fine lines.

To Sharpen the R. L. Pen.—Place oil or water as required on the stone. Screw the nibs of the pen together until they firmly touch. Hold the pen in a plane perpendicular to the oil-stone, the opening of the nibs in that plane, and move it back and forth along the stone, changing the slope of the pen one way and the other as it is moved along the stone, so as to grind off the points to the proper curve and also to make them of the same length. This makes both points dull, but they are of equal length. Next, clean the pen and open the nibs; examine the pen as described before and note what parts of the

points need most sharpening. Of course the widest light portions are the dullest. Close the nibs until they just touch, and proceed to sharpen as follows: Place one of the nibs on the stone, the pen at an angle of about 15° . Move the pen backwards and forwards along the stone, at the same time twisting it in the fingers. This brings the edges of the nibs in position to be ground down as required. Sharpen principally the portions noted as dull. Frequently clean the pen and examine as before. Continue the operation until no dull places can be discovered. Clean thoroughly and test the pen with ink. If not properly sharpened, continue as before until exactly right. In sharpening, it is likely that one nib may be sharpened too much and thus become too short; in that case the ink-line drawn will show the defect, and it will be necessary to again dull the points and begin over again. Practice soon brings efficiency, and nobody can properly sharpen a pen for another, as no two people hold the pen in precisely the same way. It is very important, then, for each one to persevere and learn to sharpen his pen.

Be very careful about using the stone on the inside of the nibs. If a feather-edge be formed in sharpening the pen, open the nibs and slip the stone between them. A very few and slight movements of the stone will take away the feather-edge.

There is a limit to the sharpness of pen required, as the paper will be cut and ruined if the pen is too sharp. Trial only will test for this defect, and it is a very simple matter to dull the pen slightly, as explained.

Compasses.—This instrument is used for drawing arcs of circles in pencil or ink, from the largest that can be made with the extension bar inserted to a circle of about $1\frac{1}{2}$ " in diameter. It is an extremely accurate instrument and should be well treated. The needle-point is fixed; either the pencil- or pen-point may be put in place and clamped with the screw. These points should always be pushed home and carefully clamped; and pushed or pulled straight when placing or removing them.

To set the needle-point, put in place the pen-point; close the instrument and push the needle-point out until the shoulder at the base of the needle just coincides with the point of the pen; then clamp the needle-point. Once the needle-point is adjusted, it need never be changed.

To set the pencil-point, insert the pencil-point in the compasses and push it home and clamp in position; push the pencil out until it coincides with the shoulder of the needle-point and clamp the pencil. As the pencil is resharpened, it must be pushed out to agree again with the shoulder of the needle-point.

NOTE.—The pencil-point is sharpened as described under the methods of sharpening leads, making the chisel-point narrow.

To Test the Compasses.—Insert the pen-point and close the instrument. The needle-point and the middle of the pen should coincide. The same should apply to the pencil-point, except that allowance must be made for inaccuracy in sharpening the lead. Another test for the compasses: Place the pen-point in place; break the knees of both legs of the instrument and open the legs until the angle at the upper part is about 45° and bring the points together; these should closely coincide.

To Use the Compasses.—From the given center the radius to be used is measured with the triangular scale and sharply and clearly marked. Carefully place the needle-point of the compasses exactly in the center of the mark for the given center and push it home to the shoulder. This fixes the center so that it may be found again when needed, and also gives the needle-point a firm support in the wood under the paper and preserves the paper. This needle-point must always be kept upright by bending the knee above it as much as is necessary for whatever circle is drawn. This is *very important*. Next, open the legs of the compasses and bend the knee above the needle-point as required, and also the knee

above the pencil-point, until both needle- and pencil-points are vertical. This may be approximated to with the pencil-point, but must be carefully done for the needle-point. When the pencil-point is nearly over the point measured, spring the instrument open as required until the pencil-point cuts the middle of the mark for the measured distance. Test it by sweeping a short arc through the point and change as needed until the exact center is cut by the pencilled arc. Hold the handle of the compasses between the thumb and first finger, the instrument nearly vertical; begin to draw the arc at the left and towards the body at a point towards the S. W.; lean the instrument slightly ahead of the position of the pencil-point and keep the same amount of forward slope as the arc is swept around to the starting-point, always from W. to N., etc., and press on the pencil-point firmly and with a constant pressure. *Never* go backwards on the arc. If any part is indistinct, go over it again in the same direction.

Make the line sharp and clean.

On arriving at the starting-point, the line should coincide exactly with that part drawn at the beginning.

The same methods apply for inking, the amount of pressure required on the pen-point being determined by experience for the kind of paper used. The bending of the knees of the compasses in inking is especially important, as both nibs of the pen must cut sharply and equally in order to secure a clean, sharp line.

At each change of opening of the compasses, before making a line on the drawing, a test should be made on the margin of the paper to see that a good line will be drawn.

The remarks under R. L. pen in regard to cleaning the pen apply with equal force to the compass-pen.

Extension-bar.—When the arc to be drawn is large, the extension-bar is put in place above the pencil- or pen-point, care being taken that it and the pencil- or pen-point are both pushed home and clamped.

In drawing arcs with the extension-bar in use, it is sometimes necessary to guide the pencil- or pen-point with one hand while steadying and turning the compasses with the other hand on the handle.

If a "beam compass" is available, it should be used instead of the compass with the extension-bar for inking, as the latter springs considerably.

Bow Spacers.—The bow spacers are used for spacing off distances of equal length. The points are also much used for marking measured points instead of using a "needle-pointed" lead-pencil, as the point of the spacer is much finer than can be maintained on any lead-pencil.

Instead of using the spacers for laying off distances of equal lengths, it is more accurate to lay the triangular scale along the line and mark the divisions. Although some of the divisions thus laid off may be inaccurate, the total length will be true and there is less liability of error. When dimensions are not on the triangular scale, the bow spacers are used with advantage and are useful in dividing a line into any given number of parts quickly, when it is not desired to take the time necessary to divide the line geometrically.

In dividing a line into parts geometrically, the bow spacers are useful in laying off quickly and accurately the equal lengths on the line laid off at an angle with the given line.

Constantly keep the index-finger of the right hand on the top of the spacers and step off the points along the line to be spaced, using the thumb and second finger to swing the instrument. The steps are made by swinging the points of the spacer alternately one way and then the other, pushing each point in sufficiently to mark the point well. This necessitates a forward and backward movement of the hand for each point marked, combined with the swinging movements of the points of the spacers.

If a distance, as 2 inches, is to be spaced off into any number of divisions, say ten, estimate with the eye about the

length of one division and set the spacer. Go over the line quickly, making the least amount of puncture possible. The amount under or over at the end is again divided by estimate and the spacers reset and another trial made very lightly. When the exact setting is found, go over the line again and puncture the paper sufficiently to clearly mark the divisions.

Bow Pencil and Bow Pen.—These instruments are very useful and are extremely accurate when handled carefully and kept in good order.

They are used for small arcs.

The needle-points are adjusted and the instruments tested as given under compasses, noting that the flattened side of the needle-point is placed towards the pen- or pencil-point so that very small circles may be drawn.

In using these instruments, the needle-points are always pressed in to the shoulder, as stated under Compasses; by testing the setting with a small arc and slightly changing the screw, very accurate adjustments can be made.

The remarks under Compasses apply as to leaning the instrument a little forward and putting a certain and constant amount of pressure on the point; also in regard to the point of beginning to draw the circle.

In opening and closing these instruments, press the points together with the left thumb and forefinger, thus removing the pressure from the adjusting-nuts before turning them; this preserves the threads of the adjusting-screws and makes the operations more rapid.

Since there are no knees to be bent in the bow instruments, the nibs of the pen-points do not evenly touch the paper for all radii, and the largest and smallest circles may not be as good as the medium-sized ones drawn. When the needle-point is set as stated above, it is right for the average of radii used, but it may be necessary to change the needle-point for very small or very large arcs.

In Fig. 12, *a* represents the positions of the nibs of the pen

for the average arcs; b for the very small; and c for the largest. The needle must be pushed in for b and out for

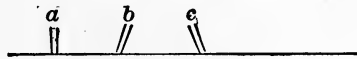

FIG. 12.

c , in order to have the nibs cut equally and produce a perfect line.

The remarks under R. L. Pen in regard to cleaning the pen apply with equal force to the bow pen.

Dividers.—This instrument has two sharp points, and is used on the drawing-board for marking off distances that are too great for the bow spacers; and very largely on charts in making measurements.

The clamp at the top, when set, ensures no change in the opening of the instrument. Many draftsmen, however, object to this clamp and consider that a properly made joint carefully handled will never slip. The small adjusting-screw on one of the legs enables most accurate work to be done. This is called the hair-spring adjustment.

To Use the Dividers.—Ease the clamp-screw at the head of the instrument; open the legs until the points are slightly wider apart than the required distance; set the clamp-screw at the head; with the “hair-spring” adjusting-screw close the movable point the required amount.

Distances must never be taken from the triangular scale with these instruments, as the points will ruin the scale; and this way is not as accurate as the correct method.

Always lay the triangular scale on the drawing-board and measure off the desired distance, marking it by means of one of the points of the bow spacers, or, better still, with one of the points of the dividers, or a pricker. As the inner sides of the divider legs are flattened, these flat portions may be slid along down the triangular scale and the points accurately marked.

Take care not to unscrew the “hair-spring” adjusting-

screw too much, as the screw will become detached from the point and the spring may be broken.

The dividers should always have the adjusting-screw of the "hair-spring" screwed "home" when put away.

Irregular Curves.—These are guides for drawing lines that are neither straight nor arcs of circles. When a series of irregular points are found through which a line is to be drawn, begin with some definite point and pick out the portion of any one of the irregular curves that seems most likely to fit for the greatest length. Test by laying this curved part along the line of points, moving the curve about; and, if necessary, trying other curves until the longest correct one is found. Draw in pencil the curved line until nearly to the end of the part that fits accurately. Never draw the line quite to the end of the unison of the curves. Before removing the irregular curve from its position, make on it faint pencil-marks defining the beginning and end of the portion drawn, and also make corresponding marks on the paper. Then remove the curve. The portion used may then be readily found when inking.

If the curved figure is a regular one, a reverse curve exactly corresponding to the one drawn will be required somewhere in the figure. This curve may be marked on the irregular curve by carrying the marks placed there across the narrow edge and to the under side, where the corresponding marks may be made. Then this curve will fit, if the right mark is placed at the point exactly opposite the original definite point of starting.

From the end of the curve drawn, carry on as far as possible a new curve, and continue until the entire curve is drawn.

It is especially important never to draw the curves quite to the point of separation of the required curve and the one on the irregular curve, as it will be found difficult to begin a new portion of curve exactly in agreement with the one ended. This is the most difficult part of the use of the irregular curves—to have the end of the one and the beginning of the other line in unison.

In pencilling and inking with the irregular curves as guides, the pencil or pen must be turned in the fingers so as to be tangent to the curve drawn at all points.

Where the irregular curve already contains numerous pencil-marks, the new marks may be connected by lines for certainty of finding them when inking.

If the points through which the curve is to be drawn are far apart, it is often well to lightly pencil the curve free-hand and then draw the portions of it in pencil with the aid of the irregular curve; but never fail to draw in pencil first, and mark the irregular curve for inking. Do not attempt to draw the curve in ink without pencilling it first.

For small curves it is often a good plan to cut a special curve from a thin strip of wood or from a card that is sufficiently thick and stiff.

Protractors.—These are used for laying off angles. They are seldom used in machine drawing, but are largely used in surveying work of all kinds.

The protractors should not be used on the drawing-board for angles that can be made by the aid of the triangles.

There are many forms of these instruments, from the heavy metal frame with the swinging arms to the plain metal, horn, or celluloid article; for ordinary drafting-room work the plain metal, horn, or celluloid kind answers all purposes, as the number of degrees of irregular angles would be stated on the drawing.

How to Use the Protractors.—Place the 180° marks at either side of the arc (not necessarily at the end of the arc) on the base line from which the angle is to be measured, and slide the protractor along until the notch or mark in the middle of the base coincides with the vertex of the angle. Mark at the outer circumference the point through which the line defining the angle is to be drawn, noting that the inner marks read from one end of the arc, and the outer from the other. Remove the protractor and draw the line.

Erasers.—The rubber ink-eraser should be used very carefully on the drawing-board. It erases only a little more rapidly than the rubber pencil-eraser and is likely to ruin the surface of the paper so that it is very difficult to make a good ink-line afterwards. With a good quality of paper it may be used with comparative safety. The surface must be well polished afterwards.

For erasing on tracing-cloth, the ink-eraser only should be used. Afterwards the surface should be rubbed with a soap-stone pencil and well polished.

When an error is made or work in ink is to be removed for any reason, use the rubber pencil-eraser and the erasure may be made and a good line drawn afterwards. Time and light pressure are required, but the line will be removed eventually. As the small particles of paper removed become electrified, it is necessary to remove them occasionally by brushing with the back of the fingers or a cloth; after the ink-line is removed, rub the paper with some smooth, hard substance like the handle of the metal ink-eraser or the end of a knife-handle or a smooth piece of ivory or agate. After that a new line may be drawn with safety. When the new ink-line is to be a heavy one, it is well to draw it in parts; in each portion have the pen closed for a comparatively fine line, and allow it to dry before drawing the next width of the line.

The metal eraser should never be used when a new line is to be drawn. It is used to remove errors where an ink-line is drawn past the required point. It must then be used with great care. Use this eraser with the hand above the handle and the fingers and thumb well down towards the point. This is to prevent the sharp point of the metal from touching the paper, as there is no way of telling how deeply this point may cut. The flat of the knife-point only must be allowed to do the erasing.

Hold the eraser as described and make a fine, light cut at the point where the error begins, and then draw the small

amount of the surface of the paper cut through away from the good line. This leaves a clearly defined line as an ending of the good work. After that the erasure may be carried on by drawing the flat edge of the eraser gently along the paper.

In case a line may be too broad, it may be made narrower by the use of this eraser. Begin at one end of the too heavy portion of the line and make a fine cut as described, continuing the cut carefully along the line and making the line of the desired width. Then each portion may be drawn away gently with the eraser as described.

The black, sponge rubber is used for cleaning the drawing after it is completed. This is rubbed across the drawing gently after all the pencil-lines have been erased by the rubber pencil-eraser. This rubber will simply clean off the dust and discolorations made by the hands and instruments. In using it, however, do not rub longer than absolutely necessary at any part of the drawing, as it will dull the ink effect. Especial care should be taken at parts of the drawing where the ink work is heavy, as its effect will be seriously marred.

The best cleanser for the drawing-paper is stale bread that is not too dry.

Erasing-shields.—These are of thin metal with small openings of various shapes that will fit over small portions of the drawings to allow of erasing just what is desired and no more.

Horn Centers.—These instruments are used when a great many circles are to be drawn from the same center. They should never be used except when absolutely necessary. If the compasses are fairly bent as described and the bending is done for each circle of varying radius, the center in the paper will generally last as long as is required. In case the center in the paper is enlarged or torn, the horn center must be used, but, as a rule, it is a sign of carelessness if a horn center appears on the drawing-board. Of course, in special drawings, where trams are used, or in line shading, the horn center is

absolutely necessary, but not in the ordinary work of the drafting-room.

In using the horn center, it is placed with its center as nearly over the required point as possible, and is pushed down until the three points on the under side are firmly imbedded in the paper and wood; in other words, it is pushed "home." Then, great care must be taken that the point of the compass is placed on the horn center directly over the correct point.

In place of the horn center small pieces of thin transparent substances such as isinglas or sheet gelatine are used. These have no points on the under side and depend on the friction of the paper for their position. These materials are used only when an especially handsome drawing is to be made and it is desired that no holes shall be made in the paper by the points of the horn center. Ordinarily the horn center is used.

To Use Isinglas or Sheet Gelatine.—Cut up into pieces about $\frac{1}{8}$ " square. Make a hole in the middle with a shouldered needle and turn the needle a few times so it will be loose; moisten the under side of the isinglas until it is quite soft; then press it on the spot where required, using the projecting needle-point as a guide; press it hard against the paper until it adheres; remove the needle-point; and then with the agate polisher press the surface of the isinglas center down until it is flush with the surface of the paper. This prevents the T square from lifting it from its position.

Brushes.—These are of camel's hair. Their uses are described under "Shading."

Pricker.—This is practically a needle-point set in a handle, and is made of various forms. It is used in marking off dimensions. Press downward with a twist; this gives better control.

Beam-compasses or Trams.—These are flat, wooden rods of various lengths with two clamps that may be secured at any points of the length. One clamp contains a "center," and the other either a pencil- or pen-point. They are used for drawing large arcs.

Foot Rule.—This is used in sketching, dimensions taken to the nearest thirty-second.

Calipers.—These are of two kinds, outside and inside, used, as the names imply, for measuring outside and inside distances when a rule cannot be used. They are used particularly for finding the diameters of cylinders.

In measuring the diameter of a cylinder use the bent calipers; open the calipers until they are slightly larger than the diameter of the cylinder; bring them to the diameter by gently tapping them on the outside or inside of the legs as necessary. Hold the calipers loosely in the fingers and as nearly as possible at right angles to the work being measured, and above the work if possible, so that the calipers will themselves assume the position where the measurement is least. Raise and lower them slowly and adjust them until a very slight touch is obtained. To measure the distance thus found, place the calipers on the foot rule with the flat face at the end of one leg just against the end of the rule and in line with the marks for the sixteenths; the measurement may be read from the flat face of the other leg.

The inside calipers are the straighter ones and are used in the same way in the interior of an opening, but the flat surfaces at the ends of the legs are now facing away from each other. To measure the distance found, lay the calipers on the foot rule so that the flat face at the end of one leg rests along the side of the rule and in line with the marks for the sixteenths and at one of the inch-marks; the measurement is read from the flat face at the end of the other leg. It is best not to bring the first leg to the end of the rule, as it is difficult to determine when it exactly agrees with the edge. By standing rule and calipers on a flat surface, of course, the edge may be used, but the other method is sufficiently accurate. It is found that the sense of touch becomes rapidly and accurately developed in using the calipers, and that dimensions found in this way are reliable.

Splines.—These are thin strips of wood or rubber that are held in place by weights, and are used for drawing irregular curves when they are long and it is not convenient to use the irregular curves furnished. The section of the spline is shown in Fig. 13.

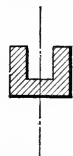

FIG. 13.

Spline-weights of lead with metal projecting wires called "fingers" are used for holding the splines. The fingers project from the ends of the weights, and the ends of the fingers are thinned and fit into the space in the top of the splines, thus holding the easily bent splines in any desired position. This leaves the surface of the spline away from the weights free, so that this edge may be fitted to any curve and lines may be drawn.

Lead-wire.—This is used for sketching whenever a peculiar contour is to be copied. The wire is bent to fit the outline to be copied, and marks are made at certain fixed points that may be found on the drawing-board. The wire is carried to the board and the outline copied. These are used only in one plane.

Paper-cutters.—These are special devices for cutting the paper from the drawing-board, but the knife answers all purposes.

GENERAL DIRECTIONS.

Stretching Paper. — For ordinary work, the paper is secured on the drawing-board with thumb-tacks, as described. For complicated drawings and for those to be tinted, the paper is stretched on the board.

Prepare the drawing-board by removing all old paper and glue, and see that the surface where the paper is to be placed is smooth and has no holes.

Raise the sheet of paper and look through it to the light and find the water-mark or other mark of the manufacturer. When the paper is held so that the name may be read properly, the nearest surface of the paper is the one on which to draw. Lay the paper drawing side up on the drawing-board. At

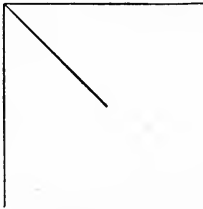

FIG. 14.

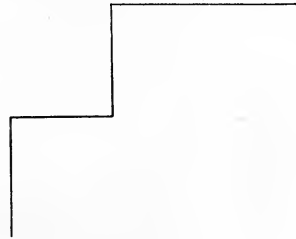

FIG. 15.

each corner either make a diagonal cut about an inch long, as in Fig. 14, or cut out a small square about three-quarters of an inch either way, as in Fig. 15.

With the fingers, turn up the edges of the paper along one of the longer sides about $\frac{3}{4}$ ''; repeat on the other longer side; then turn up the narrow edges in the same manner. Turn the paper over and let it rest on these edges. With a sponge or

damp cloth thoroughly moisten the paper except the edges now turned down. The paper will absorb a large amount of water. The object is to have the paper equally wet all over, and especial care must be taken to moisten the corners. Carefully keep the bent edges dry. After the paper is soaked well, turn it over and place it in the most central part of the board. With a brush lay the paste or other adhering substance evenly along the turned edge of one of the longer sides of the paper. A paste made of dextrine and water is excellent when the board is unvarnished. Press this edge firmly down on the wood, rubbing it along from the center to either edge with the fingers or a smooth substance. This tends to stretch this edge somewhat. Treat the edge of the opposite longer side of the paper with the paste and lay that down as before. After this edge has begun to stick, begin at the middle of the length and draw on the edge with the fingers, endeavoring to stretch it tauter by pulling directly away from the edge already pasted, constantly, at the same time advancing the hands from the center towards one edge, while holding fast all the stretch obtained. Then work from the center towards the other edge. The object is to stretch the paper across the board and at the same time to stretch the edge lengthwise. After this edge is pasted, treat the sides in the same manner.

After this go over the entire board and draw the edges, endeavoring still further to stretch the paper. The point is to draw and hold until pasted. Often large wrinkles may be drawn out of the paper in this manner. When stretched, leave the board in a horizontal position to dry. In a few hours it will be found that the paper will be stretched taut.

A more rapid and very successful method is as follows: Place the sheet of paper in a vessel of water and allow it to become thoroughly soaked and thus enlarged. Remove the paper and allow the loose water to drain off. Place the paper on the board right side up. Wipe with a towel or other cloth along the edges to be pasted, drying them as much as possible.

Apply the paste and press the paper on the board. No cutting of corners is required, and no stretching the paper by pulling along the sides. When dry the paper will be well stretched.

The board with the wet paper should be kept in a horizontal position until the paper is dry.

In damp weather the stretched paper may absorb enough moisture so that it will again wrinkle, especially in the corners where it may not have been sufficiently moistened when stretched. In this case, with a knife make cuts along and outside of the cutting lines of the paper in the neighborhood of the wrinkle. Cut enough so that the paper will lie flat and the T square will pass over the wrinkled spot with no trouble. The shrinkage of the drawing-boards often causes these wrinkles, and it is often necessary to cut lines along the whole of the top and bottom of the paper and a short distance up the sides before the T square will lie flat. Cut only a small amount on the sides and as much on top and bottom as is necessary. Generally it is necessary to cut clear across top and bottom. The paper is still stretched by being held at the sides, and good work may still be done on it. Never put a thumb-tack in the paper where it has been cut as stated above. Let it lie flat.

Profile Drawings.—These drawings are those of figures on a plane, and are principally used in Plane Descriptive Geometry and for the purpose of learning how to use the various instruments. The first two drawings are Profile Drawings.

General Arrangement.—In making drawings of complicated arrangements of mechanism, as a ship, machinery, pipelines, turrets, etc., a general plan is first made from the main ideas of the results to be accomplished. In the case of the ship, the general plan shows the location of the many important parts of the structure, and is made in a very general way with no attempt at detail. In the case of a complicated engine, the general plan called "General Arrangement of Machinery" shows how the machinery is to be assembled after the indi-

vidual parts are completed. The same applies to the turret, the positions of the various mechanisms, guns, rammers, elevating-devices, etc., being shown.

In these general arrangements only the principal dimensions are given, so that, when each portion is completed, it may be secured in its proper place. There is no detail, though the general appearance of the details may be drawn.

Working Drawings.—After the general arrangement is completed, working drawings are made of the various portions that make up the complete mechanism. Each portion is drawn in the minutest detail, so that the many workmen employed in manufacturing the various articles may be able clearly to understand how each one is to be manufactured. As many views as are necessary to a thorough understanding of the subject must be made. It is not sufficient to make the views to an exact size on an exact scale; dimensions must be placed on the working drawings so that it will not be necessary for the workmen to use a rule in order to determine the size of any important part or minor detail of the piece worked upon. These dimensions must be clearly placed on the drawing.

Working drawings are sometimes made on white paper in pencil, inked and finished, and then varnished and sent directly to the shops. Sometimes they are finished as before and are then traced and blue-printed and then sent to the shops. They are traced by placing over them a transparent paper or cloth and a copy made. These drawings on transparent cloth or paper are then treated as films used in cameras and prints are made. Generally blue-prints are used. The great advantage of tracing and blue-printing is that as many prints as desired may be made.

The business method at present is to make the drawing in pencil on white or on cheaper brown drawing-paper and then to trace directly from the pencil-work, the tracing being the only finished drawing made. This tracing is then the "original" and is carefully preserved, while the pencil drawing

is destroyed. In this case the pencilled drawing is completed: dimensions, legend, etc., but no shade lines or hatching.

Before giving the method of procedure in making drawings, certain methods used will be explained. These should be referred to when drawings are being made as the need of using each one appears.

Views.—In general, mechanical drawing of the practical kind requires only orthographic projections—those where the rays of light are all parallel for each view of an object and where all lines are represented full size or to scale. In order to show an object clearly by mechanical drawing, it may be necessary to make several views of the object. These views are taken from positions at right angles with each other. The first view to be considered is the Plan. The object may be supposed to rest on the drawing-board or the ground, and the draftsman is directly over each point of the object and endeavors to represent the object on paper as it appears to him from his point of view. Measurements are taken and the object drawn.

The next view to consider is the Front Elevation. Leaving the object in its position, the draftsman moves to one side—generally the longest side—and is supposed to have his eye for each point of the object in a direction at right angles to the vertical and at right angles to the central plane of the Plan view. He takes measurements from this point of view and draws the object as it appears to him.

The next view is the Side or End Elevation. The object remains as before and the draftsman moves to one end—generally to the end on the right of his position for the Front Elevation—where, for each point of the object, his eye is supposed to be in a direction at right angles to the central planes of both the Plan and the Front Elevation. He takes measurements and draws the object as it appears from that point of view.

These three are the views generally taken; in a few cases, where the object has a complicated structure, it may be neces-

sary to draw the other End or Front Elevation and occasionally it may be necessary to draw a Bottom View, as though the draftsman were underneath. In that case the object is turned bottom up while the dimensions are taken, if possible.

Another way to look at this method of making the different views is to first consider the object resting as before and draw the Plan. Then consider that the object is tipped over through an angle of 90° , the top moving away from the draftsman as he stands in position for drawing the Front Elevation; by placing the eye directly over the object in the new position, a drawing may be made as for the original Plan. For the end view, the object in its position for Front Elevation may be considered to be tipped over through an angle of 90° , the top moving to the left of the draftsman as he stands in position for drawing the Front Elevation; by placing the eye directly over the object in the new position a drawing may be made as for the original Plan.

The other Side Elevation, Front Elevation, and Bottom View may be considered in the same manner, by revolving the object as required in each case.

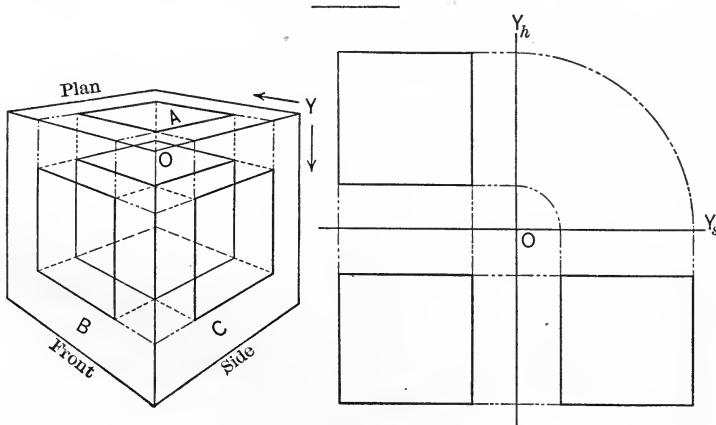

FIG. 16.

Another method.—Imagine the object partly surrounded by three transparent planes *A*, *B*, *C*, and that on each plane is projected an outline of the object, bringing the Plan or top view on plane *A*, the Front Elevation on plane *B*, and the Side Elevation on plane *C*. Flatten out these planes by separating two of them along the edge *lm* and moving them in the directions shown by the arrows, and the views will be arranged as shown to the right.

Besides these views it may often be necessary to make other special views of the object, or special sections, or special enlarged views of minor parts of the mechanism. These may be placed on the board according to judgment; as a rule, however, it is well to place these lesser views as near their position on the larger views as possible.

The views need not be drawn in the order given, as it may very much simplify the work if the Front or Side Elevation is drawn first.

The method of arranging the views is as follows:

Plan.

Side Elevation. Front Elevation. Side Elevation.

Bottom View.

As the Bottom View is seldom required and one of the Side Elevations generally suffices, the ordinary arrangement is as follows:

Plan.

Front Elevation. Side Elevation.

Projections.—In describing the method of considering the object as revolved through angles of 90° , it will be noted that each point of the object moves in a plane and keeps its same relative position from any edge that it had originally.

Consider the Plan as drawn and place the object over the drawing. It will of course exactly cover the lines drawn.

Revolve the object for the Front Elevation—that is, so that the top moves up the drawing-board—and it will rest on its side above the Plan. Draw the object directly down the board until below the Plan with any desired amount of space between. Measure the object as it appears from a point directly over it; remove the object and make the drawing. It will appear as

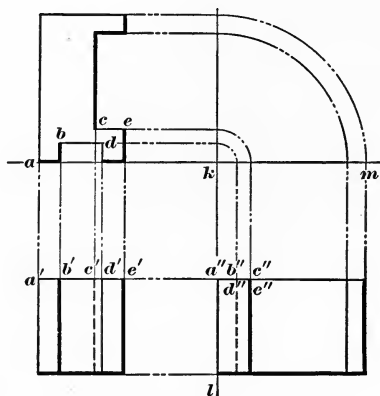

FIG. 17.

shown in the Front Elevation. In this case the narrow side is taken for the Front Elevation. Note that each point of the object described a line in a vertical plane or one up and down the board, as it was revolved; and that the point was drawn along, after being revolved, in a vertical direction or along the drawing-board, so that the point always remained in the same plane; and the plane was certain to contain the point no matter at what part of its revolution or movement vertically. Then draw dotted lines vertically from any points, as *a*, *b*, *c*, *d*, to represent these planes, and the points will at all parts of the movement be somewhere in the planes represented by these lines.

In the same manner take the object as resting on the Front Elevation and revolve it to the left and then draw it along the

paper to a convenient distance to the right. Again, these points, a , b , c , d , etc., will revolve in a plane, and a horizontal line will represent the plane in which they move. As they are all in the same plane, one dotted line represents the one plane in which they all lie. The point which was revolved to a' now falls at a'' ; b , which was projected to b' , now falls at b'' ; c , at c' and c'' ; d , at d' and d'' , etc.; b'' and d'' fall at the same point; also c'' and e'' .

These are called the projections of the point. There are many methods of describing how to make projections, but this method explains how they are used in practice on the drawing-board.

Another method of projecting the points from the Plan to the Side Elevation is shown in Fig. 17. After the Front Elevation has been drawn by projecting from the Plan as far as possible and finishing by putting in the other lines as measured, the line kl is taken, at any convenient distance from the Front Elevation, as the side line for the Side Elevation. Extend the line kl upwards and project on this line the points of the Plan that are needed in order to draw the Side Elevation. On k as a center, swing these points down to the line km and project them from this line to the Side Elevation.

This method is more of a Descriptive Geometry one than a drafting-room method (though it is sometimes necessary there), and should not be followed as a rule.

Distances are seldom measured more than once on a drawing if they can be readily projected.

Lines.—There are three kinds used in Mechanical Drawing; full, broken, and dotted. See "Lines to be used on Drawings," at end of book.

The full line is a continuous line. The full line in black ink is used to show any edge or boundary of a surface when the edge is in sight from the point of view from which the drawing is made. When red ink is used, center lines are drawn as full lines.

The broken line is one composed of short or long dashes with spaces between. The spaces should be about one-eighth the length of the dashes. For ordinary work in black ink the dashes are about one-eighth of an inch long and the spaces about one sixty-fourth of an inch in length. These lines are as heavy as the full lines of the drawing, as they are equally important, but are never made as heavy as shade lines. The broken lines in black ink are used to show any edge or boundary of a surface when the edge is concealed from view.

When two broken lines are parallel and close together, break joints with dashes and spaces.

The broken lines are also always used for dimension extension lines and for dimension lines. The lengths of the dashes and spaces vary in this case, as explained under "Dimension Lines."

The dotted lines are occasionally used for the projection of points from one view to another. They are seldom used except for the first drawings and when an exceptionally difficult intersection is made.

The dotted line is a series of the shortest dashes that can be made, the spaces between being fully as great as the length of the dashes, so that the effect is that of a series of dots. These dotted lines are always fine lines, as they are subordinate lines.

Broken and dotted lines are never shaded.

Center Lines.—All drawings of objects are made from center lines. These are the first lines drawn in sketching and in work on the drawing-board. When an object is to be sketched or drawn, it is examined and the necessary views decided upon. Next determine the positions of the center lines of the object. These lines are as a rule imaginary and pass through the center of figure of the body in the three directions at right angles to each other, as must be the case from the three views generally drawn. If the body is uniform about these centers, as a cube, there is no difficulty in determining the center lines; if it is a cylindrical body, there is again little

difficulty in placing the center lines; and so with any body of revolution. In most bodies, however, there is some system so that the middle of the width of one side may be taken as a starting-point in deciding on one center line, and the others are arranged to the best advantage. In the case of a cylindrical body, measure the diameter with the calipers and the center line will be half-way.

After the center lines are decided upon, measurements are made with regard to them and the sketch or drawing constructed from them after they are drawn in. The cylindrical part is measured from the center line, the radius laid off either way. Distances parallel to the center line are measured along that line and vertical lines are drawn through the points marked. Then the distances from the center on these vertical lines are measured and laid off and the positions of the points in that view are established. Each point is in this way established in one view and then is projected to another view, if possible, so that the least number of measurements may be made.



The positions of the views are given under the heading "Views." Next measure the extreme or "over-all dimensions" of the object and decide on the scale to be used and calculate as to where the center lines of the various views must be placed. This requires considerable care in order that the views may all be placed on the drawing-board without interfering with each other and so that the points may be properly projected for the views. As a rule, the positions of the center lines for the Plan, one of which extended will be a center line for the Front Elevation as well, are decided upon first, if a Plan is to be drawn. After that the positions of the center lines of the Front Elevation, one of which will also be a center line for the Side Elevation, are decided upon. Then the other or vertical center line for the Side Elevation is decided upon. All these center lines should be drawn in pencil before any work is done on the drawing.

These center lines should be drawn with the greatest care and should be firm, clean lines, as measurements are made along and on either side of them, and the accuracy of the work depends on the accuracy of the center lines.

Center lines are drawn for each view of the object represented, and for centers of bolts or bolt-holes and wherever centers are used in constructing the drawings. They are inked in after the black-ink work is entirely completed, and are drawn dash-dot in black ink with the lines extending beyond the figures for a distance of from $\frac{1}{4}$ " to 1", depending on the size of the figure. The system of extending the center lines until they meet other center lines and thus form rectangles is not approved.

Shade Lines.—To give life to a drawing and to make it apparently stand out from the paper, shade lines or relief lines are used. These distinguish raised and depressed portions of an object. They are all of the same width and are about four times as wide as the original lines; in tracings they are still wider.

Shade lines are always drawn *outside* the original lines of the figure. The light is supposed to fall on the object in all views from the top left-hand (N. W.) direction at an angle of 45° from above; and, generally speaking, the heavy line marks the dividing edge between light and dark surfaces, though it often marks edges when both surfaces forming the line are in shadow.

The shade line begins and ends at its full width and does not slope at the ends, as, ; but is drawn .

The positions of these lines are largely conventional, but certain general customs prevail.

As a rule, the right-hand and lower sides of the figures are shaded; the opposite for interior openings.

In Fig. 18, *A* shows a central raised portion and *B* a depressed interior portion.

The question of the lines to be shaded may be studied by considering which edges would cast shadows if the object were placed so that the light came from the proper direction.

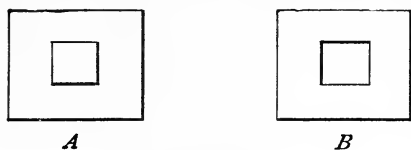

FIG. 18.

Place a 60° triangle on the drawing-board in position against the T square and then remove the T square. Shadows will be found at a , b , and c . Place a 45° triangle beside the

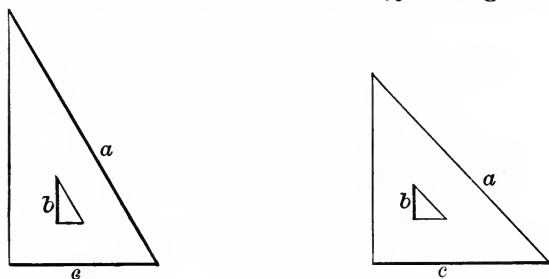

FIG. 19.

60° one and shadows will be found at b and c only. As the light now shines along the side a , there is no shadow, and hence no shade line. Turn the triangles the other way and remove the square and the shadows in both will be found at

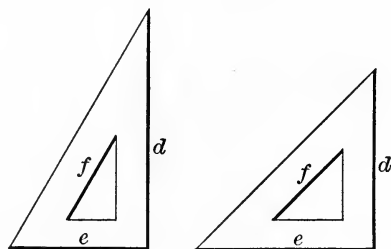

FIG. 20.

d , e , and f . Now turn the triangles about centers and note where the shadows begin and end on the different interior and

exterior edges while the turning slowly proceeds. Since all the rays of light are considered parallel and all come from the N. W. and from above at an angle of 45° , the shadows begin as soon as the direct rays of light fail to strike the edges.

The edges to have shade lines may generally be readily determined by eye, but if an edge away from the source of light is nearly in a N. W. direction, the question of the shade line may be determined by placing a 45° triangle in position on the T square. If the edge of the solid body farthest from the source of light is beyond the 45° point, so that the light does not shine along that edge, a shade line should be placed on the drawing.

Cylindrical and other curved surfaces are shaded.

When circles are shaded, the method given above of determining the shaded portions by using the 45° triangles will be followed. The shade lines begin at the points where the light fails to strike the edges. These points are determined by the 45° triangle placed on the T square and held just tangent to the arc; but a simpler way is to place the triangle on the T square in the reversed position with the diagonal edge at the center of the circle

This edge will be a normal to the tangents at a and b , and marks may be made there for the ends of the shade lines.



FIG. 21.

For an interior, as the inner line of the hollow cylinder in Fig. 21, the opposite part of the arc is shaded; the points of beginning and ending are found as before.

In shading these circles, it is generally customary to taper

the shade line to nothing at a and b and make it heaviest at c , the point of broadest shadow.

There are several methods of drawing these irregular shade lines. The best method is as follows (see Fig. 22): After drawing the original circle, begin again near a , but between a and c , and slightly spring the compass without changing the set of the instrument, following along a line like the outer portion of the line between a and b , through c . This requires a gradual springing open and a gradual closing of the instru-

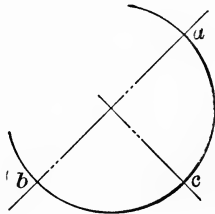

FIG. 22.

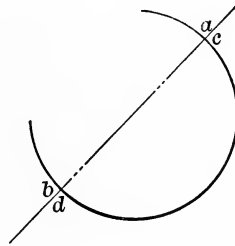

FIG. 23.

ment, and requires considerable practice before perfect work may be done. After the outer line is drawn, the space between the lines may be filled in by springing the instrument as desired, at the same time opening the pen-points wider. Always draw in the same direction, however, returning for each new sweep of line.

The heaviest part of the shade is about four times as heavy as the original line, as in the case of the straight lines.

Another method of drawing shade lines of circles is as shown in Fig. 23.

Begin at the point c near a and draw a heavy shade line (four times the width of the ordinary line) to a point d near b . From a to c and from b to d taper the line by springing the instrument as described above. This method is little used.

For irregular curves or for portions of arcs the points of beginning and ending of shade lines are determined, as with

straight lines, by the 45° triangles. In this case, the shading tapers from nothing to the full width, as explained in the second method of shading circles.

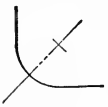

Fig. 24 represents a fillet, a small arc of a circle joining two straight lines. The point of beginning the shade is determined by the 45° triangle set at the center of the arc, and the shading is gradual up to the point of meeting the straight line.

Fig. 25 represents a curved surface like a section of a por-

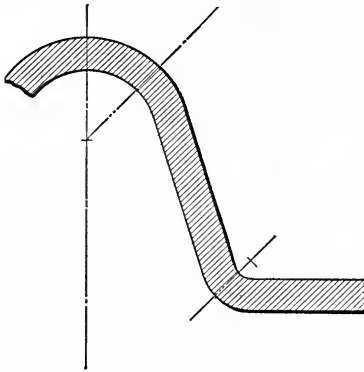

FIG. 25.

tion of a cylinder-head. The shading is shown. Note that the shade lines cross the figure at the 45° points.

When surfaces of separate portions of the figures are touching and are at the same level, no shade lines are drawn.

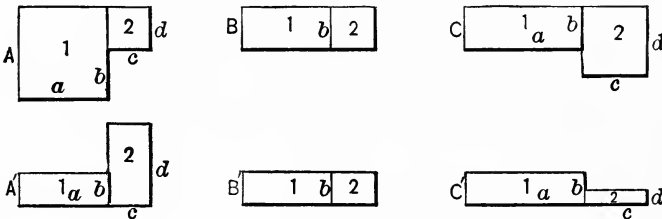

FIG. 26.

In *A* and *A'*, Fig. 26, block 1 is wider and lower than block 2. In the top figure or plan view, when looking down

on the blocks, the sides a , c , and d are shaded in accordance with the general plan; the line b is shaded only where it is free from block 2, as its edge in contact with block 2 cannot cast a shadow. In the lower figure or elevation, when looking at the side of the blocks, a , c , and d are shaded by the general plan, and b is shaded as it projects beyond the block 2.

In figures B and B' , where the blocks are equally high and wide, there is no shade line at b in either view, as the edges are on the same level.

In figures C and C' , block 2 is lower and wider than block 1. In the top or plan view, when looking down on the blocks, the sides a , c , and d are shaded by the general plan and b is shaded where block 1 is higher than block 2, as it may there cast a shadow; but the remainder of the line—that for block 2 only—is not shaded, as the light may strike that edge.

In the lower view, or elevation, when looking at the side of the blocks, the lines a , c , and d are shaded by the general plan, and b is shaded only where block 1 is above block 2.

As seen above, in shading one view of an object, it is often necessary to refer to the other views.

The shade lines are drawn outside the original lines so that

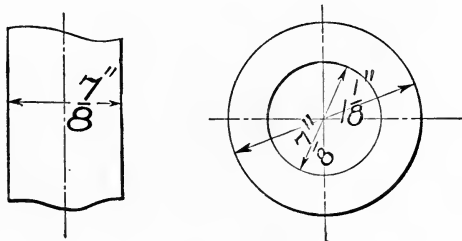

FIG. 27.

the inner dimensions may be retained and measurements accurately taken. This method also allows placing the arrow-

points used for marking the dimensions so that they just touch the inner edges of the figures, as in Fig. 27.

All the shade lines should be of the same width. Make a sample line on the border of the paper and often test the set of the pen with this sample line.

Shade lines are not shown in the pencil drawings.

Dotted or broken lines are never shaded.

Bolt-heads are shaded in various ways, but the best method is shown in Fig. 28. It will be observed that the general plan is followed.

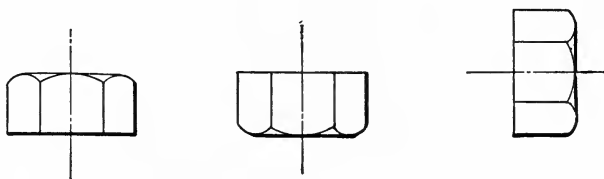

FIG. 28.

Where a bolt, rod, rivet, etc., is represented in elevation resting in a section, the shading conforms to the method shown in Fig. 29.

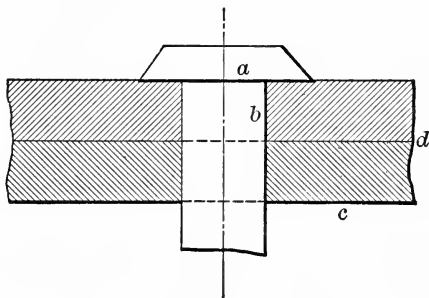

FIG. 29.

Shade *a*, keeping outside the head of the rivet.

Shade *b*, keeping outside the rivet.

Shade *c*, keeping outside the plate.

Shade *d*, keeping outside the section.

Shafts and other Cylindrical Objects.—In representing these on the drawing-board, it is best always to draw first the

view that shows the shaft as a circle. Measure off the radius from the center and strike in the circle. For the other views,

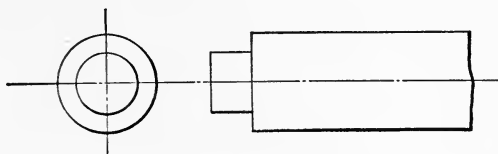

FIG. 30.

the straight lines may be projected from the arcs and time will be saved.

Sections.—If an object is cut through by an imaginary plane in any direction, the drawing showing the appearance of this imaginary cut is called a section. (See models of sections.)

The draftsman is supposed to be in a position normal to this cutting plane, and to draw what appears from that point of view.

Sections are drawn to show clearly a hollow interior or to clear up any part of the drawing that is not lucid from the other views, and considerable choice may be made in the positions of the cutting planes chosen. These are, however, usually taken either vertically or horizontally, though they are sometimes taken in other directions; but they are generally perpendicular to either a vertical or horizontal plane. Often a vertical plane is passed through on a radius on the Plan, and the section is swung around until it coincides with the plane of the paper, when it is drawn.

When a section is made, the drawing must show not only the part of the object in the plane, but everything beyond to the end of the figure.

Those parts concealed by the figure are drawn in broken lines. Sometimes portions of the object beyond the section plane may be omitted when the drawing would be too complicated; the main outlines are always drawn.

In making a Plan or Elevation, it is sometimes well to

make part of a view a section; or to remove a portion of the object to more clearly show the interior. In this case, the line of demarkation is always a solid black line made with the right-line pen, and is generally straight. This line is shaded in accordance with the directions under "Shading."

If a section is made at any plane, a heavy, broken line is drawn at that plane, and its extremities are marked *A.B*, *C.D*, etc., and the drawing of the section is clearly marked, Section *AB*, Section *CD*, etc.; or, Section on *AB*; or, Section on line *AB*.

The section drawn may not follow a plane, but may run irregularly across the figure; the broken line will follow the course of the section, however, so that its course may be clearly marked.

Hatching.—In making a drawing of a section, the portions where the plane passes through solid substances are "hatched." This consists in covering these portions of the surface with lines of various kinds, to represent the fact that solid substance is cut; and also to represent, according to accepted methods, the kind of substance that is cut by the plane. (See drawing of Standard Hatching at end of book.)

Hatching is never drawn in pencil; in black ink only.

The lines of hatching are of various widths apart, according to the size of the surface to be covered. For small surfaces the lines are quite close together, as in Fig. 31.



FIG. 31.

For larger surfaces the distance apart of the lines increases, until, for a very large surface, the lines may be as in Fig. 32.

It is also customary in making sectional views of very large surfaces to begin the hatching away from the edges, as shown in Fig. 33.

Still another custom, for reduction of the work of hatching large surfaces, is shown in Fig. 34.

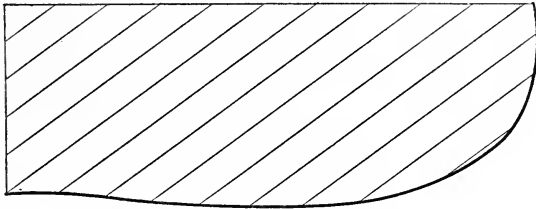

FIG. 32.

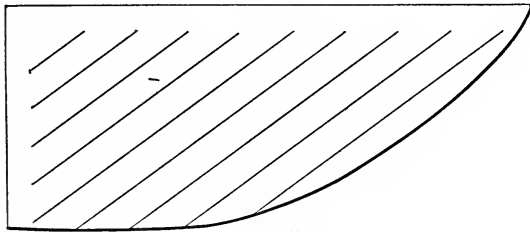

FIG. 33.

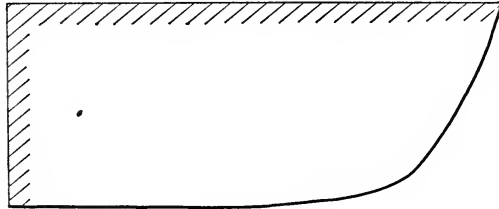

FIG. 34.

These last two conventions are used especially in drawings of embankments, etc. In machine drawings these methods are seldom necessary.

The lines for hatching are drawn with the 45° triangle as long as that angle can be used, the first ones used being always the lines from S. W. to N. E. on the board. When two surfaces cut by the plane of section join along a line, one of the sets of lines for hatching must be inclined one way 45° and the other one the other way 45° , so as to distinguish

the separate pieces readily. A third substance in contact with either of these two must have hatched lines at another angle; a fourth at still a different angle, etc. After the two 45° lines have been used, it is customary to draw the others that are necessary with the 60° triangle.

After the drawing is inked and dimensioned, the hatching is done. Set the pen to make clear lines, not too fine; decide on the angle of the lines and their distance apart; with the triangle at the correct angle begin at the portion of the surface to be covered that will allow the triangle, as it moves back for the hatching, to sweep from end to end of the surface; space the distance apart by eye and do not try to get a certain number of lines per inch. Do not attempt to have the lines come out even at any point; the distance apart is what is important; cover the entire surface that belongs to the same body with lines at the same angle and the same distance apart.

Hatching machines of various kinds are a mistake for beginners. A steady hand and a quick eye will soon cause proficiency, and the training is excellent.

When two surfaces of about the same size and the same material meet at a line and both are to be hatched, finish one hatching, and draw the other so that the various lines meet the first set of lines at the line of demarkation, as in Fig. 35.

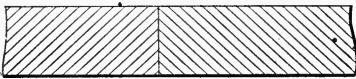

FIG. 35.

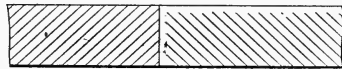

FIG. 36.

Another method that emphasizes the line of separation of the surfaces is shown in Fig. 36.

When the hatching consists of heavy and light lines, the surface is hatched across with the light lines as though those lines were the only ones to be used. The correct spaces are then filled in solid, producing the heavy lines.

To fill in these spaces, draw a fairly heavy line on either side of the space to be filled; go over all the spaces of any one portion of metal and allow these lines to become dry; then open the pen wider and fill in the central portions. These filling lines are drawn with the R. L. pen guided by the triangle. Never fill in with a writing-pen or use the R. L. pen as a brush.

This method of filling the spaces causes a loss of time, as the first lines drawn must be allowed to dry, but the method is a safe one. A more rapid method and a better one after sufficient experience has been acquired is to fill each of the spaces at once by drawing line after line until the surface of the space is covered with liquid ink. The ink will then dry evenly over the entire surface of the space. Also, this allows of continual advancement without waiting for lines to dry. Caution is necessary to keep the triangle well away from the liquid lines of ink or a bad blot will result.

Just as good ink-lines are required for hatching as for the other parts of the drawing. Do not attempt to make the lines of hatching too fine.

In doing hatching, glance back after drawing every ten lines

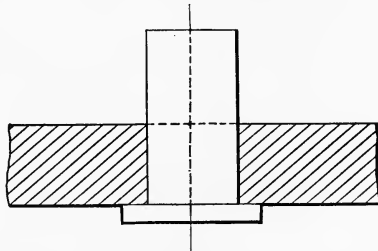

FIG. 37.

or so to see that the spacing continues regular; if irregular, gradually change the spacing until the exact amount is obtained.

In drawing sections where the plane passes through the center line of a cylindrical body, the cylinder is generally not

hatched, but is drawn in elevation, resting in the section. This refers to shafts, spindles, bolts, rivets, etc., as in Fig. 37.

Fig. 38 shows a Plan and Elevation of a steam-cylinder. The Plan is half in section, the section taken at the line *AB* of the Elevation. The upper half of the half-cylinder is removed and the section drawn, the lower flange of the

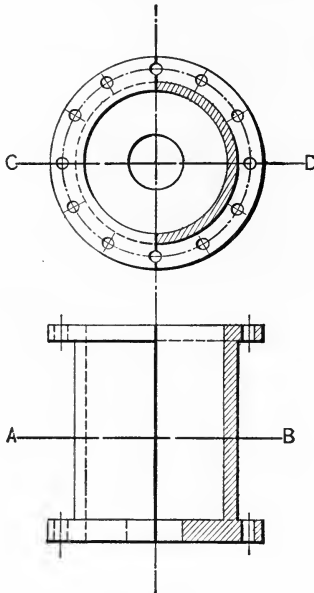

FIG. 38.

cylinder showing below the section. Each bolt-hole is drawn, and the centers marked, first by the circular center line and also by the short radial lines.

The elevation of the cylinder is also half in section, the section made at the plane *CD* in the Plan. In this case the front half of the half-cylinder is removed and the section drawn. The top and bottom lines of the flanges and the opening at the bottom are carried across to the center line. The lower line of the upper flange in the section is a broken line, as this rim of the flange is concealed behind the section.

The line at the right of the opening in the bottom of the cylinder is a full line, as the edge of the opening is in view though the curve drops away from the plane of the section.

Besides the main center lines for both figures there are drawn in the Plan the circular center line and the short radial dashes for the bolt-holes, and in the Elevation the short center lines for the bolt-holes. In the Elevation only the bolt-hole at the diameter is dotted in the outside view, and drawn full in the section. The other bolt-holes are shown sufficiently in the Plan. The hole in the bottom of the cylinder is shown in the Elevation, one edge drawn full in the section, and the other a broken line. The lines in both Plan and Elevation separating the section from the other view are drawn full black lines; their extensions, the center lines extended, are drawn in as usual. These black division lines are shade lines as explained under the heading "Shade Lines."

Breaks.—Breaks are used in drawings to represent that a shaft, rod, etc., is broken off. This is done when there is not enough space on the paper to draw in full length any portion of the mechanism, or when it is undesirable and unnecessary to use the space required for the purpose. These breaks are also used to show the shape of the cross-section and the kind of material of which it is composed. *They are complete in one view* and have no reference to any other view.

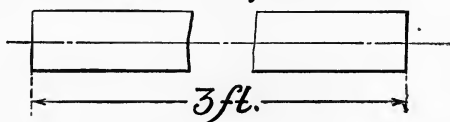

FIG. 39.

The irregular lines of fracture are made in black ink and are drawn best with the R. L. pen held carefully and twisted in the fingers, so as to keep the nibs always parallel with the line of direction of the movement. One of these lines is a shade line throughout; the other a light line. This adds much to the effect.

The rod must always be broken as shown, so that a piece is lost from the central portion and the ends left intact. In this way the total length or "over-all dimension" may be given.

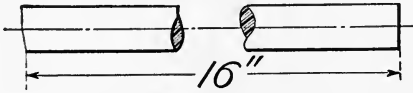

FIG. 40.

A variation is sometimes made in the method of making the break, as shown in Fig. 40. This shows the material, the hatching being done in accordance with the "Standard Hatching."

Often breaks are made of small portions of a piece of mechanism in company with a portion of a section, as shown in Fig. 41.

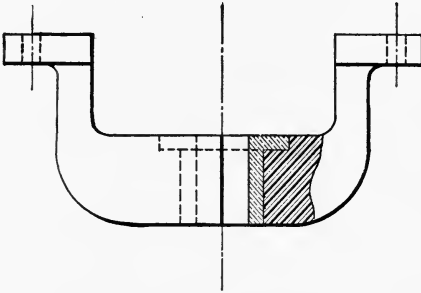

FIG. 41.

In order to show the kinds of metals, and to make more clear the interior of the mechanism, the irregular break is made. It is considered that this break extends inward to the center line and that the top half is removed. This irregular break is drawn as before with a R. L. pen used carefully.

Dimension Lines. Dimension Extension Lines.—Besides drawing the views of an object to correct size or to a certain scale, the dimensions of all parts of the object must be clearly placed on some of the different views, so that whoever may

have occasion to use the drawing will not be obliged to measure any dimension.

Auxiliary lines are used for these dimensions. They are light, broken lines in black ink and are drawn after the center lines are completed. The lengths of the dashes vary with the lengths of the lines.

When the dimension between two points is to be given, a black broken line is drawn from one point to the other, leaving a break near the center for placing the dimension. This line is drawn directly to the points and terminates at these points. The dimension is placed in the space left, and at the ends of the line are placed arrow-points, the points of the arrows exactly at the extremities between which the dimension is taken. See Fig. 42.

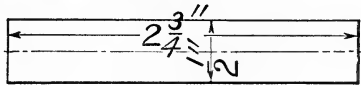

FIG. 42.

Frequently dimensions are given directly on the views of the object; but when this method crowds the drawing, the dimensions are placed beyond the outlines, and the distance to be marked is carried out from the outlines by dimension extension lines, as in Fig. 43.

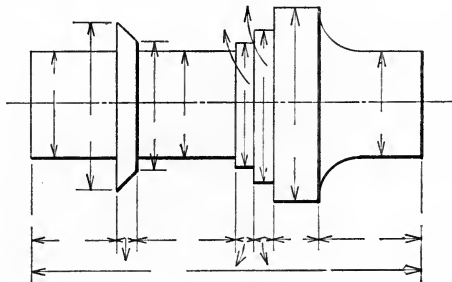

FIG. 43.

The position of the dimension lines is a matter of judgment, but the greatest care must be exercised not to complicate the

drawing and not to repeat the dimensions on the different views unless this may make a complicated drawing easier to follow.

Where two views are beside each other, corresponding points are often connected by dimension extension lines and the dimension lines drawn between these, as in Fig. 44.

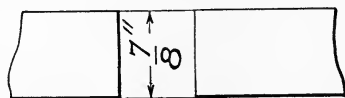

FIG. 44.

When dimension lines are outside of the views, these lines are placed at least $\frac{1}{4}$ " away from the outlines of the figures.

Center lines are never used for dimension lines, and the figures for the dimensions are not made over the center lines. The center lines are left as clear as possible.

If it can be arranged without too much difficulty, dimensions are not placed on hatched portions of the drawing; but, if it is necessary to do this, leave irregular spaces in the hatching so that the dimensions may be placed at these points.

Group dimensions that are for portions of the drawings that are alike; that is, place them near together.

"Over-all dimensions" should always be given for convenience in getting out material for work. This means the dimensions of the greatest limits of the object in the directions

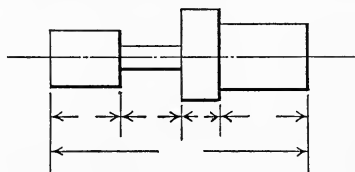

FIG. 45.

of the three center lines at right angles. These are generally outside of the figures and should be beyond all the other dimensions that are outside the figures, as in Figs. 43 and 45.

The figures for the dimensions are placed so as to be read from

the bottom or right-hand side of the drawing-board. They are placed so that the middles of the figures and the horizontal line of the fractions are in line with the dimension line; and the figures are at right angles to the line. As the dimension lines are drawn before the figures are made, spaces must be left while drawing the dimension lines. This requires especial care in dimensioning diameters of circles, as in Fig. 46.

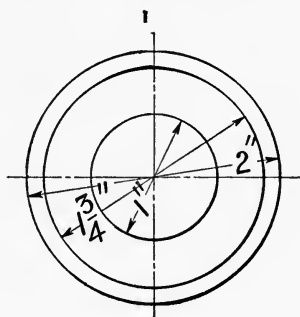

FIG. 46.

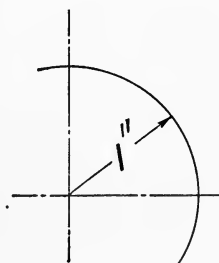

FIG. 47.

All the dimension lines are in the two quadrants, as shown.

Diameters, not radii, are dimensioned where possible. If radii must be dimensioned, place the arrow-heads at both center and circumference, as in Fig. 46.

Dimension extension lines are broken lines made with black ink and extend a short distance beyond the points where the dimension arrows are placed. See sketches 43 and 45.

The dimension and dimension extension lines are made with dashes from $\frac{1}{8}$ " to $\frac{3}{4}$ " long, depending on the lengths of the lines. The spaces between the dashes vary from $\frac{1}{32}$ " to $\frac{3}{16}$ ". These lines are never heavy lines.

Arrow-points are drawn in black ink with a fine writing-pen—not with the R. L. pen—and the points of the arrows touch the lines between which the dimension is to be given. The diverging lines of the arrow-heads make an angle of about 60° with each other. These diverging lines are light, clean lines from $\frac{1}{16}$ " to $\frac{1}{8}$ " long.

When the distances are small, these arrow-heads are placed on the outsides of the lines, pointing towards each other, and the dimension is either placed between the points or is carried to one side with an arrow pointing towards it from the space to be measured. See Fig. 43. Dimensions so carried away are placed so as to be read from the same direction as if in their correct positions.

The figures for marking the dimensions are made in black ink with a writing-pen that is not too fine. They are made clear and prominent. The shorter dimensions must have as prominent figures as the large ones. These figures are $\frac{1}{8}$ " high and stand at right angles to the dimension lines. When fractions are used, the line separating the numerator and denominator is horizontal, as $\frac{3}{4}$ ", not $\frac{3}{4}$ ". When mixed numbers are used, the inch sign is placed after the fraction, as $2\frac{3}{4}$ ", not $2''\frac{3}{4}$.

When dimensions are given in decimals, the inch sign (") is placed over the zero mark; as, $2''.375$, not $2.375''$.

Up to and inclusive of $24''$, dimensions are given in inches; beyond $24''$, the dimensions are given in feet and inches. For feet use "ft." or "feet," instead of the character ' $'$ '; as, $2\text{ ft. }6''$.

Dimensions are given in feet, inches, and fractions of inches. The fractions of inches used are halves, quarters, eighths, sixteenths, thirty-seconds, and occasionally sixty-fourths. Fractions are always reduced to their lowest terms. The total height of the fraction is about $\frac{1}{4}$ ".

The diameters of cylinders and strokes of engines are given in inches. These are practically the only exceptions to the above.

In locating bolts or holes, if they are uniform on both sides of the center line, draw a circular center line through the centers and give the diameter of this "bolt circle." This gives the distance between the centers of opposite bolt-holes and thus the radius of the bolt circle. Mark the center of each bolt-hole with a short radial line.

If they are not uniform, give the distance from the center

line to the center of the bolts. Occasionally it is necessary to give the distance between the center of the bolt or hole and the nearest edge of the object; but, in general, distances should be given from the center lines. See Fig. 48.

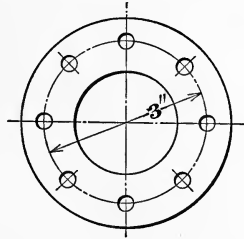

FIG. 48.

The number of bolt-holes defines the angular distance apart.

On the drawing-board do not draw the dimension extension lines and dimension lines in pencil, and do not put down the dimensions in pencil unless a tracing is to be made from the pencilled work. This is all done in ink after the drawing is completed.

On the drawing-board draw first the dimension lines and then the arrows; this is reversed in sketching.

Threads.—The screw-thread cut on a bolt is for the purpose of allowing the bolt to advance in the hole as it is turned around. As the bolt turns around once it advances a certain distance, called the “pitch” of the thread. The nut that may turn on the bolt has a thread cut on the inside with the same pitch as the thread on the outside of the bolt. The thread cut on the bolt is called a “male” thread, and that in the nut a “female” thread.

If we follow the top of an ordinary screw-thread around the bolt, we find that for a complete revolution we have advanced one thread. Hold the bolt in a vertical position and the front elevation of the bolt shows that the view of the path of the point we followed is a curve. This curve slopes upward from left to right and then passes behind the bolt and slopes upward from right to left; it reappears at the top of the next thread.

Thus we have advanced one pitch. In half the revolution one half pitch was advanced. The same happens if we follow the path of the bottom of the thread.

To represent the threads on the drawing-board, draw the center line and draw parallel to it lines for the outside diameter of the bolt.

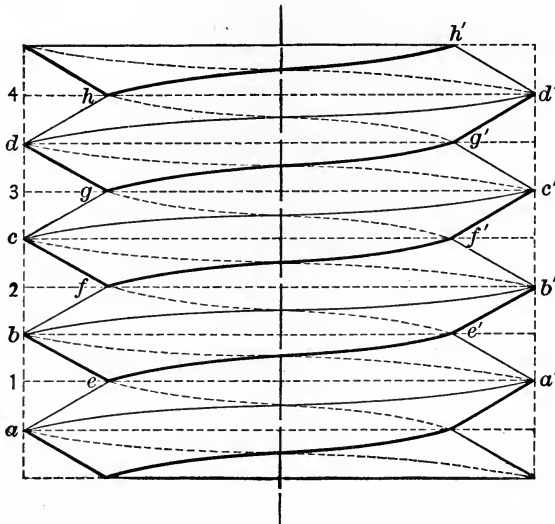

FIG. 49.

Lay off on the left side the pitch lengths ab , bc , cd , etc., and the half-pitch lengths at 1, 2, 3, etc. Draw horizontal lines through these points. Then the top of one of the threads will be represented by the curved line from a to a' , as the distance travelled longitudinally for one half-revolution will be one half-pitch. The other half of the revolution will cause the top of the thread to travel behind the bolt in a line represented by the dotted line $a'b$. The other tops of the threads will be parallel to these two lines, as the same cycle is repeated farther along the bolt.

The thread represented is called a triangular thread, and the standard angle for the sides of the thread is 60° . From

the points a and b draw 60° lines to meet on the line of half-pitch at e . This, then, is the position of the beginning of the root of the thread. The root will advance to e' in one half-revolution and the moving point will follow the curved line ee' . During the other half-revolution this point will follow the curved line $e'f$ behind the bolt. These lines, $aa'b$ and $ee'f$, represent, then, the form of one thread for one revolution. As the other threads are exactly the same, they are simply copies of this first one.

The curves made are readily found, as they are helices, and for every portion of a revolution an equal portion of the total pitch is passed over longitudinally.

It is customary to show the threads as shown in Fig. 50. The rest is shaded according to the general plan.

In making drawings, these lines are seldom drawn as curves. They are so near straight lines that they are usually represented as straight. Fig. 50 shows the appearance of the

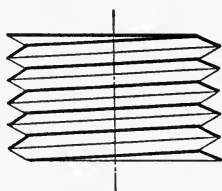

FIG. 50.

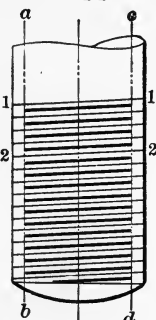

FIG. 51.

threads as drawn when threads are represented at all.

The straight lines simply replace the curved ones, and the broken lines are not drawn.

To still further simplify the representation of threads the portion to be threaded is shown as in Fig. 51.

The finer lines, 1 1, 2 2, etc., represent the tops, and the heavy lines the bottoms, of the threads. The distance apart

of the lines is not measured, but is spaced by eye as in hatching. This distance varies for different diameters, being smaller for small bolts to represent approximately the number of threads per inch of length.

The finer lines are drawn first. In order that the heavy lines may begin and end uniformly, draw fine pencil-lines on either side and equally distant from the side lines of the bolts, as *ab*, *cd*. Draw the heavy lines with these lines for guides for the beginning and ending, and place them by eye in the middle between the light lines.

To still further simplify the representation, sometimes the heavy lines are omitted entirely, but this is not customary except for very small bolts.

To find accurately the angle at which to draw these representative lines it is first necessary to know the number of threads to the inch.

If the drawing is made from a model, lay a rule along the top of the thread so that one ridge corresponds with any inch-mark of the rule. Count the number of ridges for one inch of length. If the number is 6, 8, 10, etc., this gives the fraction of an inch occupied by the length of one thread, or the pitch. If there is no model and the bolt is standard, consult a Table of Standard Bolts and Nuts, which will give the number of threads per inch for the diameter of bolt required.

A Table of Standard Bolts and Nuts for the United States Navy is found at the end of the book.

Lay off this length on the left side of the bolt and draw two horizontal lines through the marks. Since the thread must advance longitudinally one-half of one of these divisions for the half revolution, one-half this height will show the limiting height of the right-hand end of the line. See Fig. 52.

The lines through *a* and *b* are apart a distance equal to the pitch. The line through *c* is at the half-pitch. Then *ad* is the line sought.

As a rule, the slope of the line may be determined with

sufficient accuracy by eye. As the height of this line longitudinally is one half-pitch, double this height must separate the lines longitudinally. See Fig. 53.

After drawing ad with the slope determined by eye, project d across to b ; double ab : ac is the pitch, and the next line begins at c .

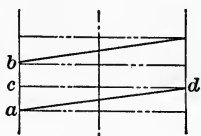

FIG. 52.

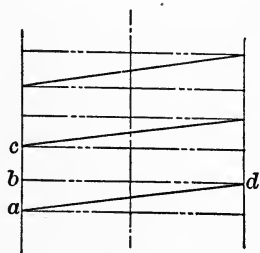

FIG. 53.

After having determined the position of the lines for the top of the thread the lines for the bottom may be drawn as above.

When a bolt is turned to the right, or so that the top of a thread moves to the right and down, or in the direction of the hands of a watch, the thread on the bolt is called a "right-handed thread." All of those drawn are right-handed. The slope is the opposite for the "left-handed thread." These left-handed threads are used only for special purposes.

When a section is cut through the center of a threaded hole, the part of the female thread seen beyond the section corresponds to the hidden part of the thread on a bolt, and the slope is in the opposite direction. The shading of the female thread is the same as that of the male thread, the heavy line at the bottom of the thread.

When the section goes through the bolt in position in the bolt-hole, the bolt is drawn in elevation resting in the section. As a rule the threads are not drawn and the bolt and hole are represented as in Fig. 54. As the drill used for drilling the hole is ground at an angle of 60° , the bottom of the hole is

finished by the two lines making an angle of 120° with each other. The end of the bolt is rounded off as a rule, the common radius being the diameter of the bolt. The bolt is

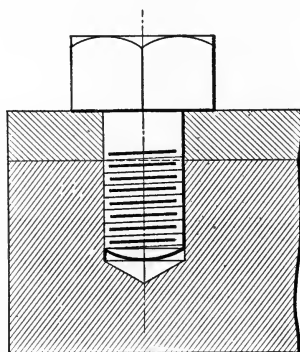

FIG. 54.

represented as screwed to the bottom of the cylindrical part of the hole.

Square Threads.—The threads drawn in the figures are all triangular, which is the common type; but square threads are used for many special purposes. The only difference is in the shape of the thread. The pitch and methods of finding the curves for the top and bottom are the same.

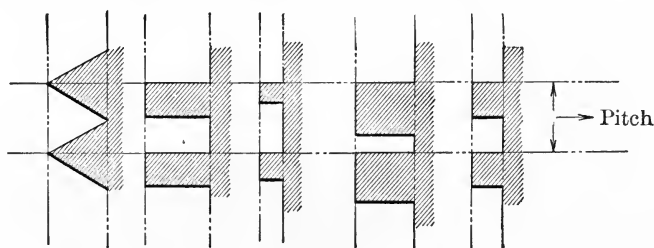

FIG. 55.

The pitch-length outside the solid metal is filled, in the case of the triangular threads, with a triangular-shaped figure

and a space of nearly the same shape. In the case of square threads the portion for the metal and the space remaining are both rectangular. These may be equal and may differ greatly, as in Fig. 55.

These threads are represented as in the case of triangular threads. When the drawing is large and ornamental, the helices are drawn; ordinarily straight lines are used. The lines for the depressed portions may be left out as a rule. See Fig. 56.

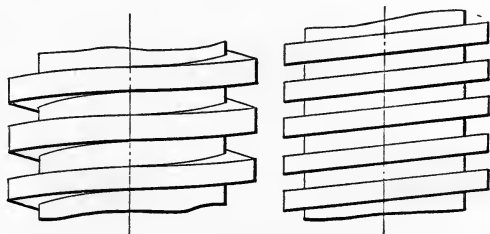

FIG. 56.

The pitch may be taken up by a single thread, when the thread is called "single screw"; or the length of the pitch may be filled by two or more threads, when the thread is called "double screw," "triple screw," etc.

To determine to what class a screw belongs, follow a ridge

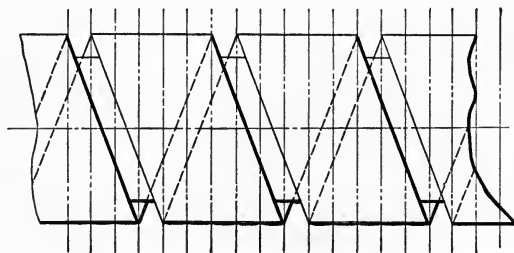

FIG. 57.

around for one revolution and find how many ridges there are between the original point and the one arrived at after going around. Double, triple screws, etc., are used when a greater

longitudinal movement is desired; in other words, when the pitch is increased. Then the space between the following threads is filled in by extra threads for strength.

Fig. 57 shows a single screw of great pitch.

It is noticed that most of the bolt is cylindrical. For strength, there are placed between the threads two extra ones

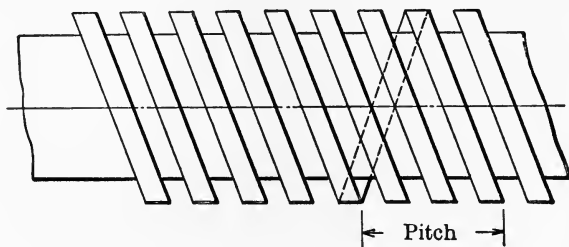

FIG. 58.

that have the same pitch as the original one. Fig. 58 shows a triple screw as usually drawn.

When the threads are double or triple, or when the thread is other than standard, it is stated on the drawing near the bolt.

Hidden threads are never drawn except in the case of very large threads inside of nuts, as in the case of a propeller nut. In this case the threads are shown in broken lines, unshaded.

When threads are drawn on bolts, it is seldom advisable to make the exact ending of the threads as it is in reality.

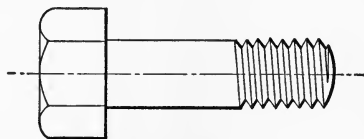

FIG. 59.

The tops and bottoms of threads are ended as in the sketch. The real ending of the top of the thread is behind the bolt somewhere. The bottom has to be ended according to how the curve or other line at the bottom cuts the teeth of the thread.

Bolts and Nuts.—As most bolts are standard, the dimensions are obtained from the Table of Standard Bolts and Nuts. If the bolt differs from the standard, the points of difference are shown on the drawing.

The diameter of the bolt is determined either by calculations for strength or by custom. The ordinary bolts used in machine work have hexagonal heads; the square-headed bolts are used for rough work or for special purposes. The height of the bolt-head and the long and short diameters are given in the Table. The length of the bolt is determined by the necessities of the special case. After the head of the bolt is shaped, the top edge is chamfered off at an angle of 45° . This is done by centering the bolt in a lathe and cutting the chamfer as the bolt revolves. This chamfer as a rule is cut just enough so that the sharp corners are removed, and so that the flat sides are left at the full height at the center. This is shown in Fig. 60.

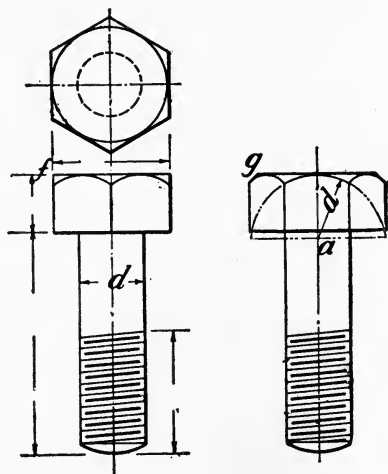

FIG. 60.

The point *f* shows that the middle of the flat side is left at its full height, while at *g* the sharp corner is cut off. The

chamfer makes a cone of revolution which cuts the flat sides; the curves of intersection are hyperbolæ; but the projections of these hyperbolæ are so nearly circles that they are drawn as circles. Where the cone of chamfer cuts the top plane, the intersection is a circle, as shown in the plan view.

The exact representation of the top of the bolt or nut is shown in Fig. 61, but the 45° lines are seldom drawn in practice.

From the Table of Standard Bolts and Nuts it is found that the height of the nut is the same as the diameter of the bolt, while the height of the bolt-head is less, as a rule.

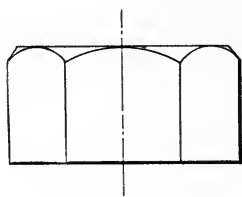

FIG. 61.

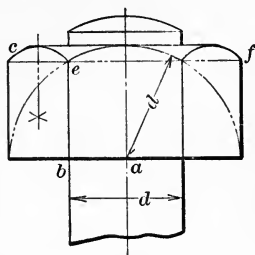

FIG. 62.

In drawing the nut, from the point a with a radius equal to the diameter of the bolt describe an arc, as shown. See Fig. 62. This is approximately the curve for the middle portion; the continuation of this curve defines the limits of the long diameter of the nut. The continuation of the lines of the bolt defines the limits of the central face. Draw the four verticals and a horizontal line cf through e . Draw a vertical center line for the face bc by means of small arcs from c and e , and find a center on this line that will cause an arc to pass through the points c and e and tangent to the top line. Note that, as usually drawn, the line across the top of the nut ends at and is tangent to the top of the curves for the side faces, and is tangent to the curve of the middle face.

In drawing the head of the bolt (see Fig. 60), the height is laid off from the Table and the top line drawn. From the

center of this top line lay off along the center line of the bolt the distance d .

Beginning with this point, a , as in the case of the nut, find the centers for the side faces.

To draw the other view of the bolt-head (Fig. 60), the widths of the faces are projected from the plan, and the points where the curves begin are projected from the other view drawn. These curves must have centers in the middle lines of the faces and must be tangent to the top line. The center is generally found by trial, but the length of the radius is about four-fifths of the diameter of the bolt.

Although Fig. 60 shows the correct way to represent a bolt according to the general plan, it is customary to place the Side Elevation under the Plan. The reason is that the Front Elevation cannot be drawn until the Side Elevation is completed, as the limits of the curves have to be determined from the Side Elevation. Hence it is the custom always to draw the Side Elevation of Fig. 60 first for any representation of a bolt. If two views of the bolt are made, the second one drawn is the Front Elevation of Fig. 60. In other words, the first view shows the long diameter of the bolt-head.

In the Plan it is not good practice to draw a broken line to show the diameter of the bolt.

Where a number of bolts or nuts are drawn, either in a straight line or in an arc of a circle, the heads always face the same way, whether in Plan or Elevation; the faces of the nuts are drawn facing in the same way as the bolts for each view.

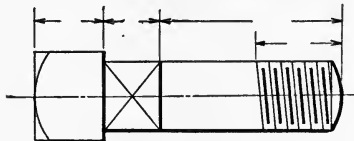

FIG. 63.

Sometimes bolts are made with square shoulders under the head so that they will not turn when in place. The conven-

tional way of representing this square portion at any part of a body generally cylindrical is shown in Fig. 63.

The portion with the crossed lines is the flat-sided portion.

For rough work only, where the nuts are stamped out and

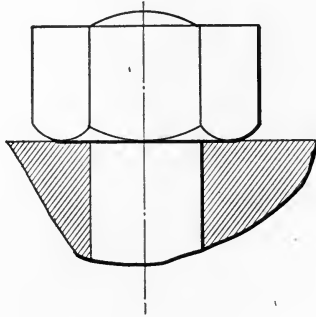

FIG. 64.

unfinished, the nuts are screwed on the bolts with the rounded side down, as in Fig. 64.

Bolts that are finished always have the bottom portion slightly cut away at the projecting corners, so that these corners will not cut into the metal.

When bolts and nuts are drawn in place, the bolt is represented as projecting beyond the nut slightly. When threads are drawn on the bolt beyond the nut, represent the extension

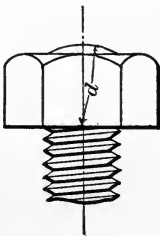

FIG. 65.

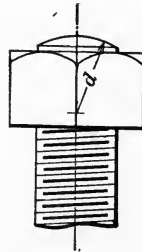

FIG. 66.

of the bolt as in Fig. 65. The bottom of the thread is projected to the top of the nut on either side of the center. An

arc is drawn through these two points, using the middle point of the bottom of the nut as a center.

When threads are merely represented on the bolt, show the extension of the bolt as in Fig. 66.

The outside diameter of the bolt is projected to the top of the nut, and short lines are drawn and an arc drawn across with a radius equal to the outside diameter of the bolt. The height of the short lines drawn varies with the diameter of the bolt.

Jam-nuts.—These are two nuts screwed tight together on a bolt, each one preventing the other from turning. These are generally of different thicknesses and are represented as in Fig. 67.

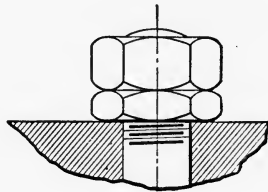

FIG. 67.

The nut nearest the end of the bolt is thicker than the first one screwed on. Both edges of both nuts are chamfered.

When bolts are standard, the dimensions given are diameter, length under head, and length of the threaded portion.

When bolts are not standard, in addition to the above there are given the height of the head, either the long or short diameter of the head, and the number of threads to the inch.

Tails.—When two curved surfaces meet at angles with rounded corners to prevent sharp angles and so that the defining lines of one of them disappear, it is customary to represent this effect by short curved endings called “tails.” The small projections represent bosses for bolts and are cylindrical. They gradually meet the rounded larger surface with small

curves at the junction. "Tails" are placed at the ends of the vertical lines to represent this effect.

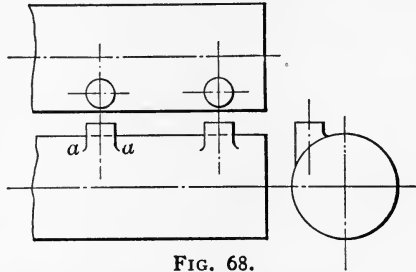

FIG. 68.

Working, Border, and Cutting Lines.—The working line encloses a rectangle beyond which the drawing may not extend, as a rule. It is laid off from the center of the paper both ways, using the 32 scale. The center is found by drawing with the T square diagonals from opposite corners of the paper (not the board). This line is pencilled but not inked. The idea of it is to leave a space between the drawing and the border line for a good effect and to avoid confusion. In special cases, where the scale of the drawing would have to be made too small on account of this line, it may be surpassed.

The border line is ornamental only in that it gives a finish to the general effect of the drawing, and the blank, irregular spaces of the paper beyond the drawing are made less prominent.

This line is drawn in pencil after the working line is drawn, and is at a certain distance outside of the working line. It is inked after the drawing is completed. Border lines are often very ornamental, and much time and care may be expended on them when an especially ornamental drawing is to be made; but, as a rule, little time may be put upon them, as other work is more important.

It is a good effect to shade the lower and right-hand border lines. The upper and left-hand lines are made of fair width, and the other lines at least four times as heavy. Plain lines meeting at points are sufficiently effective. Occasionally small

portions of the drawing may project beyond the border line. In this case interrupt the border line for half an inch on either side of the outline passing beyond it.

The cutting line is outside of the border and is drawn in pencil after the border line is marked. This line is simply a guide for cutting, and is not inked. When the line is drawn, it may be found that portions of the paste used in stretching the paper may be so far in that there will be difficulty in cutting off the paper finally; in this case, all the lines may be moved farther away from this side; or it may be necessary to change the dimensions of working, border, and cutting lines, as is most convenient.

In marking the working, border, and cutting lines, the half-distances enclosed by these lines are laid off vertically and horizontally along center lines drawn in these directions through the center of the paper. These distances are marked once only. The T square and triangles are depended upon for accurate lines.

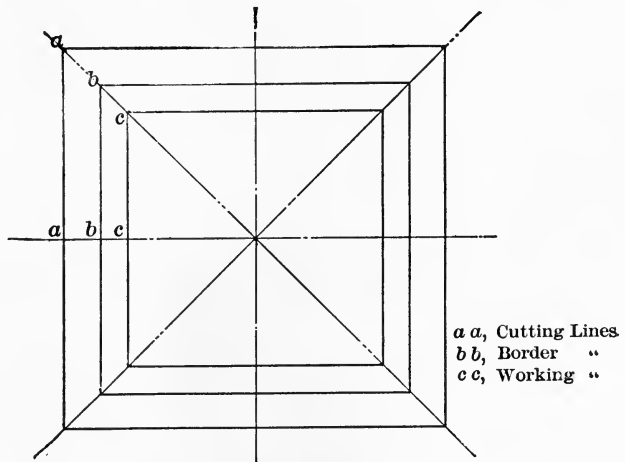

FIG. 69.

Legend, Lettering, Scale, etc.—The legend refers to the description of the drawing, with the scale and the name of the

one who made the drawing. All these records are placed in the lower right-hand (S. E.) corner of the drawing inside the working edge, and space must be left for them when calculating on the best arrangement of the different views. This generally leaves a blank space along the upper right-hand edge of the paper, but the effect of the drawing as a work of art is sacrificed to utility. As drawings are stored in drawers and it must be possible rapidly to find the one sought, the descriptions must be in the same place in all, and they must be at one of the lower corners, so that it may be possible to read them without pulling out each sheet. By raising the right-hand corners of a number of drawings, the legends may be rapidly looked at and the one desired found with the least loss of time.

In the S. E. corner is placed the general description of the drawing or drawings on the board. If a number of objects are shown, find as generic a name as possible for them all, but one that will leave no uncertainty as to what may be on the drawing. Besides the very general description in the S. E. corner, place near (under, if convenient) each different drawing any especial remarks that may be necessary to more thoroughly describe it.

When drawings are made from brass models, after the name of the object the legend reads: "Sketched and drawn from models."

When drawings are made from portions of machinery, after the name of the object the legend reads: "Sketched and drawn from work."

When drawings are made from blue-prints of general arrangements, first give the name of the ship (Battleship Iowa, Cruiser Detroit, U. S. S. Adams, etc.), then the description of the object or objects; after that the legend reads: "Taken from blue-print of General Arrangement of Machinery."

If all the drawings on the sheet are taken from the same work, the legend in the S. E. corner may contain the re-

**BATTLE SHIPS NOS. I. II. & III.
HIGH PRESSURE PISTON.**

*Taken from Blue Print of
General Arrangement of Machinery.*

Scale, $3'' = 1$ Foot.

J. K. White.

2nd Class.

January, 15, 1911.

marks showing whence the material for the drawing came; in case the drawings are from different sources, the special remarks are placed near the different drawings.

In the legend, the sequence of the different portions is as follows:

Name of object represented.

Special remarks.

Scale.

Name. Class.

Date.

The name of the object is made in some type of heavy lettering and is the prominent part of the legend. When a ship's name or number is given, this is equally prominent. All the rest of the lettering is done with a writing-pen, the letters small and clear. The name is not prominent and is an autograph.

Block Letters.—This is the type of lettering preferred for heavy type. The letters, as a rule, are three spaces wide and all are five spaces high, as shown in the sketch, while one space separates the letters. The letters M and W occupy respectively four and five spaces, as shown. The peculiarity of the letter K is shown. The peculiarities of the figures are also shown.

Numerous variations of these letters may be made by varying the heights, widths, slopes, etc., of the spaces; by making solid or skeleton letters; by drawing shade lines; by drawing the shade lines only; by shading in any direction and to any extent, etc.

Sample drawings of these letters are found in the drawing-room.

When block lettering is to be used, measure the length of space that is available and draw a vertical center line. Make a rough copy of the letters to go on one line on a spare piece of paper. Allow the spaces between the words and place

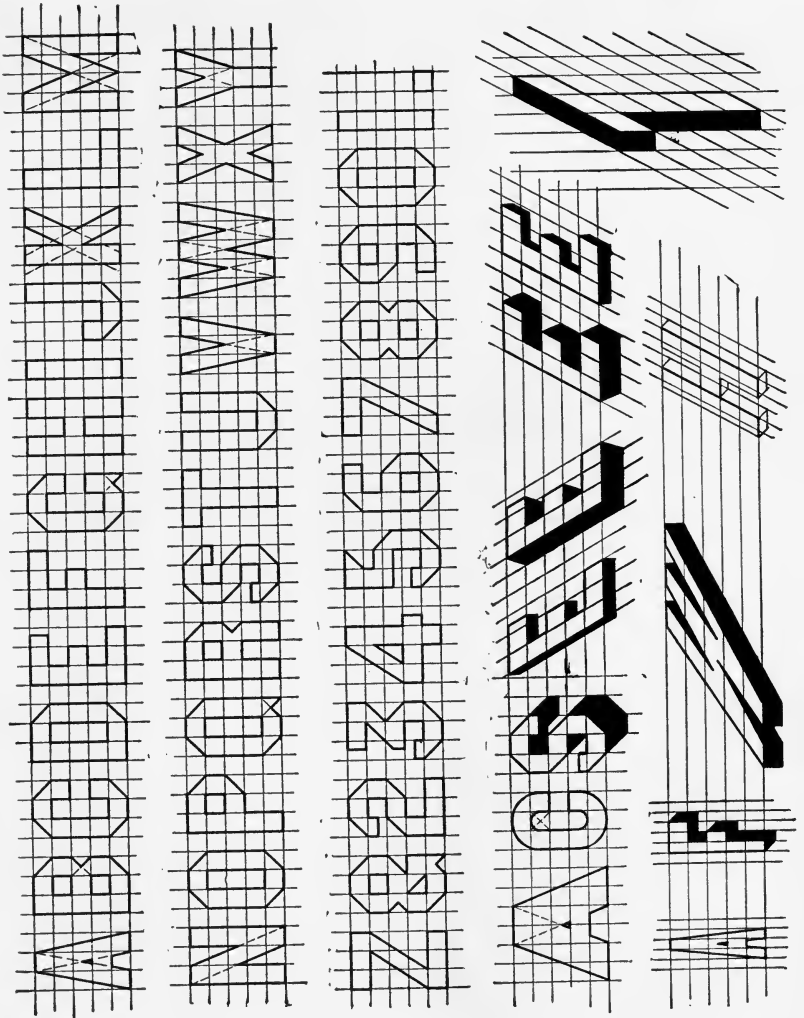

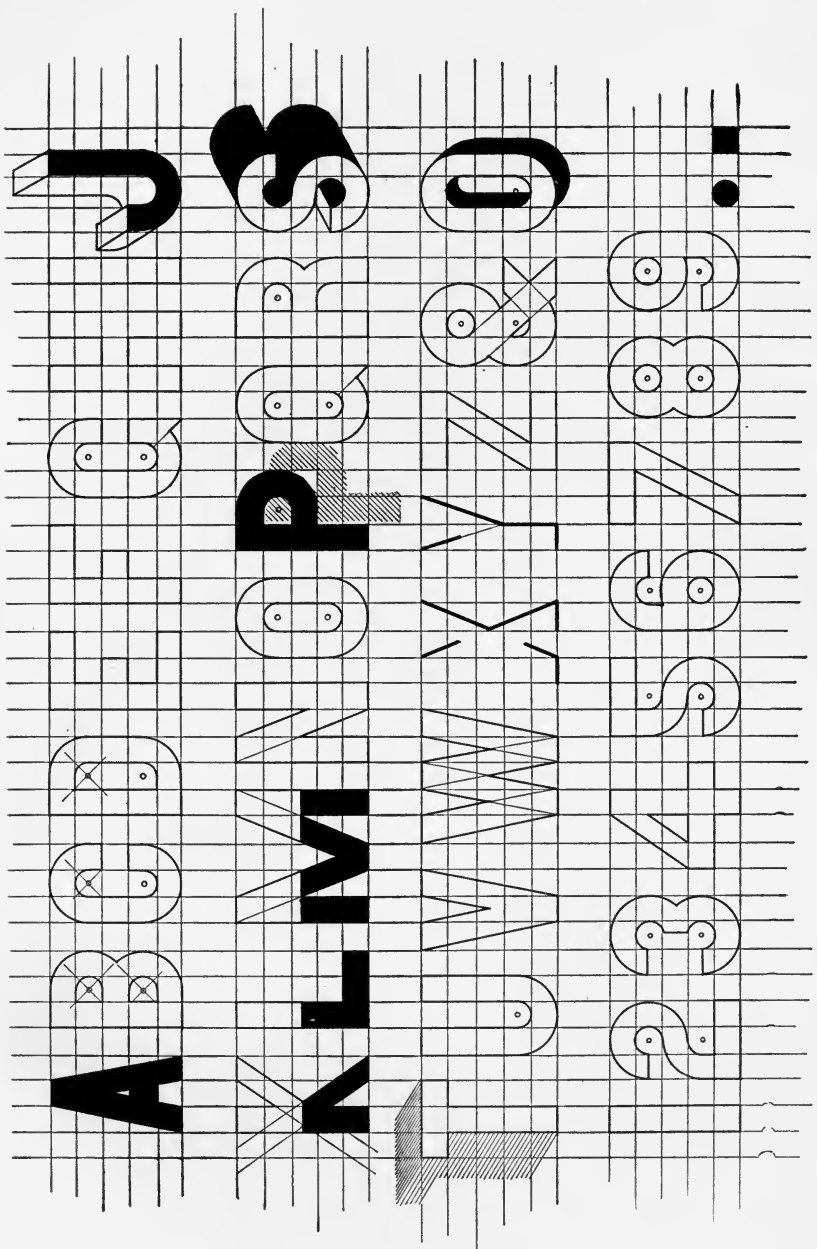

figures over each letter and the following space for the number of the spaces actually needed. Half the sum of these figures gives the part of the lettering to coincide with the center line drawn. From the half-width of the space available and the half-number of spaces required, the width of one space is calculated. The next smaller division on a regular scale may be used and the spaces laid off from the triangular scale; or the exact width desired may be obtained very closely and this distance laid off with the bow spacers on a line just below the one for the bottom of the letters. The vertical lines for the spaces may then be drawn and the height chosen for the vertical spaces. For ordinary work letters need not be over half an inch high, and three-eighths of an inch is amply large for most drawings.

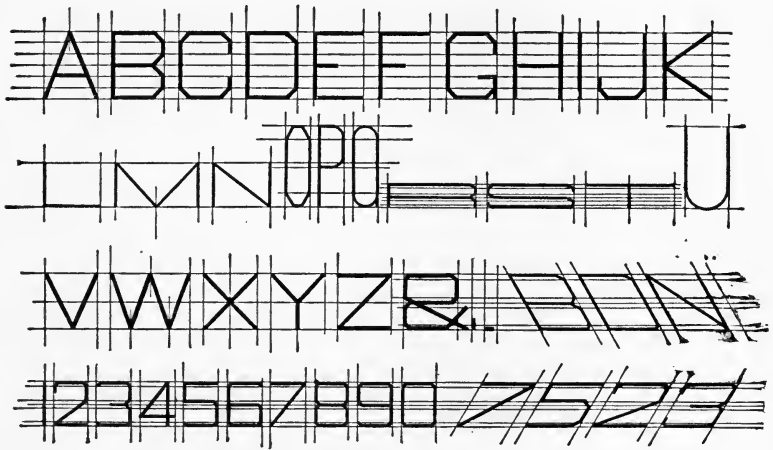

Another type of block letters is shown. In this case, decide on the total width allowable for each letter and its following space, and lay off these total spaces; then decide on how much of these total spaces shall be letter and how much distances between letters. Divide the laid-off spaces accordingly. Draw horizontal lines for determining the beginnings of the slopes at any desired distances from the top, middle,

CAPITAL LETTERS: A B C D E F G H I

LOWER CASE LETTERS: a b c d e f g h i j k l m n o

THE OVAL in the lower case letters is shape of it is used in the following letters in the m

abcdeghj

THE SLOPE for all letters is 3 in 8, thus $\frac{3}{8}$
In A, V, W and Y the slope is obtained thus: $\frac{3}{8}$

CAPITAL LETTERING: Examples: SECTION

This style of lettering is for titles and headin

LOWER CASE LETTERING: Example: Make

This style of lettering is for everything e

SIZES: Standard $\frac{3}{16}$ END VIEW $\frac{1}{8}$ $\frac{1}{8}$ M

Small: $\frac{3}{32}$ END VIEW $\frac{3}{32}$ $\frac{3}{32}$

Large: $\frac{9}{32}$ END VIEW $\frac{3}{16}$ $\frac{3}{16}$

When there is not room for the standar

The large size should be used only whe
ing or note.

SPACING: STANDARD

In this example, letters, words and lines are correctly spaced.

The letters of a word should be reasonably close together.

Paragraphs should be indented as illustrated here.

In thi

and i

The
be rea

Par
as ill

$\frac{5}{32}$

KLMNOPQRSTUVWXYZ &

rstuvwxyz & abfgptyshd } 4 equal spaces
PROPORTIONS

thus O, and inverted thus: D; this oval or part
er indicated:

A a p q r u

example d: 8
3

A, Y not V, W not W, Y not Y.

B. PATTERN LIST. END VIEW.

pattern to this line.

cept titles and headings.

pattern to this line. 

pattern to this line. 

Make pattern to this line. 

use the small size.

It is advisable to give special prominence to a head-

SMALL

example, letters, words
are correctly spaced.
ers of a word should
ably close together.
raphs should be indented
ated here.

LARGE

In this example
letters, words and
lines are correctly
spaced.

Q W X Y Z

Q W X Y Z

Q W X Y Z

Q W X Y Z

Q W X Y Z

Q W X Y Z

Q W X Y Z

Q W X Y Z

Q W X Y Z

LARGE

In this example letters were not lined and correctly spaced

In this example letters were not lined and correctly spaced



EXPLANATORY: by the term "dimension" is meant the
as in the following example:

THE FIGURE IS 3-0-78-90
THE SLOPE IS 1/8. Thus



NOTATIONAL MARKS: 3-0-78-90
45° 30' 15" 10' 5' 0'

... of the slope ...
... of the slope ...

... of the slope ...
... of the slope ...

... of the slope ...
... of the slope ...



EXPLANATORY: By the term "dimension" is meant the following example: ←

THE FIGURES: 1234567890
THE SLOPE is 3 in 8, thus: $\frac{3}{8}$

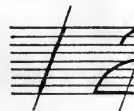

NOTATION MARKS: 3'-6" means a distance of 3 feet 6 inches
45°-30'-52" means an angle
The minute and second marks

DISTANCES: Examples: 3" 7'-6" 12'-0 $\frac{1}{2}$ " $\frac{5}{32}$ " 3 $\frac{1}{16}$ "
FRACTIONS: Numerator and denominator are set
DECIMALS: The notation mark is placed vertical

THE SIZE of the figures should be suited to the other parts of the drawing. A suitable size for a dimension should be chosen with discretion. When immediately connected with lettering, the size should be of the capital, thus: Aug. 3. 1904. Fig. 28 DW

ARROW-HEADS:  About 60°, made freehand

CONSTRUCTIONS: The parts of a dimension can be arranged in a set of standard dimensions.

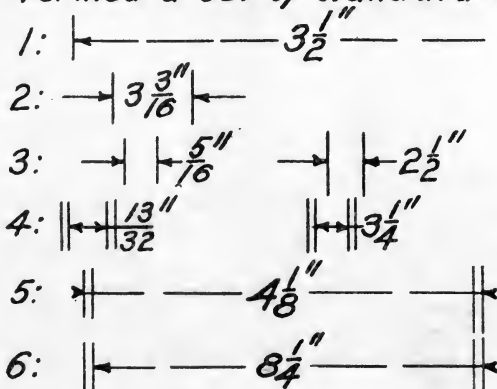

The purpose of these dimensions is to be drawn with ordinary care. Each construction is a standard dimension, and is suitable for use in 5 the reverse. In 6 it is clear. A dimension line should be preferred with by

When you are all done, please turn in your work.

1 2 3 4 5 6 7 8 9 0

10 11 12 13 14 15 16 17 18 19 20

21 22 23 24 25 26 27 28 29 30

31 32 33 34 35 36 37 38 39 40

41 42 43 44 45 46 47 48 49 50

51 52 53 54 55 56 57 58 59 60

61 62 63 64 65 66 67 68 69 70

71 72 73 74 75 76 77 78 79 80

81 82 83 84 85 86 87 88 89 90

91 92 93 94 95 96 97 98 99 100

101 102 103 104 105 106 107 108 109 110

111 112 113 114 115 116 117 118 119 120

121 122 123 124 125 126 127 128 129 130

131 132 133 134 135 136 137 138 139 140

141 142 143 144 145 146 147 148 149 150

151 152 153 154 155 156 157 158 159 160

161 162 163 164 165 166 167 168 169 170

171 172 173 174 175 176 177 178 179 180

181 182 183 184 185 186 187 188 189 190

191 192 193 194 195 196 197 198 199 200

201 202 203 204 205 206 207 208 209 210

211 212 213 214 215 216 217 218 219 220

221 222 223 224 225 226 227 228 229 230

231 232 233 234 235 236 237 238 239 240

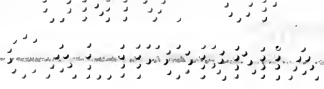

A B C D E F

M O R O R S

1 2 3 4 5 6

THEY WERE
DURING THE
IN THE
DAYS OF
STAYING
REVOLUTION
STEAM PRESSURE
SCALE

A B C D E F

N O P Q R S

1 2 3 4 5 6

TWIN SCREW.....
DISPLACEMENT.....
I.H.P.....
DIAM. OF CYLINDERS.....
STROKE.....
REVOLUTIONS.....
STEAM PRESSURE.....
SCALE.....

H I J K L M

U V W X Y Z

7 8 9 0 & .

...TWO ENGINES.

...IN. = 1 FT

8 301



M J K L M

S Y X W T V U

. 8 0 0 8

230013

CHRYSLER
M. E. ANDERSON

and bottom lines. Where these lines cut the vertical bounding lines of the letters the angular lines begin. The slopes may be varied, the slopes made arcs, and the slant of the lines may be changed as desired, but for ordinary drawings the simple type is best. These letters are generally drawn with an opening of the pen that will ensure a good line that may be continued indefinitely and that is at the same time quite heavy.

Free-hand Lettering.—There are many types of free-hand lettering, but the simplest and most clear and the easiest made are the best. No time should be wasted on the lettering, but it must be distinct. The samples given are very satisfactory and are much used. A little practice brings a fair proficiency. It is well to draw the top and bottom guide-lines for the capitals as well as the small letters.

The height of the small letters is about $\frac{1}{8}$ " , and of the capitals $\frac{3}{16}$ " .

The figures are the same height as the capitals.

Variation may be made in the slope of the letters and individual designs used to a certain extent, but the simpler and more upright the letter the better.

Use an ordinary writing-pen. Try many kinds until the most satisfactory result is obtained. Always make the letters and figures distinct.

After the drawings of brass models are completed, the different views are no longer marked "Plan," "Front Elevation," etc., as it is supposed that all are familiar with the different views by that time.

Scales.—The scale of the drawing is clearly stated. If only one scale is used throughout the drawing, this scale is given in the legend. If different scales are used in different parts of the drawing, the various scales are placed near the drawings where used, generally under them, so that there may be no possibility of error.

Scales are stated as follows: Scale, $3'' = 1$ foot; $\frac{1}{4}'' = 1$ foot; etc.

Scales other than those on the triangular scale are stated: Scale, full size; scale, half size; scale, three-quarter size; scale, double size.

Never state: Scale, $\frac{3}{4}$ size. Always write out the fraction.

Never state: Scale, $9'' = 1$ foot; or, Scale, $8'' = 1$ foot; as there are no such scales on the triangular scales used.

Line Shading and Tinting.—Line shading and tinting are used for ornamental drawings, and to show more clearly to those not familiar with mechanical drawing the intention of the views and the arrangement of the different parts of the mechanism.

As shown by the title, the surfaces are covered with lines or tints of different light effects to show as clearly as possible how the object really appears.

Line Shading.—There are certain prevailing methods of shading surfaces, and these methods apply to all views of an object.

The light is supposed to come from the same point as under "Shade Lines," that is, from the N. W. direction and from an angle of 45° above the drawing-board.

Flat Surfaces.—Fig. 70 shows two positions of half of a hexagonal prism with a smaller hexagonal prism cut out centrally. These views give some of the various types of flat surfaces to be considered.

Flat surfaces parallel to the paper and on which the light falls have a uniform light effect, as surfaces *A*.

Flat surfaces parallel to the paper and on which the light does not fall have a uniform dark effect.

Flat surfaces on which the light falls and which are inclined to the paper have a light effect which gradually becomes darker as the surface recedes, as surfaces *B*.

Flat surfaces on which the light does not fall and which are inclined to the paper have a dark effect that gradually becomes lighter as the surface recedes, as surfaces *C*.

Generally speaking, striking contrasts are made at the front of the drawing: the parts near the eye are in high light and

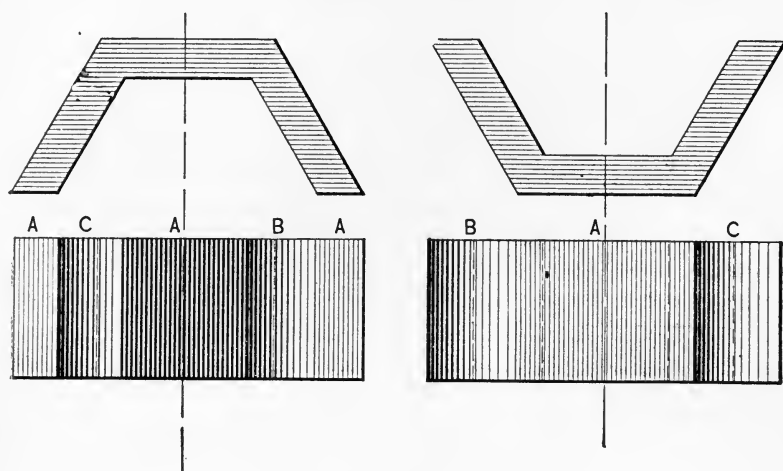

FIG. 70.

deep shades, while those parts in the background have less contrast as they are farther away, the parts in the light being less bright, and those in the shade less dark.

To Shade a Cylinder.—In order to produce the rounded effect of the cylinder, lines or tints are graded from light effect to darker ones. The heaviest part of the shade is theoretically at the position of 45° , as shown in Fig. 71. The point of lightest effect is theoretically at a position of $22\frac{1}{2}^\circ$, as shown.

It is not deemed necessary to study the reason for these points of light and shade. After these points are determined, it is in accordance with the best practice to move these positions somewhat in order to produce a better effect. The darkest part is moved nearer to the central line of the figure, and the lightest part is moved farther away from this center.

The amount of this movement is proportional entirely, and Fig. 71 gives about the right amount. After finally establishing the dark and light lines, one method of line shading is shown in the above figure. In this case all the lines are of the same breadth, and the effect of rounding is produced entirely by varying the distances apart of the lines. A clear line, com-

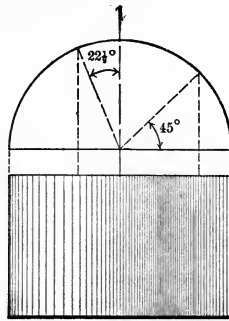

FIG. 71.

paratively fine, is chosen and the lines are drawn in succession from one side to the other, the gradations of space being made according to judgment. It seems best to begin at the side of the cylinder nearest to the lightest line, and to follow along to the other. The effect at the edges should be exactly the same.

Fig. 72 shows the more ornamental and effective kind of line shading. This is more extensively used also. The dark and light portions are established as before, and the rounding effect is produced by a combination of varying the width of the lines and also the distances apart. Often three or four of the darkest lines at the darkest point of the shading are combined in one. It seems best to begin this shading on the left side—that nearest to the lighter portion. The line first drawn should be well chosen and in accordance with the size of the cylinder. This line will establish the weights of the other lines and practically whether the cylinder will be shaded dark or light. After the first line, the others are varied

according to judgment. At times three or four lines of the same width are drawn, the spaces between them slightly varied. The combination of varying the width of the lines and the width of the spaces gives a good chance to round the

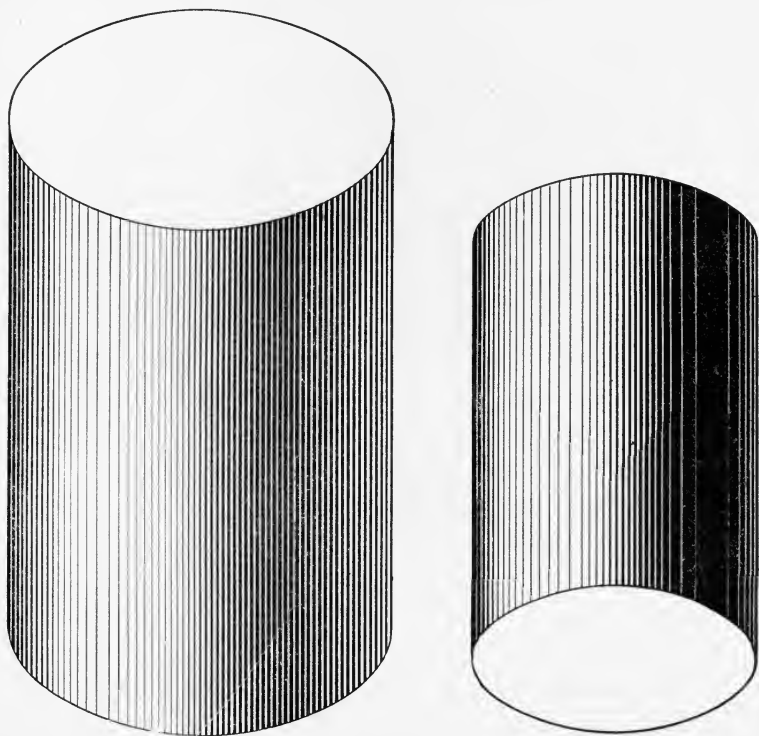

FIG. 72.

cylinder up nicely. At the end, note that there is always a light effect near the edge last finished. There is a slightly wider space left between the last two lines and the others just drawn. This produces the effect of a light streak just near the edge. This is supposed to be the effect of reflected or diffused light coming around the side of the cylinder.

This effect is never shown at the other side of the cylinder; the shading there is gradual to the very edge.

Interior of a Hollow Cylinder.—As shown in Fig. 73, the heavy part of the shading commences at the edge in shadow

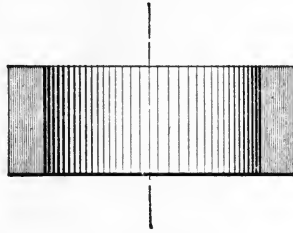
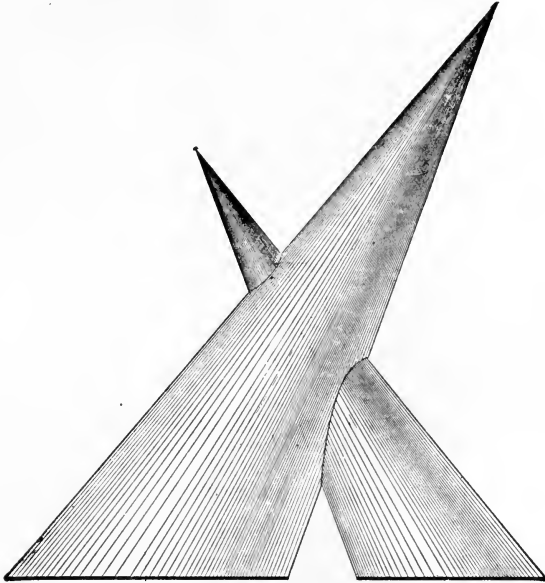

FIG. 73.

and grades to the lightest part, found as before; then the shading continues to the other side gradually.



A Cone.—The dark and light points are established as in the case of the cylinder and the same system is followed. In the heavy type of shading each of the shade lines becomes a triangle. The light effect at the side nearest to the heavy

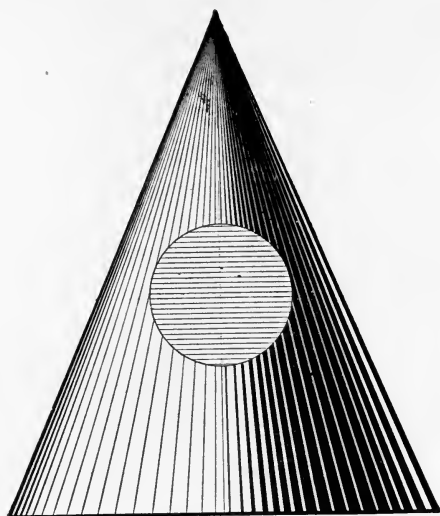

FIG. 74.

shade lines is preserved as in the case of the cylinder. It is found advisable in shading the cone to draw the lines from the

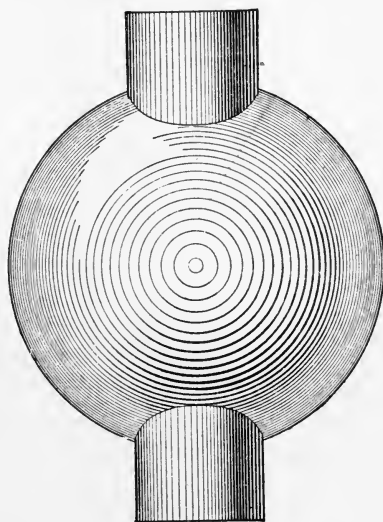

FIG. 75.

apex and to begin at the heaviest shading, working both ways. Many lines are not begun at the apex but a little below, to avoid a blot. When all the lines are drawn, the light spaces near the apex are filled in with a fine opening of pen.

A Sphere.—The darkest and lightest points are on the 45° line as shown, and their approximate radial positions determined by eye. See Fig. 75.

These lines are drawn as shown under "Shade Lines." A horn center should be used.

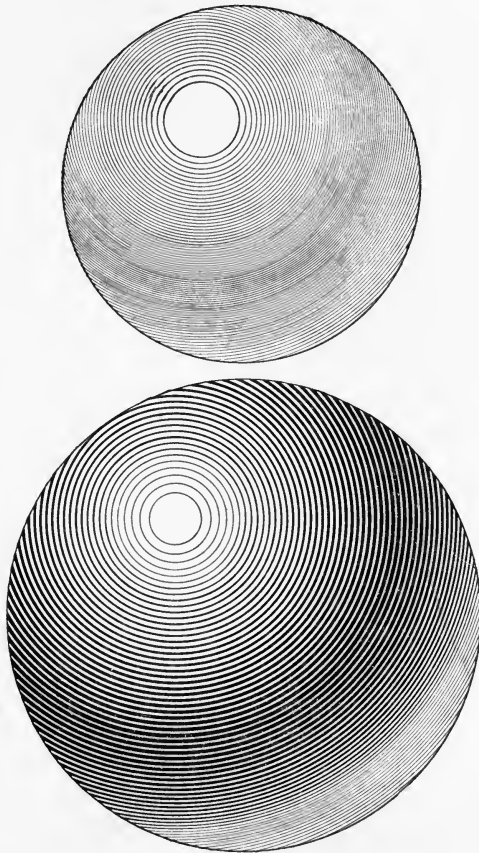

FIG. 76.

Another method. (Fig. 76.) This does not produce the true effect, as the varying lights traverse the surface in zones, but it is much easier to make and is much used. The center of the arcs is the center of the lightest portion.

Tinting.—The same methods of arranging the lights and shadows of the shading apply to the tinting.

Tinting may be done with any colors or with Indian ink. Colors are seldom used; and as the same methods apply, the description of the method of using Indian ink will answer. Use stick Indian ink—not the ink mixed in bottles.

The paper must be stretched on the board if tinting is to be done. The drawing must be kept as clean as possible, and the rubber not used, as it roughens the surface of the paper. The tinting is done after the black lines of the drawing are completed without shade lines. The drawing is then washed in running water—not rubbed—and is allowed to dry.

To Prepare the Tint.—At least two brushes are needed; two beakers or water-glasses partly filled with clean water; an ink-slab or saucer in which to mix the ink; a stick of Indian ink; and a piece of blotting-paper.

Clean all these articles thoroughly. Decide on the amount of liquid ink necessary according to the quantity of surface to be covered. Place sufficient water in the ink-saucer and proceed to grind the ink in the water by rubbing it about with a certain pressure on the bottom of the saucer. This requires considerable time, as the ink dissolves slowly. It should be ground until a line made with it by the R. L. pen remains black when dry. This ink is now in condition to be used for drawing. As the ink used in tinting is very much lighter in color, the ink mixed will serve to cover from three to four times the surface that it would cover if used in its black state. In one of the water-glasses or beakers place a small quantity of water; dip the brush in the top of the mixed ink, so as to take up only the clear ink and leave the sediment, and stir this color

into the water in the beaker. With a brush test the color of the tint on a piece of drawing-paper, allowing the color to dry. Add black ink until the tint is as desired. The tint chosen should be much lighter than will be the final effect on the drawing, as it is very easy to darken the drawing by laying on another tint, while it is very difficult to repair work that is too dark.

Take a clean brush and clean water and carefully go over the surface to be tinted with this water; be particularly careful that the edges are moist to the boundary lines and that these are not passed, as the tint will follow all these defects.

To Lay on a Flat Tint.—This seems easy but is extremely difficult, and methods differ also. Some leave the drawing-board level and others tip it slightly, so that the bottom of the board is three inches or more lower than the top. Draftsmen follow the methods that suit them best. The same general plan is followed in either case, only that it is thought that when the board is tipped the tint flows by gravity and assists the operation. However, as it is difficult to tip the board in all the directions required in making a complicated drawing, it is well to learn to tint with the board horizontal.

After a space has been moistened slightly with the clean water, dip a brush deeply into the prepared tint and stir it well around so that it is permeated with the same shade of color; either keep the brush full for a large surface, or for a small one remove part of the liquid by rubbing the brush on the edge of the glass; according to the shape of the surface, carry the brush along one line rapidly and carefully; before this has a chance to dry, run the brush again along in the same direction but a little farther on from the edge, thus making the surface moistened twice as wide as before; continue in this way, never allowing an edge to dry until the whole surface has been covered; at the end, if there is too much of the tint on the paper, quickly dry the brush by rubbing it on a piece of blotting-paper and then use it to dry up the last part of the

work. If carefully done, it will be found that a perfectly even coat of color has been placed on the surface. If this tint is not dark enough, it may be darkened by successive tintings; but never put on a second tint until the first one is "hand dry," or dry to the touch. Never try to touch up a small portion of the surface except by "stippling," which alters the entire effect of the work.

When using the brush along the boundary lines of the space, always keep the point of the brush towards the edge. Do not bear on the brush, as this may cause marks to be made that will show under the tint.

For large surfaces lay on a light tint. Reverse the board and lay on a second one. Turn the board and repeat from one side; then do the same from the other side. This does away with the effects of streaks in any one direction, and the result is an even tint over the whole surface.

Graduated Tints.—There are two general methods, the French and the American.

The French method consists in dividing up the space to be covered into small rectangles (these must not be marked with pencil, as the marks cannot be eradicated); putting on a tint in the rectangle to be darkest and allowing it to dry; putting on a tint covering the rectangle already tinted and an adjacent one and allowing it to dry again; and continuing this operation until the entire surface is covered. By this method the shading is in streaks that are more or less prominent according to the width or narrowness of the rectangles. This method takes too much time also.

The American method is most used and takes less time, while the effect is equally good. This is called the method of shading by softened tints. For a surface that is flat and inclined at an angle to the paper, the method is as follows:

Saturate the brush as before with the tint and remove most of it against the side of the beaker; lay a narrow line of the tint along the line of darkest shade; *while this is still wet* dip



FIG. 77.

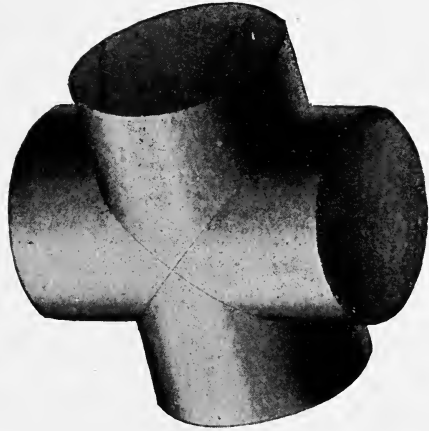

FIG. 78.



FIG. 79.

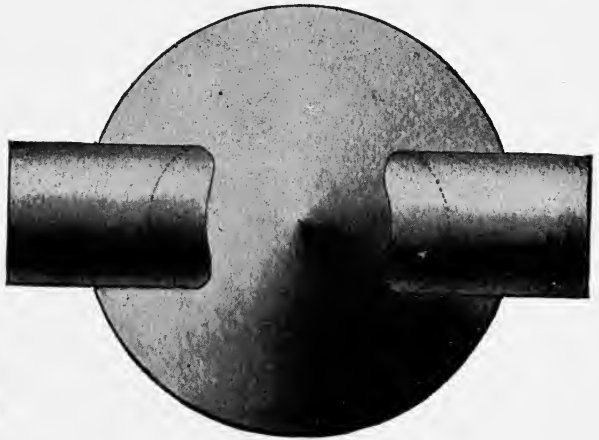

FIG. 80.

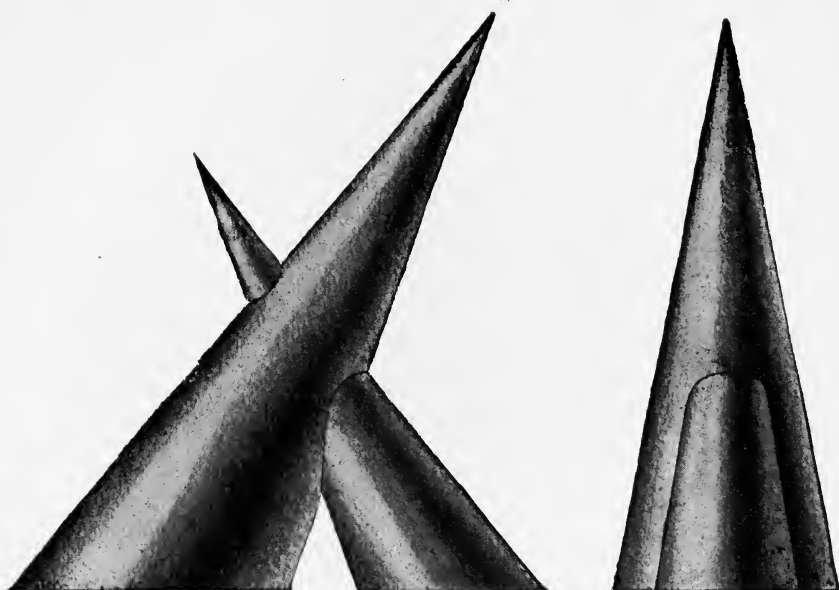

FIG. 81.

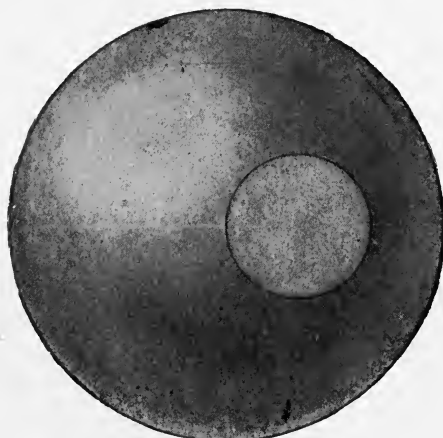

FIG. 82

the point of the brush in clean water, which dilutes the color on the brush, and apply a line along the edge of the tint previously laid on, rubbing into the edge of the other tint; again weaken the tint and continue as before. Each operation leaves a lighter tint, and at the end a clean brush in clear water leaves practically no color. This method softens the gradations from one tint to another and is rapidly finished.

When the surface is dry the operation may be repeated and thus continued until the desired effect is produced.

For large surfaces it is well to mix three or more tints of varying darkness. After laying on the first line of the darkest tint, dip the brush in the next darkest and so carry on the shading until approaching the light edge, when finish with a clean brush and clear water.

In shading cylinders, cones, and spheres, the work is done very rapidly, as the dark tint is first laid in the interior of the surface and the shading must be carried away from the edges of this first tint in all directions before any of it may become dry.

Stippling.—When the work is uneven, as is often the case, due to irregularities in the paper and lack of experience, stippling may be resorted to to improve the effect. Fill the brush with a light tint and remove most of the color; touch the lighter portions of the tinting with the point of the brush until the surface is brought to the right effect by these points of color. After stippling, it is well to go over the whole surface with an even light tint to smooth down the effect. Many draftsmen stipple a drawing after the shading is complete, as it is thought to improve the effect.

Tracing.—If more than one copy of a drawing is required, it is traced, and blue-prints are made from the tracing. The business method is to make the original drawing in pencil only; this is traced in ink, and the tracing is kept as the original. The pencilled drawing is not retained.

Tracing-cloth or paper is transparent; it is tacked in place

over the drawing as described under "Thumb-tacks," and the method of tracing follows the method of inking the original drawing as described under "Plan of Procedure."

Tracings are made on the smooth or shiny side of the paper. As there is sometimes trouble in getting the ink to run freely on the tracing-cloth, special powders are furnished; dust on a little powder and rub it around with a cloth. Electro-silicon is found to be an excellent powder for this purpose. A blackboard-eraser saturated with chalk is sometimes rubbed gently across the paper for the same purpose and answers as well.

The tracing is completed, lettering, border lines, legend, etc. It is then removed from the board and trimmed, and blue-prints are made.

Be careful not to wet the tracing.

Errors should be erased only with the rubber ink-eraser. After that, rub the surface with a soapstone pencil and polish with agate or other hard substance.

Blue-printing.—The tracing is placed in the printing-frame, the shiny or drawing side next the glass; the sensitive paper is placed next the tracing, the sensitive side towards the tracing; the backing is put in place and the frame placed so that the sun's rays strike normally. Ordinarily in from five to ten minutes the print is completed. The print is removed from the frame in as dark a place as is convenient, and is then placed face down in a bath containing clear, running water sufficiently deep to cover the paper well.

The print is moved about occasionally and remains in the water about fifteen minutes. The action is made more rapid by placing a small quantity of ordinary salt in the water.

The print is now dried, preferably by being tacked at the upper edge so as to hang vertically. In this way it does not become curled and troublesome.

These blue-prints are now the working drawings used, as

many copies may be furnished; the original, the tracing, is carefully preserved.

Line shading may be very well done on tracing-cloth, but the tinting draws the cloth out of shape as the tint dries. So, instead of tinting, colored chalk is rubbed on the back of the tracing.

The same light and dark effects may be produced as with tinting, and the blue-print carefully reproduces these effects.

To write on a blue-print (white characters), or to scratch out or wipe out any portion that has been printed, use a saturated solution of sal-soda (washing-soda).

If the blue print is underexposed, it may be developed by acetic or hydrochloric acid bath.

The ordinary blue-print consists of white lines on a blue ground. Many prefer blue or black lines on a white ground. This is accomplished by printing from the tracing on special paper a "negative" which consists of white lines on a black ground. By using this "negative" instead of the tracing, a print of either blue or black lines on a white ground may be produced.

Sketches.—Sketches are considered one of the most important parts of the course. They are made in the sketch-books, free-hand, not to scale. The attempt is made to sketch as well as possible an accurate representation of an object in the different views needed, and to preserve quite accurately the relative proportions of the object. Dimensions are carefully taken with calipers and rule only and are clearly marked on the sketches.

The idea to bear in mind when making sketches is that there will be no further opportunity to see the object after once the sketch is completed; it is supposed that the one making the sketch is on detached duty and must make a sketch so accurate that he will be able to make a working drawing of the object at any later date.

No instruments whatever are used in making the sketches.

The pencil used is softer than HHHHHH and is sharpened to a point, and should be kept fairly sharp if good work is attempted.

The first sketches are made on the lined paper in the front part of the sketch-book. This assists in learning how to make straight lines free-hand, and also assists in drawing lines perpendicular to each other and in preserving the general proportions of the sketches. After the drawing of the brass models is completed, sketches are made on the unlined paper in the other parts of the book, as it is considered that all may have acquired sufficient ability by that time, and the lined paper may not always be at hand.

The sizes of the sketches are not in proportion to the size of the object sketched, but are large enough so that all details may be shown without confusion and so that all dimensions may be readily placed and clearly read.

As a rule, the same views are made in sketching as are made on the drawing-board, and the same dimensions that are placed on the sketch are eventually placed on the drawing. In the sketch, however, there are many abbreviations and lessenings of work. It is sufficient to represent a portion of the work. If a large surface is to be hatched, in the sketch only a small portion need be hatched, as it is understood that the remainder must be treated in the same manner. If there are a number of threads or bolt-holes of the same kind, it is sufficient to sketch one of them carefully and indicate the number and positions of the others.

The first thing to do when beginning a sketch is to examine the object and decide what sketches are required and then decide in what order to make them. If the book is sufficiently large, the general plan is followed and the points are projected from one drawing to the other. The projecting lines are not drawn. There may be a choice as to which one is drawn first. It may be the Plan, the Side Elevation, or the Front Elevation, but it is best to draw first the one that gives

the best general idea of the object and the most points to project from.

After the views are decided upon, next draw the center lines. Then the sketch continues according to the ideas of the sketcher.

The sketches are made quickly, a free sweep of the hand for the lines and a rapid proportioning by eye of the parts. After the sketches are completed, the arrow-points are placed on the sketches for the ends of the dimension lines. Cover the sketches with these arrows, deciding quickly what dimensions are needed. Then draw rapidly the dimension lines, leaving the spaces for the dimensions. Then make the measurements quickly and accurately and place them on the sketch. In this way the work goes on systematically and quickly. After completing the sketch, go over it with the idea of noting whether the object could be constructed from the notes taken and the sketch made. Write on the sketch the kinds of metals used in the different parts, unless these are shown by the symbolic hatching. Note if any of the bolts or nuts differ from the standard. Note what parts of the object are finished, and so state on the sketch. If the object is finished all over, note on the sketch, "Finished all over."

If a complicated machine is to be sketched, first make a free-hand sketch of the general outline, omitting all lesser details, but take special care to get the exact positions of the principal centers in all views. After the general view is sketched, the details may be drawn one by one.

The sketches must not be overcrowded with details.

From the dimensioned sketches the scale drawings are made. The scale of the drawing is decided upon, bearing in mind a correct and neat arrangement of the required views and the space for the legend.

Fig. 83 is a sample of sketching when the lined paper is used. It is seen that two views, part of one in section, are all

that are needed for a thorough representation of the object. The section shows the material to be cast iron.

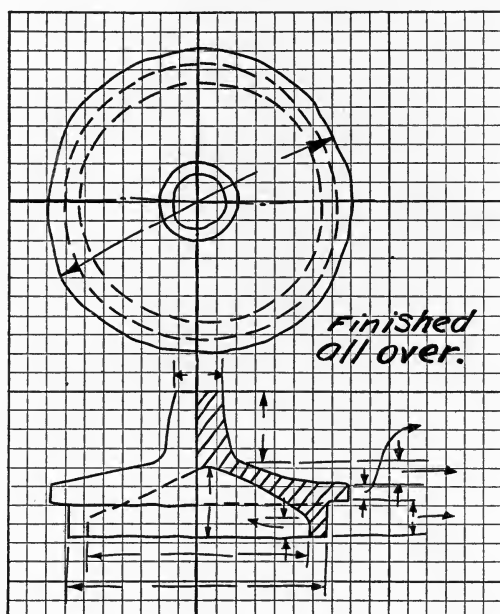

FIG. 83.

Plan of Procedure in Making a Drawing.—After the paper is stretched or tacked on the board and is ready for use, the following is the sequence of the different operations in making the drawing and blue-print (if required).

1. Examine the object to be drawn, and decide what views are necessary so that it may be properly represented.
2. Make dimensioned sketches.
3. Center the drawing-paper.
4. Mark the working, border, and cutting lines in pencil.
5. Decide on the scale to be used.
6. Establish the positions of the center lines and pencil them in carefully. (Special directions are given for the first

drawings or sheets, so that from this point the methods may vary slightly; but the same general plan is followed.)

7. Inspection of the drawing.
8. Pencil the drawing.
9. Inspection.
10. Ink the drawing in black ink: no sections, no tinting, no shade lines.
11. Inspection.
12. Tint or line shade, if required.
13. Inspection.
14. Draw center lines.
15. Draw extension and dimension lines.
16. Make the dimension figures and arrows.
17. Inspection.
18. Hatch sections.
19. Inspection.
20. Draw shade lines.
21. Inspection.
22. Make the legends and other lettering.
23. Draw the border lines.
24. Clean the paper.
25. Inspection.
26. Trace drawing. (If required.)
27. Inspection of tracing.
28. Remove and trim tracing, and cut the drawing from the board.
29. Make blue-prints.
30. Stretch or tack paper for the next drawing.

Remarks on the above: Before beginning any operation, read the remarks under that head.

Penciling the Drawings.—Read carefully the remarks under “Pencils.”

Note carefully the remarks under “Center Lines” and carefully make all measurements from them as far as possible.

Lay off first all center lines for portions of drawings.

When straight lines are joined by arcs in pencil-work, the straight lines are generally drawn first and centers of the arcs found and the arcs drawn so as to be tangent to the lines. The methods given in Geometry generally cover all cases.

When inking, the reverse method is followed, as the centers are already found; these centers should be made distinct in the pencilling, so that they may be readily found when inking.

Make no shade lines in pencil-work.

Do no hatching in pencil-work.

When a large number of lines radiate from a point, draw the outer lines to the point and stop all the others at a distance of from $\frac{1}{4}$ " to $\frac{1}{2}$ " away.

Leave no centers to be found when inking, and leave no lines to be "faired." The pencil-work must be complete except for shade lines, hatching, dimensions, and tinting.

Plan of Procedure in Inking.—Ink all the arcs on the board first, beginning with the largest; then ink all the irregular curve lines; then the straight lines. Always draw the straight lines *from* the curves if possible—never towards them.

After finishing the arcs and irregular curves, use the triangles, beginning at the top of the board. Place the T square so that the triangle laid in place will reach just above the highest lines on the board. Beginning at the left sweep across the board with the triangle and draw the vertical lines found at any part of any one of the drawings or views. Then lower the T square and again sweep across with the triangle; and so on until all the vertical lines on the board are completed.

The horizontal lines are drawn by means of the T square, beginning at the top of the board and sweeping the T square from top to bottom, drawing lines as they appear above the T square at any part of the board.

Read carefully the remarks under "R. L. Pen."

If the drawing is to be tinted or covered with line shading, note carefully the remarks under these headings, and take care not to draw a heavy line until the drawing has been washed.

In shading the circles, follow the method as in drawing them; shade the large ones first, then the smaller ones, etc.

Read carefully the remarks under "Shade Lines."

General Remarks.—Note always and continually the direction from which the light should come.

Keep the instruments clean. Clean them at once when through using them.

Keep the instruments not in use off the drawing-board.

Keep the paper clean.

Come to the drawing-room with clean hands, and clean them often while drawing, if necessary.

Cover the portions of the drawing not being worked upon with paper or cloth to keep them clean and the lines clear.

Never do free-hand work that may be done with the instruments. Even "breaks" and "tails" may be made best with instruments.

The excellence of the work is of far more importance than speed. It is better to make one good drawing than a dozen poor ones. Speed combined with excellent work is the object aimed at, but the speed must come last.

Pens that are dull, or instruments requiring repairs, may be turned in to the desk. It is advisable, however, for all to learn to sharpen their own pens.

When compass pens require sharpening, turn in the whole instrument, so the sharpening may be tested.

Pens that are found to be soft may be turned in for retempering.

Attach to the instruments turned in a slip of paper giving name, class, and repairs needed.

Write the names clearly on the covering cloths and on all triangular scales, irregular curves, etc.

Write the names clearly in ink on the N. W. corner of the drawing-paper outside the border line.

Bring all models to the middle of the room at the end of the period.

FIRST DRAWINGS.

THESE consist of two sheets. Sheet I is for the purpose of teaching the use of the instruments; Sheet II is a study of Projection and Working Drawings. In Sheet I there are twenty-one figures. Each figure represents a block raised above the drawing-board. Some of the figures show lines drawn on the upper surface of the blocks, and some show other figures resting on the top of the original one. The figures in this sheet are all "Plans." The remaining portion of the sheet is for the "Legend."

Figs. A to J consist of straight lines only. The attempt is made to bring into these figures all kinds of straight-line work.

Figs. K to V consist of arcs, combinations of arcs and straight lines, combinations of arcs with other arcs and with irregular curves, irregular curves. The attempt is made to bring into these figures all kinds of curved-line work.

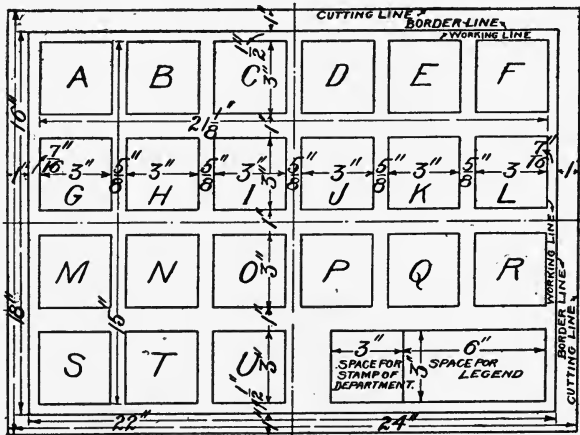

GENERAL VIEW OF SHEET I.

Sheet II consists of drawings of brass models. Several views are made of each model and the points are all projected. The models are cut across in certain planes and are pinned together. They may be separated at the planes, and sections studied and drawn. They are then hatched with Standard Hatching.

The figure on p. 105 shows the dimensions of the Working, Border, and Cutting Lines, and the dimensions of the figures of Sheet I.

SHEET I.

As stated under "Working, Border, and Cutting Lines," center the drawing-paper and draw the lines. Measure once only for these lines and carry the lines across from these measurements. The T square and triangles are depended upon for the rectitude of the lines.

On the first ruled page of the sketch-book make a sketch of the general view of the sheet, placing there the dimensions of the bounding lines of the paper and of the figures of the sheet. Full directions should be given with the sketch so that the outlines may be drawn from it. This should occupy only about one-fourth of a page in the sketch-book, leaving room for some of the figures.

Mark off to "full-size scale" the boundaries of the different figures of the sheet. Measure along the center lines and draw carefully. One measurement only should be made for each line, and the lines should be carried across the board.

The outer lines of the figures coincide with the working lines of the paper.

Sketch each figure in the sketch-book before putting it on the drawing-board. The text-book is then kept closed and the work is done entirely from the sketch-book. The text-book is to be used only for correcting the sketch. Sketch a row of figures at a time and then draw all the figures of that row.

Pencil-work.—Place Fig. A in the upper left-hand corner; continue on to the right along the upper row of figures; begin again at the left hand of the second row and continue as before to the right; leave the legend until all the figures are inked.

Finish completely in pencil all the figures of a horizontal row before inking any figure.

Pencil-lines cannot be made too fine, provided they are clear-cut and distinct. See notes under “Pencils and Pencil-ing.”

When the pencil-work of all the figures of a row is completed, the drawing must be inspected before the next step is begun.

Put no dimensions in pencil on the drawing.

When a row of figures is completed cover it with paper.

Ink-work.—In inking, do not make too fine lines. Follow the directions under “Use of the R. L. Pen.”

For this sheet disregard the general instructions for inking drawings, and ink each figure in its order as pencilled, but ink none until all the pencil-work of a row is completed.

When inking the drawing, make all the lines of the same figure and of the same type of the same width. Set the pen before drawing the first line, and draw a sample line on the margin of the paper beyond the cutting line, taking care to draw this line by guiding the pen against the T square or triangle. Often test the pen by drawing a line near the sample line for comparison.

When all the figures of a row are inked, the drawing must be inspected before the next step is begun.

After all the figures of the sheet are inked, draw the shade or relief lines on the right-hand and lower sides of the figures and on the other parts as required. Make these lines about four times as heavy as the other parts of the drawing. These lines are drawn over the lines previously drawn, but the extra width of line is *outside* of the original lines. All these shade lines

are of the same width throughout the sheet, and they must not be too heavy. The pen is opened the right amount, and the line made with one sweep.

In drawing these shade lines, draw the vertical ones first.

Another inspection of the drawing is made after the shade lines are completed.

After the shade lines are inspected, the legend is placed in the space reserved for it. Lines are drawn in pencil at the proper distances apart and the block letters are laid off. Care must be taken to calculate the spaces occupied by the letters so as to have the letters central in the space left for the purpose. See notes under "Lettering."

The lettering of the free-hand type is next made, the name written, and then an inspection follows. Scales are marked as stated under "Triangular Scale."

After this inspection, the border lines are drawn and the drawing cleaned.

A final inspection follows, and then the drawing is cut from the board. Paper is stretched or tacked for the next drawing.

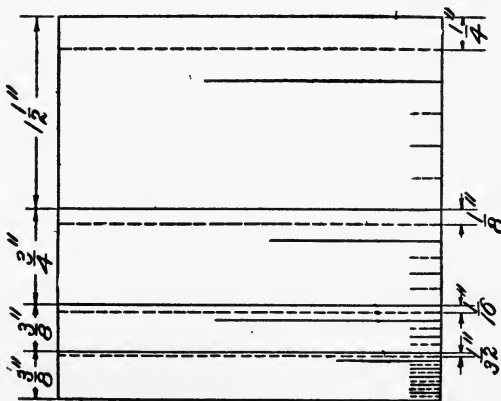

SHEET I. FIG. A.

Scale, full size. (Use 32 scale.)

Horizontal full and broken lines.

T square; triangular scale; full and broken lines, pencil and ink.

Pencil-work.—Measure off the vertical distances as given and mark the points with the bow spacer or pricker. Draw lines across at all marked points.

Sweep the lines across in pencil from left to right, not attempting to begin or stop the lines exactly at the boundary lines.

Ink-work.—The lines are alternately full and broken lines of standard width. Each line must be clear, the nibs of the pen cutting sharply. The endeavor is to make the full lines exactly alike, equal in width and distinctness, and the broken lines as much alike as possible, the dashes and spaces the same throughout. Begin the lines firmly, and carry them on with an even pressure, and stop them exactly at the boundary line.

Do not draw the dimension lines until all the figures of the row are completed. See notes under "Dimension Lines."

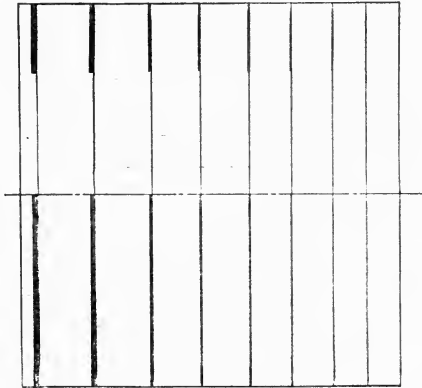

SHEET I. FIG. B.

Scale, 3" = 1 foot, or one-fourth size.

Vertical heavy lines.

T square; triangular scale; triangle; full lines, of varying widths when inked.

Pencil-work.—From one of the top corners lay off horizontally the following distances, each distance measured from the corner: $1''$; $2\frac{1}{8}''$; $3\frac{3}{8}''$; $4\frac{3}{4}''$; $6\frac{1}{4}''$; $7\frac{1}{8}''$; $9\frac{1}{8}''$; $11\frac{1}{2}''$.

Draw a horizontal center line and vertical lines through each of the points marked, also a line $\frac{1}{2}''$ above the lower boundary.

Ink-work.—Draw the boundary lines and the lines through the marked points. These lines are standard lines. Make the upper halves of the lines of increasing width, beginning at the left with very fine lines and increasing the width slightly for each new line. Place the extra width of the lines entirely beyond the original lines from the original point of measurement.

Do not continue the heavy lines quite to the top line, as it is difficult to carry a solid heavy line sharply to the end. After all the heavy lines are drawn, with the T square as a guide fill in the short spaces left with the R. L. pen and a fine opening.

Stop the lower heavy lines at a distance of one-half inch from the bottom. Draw the first five lines from the left like those above. Beginning with the sixth line from the left, draw lines as wide as for the upper half of the figure, but leave a narrow central strip of white.

These heavy lines will have to be squared at the ends by using the R. L. pen along the T square.

The right-hand and lower boundaries of the figure are shaded.

The center line is drawn, but not the line $\frac{1}{2}''$ above the lower boundary.

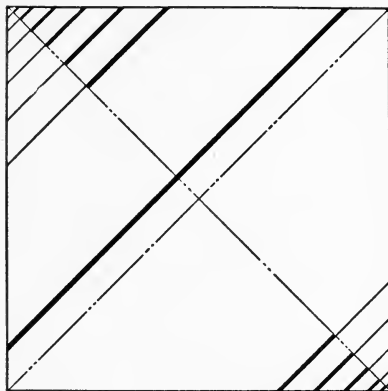

SHEET I. FIG. C.

Scale, 2" = 1 foot, or one-sixth size.

45° triangle.

T square; triangular scale; triangle; full lines, of varying widths when inked.

Pencil-work.—Draw the diagonals. From the N. W. and S. E. corners of the figure measure the following distances on the diagonal towards the center, each distance measured from the corners: $\frac{1}{4}$ " ; $\frac{3}{4}$ " ; $1\frac{1}{2}$ " ; $2\frac{1}{2}$ " ; $3\frac{3}{4}$ " ; $5\frac{1}{4}$ " ; 7" ; 9" ; $11\frac{1}{4}$ ". The remaining distances are each $1\frac{1}{2}$ " , which is a *check*.

Through these marked points draw lines parallel to the other diagonal of the figure.

Ink-work.—Draw the boundaries of the figure as standard lines and the lines through the marked points with a fine pen. Beginning with the lines nearest the corners make half of each successive line heavier than the preceding in about the proportion of Fig. B.

The two lines nearest to the center are made heavy all the way across. The added width of the lines is towards the center.

The diagonal lines are drawn as construction lines. See

page 164, "Lines to be used in Drawings," at end of book.

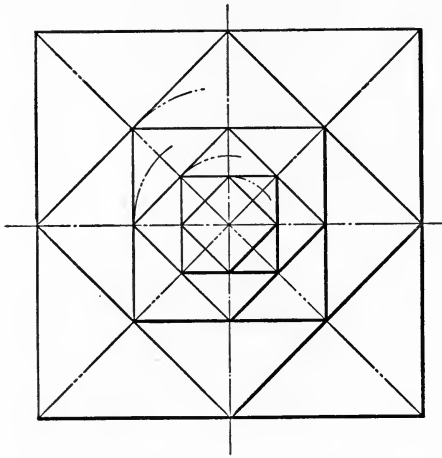

SHEET I. FIG. D.

Scale, full size.

45° triangle.

T square; 45° triangle; full lines in pencil and ink; shade lines.

The figure represents blocks resting centrally on each other, the smallest on top.

Pencil-work.—Center the figure and draw as shown, using only the T square and the 45° triangle.

The *checks* on the work are the inscribed circles, as shown.

Ink-work.—The lines are all standard lines.

The construction and check lines are drawn.

The blocks are shaded according to remarks under "Shade Lines."

Carefully choose the proper width of line, and do not change the pen when shading.

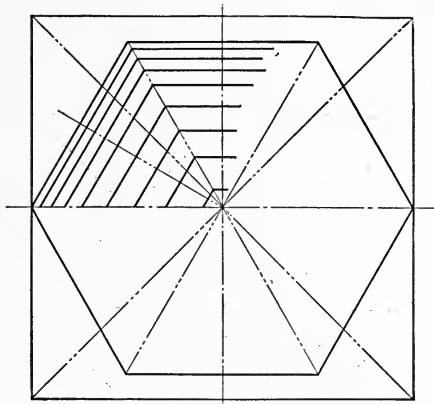

SHEET I. FIG. E.

Scale, $\frac{3}{8}'' = 1$ foot, or one thirty-second size.

60° triangle.

T square; triangular scale; triangles; full lines of standard width, pencil and ink; shade lines.

The figure represents blocks resting centrally on each other, the smallest on top.

Pencil-work.—Center the figure with the 45° triangle laid along the T square. With the 60° triangle laid along the T square draw lines making angles of 60° with the horizontal through the center of figure.

From the extremities of the horizontal center line draw lines making angles of 60° with the horizontal, and extend them to cut the lines last drawn. Through these intersections draw horizontal lines. This forms a hexagon.

Through the central point of the figure draw a line at 30° with the horizontal, and extend it to cut one side of the hexagon. This line will be at right angles to the side of the hexagon. Beginning at the side of the hexagon, measure to scale towards the center of figure along the line last drawn the following distances, each distance measured from the side of the hexagon: 2"; 4"; 7"; 11"; 16"; 22"; 2 ft. 5"; 3 ft. 1".

Through these points draw lines parallel to the side of the hexagon from which the distances were measured. Carry these lines around the figure.

They make a number of hexagons within the original hexagon.

Portions of circles are drawn with the bow spacers as far as they can be used, and after that with the compasses through the extreme points of each hexagon, as a *check*.

The center of figure is the center from which these circles are drawn.

Ink-work.—Ink with standard lines the boundaries of the figure and the hexagonal blocks. Ink center lines and diagonals of hexagons only.

Place shade lines on the blocks. Take care that the heavy portion is outside the original line.

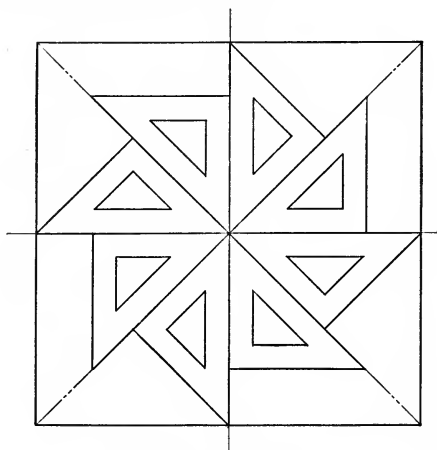

SHEET I. FIG. F.

Scale, 1" = 1 foot, or one-twelfth size.

45° triangle.

T square; triangular scale; 45° triangle; full lines, pencil and ink; shade lines.

The figure represents several 45° triangles.

Pencil-work.—Center the figure and draw the vertical center line and the diagonals. Draw the triangles as shown. The distances between the outer edges and the openings in the triangles is $2\frac{1}{4}$ " to the given scale.

Checks for the work are circles drawn with the center of figure as a center and through the corresponding points of the triangles.

Ink-work.—Use standard lines and ink no construction or check lines. Extend both center lines beyond the figure. Shade the proper edges.

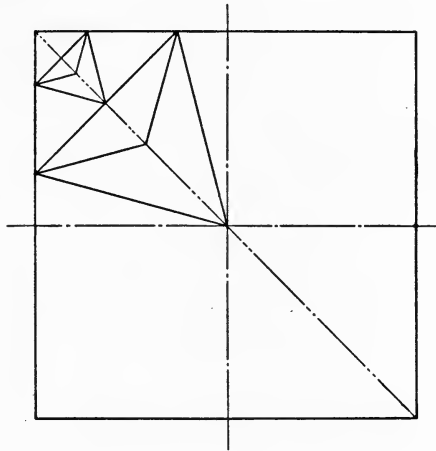

SHEET I. FIG. G.

Scale, full size.

45° and 60° triangles.

T square; triangles; full lines of varying widths, pencil and ink.

Pencil-work.—Draw the diagonals. With the 45° triangle in position on the T square and the 60° triangle resting against the 45° triangle, draw the figure for all four quadrants. The *checks* for accuracy are circles drawn with the center of figure as the center and radii for corresponding points.

30° with the T square. From the divisions of GH draw lines at angles of 60° with the T square.

The horizontal center line LM is a check, as all the intersections should be on that line.

Ink-work.—Draw full lines as fine as the pen will maintain from the divisions of AE and FC to the horizontal center line.

Draw full lines from the divisions of GH to the horizontal center line, the lines to be of the same width as the lines previously drawn—noting that the lines stop where they come in contact with the previously completed full lines.

Draw standard lines from the divisions of AB to the vertical center line.

Draw the vertical and horizontal center lines.

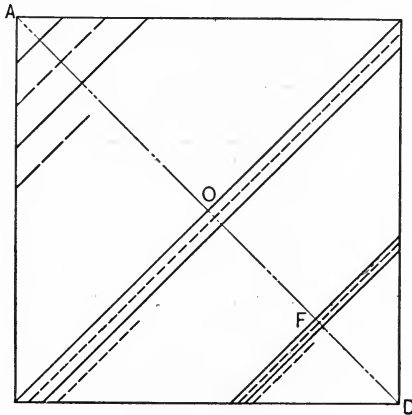

SHEET I. FIG. I.

Scale, full size.

Bow spacers.

T square; 45° triangle; bow spacers; full lines in pencil, full and broken lines in ink.

Pencil-work.—Draw the diagonals. These should check exactly with the 45° triangle laid along the T square.

With the bow spacers, space by trial (see "Bow Spacers") each of the half-diagonals AO and OD into nine parts, and draw

full lines through each point parallel to the other diagonal, using the 45° triangle sliding along the T square. Draw from the S. W. point and begin with that nearest *A*.

Do not take time to begin and stop the lines at the boundaries.

With the bow spacers divide each space of *OD* into three parts and draw full lines as before.

F is at five of the original spaces from the center.

Divide the spaces *FD* into two parts with the bow spacers and draw lines as before.

Note that in this figure the lines that are to be broken lines when inked are not drawn broken in the pencil-work.

Ink-work.—Draw the lines alternately full and broken lines, varying the lengths of the dashes from $\frac{1}{4}$ " long for the lines farthest apart to $\frac{1}{16}$ " long for those nearest together.

Ink diagonal construction line.

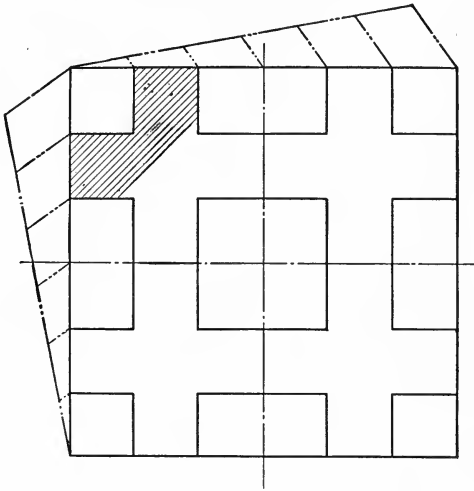

SHEET I. FIG. J.

Scale, full size.

Section: **Hatching.**

T square; triangles; bow spacers; full lines, pencil and ink; shade lines; hatching.

The figure represents a horizontal section through a piece of cast iron, the iron resting on the lower block.

Pencil-work.—Divide one top and one side boundary line into six parts each by drawing lines from a corner at an angle and using the bow spacers and a different spacing length for each.

Draw the horizontal and vertical lines, running them entirely across the figure. Do not hatch in pencil.

Ink-work.—Draw the figure in standard lines.

Begin at the N. W. corner and hatch the figure with lines at an angle of 45° , from S. W. to N. E.

The line used for hatching is not the finest the pen may make, but is as fine a line as can be depended upon. Do not fail to make every line of the hatching just as distinct as if it were a line of the figure.

When a line of the hatching is begun and ends at a space, the same line is continued beyond the space if it would cut the figure farther on.

Shade the figure according to remarks under "Shade Lines."

Refer to remarks under "Hatching."

Ink center and construction lines.

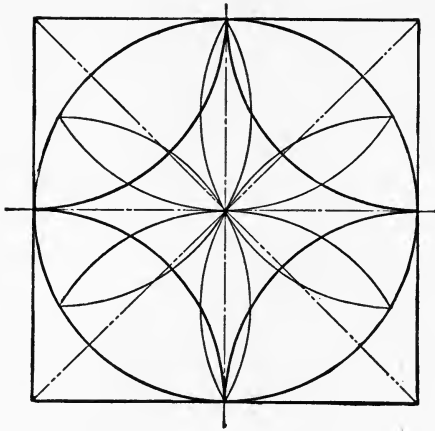

SHEET I. FIG. K.

Scale, full size.

Compass.

T square; triangles; compasses; same radius for all circles; full lines in pencil and ink; varying widths of lines in ink-work. See remarks under "Compasses."

Pencil-work.—Center the figure by drawing diagonals. Use the center of figure as a center and a radius to the middle point of one side and draw a circle. Take care to properly bend the knees of the compass. This circle should exactly touch the boundaries at the *middle points*.

Begin at the middle point of the left-hand boundary line and with the same radius as before draw an arc ending at the first circle drawn. Use the point where this arc cuts the first circle drawn as a center and draw another arc; and so on around until the last arc drawn passes through the first center used on the left. Every one of these arcs should pass exactly through the *center of figure*.

From each of the corners of the figure draw arcs. These should pass exactly through the middle points of the *sides*.

Ink-work.—Set the pen for the first circle and first set of arcs drawn. Make this a fair line—not as fine as the pen will make—and draw a sample line on the margin of the paper where others may be compared with it at will. Draw the first circle. Draw the next set of arcs until they end at the first circle.

Set the pen for the other arcs, making the sample line the standard line. Draw the arcs that have the corners as centers, extending them to the boundaries.

Draw the construction and center lines.

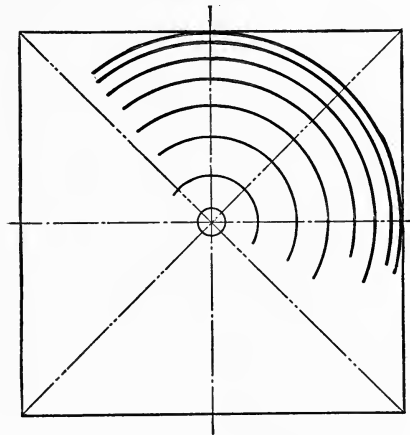

SHEET I. FIG. L.

Scale, 4" = 1 foot.

Compasses, bow, pencil, and pen.

T square; triangles; triangular scale; compasses; bow pencil and pen; full lines, pencil and ink, varying widths in ink.

Pencil-work.—Center the figure. Draw the center lines. From the middle point of the top boundary line measure downward the following dimensions: $\frac{1}{4}$ " ; $\frac{5}{8}$ " ; $1\frac{1}{8}$ " ; $1\frac{3}{4}$ " ; $2\frac{1}{2}$ " ; $3\frac{3}{8}$ " ; $4\frac{1}{8}$ ". The *remaining distance* to the center is $\frac{3}{8}$ ".

Using the bow pencil (see notes under "Bow Pencil") with the center of figure as a center draw circles through each

of the points marked, until the circles became so large that the compasses must be used.

Ink-work.—Using the bow pen (see notes under “Bow Pen”), draw the smaller circles. Use compass for the larger ones. Make the inner one a fine line and the others gradually increasing in width to the outer one, the one tangent to the boundaries. Place the extra width of line on either side of the pencil-line but do not make the outer circle pass outside the boundaries.

Draw the diagonals and the horizontal and vertical center lines.

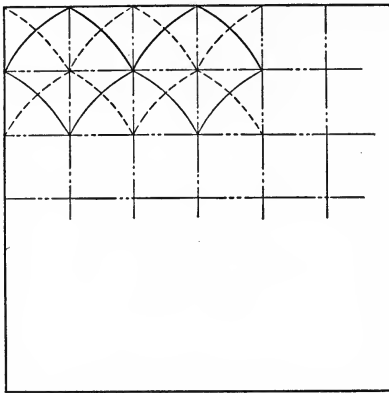

SHEET I. FIG. M.

Scale, full size.

Bow pencil and pen.

T square; triangles; triangular scale; bow pencil and pen; full lines in pencil, full and broken lines in ink.

Pencil-work.—Draw the center lines. Divide each of these lines into six parts by any method and draw vertical and horizontal lines through these divisions. Draw arcs as shown, using a radius equal to the length of the diagonal of two adjacent squares. Take time in getting the exact radius by

trial at several points and do not change this radius while drawing the arcs.

Ink-work.—Set the pen as exactly to the correct radius as possible and do not change the setting while drawing the lines. Make the lines quite fine. Draw every other pair of arcs full lines and the remaining ones broken lines with dashes about $\frac{1}{16}$ " long.

After all the arcs are drawn, go over the top and bottom rows of full lines, making them standard lines, keeping the extra width of line within the boundary lines.

Draw the vertical and horizontal lines as construction lines.

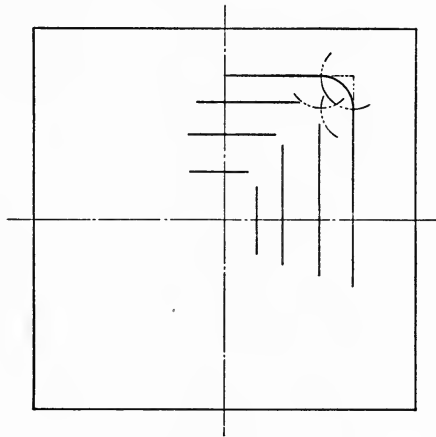

SHEET I. FIG. N.

Scale, 2"=1 foot.

Fillets.

T square; triangles; triangular scale; bow pencil and pen; full lines in pencil, full and broken lines in ink.

The figure represents blocks resting upon each other.

Pencil-work.—Draw the center lines. On the horizontal center line measure from the center to right and left the following dimensions: $1\frac{1}{2}$ "; $2\frac{3}{4}$ "; $4\frac{1}{2}$ "; 6"; $7\frac{1}{4}$ "; $8\frac{1}{4}$ "; 9".

On the vertical center line measure from the center upwards and downwards the following dimensions : $2\frac{1}{4}''$; $4''$; $5\frac{1}{2}''$; $6\frac{3}{4}''$; $7\frac{3}{4}''$; $8\frac{1}{2}''$; $9''$.

Construct rectangles with the use of the T square and triangles on the corresponding measurements. Connect the corners of the rectangles with small arcs or "fillets," as follows :

For the N. E. corners, use radii in succession, beginning with the inner rectangle, as follows : $\frac{1}{2}''$; $1''$; $1\frac{1}{2}''$; $2''$; $2\frac{1}{2}''$; $3''$; $3\frac{1}{2}''$.

For the N. W. corners, as before, use the following radii : $\frac{3}{4}''$; $1\frac{1}{4}''$; $1\frac{3}{4}''$; $2\frac{1}{4}''$; $2\frac{3}{4}''$; $3\frac{1}{4}''$; $3\frac{3}{4}''$.

For the S. W. corners, as before, use the following radii : $1''$; $1\frac{1}{2}''$; $2''$; $2\frac{1}{2}''$; $3''$; $3\frac{1}{2}''$; $4''$.

For the S. E. corners, as before, use the following radii : $1\frac{1}{2}''$; $1\frac{3}{4}''$; $2\frac{1}{4}''$; $2\frac{3}{4}''$; $3\frac{1}{4}''$; $3\frac{3}{4}''$; $4\frac{1}{4}''$.

In drawing these fillets, from the corner of the rectangle swing an arc around of the correct length to cut the adjacent sides of the rectangle. From these points swing arcs of the same radius to meet each other. These last points are the centers from which to draw the fillets.

Many draftsmen of experience do not take the trouble to define these centers, but find them rapidly and accurately by trial.

Carefully draw all these fillets with the bow pencil. Mark the centers clearly. Swing the arcs beyond the points of tangency, as it is impossible to determine that the arc is exactly right if it stops on the line.

Ink-work.—Ink all the fillets first with standard lines.

In inking the straight lines, carefully set the bow pen for the first line to agree with the line of the fillets. Draw the vertical lines first one after the other, beginning at the left. Always draw from the fillet at the left hand towards the one at the right and stop the line near the fillet and draw a line from the right-hand fillet to meet the previously drawn line.

This allows of a slight moving of the pen from or towards the triangle or T square to meet the other line fairly. This case of drawing a straight line to meet two curves is the only one where it is advisable to break the general rule of drawing from left to right.

Shade each block.

Draw the center lines.

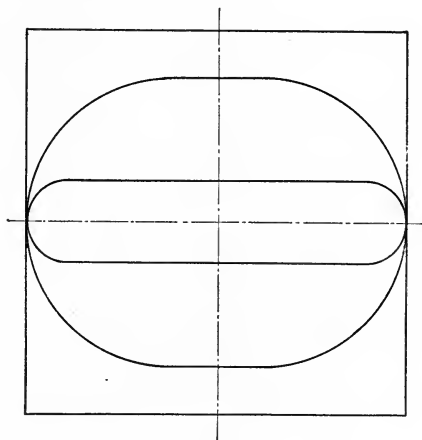

SHEET I. FIG. O.

Scale, $\frac{1}{2}'' = 1$ foot.

Two arcs and straight line joining them.

T square; triangles; triangular scale; bow pencil and pen; connecting tangents with arcs; full lines in pencil, full lines in ink.

Pencil-work.—Draw the center lines.

With centers on the horizontal center line, draw arcs tangent to the side boundary lines at the middle points with the following radii: 2 ft. $6\frac{1}{2}''$; 2 ft. $3''$; $21\frac{1}{2}''$; $14\frac{1}{2}''$; $8''$; $2''$.

Connect these corresponding arcs above and below the horizontal center line with straight lines, using the triangles

only. Draw a line away from the left-hand arc and extend it to near the other arc; then break the established rule of drawing lines from left to right and draw a line away from the right-hand arc to connect with the line already drawn.

The T square moved up and down the board is a *check* on the work.

Ink-work.—Draw the arcs and tangents in full lines, making the inner one a fine line and increasing the width of the other lines as the radii increase.

Draw the vertical and horizontal center lines.

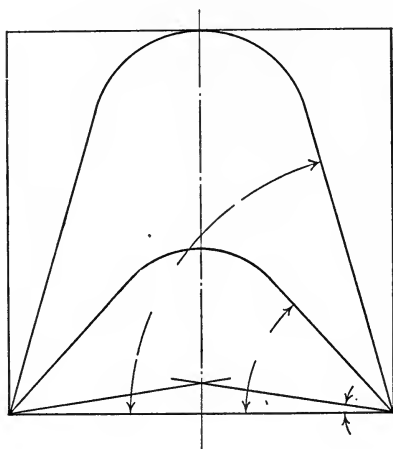

SHEET I. FIG. P.

Scale, full size.

Protractor, arcs, and straight lines.

T square; triangles; triangular scale, protractor; full lines in pencil, full and broken lines in ink.

Pencil-work.—From the two bottom corners lay off upward from the bottom line and within the figure the following angles: 5° ; 11° ; $18^{\circ} 30'$; 27° ; $36^{\circ} 30'$; 48° ; $60^{\circ} 30'$; 74° ; $88^{\circ} 30'$.

Join seven of the corresponding pairs of lines with tangential

arcs of the following radii in succession, beginning with the lines drawn from the smallest angles: $2''$; $1\frac{3}{4}''$; $1\frac{1}{2}''$; $1\frac{1}{4}''$; $1''$; $\frac{3}{4}''$; $\frac{1}{2}''$. For the next set of lines use a radius that will make the arc tangent to the two lines and to the top boundary line. For the last set of lines, use a radius of $\frac{1}{2}''$ and draw arcs tangent to the lines and to the top boundary line.

The centers are found by trial.

Ink-work.—Ink all the arcs first and draw the straight lines away from the arcs. Make the lines all standard.

Draw the vertical center line. Lay off and figure dimension angles at lower right-hand corner.

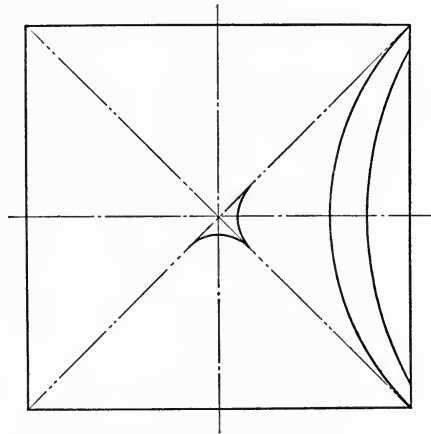

SHEET I. FIG. Q.

Scale, 10.

Tangent arcs.

T square; triangles; triangular scale; compasses; bow pencil and pen; full arcs in pencil, full lines in ink.

Pencil-work.—Center the figure and draw center lines and diagonals, extending these lines beyond the boundaries of the figure about $3''$.

From the center of figure measure on one of the center lines

in one direction only the following dimensions: ".50; ".75; 1"; 1".25; 1".75; 2".25; 3"; 4".

With the bow pencils and compasses, swing these dimensions around the central point and mark them on the other side of the center line used and on both sides of the center line not first used.

With these points as centers draw arcs tangent to the adjacent diagonals, extending them just enough beyond the diagonals to ensure their tangency. These radii are determined by trial only.

The larger arcs meet the extensions of the diagonals, but are drawn only within the boundaries.

Checks for the work are circles drawn with the center of figure as a center and radii to the points of tangency of corresponding arcs on the diagonals.

Ink-work.—Draw the arcs from diagonal to diagonal in standard lines.

Draw the center and diagonal lines.

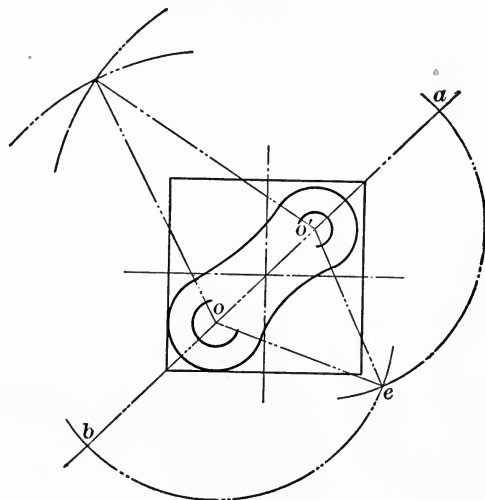

SH.ET I. FIG. R.

Scale, full size.

Connecting arcs.

T square; triangles; triangular scale; bow pencil and pen; compasses; full lines in pencil, full and broken lines in ink.

Pencil-work.—Center the drawing by diagonals. Find the middle points of the half diagonals running N. E. and S. W. From the lower one of these centers draw arcs with the following radii: $\frac{1}{4}''$; $\frac{3}{8}''$; $\frac{1}{2}''$; $\frac{5}{8}''$; $\frac{3}{4}''$.

From the upper one of these centers draw arcs of the following radii: $\frac{1}{8}''$; $\frac{1}{4}''$; $\frac{3}{8}''$; $\frac{1}{2}''$; $\frac{5}{8}''$.

Connect the arcs on the lower side, beginning with the largest of each set, by arcs with the following radii in succession: $2''$; $2\frac{1}{8}''$; $2\frac{1}{4}''$; $2\frac{3}{8}''$; $2\frac{1}{2}''$. These arcs are convex looking from the top down.

Connect the first set of arcs on the upper side, beginning with the largest of each set, by arcs with the following radii in succession: $3\frac{1}{2}''$; $3\frac{7}{8}''$; $3\frac{3}{4}''$; $3\frac{5}{8}''$; $3\frac{1}{4}''$. These arcs are concave looking from the top down.

The centers of these arcs are found as follows:

On any line through the center o' , as the line oo' , measure off from the arc drawn with o' as a center the distance for the radius of the tangent circle. This gives, for instance, the point a . On any line through the center o , as the line oo' measure off from the arc the same distance, as the point b . With o' as a center and radius $o'a$, and with o as a center and radius ob , strike arcs to meet each other. This is the center required, as point e .

Draftsmen of experience often find these centers by trial, as that method is quicker and sufficiently accurate for all practical purposes.

Ink-work.—Draw the larger arcs first with the compasses and then the smaller ones with the bow pen. This allows of slight bending or springing of the bow pen to allow for inaccuracies of the work.

The lines are made standard size and the two inner sets of lines are broken, with dashes about $\frac{1}{8}''$ long. Stop the inner lines at the points of meeting. Shade the three larger figures.

Draw diagonals and one set of construction lines.

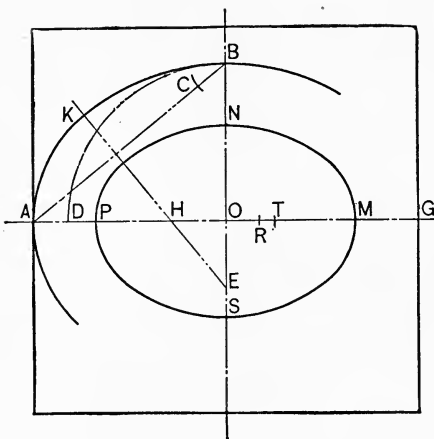

SHEET I. FIG. S.

Scale, full size.

Ellipses: Irregular curves.

T square; triangles; triangular scale; bow pencil and pen; compasses; irregular curves; full lines in pencil and ink.

Pencil-work.—Center the figure and draw the center lines.

From the center measure upwards the following dimensions: $\frac{3}{4}$ ''; 1''; $1\frac{1}{4}$ ''.

From the center measure to right or left the following dimensions: 1''; $1\frac{1}{4}$ ''; $1\frac{1}{2}$ ''.

The corresponding horizontal and vertical distances are semiaxes of ellipses. Construct the largest of the ellipses on these axes extended to the other sides of the center, by the following method:

Draw AB . With O as a center swing the distance OB to the point D . Take the distance AD and measure it from B to C . Bisect AC and extend the bisecting line to meet the vertical axis at E . With E as a center and a radius EB draw an arc to right and left of B , extending it to the line EK . With H as a center draw an arc with HA as a radius; this line will meet the line of

the ellipse drawn from B with E as a center, and this method of construction is an approximate method of constructing an ellipse. If the work is not done with the utmost accuracy, the irregular curves must be used to join the arcs fairly. See note under "Irregular Curves."

Construct the remaining ellipses by the following method: From M lay off the semiminor axis, ON , to the point R . With the length RP as a radius describe arcs through N and S . Make $OT = \frac{3}{2}OR$. With T as a center draw an arc through M . If drawn with care this arc meets those already drawn.

Divide the horizontal center line into twelve equal parts, using the triangular scale.

On the two outside lines next the vertical boundary lines measure off from the horizontal center line, above and below, $10''$.

On the next two interior lines on each side measure off in the same way $11\frac{3}{4}''$.

On the next two lines measure as before $12''$.

On the next two lines measure as before $11\frac{3}{4}''$.

On the next two lines measure as before $11\frac{1}{2}''$.

On the middle line measure off as before $11\frac{1}{2}''$.

See notes under "Irregular Curves."

Through the ends of the horizontal center lines and the corresponding measurements draw a smooth curve with the aid of the irregular curves. The line is to be tangent to the vertical boundary line at the middle point.

Note that the curves correspond on either side of the center lines.

Ink-work.—Draw the arcs of the ellipses first and finish with the irregular curves later, if necessary. Care is required in carrying the arcs just far enough and not too far. The lines are all standard lines (shaded for ellipses). Ink the irregular curve with standard line.

Draw center lines and the construction lines of one-quarter of one ellipse drawn by each method.

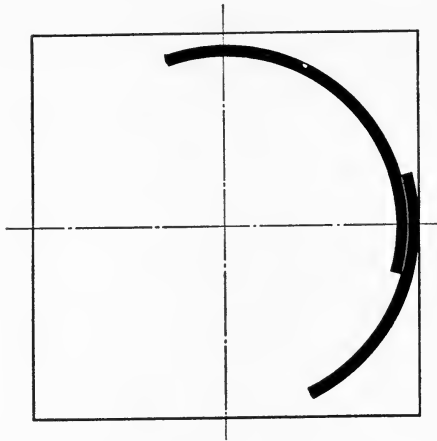

SHEET I. FIG. T.

Scale, 1"=1 foot.

Heavy lines with narrow spaces between.

T square; triangle; triangular scale; bow pencil and pen; compasses; shade lines; full lines in pencil and ink.

The figure represents sections of sheet metal standing on end. Where the sheets lap, a fine white line is left, the entire width of this being taken from one sheet. The ends of the laps are closed, as shown.

Pencil-work.—Use the center of figure as the center for the rings of metal. The radii of the mean diameters of the rings are as follows: 9"; $12\frac{3}{4}$ "; $16\frac{7}{8}$ ".

The thicknesses of the sheets, beginning with the outer ones, are: $1\frac{1}{8}$ "; 1"; $\frac{3}{4}$ ".

Make the joints for the outer rings at the sides and for the next inner one at top and bottom. Alternate to the innermost one.

The laps are 30° long, half on each side of the center line. Construct the joints of plating.

Ink-work.—Carefully draw the boundaries of the metals with quite a fine opening of pen and fill in with a widely opened

pen. Do not attempt to bring the heavy ink-lines sharply to the ends. Finish them off with the triangle and R. L. pen.

Draw center lines. Dimension the complete circles, giving diameters. (See Dimensions.)

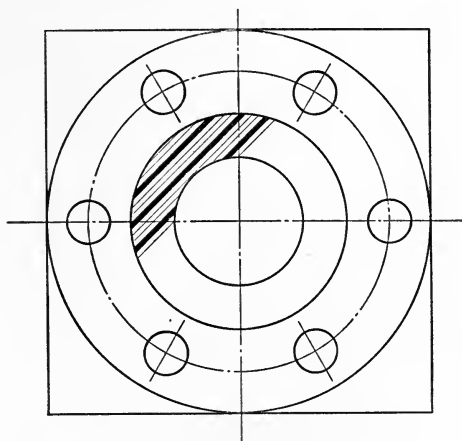

SHEET I. FIG. U.

Scale, 2" = 1 foot.

Shading circles: Hatching.

T square; triangles; triangular scale; compasses; bow pencil and pen; shading circles; full lines in pencil and ink.

The figure represents a section of a hollow shaft showing beyond the section the enlarged portion for the coupling to join it to the next shaft. The coupling rests on the rectangular block and the shaft is vertical.

Diameter of the outer circle of the coupling.	18"
Diameter of the outside of the shaft.	10"
Diameter of the axial hole in the shaft.	6"
Diameter of the bolt-circle.	14"
Diameter of the bolts.	2"
Number of bolts.	6

Pencil-work.—Draw the center lines. The central point is the center of the shaft.

Ink-work.—After the figure is completed with standard lines, shade the circles.

Draw the center lines and the bolt-circle.

Dimension the drawing in accordance with the notes under "Dimension Lines." Mark the centers of the bolt-holes with short full radial lines. These are at right angles to the bolt-circle, thus marking the centers properly. Hatch the section (wrought steel). See "Standard Hatching." Hatch as if for cast-iron and then fill in the proper spaces.

Legend and Lettering the Sheet.—The legend reads:

SHEET I.

STRAIGHT AND CURVED LINE DRAWING.

Name [F. K. Jones.] *Class* [Fourth Class.]

Date [Dec. 1, 1910.]

The space to be used is divided and the sizes of the lettering arranged by each one according to his judgment. "Sheet I" and "Straight and Curved Line Drawing" are made in block letters of two different types, but of straight lines only. See pp. 80 and 81 for the former and p. 82 for the latter. The word "Drawing" is on a lower line as the entire inscription would be too long. The remainder of the legend except the name is made in free-hand lettering." The name is an autograph.

Above each figure the number of the figure is centrally placed, as Fig. A, Fig. B, etc., in "free-hand lettering." The bottom line of the lettering is $\frac{1}{8}$ " above the top of the figures.

The scale is centrally placed below each figure, the bottom line of the lettering $\frac{3}{8}$ " below the bottom of the figure. This is also "free-hand lettering."

The effect is improved by drawing moderately heavy black lines just under the lettering.

The boundaries of all figures are shaded on the right and bottom.

Border Line.—After the lettering is completed, the border line is drawn. See "Border Line." The drawing is cleaned and finally inspected. It is then cut from the board.

12



13

14

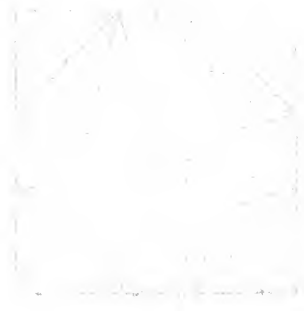

15

16

17

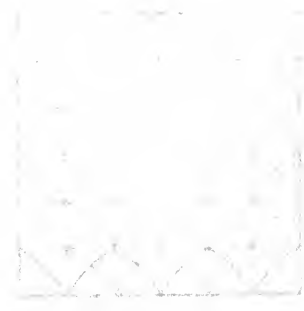
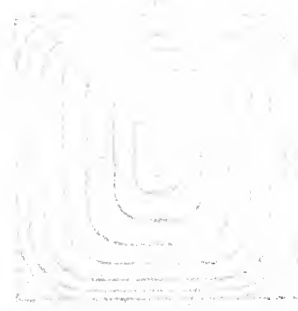

18

19

20

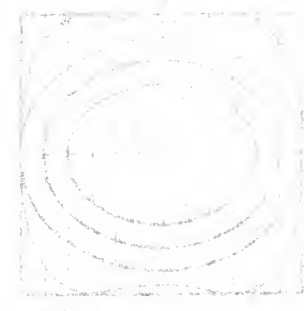
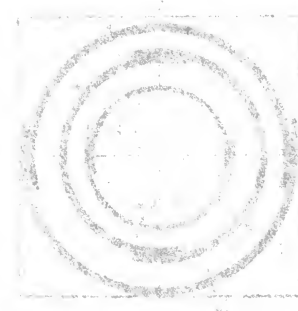

21

22

23

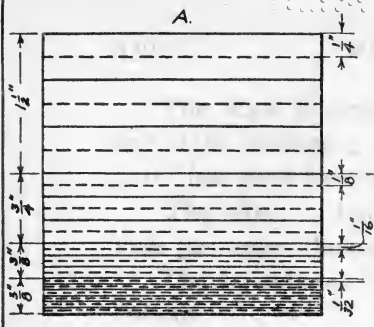

A. Scale, Full Size.

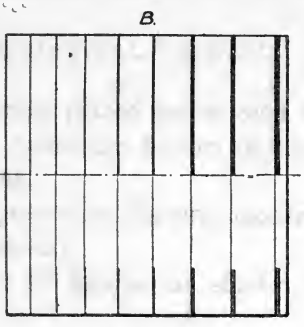

B. Scale, 3" = 1 Ft.

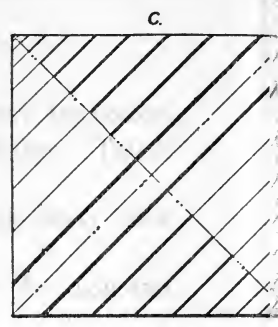

C. Scale, 2" = 1 Ft.

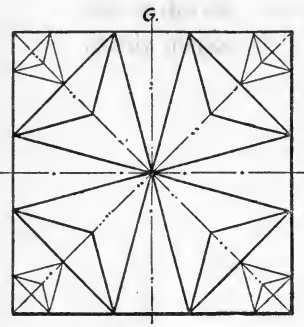

G. Scale, Full Size.

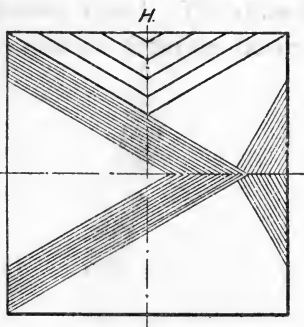

H. Scale, 4" = 1 Ft.

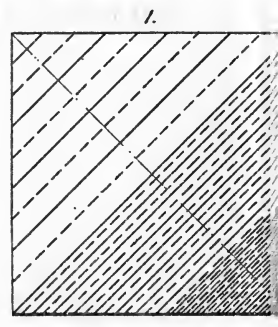

I. Scale, Full Size.

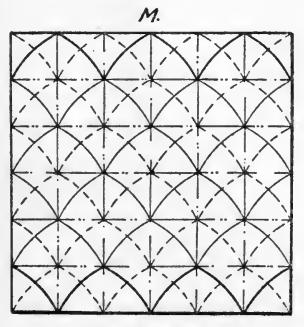

M. Scale, Full Size.

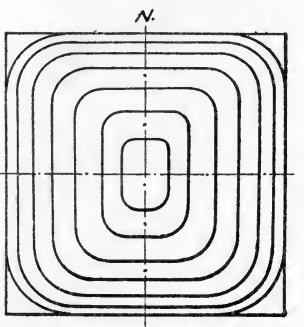

N. Scale, 2" = 1 Ft.

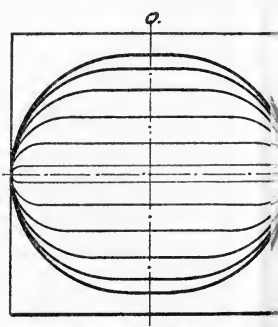

Q. Scale, 1/2" = 1 Ft.

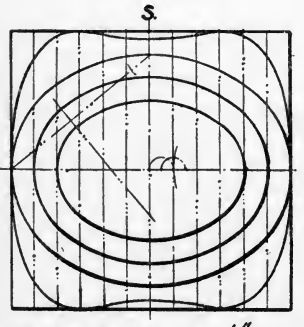

S. Scale, full size & 1/2" = 1 Ft.

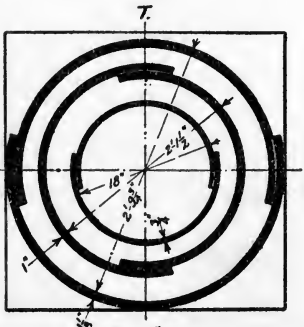

T. Scale, 1" = 1 Ft.

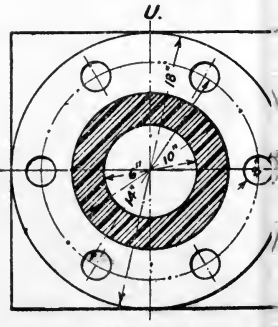

U. Scale, 2" = 1 Ft.

D.

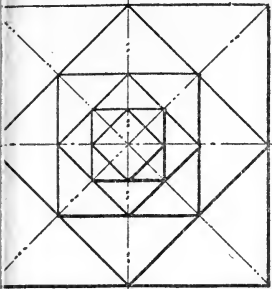

Scale, Full Size.

E.

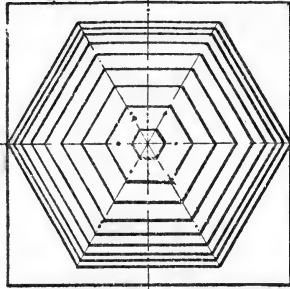

Scale, $\frac{3}{8}'' = 1 \text{ Ft.}$

F.

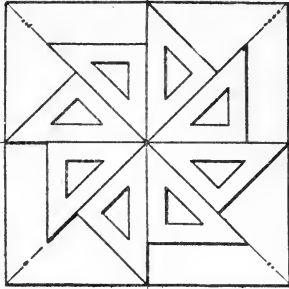

Scale, $1'' = 1 \text{ Ft.}$

G.

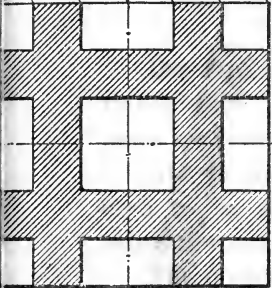

Scale, Full Size.

H.

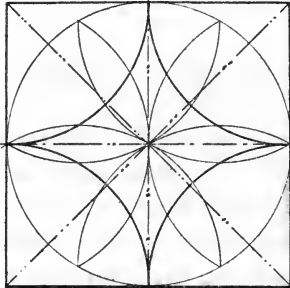

Scale, Full Size.

I.

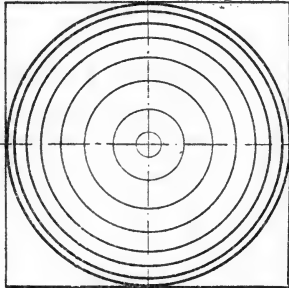

Scale, $4'' = 1 \text{ Ft.}$

J.

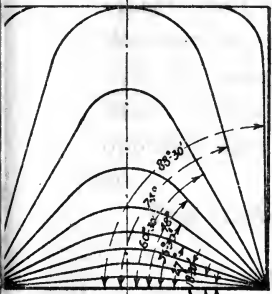

Scale, Full Size.

K.

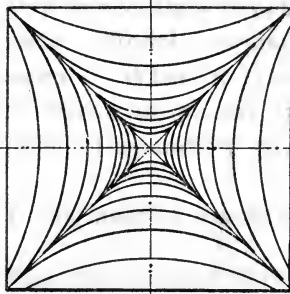

Scale, Full Size, Decimal.

L.

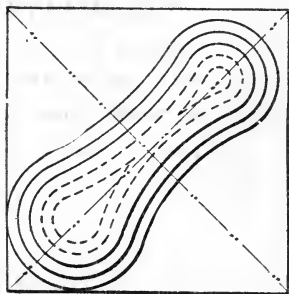

Scale, Full Size.

SHEET I.

STRAIGHT & CURVED LINE DRAWING

J. W. Johnson

(for) 4th Class

Oct. 10 1910.

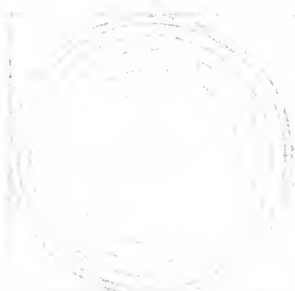

SHEET 1

PROF. J. G. BROWN

DRAWING

1880

NO. 10



SHEET II.

WORKING DRAWINGS.

SKETCHING ; VIEWS ; CENTER LINES ; PROJECTION ; SECTIONS ; HATCHING ; DIMENSIONS. (SEE REMARKS UNDER THESE HEADS.)

Description of Models.—Three brass models are used for this sheet. These are cut across in certain planes and the parts are pinned together. They may be separated into parts in order to study and draw sections. The models are considered to be solid and are drawn accordingly. The lines of separation are generally along center lines.

The dowel pins and holes are not drawn.

The different models of each kind differ slightly in dimensions, so that care must be taken to note the marks on the models used, as it may be necessary to again refer to them after the sketches are made. Models are marked on each portion with the same characters. Where the portions are of the same shape, center-punch marks are placed opposite each other on opposite sides of a plane of separation: as, —∴—, ∴∴∴, ∴∴∴∴, etc.

This conforms to engineering practice.

GENERAL DIRECTIONS FOR WORK.

Tack paper for this sheet.

The drawings of the views are to "Scale, full size."

The sheet is to be inked and completed, not traced.

Sketch model I.

Inspection of sketch.

Pencil the views of model I on drawing-paper.

Inspection.
Cover drawing with paper.
Same, model II.
Same, model III.
Pencil legend.
Inspection.
Ink and completely finish the views of model I.
Inspection.
Cover drawing with paper.
Same, model II.
Same, model III.
Ink legend, draw border, clean drawing.
Inspection.
Cut drawing from board.

GENERAL DESCRIPTION OF SKETCHING.

Sketches of the different views of each model are first made in the sketch-books. Note carefully that no instruments but the medium hard lead-pencil are used in making the sketches. Even the center lines and the arcs must be drawn free-hand.

Only the foot rule and the calipers are used in making the measurements.

Unless the model is large, it is best to make the sketches of such a size that they will all go on one page or two facing pages of the sketch-book. The different views must be proportioned in size to the real sizes of the views of the models.

As the number of views and sections required for this sheet are given, decide for each model whether to make them of a size that will fit on one or two pages and thus decide approximately how large each view must be sketched and the position it will occupy in the sketch-book.

Always fix the positions of the Plan, Front Elevation, and Side Elevation first and draw them first. Later on, place the sections where most convenient. If the book is large enough

to place the sections so that they may be partly projected from one of the other views, it is well to arrange the positions of the sections accordingly. Generally, however, sections are placed in any convenient position after the main views are drawn.

It is generally best to draw the Plan first and project from that for the Front Elevation, but it must be decided upon in each case.

First draw the vertical center line for the Plan and Front Elevation. Then decide on the position of and draw horizontal center lines for the Plan and for the Front and Side Elevations, if the views are symmetrical about centers. Next draw a vertical center line for the Side Elevation. This establishes the positions of the central points of the views, if symmetrical. If the views are not symmetrical, decide on whatever center lines there are and draw them.

After deciding on the view to be sketched first, place the object or yourself in such a position that the face that is to be sketched of the model is normal to the line of sight. Draw the principal boundaries first, if the figure is symmetrical carefully making the corresponding boundaries equally distant from the center line. Draw all lines that appear to view first and later put in the hidden lines as broken lines.

After the first sketch is completed, draw next the one that seems most easily sketched and measured. Each corresponding point and line must be projected vertically or horizontally.

After the Plan, Front Elevation, and Side Elevation are sketched, place all the necessary dimension extension lines; then the arrows; then the dimension lines. Measure the model and place the dimensions in the spaces left. Place each dimension once only on the views, but choose a position for it that will show it clearly.

Mark where advisable on these views in heavy broken lines the positions of the planes where the sections are to be taken; mark the ends of these broken lines; A — — B , C — — D , etc.

After the three views are dimensioned, separate the model at the plane where a section is to be made and place the section normal to the line of sight. Either portion may be drawn as desired, but one is generally more important on account of the part of the model beyond the section plane. Note that part of the figure is removed entirely, and the part remaining only is drawn and the surfaces cut by the plane hatched.

Choose a position in the sketch-book, if there be space, so that as many points as possible may be projected from a view already drawn; if the size of the book and the other sketches do not allow of this, place the section wherever convenient and sketch the portion of the model remaining as if it were a new model, making the sketch as near the size of the corresponding view already drawn as possible. Draw the vertical center line and any other center lines first. As before, draw all lines that appear to the eye first and later the hidden lines. Note that all the lines beyond the section plane must be drawn. When completed, hatch rapidly, free-hand, either a portion or all of each surface cut by the plane, using the proper Standard Hatching. Hatch enough to clearly indicate what metal is used and how far the surfaces extend.

Mark the section sketched, Section on, to agree with the letters placed on one of the other views to show where the section is taken.

Make sketches of all the required sections.

It is seldom, except in very complicated drawings, that many dimensions are placed on a section. It is never done if the dimensions may be conveniently placed on the other views.

Over the sketches *for this sheet only* place the names of the views sketched and draw projection lines for every point or surface projected.

The projection lines are short dashes and extend for only a distance of $\frac{1}{4}$ " to $\frac{3}{8}$ " away from the point or surface projected and the same distance back from the position projected to.

When all the sketches of each model are completed, they are inspected before the drawing is begun.

GENERAL DIRECTIONS FOR DRAWING SHEET II.

Working line.....	15" × 21"
Border line.....	16" × 22"
Cutting line.....	18" × 24"

The legend is placed in the lower right-hand portion, as usual, and is as follows:

SHEET II. [Block lettering of simple type.]	
WORKING DRAWINGS. [Free-hand lettering, large.]	
Sketching; Views; Center lines; Projection; Sections; Hatching;	
Dimensions. [Free-hand lettering, small.]	
Sketched and drawn from brass models.	
Scale. [Free-hand lettering, small.]	
Name. [Autograph.]	Date. [Free-hand lettering, small.]
	Class. [Same.]

On this sheet only place the names of the views over them in free-hand lettering.

When sections are made, place above the views in free-hand lettering, Section on, using the same letters that mark the section plane in one of the views. This applies to all drawings.

On this sheet only draw projection lines for every point projected. The projection lines are not made of dots, but of very short dashes. They extend for only a distance of $\frac{1}{4}$ " to $\frac{3}{8}$ " away from the point projected and the same distance back from the position projected to.

Make the pencil-lines full and broken lines as required.

Do no hatching in pencil.

Draw no projection lines in pencil.

Place no dimensions in pencil.

Ink-work.—Carry out the established method of drawing all vertical lines first, full and broken, and then sweep down the board with the T square for all horizontal lines wherever found. All lines of the figures are standard.

When the shade lines are drawn, set the pen to proper width and never change the setting while drawing the shade lines.

Carry out the "Plan of Procedure" for inking.

Note carefully which lines are to be drawn broken and which surfaces hatched. The sketches should be so complete in these details that they may be followed absolutely in inking the drawing.

POSITIONS OF THE VIEWS ON THE SHEET.

A distance of $\frac{1}{2}$ " separates horizontally all views of the same model. The vertical distances between the views are given for each model.

Place the views of model I as follows:

Section on *CD*.

Plan.

Front Elevation. Side Elevation.

Section on *AB*. Section on *EF*.

The views to the left touch the left hand, top, and bottom working lines. The vertical distances between the views are equal.

In the space to the right of "Section on *CD*" is placed:

MODEL I.

GUIDE-BLOCK.

Place the views of model II as follows:

Plan

Side Elevation, half section on *CD*. Front Elevation.

Section on *AB*.

The vertical center line of the Plan is on the vertical center line of the sheet. The top of the Plan touches the top working edge. A vertical distance of $1\frac{1}{2}$ " separates the views in the same vertical line.

In the space below "Section on *AB*" and centrally under it is placed:

MODEL II.

BOTTOM JOURNAL BRASS.

Place the views of model III as follows:

Plan.

Front Elevation. Side Elevation, half section on *AB*.

Section on *CD*.

The "Side Elevation, half section" touches the right-hand working line.

A vertical distance of $\frac{3}{4}$ " separates the views in the same vertical line.

In the space to the right of the Plan is placed:

MODEL III.

CROSS-HEAD.

MODEL I.

Make a working drawing of the model of a guide-block.

Three views, Plan; Front Elevation; Side Elevation: and sections through the horizontal center line of the Plan; the vertical center line of the Front Elevation; and through a horizontal plane about $\frac{1}{2}$ " below the top of the Front Elevation.

The figure represents a block of cast iron which is bolted to the framing of an engine by bolts passing through holes (not shown) extending vertically through at the points marked for the centers of the curves of the corners. The rectangular depression acts as a guide to a rectangular rod moving back and forth longitudinally.

The moving rod is horizontal, therefore the Plan will be the view looking down on the model placed so that the depressed portion is seen from above.

Sketching.—Draw the vertical center line for the Plan and Front Elevation; horizontal center line for the Plan; horizontal center line for the Front and Side Elevations; and vertical center line for the Side Elevation.

Sketch the Plan. Project downwards from each vertical

line of the Plan a series of short dashes. These define the limits of the horizontal lines in the Front Elevation. Sketch the Front Elevation, using these projection lines for limits for the horizontal lines. The lengths of the vertical lines are decided by eye, noting that the boundaries of the view are equally distant from the horizontal center line. Note the

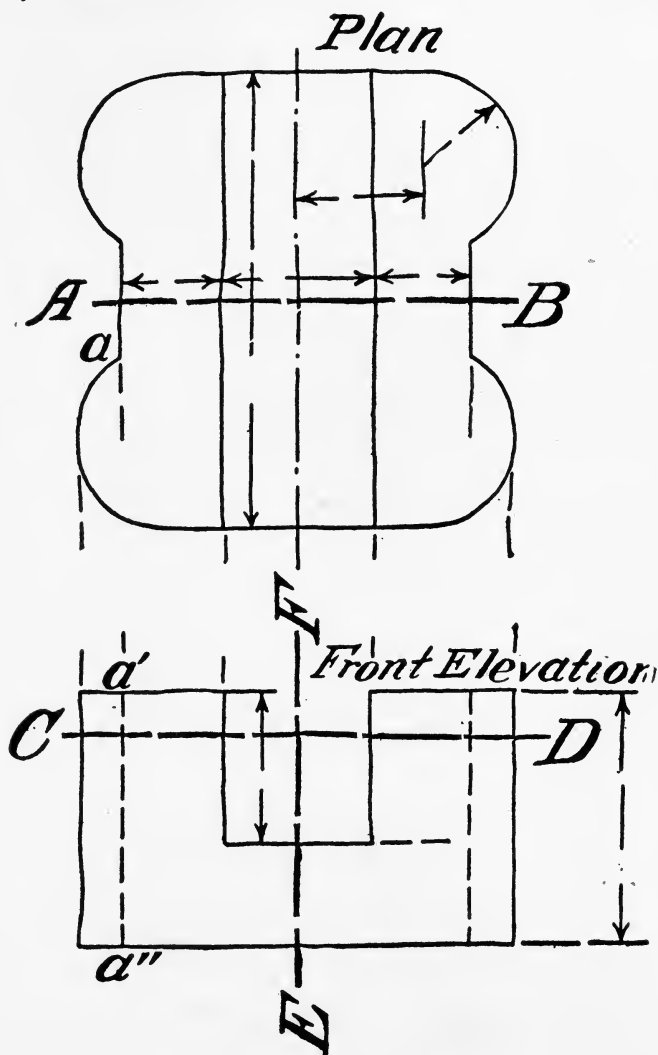

hidden lines showing that the depressions on the vertical side boundaries of the Plan appear as vertical lines in the Front Elevation. These are projected from the Plan, or the surface a projects to $a'a''$.

Draw projection lines horizontally from all horizontal lines of the Front Elevation. These define the limits of the vertical lines of the Side Elevation.

Sketch the Side Elevation, using the projection lines from the Front Elevation as limits for the vertical lines. The lengths of the horizontal lines are determined by eye, noting that the boundaries of the views are equally distant from the vertical center line, and that the horizontal lengths of this view should agree with the vertical heights of the corresponding lengths in the Plan. Note that the bottom of the depression in the Front Elevation becomes a hidden line in the Side Elevation, the line extending across the view.

Dimensions.—Place arrows, as shown, for measurements and draw dimension extension and dimension lines. The radii of the arcs in the Plan must be given and the positions of the centers. Note that no dimensions are required for the Side Elevation, dimensions in the vertical direction being given in the Front Elevation and in the horizontal direction in the Plan.

The sketches are now complete as far as the main views are concerned.

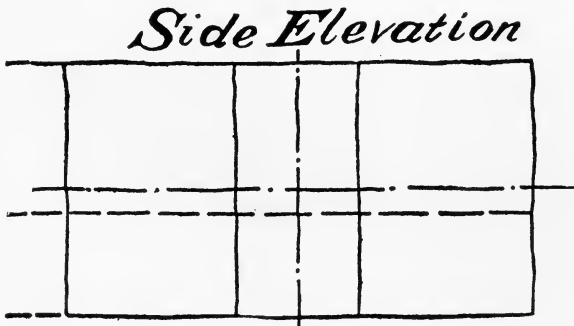

Sections.—Sections are required on planes *AB*, *CD*, and *EF*. Mark these planes on the proper views with heavy broken lines and letter them, as shown.

As stated, place these views in the sketch-books to best advantage.

Section on AB.—Divide the model on the line *AB* and sketch one portion, looking towards the surface cut by the

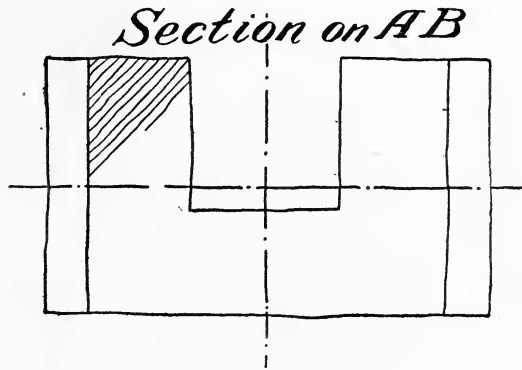

plane. The position with reference to the model is the same as when the Front Elevation was sketched.

Sketch the model as it appears.

Note that the outer boundary is the same as that of the Front Elevation. Part of the view could, then, be readily projected from the Front Elevation.

Hatch the surface cut by the plane. Use the Standard Hatching for cast iron. Mark the sketch, "Section on *AB*."

Section on CD.—Join the portions of the model and divide it on the plane *CD*. Sketch the larger portion, looking towards the surface cut by the plane. The position with reference to the model is the same as when the Plan was drawn.

Sketch the model as it appears. It is exactly the Plan repeated, except that the side portions are hatched where cut by the plane. Part of the sketch could be readily projected if placed at the top or side of the Plan.

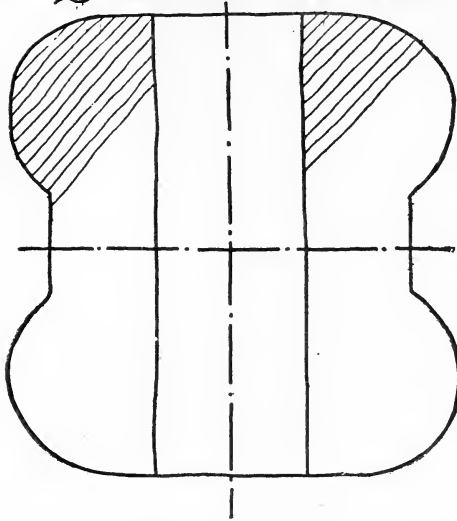
Section on CD

Section on EF.—Join the portions of the model and divide again on the plane *EF*.

Sketch one portion, looking towards the surface cut by the

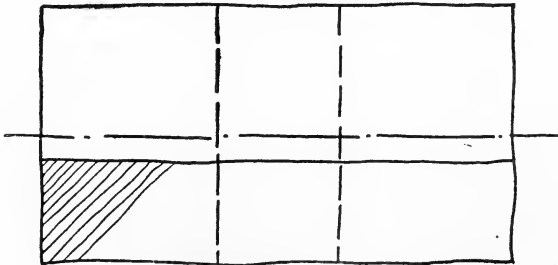
Section on EF

plane. The position is the same as when the Side Elevation was drawn.

Sketch the model as it appears and hatch the surface cut by the plane.

Note that the lines showing the intersections of the curved corners with the side boundaries in the middle of the height become vertical broken lines.

Part of the sketch could be projected from the Side Elevation and the rest from the Front Elevation.

Mark the sketch, "Section on *EF*."

Below the sketches and in the lower right-hand corner of the page, write:

Model I. Guide-block.

DIRECTIONS FOR DRAWING MODEL I.

Pencil-work.—After centering the paper and drawing the three dimension lines of the sheet, note that the views to the left of model I touch the left-hand and the top and bottom working lines.

From the sketches, decide on the position of the vertical center line of the left-hand views and draw it vertically the whole length of the working line.

From the sketches, decide on the total vertical distance remaining for spaces between the views and divide this distance equally for the spaces.

Draw the extreme horizontal bounding lines of the views and their horizontal center lines. Check to see that there is the same distance between the views.

Plan.—Draw the Plan first. Measure when possible from the center lines half the dimensions on either side. Make as few measurements as possible. Measure once and project up and down or sideways for corresponding points. Fix the center of one of the bolt-holes and project in directions at right angles. Fix the center of the diagonally opposite one and again project in directions at right angles. This establishes the four centers.

Front Elevation.—Project vertically downward from the Plan the lines of the vertical surfaces and draw them across the view of the Front Elevation. Only one measurement is made

—that for the depth of the depression in the model. Draw the hidden lines, projecting properly.

Carefully mark on the Plan and Front Elevation the positions of the planes where sections are to be taken.

Side Elevation.—Project horizontally from the Front Elevation, noting that the bottom of the depression in the model becomes a broken line. The horizontal distances need not be measured; they may be taken with the dividers from the vertical distances on the Plan.

Section on AB.—Project downward from the Front Elevation. The vertical dimensions may be taken from the Front Elevation by dividers.

Section on CD.—Project upwards from the Plan and make the view the same as the Plan, as in the sketch.

Section on EF.—Project horizontally from “Section on AB” and downwards from the Side Elevation. The view is entirely finished from these projections.

Note the part to be hatched.

Ink according to directions.

MODEL II.

Make a working drawing of a model of a Bottom Journal Brass. Metal: composition. Three views: Plan; Front Elevation; Side Elevation, half in section; and a section through the horizontal center line of the Plan. Scale, full size.

The model represents the lower half of a pair of “Brasses” in which a shaft revolves. It is made “flat sided” on the under side to prevent its turning in the framing in which it rests.

As it is the lower “brass,” the Plan is the view looking into the concave surface.

In this case, in order to fit better on the drawing-paper, the Side Elevation is taken to the left.

Sketching.—It will be found best to sketch the Front Elevation first, as one measurement only is required for the

diameters of the half circles shown on the Front Elevation, and the radii used will define both ends of the diameters, which may be projected vertically to the Plan. The basis of work in this view is, then, the top line of the brass.

Note also that the shape of the "flat-sided" portion of the bottom of the "brass" is drawn in the Front Elevation and the edges projected to the Plan.

There are many more hidden lines than in the views of model I; all must be carefully drawn.

Draw the vertical center line for the Plan and Front Elevation. Leave space above for the Plan and sketch the Front Elevation. Project upwards and sketch the Plan.

Note that the flanges of the brass are semi-circles except for short vertical portions, but their center is not coincident with the center of the circles of the bearing. The position of this center is dimensioned on the sketch.

Carefully mark the positions of the planes where sections are to be taken.

The Side Elevation is projected to the right or left of the Front Elevation. Draw a vertical center line for this view at the proper distance away from the Front Elevation. Sketch half of this view only—the portion to the right or left of the vertical center line.

*Side Elevation.
Half Section on CD*

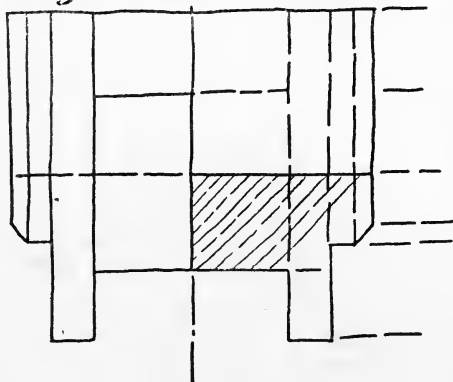

To finish the Side Elevation, half in section, separate the model on the plane CD and hold the half that is used in the same position as when sketching the Side Elevation. Sketch half of the half model, placing proper Standard Hatching on the surface cut by the plane.

Note that the outline is the same as for the rest of the view, the difference being in the lines seen and hidden.

The vertical line separating the elevation from the section

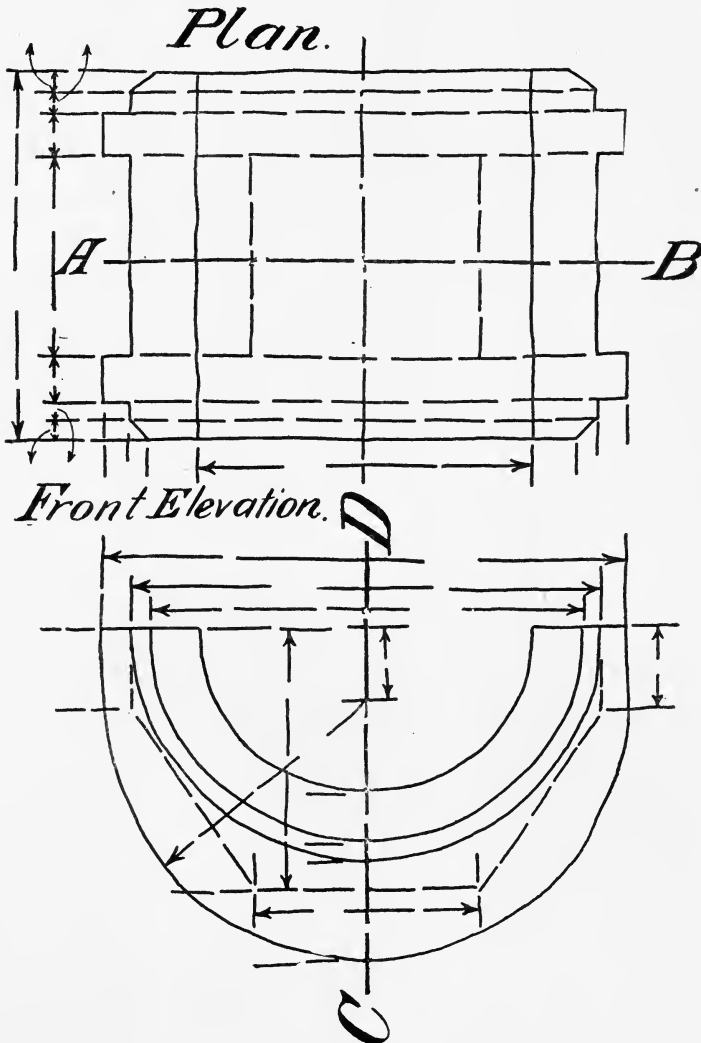

is a full line. The center line continues beyond above and below.

Mark the view, Side Elevation. "Half section on *CD*."

Dimensions.—Place arrows, lines, etc., for measurements, as shown. Note that all the measurements are on the Plan and Front Elevation. All arcs are dimensioned by diameters where possible.

Section on AB.—Unite the parts of the model and separate again on the plane *AB*. Place the half model so that the sur-

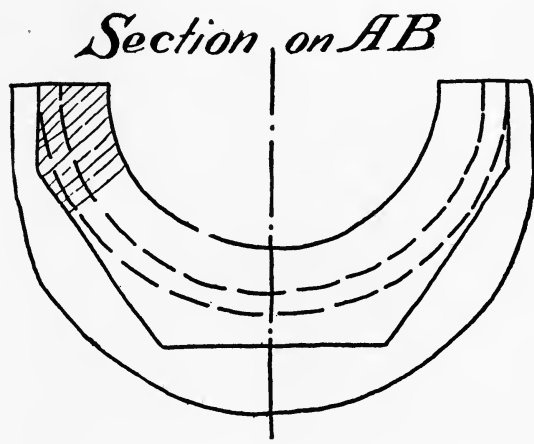

face cut by the plane is at right angles to the line of sight and sketch it.

Note that the model is now in the same position as when the Front Elevation was drawn, and that the boundary is the same. Hence this view might be largely projected from the Front Elevation.

Hatch the surface cut by the plane. Note carefully the hidden lines.

This sketch is placed so it may be projected, if possible.

Mark the sketch, "Section on *AB*."

Mark the sketches, "Model II. Bottom Journal Brass."

DIRECTIONS FOR DRAWING MODEL II.

Draw the vertical center line for the Plan, Front Elevation, and Section on *AB*, and the horizontal center line for the Plan.

Draw the horizontal boundary lines for the Plan and the top line of the Front Elevation. On this last line measure from the vertical center line, the radii of the arcs having this point for a center, and draw the arcs; the distances for the vertical parts of the "flat-sided" portions of the base and draw vertical lines; and the half extreme horizontal dimensions of the "brass" and draw vertical lines. Measure from the top line down the vertical center line for the position of the center of the lower bounding arc and with the proper radius draw the arc. This arc should join tangentially the vertical lines for the outer vertical boundaries. Measure downward from the same point for the position of the bottom of the "flat-sided" portion of the base of the "brass" and for the depth of the vertical flat portion on the two sides. Draw an indefinite line for the bottom flat and measure along it the half widths. This defines the bottom edges. Project across from the measurements taken for the ends of the vertical "flat-sided" portions. Connect the two sets of points last found on the two sides. The lines connecting the portions of the under part are thus determined.

Project upwards for the Plan. All the necessary measurements are made on the vertical center line, and the horizontal lines are drawn in the proper places from these measurements. In this case, all the lines cross the figure to their respective boundaries, which are projected upwards from the Front Elevation. The radii of the curves at the corners are not important, but the approximate radii found for the sketches are used. The radii are about $\frac{1}{8}$ ".

Draw the vertical center line for the Side Elevation, half in section.

Project to the left from the Front Elevation for the horizon-

tal lines. The horizontal dimensions are obtained from the vertical heights of the Plan. Measure always from the vertical center line. Note that the lines are the same for both parts of the view in the pencil-work, some full, some broken.

Section on AB.—As this is simply a copy of the Front Elevation with a variation in the lines made full or broken, project down from the Front Elevation and take the vertical measurements from it with the dividers. Lay these measurements off on the vertical center line as usual and project across.

Ink according to directions.

MODEL III.

Make a working drawing of a model of a cast-steel Cross-head for a small horizontal engine. Three views: Plan; Front Elevation; Side Elevation, half in section; and a section through the horizontal center line of the Plan. Scale, full size.

The figure represents the sliding-block of metal that connects the reciprocating or "back-and-forth" motion of the piston and piston-rod in the cylinder with the rotary motion of the crank and the shaft. As the engine is horizontal, the broad, flat portion is below and furnishes a large surface for support as the Cross-head moves back and forth on the guide. Therefore, the Plan view is the one where the flat portion is downwards.

The two cylindrical portions show where the forked "connecting-rod," that connects the cross-head and the crank-pin, grasps the cross-head. These are called journals. Note carefully the fillets where the journals join the main casting. The piston-rod is secured through the middle of the square-faced portion between the cylindrical pins. The hole for this is not shown. The projection on the side of the cross-head is for the purpose of securing there a horizontal pump-rod which moves with the cross-head. The center of the hole for the rod is indicated.

Sketching.—In this case the figure is generally symmetrical in the Plan view, but not so much so in the other views; so the

Plan

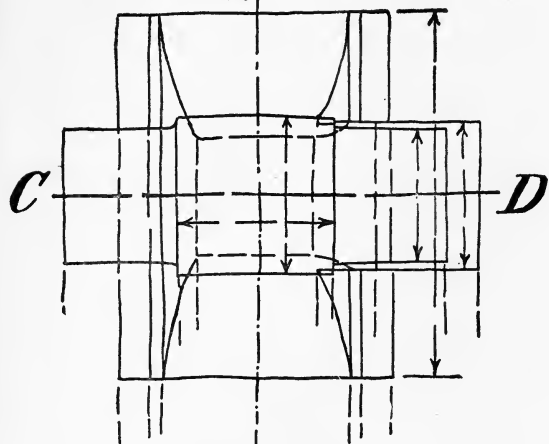

Front Elevation

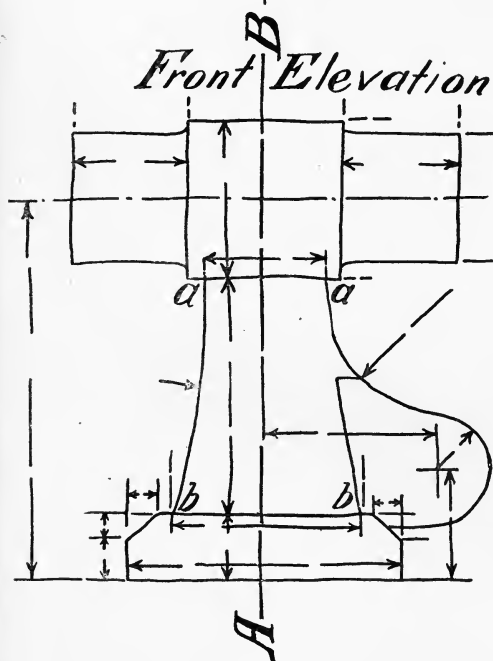

*Side Elevation.
Section on AB.*

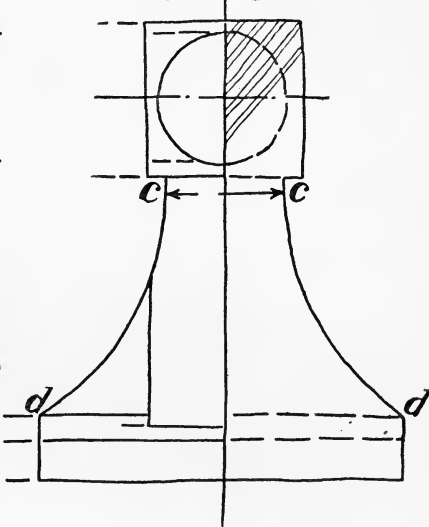

vertical center line for the Plan and Front Elevation is drawn and the horizontal center line for the Plan, but no horizontal center line for the Front Elevation and Side Elevation. The vertical center line for the Side Elevation may now be drawn, but it is better to wait until the Front Elevation is completed. Also, it may be readily seen that it is better to sketch the Front Elevation first, as it gives a better view and a better understanding of the model.

Leave room for the Plan above. Draw a center line for the two cylindrical portions, or journals, and extend this for the Side Elevation. Sketch the Front Elevation and project for the Side Elevation and Plan. Mark the views properly. Note carefully what lines of the Plan are concealed by the projecting portions above.

For the half-section on *AB* separate the model on that plane and place it normal to the line of sight and sketch it. The outline corresponds with that of the Side Elevation, as the part remaining beyond the section is a fac-simile of the part already sketched.

Note that the circle seen by looking at the end of the journal becomes a broken line in the section, as the nearer cylinder is removed and the farther one is hidden. Note also that the lines defining the outline of the portion for securing the pump-rod are now gone, as all this portion is removed.

Mark the sketch, "Side Elevation, half-section on *AB*."

Dimensions.—Place arrows, etc., as shown. The dimensions are again placed on the Plan and Front Elevation only. The approximate shapes of the arcs defining the outlines are determined after the drawing is made on the drawing-board, as they are simply clean arcs joining the determined points. The positions of the beginning and ending of these arcs must be accurately determined and noted on the sketches. The center of the pump-rod is the center of the arc around the metal at that place and is accurately shown, as well as the radius of the curve.

Section on CD.—Separate the model on the plane.

Place the sketch as advisable in the sketch-book, noting that portions of it may be projected from any of the other views.

Section on CD

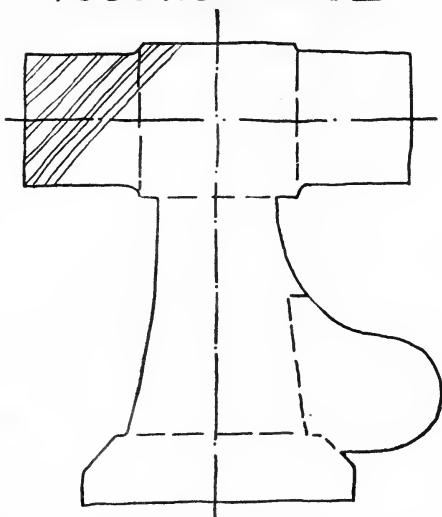

It is seen that the outline exactly corresponds with that of the Front Elevation and that the entire surface is hatched. Carefully draw all broken lines representing hidden lines beyond the section.

Mark the sketch, “Section on *CD*.”

Mark the set of sketches,

MODEL III.

CROSS-HEAD.

DIRECTIONS FOR DRAWING MODEL III.

Lay off along the top working line from the upper right-hand corner the distance of the half width of the Side Elevation and draw a vertical center line of indefinite length for the center line of the Side Elevation.

From the sketches, determine the distance between this

center line and the one through the Plan, Front Elevation, and Section on CD , allowing the proper distance between the views, and draw the new center line. Lay off downward on this center line from the top working line the half height of the Plan view and draw the horizontal center line for the Plan. Draw the boundaries of the base in the Plan.

From the lower boundary of the Plan lay off the proper amount for the vertical distance between the views and draw the top line of the Front Elevation. Next draw the center line for the journals and continue to draw the figure from the dimensions of the sketches, measuring always along center lines when possible.

After completing the Front Elevation, project for the horizontal lines of the Side Elevation and the vertical lines of the Plan. Either Plan or Side Elevation may be finished first; but it is easier to draw the Side Elevation using the dimensions given on the Plan sketch, and then take these dimensions with the dividers from the Side Elevation and use them in drawing the Plan.

The curved lines for the boundaries of the curved surfaces extending from the upper to the lower parts of the Front and Side Elevations are not necessarily arcs of circles, but are generally drawn as such, as the pattern-maker does not require accurate curves and will fashion them as required when he makes the pattern for casting. The arcs are drawn tangent at points a and c (see sketch) and of radii such that the lower portions of the arcs reach the points b and d . A third point on the curve is found by laying a straight edge (side of a triangle) from a to b and c to d . The edge is a chord and the distance to the arc at the middle point may be measured and the point thus plotted. These radii and the positions of the centers on the horizontal line through aa and cc are found by trial. The direction of curvature of these edges, as they appear in the *plan*, must be worked out as a problem in the intersection of two cylinders. The best solution is by passing planes parallel to H . The two

end points of this curve are already determined and a few intermediate ones are plotted and a curve drawn in with the irregular curves. The same portion of the curve is used in all four places, reversing the curve for two of them.

The curve in the Front Elevation defining the boundary of the surface extending down to the side extension for the pump-rod is drawn as an arc of a circle with its center on the line *aa* and a radius and position of center (found by trial) to cause the arc to join at a tangent the arc drawn with the center of the hole for the pump-rod as a center.

Half-section on AB.—This corresponds with portions of the Side Elevation, as shown in the sketch, and is drawn at the same time as the Side Elevation.

Section on CD.—This is a reproduction of the outlines of the Front Elevation, so that vertical projections define all horizontal lengths and the vertical distances are taken from the Front Elevation with the dividers.

Carefully draw the horizontal center line first.

Ink according to directions.

Legend.—In inking the legend, use as little time as possible. Do not make the block letters solid unless they are sufficiently narrow so that a stroke of the R. L. pen will suffice.

Make the border simple and make the right-hand and bottom lines heavier than the others. The widths of the parts of the border line should be in accord with the rest of the drawing.

When cleaned and inspected, cut the drawing from the board.

STANDARD DIMENSIONS OF BOLTS AND NUTS FOR THE UNITED STATES NAVY.

Diameter.		Area.	Threads.	Long Diameter.		Short D.	Depth.	
Col. 1.	Column 2.	Column 3.	Column 4.	Column 5.	Column 6.	Column 7.	Column 8.	Col. 9.
Nom.	Eff.	Eff.	No.	Hex.	Sq.	W.	Head.	Nut.
1/4	.185	.026	20	9/16	2 1/8	1 1/8	1 1/4	1 1/4
1/8	.240	.045	18	1 1/8	2 3/8	1 1/2	1 1/2	1 5/8
3/16	.294	.067	16	1 1/4	2 7/8	1 5/8	1 3/4	1 7/8
1/2	.345	.093	14	1 1/2	3 1/8	1 3/4	1 3/4	1 7/8
5/16	.400	.125	13	1 3/8	3 1/2	1 7/8	1 3/4	1 7/8
3/8	.454	.162	12	1 1/2	3 3/4	1 7/8	1 3/4	1 7/8
7/16	.507	.202	11	1 5/8	4 1/8	1 7/8	1 3/4	1 7/8
1/2	.620	.302	10	1 3/4	4 1/2	1 7/8	1 3/4	1 7/8
5/8	.731	.419	9	1 7/8	4 7/8	1 7/8	1 3/4	1 7/8
I	.837	.550	8	1 7/8	5 1/8	1 7/8	1 3/4	I
I 1/8	.940	.694	7	2 1/8	5 1/2	1 7/8	1 3/4	I 1/8
I 1/4	1.065	.891	7	2 1/4	5 7/8	2	I	I 1/4
I 3/8	1.160	1.057	6	2 3/8	6 1/8	2 1/8	I 3/8	I 3/8
I 1/2	1.284	1.294	6	2 1/2	6 1/2	2 1/8	I 1/2	I 1/2
I 5/8	1.389	1.515	5 1/2	2 3/4	6 3/4	2 1/8	I 5/8	I 5/8
I 7/8	1.491	1.746	5	3 1/8	7 1/8	2 1/8	I 7/8	I 7/8
I 7/8	1.616	2.051	5	3 1/4	7 1/2	2 1/8	I 7/8	I 7/8
2	1.712	2.302	4 1/2	3 3/8	7 3/4	3 1/8	2	2
2 1/4	1.962	3.023	4 1/2	4 1/8	8 1/8	3 1/2	2 1/4	2 1/4
2 1/2	2.176	3.719	4	4 1/4	8 1/2	3 3/8	2 1/2	2 1/2
2 3/4	2.426	4.622	4	4 3/8	8 3/4	4 1/4	2 3/4	2 3/4
3	2.676	5.624	4	5 1/8	9 1/8	4 3/8	3	3
3 1/4	2.926	6.724	4	5 3/8	9 3/4	5	2 3/4	3 1/4
3 1/2	3.176	7.922	4	6 1/8	10 1/8	5 3/8	2 1/2	3 1/2
3 3/4	3.426	9.219	4	6 3/8	10 3/4	5 3/8	2 3/4	3 3/4
4	3.676	10.613	4	7 1/8	11 1/8	6 1/8	3 1/8	4
4 1/4	3.926	12.106	4	7 3/8	11 3/4	6 3/8	3 1/4	4 1/4
4 1/2	4.176	13.697	4	7 1/2	12 1/8	6 3/4	3 1/2	4 1/2
4 3/4	4.426	15.386	4	8 1/8	12 3/4	7 1/4	3 3/8	4 3/4
5	4.676	17.173	4	8 1/2	13 1/8	7 3/4	3 3/4	5
5 1/4	4.926	19.058	4	9 1/8	13 3/4	8	4	5 1/4
5 1/2	5.176	21.042	4	9 1/2	14 1/8	8 3/8	4 1/8	5 1/2
5 3/4	5.426	23.123	4	10 1/8	14 3/4	8 3/4	4 3/8	5 3/4
6	5.676	25.303	4	10 1/2	15 1/8	9 1/8	4 3/4	6

STANDARD HATCHING.

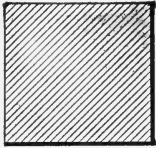

CAST IRON.



WRO'T IRON.

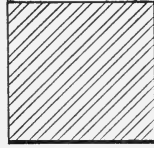

CAST STEEL.

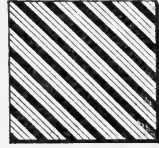

WRO'T STEEL.

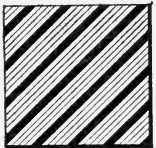

NICKEL STEEL.



NICKEL STEEL,
HARVEYED.

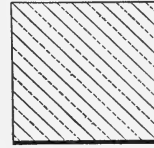

BRASS OR
COMPOSITION.

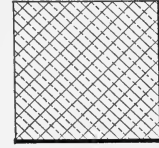

COPPER.

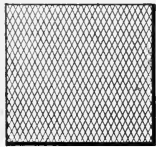

LEAD OR
BABBIT.

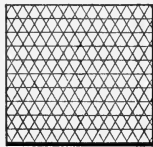

WIRES.

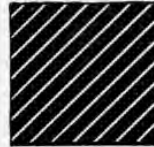

VULCANITE.

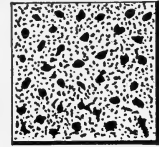

LEATHER
OR GUM.



GLASS.

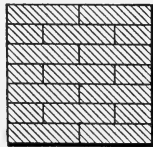

BRICK.

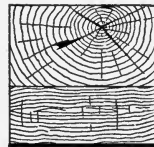

WOOD.

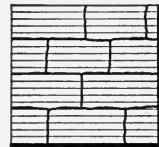

STONE.



EARTH.

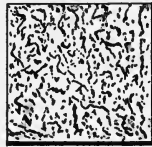

CEMENT.

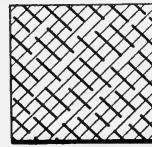

ALUMINUM.

LINES TO BE USED ON DRAWINGS.

STANDARD OF BUREAUS OF NAVY DEPARTMENT.

All lines on drawings must be black.

The standard lines, full or broken, used for visible or concealed outlines of object are made heavier than center, dimension, hatching, or construction lines.

Standard Lines.

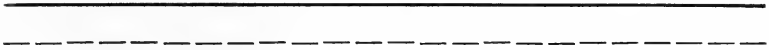

Center Lines.



Dimension Lines.



Hatching Lines.



Construction Lines.



Lines Indicating Path of Sections.



Dividing Lines of Partial Sections are made Free Hand.



Section lines and sections when not cutting through the centers of objects must be indicated by letters.

Shade lines are permitted in general arrangements only.

Shade Line.



INDEX.

- Arrows, 60
- Beam-compasses, 29
- Block letters, 78 to 82
- Blue-printing, 97
- Bolts and nuts, 70
 standard, 160
- Border line, 75
- Bow spacers, 22, 118
- Bow pencil, 22, 122, 123
- Bow pen, 22, 122, 123
- Breaks, 56
- Brushes, 29
- Calipers, 30
- Center Lines, 1, 41
- Centers, horn, 28
- Compass, beam, 22, 29
- Compasses, 10, 121, 122
 test, 20
 use, 20
- Cone, line shade, 88
- Curves, irregular, 25
- Cutting line, 75
- Cylinder, line shade, 85
- Dimension extension lines, 57
- Dimension lines, 57
- Dimensions, 61
 figures, 61
 figures, decimal, 61
 over all, 59
- Dividers, 24
 use, 24
- Dividing lines into parts, 119
- Drawing-board, 1
- Ellipses, 131
- Erasers, 27
 rubber, 27
 metal, 27
- Erasing shields, 28
- Extension-bar, 21
- File, 4
- Filllets, 47, 124
- First drawings, 106
- Flat tint, 92
- General arrangement, 34
- General remarks, 104
- General view, Sheet I, 106, 136
- Hatching, 51, 119
 standard, 161
- Horizontal lines, 1, 7
- Horn centers, 28
- Ink, black, China, 5
 bottled, 5
 red, 5
- Irregular curves, 24, 131
- Isinglass, 29
- Jam-nuts, 74
- Leads, 2
- Lead, sharpening, 3
- Lead-wire, 31
- Legend, 76, 135, 159
- Lettering, 76
 free-hand, 83, 84
- Letters, block, 28, 79 to 82
- Light, 2
- Lines, 2, 3, 40
 border, 75
 center, 41
 cutting, 75
 dimension, 58
 extension, 58
 shade, 43, 134
 bolt-heads, 49
 sections, shafts, etc., 49
 working, 75
- Line-shading, 84
 cone, 88
 cylinder, 85
 hollow, 88
 sphere, 90
- Marking dimensions, 5

- Models, 137
 Model I, 143
 II, 149
 III, 154
 Nuts, 70
 jam, 74
 Pads, for sharpening leads, 5
 Paper-cutters, 31
 Paper, stretching, 32
 Parallel lines, to draw, 8
 Pen, right-line, 13
 Pencils and pencilling, 2
 Artist, 3
 points, 3
 sharpening, 3
 compasses, 3
 Pencil, use of, 5
 Pencilling drawings, 102
 Plan of procedure in making a drawing, 101
 Plan of procedure in inking a drawing, 103
 Pricker, 5, 29
 Profile drawings, 34
 Projections, 38
 Protractors, 26, 127
 Right-line pen, 13
 clean, use, etc., 13-18
 Rule, foot, 30
 Scales, 10 to 12, 76, 83
 Screw-threads, 62
 Secure paper on board, 2
 tracing-cloth on board, 2
 Sections, 50, 118, 146, 147, 150, 151, 152, 155, 157
 Shade lines, 43 to 49, 134
 Sheet I, 107
 II, 137
 Shields, erasing, 28
 Sketches, 98, 138, 143, 149, 154
 Spacers, bow, 22
 Sphere, line shade, 90
 Splines, 31
 Standard bolts and nuts, 160
 hatching, 161
 Stippling, 96
 Tails, 74
 Thumb-tacks, 2
 Threads, double, etc., 68
 screw, 62
 square, 67
 Tint, flat, 92
 Tinting, 91 to 95
 cone, 94, 95
 cylinder, 94
 sphere, 95
 Tracings, 35, 96
 Trams, 29
 Triangles, 8
 test, 9
 45°, 112, 113, 115, 116, 118
 60°, 114, 116, 117
 Triangular scale, 10
 use, 13
 guard, 13
 Truing up, 1
 T square, 6
 Vertical lines, 1, 7
 Views, 36
 Weights, 7
 Wire, lead, 31
 Working drawings, 35, 137
 business method, 35
 Working-edge, 1
 Working line, 75

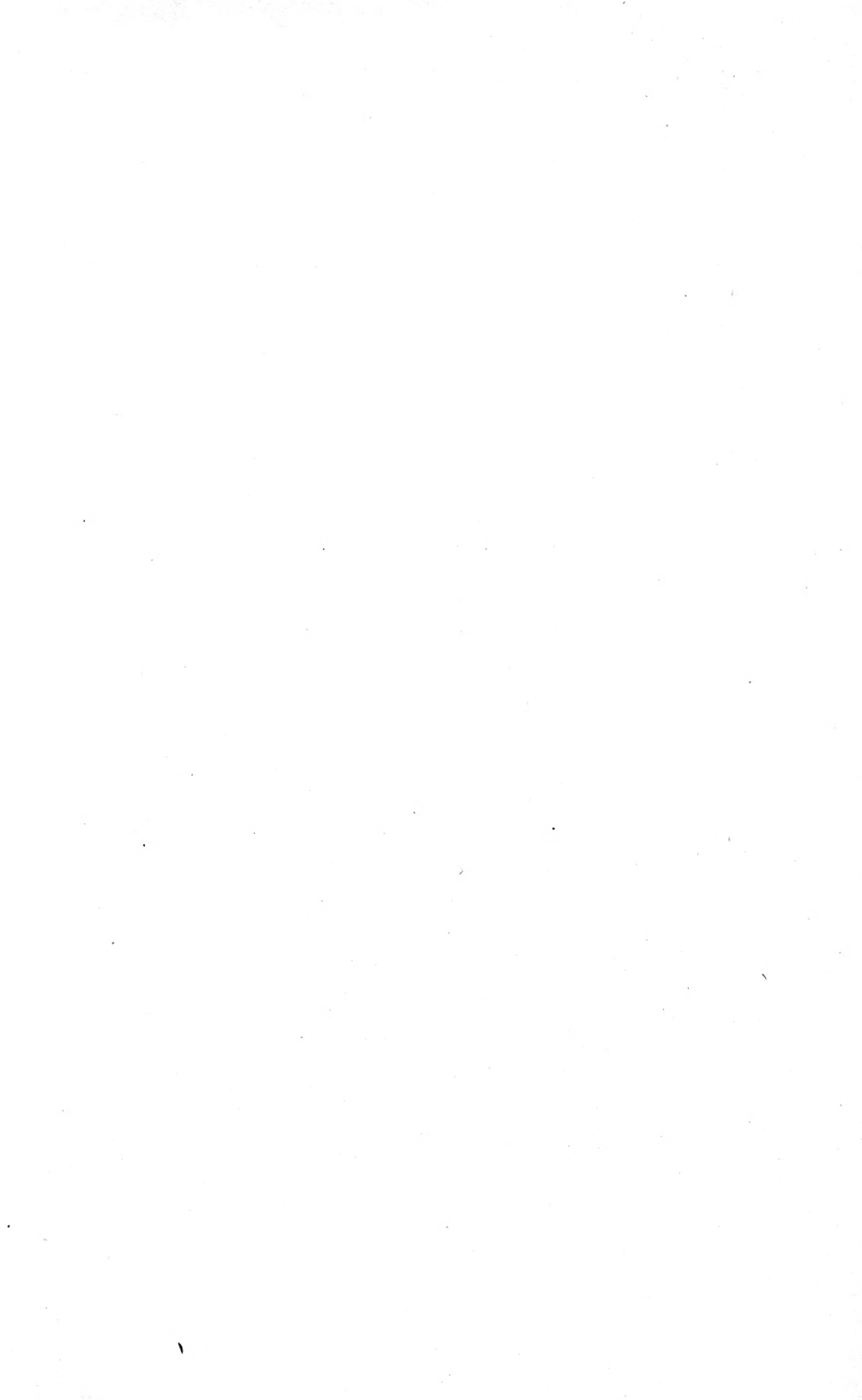

3.00 m

LIBRARY OF CONGRESS
THIS BOOK IS DUE ON THE LAST DATE
STAMPED BELOW

AN INITIAL FINE OF 25 CENTS
WILL BE ASSESSED FOR FAILURE TO RETURN
THIS BOOK ON THE DATE DUE. THE PENALTY
WILL INCREASE TO 50 CENTS ON THE FOURTH
DAY AND TO \$1.00 ON THE SEVENTH DAY
OVERDUE.

SEP 9 '47

OCT 24 1933

MAY 8 1945

SEP 23 1947

SEP 13 1947

4 NOV 45

NOV 15 1997

5022547903



U. C. BERKELEY LIBRARIES

241310

13.07 11

