



Marine Biological Laboratory Library  
Woods Hole, Massachusetts



Gift of F. R. Lillie estate - 1977

MBL/WHOI



0 0301 0010745 4





**THE  
MECHANISTIC CONCEPTION  
OF LIFE**

THE UNIVERSITY OF CHICAGO PRESS  
CHICAGO, ILLINOIS

Agents

THE BAKER & TAYLOR COMPANY  
NEW YORK

---

THE CAMBRIDGE UNIVERSITY PRESS  
LONDON AND EDINBURGH

# THE MECHANISTIC CONCEPTION OF LIFE

## BIOLOGICAL ESSAYS

BY

JACQUES LOEB, M.D., PH.D., SC.D.

MEMBER OF THE ROCKEFELLER INSTITUTE  
FOR MEDICAL RESEARCH



THE UNIVERSITY OF CHICAGO PRESS  
CHICAGO, ILLINOIS

COPYRIGHT 1912 BY  
THE UNIVERSITY OF CHICAGO

---

All rights reserved

---

Published July 1912

Composed and Printed By  
The University of Chicago Press  
Chicago, Illinois, U.S.A.

## PREFACE

The essays contained in this volume were written on different occasions mostly in response to requests for a popular presentation of the results of the author's investigations. The title of the volume characterizes their general tendency as an attempt to analyze life from a purely physico-chemical viewpoint. Since they deal to a large extent with the personal work of the author, repetition was unavoidable, but in view of the technical difficulties presented by some of the topics this may serve to facilitate the understanding of the subject.

The author wishes to thank the editors and publishers who gave their consent to the reprinting of these essays: Professor J. McKeen Cattell, of Columbia University, Professor Albert Charles Seward, of the University of Cambridge, England, Ginn & Co., of Boston, G. P. Putnam's Sons, of New York and London, and the J. B. Lippincott Company, Philadelphia.

THE ROCKEFELLER INSTITUTE  
FOR MEDICAL RESEARCH  
April 4, 1912



## TABLE OF CONTENTS

	PAGE
I. The Mechanistic Conception of Life - - - -	3
II. The Significance of Tropisms for Psychology - -	35
III. Some Fundamental Facts and Conceptions concerning the Comparative Physiology of the Central Nervous System - - - - -	65
IV. Pattern Adaptation of Fishes and the Mechanism of Vision - - - - -	79
V. On Some Facts and Principles of Physiological Morphology - - - - -	85
VI. On the Nature of the Process of Fertilization - -	113
VII. On the Nature of Formative Stimulation (Artificial Parthenogenesis) - - - - -	127
VIII. The Prevention of the Death of the Egg through the Act of Fertilization - - - - -	155
IX. The Rôle of Salts in the Preservation of Life - - -	169
X. Experimental Study of the Influence of Environment on Animals - - - - -	195
INDEX - - - - -	229





## I. THE MECHANISTIC CONCEPTION OF LIFE



# I

## THE MECHANISTIC CONCEPTION OF LIFE<sup>1</sup>

### I. INTRODUCTORY

It is the object of this paper to discuss the question whether our present knowledge gives us any hope that ultimately life, i.e., the sum of all life phenomena, can be unequivocally explained in physico-chemical terms. If on the basis of a serious survey this question can be answered in the affirmative our social and ethical life will have to be put on a scientific basis and our rules of conduct must be brought into harmony with the results of scientific biology.

It is seemingly often taken for granted by laymen that "truth" in biology, or science in general, is of the same order as "truth" in certain of the mental sciences; that is to say, that everything rests on argument or rhetoric and that what is regarded as true today may be expected with some probability to be considered untrue tomorrow. It happens in science, especially in the descriptive sciences like paleontology or zoology, that hypotheses are forwarded, discussed, and then abandoned. It should, however, be remembered that modern biology is fundamentally an experimental and not a descriptive science; and that its results are not rhetorical, but always assume one of two forms: it is either possible to control a life phenomenon to such an extent that we can produce it at desire (as, e.g., the contraction of an excised muscle); or we succeed in finding the numerical relation between the conditions of the experiment and the biological result (e.g.,

<sup>1</sup> Address delivered at the First International Congress of Monists at Hamburg, September 10, 1911; reprinted from *Popular Science Monthly*, January, 1912, by courtesy of Professor J. McKeen Cattell.

Mendel's law of heredity). Biology as far as it is based on these two principles cannot retrogress, but must advance.

## II. THE BEGINNING OF SCIENTIFIC BIOLOGY

Scientific biology, defined in this sense, begins with the attempt made by Lavoisier and Laplace (1780) to show that the quantity of heat which is formed in the body of a warm-blooded animal is equal to that formed in a candle, provided that the quantities of carbon dioxide formed in both cases are identical. This was the first attempt to reduce a life phenomenon, namely, the formation of animal heat, completely to physico-chemical terms. What these two investigators began with primitive means has been completed by more recent investigators—Pettenkofer and Voit, Rubner, Zuntz and Atwater. The oxidation of a food-stuff always furnishes the same amount of heat, no matter whether it takes place in the living body or outside.

These investigations left a gap. The substances which undergo oxidations in the animal body—starch, fat, and proteins—are substances which at ordinary temperature are not easily oxidized. They require the temperature of the flame in order to undergo rapid oxidation through the oxygen of the air. This discrepancy between the oxidations in the living body and those in the laboratory manifests itself also in other chemical processes, e.g., digestion or hydrolytic reactions, which were at first found to occur outside the living body rapidly only under conditions incompatible with life. This discrepancy was done away with by the physical chemists, who demonstrated that the same acceleration of chemical reactions which is brought about by a high temperature can also be accomplished at a low temperature with the aid of certain specific substances, the so-called catalyzers. This progress is connected pre-eminently with the names of Berzelius and Wilhelm Ostwald. The specific substances

which accelerate the oxidations at body temperature sufficiently to allow the maintenance of life are the so-called ferments of oxidation.

The work of Lavoisier and Laplace not only marks the beginning of scientific biology, it also touches the core of the problem of life; for it seems that oxidations form a part, if not the basis, of all life phenomena in higher organisms.

### III. THE "RIDDLE OF LIFE"

By the "riddle of life" not everybody will understand the same thing. We all, however, desire to know how life originates and what death is, since our ethics must be influenced to a large extent through the answer to this question. We are not yet able to give an answer to the question as to how life originated on the earth. We know that every living being is able to transform food-stuffs into living matter; and we also know that not only the compounds which are formed in the animal body can be produced artificially, but that chemical reactions which take place in living organisms can also be repeated at the same rate and temperature in the laboratory. The gap in our knowledge which we feel most keenly is the fact that the chemical character of the catalyzers (the enzymes or ferments) is still unknown. Nothing indicates, however, at present that the artificial production of living matter is beyond the possibilities of science.

This view does not stand in opposition to the idea of Arrhenius that germs of sufficiently small dimensions are driven by radiation-pressure through space; and that these germs, if they fall upon new cosmic bodies possessing water, salts, and oxygen, and the proper temperature, give rise to a new evolution of organisms. Biology will certainly retain this idea, but I believe that we must also follow out the other problem: namely, we must either succeed in producing

living matter artificially, or we must find the reasons why this is impossible.

#### IV. THE ACTIVATION OF THE EGG

Although we are not yet able to state how life originated in general, another, more modest problem, has been solved, that is, how the egg is caused by the sperm to develop into a new individual. Every animal originates from an egg and in the majority of animals a new individual can only then develop if a male sex-cell, a spermatozoon, enters into the egg. The question as to how a spermatozoon can cause an egg to develop into a new individual was twelve years ago still shrouded in that mystery which today surrounds the origin of life in general. But today we are able to state that the problem of the activation of the egg is for the most part reduced to physico-chemical terms. The egg is in the unfertilized condition a single cell with only one nucleus. If no spermatozoon enters into it, it perishes after a comparatively short time, in some animals in a few hours, in others in a few days or weeks. If, however, a spermatozoon enters into the egg, the latter begins to develop, i.e., the nucleus begins to divide into two nuclei and the egg which heretofore consisted of one cell is divided into two cells. Subsequently each nucleus and each cell divides again into two, and so on. These cells have, in many eggs, the tendency to remain at the surface of the egg or to creep to the surface, and later such an egg forms a hollow sphere whose shell consists of a large number of cells. On the outer surface of this hollow sphere cilia are formed and the egg is now transformed into a free-swimming larva. Then an intestine develops through the growing in of cells in one region of the blastula and gradually the other organs, skeleton, vascular system, etc., originate. Embryologists had noticed that occasionally the unfertilized eggs of certain animals, e.g., sea-urchins,

worms, or even birds, show a tendency to a nuclear or even a cell division; and R. Hertwig, Mead, and Morgan had succeeded in inducing one or more cell divisions artificially in such eggs. But the cell divisions in these cases never led to the development of a larva, but at the best to the formation of an abnormal mass of cells which soon perished.

I succeeded twelve years ago in causing the unfertilized eggs of the sea-urchin to develop into swimming larvae by treating them with sea-water, the concentration of which was

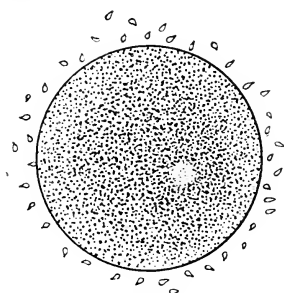

FIG. 1

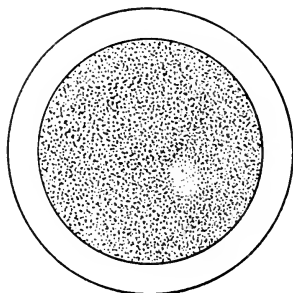

FIG. 2

FIG. 1.—Unfertilized egg of the sea-urchin surrounded by spermatozoa. Only the heads of the spermatozoa are drawn, since at the magnification used the tails were not visible.

FIG. 2.—The same egg immediately after the entrance of the spermatozoon. The egg is surrounded by a larger circle, the fertilization membrane, which is formed through the action of the spermatozoon. This formation of a fertilization membrane can be induced by a purely chemical treatment of the egg.

raised through the addition of a small but definite quantity of a salt or sugar. The eggs were put for two hours into a solution the osmotic pressure of which had been raised to a certain height. When the eggs were put back into normal sea-water they developed into larvae and a part of these larvae formed an intestine and a skeleton. The same result was obtained in the eggs of other animals, star-fish, worms, and mollusks. These experiments proved the possibility of substituting physico-chemical agencies for the action of the living spermatozoon, but did not yet explain how the spermatozoon causes the development of the egg, since in

these experiments the action of the spermatozoon upon the egg was very incompletely imitated. When a spermatozoon enters into the egg it causes primarily a change in the surface of the egg which results in the formation of the so-called membrane of fertilization. This phenomenon of membrane formation which had always been considered as a phenomenon of minor importance did not occur in my original method of treating the egg with hypertonic sea-water. Six years ago while experimenting on the Californian sea-urchin, *Strongylocentrotus purpuratus*, I succeeded in finding a method of causing the unfertilized egg to form a membrane without injuring the egg. This method consists in treating the eggs for from one to two minutes with sea-water to which a definite amount of butyric acid (or some other monobasic fatty acid) has been added. If after that time the eggs are brought back into normal sea-water, all form a fertilization membrane in exactly the same way as if a spermatozoon had entered. This membrane formation or rather the modification of the surface of the egg which underlies the membrane formation starts the development. It does not allow it, however, to proceed very far at room temperature. In order to allow the development to go farther it is necessary to submit the eggs after the butyric acid treatment to a second operation. Here we have a choice between two methods. We can either put the eggs for about one half-hour into a hypertonic solution (which contains free oxygen); or we can put them for about three hours into sea-water deprived of oxygen. If the eggs are then returned to normal sea-water containing oxygen they all develop; and in a large number the development is as normal as if a spermatozoon had entered.

The essential feature is therefore the fact that the development is caused by two different treatments of the egg; and that of these the treatment resulting in the formation of the membrane is the more important one. This is proved



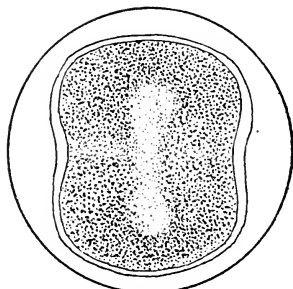

FIG. 3

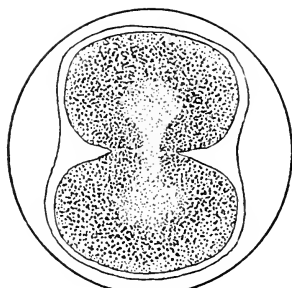

FIG. 4

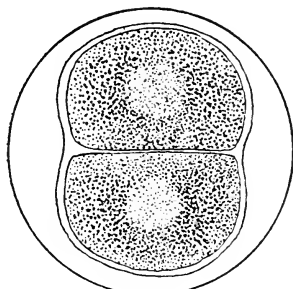

FIG. 5

FIGS. 3, 4, and 5.—Segmentation of the sea-urchin egg, resulting in the formation of two cells (FIG. 5). The changes from Fig. 3 to Fig. 5 occur in about one minute or less time. This segmentation occurs after fertilization or after the chemical treatment of the egg described in the text.

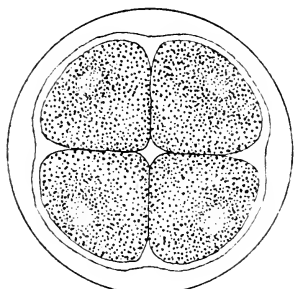

FIG. 6

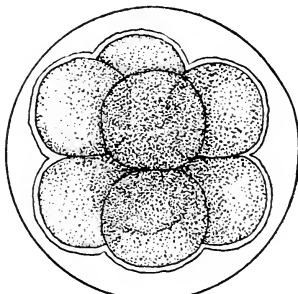

FIG. 7

FIGS. 6 and 7.—The sea-urchin egg divided into four and eight cells respectively.

by the fact that in certain forms, as for instance the star-fish, the causation of the artificial membrane formation may suffice for the development of normal larvae; although here, too, the second treatment increases not only the number of larvae, but also improves the appearance of the larvae, as R. Lillie found.

The question now arises, how the membrane formation can start the development of the egg. An analysis of the

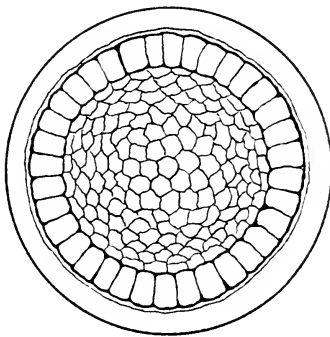

FIG. 8

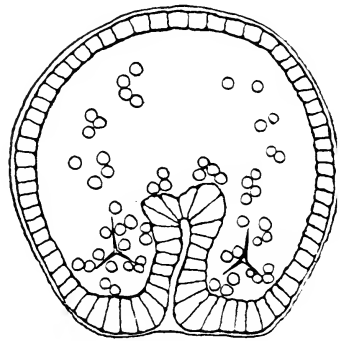

FIG. 9

FIG. 8.—Blastula. First larval stage of the sea-urchin egg. At the surface of the cells cilia are formed and the larva begins to swim and reaches the surface of the water.

FIG. 9.—Gastrula stage. The intestine begins to form and the first indication of the skeleton appears in the form of fine crystals.

process and of the nature of the agencies which cause it yielded the result that the unfertilized egg possesses a superficial cortical layer, which must be destroyed before the egg can develop. It is immaterial by what means this superficial cortical layer is destroyed. All agencies which cause a definite type of cell destruction—the so-called cytolysis—cause also the egg to develop, as long as their action is limited to the surface layer of the cell. The butyric acid treatment of the egg mentioned above only serves to induce the destruction of this cortical layer. In the eggs of some animals this cortical layer can be destroyed mechanically by shaking the

egg, as A. P. Mathews found in the case of star-fish eggs and I in the case of the eggs of certain worms. In the case of the eggs of the frog it suffices to pierce the cortical layer with a needle, as Bataillon found in his beautiful experiments a year ago.<sup>1</sup> The mechanism by which development is caused is apparently the same in all these cases, namely, the destruction of the cortical layer of the eggs. This can be caused generally by certain chemical means which play a rôle also in bacteriology; but it can also be caused in special cases by mechanical means, such as agitation or piercing of the cortical layer. It may be mentioned parenthetically that foreign blood sera have also a cytolytic effect, and I succeeded

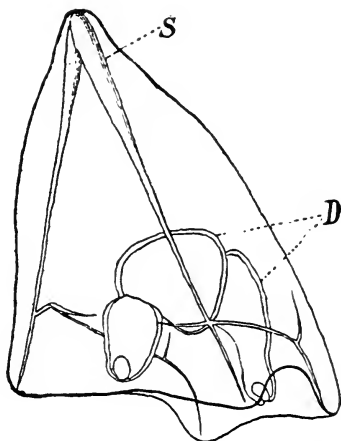

FIG. 10.—Pluteus stage of *Strongylocentrotus purpuratus*. S skeleton; D intestine.

in causing membrane formation and in consequence the development of the sea-urchin egg by treating it with the blood of various animals, e.g., of cattle, or the rabbit.

Recently Shearer has succeeded in Plymouth in causing a number of parthenogenetic plutei produced by my method to develop beyond the stage of metamorphosis, and Delage has reported that he raised two larvae of the sea-urchin produced by artificial parthenogenesis to the stage of sexual maturity. We may, therefore, state that the complete imitation of the developmental effect of the spermatozoon by certain physico-chemical agencies has been accomplished.

I succeeded in showing that the spermatozoon causes the development of the sea-urchin egg in a way similar to that

<sup>1</sup> This method does not work with the eggs of fish and is apparently as limited in its applicability as the causation of development by mechanical agitation.

in my method of artificial parthenogenesis; namely, by carrying two substances into the egg, one of which acts like the butyric acid and induces the membrane formation, while the other acts like the treatment with a hypertonic solution and enables the full development of the larvae. In order to prove this for the sea-urchin egg foreign sperm, e.g., that of the star-fish, must be used. The sperm of the sea-urchin penetrates so rapidly into the sea-urchin egg that almost always both substances get into the egg. If, however, star-fish sperm is used for the fertilization of the sea-urchin egg, in a large number of cases, membrane formation occurs before the spermatozoon has found time to penetrate entirely into the egg. In consequence of the membrane formation the spermatozoon is thrown out. Such eggs behave as if only the membrane formation had been caused by some artificial agency, e.g., butyric acid. They begin to develop, but soon show signs of disintegration. If treated with a hypertonic solution they develop into larvae. In touching the egg contents the spermatozoon had a chance to give off a substance which liquefied the cortical layer and thereby caused the membrane formation by which the further entrance of the spermatozoon into the egg was prevented. If, however, the star-fish sperm enters completely into the egg before the membrane formation begins, the spermatozoon carries also the second substance into the egg, the action of which corresponds to the treatment of the egg with the hypertonic solution. In this case the egg can undergo complete development into a larva.

F. Lillie has recently confirmed the same fact in the egg of a worm, *Nereis*. He mixed the sperm and eggs of *Nereis* and centrifuged the mass. In many cases the spermatozoa which had begun to penetrate into the egg were thrown off again. The consequence was that only a membrane formation resulted without the spermatozoon penetrating into the

egg. This membrane formation led only to a beginning but not to a complete development. We may, therefore, conclude that the spermatozoon causes the development of the egg in a way similar to that which takes place in the case of artificial parthenogenesis. It carries first a substance into the egg which destroys the cortical layer of the egg in the same way as does butyric acid; and secondly a substance which corresponds in its effect to the influence of the hypertonic solution in the sea-urchin egg after the membrane formation.

The question arises as to how the destruction of the cortical layer can cause the beginning of the development of the egg. This question leads us to the process of oxidation. Years ago I had found that the fertilized sea-urchin egg can only develop in the presence of free oxygen; if the oxygen is completely withdrawn the development stops, but begins again promptly as soon as oxygen is again admitted. From this and similar experiments I concluded that the spermatozoon causes the development by accelerating the oxidations in the egg. This conclusion was confirmed by experiments by O. Warburg and by Wasteneys and myself in which it was found that through the process of fertilization the velocity of oxidations in the egg is increased to four or six times its original value. Warburg was able to show that the mere causation of the membrane formation by the butyric acid treatment has the same accelerating effect upon the oxidations as fertilization.

What remains unknown at present is the way in which the destruction of the cortical layer of the egg accelerates the oxidations. It is possible that the cortical layer acts like a solid crust and thus prevents the oxygen from reaching the surface of the egg or from penetrating into the latter sufficiently rapidly. The solution of these problems must be reserved for further investigation.

We therefore see that the process of the activation of the egg by the spermatozoon, which twelve years ago was shrouded in complete darkness, is today practically completely reduced to a physico-chemical explanation. Considering the youth of experimental biology we have a right to hope that what has been accomplished in this problem will occur in rapid succession in those problems which today still appear as riddles.

#### V. NATURE OF LIFE AND DEATH

The nature of life and of death are questions which occupy the interest of the layman to a greater extent than possibly any other purely theoretical problem; and we can well understand that humanity did not wait for experimental biology to furnish an answer. The answer assumed the anthropomorphic form characteristic of all explanations of nature in the prescientific period. Life was assumed to begin with the entrance of a "life principle" into the body; that individual life begins with the egg was of course unknown to primitive or prescientific man. Death was assumed to be due to the departure of this "life principle" from the body.

Scientifically, however, individual life begins (in the case of the sea-urchin and possibly in general) with the acceleration of the rate of oxidation in the egg, and this acceleration begins after the destruction of its cortical layer. Life of warm-blooded animals—man included—ends with the cessation of oxidation in the body. As soon as oxidations have ceased for some time, the surface films of the cells, if they contain enough water and if the temperature is sufficiently high, become permeable for bacteria, and the body is destroyed by micro-organisms. The problem of the beginning and end of individual life is physico-chemically clear. It is, therefore, unwarranted to continue the statement that in addition to the acceleration of oxidations the beginning of

individual life is determined by the entrance of a metaphysical "life principle" into the egg; and that death is determined, aside from the cessation of oxidations, by the departure of this "principle" from the body. In the case of the evaporation of water we are satisfied with the explanation given by the kinetic theory of gases and do not demand that—to repeat a well-known jest of Huxley—the disappearance of the "aquosity" be also taken into consideration.

#### VI. HEREDITY

It may be stated that the egg is the essential bearer of heredity. We can cause an egg to develop into a larva without sperm, but we cannot cause a spermatozoon to develop into a larva without an egg. The spermatozoon can influence the form of the offspring only when the two forms are rather closely related. If the egg of a sea-urchin is fertilized with the sperm from a different species of sea-urchin, the larval form has distinct paternal characters. If, however, the eggs of a sea-urchin are fertilized with the sperm of a more remote species, e.g., a star-fish, the result is a sea-urchin larva which possesses no paternal characters, as I found and as Godlewski, Kupelwieser, Hagedoorn, and Baltzer were able to confirm. This fact has some bearing upon the further investigation of heredity, inasmuch as it shows that the egg is the main instrument of heredity, while apparently the spermatozoon is restricted in the transmission of characters to the offspring. If the difference between spermatozoon and egg exceeds a certain limit the hereditary effects of the spermatozoon cease and it acts merely as an activator to the egg.

As far as the transmission of paternal characters is concerned, we can say today that the view of those authors was correct who, with Boveri, localized this transmission not only in the cell nucleus, but in a special constituent of the nucleus,

the chromosomes. The proof for this was given by facts found along the lines of Mendelian investigations. The essential law of Mendel, the law of segregation, can in its simplest form be expressed in the following way. If we cross two forms which differ in only one character every hybrid resulting from this union forms two kinds of sex-cells in equal numbers; two kinds of eggs if it is a female, two kinds of spermatozoa if it is a male. The one kind corresponds to the pure paternal, the other to the pure maternal type. The investigation of the structure and behavior of the nucleus showed that the possibility for such a segregation of the sex-cells in a hybrid can easily be recognized during a given stage in the formation of the sex-cells, if the assumption is made that the chromosomes are the bearers of the paternal characters. The proof for the correctness of this view was furnished through the investigation of the heredity of those qualities which occur mainly in one sex; e.g., color blindness which occurs pre-eminently in the male members of a family.

Nine years ago McClung published a paper which solved the problem of sex determination, at least in its essential feature. Each animal has a definite number of chromosomes in its cell nucleus. Henking had found that in a certain form of insects (*Pyrrhocoris*) two kinds of spermatozoa exist which differ in the fact that the one possesses a nucleolus while the other does not. Montgomery afterward showed that Henking's nucleolus was an accessory chromosome. McClung first expressed the idea that this accessory chromosome was connected with the determination of sex. Considering the importance of this idea we may render it in his own words:

A most significant fact, and one upon which almost all investigators are united in opinion, is that the element is apportioned to but one-half of the spermatozoa. Assuming it to be true that the chromatin is the important part of the cell in the matter of heredity,



then it follows that we have two kinds of spermatozoa that differ from each other in a vital matter. We expect, therefore, to find in the offspring two sorts of individuals in approximately equal numbers, under normal conditions, that exhibit marked differences in structure. A careful consideration will suggest that nothing but sexual characters thus divides the members of a species into two well-defined groups, and we are logically forced to the conclusion that the peculiar chromosome has some bearing upon the arrangement.

I must here also point out a fact that does not seem to have the recognition it deserves; viz., that if there is a cross-division of the chromosomes in the maturation mitoses, there must be two kinds of spermatozoa regardless of the presence of the accessory chromosome. It is thus possible that even in the absence of any specialized element a preponderant maleness would attach to one-half of the spermatozoa, due to the "qualitative division of the tetrads."

The researches of the following years, especially the brilliant work of E. B. Wilson, Miss Stevens, T. H. Morgan, and others, have amply confirmed the correctness of this ingenious idea and cleared up the problem of sex determination in its main features.

According to McClung each animal forms two kinds of spermatozoa in equal numbers, which differ by one chromosome. One kind of spermatozoa produces male animals, the other female animals. The eggs are all equal in these animals. More recent investigations, especially those of E. B. Wilson, have shown that this view is correct for many animals.

While in many animals there are two kinds of spermatozoa and only one kind of eggs, in other animals two kinds of eggs and only one kind of spermatozoa are formed, e.g., sea-urchins and certain species of birds and of butterflies (*Abraxas*). In these animals the sex is predetermined in the egg and not in the spermatozoon. It is of interest that, according to Guyer, in the human being two kinds of spermatozoa exist and only one kind of eggs; in man, therefore, sex is determined by the spermatozoon.

How is sex determination accomplished? Let us take the case which according to Wilson is true for many insects and according to Guyer for human beings, namely, that there are two kinds of spermatozoa and one kind of eggs. According to Wilson all unfertilized eggs contain in this case one so-called

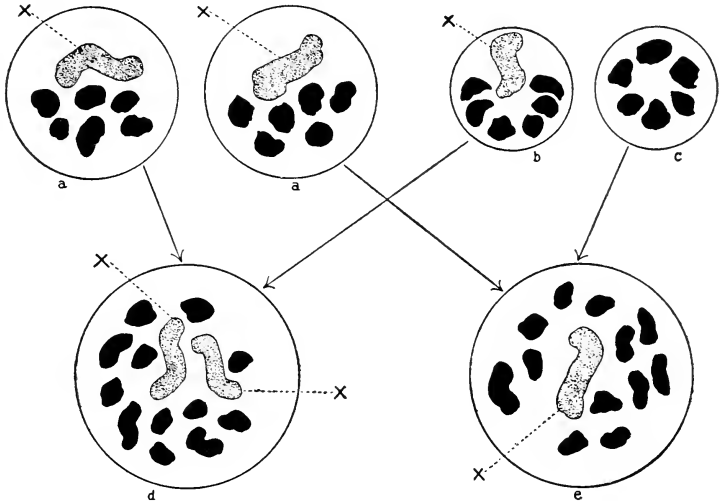

FIGS. 11-16 (after E. B. Wilson).—Diagrammatic presentation of sex determination in an insect (*Protenor*). *a a* are the nuclei of unfertilized eggs. Each contains one sex chromosome marked *X*; the other six dark spots are the chromosomes which are supposed to transmit hereditary characters not connected with sex. *b* and *c* represent the two different types of sperm; *b* containing a sex chromosome *X*, *c* being without such a chromosome.

*d* represents the constitution of the egg nucleus after it is fertilized by a spermatozoon of the type *b* containing a sex chromosome. This egg now has two sex chromosomes and therefore will give rise to a female. *e* represents a fertilized egg after a spermatozoon of the type *c* (without a sex chromosome) has entered it. This egg contains after fertilization only one sex chromosome *X* and hence will give rise to a male.

sex chromosome, the *X*-chromosome. There are two kinds of spermatozoa, one with and one without an *X*-chromosome. Given a sufficiently large number of eggs and of spermatozoa, one-half of the eggs will be fertilized by spermatozoa with and one-half by spermatozoa without an *X*-chromosome. Hence one-half of the eggs will contain *after* fertilization two *X*-chromosomes each and one-half only one *X*-chromosome

each. The eggs containing only one *X*-chromosome give rise to males, those containing two *X*-chromosomes give rise to females—as Wilson and others have proved. This seems to be a general law for those cases in which there are two kinds of spermatozoa and one kind of eggs.

These observations show why it is impossible to influence the sex of a developing embryo by external influences. If, for example, in the human being a spermatozoon without an *X*-chromosome enters into an egg, the egg will give rise to a boy, but if a spermatozoon with an *X*-chromosome gets into the egg the latter will give rise to a girl. Since always both kinds of spermatozoa are given off by the male it is a mere matter of chance whether a boy or a girl originates; and it agrees with the law of probability that in a large population the number of boys and girls born within a year is approximately the same.<sup>1</sup>

These discoveries solved also a series of other difficulties. Certain types of twins originate from one egg after fertilization. Such twins have always the same sex, as we should expect, since the cells of both twins have the same number of *X*-chromosomes.

In plant lice, bees, and ants, the eggs may develop with and without fertilization. It was known that from fertilized eggs in these animals only females develop, males never. It was found that in these animals the eggs contain only one sex chromosome; while in the male are found two kinds of spermatozoa, one with and one without a sex chromosome. For *Phylloxera* and *Aphides* it has been proved with certainty by Morgan and others that the spermatozoa which contain no sex chromosome cannot live, and the same is probably true for bees and ants. If, therefore, in these animals an egg is

<sup>1</sup> It is stated that the number of males born exceeds that of the females by a slight percentage. If this statement is correct it must be due to a secondary cause, e.g., a greater motility or greater duration of life of the male spermatozoon. Further researches will be needed to clear up this point.

fertilized it is always done by a spermatozoon which contains an  $X$ -chromosome. The egg has, therefore, after fertilization in these animals always two  $X$ -chromosomes and from such eggs only females can arise.

It had been known for a long time that in bees and ants the unfertilized eggs can also develop, but such eggs give rise to males only. This is due to the fact that the eggs of these animals contain only one  $X$ -chromosome and from eggs with only one chromosome only males can arise (at least in the case of animals in which the male is heterozygous for sex).

The problem of sex determination has, therefore, found a simple solution, and simultaneously Mendel's law of segregation also finds its solution.

In many insects and in man the cells of the female have two sex chromosomes. In a certain stage of the history of the egg one-half of the chromosomes leave the egg (in the form of the "polar-body") and it keeps only half the number of chromosomes. Each egg, therefore, retains only one  $X$  or sex chromosome. In the male the cells have from the beginning only one  $X$ -chromosome and each primordial spermatozoon divides into two new (in reality into two pairs of) spermatozoa, one of which contains an  $X$ -chromosome while the other is without such a chromosome. What can be observed here directly in the male animal takes place in every hybrid; during the critical, so-called maturation division of the sexual cell in the hybrid, a division of the chromosomes occurs, whereby only one-half of the sex-cells receive the hereditary substance in regard to which the two original pure forms differ.

That this is not a mere assumption can be shown in those cases in which the hereditary character appears only, or pre-eminently, in one sex as, e.g., color blindness which appears mostly in the male. If a color-blind individual is mated with an individual with normal color vision the heredity of color

blindness in the next two generations corresponds quantitatively with what we must expect on the assumption that the chemical substances determining color vision are contained in the sex chromosomes. In the color-blind individual something is lacking which can be found in the individual with normal color perception. The factor for color vision is obviously transmitted through the sex chromosome. In the next generation color blindness cannot appear, since each fertilized egg contains the factor for color perception. In the second generation, however, the theory demands that one-half of the males should be color blind. In man these conditions cannot be verified. T. H. Morgan has found in a fly (*Drosophila*) a number of similar sex-limited characters which behave like color blindness, e.g., lack of pigment in the eyes. These flies have normally red eyes. Morgan has observed a mutation with white eyes, which occurs in the male. When he crossed a white-eyed with a red-eyed female all flies of the first generation were red-eyed, since all flies had the factor for pigment in their sex-cells; in the second generation all females and exactly one-half of the males had red eyes, the other half of the males, however, white eyes, as the theory demands.

From these and numerous similar breeding experiments of Correns, Doncaster, and especially of Morgan, we may conclude with certainty that the sex chromosomes are the bearers of those hereditary characters which appear pre-eminently in one sex. We say pre-eminently, since theoretically we can predict cases in which color blindness or white eyes must appear also in the female. Breeding experiments have shown that this theoretical prediction is justified. The riddle of Mendel's law of segregation finds its solution through these experiments and incidentally also the problem of the determination of sex which is only a special case of the law of segregation, as Mendel already intimated.

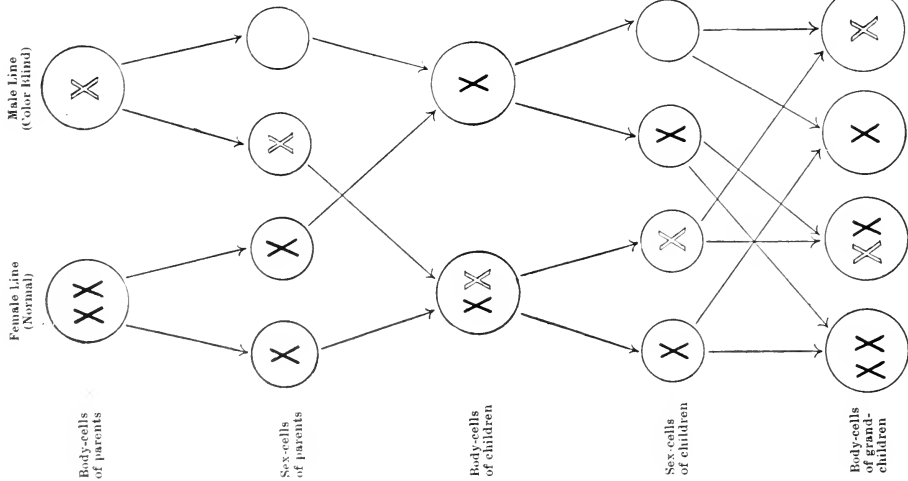

FIG. 17 (after E. B. Wilson).—Diagram illustrating the inheritance of a sex-limited character (e.g., color blindness in man, or lack of pigment in the eye of *Drosophila*) on the assumption that the factor for normal color perception (in man), or pigment formation (in *Drosophila*), is located in the sex chromosome. It is assumed that a normal female is mated with a color-blind male.

*First row: body-cells of parents.*—The body-cells of the female contain two X or sex chromosomes, each of which contains a factor for the development of normal color perception, since it is assumed that the female is normal. The normal sex chromosome is indicated by a black X. The body-cells of the color-blind male have only one sex chromosome which is lacking the factor for color perception and is marked by a light X.

*Second row: sex-cells of parents.*—The female has eggs each of which has one normal sex chromosome; the male has two kinds of spermatozoa, one with a defective sex chromosome and one without any sex chromosome.

*Third row: body-cells of children.*—Two types of children are produced by such a mating which are represented in this row. One type is produced by the entrance of a spermatozoon with a sex chromosome and one by the entrance of a spermatozoon without a sex chromosome. Since in both cases the egg contained already a sex chromosome provided with a factor for color perception, all the children have normal color vision.

*The fourth row* contains a diagram of the various sex-cells formed in the children of the original couple. The female has two kinds of eggs each with a sex chromosome, but one has chromosomes with a factor for the production of normal color perception while in the other this factor is lacking. The two types of spermatozoa formed in the male consist of one with a sex chromosome, containing the normal factor for color perception and the other without a sex chromosome.

*Fifth row: body-cells of grandchildren.*—This row contains the results which would be obtained if these children could be mated. It is obvious that all the girls born in such a case would have normal color perception while one-half of the boys would be color blind. This mating can be carried out on a large scale in *Drosophila* and Morgan showed that the results harmonize quantitatively with what we should expect from this diagram. In the human similar matings could be carried out between cousins and in such cases color blindness will result in the ratio indicated by the diagram.

The main task which is left here for science to accomplish is the determination of the chemical substances in the chromosomes which are responsible for the hereditary transmission of a quality, and the determination of the mechanism by which these substances give rise to the hereditary character. Here the ground has already been broken. It is known that for the formation of a certain black pigment the cooperation of a substance—tyrosin—and of a ferment of oxidation—tyrosinase—is required. The hereditary transmission of the black color through the male animal must occur by substances carried in the chromosome which determine the formation of tyrosin or tyrosinase or of both. We may, therefore, say that the solution of the riddle of heredity has succeeded to the extent that all further development will take place purely in cytological and physico-chemical terms.

While until twelve years ago the field of heredity was the stamping ground for the rhetorician and metaphysician it is today perhaps the most exact and rationalistic part of biology, where facts cannot only be predicted qualitatively, but also quantitatively.

#### VII. THE HARMONIOUS CHARACTER OF THE ORGANISMS

It is not possible to prove in a short address that all life phenomena will yield to a physico-chemical analysis. We have selected only the phenomena of fertilization and heredity, since these phenomena are specific for living organisms and without analogues in inanimate nature; and if we can convince ourselves that these processes can be explained physico-chemically we may safely expect the same of such processes for which there exist a-priori analogies in inanimate nature, as, e.g., for absorption and secretion.

We must, however, settle a question which offers itself not only to the layman but also to every biologist, namely, how we shall conceive that wonderful “adaptation of each part to the

whole" by which an organism becomes possible. In the answer to this question the metaphysician finds an opportunity to put above the purely chemical and physical processes something specific which is characteristic of life only: the "Zielstrebigkeit," the "harmony" of the phenomena, or the "dominants" of Reinke and similar things.

With all due personal respect for the authors of such terms I am of the opinion that we are dealing here, as in all cases of metaphysics, with a play on words. That a part is so constructed that it serves the "whole" is only an unclear expression for the fact that a species is only able to live—or to use Roux's expression—is only durable, if it is provided with the automatic mechanism for self-preservation and reproduction. If, for instance, warm-blooded animals should originate without a circulation they could not remain alive, and this is the reason why we never find such forms. The phenomena of "adaptation" cause only apparent difficulties since we rarely or never become aware of the numerous faultily constructed organisms which appear in nature. I will illustrate by a concrete example that the number of species which we observe is only an infinitely small fraction of those which can originate and possibly not rarely do originate, but which we never see since their organization does not allow them to continue to exist long. Moenkhaus found ten years ago that it is possible to fertilize the egg of each marine bony fish with the sperm of practically any other marine bony fish. His embryos apparently lived only a very short time. This year I succeeded in keeping such hybrid embryos between distantly related bony fish alive for over a month. It is, therefore, clear that it is possible to cross practically any marine teleost with any other.

The number of teleosts at present in existence is about 10,000. If we accomplish all possible hybridizations 100,000,000 different crosses will result. Of these teleosts only a very small proportion, namely about one one-hundredth of 1 per cent,



can live. It turned out in my experiments that the heterogeneous hybrids between bony fishes formed eyes, brains, ears, fins, and pulsating hearts, blood and blood-vessels, but could live only a limited time because no blood circulation was established—in spite of the fact that the heart beat for weeks—or that the circulation, if it was established at all, did not last long.

What prevented these heterogeneous fish embryos from reaching the adult stage? The lack of the proper “dominants”? Scarcely. I succeeded in producing the same type of faulty embryos in the pure breeds of a bony fish (*Fundulus heteroclitus*) by raising the eggs in 50 c.c. of sea-water to which was added 2 c.c. 1/100 per cent NaCN. The latter substance retards the velocity of oxidations and I obtained embryos which were in all details identical with the embryos produced by crossing the eggs of the same fish with the sperm of remote teleosts, e.g., *Ctenolabrus* or *Menidia*. These embryos, which lived about a month, showed the peculiarity of possessing a beating heart and blood, but no circulation. This suggests the idea that heterogeneous embryos show a lack of “adaptation” and durability for the reason that in consequence of the chemical difference between heterogeneous sperm and egg the chemical processes in the fertilized egg are abnormal.

The possibility of hybridization goes much farther than we have thus far assumed. We can cause the eggs of echinoderms to develop with the sperm of very distant forms, even mollusks and worms (Kupelwieser); but such hybridizations never lead to the formation of durable organisms.

It is, therefore, no exaggeration to state that the number of species existing today is only an infinitely small fraction of those which can and possibly occasionally do originate, but which escape our notice because they cannot live and reproduce. Only that limited fraction of species can exist which possesses no coarse disharmonies in its automatic mechanism of preservation and reproduction. Disharmonies and faulty attempts in

nature are the rule, the harmonically developed systems the rare exception. But since we only perceive the latter we gain the erroneous impression that the "adaptation of the parts to the plan of the whole" is a general and specific characteristic of animate nature, whereby the latter differs from inanimate nature.

If the structure and the mechanism of the atoms were known to us we should probably also get an insight into a world of wonderful harmonies and apparent adaptations of the parts to the whole. But in this case we should quickly understand that the chemical elements are only the few durable systems among a large number of possible but not durable combinations. Nobody doubts that the durable chemical elements are only the product of blind forces. There is no reason for conceiving otherwise the durable systems in living nature.

#### VIII. THE CONTENTS OF LIFE

The contents of life from the cradle to the bier are wishes and hopes, efforts and struggles, and unfortunately also disappointments and suffering. And this inner life should be amenable to a physico-chemical analysis? In spite of the gulf which separates us today from such an aim I believe that it is attainable. As long as a life phenomenon has not yet found a physico-chemical explanation it usually appears inexplicable. If the veil is once lifted we are always surprised that we did not guess from the first what was behind it.

That in the case of our inner life a physico-chemical explanation is not beyond the realm of possibility is proved by the fact that it is already possible for us to explain cases of simple manifestations of animal instinct and will on a physico-chemical basis; namely, the phenomena which I have discussed in former papers under the name of animal tropisms. As the most simple example we may mention the tendency of certain animals to fly or creep to the light. We are dealing in this case with the manifestation of an instinct or impulse which the

animals cannot resist. It appears as if this blind instinct which these animals must follow, although it may cost them their life, might be explained by the same law of Bunsen and Roscoe, which explains the photochemical effects in inanimate nature. This law states that within wide limits the photochemical effect equals the product of the intensity of light into the duration of illumination. It is not possible to enter here into all the details of the reactions of these animals to light; we only wish to point out in which way the light instinct of the animals may possibly be connected with the Bunsen-Roscoe law.

The positively heliotropic animals—i.e., the animals which go instinctively to a source of light—have in their eyes (and occasionally also in their skin) photosensitive substances which undergo chemical alterations by light. The products formed in this process influence the contraction of the muscles—mostly indirectly, through the central nervous system. If the animal is illuminated on one side only, the mass of photochemical reaction products formed on that side in the unit of time is greater than on the opposite side. Consequently the development of energy in the symmetrical muscles on both sides of the body becomes unequal. As soon as the difference in the masses of the photochemical reaction products on both sides of the animal reaches a certain value, the animal, as soon as it moves, is automatically forced to turn toward one side. As soon as it has turned so far that its plane of symmetry is in the direction of the rays, the symmetrical spots of its surface are struck by the light at the same angle and in this case the intensity of light and consequently the velocity of reaction of the photochemical processes on both sides of the animal become equal. There is no more reason for the animal to deviate from the motion in a straight line and the positively heliotropic animal will move in this line to the source of light. (It was assumed that in these experiments the animal is under the influence of only one source of light and positively heliotropic.)

In a series of experiments I have shown that the heliotropic reactions of animals are identical with the heliotropic reactions of plants. It was known that sessile heliotropic plants bend

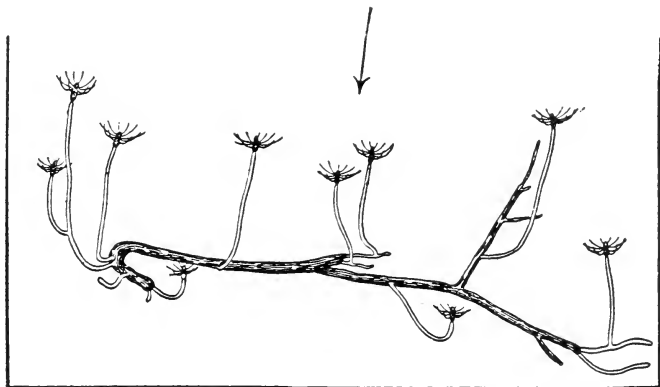

FIG. 18

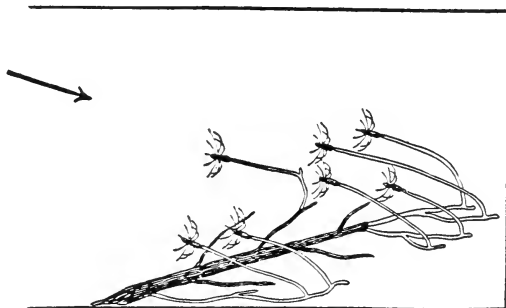

FIG. 19

FIGS. 18 and 19.—Positive heliotropism of the polyps of *Eudendrium*. The new polyp-bearing stems all grow in the direction of the rays of light which is indicated by an arrow in each figure. (From nature.) These animals bend in the same way to the light as the stems of positively heliotropic plants kept under similar conditions.

their stems to the source of light until the axis of symmetry of their tip is in the direction of the rays of light. I found the same phenomenon in sessile animals, e.g., certain hydroids and worms. Motile plant organs, e.g., the swarm spores of plants, move to the source of light (or if they are negatively

heliotropic away from it), and the same is observed in motile animals. In plants only the more refrangible rays from green to blue have these heliotropic effects, while the red and yellow rays are little or less effective; and the same is true for the heliotropic reactions of animals.

It has been shown by Blaauw for the heliotropic curvatures of plants that the product of the intensity of a source of light into the time required to induce a heliotropic curvature is a

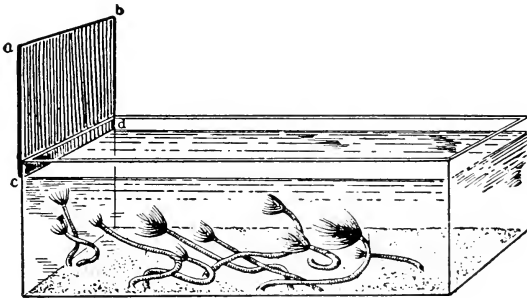

FIG. 20.—Positive heliotropism of a marine worm (*Spirographis*). (From nature.) The light fell into the aquarium from one side only and the worms all bent their heads toward the source of light, as the stems of positively heliotropic plants would do under the same conditions.

constant; and the same result was obtained simultaneously by another botanist, Fröschl. It is thus proved that the Bunsen-Roscoe law controls the heliotropic reactions of plants. The same fact had already been proved for the action of light on our retina.

The direct measurements in regard to the applicability of Bunsen's law to the phenomena of animal heliotropism have not yet been made. But a number of data point to the probability that the law holds good here also. The first of these facts is the identity of the light reactions of plants and animals. The second is at least a rough observation which harmonizes with the Bunsen-Roscoe law. As long as the intensity of light or the mass of photochemical substances at the surfaces of the

animal is small, according to the law of Bunsen, it must take a comparatively long time until the animal is automatically oriented by the light, since according to this law the photochemical effect is equal to the product of the intensity of the light into the duration of illumination. If, however, the intensity of the light is strong or the active mass of the photochemical substance great, it will require only a very short time until the difference in the mass of photochemical reaction products on both sides of the animal reaches the value which is necessary for the automatic turning to (or from) the light. The behavior of the animals agrees with this assumption. If the light is sufficiently strong the animals go in an almost straight line to the source of light; if the intensity of light (or the mass of photosensitive substances on the surface of the animal) is small the animals go in irregular lines, but at last they also land at the source of light, since the directing force is not entirely abolished. It will, however, be necessary to ascertain by direct measurements to what extent these phenomena in animals are the expression of Bunsen-Roscoe's law. But we may already safely state that the apparent will or instinct of these animals resolves itself into a modification of the action of the muscles through the influence of light; and for the metaphysical term "will" we may in these instances safely substitute the chemical term "photochemical action of light."

Our wishes and hopes, disappointments and sufferings have their source in instincts which are comparable to the light instinct of the heliotropic animals. The need of and the struggle for food, the sexual instinct with its poetry and its chain of consequences, the maternal instincts with the felicity and the suffering caused by them, the instinct of workmanship, and some other instincts are the roots from which our inner life develops. For some of these instincts the chemical basis is at least sufficiently indicated to arouse the hope that their analysis, from the mechanistic point of view, is only a question of time.

## IX. ETHICS

If our existence is based on the play of blind forces and only a matter of chance; if we ourselves are only chemical mechanisms—how can there be an ethics for us? The answer is, that our instincts are the root of our ethics and that the instincts are just as hereditary as is the form of our body. We eat, drink, and reproduce not because mankind has reached an agreement that this is desirable, but because, machine-like, we are compelled to do so. We are active, because we are compelled to be so by processes in our central nervous system; and as long as human beings are not economic slaves the instinct of successful work or of workmanship determines the direction of their action. The mother loves and cares for her children, not because metaphysicians had the idea that this was desirable, but because the instinct of taking care of the young is inherited just as distinctly as the morphological characters of the female body. We seek and enjoy the fellowship of human beings because hereditary conditions compel us to do so. We struggle for justice and truth since we are instinctively compelled to see our fellow beings happy. Economic, social, and political conditions or ignorance and superstition may warp and inhibit the inherited instincts and thus create a civilization with a faulty or low development of ethics. Individual mutants may arise in which one or the other desirable instinct is lost, just as individual mutants without pigment may arise in animals; and the offspring of such mutants may, if numerous enough, lower the ethical status of a community. Not only is the mechanistic conception of life compatible with ethics: it seems the only conception of life which can lead to an understanding of the source of ethics.





## II. THE SIGNIFICANCE OF TROPISMS FOR PSYCHOLOGY



## II

### THE SIGNIFICANCE OF TROPISMS FOR PSYCHOLOGY<sup>1</sup>

#### I

A mechanistic conception of life is not complete unless it includes a physico-chemical explanation of psychic phenomena. Some authors hold that even if a complete physico-chemical analysis of these phenomena were possible today it would leave the "truly psychical" unexplained. We do not need to enter into a discussion of such an objection since we are still too far from the goal. We are at least able to show for a limited group of animal reactions that they can be explained unequivocally on a purely physico-chemical basis, namely, phenomena which the metaphysician would classify under the term of animal "will."

Through the writings of Schopenhauer and E. von Hartmann I became interested in the problem of will. When as a student I read Munk's investigations on the cerebral cortex I believed that they might serve as a starting-point for an experimental analysis of will. Munk stated that he had succeeded in proving that every memory image in a dog's brain is localized in a particular cell or group of cells and that any one of these memory images can be extirpated at desire. Five years of experiments with extirpations in the cerebral cortex proved to me without doubt that Munk had become the victim of an error and that the method of cerebral operations may give data concerning the path of nerves in the central nervous system but that it teaches little about the dynamics of brain processes.

A better opportunity seemed to offer itself in the study of the comparative psychology of the lower animals in which

<sup>1</sup> Lecture delivered at the Sixth International Psychological Congress at Geneva, 1909. (After a translation in *Popular Science Monthly* by Miss Grace B. Watkinson.) Reprinted by courtesy of Professor James McKeen Cattell.

the mechanism for memory is developed but slightly or not at all. It seemed to me that some day it must become possible to discover the physico-chemical laws underlying the apparently random movements of such animals; and that the word "animal will" was only the expression of our ignorance of the forces which prescribe to animals the direction of their apparently spontaneous movements just as unequivocally as gravity prescribes the movements of the planets. For if a savage could directly observe the movements of the planets and should begin to think about them, he would probably come to the conclusion that a "will action" guides the movements of the planets just as a chance observer is today inclined to assume that "will" causes animals to move in a given direction.

The scientific solution of the problem of will seemed then to consist in finding the forces which determine the movements of animals, and in discovering the laws according to which these forces act. Experimentally, the solution of the problem of will must take the form of forcing, by external agencies, any number of individuals of a given kind of animals to move in a definite direction by means of their locomotor apparatus. Only if we succeed in this have we the right to assume that we know the force which under certain conditions seems to a layman to be the will of the animal. But if one part only of the animals moves in this definite direction and the other does not, we have not succeeded in finding the force which unequivocally determines the direction of their movement.

One other point should be observed. If a sparrow flies down to a seed lying on the ground, we speak of an act of will, but if a dead sparrow falls upon the seed this does not appear to us as such. In the latter case purely physical forces are concerned, while in the former chemical reactions are also taking place in the sense-organs, nerves, and muscles of the animal. We speak of an act of will, only when this latter complex, that is, the natural movement of locomotion, plays its part also, and

it is only with this sort of reactions that we have to deal in the psychology of the will.

## II

Some experiments on winged plant lice may serve as an introduction to the methods of prescribing to animals the direction of their progressive movements.

In order to obtain the material, potted rose bushes or *Cinerarias* infected with plant lice are brought into a room and placed in front of a closed window. If the plants are allowed to dry out, the aphids (plant lice), previously wingless, change into winged insects. After this metamorphosis the animals leave the plants, fly to the window, and there creep upward on the glass. They can then easily be collected by holding a test-tube underneath and touching one animal at a time from above with a pen or scalpel, which causes the animals to drop into the test-tube. In this manner a sufficiently large number, perhaps twenty-five or fifty suitable subjects for the experiment, may be obtained. With these animals it may be demonstrated that the direction of their movement toward the light is definitely determined—provided that the animals are healthy and that the light is not too weak. The experiment is so arranged that only a single source of light, e.g., artificial light, is used.

The animals place themselves with their heads toward the source of light and move toward it in as straight a line as the imperfection of their locomotor apparatus allows, approaching as near to the source of light as their prison (the test-tube) permits. When they reach that end of the test-tube which is directed toward the source of light, they remain there, stationary, in a closely crowded mass. If the test-tube is turned 180° the animals again go straight toward the source of light until the interference of the glass stops their further progressive movements.<sup>1</sup> It can be demonstrated in these animals that the

<sup>1</sup> Loeb, *Der Heliotropismus der Tiere und seine Uebereinstimmung mit dem Heliotropismus der Pflanzen*, Würzburg, 1889. Translated in *Studies in General Physiology*, 1906.

direction of their progressive movement is just as unequivocally governed by the source of light as the direction of the movement of the planets is determined by the force of gravity.

The theory of the compulsory movements of aphids under the influence of light is as follows: Two factors govern the progressive movements of the animals under these conditions; one is the symmetrical structure of the animal, and the second is the photochemical action of light. We will consider the two separately. In regard to the photochemical action of light, we know today that a great many chemical reactions of organic bodies are accelerated by light. Especially is this true of oxidations.<sup>1</sup> The mass of facts is already so great that we are justified in assuming that the determining action of light upon animals and plants is in its last analysis due to the fact that the rate of certain chemical reactions in the cells of the retina or of other photosensitive regions of the organisms is modified by light; with increasing intensity of light the rate of certain chemical reactions, e.g., oxidation, increases.

The second factor is the symmetrical structure of the animal. As expressed in the gross anatomy of the animal, the right and left halves of the body are symmetrical. But it is my belief that such a symmetry exists in a chemical sense, as well as in an anatomical, by which I mean that symmetrical regions of the body are chemically identical and have the same metabolism, while non-symmetrical regions of the body are chemically different, and in general have a quantitatively or qualitatively different metabolism. In order to illustrate this difference it is only necessary to point out that the two retinæ, which are certainly symmetrical, have an identical metabolism, while a region of the skin which is not symmetrical with the retina has a different metabolism. The individual points on

<sup>1</sup> Luther, *Die Aufgaben der Photochemie*, Leipzig, 1905; C. Neuberg, *Biochem. Zeitschr.*, XIII, 305, 1908; Loeb, *The Dynamics of Living Matter*, New York, 1906. In addition, see the work of Ciamician, as also of Wolfgang Ostwald (*Biochem. Zeitschr.*, 1907).

the retina are also chemically unlike. The observations upon visual purple, the differences in the color sensitiveness of the *fovea centralis*, and the peripheral parts of the retina indicate that the points of symmetry of the two retinae are chemically alike, the non-symmetrical points chemically unlike.

Now if an unequal amount of light falls upon the two retinae the photochemical reactions in the one which receives more light will also be more accelerated than those in the other. The same naturally holds true for every other pair of symmetrical photosensitive surface elements. For it should be mentioned that photochemical substances are not found in the eyes only, but also in other places on the surface of many animals. In planarians, as my experiments and those of Parker have shown, not only the eyes, but also parts of the skin, are photosensitive. But if more light falls upon one retina than upon the other, the chemical reactions will also be more accelerated in the one retina than in the other, and accordingly more intense chemical changes will take place in one optic nerve than in the other. S. S. Maxwell and C. D. Snyder have demonstrated, independently of each other, that the rate of the nerve impulse has a temperature coefficient of the order of magnitude which is characteristic for chemical reactions. From this we must conclude that when two retinae (or other points of symmetry) are illuminated with unequal intensity, chemical processes, also of unequal intensity, take place in the two optic nerves (or in the sensory nerves of the two illuminated points). This inequality of chemical processes passes from the sensory to the motor nerves and eventually to the muscles connected with them. We conclude from this that with equal illumination of both retinae the symmetrical groups of muscles of both halves of the body will receive equal chemical stimuli and thus reach equal states of contraction, while, when the rate of reaction is unequal, the symmetrical muscles on one side of the body come into stronger action than

those on the other side. The result of such an inequality of the action of symmetrical muscles of the two sides of the body is a change in the direction of movement on the part of the animal.

The change in the direction of movement can result either in a turning of the head and, in consequence, of the whole animal toward the source of light, or in a turning of the head and the animal in the opposite direction. The structure of the central nervous system is segmental and the head segments generally determine<sup>1</sup> the behavior of the other segments with their accessory parts.

In the winged aphids the relations are as follows: Suppose that a single source of light is present and that the light strikes the animal from one side. As a consequence the activity of those muscles which turn the head or body of the animal toward the source of light will be increased.<sup>2</sup> As a result the head, and with it the whole body of the animal, is turned toward the source of light. As soon as this happens, the two retinæ become illuminated equally. There is therefore no longer any cause for the animal to turn in one direction or the other. It is thus automatically guided toward the source of light. In this instance the light is the "will" of the animal which determines the direction of its movement, just as it is gravity in the case of a falling stone or the movement of a planet. The action of gravity upon the movement of the falling stone is direct, while the action of light upon the direction of movement of the aphids is indirect, inasmuch as the animal is caused only by means of an acceleration of photochemical reactions to move in a definite direction.

<sup>1</sup> Loeb, *Comparative Physiology of the Brain and Comparative Psychology*, New York and London, 1900.

<sup>2</sup> If two sources of light of equal intensity are at an equal distance from the animal, it will move in a direction at right angles to a line connecting the two sources of light, because in this case both eyes are similarly influenced by the light. Herein, as Bohn has rightly said, the machine-like heliotropic reaction of animals differs from the movement of a human being toward one of two sources of light, the movement in the latter case not being determined by heliotropism.



We will now designate as positively heliotropic those animals which are forced to turn their head or move toward the source of light, and as negatively heliotropic those animals which are oriented or compelled to move in the opposite direction.<sup>1</sup>

The aphids serve here only as an example. The same phenomena of positive heliotropism may be demonstrated with equal precision in a great many animals, vertebrates as well as invertebrates. We cannot, of course, give here an account of all these cases. The reader who is interested in them must look into the voluminous literature upon this subject. Heliotropism is unusually common among the larvae of marine animals and insects, but also not lacking in sexually mature individuals.

Heliotropic animals are therefore in reality photometric machines. According to photometric laws the intensity of light varies with the sine of the angle at which the light strikes a surface element of the animal (or with the cosine of the angle of incidence). The animal is oriented by the light in such a way that symmetrical elements of its photosensitive surface are struck at about the same angle. In the presence of only one source of light this condition is fulfilled if the axis of symmetry of the animal moves in the direction of the rays of light. In this case the velocity of photochemical reactions on both sides of the animal is the same and there is no reason why it should deviate from this direction in its progressive motions.

Experiments on the heliotropism of plants as well as on the perception of light by our retina have shown that the effect of light equals the product of the intensity into the duration of illumination. This law is identical with the general law of Bunsen and Roscoe which states that the chemical effect of light is within wide limits equal to this product. We do not yet know whether or not Bunsen's law holds good for the heliotropic animals. If it does, we shall have to substitute

<sup>1</sup> Whether an animal is positively or negatively heliotropic depends upon the fact whether the light causes an increase or a decrease in the tension of the muscles. Why light should have these opposite effects is as yet unknown.

this law for what the metaphysician calls the will of these animals.

### III

The winged aphids serve as an example, because they fulfil the above-mentioned requirement, namely, that *all* individuals, without exception, move toward the light. For mechanistic science it is a methodological postulate that the same law acts without exception, or that the exception must be satisfactorily explained. It was soon found, as was to be expected, that not all organisms in their natural condition are equally suitable for these experiments. Many animals show no heliotropism at all; many show only a slight reaction, while others show it in a degree as pronounced as do the winged aphids. The problem therefore presented itself of producing heliotropism artificially in animals which, under natural conditions, show no positive heliotropism. If small crustaceans of a fresh-water pond or lake are taken with a plankton net at noontime or in the afternoon and placed in an aquarium which is illuminated from one side only, it is often found that these animals move about in the vessel pretty much at random and distribute themselves irregularly. Some seem to go more toward the source of light, others in the opposite direction, and the majority perhaps pay no attention to the light.

This condition changes instantly if we add to the water some acid, preferably carbonic acid, which easily penetrates the cells of the animal. To every 50 c.c. of the fresh water a few cubic centimeters of water charged with carbon dioxide are slowly added. If the correct amount is added all the individuals become actively positively heliotropic and move in as straight a line as the imperfection of their swimming movements permits, toward the source of light, and remain there closely crowded together on the illuminated side of the vessel. If the vessel is turned 180°, they go directly back again to the lighted side of the vessel. Every other acid acts like carbonic acid and

alcohol acts in the same manner, only more weakly and much more slowly. Animals which were previously indifferent to light become, under carbonic acid treatment, complete slaves of the light.<sup>1</sup>

How does the acid produce this result? We will assume that it acts as a sensitizer. The light produces chemical changes, for instance, oxidation, on the surface of the animal, especially in the eye, as was suggested in the case of the aphids. The mass of photochemical substance which is acted upon by the light is often relatively small, so that even when the light strikes the crustacean (copepod) on one side only, the difference in the chemical changes on the two sides of the body remains still too small to call forth a difference in tension or action in the muscles of the two sides of the body, sufficient to turn the animal toward the source of light. But if we add an acid this could act as a catalyzer, as, for instance, in the *catalysis of esters*. In the *catalysis of esters*, the acid acts, according to Stieglitz, only to the extent of increasing the active mass of the substance which undergoes a chemical change. In order to fix our ideas provisionally we will assume that the acid makes the animal more strongly positively heliotropic by increasing the active mass of the photosensitive substance. In this way the same intensity of light which before produced no heliotropic reaction now may cause a very pronounced positively heliotropic reaction; because if now the animal is struck on one side only by the light, the difference in the reaction products in both retinae becomes rapidly large enough to cause automatically a difference in the action of the muscles of both sides of the body and a turning of the head toward the source of light.

In certain forms, for instance, in *Daphnia* and in certain marine copepods, a decrease in temperature also increases the tendency to positive heliotropism. If the mere addition of acid is not sufficient to make *Daphniae* positively heliotropic,

<sup>1</sup> Loeb, *Pflügers Archiv*, CXV, 564, 1906.

this may often be accomplished by simultaneously reducing the temperature.

#### IV

The animals which are strongly positively heliotropic and those animals which do not react at all to light offer no difficulties to the observer. Nevertheless, some zoologists seem to have found difficulty in explaining the behavior of those animals which come between the two extremes. For instance, one writer has asserted that with greater intensity of light the laws of heliotropic orientation hold good, while with a lessened light intensity the animals react to light by the method of "trial and error." From a chemical standpoint the behavior of animals at low intensity is easily to be understood. If a positively heliotropic animal is illuminated from one side, a compulsory turning of the head toward the source of light occurs only when the difference in the rate of certain photochemical reactions in the two eyes reaches a certain value. If the intensity of the light is sufficient and the active mass of photochemical substance in the animal great enough, it requires only a short time, for instance, the fraction of a second, before the difference in the mass of the reaction products formed on the two sides of the animal reaches the value necessary for the compulsory turning of the head toward the source of light. In this case the animal is a slave of the light; in other words, it has hardly time to deviate from the direction of the light rays; for if it turns the head even for the fraction of a second from the direction of the light rays, the difference in the photochemical reaction products in the two retinae becomes so great that the head is at once turned back automatically toward the source of light. But if the intensity of the light or the photosensitiveness of the animal is lessened the animal may deviate for a longer period from the direction of the light rays. Such animals do eventually reach the lighted side of the vessel, but they no longer go straight toward it, moving instead in zig-zag lines

or very irregularly. It is therefore not a case of a qualitative, but of a quantitative, difference in the behavior of heliotropic animals under greater or lesser illumination, and it is therefore erroneous to assert that heliotropism determines the movement of animals toward the source of light only under strong illumination, but that under weaker illumination an essentially different condition exists.

Still another point is to be considered. We have seen that acid increases the sensitiveness of certain animals to light, possibly by increasing the active mass of the photochemical substance. Every animal is continually producing acids in its cells, especially carbonic acid and lactic acid; and such acids increase the tendency in certain animals to react heliotropically. It probably produces also substances which could have the opposite effect and which decrease the heliotropic sensitiveness of the animals. Fluctuations in the rate of the production of these substances will also produce fluctuations in the heliotropic sensitiveness of the animal. If, for instance, the active mass of the photosensitive substance in a copepod is relatively small, a temporary increase in the production of carbonic acid can increase the photosensitiveness of the animal sufficiently to cause it to move for the period of a few seconds directly toward the source of light. Later the production of carbonic acid decreases and the animal again becomes indifferent to light and can move in any direction. Then the production of carbonic acid increases again and the animal goes again, for a short time, toward the light. Such animals finally gather at the lighted side of the vessel because the algebraic sum of the movements in the other directions becomes zero according to the law of chance. But it is plain that such animals do not reach the source of light by a straight path. A writer who is not trained to interpret the variations in the behavior of such an animal chemically and physiologically, can naturally give no explanation of their significance. If he is forced to find an

explanation he will wind up with the suggestion of "trial and error" which is no more chemical or scientific than the explanations of metaphysicians in general.

Some authors have, it seems, worked only with animals which were not pronouncedly heliotropic and whose photosensitiveness wavered about the threshold of stimulation in the manner described above. Such animals are not suitable for experiments in heliotropism and it is necessary to first increase their photosensitiveness if the laws of the action of light upon them are to be investigated.

I also believe that observations upon animals which are not sufficiently photosensitive have caused many writers to assert that heliotropic animals do not place themselves directly in the line of the rays of light,<sup>1</sup> but that they first have to learn the right orientation. A very striking experiment contradicts this assertion. The larvae of *Balanus perforatus* develop entirely in the dark. If the ovary filled with mature larvae is placed in a watch crystal filled with sea-water in the dark, the larvae emerge at once and, if they are brought into the light, they move at once to the side of the watch crystal nearest to the window. They were, therefore, pronouncedly positively heliotropic before they came under the influence of the light.

In experiments with winged aphids I often found that after having gone through the heliotropic reactions a few times they react much more quickly to light than at the beginning. This might be interpreted as a case of "learning." In so far as it is not a case of a lessening of the stickiness of the feet or the removal of some other purely mechanical factor which retards the rate of movement, it may be brought about by the carbonic or lactic acids produced through the muscular activity.<sup>2</sup>

<sup>1</sup> Provided that only a single source of light is present.

<sup>2</sup> The so-called "staircase" phenomenon of stimulation of a muscle is ascribed, probably rightly, also to the formation of acid. This phenomenon, that is, the increase of the amount of contraction with every new stimulus, is, however, comparable to or identical with the increase in the rate of reactions in the experiments described here.

## V

As far back as 1889 I pointed out that the photosensitiveness of an animal is different in different physiological conditions and that, therefore, under natural conditions, heliotropism is found often only in certain developmental stages, or in certain physiological states of an animal. I have already mentioned that in the aphids distinct heliotropic reactions may only be expected when the animals have developed wings and have left the plant. The influence of the chemical changes which take place in animals upon heliotropism is much more distinct in the larvae of *Porthesia chrysorrhoea*. The larvae hatch from the eggs in the fall and, as young larvae, hibernate in a nest. The rising temperature in the spring drives them out of the nest, and they can also be driven out of the nest in winter by an increase in temperature. When driven out of the nest in this condition they are strongly positively heliotropic and I have never found in natural surroundings any animals whose heliotropic sensitiveness was more pronounced than it is in the young larvae of *Chrysorrhoea*. But as soon as the animals have once eaten, the positive heliotropism disappears and does not return even if they are again allowed to become hungry.<sup>1</sup> In this case it is clear that the chemical changes directly or indirectly connected with nutrition lead to a permanent diminution or disappearance of the photochemical reaction. In ants and bees the influence of substances from the sexual organs seems to be the determining factor in the production of positive heliotropism. The ant workers show no heliotropic reactions, while in the males and females, at the time of sexual maturity, a distinct positive heliotropism develops, the intensity of which continues to increase.

It is a well-known fact that during sexual maturity special substances are formed which influence various organs. For

<sup>1</sup> Loeb, *op. cit.*, p. 24. (This latter fact has been overlooked by several writers.)

instance, Leo Loeb has found that the substances which are set free by the bursting of an egg follicle cause a special sensitiveness in the non-pregnant uterus, so that every mechanical stimulus causes the latter to form a decidua. In this way he could cause the formation of any number of deciduae in non-pregnant uteri, while without the circulation of follicle substance in the blood the uterus did not react in this manner.

It is a common phenomenon that animals in certain larval stages are positively heliotropic, while in others they are not sensitive to light or are even negatively heliotropic. I will not discuss these facts further in this place, but refer my readers to my earlier papers.

This change in the heliotropic sensitiveness, produced by certain metabolic products in the animal body, is of great biological significance. I pointed out in former papers that it serves to save the lives of the above-mentioned young larvae of *Chrysorhoa*. When the young larvae are awakened from their winter sleep by the sunshine of the spring they are positively heliotropic. Their positive heliotropism leaves them no freedom of movement, but forces them to creep straight upward to the top of a tree or branch. Here they find the first buds. In this way their heliotropism guides them to their food. Should they now remain positively heliotropic they would be held fast on the ends of the twigs and would starve to death. But we have already mentioned that after having eaten they once more lose their positive heliotropism. They can now creep downward, and the restlessness which is characteristic of so many animals<sup>1</sup> forces them to creep downward until they reach a new leaf, the odor or tactile stimulus of which stops the progressive movement of the machine and sets their eating activity again in motion.

The fact that ants and bees become positively heliotropic at the time of sexual maturity plays an important rôle in the

<sup>1</sup> The physico-chemical cause of this "restlessness" which is noticeable in many insects and crustaceans is at present unknown.



vital economy of these creatures. As is well known, the mating of these insects takes place during the so-called nuptial flight. I found that among the male and female ants of a nest the heliotropic sensitiveness increases steadily up to the time of the nuptial flight and that the direction of their flight follows the direction of the rays of the sun. I gained the impression that this nuptial flight is merely the consequence of a very highly developed heliotropic sensitiveness. The case seems to be similar among the bees according to the following experiment described by Kellogg. The bees were ready to swarm out of the opening of the box used for the experiment when he suddenly removed the dark covering of the box so that the light now entered it from above. The heliotropic sensitiveness of the animals was so great that they crept upward within the box, following the direction of the light rays, and were not able to make the nuptial flight. Thus, according to these observations the bees at the time of the nuptial flight are positively heliotropic machines.

These observations may serve as examples of the way in which the analysis of the vital phenomena of certain animals shows tropisms to be elements of these phenomena. Many observations of a similar nature are found in the papers of Georges Bohn, Parker, Rádl,<sup>1</sup> and myself.

## VI

Under the influence of the theory of natural selection the view has been accepted by many zoologists and psychologists that everything which an animal does is for its best interest. The exact doctrine of heredity, founded by Mendel and advanced to the position of a systematic science in 1900, reduces this idea to its proper value. It is only true that species possessing tropisms which would make reproduction and preservation of the species impossible must die out.

<sup>1</sup> Rádl, *Der Phototropismus der Tiere*, Leipzig, 1903.

Galvanotropism illustrates this fact in a striking manner. If a galvanic current is passed through a trough filled with water, and animals are placed in this trough, it can be observed that an orientation in relation to the direction of the current takes place in many of the animals, and that they move in the direction either of the positive or of the negative current. This phenomenon we call galvanotropism. In galvanotropism the current lines or the current curves play the same rôle as the light rays in heliotropism. At those points where the current curves enter the cells<sup>1</sup> a collection of ions takes place which influences the chemical reactions. The number of species which show typical galvanotropic reactions is not so great as the number of those showing typical heliotropism. In my opinion this difference is the result of the physical difference in the action of light and of the electric current. Light acts essentially upon the free surface of the animal, while the electric current affects all the cells and nerves. Thus the action of the current upon the skin becomes complicated and modified by its simultaneous effect upon the nerve branches and upon the central nervous system. The result is thus much more complicated than that of the action of light where essentially only the effect upon the skin and retina is involved. For this reason, a distinct galvanotropism is found more often in organisms with a simple structure, as, for instance, in unicellular organisms, than in vertebrates, although it is also demonstrable in the latter.

Galvanotropism is, however, purely a laboratory product. With the exception of a few individuals, which have in recent years fallen into the hands of physiologists who happened to be working on galvanotropism, no animal has ever had the chance to come under the influence of an electric current. And yet galvanotropism is a remarkably common reaction among animals. A more direct contradiction of the view that the

<sup>1</sup> Or where the movement of the ions within the cell is retarded.

reactions of animals are determined by their needs or by natural selection could hardly be found.

One might be led to suppose that galvanotropism and heliotropism are not comparable. They are, however, as a matter of fact, phenomena of the same category with the exception of the aforementioned fact, that light acts generally only upon the surface of the skin, while the electric current influences all the cells of the body. As already mentioned, the disturbing complications arising from this latter circumstance disappear for the most part when we work with unicellular organisms, and we should expect that galvanic and heliotropic reactions would more nearly resemble one another in this case, provided that we work with organisms possessing both forms of sensitiveness. And this expectation is fulfilled. The algae of the species *Volvox* show heliotropism and galvanotropism. The investigations made by Holmes and myself upon heliotropism, as well as those of Bancroft upon the galvanotropism of these organisms indicate that the mechanism of these reactions in *Volvox* is the same and the degree of determinism of the heliotropic and galvanotropic reactions in *Volvox* is equally great.

Claparède raises the objection that the galvanotropic reactions are purely compulsory, while the heliotropic reactions are governed by the "interest of the animal."<sup>1</sup> Such a view, however, is not supported by the facts. The reason why heliotropism may occasionally, as we have seen, be of use, while galvanotropism has no biological significance, is because the electric current does not exist in nature. It can, however, be shown also that heliotropism is just as useless to many animals as galvanotropism. For instance, I pointed out twenty years ago that some varieties of animals which do not live in the light at all, for instance, the larvae of the goat moth, which live under the bark of trees, may show positive heliotropism. I found, moreover, that the crab, *Cuma Rathkii*, which lives in the mud of

<sup>1</sup> Claparède, "Les tropismes devant la psychologie," *Journ. f. Psychologie und Neurologie*, XIII, 150, 1908.

the harbor at Kiel, when brought into the light and removed from the mud shows positive heliotropism. It is, therefore, just as incorrect to assert that the heliotropic reactions are

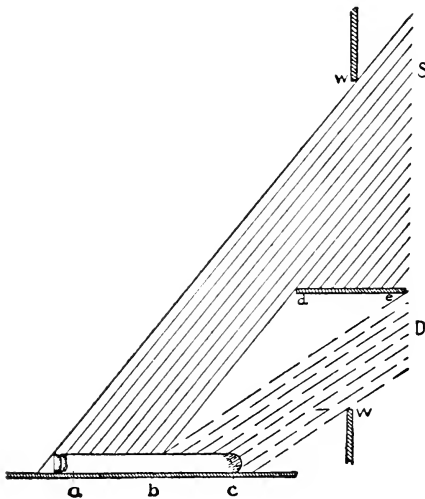

FIG. 21.—Arrangement to prove that positively heliotropic animals move toward the source of light even if by so doing they go from the sunlight into the shade. *W W* is a window through which sunlight *S* falls into the room. By a piece of board *d e* the sunlight *S* is prevented from striking the region *b c* of a table near the window and this part of the table is in the shade. Only the daylight *D* can reach this part of the table.

A test-tube *a c* is put on this table at right angles to the plane of the window. At the beginning of the experiment the animals (e.g., the winged aphides) are all at *a*. The animals move at once toward the window, but instead of remaining at *b* they keep on moving from the direct sunlight into the shade toward the source of light until they all reach the end of the tube *c* near the window (in the shade) where they remain permanently.

invariably reach that intensity of light which is best suited to their well-being. I believe that this is also a suggestion forced upon the investigators by the extreme application of the theory of natural selection. I have made experiments upon a large number of animals, but, with a clear

governed by the biological interests of the animal as that this is true for galvanotropism. We must, therefore, free ourselves at once from the overvaluation of natural selection and accept the consequences of Mendel's theory of heredity, according to which the animal is to be looked upon as an aggregate of independent hereditary qualities.

## VII

The attempt has been made to prove that organisms are attuned to a certain intensity of light and so regulate their heliotropism that they

arrangement of the physical conditions of the experiment, I have never found a single indication of such an adaptation. In every case it has been shown that positively heliotropic animals are positive to any intensity of light above the threshold. Thus winged plant lice or wingless larvae of *Chrysorrhoea* or copepods, which have been made heliotropic by acids, go toward the light whether the source of light is the direct sunlight or reflected light from the sky or weak lamp light, provided that the (threshold) value of the intensity of light required for the reaction is exceeded. Indeed, I have been able to show that positively heliotropic animals also move toward the source of light even if the arrangement is such that by so doing they go from the light into the shadow.<sup>1</sup> I have never observed a "selection" of a suitable intensity of light.

What probably lies behind these interpretations of the "selection of a suitable intensity of light" is the fact that under certain conditions reaction products formed by the photochemical action of light may inhibit the positive heliotropism. I found a very clear instance of this sort in the newly hatched larvae of *Balanus perforatus*, which are positively heliotropic. If they are placed in the light of a quartz mercury lamp (of Heraeus), which is very rich in ultra-violet rays, the positively heliotropic larvae soon become negatively heliotropic. For these experiments the larvae should be placed only in a very shallow depth of sea-water.

Even in a strong light which is not so rich in ultra-violet rays as the light of the mercury lamp, it is sometimes possible to cause positively heliotropic animals to become negatively heliotropic. This is the case, for instance, with the larvae of *Polygordius*. But it would be wrong in this case to speak of an adaptation of the animal to a certain intensity of light.

<sup>1</sup> Quite often without even stopping for a moment. In animals sensitive to differences (see next chapter) a stopping occurs in this experiment in the passing from the light into the shadow, but they go, nevertheless, immediately on in the direction of the source of light. The reader will find a further account of this experiment in my book on *The Dynamics of Living Matter*.

In my opinion it is merely a case where a metabolic product either alters the photochemical action or so influences the central nervous system that the excitation of the retina by the light weakens the tonus of the muscles, instead of strengthening it.

Some of the other mistakes have perhaps also arisen because the writers worked with complicated experimental conditions instead of with simple ones, for instance, because they used a hollow prism filled with ink in order to produce a gradual decrease in the light intensity. In the semidarkness thus produced, the intensity of light often remains beneath or near the threshold of stimulation, and the writers fall victims to that class of errors which we have already pointed out in speaking of the influence of lesser intensities of light.

### VIII

Heliotropic phenomena are determined by the relative rates of chemical reactions occurring simultaneously in symmetrical surface elements of an animal. There is a second class of phenomena which is determined by a sudden change in the rate of chemical reactions in the same surface elements. Reactions to a sudden change in the intensity of light are shown most clearly in marine tube-worms, whose gills are exposed to light. If the intensity of the light in the aquarium is suddenly diminished the worms withdraw quickly into their tubes. A sudden increase in the intensity of light has no such effect. With other forms, for instance, with planarians, a sudden decrease in the intensity of the light causes a decrease in movement. Such animals gather chiefly in parts of the space where the intensity of light is relatively small. I have designated such reactions as the expression of sensitiveness to changes in the intensity of a stimulus ("Unterschiedsempfindlichkeit") differential sensibility, in order to distinguish them from tropisms.<sup>1</sup>

<sup>1</sup> Loeb, "Ueber die Umwandlung positiv heliotropischer Tiere, u.s.w.," *Pflügers Archiv*, 1893. See also the recent investigations of Georges Bohn, *La naissance de l'intelligence*, Paris, 1909; "Les essais et les erreurs chez les étioles de mer," *Bull.*

It is hardly necessary to point out here that the effects of rapid changes in intensity, when they are very marked, can easily complicate and entirely obscure the heliotropic phenomena. In *Hypotricha* and other infusoria this differential sensibility is very pronounced in response to sudden touch or sudden alteration of the chemical medium, and like the tube-worms they thereupon draw back very quickly. Since their locomotor organs are not symmetrical, but are arranged in a peculiar unsymmetrical manner, they do not, after the next progressive movement, return to the former direction of movement, but deviate sideways from it, and it is therefore easy to understand that such animals do not furnish the best material for demonstrating the laws of heliotropism, especially since they possess only a slight photochemical sensitiveness. But Jennings<sup>1</sup> has with special preference used observations on such organisms to argue against the theory of tropisms. Just as the action of a constant current in muscles and nerves is different from that of an intermittent current, so we find an analogous case in the action of light. If we wish to trace all animal reactions back to physico-chemical laws we must take into consideration besides the tropisms not only the facts of the differential sensibility but also all other facts which exert an influence upon the reactions. The influence of that mechanism which we call "associative memory" also belongs in this category, but we cannot discuss this further at this place. The reader is referred to my book<sup>2</sup> as well as to the more recent works of Bohn, *La naissance de l'intelligence*<sup>3</sup> and *La nouvelle psychologie animale*.<sup>4</sup> Let us bear in mind that "ideas" also

*Inst. gen. psychol.*, 1907; "Intervention des réactions oscillatoires dans les tropismes," *Ass. franc. d. Sciences*, 1907.

<sup>1</sup> Jennings, *The Behavior of Lower Organisms*, 1906.

<sup>2</sup> *Comparative Physiology of the Brain and Comparative Psychology*, New York and London, 1900.

<sup>3</sup> Paris, "Bibliothèque de philosophie scientifique," 1909.

<sup>4</sup> Paris, "Bibliothèque de philosophie contemporaine," 1911.

can act, much as acids do for the heliotropism of certain animals, namely, to increase the sensitiveness to certain stimuli, and thus can lead to tropism-like movements or actions directed toward a goal.

## IX

Besides light and the electric current, the force of gravity also has an orienting influence upon a number of animals. The majority of such animals are forced to turn their heads away from the center of the earth and to creep upward. It was uncertain for a long time how the orientation of cells in relation to the center of gravity of the earth could influence the rate of the chemical reactions within, but it has been suggested that an enlargement or shifting of the reacting surfaces formed the essential connecting link. If it is assumed that in such geotropically sensitive cells two phases (for instance, two fluid substances which are not at all, or not easily, miscible, or one solid and one fluid substance) of different specific gravities are present, which react upon one another, a reaction takes place at the surfaces of contact. Every enlargement of the latter increases the mass of reacting molecules. A shifting of the surfaces would act in the same manner. Finally, a third possibility remains which could perhaps be realized in plant roots and stems. If in the geotropically sensitive elements two masses of different specific gravity are present, only one of which reacts to the flowing sap in the center or the periphery of the stem, the cells of the upper side of a stem which is laid horizontally will acquire a different rate of reaction from those of the lower side, because in the former the specifically heavier substances are directed toward the center of the stem, while in the latter the specifically lighter ones are directed toward the center. Consequently, one side will grow faster than the other, hence the geotropic bending.<sup>1</sup> In the frog's egg, we can actually demonstrate directly the existence of two substances of different

<sup>1</sup> Chapter on "Tropisms" in *Dynamics of Living Matter*.



specific gravity and can study their behavior, since in this case they are of different color.

In animals it has been observed that orientation toward the center of gravity of the earth often becomes less compulsory when the inner ear has been removed. Mach first pointed out the possibility that the otoliths are responsible for this. He believed that they might press upon the end-organs of the sensory nerves and every change of pressure might cause a correction of the position of the animal. It is generally assumed that this view has been verified by experiment but I cannot entirely agree with it although I once described experiments which seemed to support Mach's otolith theory. I had found that when the otoliths of the inner ear of the shark are scraped out with a sharp spoon the normal orientation of the animal suffers; but if the otoliths are simply washed out from the inner ear by a weak current of sea-water the orientation does not so easily suffer.

In the latter case, it is doubtful whether all the otolith powder has been removed from the ear. The problem was solved by experiments on flounders, which have only a single large otolith that can easily be removed from the ear. E. P. Lyon carried out these experiments, which showed that no disturbance of the orientation resulted from this operation. We may conclude, therefore, that in my experiments of scraping out the otoliths a disturbance of the orientation occurred, because in so doing the nerve endings in the ears were injured. We have, therefore, no right to maintain that the orientation of animals in relation to the center of gravity of the earth is regulated by the pressure of the otoliths upon the nerve endings, but that this regulation takes place in the nerve endings themselves, and probably, indeed, as a result of the existence there of two different phases of different specific gravity which react upon one another. Through the change of orientation of the cells in relation to the center of gravity of the earth, the two

phases undergo a shifting by means of which a change in the rate of reaction is brought about according to one of the ways described above. Since then I have looked through the literature on the function of the otoliths or statoliths, and have reached the conclusion that all writers who assert that the removal of the otoliths disturbs the geotropic orientation of animals have been victims of the same fallacy as myself. They have injured or removed the nerve endings. In the only case in which a removal of the otoliths without tearing or other injury of the nerve endings can be justifiably assumed, no disturbance of the orientation occurred.

While in my own work I have aimed to trace the complex reactions of animals back to simpler reactions like those of plants and finally to physico-chemical laws, the opposite tendency has lately been gaining influence. Some botanists, namely, Haberlandt, Němec, and F. Darwin, endeavor to show that the relatively simpler reactions of plants may be traced back to the more complex relations found in animals. Instead of deriving the tropic reactions of plants as directly as possible from the law of mass action or the law of Bunsen and Roscoe, they try to show that "sense-organs" exist in the cells of plants and Francé even attributes to the latter a "soul" and "intelligence." I believe that in order to be consistent, these writers ought to base the law of mass action upon the assumption of the existence of sense-organs, souls, and intelligence in the molecules and ions. It is probably unnecessary to emphasize the fact that it is better for the progress of science to derive the more complex phenomena from simpler components than to do the contrary. For all "explanation" consists solely in the presentation of a phenomenon as an unequivocal function of the variables by which it is determined, and if in nature we find a function of two variables, it does not, in my opinion, tend toward progress to assert that this is a case of functions of more than two variables, without furnishing sufficient proof for this assertion.

These writers explain the geotropic reactions of plants by saying that in certain cells starch grains are present which serve the purpose of the otoliths in animals. These starch grains are believed to press upon the sense-organs or nerve endings in the plant cells concerned and the "pressure-sense" of the plant is then supposed to give rise to the geotropic curvature. I have no opposition to offer to the assumption that the starch grains change their position with a change in the position of the cells, and I am also willing to pass over for the present the view that the starch grains form one of the two phases in the cell. But I see no necessity for assuming besides this the existence of intracellular sense-organs which perceive the pressure of the starch grains. This is, in my opinion, an unnecessary complication of simple relations.

## X

The progress of natural science depends upon the discovery of rationalistic elements or simple natural laws. We find that there are two classes of investigators in biology, grouped according to their attitude toward such simple laws or rationalistic elements. One seems to aim at the denial of the existence of such simple laws and every new case which does not fall at once under such a law offers an opportunity for them to point out the inadequacy of the latter. The other group of investigators aims to discover and not to disprove laws. When such investigators have discovered a simple law which is generally applicable, they know that an apparent exception does not necessarily overthrow the law, but that possibly an opportunity is offered for a new discovery and an extension of the old law. Mendel's laws have been brilliantly confirmed in a number of cases. In some cases of apparent deviations (from these laws), however, it has not always been possible at once to recognize the cause. One group of investigators has recognized that these deviations do not indicate the incorrectness of Mendel's laws, but that they are merely the

result of secondary and often minor complications; the latter investigators have from this standpoint made further fruitful discoveries. The rôle of the other group of investigators in this case has consisted, primarily, in an attempt to minimize the importance of Mendel's laws and thus to retard the progress of science.

The case is similar in the realm of tropisms. Tropisms and tropism-like reactions are elements which pave the way for a rationalistic conception of the psychological reactions of animals and I believe, therefore, that it is in the interest of the progress of science to develop further the theory of animal tropisms. The fact that in an electric current the same animal often moves differently from what it does under the influence of light finds its explanation for the observer conversant with physical chemistry in the fact that the electric current causes changes in the concentration of ions within, as well as upon the surface, while the chemical action of light is essentially limited to the surface. Certain writers, however, leave this difference in the action of the two agents out of consideration and make use of the difference in the behavior of certain organisms in response to light and to the electric current, to assert that it is not permissible to speak of tropisms as being governed by general laws; in other words, they say that tropisms are without significance. Animals in general are symmetrically built and the motor elements of the right and left sides of the body usually act symmetrically. Consequently the heliotropic orientation, for instance, comes about as we have already described. There are animals, however, which move sideways, for instance, certain crabs, such as the fiddler crab. Holmes has found that these crustaceans also go sideways toward the light. Jennings draws from this fact the following conclusions: "The symmetrical position is an incident of the reaction, not its essence."

In other words, he uses these observations of Holmes to

indicate that the rôle ascribed to symmetry has no importance for the theory of tropisms. I am, however, inclined to draw another conclusion, namely, that in the fiddler crabs in the first place there is an entirely different connection between the retina and the locomotor muscles from that in other crustaceans, and that, secondly, there is a special peculiarity in regard to the function of the two retinæ whereby they do not act like symmetrical surface elements. I believe that a new discovery may be made here.<sup>1</sup>

## XI

These data may suffice to explain my point of view. To me it is a question of making the facts of psychology accessible to analysis by means of physical chemistry. In this way it is already possible to reduce a set of reactions, namely, the tropisms to simple rationalistic relations. Many animals, because their body structure is not only morphologically, but also chemically, symmetrical, are obliged to orient their bodies in a certain way in relation to certain centers of force, as, for instance, the course of light, an electric current, the center of gravity of the earth, or chemical substances. This orientation is automatically regulated according to the law of mass action. The application of the law of mass action to this set of reactions is thus made possible. I consider it unnecessary to give up the term "comparative psychology," but I am of the opinion that the contents of comparative psychology will under the influence of the above-mentioned endeavors be different from the contents of speculative psychology. But I believe also that the further development of this subject will fall more to the lot of biologists trained in physical chemistry than to the specialists in psychology or zoology, for it is in general hardly

<sup>1</sup> From which I expect, furthermore, that they will only confirm still more the laws of heliotropism. This expectation is based upon analogous relations in the pleuronectids, which I cannot, however, discuss further here. However, probably no one will maintain that the existence of the pleuronectids invalidates all laws in regard to the symmetrical body structure.

to be expected that zoologists and psychologists who lack a physico-chemical training will feel attracted to the subject of tropisms.

In closing let me add a few remarks concerning the possible application of the investigations of tropisms.

I believe that the investigation of the conditions which produce tropisms may be of importance for psychiatry. If we can call forth in an animal otherwise indifferent to light by means of an acid a heliotropism which drives it irresistibly into a flame; if the same thing can be brought about by means of a secretion of the reproductive glands, we have given, I believe, a group of facts, within which the analogies necessary for psychiatry can be called forth experimentally and can be investigated.

These experiments may also attain a similar value for ethics. The highest manifestation of ethics, namely, the condition that human beings are willing to sacrifice their lives for an idea is comprehensible neither from the utilitarian standpoint nor from that of the categorical imperative. It might be possible that under the influence of certain ideas chemical changes, for instance, internal secretions within the body, are produced which increase the sensitiveness to certain stimuli to such an unusual degree that such people become slaves to certain stimuli just as the copepods become slaves to the light when carbon dioxide is added to the water. Since Pawlow and his pupils have succeeded in causing the secretion of saliva in the dog by means of optic and acoustic signals, it no longer seems strange to us that what the philosopher terms an "idea" is a process which can cause chemical changes in the body.

### III. SOME FUNDAMENTAL FACTS AND CONCEPTIONS CONCERNING THE COMPARATIVE PHYSIOLOGY OF THE CENTRAL NERVOUS SYSTEM





### III

#### SOME FUNDAMENTAL FACTS AND CONCEPTIONS CONCERNING THE COMPARATIVE PHYSIOLOGY OF THE CENTRAL NERVOUS SYSTEM<sup>1</sup>

1. The understanding of complicated phenomena depends upon an analysis by which they are resolved into their simple elementary components. If we ask what the elementary components are in the physiology of the central nervous system, our attention is directed to a class of processes which are called reflexes. A reflex is a reaction which is caused by an external stimulus, and which results in a coordinated movement, the closing of the eyelid, for example, when the conjunctiva is touched by a foreign body, or the narrowing of the pupil under the influence of light. In each of these cases, changes in the sensory nerve endings are produced which bring about a change of condition in the nerves. This change travels to the central nervous system, passes from there to the motor nerves, and terminates in the muscle-fibers, producing there a contraction. This passage from the stimulated part to the central nervous system, and back again to the peripheral muscles, is called a reflex. There has been a growing tendency in physiology to make reflexes the basis of the analysis of the functions of the central nervous system, and consequently much importance has been attached to the processes underlying them and the mechanisms necessary for reflex.

The name reflex suggests a comparison between the spinal cord and a mirror. Sensory stimuli were supposed to be reflected from the spinal cord to the muscles; destruction of the spinal cord would, according to this, make the reflex impossible,

<sup>1</sup> Reprinted from Loeb, J., *Comparative Physiology of the Brain and Comparative Psychology* (1899). By courtesy of G. P. Putnam's Sons of New York and London.

just as the destruction of the mirror might prevent the reflection of light. This comparison, however, of the reflex process in the central nervous system with the reflection of light has, long since, become meaningless, and at present few physiologists in using the term reflex think of its original significance. Instead of this, another feature in the conception of the term reflex has gained prominence, namely, the *purposeful* character of many reflex movements. The closing of the eyelid and the narrowing of the pupil are eminently purposeful, for the cornea is thereby protected from hurtful contact with foreign bodies, and the retina from the injurious effects of strong light. Another striking characteristic in such reflexes has also been emphasized. The movements which are produced are so well planned and coordinated that it seems as though some intelligence were at work either in devising or in carrying them out. The fact, however, that even a decapitated frog will brush with its foot a drop of acetic acid from its skin, suggests that some other explanation is necessary. A prominent psychologist has maintained that reflexes are to be considered as the mechanical effects of acts of volition of past generations.<sup>1</sup> The ganglion-cell seems the only place where such mechanical effects could be stored up. It has therefore been considered the most essential element of the reflex mechanism, the nerve-fibers being regarded, and probably correctly, merely as conductors.

Both the authors who emphasize the purposefulness of the reflex act and those who see in it only a physical process have invariably looked upon the ganglion-cell as the principal bearer of the structures for the complex coordinated movements in reflex action.

I should have been as little inclined as any other physiologist to doubt the correctness of this conception had not the establishment of the identity of the reactions of animals and plants to light proved the untenability of this view and at the

<sup>1</sup> A statement for which no trace of experimental proof exists.

same time offered a different conception of reflexes. The flight of the moth into the flame is a typical reflex process. The light stimulates the peripheral sense-organs, the stimulus passes to the central nervous system, and from there to the muscles of the wings, and the moth is caused to fly into the flame. This reflex process agrees in every point with the heliotropic effects of light on plant organs. Since plants possess no nerves and no ganglia, this identity of animal with plant heliotropism can force but one inference—these heliotropic effects must depend upon conditions which are common to both animals and plants. At the end of my book on heliotropism<sup>1</sup> I expressed this view in the following words: “We have seen that, in the case of animals which possess nerves, the movements of orientation toward light are governed by exactly the same external conditions, and depend in the same way upon the external form of the body, as in the case of plants which possess no nerves. These heliotropic phenomena, consequently, cannot depend upon *specific* qualities of the central nervous system.” On the other hand, the objection has been raised that destruction of the ganglion-cells interrupts the reflex process. This argument, however, is not sound, for the nervous reflex arc in higher animals forms the only protoplasmic bridge between the sensory organs of the surface of the body and the muscles. If we destroy the ganglion-cells or the central nervous system, we interrupt the continuity of the protoplasmic conduction between the surface of the body and the muscles, and a reflex is no longer possible. Since the axis cylinders of the nerves and the ganglion-cells are nothing more than protoplasmic formations, we are justified in seeking in them only general protoplasmic qualities, unless we find that the phenomena cannot be explained by means of the latter alone.

2. A further objection has been raised, that although these

<sup>1</sup> Loeb, J., *Der Heliotropismus der Tiere und seine Uebereinstimmung mit dem Heliotropismus der Pflanzen*, Würzburg, 1890. A preliminary note on these experiments appeared January, 1888.

reflexes occur in plants possessing no nervous system, yet in animals where ganglion-cells are present the very existence of the ganglion-cells necessitates the presence in them of special reflex mechanisms. It was therefore necessary to find out if there were not animals in which coordinated reflexes still continued to exist after the destruction of the central nervous system. Such a phenomenon could be expected only in forms in which a direct transmission of stimuli from the skin to the muscle or direct stimulation of the muscle is possible, in addition to the transmission through the reflex arc. This is the case, for instance, in worms and in ascidians. I succeeded<sup>1</sup> in demonstrating in *Ciona intestinalis* that the complicated reflexes still continue after removal of the central nervous system.<sup>2</sup>

A study, then, of comparative physiology brings out the fact that irritability and conductivity are the only qualities essential to reflexes, and these are both common qualities of all protoplasm. The irritable structures at the surface of the body, and the arrangement of the muscles determine the character of the reflex act. The assumption that the central nervous system or the ganglion-cells are the specific bearers of reflex mechanisms cannot hold. But have we now to conclude that the nerves are superfluous and a waste? Certainly not. Their value lies in the fact that they are quicker and more sensitive conductors than undifferentiated protoplasm. Because of these qualities of the nerves, an animal is better able to adapt itself to changing conditions than it possibly could if it had no nerves. Such power of adaptation is absolutely necessary for free animals.

3. While some authors explain all reflexes on a psychical basis, the majority of investigators explain in this way only a

<sup>1</sup> Loeb, J., *Untersuchungen zur physiologischen Morphologie der Tiere*, II, Würzburg, 1892.

<sup>2</sup> This animal closes the oral opening when we touch it. This is a reflex comparable to the closing of the eyelid if we touch the cornea. The central nervous system of the animal consists of one ganglion. When the latter is removed the oral opening still closes upon mechanical stimulation.

certain group of reflexes—the so-called instincts. Instincts are defined in various ways, but no matter how the definition is phrased the meaning seems to be that they are inherited reflexes so purposeful and so complicated in character that nothing short of intelligence and experience could have produced them. To this class of reflexes belongs the habit possessed by certain insects of laying their eggs on the material which the larvae will afterward require for food. When we consider that the female fly pays no attention to her eggs after laying them, we cannot cease to wonder at the seeming care which nature takes for the preservation of the species. How can the action of such an insect be determined if not by mysterious structures which can only be contained in the ganglion-cells? How can we explain the inheritance of such instincts if we believe it to be a fact that the ganglion-cells are only the conductors of stimuli? It was impossible either to develop a mechanics of instincts or to explain their inheritance in a simple way from the old standpoint, but our conception makes an explanation possible. Among the elements which compose these complicated instincts, the tropisms (heliotropism, chemotropism, geotropism, stereotropism) play an important part. These tropisms are identical for animals and plants. The explanation of them depends first upon the specific irritability of certain elements of the body-surface, and, second, upon the relations of symmetry of the body. Symmetrical elements at the surface of the body have the same irritability; unsymmetrical elements have a different irritability. Those nearer the oral pole possess an irritability greater than that of those near the aboral pole. These circumstances force an animal to orient itself toward a source of stimulation in such a way that symmetrical points on the surface of the body are stimulated equally. In this way the animals are led without will of their own either toward the source of the stimulus or away from it. Thus there remains nothing for the ganglion-cell to do but to conduct the stimulus, and

this may be accomplished by protoplasm in any form. For the inheritance of instincts it is only necessary that the egg contain certain substances—which will determine the different tropisms—and the conditions for producing bilateral symmetry of the embryo. The mystery with which the ganglion-cell has been surrounded led not only to no definite insight into these processes, but has proved rather a hindrance in the attempt to find the explanation of them.

It is evident that there is no sharp line of demarkation between reflexes and instincts. We find that authors prefer to speak of reflexes in cases where the reaction of single parts or organs of an animal to external stimuli is concerned; while they speak of instincts where the reaction of the animal as a whole is involved (as is the case in tropisms).

4. If the mechanics of a number of instincts is explained by means of the tropisms common to animals and plants, and if the significance of the ganglion-cells is confined, as in all reflex processes, to their power of conducting stimuli, we are forced to ask what circumstances determine the coordinated movements in reflexes, especially in the more complicated ones. The assumption of complicated but unknown and perhaps unknowable structures in the ganglion-cells served formerly as a convenient terminus for all thought in this direction. In giving up this assumption, we are called upon to show what conditions are able to determine the coordinated character of reflex movements. Experiments on galvanotropism of animals suggest that a simple relation may exist between the orientation of certain motor elements in the central nervous system and the direction of the movements of the body which is called forth by the activity of these elements. This perhaps creates a rational basis for the further investigation of coordinated movements.<sup>1</sup>

<sup>1</sup> Since this was written von Uexkuell found a law which will go far in explaining the mechanism of coordination, namely, that a stretched muscle shows an increased irritability while the contracted muscle shows a decreased irritability. Since

5. We must also deprive the ganglion-cells of all specific significance in spontaneous movements, just as we have done in the case of simple reflexes and instincts. By spontaneous movements we mean movements which are apparently determined by internal conditions of the living system. Strictly speaking, no movements of animals are exclusively determined by internal conditions, for atmospheric oxygen and a certain range of temperature are always necessary in order to preserve the activity beyond a short period of time.

We must discriminate between simple and conscious spontaneity. In simple spontaneity we must consider two kinds of processes, namely, aperiodic spontaneous processes and rhythmically spontaneous or automatic processes. The rhythmical processes are of importance for our consideration. Respiration and the heart beat belong in this category. The respiratory movements seem to indicate that automatic activity *can* arise in the ganglion-cells, and from this the conclusion has been drawn that all automatic movements are due to specific structures of the ganglion-cells. Recent investigations, however, have transferred the problem of rhythmical spontaneous contractions from the field of morphology into that of physical chemistry. The peculiar qualities of each tissue are partly due to the fact that it contains certain ions (Na, K, Ca, and others) in definite proportions. By changing these proportions, we can impart to a tissue properties which it does not ordinarily possess. If in the muscles of the skeleton the Na ions be increased and the Ca ions be reduced, the muscles are able to contract rhythmically like the heart. It is only the presence of Ca ions in the blood which prevents the muscles of our skeleton from beating rhythmically in our body. As the muscles contain no ganglion-cells, it is certain that the power of rhythmical spontaneous contractions is not due to the specific

the contraction of one group of muscles necessitates the stretching of their antagonists the coordinated character of locomotive action seems to become intelligible (1912).

morphological character of the ganglion-cells, but to definite chemical conditions which are not necessarily confined to ganglion-cells.<sup>1</sup>

The coordinated character of automatic movements has often been explained by the assumption of a "center of coordination," which is supposed to keep a kind of police watch on the different elements and see that they move in the right order. Observations in lower animals, however, show that the coordination of automatic movements is caused by the fact that that element which beats most quickly forces the others to beat in its own rhythm. Aperiodic spontaneity is still less a specific function of the ganglion-cell than rhythmical spontaneity. The swarm spores of algae, which possess no ganglion-cells, show spontaneity equal to that of animals having ganglion-cells.

6. Thus far we have not touched upon the most important problem in physiology, namely, which mechanisms give rise to that complex of phenomena which are called psychic or conscious. Our method of procedure must be the same as in the case of instincts and reflexes. We must find out the elementary physiological processes which underlie the complicated phenomena of consciousness. Some physiologists and psychologists consider the purposefulness of the psychic action as the essential element. If an animal or an organ reacts as a rational human being would do under the same circumstances, these authors declare that we are dealing with a phenomenon of consciousness. In this way many reflexes, the instincts especially, are looked upon as psychic functions. Consciousness has been ascribed even to the spinal cord, because many of its functions are purposeful. We shall see in the following chapters that many of these reactions are merely tropisms which may occur in exactly the same form in plants. Plants must therefore have a psychic life, and, following the argument, we must ascribe it to machines also, for the tropisms depend

<sup>1</sup> Loeb, J., *American Journal of Physiology*, III, 327 and 383, 1900.



only on simple mechanical arrangements. In the last analysis, then, we would arrive at molecules and atoms endowed with mental qualities. We can dispose of this view by the mere fact that the phenomena of embryological development and of organization in general show a degree of purposefulness which may even surpass that of any reflex or instinctive or conscious act. And yet we do not consider the phenomena of development to be dependent upon consciousness.

On the other hand, physiologists who have appreciated the untenable character of such metaphysical speculations have held that the only alternative is to drop the search for the mechanisms underlying consciousness and study exclusively the results of operations on the brain. This would be throwing out the wheat with the chaff. The mistake made by metaphysicians is not that they devote themselves to fundamental problems, but that they employ the wrong methods of investigation and substitute a play on words for an explanation by means of facts. If brain physiology gives up its fundamental problem, namely, the discovery of those elementary processes which make consciousness possible, it abandons its best possibilities. But to obtain results, the errors of the metaphysician must be avoided and explanations must rest upon facts, not words. The method should be the same for animal psychology that it is for brain physiology. It should consist in the right understanding of the fundamental process which recurs in all psychic phenomena as the elemental component. *This process, according to my opinion, is the activity of the associative memory, or of association.* Consciousness is only a metaphysical term for phenomena which are determined by associative memory. By associative memory I mean that mechanism by which a stimulus brings about not only the effects which its nature and the specific structure of the irritable organ call for, but by which it brings about also the effects of other stimuli which formerly acted upon the organism almost or quite

simultaneously with the stimulus in question.<sup>1</sup> If an animal can be trained, if it can learn, it possesses associative memory. By means of this criterion it can be shown that Infusoria, Coelenterates, and worms do not possess a trace of associative memory. Among certain classes of insects (for instance, ants, bees, and wasps), the existence of associative memory can be proved. It is a comparatively easy task to find out which representatives of the various classes of animals possess, and which do not possess, associative memory. Our criterion therefore might be of great assistance in the development of comparative psychology.

7. Our criterion puts an end to the metaphysical ideas that all matter, and hence the whole animal world, possesses consciousness. We are brought to the theory that only certain species of animals possess associative memory and have consciousness, and that it appears in them only after they have reached a certain stage in their ontogenetic development. This is apparent from the fact that associative memory depends upon mechanical arrangements which are present only in certain animals, and present in these only after a certain development has been reached. The fact that certain vertebrates lose all power of associative memory after the destruction of the cerebral hemispheres, and the fact that vertebrates in which the associative memory either is not developed at all or only slightly developed (e.g., the shark or frog) do not differ, or differ but slightly, in their reactions after losing the cerebral hemispheres, support this view. The fact that only certain animals possess the necessary mechanical arrangements for associative memory, and therefore for consciousness, is not stranger than the fact that only certain animals possess the mechanical arrangements for uniting the rays from a luminous point in one point on the retina. The liquefaction of gases is an example of a sudden

<sup>1</sup> Loeb, J., "Beiträge zur Gehirnphysiologie der Würmer," *Pflügers Archiv*, LVI, 247, 1894.

change of condition which may be produced when one variable is changed; it is not surprising that there should be sudden changes in the ontogenetic and phylogenetic development of organisms when there are so many variables subject to change, and when we consider that colloids easily change their state of matter.

It becomes evident that the unraveling of the mechanism of associative memory is the great discovery to be made in the field of brain physiology and psychology. But at the same time it is evident that this mechanism cannot be unraveled by histological methods, or by operations on the brain, or by measuring reaction times. We have to remember that all life phenomena are ultimately due to motions or changes occurring in colloidal substances. The question is, Which peculiarities of the colloidal substances can make the phenomenon of associative memory possible? For the solution of this problem the experience of physical chemistry and of the physiology of the protoplasm must be combined. From the same sources we must expect the solution of the other fundamental problems of brain physiology, namely, the process of conduction of stimuli.



IV. .PATTERN ADAPTATION OF FISHES AND THE  
MECHANISM OF VISION



## IV

### PATTERN ADAPTATION OF FISHES AND THE MECHANISM OF VISION<sup>1</sup>

The mechanism of the action of the brain is entirely unknown to us. We are unable to look into the active brain and the objective results of brain action are in general so different in their nature from the external stimulus which leads to the action that we are prevented in most cases from drawing any conclusions concerning the nature of the processes occurring in the brain.

From results obtained in experiments on dogs Munk stated years ago that there existed a projection of the retina on a part of the cortex which he had designated as the visual sphere and that the extirpation of definite parts of this sphere caused blindness in definite parts of the retina. I repeated these experiments but was not able to confirm his statements. Henschen has recently, however, furnished the proof, on the basis of excellent pathological observations on man, that such a projection after all exists, but that it is situated in another part of the cortex from where Munk had believed it to be, namely, in the area striata. Minkowski was able to confirm Henschen's conclusions through experiments on dogs. These observations and experiments suggest the possibility that in vision an image is formed not only on the retina but also on the cortex.

The possibility that vision is based on the formation of an image in the brain is supported by a group of facts which to my knowledge have never received any consideration in this connection.

<sup>1</sup> Reprinted from *Physiologisches Centralblatt*, XXV, No. 22, 1912. This note is given merely as a suggestion concerning the mechanism underlying certain brain processes.

It has been known for some time that many animals, especially certain fishes, adapt their color and pattern to the ground upon which they happen to be. This fact has been extensively utilized for the theory of natural selection. It seems to me that the same facts furnish also the proof that an image of the objects is formed in the brain. Pouchet many years ago showed that the adaptation of fishes to the ground ceases as soon as their eyes are removed or as soon as the formation of retinal images is prevented through the turbidity of the refractive media of the eye. This fact (confirmed by many observers) proves that the harmony between color and pattern of the skin of fishes with their surroundings is transmitted through the retinal image; in other words, that the so-called adaptation of fishes to their surroundings is only the transmission of the retinal image to the skin.

It has, moreover, been shown that the destruction of the optic fibers and the optic ganglia in the brain acts like the extirpation of the eyes; and finally it has been proved that the cutting of the sympathetic fibers which go to the pigment cells of the skin also prevents the formation of a picture of the ground on the skin. Hence we know the path by which the retinal image is transferred to the skin of fishes. One station is the ending of the optic fibers in the brain. Since we are able to prove the existence of an image of the object on the retina of fishes; since it is proved that the image on the skin of the fish is a picture of the retinal image but not of the object (in this case the ground) itself; since, moreover, the transmission of the retinal image upon the skin takes place through the optic nerve, it follows that the image must pass the central stations of the optic nerve during the transmission to the skin.

An image consists of a number of points of different intensity of light, the mutual arrangement of which is definite and characteristic for the object. Sumner has shown that certain fishes are able to reproduce on their skin rather complicated



patterns (e.g., a chess board), which form the bottom of the aquarium. This reproduction of the pattern is somewhat imperfect, but if we deduct the secondary disturbing factors the fact remains that the pattern on the skin is a tolerably true picture of the pattern of the ground. There exists, therefore, a definite arrangement of the images of the different luminous points of the ground on the retina and a similar arrangement of the images of the luminous points on the skin of the fishes. We may consider each point of the retinal image as a luminous or a stimulating point which produces a corresponding image point in the primary optic ganglia through the action of the nerve-fiber through which it is connected with the ganglia. Every image point in the primary optic ganglia may be considered again as a luminous or stimulating point which through the mediation of a special nerve-fiber influences an individual chromatophore or a small group of chromatophores of the skin. Considering the fact that the retina is a mosaic, we cannot well imagine the transmission of the retinal image upon the skin in any other way than by assuming that the relative arrangement of the individual points of the retinal image is preserved in the optic fibers and the end ganglia of the optic nerve. Under this assumption a relative distribution of the stimulating intensities must occur in the primary optic ganglion which corresponds to the distribution of the image points on the retina and which again can be called an image.

These observations in fish and the conclusions drawn in this note suggest the idea that vision is a kind of telephotography.



V. ON SOME FACTS AND PRINCIPLES OF  
PHYSIOLOGICAL MORPHOLOGY



## V

### ON SOME FACTS AND PRINCIPLES OF PHYSIOLOGICAL MORPHOLOGY<sup>1</sup>

#### I. HETEROMORPHOSIS<sup>2</sup>

The various organs of the higher animals have a definite arrangement; from the shoulders arms originate, from the hips legs, but we never see legs growing out from the shoulders or arms from the hips. In the lower animals the same definite arrangement of organs exists.

Fig. 22 gives a diagram of a hydroid, *Antennularia anten- nina*, which is quite common in the Bay of Naples. From a bundle of roots or stolons a straight stem arises to a height of six inches or more. From this main stem originate, in regular succession, short and slender branches, which carry polyps on their upper sides.

In this animal we never find a root originating at the apex, or in place of a branch, or polyps originating on the under side of a branch.

In observing these phenomena the question arose: What are the circumstances which determine that only one kind of organ shall originate at certain places in the body? It occurred to me that the answer to this question might be obtained by finding out first of all whether or not it were possible to make any desired organ of an animal grow at any desired place. In case this could be done, the question to be decided was whether the same circumstances by which the arrangement of organs can be changed experimentally also determine the arrangement of

<sup>1</sup> Reprinted from Biological Lectures delivered at the Marine Biological Laboratory of Woods Hole, 1893, by courtesy of Ginn & Co.

<sup>2</sup> *Untersuchungen zur physiologischen Morphologie der Tiere*. I, Heteromorphosis, Würzburg, 1891. II, Organbildung und Wachstum, Würzburg, 1892. Translated in *Studies in General Physiology*.

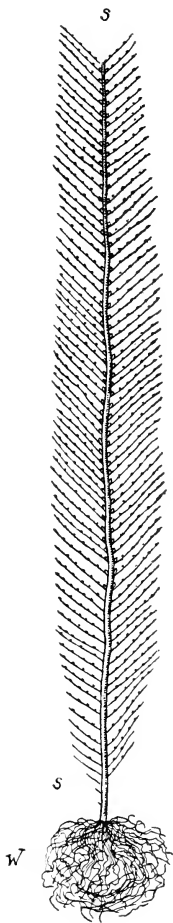

FIG. 22.—A piece of the normal stem of *Antennularia antennina*, a hydroid of the Bay of Naples. Approximately natural size. *S S*, stem. *W*, stolons or roots.

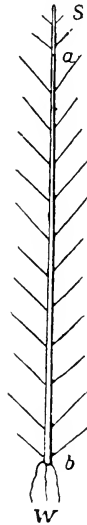

FIG. 23.—Diagram of normal regeneration if a piece *ab* of *Antennularia* is hung up vertically in the water. The piece forms roots *W* at the lower end *b* and a new stem *S* at the upper end *a*. The old normal arrangement of organs is thus restored through the process of regeneration.



FIG. 24.—Diagram of heteromorphic regeneration in *Antennularia*. A piece *ab* cut out of the stem is hung up in an inverted position, i.e., the root end *b* upward and the stem end *a* downward. In this case the apical end *a* forms roots *W*, and the basal end *b* forms a new stem *S* which grows upward.

organs in the natural development. The hydroid, *Antennularia antennina*, above mentioned, seemed to afford a suitable subject for experimentation in an attempt to solve this problem and the following simple experiments were performed.

A piece *ab* (Fig. 23) of an *Antennularia* was cut out and hung up vertically in the water of the aquarium, the apical end *a* above and the root end *b* below. It was found that after a few days the root end *b* had formed little roots, *W*, which

grew downward, and the apical end, *a*, had formed a new stem, *S*.

A similar piece was cut out from another specimen and was hung upside down in the aquarium (Fig. 24). The root end *b*, which was now above, formed a new stem, *S*, and the apical end *a*, which was below, formed roots, *W*. In the newly formed stem the arrangement of the organs was the same as in the normal animal, namely, the branches which were growing

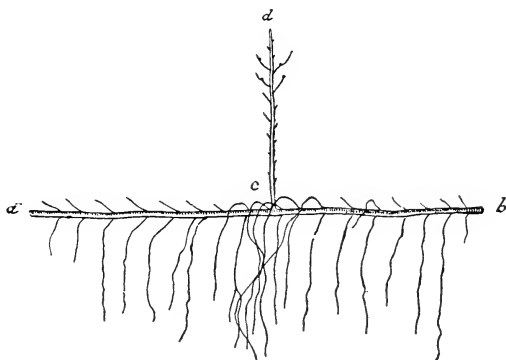

FIG. 25.—From nature. Regeneration of a piece *a b* cut out from the stem of *Antennularia* and put horizontally into the water. The branches on the lower side which had ceased to grow, grow downward as stolons and attach themselves to solid bodies. On the upper side a new stem *c d* grows vertically upward.

obliquely upward bore polyps on their upper side. From this we see that it was possible to substitute a root for a stem and an apex for a root. This phenomenon of the substitution of one organ for another I termed heteromorphosis. If the excised piece of an *Antennularia* was placed horizontally instead of vertically in the aquarium, something still more remarkable occurred, namely, the branches on the lower side suddenly began to grow vertically downward, and these downward growing elements were no longer branches but roots (Fig. 25). This could be proved by their physiological reactions, for the roots attach themselves to the surface of solid bodies, e.g., the glass

of the aquarium, while the stems never show such a reaction. These new parts growing out from the branches of the under side of the stem attached themselves to the solid bodies with which they came in contact. Moreover, they were positively geotropic (that is, they grew toward the center of the earth),

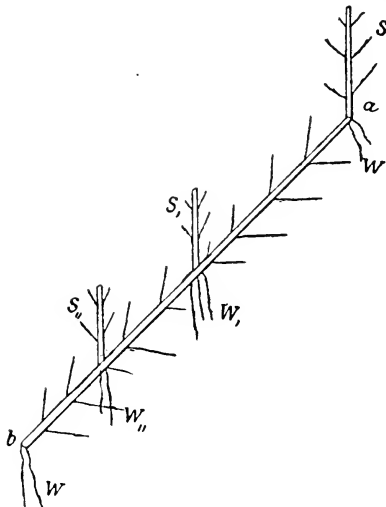

FIG. 26.—Diagrammatic regeneration in a piece *a b* of a stem of *Antennularia* put obliquely into the water. On the upper side of the stem *a b* new stems *S*, *S'*, *S''*, *S'''* grow vertically upward, while at the lower end of the piece *a b* opposite the new stems roots *W*, *W'*, *W''*, *W'''* grow out.

This influence of gravitation is found only in *Antennularia antennina*, not in other forms of *Antennularia*.

while the branches never showed any positive geotropism. The branches on the upper side were not transformed into roots. They either perished or gave rise to long, slender, perfectly straight stems, which grew vertically upward. These stems, as a rule, were too slender to bear branches, but at parts of the upper surface of the main stem there originated new stems (*c d*, Fig. 25), which grew vertically upward and produced the typical little branches bearing polyps.

If we brought the stem into an oblique position (Fig. 26), with the apex *a* upward, from every element of the main stem new stems and roots originated, but with this difference, that stems always originated from the upper side of an element and roots from its lower side. If the stem were placed in an oblique position, with the root end above, the branches on the under side grew out as roots, and at the upper end a stem arose as usual.



What circumstances had all these experiments in common? The stems always originated from the upper end or side of an element, and roots always from the lower side or end of the same element. These facts can be explained only on the assumption that in this case gravitation determines the place of origin of organs.

Now we may ask whether the action of this force, gravitation, is also responsible for the natural arrangement of the organs in this form, namely, that roots appear only at the base of the stem and never at the apex or in the place of a branch. I believe that this is the case. By reason of its negative geotropism, the stem grows vertically upward. Gravitation does not permit roots to arise at any place except at the under side of the organs, and that is, under normal conditions, at the base of the stem. The same force determines that polyps can originate only on the upper side of branches, and thus the general arrangement of organs is brought about by gravitation. But how does gravitation determine that stems grow on the upper and roots at the under side? This is a question to which we shall return later.

Fig. 27 gives a drawing of an example of heteromorphosis in *Margelis*, a hydroid common at Woods Hole, upon which another set of experiments was carried on. If we cut off a stem, or a small piece of a stem of this hydroid, and place it in a dish containing sea-water, protecting it carefully from every motion, a curious change takes place in the organism. Almost all, and in some cases all, of the stems which touch the glass give rise to roots that spread out and very soon cover a large area of the glass. In this way the apical end of a stem may continue to grow as a totally different organ, namely, as a root. Every organ not in contact with some solid body gives rise to polyps. Even the main root, if not in contact with a solid body, no longer grows as a root, but gives rise to a great number of small polyps which appear at the end of long stems. Fig. 27, which Mr.

Tower was kind enough to draw for me, shows a branch which formed roots at its apex and polyps at its roots in this manner.

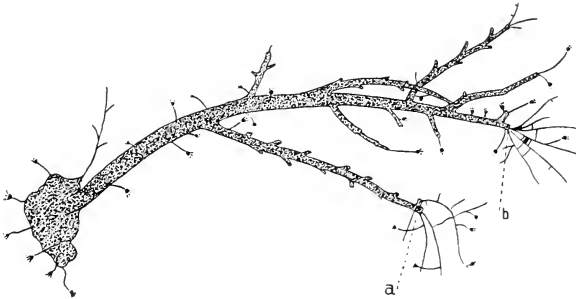

FIG. 27.—Heteromorphosis in *Margelis*, a hydroid. At *a* and *b*, where the points of stems touch the ground of the aquarium, new roots or stolons grow out.

The stem touched the bottom of the dish with the apical ends, *a* and *b*. All these ends gave rise to roots. From the upper side of the original root, which was not in contact with the



FIG. 28.—Heteromorphosis in *Pennaria*. A piece *a b* of this hydroid was cut out and put into a jar with sea-water. The ends *a* and *b* touched the bottom of the jar. At both points new roots grew out.

glass, later on small polyps grew out. Every place which was in contact with solid bodies gave rise to roots, and every place which was in contact with sea-water gave rise to polyps.

This is not the only species of hydroid found at Woods Hole

in which such forms of heteromorphosis can be produced. Another form, *Pennaria*, is just as favorable. In *Pennaria* I succeeded repeatedly in producing roots at both ends of a small stem that bore no polyps (Fig. 28).<sup>1</sup>

In these experiments on *Margelis* and *Pennaria* organs brought into contact with solid bodies continue to grow as roots, if they grow at all. Organs surrounded on all sides by water continue to grow in the form of polyps, if they grow at all. In *Margelis*, contact with a solid body plays the same rôle as did gravitation in the case of *Antennularia*. In what way the contact may have an influence shall be mentioned later on, but here one more point may be mentioned. In *Antennularia*, gravitation not only determines the place of origin of the various organs, but also the direction of their growth; the stem, growing upward, is negatively geotropic, the root, growing downward, is positively geotropic. In *Pennaria*, the nature of the contact not only determines the place of origin of the various organs, but also the direction of their growth. If we bring an outgrowing polyp of *Pennaria* into contact with a solid body, the polyp begins to grow away from the body, and the new stem is very soon nearly perpendicular to the part of the surface with which it came into contact.

I have called this form of irritability stereotropism. We

<sup>1</sup> In a Tubularian I was able to produce the opposite result, namely, to get an animal that ended at both ends in a polyp and had no root. Weismann seems to assume, in his *Germ Plasm*, that the latter result is to be explained by the principle of natural selection, inasmuch as an animal without polyps could not continue to live, and hence it would be impossible to produce roots at both ends. In *Pennaria* this supposed impossibility was realized; one may say that these roots in *Pennaria* may give rise later on to polyps. In the special case that I observed they did not, although as a rule they do; but the same is the case in *Tubularia*, in which polyps also arise from the roots. It might be said, perhaps, that the formation of roots in *Pennaria* is, for some reason, absolutely necessary; but it is just as easy to produce polyps at both ends. Even if it were possible to reconcile these facts with the principles of natural selection, causal or physiological morphology would not gain thereby, as the circumstances that determine the forms of animals and plants are only the different forms of energy in the sense in which this word is used by the physicist, and have nothing to do with natural selection.

may speak of positive stereotropism in the case of the root, and of negative stereotropism in the case of the polyp.

Here, too, we may ask whether the contact with foreign bodies, which in these experiments determines the arrangement of the various organs, may not have the same effect in the natural development of the organism. I believe that such is the case. Negative stereotropism forces the polyps to grow away from the ground into the water, and hence parts surrounded by water form polyps only. Positive stereotropism forces roots in contact with the ground to hold to it, hence parts in contact with the ground give rise to roots only. Thus it happens that, under ordinary circumstances, in this animal we find roots only at the base where it touches the ground. In other hydroids the place of origin of the different organs is determined by light, and in others we find more complicated relations.

It may appear from the foregoing that such cases of heteromorphosis are confined to hydroids, but such is not the case. We find similar cases in *Tunicates*. *Ciona intestinalis*, a solitary ascidian, has eye-spots around the two openings into the pharyngeal cavity. If we make an incision eye-spots are formed on both sides of the incision.<sup>1</sup>

## II. POLARIZATION

While the foregoing experiments were in progress, I observed that in many animals I was unable to produce any kind of heteromorphism. These animals showed, in regard to the formation of organs, a phenomenon with which we are familiar in a magnet. If a magnet is broken into pieces, every piece has its north pole on that side which in the unbroken magnet was directed toward the north. Likewise, there are animals every piece of which produces, at either end, that organ toward

<sup>1</sup> Since this was written phenomena of heteromorphosis have been produced in many animals. Herbst found that in crustaceans an antenna could be caused to be formed in the place of an excised eye, Van Duyne, Bardeen, and Morgan observed phenomena of heteromorphosis in Planarians and so on (1912).

which it was directed in the normal condition. We may speak in such cases of polarization. The clearest example of this I found in an actinian, *Cerianthus membranaceus*.

If we cut a rectangular piece,  $c d e f$ , out of the body-wall of *Cerianthus* new tentacles soon begin to grow out of this piece, but only from the side  $e f$  (Fig. 29), which was directed toward the oral end of the animal.

Nothing of the sort occurs in the side  $c e$ , or  $d c$ , or  $f d$ . The production of tentacles takes place before any other regeneration begins. The same polarization is shown in the following variation of the preceding experiment. If we make an incision,  $a c b$  (Fig. 30),

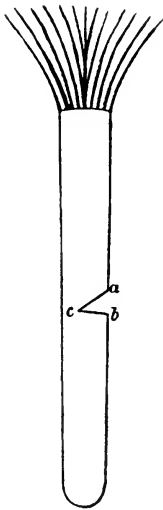

FIG. 30.—Diagrammatic. If an incision  $a c b$  is made into the body of *Cerianthus* new tentacles grow out only from the lower edge  $c b$ .

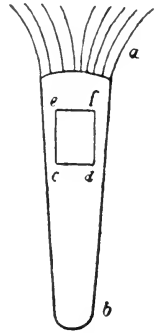

FIG. 29.—Diagrammatic. If a piece  $c d e f$  is cut out from the wall of *Cerianthus*, a sea anemone, new tentacles are formed only at the upper cut  $e f$ .

into the body-wall of the actinian, only the lower lip,  $b c$ , produces tentacles, while the upper lip,  $a c$ , produces none. The two ends heal together in such a way that one-half of a mouth, with its surrounding tentacles,  $b$  (Fig. 31), is formed. It is curious to see how these tentacles behave if we offer them bits of meat. They endeavor to force them into the new oral disc, where the mouth should be, and only after a struggle of some minutes do they give up the futile attempt. I tried in every possible way to produce tentacles in the aboral end of a piece which had been cut out, but without success.

*Hydra* behaves, as regards polarization, a little differently from *Cerianthus*. If we make an incision in the stem, a

whole new oral pole grows out, but otherwise it too shows polarization.

A good many animals, so far as we know, reproduce only the lost organ, but never show any heteromorphism. We see,

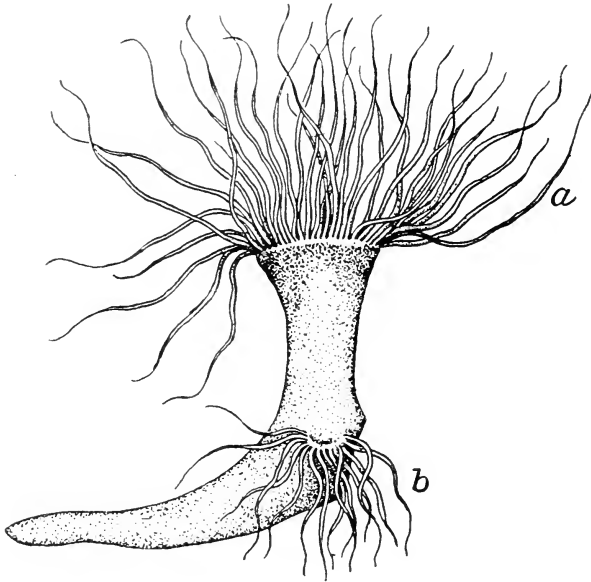

FIG. 31.—From nature. Formation of a second head in *Cerianthus* after a lateral incision at *b*. Only a fraction of the normal number of tentacles are formed corresponding to the fraction of the periphery laid bare by the incision. No new mouth is formed, but if a piece of meat is offered to the group of tentacles at *b* they seize it and press it to the place where a mouth ought to be, showing the purely machine-like character of all these reactions.

therefore, that while in some animals we are able to produce heteromorphosis, in others the most definite polarization exists, and we are able to produce regeneration of lost parts only in the arrangement which exists in the normal animal. In this case we must assume that unknown *internal* conditions determine the arrangement of limbs.

In addition to examples of heteromorphosis or polarization occurring separately, we find cases in which both phenomena

are exhibited by the same animal. If we cut out a sufficiently large piece of the stem of *Tubularia mesembryanthemum*, and place it in the bottom of a dish of water, carefully protected from jarring, the anterior end of the piece gives rise to a new polyp, the posterior end to a root; but if we hang up the stem in such a way that the posterior end does not touch the surface of the glass, and is sufficiently provided with oxygen, this end, too, produces a polyp, and we have a true case of heteromorphosis (Fig. 32). In all cases the polyp at the oral end is formed first, and a relatively long time (one or more weeks) elapses before the aboral polyp is formed. Under one condition, however, I could cause the stem to form a polyp at the aboral as quickly as at the oral end, namely, by inhibiting or retarding the formation of the oral polyp. This could be done readily by diminishing the supply of oxygen at the oral end. In such cases the aboral polyps were produced almost as quickly as the oral polyps.<sup>1</sup>

### III. THE MECHANICS OF GROWTH IN ANIMALS

In order to arrive at an explanation of the phenomena of organization we must ask what the physical forces are that determine the formation of a new organ. We know that the ultimate sources of energy for all the functions of living bodies

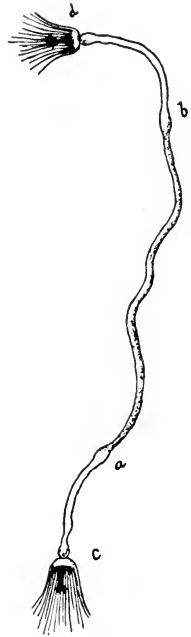

FIG. 32. — Heteromorphosis in *Tubularia*. From nature. The normal *Tubularia* ends at one end in a stolon, at the other in a head or polyp. If a piece *a b* is cut out and suspended in water a new head or polyp *c* and *d* is formed at both ends. We can thus produce an animal which terminates in a head at both ends of its body; while in Fig. 28 an animal was represented which ended at both ends in a stolon or foot.

<sup>1</sup> It was found later independently by both Godlewski and myself that if we ligature the stem of a Tubularian the polyps at both ends are formed simultaneously (1912).

are chemical processes. The question is, How can these chemical forces be brought into relation with the visible changes which take place in the formation of a new organ? The answer to this question is to be obtained by a knowledge of the mechanics of growth. It is very remarkable that the mechanics of growth forms almost an empty page in the history of animal morphology and physiology. I can refer here only to the few experiments I have made on this subject; but fortunately the subject has been worked out very carefully in plants, and as my experiments show that the conditions for growth in animals are, to a certain extent at least, the same as the conditions for growth in plants, we have the beginning of a basis for work.

A brief outline of the manner of growth in plants is as follows: Before the cell grows it forms substances which attract water from the surroundings, or, as the physicist expresses it, it forms substances which determine a higher osmotic pressure within the cell than did the substances from which they originate. The walls of the cell, or rather the protoplasmic layer that lines the cell-wall, possesses peculiar osmotic properties, in consequence of which it allows molecules of water to pass through freely while remaining resistant to the passing through of the molecules of many salts dissolved in the water. The result is that when substances of higher osmotic pressure are formed inside the cell, water from the outside passes in until the pressure within again equals the pressure without. The cell-wall becomes stretched and, according to Traube, new material is precipitated in the enlarged interstices, thus rendering growth permanent. This method of growth is most conspicuous, perhaps, in the germinating seed. The rising temperature in spring produces in the seed substances of higher osmotic pressure (with greater attraction for water) than the substances from which they originate. The result is that water enters the seed; by the pressure of the water within the cells their walls are stretched out and the seed grows. The chemical and



osmotic changes are the sources for the energy which is needed to overcome the resistance to growth.<sup>1</sup>

In order to ascertain whether I could determine what are the mechanical causes of growth in animals, I began at Naples some experiments on *Tubularia mesembryanthemum*. I chose long stems belonging to the same colony and distributed them in a series of dishes containing sea-water of different concentrations. In some of the dishes the concentration had been raised by adding sodium chloride, and in others it had been lowered by adding distilled water. According to the laws of osmosis the amount of water absorbed by the cells of these Tubularians differed with the concentration of the sea-water, the amount being greatest in the most diluted solution and least in the most concentrated solution. If now in reality the mechanics of growth is the same for animals as for plants, we should expect that the more diluted the sea-water the more rapid would be the growth in the Tubularian stem. Of course, finally, a limit is reached where the water begins to have a poisonous effect. It was found, indeed, that within certain limits of concentration the increase in the length of the stems during the same period was greatest in the most diluted and least in the most concentrated sea-water. It is remarkable that the maximum of growth took place not in sea-water of normal concentration, but in more diluted sea-water, though this of course may not be the case in all animals. The following curve (Fig. 33) will give an idea of the dependence of growth upon the concentration of the sea-water in *Tubularia*. The values for the amount of sodium chloride, in 100 cubic centimeters of sea-water, are represented on the axis of the abscissa, the values for the increase in growth on the axis of ordinates.

These and similar experiments, which for lack of space cannot be mentioned here, show that growth in animals is

<sup>1</sup> The substance which is formed and which causes the swelling may be an acid. I found that acids cause a swelling of muscles and it has since been shown that this is a general phenomenon.

determined by the same mechanical forces which determine growth in plants. An obstacle to such a conclusion seems to lie in the fact that many plant-cells have solid walls, while this is not the case in most animal cells. The solid cell-wall, however, does not determine the peculiar character of growth. This character is determined first, by chemical processes within the cell, which result in a higher osmotic pressure, and, secondly, by the osmotic qualities of the outer layer of protoplasm, which

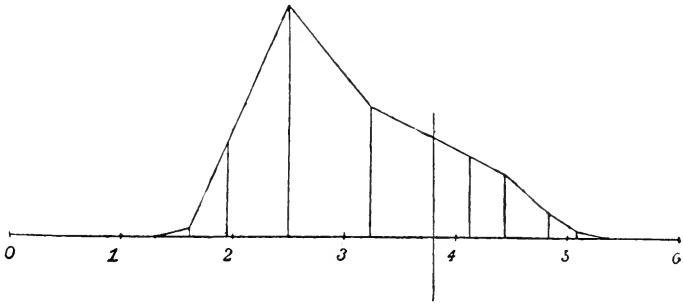

FIG. 33.—Curve representing the influence of diluted sea-water. The abscissae represent the concentrations, the ordinates the corresponding growth in the unit of time. The maximum growth is at a concentration between 2 and 3 per cent of salt, while the normal concentration is indicated by the vertical line between 3 and 4.

allows water to pass through freely, but does not allow all salts dissolved in it to do the same. Both these qualities are independent of the solid cell-wall, and I see no reason why the animal cell should not agree in these two salient features with the plant-cell.

In order that the foregoing explanation of the mechanism of growth in the animal cell might be based only upon known processes, it was necessary to find out whether, in case of growth, chemical processes of such a character take place that substances of higher osmotic pressure are formed than those from which they originate. Everyone knows that by exercise our muscles increase in size. No satisfactory explanation of this fact has

been given. If my interpretation of the method of growth were correct, I must expect that during activity substances are formed in the muscle, which determine a higher osmotic pressure than those from which they originate. This is exactly the case. Ranke had already shown that the blood of a tetanized frog loses water and that this water is taken up by the muscles. In experiments which were carried on by Miss E. Cooke in my laboratory, we were able to show directly that during activity the osmotic pressure inside the cell-wall is raised. We determined the concentration of a solution of NaCl, or rather of a so-called Ringer's mixture, in which the gastrocnemius of a frog neither lost nor took up water. We found that while this concentration for the resting gastrocnemius was about 0.75 per cent to 0.85 per cent, for the gastrocnemius that had been tetanized from twenty to forty minutes it varied from 1.2 per cent to 1.5 per cent.<sup>1</sup>

This increase of osmotic pressure inside the muscle-cell leads, during normal activity, to a taking up of water from the blood and lymph, and the consequence is an increase in volume. The same muscle, as soon as it ceases to be active, begins to decrease in size. Activity, therefore, plays the same rôle in the growth of a muscle that the temperature plays in the growth of the seed.

I tried to ascertain whether segmentation, like growth in general, is influenced by the amount of water contained in the cell. If we decrease the amount of water in the egg of the sea-urchin segmentation is retarded, and if we use a sufficiently high concentration of sea-water it may be stopped entirely. Therefore the amount of water contained in the cell plays still another rôle in the process of organization and influences the process of cell-division.

<sup>1</sup> This increase in osmotic pressure is probably caused by the formation of acid. Two years after the publication of this lecture I showed that the muscle swells in an isosmotic solution if this solution is acid. The recent work of Pauli and Handovski indicates that the swelling is caused through a formation of salt between the acid and a weak base, e.g., a protein. The protein salt is more strongly dissociated than the protein base (1912).

IV. THE ARTIFICIAL PRODUCTION OF DOUBLE AND MULTIPLE MONSTROSITIES IN SEA-URCHINS<sup>1</sup>

The idea that the formation of the vertebrate embryo is a function of growth has been made the basis of the embryological investigations of His. In a masterly way, His has shown how inequality of growth determines the differentiation of organs. In the blastoderm of a chick, for example, the first step in the formation of the embryo is a process of folding. There originates a head fold, a tail fold, a medullary groove, and the system of amniotic folds. According to His, all these processes of folding are due simply to inequalities of growth, the center of the blastoderm growing more rapidly than the periphery. It can be shown, very simply, that such a process of unequal growth must, indeed, lead to the formation of exactly such a system of folds as we find in the blastoderm of a chick. If we take a thin, flat plate of elastic rubber, and lay it on a drawing-board, we can imitate the stronger growth in the center by sticking two tacks into the middle of the rubber, a short distance apart, and then pulling them in opposite directions. In this way we may imitate unequal growth, the center growing faster than the periphery. If we then fix the tacks in the drawing-board, so that the rubber in the middle remains stretched, we get the same system of folds as that shown by the embryo of a chick. I mention this way of demonstrating the effects of unequal growth as the ideas of His are still doubted by some morphologists.

His raised the question, Why is growth different in different parts of the blastoderm? But instead of trying to answer it from the physiological standpoint he answered it from the anatomical standpoint. According to him, the different regions of the unsegmented egg correspond already to the different regions of the differentiated embryo. But this so-called theory

<sup>1</sup> Another method of producing twins from one egg is discussed in the last chapter of this book.

of preformed germ-regions gives no answer to the question, why some parts of the embryo grow faster than others. Nevertheless, it is not necessarily in opposition to the theory of growth offered in the preceding chapter. Starting with the idea of His, we may well imagine that the different regions of the ovum are somewhat different chemically, and that these chemical differences of the different germ-regions determine the differences of growth in the blastoderm. Thus the phenomena of heteromorphosis would show that, in some animals at least, the arrangement of preformed germ-regions may be changed by gravitation, light, adhesion, etc.

It must be asked, however, what, from the standpoint of causal morphology, determines the arrangement of the different germ-regions in the egg. If we answer "heredity," causal morphology can make no use of such an explanation. Our blood has the temperature of about  $37^{\circ}$ , but although our parents had the same temperature, the heat of our blood is not inherited, but is the result of certain chemical processes in our tissues. Still it may be possible that the molecular forces of the chemically different substances of the egg determine a separation of these substances and thereby give rise to the chief directions of the future embryo.

Driesch has shown<sup>1</sup> that by shaking a sea-urchin's egg in the four-cell stage the four cells may be separated, and each one be capable of giving rise to a complete embryo, which differs only in size from the normal embryo. If the theory of preformed germ-regions with its later modifications were true, we should expect that every one of the isolated cells would give rise to one-fourth of an embryo. But it has been said that the artificial isolation of one cleavage-cell causes a process of post-generation or regeneration. Driesch, moreover, changed the mode of the first cleavage by submitting the ovum to one-sided pressure. In this way the nuclei were brought into somewhat

<sup>1</sup> *Zeitschrift f. wissenschaft. Zoologie*, LIII, LV.

different places from those they would have held in the case of normal segmentation. Still, normal embryos resulted. One might object again that the preformation of the germ-regions existed in the protoplasm, and not in the nucleus. I have made a series of experiments to the results of which these objections cannot be made. I shall describe these experiments somewhat fully, as they have not yet been published, though I cannot enter into details at this place.

I brought eggs of a sea-urchin, within ten to twenty minutes after impregnation, into sea-water that had been diluted by the

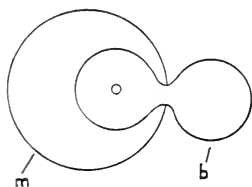

FIG. 34

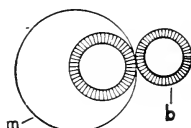

FIG. 35

FIG. 34.—Fertilized egg of a sea-urchin (*Arbacia*) put into dilute sea-water. The protoplasm swells until the membrane *m* bursts and part of the protoplasm *b* flows out; each of the two droplets may develop into a blastula, so that from such an egg two larvae may arise, as indicated in Fig. 35.

addition of about 100 per cent distilled water. In this solution the eggs took up so much water that the membrane (*m*, Fig. 34) burst and part of the protoplasm escaped in the form of a drop (*b*, Fig. 34), which often, however, remained in connection with the protoplasm inside the membrane after the eggs were brought back into normal sea-water. These eggs gave rise to adherent twins, the ejected part *b* of the protoplasm, as well as the part remaining inside the membrane, developing into a normal and perfectly complete embryo. The part of the protoplasm, which at first had connected the two drops, formed the part where the twins remained grown together. Of course, it often happened that, by accident or rapid movement, the twins were separated, and they then developed into perfectly normal single embryos. Since we cannot assume that in every case the

same part of the protoplasm escapes, we must conclude that every part of the protoplasm may give rise to fully developed embryos without regard to preformed germ-regions.<sup>1</sup> In many eggs a repeated outflow of the protoplasm takes place. In such cases each of the drops of the protoplasm may give rise to an embryo, and I obtained not only double embryos, but triplets and quadruplets all grown together.

It is remarkable that the development of these monstrosities goes on nearly at the same rate as that of the normal embryo, provided they are equally well supplied with oxygen and equally protected from microbes and infusoria. The development in most eggs takes place in so regular and typical a manner that it seems as if there were a prearrangement of some kind. It is, however, perfectly well possible that this prearrangement consists in a separation of different liquid substances in the ovum by the molecular qualities of these liquids. Such a separation, of course, might be called a preformation of germ-regions, but it would be something totally different from what is now understood by that term.

#### V. THEORETICAL REMARKS

1. All life phenomena are determined by chemical processes. This is equally the case whether we have to do with the contraction of a muscle, with the process of secretion, or with the formation of an embryo or a single organ. One of the steps that physiological morphology has to take is to show in every case the connecting link between the chemical processes and the formation of organs. I have tried to show that in a few cases at least this connecting link was to be sought in the changes of osmotic pressure determined by the chemical changes which take place in the growing organ.

But this fact alone does not explain why it is that we get

<sup>1</sup> In the light of more recent experiments it is possible, that after all only such pieces can develop into a normal embryo which contain the different germ-regions (1912).

differences in the forms of organs. In order to understand this we must bear in mind that the processes of growth must necessarily be different for different organs, as for example in the formation of a root, and the formation of a stem. As growth is a process in which energy is used up in overcoming the resistance to growth, differences of growth can only be determined either by differences in the amount of energy set free in the growing organ or by differences in resistance. Differences in the energy must be the outcome of differences in the chemical processes which determine growth. Therefore we are led to the idea that differences in the forms of different organs must be determined by differences in their chemical constitution, or, if the chemical constitutions be similar, by differences in resistance to growth. That organs which differ in shape are very often chemically different is a well-known fact. The formation of urea in the liver and the synthesis of hippuric acid by the kidneys are the consequences of chemical differences.

In this way we are led through the mechanics of growth to a conclusion which forms the nucleus of Sachs's theory of organization, namely, "that differences in the form of organs are accompanied by differences in their chemical constitution, and that according to the principles of science we have to derive the former from the latter." According to Sachs there are at least as many "spezifische Bildungstoffe" in a plant as there are different organs.<sup>1</sup>

2. In adopting the theory of Sachs and applying it to animal morphology, we must avoid a mistake very often made even in the case of good theories, namely, the endeavor to explain special cases which are complicated by unknown conditions. Huyghens explained by his theory of light the phenomena of refraction, but he could not and did not attempt to explain the sensations of color. For these phenomena the wave theory of

<sup>1</sup> J. Sachs, *Stoff und Form der Pflanzenorgane*, Gesammelte Abhandlungen, II, 1893.



light remains true, but color sensations depend not only on the wave motion of the ether, but also on the chemical and physical structure of the retina. I think it perfectly safe to say that every animal has specific germ substances, and that the germ substances of different animals differ chemically. Its chemical qualities determine that from a chick's egg only a chick can arise. But it would be a mistake to attempt at present an explanation of how the unknown chemical nature of the germ determines all the different organs and characters that belong to the species. For instance, the yolk sac of the *Fundulus* embryo has a tiger-like coloration. We might say that these markings may be due to a certain arrangement of molecules or complexes of molecules (determinants), which later on give rise to the colored places of the yolk sac, but I found that this coloration originates in a manner much more simple. The pigment cells are formed irregularly on the surface of the yolk. The pigment is chemically closely related to hemoglobin, and so its formation may from the first be connected with the formation of the blood corpuscles. But the arrangement of the pigment cells during the first days of development is not such as to produce any definite markings. They lie upon the walls of the blood-vessels as well as in the spaces between the capillaries (Fig. 36). Later on, however, all of the pigment cells have crept upon the surface of the neighboring blood-vessels (Fig. 38). I succeeded experimentally in showing it to be probable that some of the substances contained in the blood determine this reaction. These substances, if they diffuse from the blood-vessel and touch the chromatophore, make, according to the laws of surface tension, the protoplasm of the chromatophore flow toward and at last over the blood-vessel and form a sheath around it, while the gaps between the blood-vessels become empty of chromatophores. In this way the chromatophores are arranged in stripes, and possibly changes in the surface tension, and not a preformed arrangement of the germ,

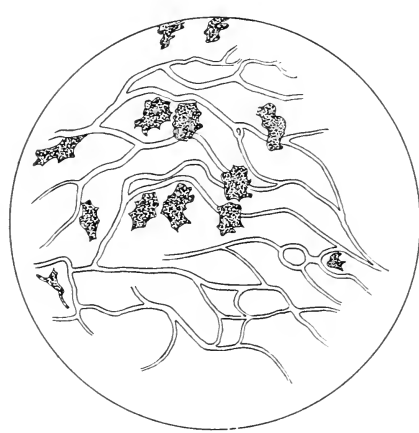

FIG. 36

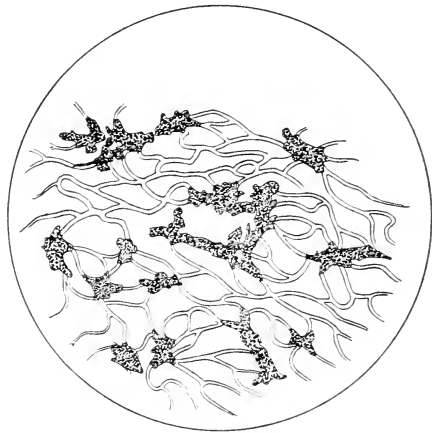

FIG. 37

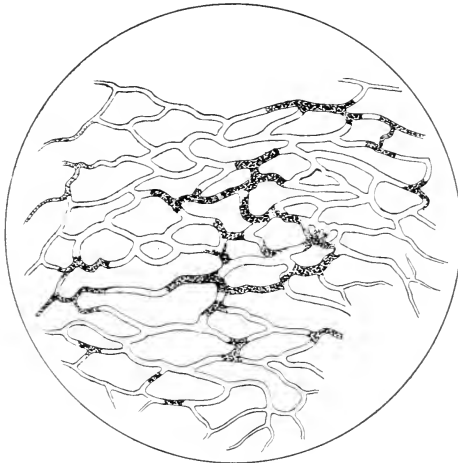

FIG. 38

FIGS. 36, 37, and 38.—From nature. The origin of the pattern on the yolk sac of a fish embryo (*Fundulus heteroclitus*). Fig. 36 is a drawing of the blood-vessels at the surface of the yolk sac at an early stage of development. The black pigment cells show no definite orientation in regard to the blood-vessels. Fig. 37, the same egg a few days later. Here we notice that some pigment cells show a tendency to creep on the blood-vessels. Fig. 38, the same egg still a few days later. The black pigment cells have completely crept on the blood-vessels and formed a sheath around them. The red chromatophores are omitted in this drawing.

This was the first observation proving that tropisms play a rôle in the arrangement of the organs in the body.

determine the marking. We do not know what processes determine the coloration of animals which owe their markings to interference colors, but the task of deriving such a coloration in the adult from a similar arrangement of molecules in the germ plasm would prove too much even for a genius like Huyghens, and without the possibility of such a derivation the theory is of no use.

3. The reasons why roots grow on the under side of the stem of *Antennularia* and stems on the upper side can only be given when the special physical and chemical conditions inside the stem of *Antennularia* have been worked out. At present we can only think of possibilities. It is possible that the hypothetical root substances of Sachs may have a greater specific gravity than the substances which form stems, and therefore take the lowest position in the cell. Since outgrowth can take place only at the free surface of a stem or branch, roots can on this assumption grow only at the under side and stems only at the upper side of an element. But there are still other possibilities which we must omit here. In the case of *Margelis* and other hydroids, it might happen that contact with solid bodies produced an increase of surface in the touched elements in case they contained specific root substances, while the opposite took place in the case of elements containing polyp substances. The consequence would be an increase in the surface of the roots if they came into contact with solid bodies, while polyps only would grow out in the opposite direction. I found, indeed, in some forms at Naples that roots of hydroids which grew free in the water began to grow much faster and to branch off more abundantly when brought into contact with solid bodies. But in these cases we must wait with our attempts at explanation until the physical and chemical conditions for the form are worked out. For the same reasons I will not go into a discussion of the question of what determines the polarization of animals like *Cerianthus*. It may suffice to suggest the possibility

that in polarized animals the tissues or cells may have such a peculiar structure as to allow the specific formative substances to migrate or arrange themselves only in one direction, while in cases of heteromorphosis migration or arrangement in every direction or in several directions is possible.

4. The egg of a sea-urchin under normal conditions gives rise to but one embryo. This circumstance is due simply to the geometrical shape of the protoplasm, which, under normal conditions, is that of a sphere. When we make the eggs burst, the protoplasm outside the egg membrane and that which remains within it assume spherical forms, by reason of the surface tension of the protoplasm. When this happens, as a rule, we get twins, if two separate segmentation cavities are formed, and only one embryo, if both cavities communicate with one another. Whether the first or the second case will happen depends upon the molecular condition of the part of the protoplasm connecting the two drops. Therefore, the number of embryos which come from one egg is not determined by the preformation of germ-regions in the protoplasm, or nucleus, but by the geometrical shape of the egg and the molecular condition of the protoplasm, in so far as these circumstances determine the number of blastulae. In my experiments, I got double or triple embryos when the egg formed two or three droplets or spheres, as every sphere gives rise to a blastula. In Driesch's experiments, one single cell of the four-cell stage necessarily formed a whole embryo after it had been isolated, as it assumed the shape of a single sphere or ellipsoid. Of course, there must be a limit to the number of embryos that can arise from one egg; but the limit is not due to any preformation, but to other circumstances, the chief one being that with too small an amount of protoplasm the formation of a blastula—from merely geometrical reasons, as there must be a minimum size for the cleavage-cells—becomes impossible.<sup>1</sup> Without the

<sup>1</sup> I stated that the minimal size is about one-eighth of the mass of the sea-urchin's egg and I do not think that this is very far off the limit.

formation of the blastula, of course it is not possible to get the later stages which are determined by the blastula.

I have chosen the name Physiological Morphology for these investigations, inasmuch as their object has been to derive the laws of organization from the common source of all life phenomena, i.e., the chemical activity of the cell. In what way this is to be done is indicated in the chapter on the mechanics of growth.

But the aim of Physiological Morphology is not solely analytical. It has another and higher aim, which is synthetical or constructive, that is, to form new combinations from the elements of living nature, just as the physicist and chemist form new combinations from the elements of non-living nature.



VI. ON THE NATURE OF THE PROCESS OF  
FERTILIZATION





## VI

### ON THE NATURE OF THE PROCESS OF FERTILIZATION<sup>1</sup>

#### I

Experimental biology is a very recent science. Not until recently have biologists begun to become conscious of the uncertainty of conclusions which are not tested and verified by adequate experiments.

Leeuwenhook demonstrated in 1677 the existence of motile elements in the sperm, the so-called spermatozoa. He believed that the spermatozoa represented the future embryo. The majority of his contemporaries assumed that the spermatozoa were parasitic organisms which had nothing to do with fertilization. The idea that spermatozoa are not parasites did not subside until it was proved about 160 years later that the spermatozoa originate from the cells of the testes.

That sperm was needed to bring about fertilization of the egg was too obvious a fact to escape even those biologists who never made an experiment, but that the spermatozoa and not the liquid constituents were the essential element in the sperm was a fact which could not be established except experimentally. It was generally assumed that no direct contact between sperm and egg was necessary and that something volatile contained in the sperm, the imaginary "aura seminalis" was sufficient for the act of fertilization. That contact between sperm and egg was really necessary for fertilization was at last proved experimentally by Jacobi (1764) who showed that fish eggs can only be fertilized if the sperm is brought into direct contact with the eggs; and by Spallanzani who put the males of frogs during the act of cohabitation into trousers and convinced

<sup>1</sup> Reprinted from *Biological Lectures* delivered at Woods Hole, 1899, by courtesy of Ginn & Co., Boston.

himself that under such conditions the eggs remained unfertilized although the "aura seminalis" was not prevented from acting upon the eggs. This ended the reign of the "aura seminalis."

It was reserved to two experimenters, Prevost and Dumas (the latter the famous chemist) to prove that the spermatozoa are the essential element in the sperm. They made the simple experiment of filtering the sperm and demonstrated that the sperm whose spermatozoa had been retained by the filter had lost its power of fertilizing the eggs. But even this did not convince many of the descriptive biologists and nine years later K. E. von Baer still expressed the opinion that spermatozoa had nothing to do with fertilization. In 1843 the entrance of the spermatozoon into the egg was directly observed by Barry and this fact has since been verified by an endless number of investigators for the egg of all kinds of animals. It is probably no exaggeration to say that with the general recognition of the experimental method in biology it would probably have taken about as many years as it took centuries to establish the simple fact that the spermatozoon is the essential element in sperm.

The mere observation of the fact that the spermatozoon must enter the egg in order to bring about fertilization did not lead to any understanding of the mechanism of the activation of the egg. Nevertheless four theories or rather suggestions were offered.

The first theory of fertilization is a morphological one. According to this theory, it is the morphological structure of the spermatozoon which is responsible for the process of fertilization.

The second theory is a chemical one. According to this theory it is not a definite morphological or structural element of the spermatozoon, but a chemical constituent, that causes the development of the egg. Against this second view Miescher raised the objection that his investigations showed the same

compounds in the egg and the spermatozoa. I do not believe that this objection is valid. We know that simple variations in the configuration of a molecule have an enormous effect upon life phenomena. This is shown among others by the work of Emil Fischer on the relation between the molecular configuration of sugars and their fermentability. When Miescher made his experiments he was not familiar with such possibilities. Moreover, Miescher was not able to state whether the spermatozoa contain enzymes or not.

A third theory was a physical theory (Bischof). This theory assumes that a peculiar condition of motion exists in the spermatozoon which is transmitted to the egg and causes its development. It should be said, however, that this idea is not so very different from the chemical conception, because it assumes exactly the same for the spermatozoon that Liebig assumes for the enzymes. Liebig thought that the enzymes owed their power of producing fermentation to the motions of certain atoms or groups of atoms.

The fourth conception is the stimulus conception, which was originated by His. According to this conception the egg is considered as a definite machine which if once wound up will do its work in a certain direction. The spermatozoon is the stimulus which causes the egg to undergo its development. It is to be said in connection with this stimulus conception that the main point at issue is omitted as to whether the stimulus carried by the spermatozoon is of a physical or a chemical character, and in this way, of course, the stimulus conception is nothing but a disguised repetition of the chemical or physical theory of fertilization.

All these theories are so vague that we do not need to be surprised that none of them has led to any further discovery. If we want to make new discoveries in biology, we must start from definite facts and observations, and not from vague speculations. Among these observations the most important

are those on parthenogenesis. It had been observed for a long time that the unfertilized egg of the silkworm can develop parthenogenetically. It was, moreover, known that plant lice can give rise to new generations without fertilization. The most impressive fact concerning the parthenogenesis of animals was contributed by Dzierzon, who discovered that the unfertilized eggs of bees develop and give rise to males, while the fertilized eggs give rise to females. Similar conditions seem to exist in wasps. It is, moreover, certain that a few crustaceans show parthenogenesis.

A beginning of parthenogenetic development had been observed in the case of a great many marine animals which develop outside of the female in sea-water. It was found that such eggs when left long enough in sea-water may divide into two or three cells, but no farther. On the other hand, in ovaries of mammals now and then eggs were found that were segmented into a small number of cells.<sup>1</sup> These facts and the occurrence of a certain class of tumors in the ovary, the so-called teratomata, suggest the possibility of at least partial parthenogenesis in the eggs of mammals. But all these phenomena were considered to be of a pathological character. It must be, however, admitted that we cannot utilize these facts with any degree of certainty for the theory of fertilization, as in this case certainty can only be obtained by the experiment. It was not until very recently that such experiments were made.

## II

Eight years ago I observed that if the fertilized eggs of the sea-urchin were put into sea-water whose concentration was raised by the addition of some neutral salt they were not able to segment, but that the same eggs, when put back after they had been in such sea-water for about two hours, broke up into a large number of cells at once instead of dividing successively

<sup>1</sup> Hertwig, O., *Die Zelle und die Gewebe*, p. 239, Jena, 1893.

into two, four, eight, sixteen cells, etc. Of course it is necessary for this experiment that the right increase in the concentration of the sea-water be selected. The explanation of this fact is as follows: The concentrated sea-water brings about a change in the condition of the nucleus which permits a division and a scattering of the chromosomes in the egg.<sup>1</sup> As soon as the egg is put back into normal sea-water it at once breaks up into as many cleavage-cells as nuclei or distinct chromatin masses had been preformed in the egg. Morgan tried the same experiment on the unfertilized eggs of the sea-urchin, and found that the unfertilized egg, if treated for several hours with concentrated sea-water, was able to show the beginning of a segmentation when put back into normal sea-water. A small number of eggs divided into two or four cells, and, in a few cases, went as far as about sixty cells, but no larvae ever developed from these eggs. Morgan<sup>2</sup> had used the same concentration of sea-water as Norman<sup>3</sup> and I had used in our previous experiments. I had added about 2 grams of sodium chloride to 100 c.c. of sea-water. Norman used instead of this 3½ grams of MgCl<sub>2</sub> to 100 c.c. of sea-water, and Morgan used the same concentration. Mead<sup>4</sup> made an observation somewhat similar to Morgan's upon *Chaetopterus*. He found that by adding a very small amount of KCl to sea-water he could force the unfertilized eggs of *Chaetopterus* to throw out their polar bodies. The substitution of a little NaCl for KCl did not have the same effect. While continuing my studies on the effects of salts upon life phenomena, I was led to the fact that the peculiar actions of protoplasm are influenced to a great extent by the ions contained in the solutions which surround the cells. As is

<sup>1</sup> Loeb, J., "Experiments on Cleavage," *Journ. of Morph.*, VII, 1892.

<sup>2</sup> Morgan, T. H., "The Action of Salt Solutions, etc.," *Arch. f. Entwicklungsmechanik*, VIII, 1899.

<sup>3</sup> Norman, W. W., "Segmentation of the Nucleus without Segmentation of the Protoplasm," *Arch. f. Entwicklungsmechanik*, III, 1896.

<sup>4</sup> Mead, A., "The Rate of Cell-Division and the Function of the Centrosome," *Woods Hole Biol. Lect.*, 1898.

well known, if we have a salt in solution, e.g., sodium chloride, we have not only NaCl molecules in solution, but a certain number of NaCl molecules are split up into Na ions (Na atoms charged with a certain quantity of positive electricity) and Cl ions (Cl atoms charged with the same amount of negative electricity). When an egg is in sea-water, the various ions enter it in proportions determined by their osmotic pressure and the permeability of the protoplasm. It is probable that some of these ions are able to combine with the proteins of the protoplasm. At any rate, the physical qualities of the proteins of the protoplasm (their state of matter and power of binding water) are determined by the relative proportions of the various ions present in the protoplasm or in combination with the proteins.<sup>1</sup> By changing the relative proportions of these ions we change the physiological properties of the protoplasm, and thus are able to impart properties to a tissue which it does not possess ordinarily. I have found, for instance, that by changing the amount of sodium and calcium ions contained in the muscles of the skeleton we can make them contract rhythmically like the heart. It is only necessary to increase the number of sodium ions in the muscle or to reduce the number of calcium ions or do both simultaneously.<sup>2</sup> On the basis of this and similar observations I thought that by changing the constitution of the sea-water it might be possible to cause the eggs not only to show a beginning of development but to develop into living larvae, which were in every way similar to those produced by the fertilized egg.

There seemed to be three ways in which this might be accomplished. The first way was a simple change in the constitution of the sea-water without increasing its osmotic pressure. The second way was to increase the osmotic pressure

<sup>1</sup> Loeb, J., "On Ion-Proteid Compounds and Their Rôle in the Mechanics of Life-Phenomena," *Amer. Journ. of Phys.*, III, 1900.

<sup>2</sup> It is due to the Ca ions of our blood that the muscles of our skeleton do not beat rhythmically, like our heart

of the sea-water by adding a certain amount of a certain salt. The third way was by combining both of these methods. The first way did not lead to the result I desired.<sup>1</sup> All the various artificial solutions I prepared had only the one effect of causing the unfertilized egg to divide into a few cells, but I was not able to produce a blastula. I next tried the effects of an increase in the sea-water by adding a certain amount of magnesium chloride. In this case I had no better results than Morgan. Very few eggs began to divide, but these did not develop beyond the first stages of segmentation. I then tried the combination of both methods. The osmotic pressure of ordinary sea-water is roughly estimated to be the same as that of a  $\frac{5}{8}$ n NaCl solution or a  $\frac{1}{8}$ n MgCl<sub>2</sub> solution. I found, after a number of experiments, that by putting the unfertilized eggs of the sea-urchin into a solution of 60 c.c. of  $\frac{2}{8}$ n MgCl<sub>2</sub> solution and 40 c.c. of sea-water for two hours the eggs began to develop when put back into normal sea-water. Such eggs reached the blastula stage. I do not think that anybody has ever seen before such blastulae as resulted from these unfertilized eggs. As these eggs had no membrane, the amoeboid motions of the cleavage-cells led very frequently to a disconnection of the various parts of one and the same egg, and the outlines of the egg became extremely irregular. The blastulae showed, as a rule, the same outline as the egg had in the morula stage. It was, moreover, a rare thing that the whole mass of the egg developed into one blastula. The disconnection of the various cleavage-cells led, as a rule, to the formation of more than one embryo from one egg. The results were in a certain way similar to those I had obtained when I caused the fertilized eggs of sea-urchins to burst. In such cases a part of the protoplasm flowed out from the egg but was able to develop. These extraovates had no membrane, and of course showed some irregularity in their outlines, but the irregularity in this case

<sup>1</sup> Later experiments gave, however, positive results. See next chapter.

was far less than that observed in the unfertilized eggs of my recent experiments. But although I had thus far satisfied my desire to see the unfertilized eggs of the sea-urchin reach the blastula stage, I was not able to keep these eggs alive long enough to see them grow into the pluteus stage. They developed more slowly than the normal eggs, and died, as a rule, on the second day.

It was my next task to find a solution which would allow the eggs to reach the pluteus stage. I found that this can be done by reducing the amount of magnesium chloride and increasing the amount of sea-water. By putting the unfertilized eggs for about two hours into a mixture of equal parts of  $\frac{2}{8}$ n MgCl<sub>2</sub> and sea-water, the eggs, after they were put back into normal sea-water, not only reached the blastula stage, but went into the gastrula and pluteus stages. The blastulae that originated from these eggs looked much healthier and more normal than those of the former solution with more MgCl<sub>2</sub>. Of course as these unfertilized eggs had no membrane it happened but rarely that the whole mass of an egg developed into one single embryo. Quadruplets, triplets, and twins were much more frequently produced than a single embryo. The outlines of each blastula were much more spherical than in the previous experiment. These eggs reached the pluteus stage on the second day (considerably later than the fertilized eggs do). Thus I had succeeded in raising the unfertilized eggs of sea-urchins to the same stage to which the fertilized eggs can be raised in the aquarium. I have not yet succeeded in raising the fertilized eggs in my laboratory dishes beyond the pluteus stage.

Though I do not wish to go into the technicalities of these experiments, I must mention a few of the precautions that I took in order to guard against the possible presence of spermatozoa in the sea-water.<sup>1</sup> The reader who is interested in this

<sup>1</sup> Today it may seem strange that I had to meet such objections, but when my first papers on artificial parthenogenesis appeared, very few biologists were willing to accept the correctness of my statements. The most absurd sources of error were suggested.



technical side of the experiments will find all the necessary data in my publication in the *American Journal of Physiology*.<sup>1</sup> Here I wish only to mention the following points:

1. These experiments were made after the spawning season was practically over.

2. Bacteriological precautions were taken against the possibility of contamination of the hands, dishes, or instruments with spermatozoa.

3. The spermatozoa contained in the sea-water lose, according to the investigation of Gemmill,<sup>2</sup> their fertilizing power within five hours if distributed in large quantities of sea-water.

4. We have a criterion by which we can tell whether the egg is fertilized or not in the production of a membrane. The fertilized egg forms a membrane and the unfertilized egg has no distinct membrane. None of the unfertilized eggs that developed artificially had a membrane.<sup>3</sup>

5. With each experiment a number of control experiments were made. Part of the unfertilized eggs were put into the same normal sea-water that was used for the eggs that did develop. None of these eggs that remained in normal sea-water formed a membrane or showed any development, except that a few of them were divided into two cells after about twenty-four hours.

6. I made another set of control experiments by putting a lot of eggs of the same female into a solution which differed less from the normal sea-water than the one which caused the formation of blastulae or plutei from the unfertilized eggs.

<sup>1</sup> Loeb, J., "On the Artificial Production of Normal Larvae from the Unfertilized Egg of the Sea-Urchin," *Amer. Journ. of Phys.*, III.

<sup>2</sup> Gemmill, "The Vitality of the Ova and Spermatozoa of Certain Animals," *Journ. of Anat. and Phys.*, 1900.

<sup>3</sup> The method used in these experiments was primitive inasmuch as no fertilization membrane was formed. A few years later I found a method for the artificial production of a fertilization membrane, which is described in the next paper. In the earlier experiments in which no fertilization membrane was developed, nevertheless a change in the cortical layer of the egg was brought about by the combined action of the hydroxyl-ions of the solution, and the increased osmotic pressure.

In this case it was shown, that although these eggs received the same sea-water as the ones which developed, and although they were injured less than the ones which developed, yet not one single egg formed a membrane or reached the blastula stage. If the sea-water had contained any spermatozoa these eggs should have reached the blastula stage.<sup>1</sup> Hence, as in nine different series of experiments these results were confirmed, we may assume that by treating the eggs for two hours with a solution of equal parts of a  $\frac{2}{8}^0$ n MgCl<sub>2</sub> solution and sea-water we can cause them to develop parthenogenetically into plutei.

### III

What conclusions may we draw from these results? If we wish to avoid wild and sterile speculations, I think we should confine ourselves to the following question: What alterations can be produced in an egg by treating it for two hours with a solution of equal parts of  $\frac{2}{8}^0$ n MgCl<sub>2</sub> and of sea-water? Even in this regard we can only give a very indefinite answer which, however, will have to be in the following direction: The bulk of our protoplasm consists of colloidal substances. This material easily changes its state of matter and its power of binding water. It seems probable that changes of these two qualities are mainly responsible for muscular contraction and perhaps amoeboid motions. Among the agencies that cause changes of these physical qualities we know of three that are especially powerful. The one is specific enzymes (trypsin, plasmase, etc.). The second is ions in definite concentration. The concentration varies for various ions. The third agency is temperature. In our experiments it is obvious that only the second possibility can have been active. I do not consider it advisable to enter into theoretical discussions beyond these

<sup>1</sup> Through other control experiments I convinced myself that a treatment of eggs or spermatozoa with equal parts of a  $\frac{2}{8}$ n MgCl<sub>2</sub> solution and sea-water diminishes the impregnability of the eggs and annihilates the fertilizing power of spermatozoa in a very short time.

statements. The next question that should be raised would be whether the spermatozoa act in the same way. It is true that the spermatozoon contains a considerable proportion of salts, especially  $K_3PO_4$ , but it may contain enzymes or it may contain substances which have similar effects upon the physical qualities of the colloids, like the three agencies mentioned above.

In the last volume of these lectures I pointed out that it is impossible to derive all the various elements that constitute heredity from one and the same condition of the egg.<sup>1</sup> Our recent experiments suggest the possibility that different constituents of the egg are responsible for the process of fertilization and for the transmission of the hereditary qualities of the male. While we are able to produce the process of fertilization by a treatment of the unfertilized egg with certain salts in certain concentrations, we cannot hope to bring about the transmission of the hereditary qualities of the male by any such treatment. Hence, the inference must be that the transmission of the hereditary qualities of the male and the agency that causes the process of fertilization are not necessarily one and the same thing. I consider the chief value of the experiments on artificial parthenogenesis to be the fact that they transfer the problem of fertilization from the realm of morphology into the realm of physical chemistry.<sup>2</sup>

<sup>1</sup> Loeb, J., "The Heredity of the Marking in Fish Embryos," *Woods Hole Biol. Lect.*, Boston, 1899.

<sup>2</sup> This paper was written immediately after I had succeeded in producing larvae from the unfertilized egg. In the following years the methods of artificial parthenogenesis were improved and this led to the unraveling of the mechanism by which the spermatozoon causes the egg to develop. An account of this work is given in the two following papers.



VII. ON THE NATURE OF FORMATIVE STIMULATION (ARTIFICIAL PARTHENOGENESIS)



## VII

### ON THE NATURE OF FORMATIVE STIMULATION (ARTIFICIAL PARTHENOGENESIS)<sup>1</sup>

#### PREFACE

The title of this paper was chosen in reference to Virchow's paper on "Stimulation and Irritability" (*Virchow's Archiv*, XIV, 1, 1858) in which he discriminates between three forms of stimulation: functional, nutritive, and formative. By formative stimuli he means those which give rise to nuclear and cellular division. He considers as the classic example for formative stimulation the fertilization of the egg and the parallel drawn by him between this process and the causation of a pathological process of growth is so characteristic that we may quote it in full:

If we admit the identity between the pathological and the embryonic neoformation, the egg will have to be considered as the analogue of the pathological mother cell and the act of impregnation as the analogue of pathological stimulation. This view is not essentially altered through the discovery of the entrance of the spermatozoon into the egg, since there is no reason to consider the spermatozoon as the direct morphological starting-point for the development of definite parts of the egg. If, as seems to be the case, the spermatozoa are dissolved in the egg, they carry into it only certain chemical substances, which serve as specific stimuli, by calling forth new chemical and morphological arrangements of the atoms. Each specific contagium offers the same possibilities.

The supposition prevalent at Virchow's time, that the spermatozoon is entirely dissolved in the egg was not correct; but his view, that the spermatozoon carries chemical substances into the egg, which form the stimulus for its development, is perfectly correct; and likewise the analogy between the causation of the development of the egg by a spermatozoon and the causation of a pathological growth seems correct. I therefore

<sup>1</sup> Address delivered at the International Medical Congress at Budapest, 1909.

believe that it may be of interest to the medical profession to follow me in a brief survey of my experiments on artificial parthenogenesis and the causation of the development of the egg by a spermatozoon.

## I

Cellular physiology has shown that tissues and organs develop only from cells through nuclear and cellular division. The conditions which cause cells to divide and to develop into new normal or pathological tissues have, since Virchow, been called formative stimuli. It is the task of modern biology to ascertain first what is the nature of these stimuli, and second, which change occurs in the cell in the process of formative stimulation. Virchow already emphasized the fact that the fertilization of the egg is the model of all phenomena of formative stimulation and that the spermatozoon may be considered as the formative stimulus in this case.

Pathologists have not yet succeeded in determining what the physico-chemical nature of the formative stimulus in the case of a tumor is, or what changes a cell undergoes in such a process. This task has, however, been accomplished to a high degree in the animal egg, and it may therefore interest the pathologist and the physician in general to become familiar with the essential features of the data thus obtained.

It is known that aside from a few exceptions the animal egg can only develop if a spermatozoon enters into it. If no spermatozoon enters, as a rule no segmentation of the egg takes place and it perishes after a comparatively short period of time. The questions which I tried to solve were the following: By which physico-chemical agencies does the spermatozoon cause the egg to divide and to develop into an embryo; and second, which changes does the egg undergo in this formative stimulation by a spermatozoon? Or in other words, what is the mechanism by which the unfertilized egg is caused to segment and to develop?



Two ways were open to find an answer to this question: first to try to cause the development of the unfertilized egg with extracts from sperm. I have spent a good deal of time in trying to succeed in this task, but met at first with only negative results for the reason that I used at first only extracts from the sperm of the same species of animals from which the eggs were taken. Only recently have I found that the extract of sperm is effective only if it is taken from a foreign species. We shall return to this curious fact later on and show that it has a bearing upon the problem of the immunity of our cells to the lysins of our body.

The second way which could lead to a decision of the question concerning the nature of formative stimulation lay in the direction of artificial parthenogenesis, i.e., of the causation of the development of the animal egg, not by extracts of sperm but directly by physico-chemical agencies. This method of procedure has a special advantage. Since in this case we know the nature of the agencies we employ, it is easier to get an insight into the mechanism by which they cause the development of the egg; while if we work with extracts of sperm we are in the dark as to the chemical character of the active substances.

## II

We will begin with a description of the method of artificial parthenogenesis in the egg of the Californian sea-urchin, since here this method has been worked out most completely. It may be mentioned that in the eggs of many animals the effect of the entrance of the spermatozoon manifests itself almost instantly by a characteristic change, namely, the formation of the so-called membrane of fertilization. Briefly stated this process may possibly consist in the entrance of sea-water between the surface film and the protoplasm of the egg, whereby the former is lifted up from the protoplasm of the egg and separated from it by a more or less wide, clear space. Figs. 1

and 2 (page 7) show these changes in the sea-urchin egg. Fig. 1 represents the unfertilized egg, Fig. 2 shows the same egg after the entrance of the spermatozoon.

In 1905 I succeeded in finding a method by which it is possible to call forth the formation of a membrane of fertilization without apparent injury to the egg. This method consists in putting the eggs for about two minutes (at a temperature of 15°) into a mixture of 50 c.c. of sea-water+3 c.c. of an n/10 lower monobasic fatty acid, e.g., acetic, propionic, butyric, or valerianic acid. In this mixture no membrane formation takes place; if, however, the eggs are transferred into normal sea-water all the eggs form a perfect fertilization membrane. The experiments showed that this process of membrane formation is the essential condition which causes the egg to develop. In all these eggs in the course of the next hours after the membrane formation those changes begin which lead to a cell-division. If the temperature is very low not only cell-divisions begin but the egg may develop into a swimming larva; it reaches the so-called blastula stage. At room temperature, however, the artificial production of a membrane in the egg by fatty acid only calls forth a nuclear and possibly a cell-division; after this the egg slowly begins to disintegrate.

We therefore see that the artificial membrane formation by a fatty acid induces the developmental process, but that at ordinary temperature the latter does not go far. In order to cause a complete development, a second influence is needed, as we shall see later.

Before we describe this second influence, another question has to be settled, namely, how we know that the membrane formation and not any other action of the acid, e.g., a catalytic, is the formative stimulus in this case. The answer is, that if we apply the acid but prevent the changes leading to a membrane formation, divisions of the nucleus and of the cell do not occur. On the other hand, we shall see later on that we can

call forth the membrane formation not alone by fatty acids but by a number of different agencies and that all these means act as formative stimuli.

The causation of the membrane formation by a fatty acid starts, therefore, the development in the sea-urchin egg, but this development is abnormal and the egg is sickly and perishes the more rapidly the higher the temperature. The question arises, how can we inhibit this sickliness and grant a normal development to the egg?

I found that two different means are at our disposal for this purpose. The one which never fails consists in putting the eggs about twenty minutes after the artificial membrane formation into hypertonic sea-water (or any other hypertonic solution, e.g., sugar solution), i.e., into sea-water or any other solution the osmotic pressure of which has been rendered 50 per cent higher than that of the sea-water. In this solution the eggs remain from twenty to sixty minutes—according to the temperature and the concentration of hydroxyl-ions in the solution. If after this time the eggs are transferred into normal sea-water they develop at room temperature in a way similar to the eggs which are fertilized by sperm.<sup>1</sup>

The second method of causing the eggs to develop normally at room temperature after the artificial causation of the membrane formation consists in putting these eggs for three hours in sea-water free from oxygen or into sea-water to which a trace of KCN has been added. After the eggs are transferred into normal sea-water they develop often but not always. This method is, therefore, not quite as reliable as the other method mentioned previously.

We see, therefore, that the formative stimulus in the artificial activation of the egg of the sea-urchin consists of two phases,

<sup>1</sup> The larvae originating from eggs fertilized by sperm live no longer than those originating from eggs which develop parthenogenetically, if the larvae are not fed. The feeding of these larvae is a tedious process and for this reason I have not undertaken the task. Delage has, however, raised two such larvae until they were sexually mature.

namely, first the artificial causation of the membrane formation and second the subsequent short treatment of the egg with a hypertonic solution; (or a longer treatment with an isotonic solution free from oxygen or containing KCN).

We may add that these observations do not hold good for the sea-urchin egg only. Similar observations were made on the eggs of annelids (*Polynoe*) and of star-fish (*Asterina*). In *Polynoe* and star-fish the artificial membrane production is often sufficient to allow the eggs to develop into larvae. But the number of eggs which reach the larval stage and the type of segmentation is improved if the eggs are treated subsequently with one of the above-mentioned methods, as R. Lillie found for *Asterias* and I for *Polynoe*. The experiments on annelids and star-fish, therefore, confirm the fact, that the calling forth of the membrane is the essential feature in formative stimulation and that the subsequent treatment of the eggs with a hypertonic solution (or an isotonic solution free from oxygen) has merely a corrective effect; it probably counteracts a secondary detrimental effect connected with the membrane formation.

### III

We will now try to gain some insight into the mechanism of these two agencies. How can the fatty acid cause the formation of a membrane? In order to get an answer to this question we must find out whether there are other agencies which act like fatty acids. It was noticed that all the agencies which cause cytolysis also cause membrane formation, namely, first the specifically cytolytic agencies like saponin, solanin, digitalin, bile salts, and soaps. Experiments with these agencies, especially with saponin, solanin, and digitalin, yielded a curious result. If the unfertilized eggs are put into a weak solution of saponin in sea-water we notice as the first effect on the eggs the formation of a fertilization membrane. Then ensues a pause of sometimes several minutes and after this pause a sudden

cytolysis of the whole egg follows. If we take the eggs during this pause (i.e., after the membrane is formed, but before the

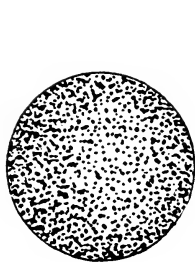

FIG. 39

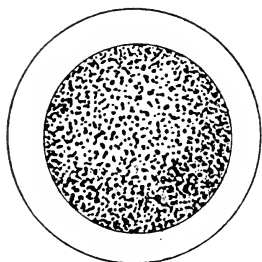

FIG. 40

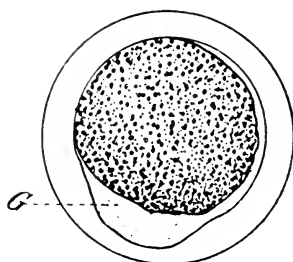

FIG. 41

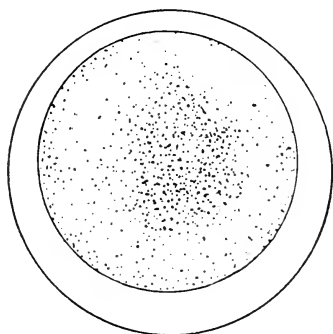

FIG. 42

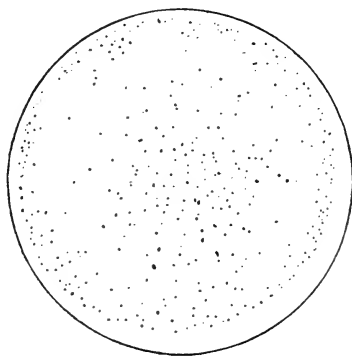

FIG. 43

FIGS. 39-43.—Membrane formation and subsequent cytolysis of the sea-urchin egg in a weak solution of saponin in sea-water. Camera drawings from nature. Fig. 39, unfertilized egg at the beginning of the experiment. In this condition the egg was put into sea-water containing a small amount of saponin. The following figures show the changes it underwent in this solution. Fig. 40, membrane formation under the influence of saponin, eight minutes later. If the egg is taken out of the saponin-sea-water in this stage, washed and put into a hypertonic solution for about one half-hour, it will develop into a larva, after it is put back into normal sea-water. If, however, it is left in the saponin solution it undergoes the rapid cytolysis represented in Figs. 41, 42, and 43. In the above drawing of the egg, cytolysis began at *G*, Fig. 41, five minutes after the membrane formation. The stages represented in Figs. 42 and 43 were reached a few minutes later.

cytolysis of the egg occurs) out of the sea-water containing saponin and free them from all traces of saponin by washing them repeatedly with sea-water, they behave as if the

membrane formation had been called forth by a fatty acid. Such eggs begin to develop, but do not go beyond the first nuclear division at room temperature. If, however, the eggs are treated for half an hour with hypertonic sea-water they can develop to normal plutei, i.e., larvae with skeletons.

The second group of cytolytic agencies is formed by the specific fat solving hydrocarbons like amylen, benzol, toluol, and in a much lesser degree chloroform, etc. Hertwig had already observed that chloroform calls forth the membrane formation and Herbst had seen the same effect brought about by benzol and toluol. But these substances act so violently that the membrane formation is followed almost immediately by a cytolysis of the egg, and for this reason these authors could not notice that the membrane formation was followed by the development of the egg. I have, however, been able to convince myself that if amylen or benzol are allowed to act only for one moment and if the eggs are then quickly transferred into normal sea-water a membrane formation can be produced in some of them without subsequent cytolysis. If such eggs were afterward treated with hypertonic sea-water they developed into larvae.

A further group of cytolytic agencies is ether or alcohols. Cytolysis of the eggs by these agencies is also preceded by a membrane formation. If the eggs are taken out from such solutions immediately after membrane formation they can be saved from cytolytic destruction (Figs. 44-47).

Bases can also call forth membrane formation, but their action is rather slow and depends on the presence of free oxygen. One gains the impression as if the alkali acted in this case only as an accelerator of oxidations and as if a product of oxidation was the proper cause for the membrane formation. The membrane formation usually becomes manifest only if one treats the eggs afterward for a short time with a hypertonic solution; such a treatment causing them to develop into larvae.

An increase in temperature can also produce a cytolytic effect. I have observed that at 34° or 35° the eggs of *Strongylocentrotus purpuratus* form often but not always a membrane

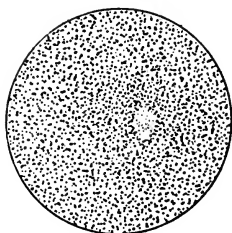

FIG. 44

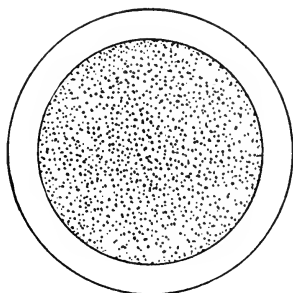

FIG. 45

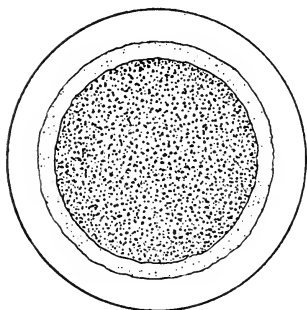

FIG. 46

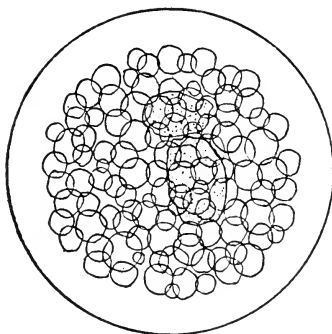

FIG. 47

FIGS. 44-47.—Membrane formation and subsequent cytolysis of the egg under the influence of the addition of a minute quantity of salicylaldehyde to sea-water. Camera drawings. Fig. 44, unfertilized egg at the beginning of the experiment. Fig. 45, membrane formation in the salicylaldehyde-sea-water. Fig. 46, beginning of the cytolysis. Fig. 47, cytolysis completed. The cytolized egg has in this case an entirely different appearance from that of an egg cytolized in saponin.

of fertilization. Such a temperature kills these eggs almost instantly and consequently they are no longer able to develop after this treatment. The eggs of the star-fish *Asterias forbesii* are, however, not killed so rapidly after the membrane

formation, and R. Lillie was able to show that such eggs can develop into larvae if the membrane formation is called forth by raising the temperature. Von Knaffl has shown that if a high temperature acts for some time on these eggs they perish by cytolysis and are transformed into "ghosts."

We have been able to convince ourselves, therefore, that all the agencies which cause cytolysis also call forth the membrane formation; while the agencies which do not call forth cytolysis do not cause a membrane formation. We find in addition that the cytolytic power of these agencies runs parallel with their power of causing membrane formation.

From this we draw the inference that the membrane formation depends upon the cytolysis of the surface layer of the egg. We shall see later on that we must discriminate between a cortical layer and the core of the unfertilized egg. This superficial cortical layer of the egg is very thin. The essential feature of the developmental stimulus consists in the cytolysis of this cortical layer of the egg and this cytolysis is caused by the spermatozoon.

#### IV

We have already mentioned that the cytolysis which underlies the membrane formation causes the development of the egg, but that the egg is as a rule sickly after this membrane formation. To fix our ideas provisionally we assume that through the membrane formation a substance is formed which must be abolished or destroyed before the egg is able to develop normally. If we permit the egg to begin its development while it still contains this hypothetical detrimental substance in a sufficient quantity it is sickly and dies prematurely. The destruction of this hypothetical substance can be brought about in two ways: first, by treating the egg for a short time with a hypertonic solution. When I discovered this fact there was no analogue known which allowed us to draw an inference concerning the mode of action of a hypertonic solution. I succeeded



in showing that such a solution is only effective in artificial parthenogenesis if it contains free oxygen. If the hypertonic solution is deprived of oxygen it remains without any effect. It remains also inefficient if a trace of KCN is added to it. Since KCN inhibits the oxidations in the cell it is obvious that the hypertonic solution only acts by a modification of the process of oxidation.

The second method of saving the life of the egg consists in putting it after the membrane formation for about three hours into sea-water which is practically free from oxygen, or contains a trace of KCN whereby the oxidations in the egg are suppressed. If these eggs are transferred after this time into normal sea-water containing free oxygen they are often able to develop normally.<sup>1</sup>

#### V

Thus far we have dealt only with artificial parthenogenesis. We are now about to take up the causation of development by a spermatozoon. Is the formative stimulation of the egg by spermatozoon of the same character as that in artificial parthenogenesis? This question can be answered in the affirmative. It is possible to show that the spermatozoon also calls forth the normal development of the egg by at least two substances and that one of these substances acts like butyric acid or saponin in artificial parthenogenesis, inasmuch as it causes the cytolysis of the thin cortical layer of the egg; while the second substance has an effect similar to that of the hypertonic solution. The correctness for this view is proved by the fact that I succeeded in separating these two effects of the spermatozoon.

If we wish to bring about a separation of these two agencies in the spermatozoon we cannot use the spermatozoa of the same species of sea-urchins from which the egg is taken; for in this case the spermatozoon penetrates at once into the

<sup>1</sup> A further discussion of the facts in this chapter is contained in the next paper on "The Prevention of the Death of the Egg through the Act of Fertilization."

protoplasm of the egg as soon as it comes in contact with it. In this way almost simultaneously both substances of the spermatozoon become effective, the cytolytic substance, which causes the membrane formation, and the "corrective" substance. The experiments, however, result differently when we add the spermatozoa of a foreign species, e.g., star-fish, to the egg of the sea-urchin. Under ordinary conditions sperm of the star-fish cannot cause the egg of the sea-urchin to develop; it becomes effective, however, in sea-water which has been rendered a little more alkaline through the addition of some NaHO. If 0.6 c.c. n/10 NaHO is added to 50 c.c. of sea-water all the eggs of the sea-urchin form fertilization membranes in such a mixture if only a trace of *living* sperm of a star-fish (*Asterias ochracea*) is added. It takes, however, some time, mostly from ten to fifty minutes, until the living star-fish sperm brings about this effect; while after the addition of sea-urchin sperm this result is obtained in one minute.

If the sea-urchin eggs, all of which have formed membranes upon the addition of living star-fish sperm, are put back into normal sea-water and if we watch their further fate, we soon notice that we are dealing with two groups of eggs. The one group acts as if only one of the two agencies, namely, the cytolytic one, had taken effect. These eggs show at room temperature only the beginning of nuclear division and then disintegrate, while at a lower temperature they may develop a little farther. If we treat them, however, after the membrane formation by star-fish sperm for from thirty to fifty minutes with a hypertonic solution they all develop at room temperature mostly into normal larvae. The other eggs develop without any subsequent treatment with a hypertonic solution into normal larvae.

What causes this difference in the behavior of both groups of eggs? A histological examination of these eggs decides this point. My assistant, Mr. Elder, found that a spermatozoon

had entered into those eggs which develop after the addition of star-fish sperm without subsequent treatment with a hypertonic solution into normal larvae; while the eggs which behave as if only an artificial membrane formation had taken place do not contain any spermatozoon.

This behavior of the eggs under the influence of foreign sperm is comprehensible under the assumption that the spermatozoon also causes the development of the egg through two agencies; one of these agencies is a cytolytic substance, a so-called lysin. This substance is probably situated at the surface of the spermatozoon. This lysin only calls forth the membrane formation and it acts like the butyric acid in the method of artificial parthenogenesis. The second agency seems to be more in the interior of the spermatozoon and it exercises an influence similar to the short treatment of the egg with a hypertonic solution. A normal development will result only if the spermatozoon enters the egg since in this case only both agencies, the cytolytic and the corrective, get into the egg. We have already mentioned that foreign spermatozoa penetrate only slowly into the egg. If a spermatozoon penetrates partially through the surface of the egg without entirely penetrating into the protoplasm, enough of the lysin sticking to the surface of the spermatozoon can be dissolved to cause the cytolysis of the surface film of the egg which gives rise to the membrane formation. Such eggs receive from the spermatozoon only the lysin, and they act therefore as if only the membrane formation had been called forth in them by the treatment with butyric acid, since in the formation of the membrane the spermatozoon is thrown out.

In the eggs of *Strongylocentrotus purpuratus* the membrane formation can in general only be called forth by living star-fish sperm while the extract of dead star-fish sperm in the same concentration remains without effect. This fact is of importance to disprove the possibility that the membrane formation

in these experiments was caused by star-fish blood which was added with the sperm.

That it is possible to separate a lysin from the sperm can be proved for the eggs of another species of sea-urchins, namely, *Strongylocentrotus franciscanus*, the eggs of which are very sensitive to lysins. In these eggs it is possible to call forth the membrane formation with a very dilute watery extract of the sperm of star-fish which was killed by heating it to 60° C., or more. Such eggs can be caused to develop into plutei by treating them after the membrane formation for a short time with hypertonic sea-water. In the place of star-fish sperm the sperm of other foreign species can be used. I have called forth the membrane formation in the sea-urchin egg with the living sperm of sharks or even roosters. Such eggs act as if only the membrane formation with the aid of butyric acid had been caused. At room temperature they begin to develop but they are sickly and soon perish. If, however, they are treated afterward with a hypertonic solution they develop into normal plutei. In this case only the lysin entered the egg but not the spermatozoon. It was, therefore, necessary to treat such eggs subsequently with hypertonic sea-water in order to cause them to undergo normal development at room temperature.

## VI

The idea that a lysin contained in the spermatozoon is the formative stimulus which causes the egg to develop can be tested experimentally. We know that blood contains lysins which destroy the blood corpuscles of foreign species, while it does not destroy the cells of the same species. If the idea is correct that the spermatozoon acts upon the egg through a lysin which calls forth the membrane formation it should be possible to call forth the membrane formation in the unfertilized egg of the sea-urchin by foreign blood and such is the case. I was able to show three years ago that the blood of certain

worms, namely *Sipunculides*, can call forth the membrane formation in the sea-urchin egg even if it is diluted a hundred times or more with sea-water. This effect is not produced in the eggs of every female sea-urchin but of only about 20 per cent of the females. I think the difference is caused by differences in the permeability of the eggs for lysins; and the degree of permeability seems to vary slightly for the eggs of different females.

Instead of wasting time on an examination of the effects of the blood of invertebrates<sup>1</sup> I examined the effects of the blood serum of warm-blooded animals. I succeeded in causing membrane formation in the sea-urchin egg (*purpuratus*) with the blood serum of cattle, sheep, pigs, and rabbits; and such eggs behaved like the eggs which had been treated with the living sperm of roosters or with butyric acid. They began to develop, but they became sickly at room temperature and soon disintegrated. If, however, they were treated after the membrane formation for a short time with a hypertonic solution they developed at room temperature. The blood, therefore, contains the lysin, but not the second substance necessary for the full development. It is, therefore, necessary to substitute for the action of the latter the treatment with a hypertonic solution if we wish to call forth a normal development of the egg treated with serum.

The lysin of the blood is like that of the spermatozoon relatively resistant to heat. The blood does not lose its power to call forth membrane formation by heating it for some time to 60° or 65° C.<sup>2</sup> It is curious that  $\text{SrCl}_2$  and  $\text{BaCl}_2$  increase the membrane-forming power of the blood.

Not only blood but also the extracts of the organs of foreign

<sup>1</sup> Since this was written the blood and the extracts of organs of a number of invertebrates were used successfully to produce the membrane formation and development of the egg of the sea-urchin.

<sup>2</sup> The substance which causes membrane formation can be precipitated with acetone (Loeb, *Pflügers Archiv*, CXXIV, 37, 1908).

species call forth membrane formation in the sea-urchin egg. An extract of the coecum of the star-fish was very effective.

We have already mentioned the fact that the extract of dead sperm of foreign species, e.g., of star-fish, certain mollusks, certain worms, sharks, fowl, causes membrane formation in the eggs of *franciscanus*. Experiments with the extract of dead sperm of their own species on the egg of *franciscanus* or *purpuratus* fail; and the same is true for extracts from the tissues of these species.<sup>1</sup> What causes this difference in the action of the lysins from their own and a foreign species? We know that the lysins of our own blood do not hurt our cells while they hurt the cells of foreign species. There exists, therefore, an immunity of the eggs as well as of the rest of the cells against the lysins of their own blood or tissues.

Our experiments throw a light upon the nature of this immunity. If the lysins contained in our blood do not injure our cells it can only be due to one of two facts: The lysins of our own blood can either not diffuse into our cells, while they can diffuse into the cells of foreign forms, or the cells contain antibodies against the lysins of their own body, but not against those of foreign species. As far as the lysins of the blood are concerned we cannot decide between the two possibilities. We can, however, reach a decision for the lysins of the spermatozoa. The extract from the dead sperm of the sea-urchin is ineffective for the eggs of the sea-urchin solely for the reason that it cannot diffuse into the sea-urchin egg. For if the sea-urchin lysin is carried by the living sea-urchin spermatozoon (which acts as a motor for the lysin) into the sea-urchin egg, the lysin is very active and probably more active than the lysin of foreign species. If the sea-urchin egg contained an antibody against the lysin of the sea-urchin sperm, the sea-urchin sperm should not be able to call forth membrane formation when it enters the sea-urchin egg.

<sup>1</sup> If eggs were sensitized with  $\text{SrCl}_2$  they could be caused to develop by extracts from the coecum of the sea-urchin, though this was true only exceptionally.

We now understand the paradoxical fact, that by foreign sperm we can cause membrane formation and development of the sea-urchin egg in two different ways: namely, first by the living sperm and second by the extract from the dead sperm; while the sperm of the same species can only cause the eggs to develop when it is alive. We now understand the fact alluded to at the beginning of this chapter that my first experiments to cause the development of the egg with extract of sperm did not succeed, since I took it for granted that it was necessary to use the extract of the sperm of the same species from which the eggs were taken. The lysins in this case were not able to diffuse into the egg.

The further unraveling of the nature of the immunity of the egg-cell against the dissolved lysins of the blood and the tissues of the same species depends upon the explanation of the fact that the lysins of a species cannot diffuse into the egg of the same species. It would be of interest if the same principle formed for the immunity of the egg-cell would hold also for the immunity of the body-cells against the lysins in the blood of their own species.

We may, therefore, say that the substance to which the sperm owes its fertilizing power is a lysin and we may express the suspicion that the lysins which we have thus far known only as protective agencies against bacteria play a great physiological rôle in the mechanism of life phenomena. We may call our theory of the developmental action of the spermatozoon the lysin theory; thereby designating that the impulse for the development of the egg is given by a lysin contained in the spermatozoon. In artificial parthenogenesis we substitute for the natural lysin a cytolytic substance. Aside from the lysin action the normal development demands, as a rule (but not always), a second corrective influence which in artificial parthenogenesis may be given by a hypertonic solution.

## VII

The experiments on the artificial parthenogenesis of other forms of animals show that the eggs of different animals possess a varying tendency for parthenogenetic development. There are eggs which can easily be induced to develop, so easily in fact, that the experimenter cannot always be sure whether he has caused the development by a substance applied by him or whether some accidental condition of the experiment was responsible. The eggs of the silkworm, of the star-fish, and of certain worms belong to this class. In working with star-fish eggs we can observe that occasionally a few of them develop in normal sea-water, apparently without any demonstrable cause, into swimming larvae. The eggs of the Californian sea-urchin *Strongylocentrotus purpuratus*, on the other hand, show not the slightest tendency to segment parthenogenetically; only the above-mentioned very specific and quantitative method causes them to develop. For this reason I selected these eggs for the investigation of the nature of the experimental stimulus, since I could always be sure that the same stimulus gave the same results; while, e.g., in the star-fish eggs we can never be perfectly certain that some internal condition in the egg or some overlooked unimportant secondary condition in the experiment may not have caused the development. Although eggs with such a strong tendency for spontaneous development as the star-fish eggs are not the best material for the study of the nature of the developmental stimulus yet we have to answer the question how it happens that some eggs have a greater tendency for parthenogenetic development than others.

Mathews has observed that by gently shaking the star-fish eggs the number of eggs which develop "spontaneously" can be increased. I made a similar observation in the eggs of *Amphitrite*, an annelid. In the eggs of the sea-urchin nobody has ever been able to obtain such a result. I am inclined to believe that if a sea-urchin should be found, the eggs of which



possess a greater tendency to develop spontaneously, it might also be found that the number of eggs developing spontaneously might be increased by agitation.

I tried whether it is possible to cause the eggs to cytolize also mechanically. If we exercise only a slight pressure with a finger upon the ovary of a star-fish we find that many of the eggs which afterward leave the ovary are cytolized. This cytolysis is not caused by a bursting of the egg membrane; on the contrary, in this case the cytolysis of the egg is, as usual, preceded by the formation of a membrane of fertilization and this membrane remains intact in the star-fish egg which is caused to cytolize by mechanical pressure. In the sea-urchin egg, however, it is impossible to produce cytolysis by a slight pressure.

The eggs of the star-fish which develop spontaneously first form a membrane. Shaking causes a development of the star-fish eggs only if the shaking first leads to a membrane formation. The greater tendency of the star-fish to develop spontaneously is, therefore, due to the greater ease with which cytolysis can be produced in this egg.

How can mere agitation or pressure call forth membrane formation or cytolysis? It seems to me that this fact is most easily understood under the assumption, first suggested by Bütschli, that the cytoplasm is an emulsion. It would then follow that the membrane formation as well as the cytolysis depends upon the destruction of this emulsion. We know that different emulsions have a different degree of durability. The eggs which upon gentle pressure undergo cytolysis have an emulsion with a lesser degree of durability than the eggs in which pressure has no such effect. Let us assume that membrane formation as well as cytolysis depends upon the destruction of an emulsion; in this case the membrane formation depends upon the destruction of the emulsion in the cortical layer of the egg only. The lysin of the egg destroys only the emulsion in

the cortical layer of the egg and thereby causes development. The greater tendency of the eggs of certain animals for spontaneous parthenogenetic development thus depends upon the relatively small degree of durability of the emulsion which constitutes the cortical layer of the egg. But it should be stated that this hypothesis is not essential for the lysin theory of the activation of the egg.

### VIII

The assumption that the membrane formation is only a superficial cytolysis of the egg presupposes that the cortical layer of the egg is different from the rest of the cytoplasm. Bütschli had already reached such a conclusion on the basis of histological observations. I am inclined to accept this view on the basis of my observations on the action of cytolytic agencies on the unfertilized egg. The action of these agencies on the unfertilized egg always occurs in two stages which are often separated from each other by a considerable interval of time. The first stage is the cytolysis of the superficial layer; the second stage is the cytolysis of the rest of the egg. This is most obvious in experiments with weak solutions of saponin or solanin in sea-water. In this case first a membrane formation occurs, then a pause ensues, often of several minutes, and then cytolysis of the whole egg follows. If instead of saponin benzol is used a pause can also be observed between membrane formation and cytolysis of the whole egg but this pause is short, often only a fraction of a second, or at the best a few seconds.

It can also be shown directly that there is a qualitative difference between the cortical layer of the protoplasm and the rest. If for the artificial membrane formation the lower fatty acids, from the formic to the capronic acid, are used, cytolysis of the cortical layer only is observed, i.e., membrane formation follows but no cytolysis of the whole egg. If, however, the higher fatty acids of the same series from the heptylic acid on

and upward are applied the membrane formation is always followed after a short pause by a cytolysis of the whole egg.

The lysins contained in the blood and the spermatozoon act according to my present experience only upon the cortical layer of the cytoplasm but not on the rest of the egg. We get a membrane formation and development but not a cytolysis of the whole egg.

If we go back to the idea of Bütschli that protoplasm has the structure of an emulsion we are led to the view that the emulsion of the cortical layer of the egg differs from that of the rest of the egg. There are certain cytolytic agencies which destroy only the cortical layer; while all general cytolytic agencies destroy the cortical layer as well as the rest of the egg.

## IX

How can the cytolysis of the cortical layer of the egg lead to a membrane formation? Von Knaffl has expressed the following view on this point: "Protoplasm is rich in lipoids, it is probably mainly an emulsion of these and of proteins. Every physical and chemical agency which is able to liquefy lipoids calls forth a cytolysis of the egg. The protein of the egg can only swell or be dissolved if the state of the lipoids is altered by chemical or physical means. The mechanism of cytolysis consists in the liquefaction of the lipoids and the subsequent swelling or liquefaction of proteins by absorption of water. . . . This confirms Loeb's view that membrane formation is caused by the liquefaction of lipoids."

We can accept this with a slight modification which refers to the nature of the emulsion. An emulsion requires not only two substances or phases as von Knaffl assumes but in addition a third substance. The third substance serves the purpose of making the emulsion more durable (Lord Rayleigh's theory). The droplets of the emulsion are surrounded by a thin layer of a substance which lessens the surface tension between the

droplet and the second phase of the emulsion. I assume that only this stabilizing substance consists of lipoids, especially cholesterin. The two other phases which constitute the emulsion need not be lipoids. To fix our ideas provisionally we may assume that these phases are first protein with little water and second water with little protein. The existence of these two phases has been established by Hardy. The emulsion at the surface of the egg consists, according to this view, of a system of protein droplets poor in water surrounded by a stabilizing film of a lipid (cholesterin or lecithin). If the sea-urchin egg is treated with a lipid solvent like benzol the stabilizing film of cholesterin is dissolved and the protein droplet can absorb water. If we use saponin the film is destroyed by the precipitation of cholesterin by saponin. The absorption of water leads to the lifting up of the surface film which surrounds the egg.<sup>1</sup>

We wish to add a few remarks concerning the nature of this surface film, although this does not belong to our problem. According to Overton and Koeppe the surface film of cells consists of lipoids, and according to Koeppe cytolysis is determined by the solution or tearing of this film. This view is not tenable, since the surface film which is lifted off in the form of the fertilization membrane does not consist of a lipid but of protein. This is suggested by the fact that this membrane is absolutely insoluble in any lipid solvent. Moreover, this membrane remains perfectly intact when the egg is transformed into a "ghost."

## X

Since we can cause the formation of a membrane of fertilization in the star-fish egg by gentle agitation or mere pressure,

<sup>1</sup> We have assumed here that the fertilization membrane is preformed in the unfertilized egg and lifted up in consequence of the cytolysis of the layer beneath it. As I stated in my book on *Die chemische Entwicklungserregung des tierischen Eies*, it is also possible that the fertilization membrane is a membrane of precipitation formed through the reaction of a constituent of the liquefied cortical layer with a constituent of the sea-water (Ca?). It is immaterial for the problem discussed in this paper which view we adopt temporarily.

this membrane is apparently preformed in the unfertilized egg; and if this be true the process of membrane formation must consist in the lifting up of a preformed film from the underlying cytoplasm through the entrance of sea-water between this film and the cytoplasm. In this process the surface film undergoes a change, since the spermatozoon can enter into the egg before but not after the membrane formation. That merely a change in the nature of the surface film prevents the entrance of a spermatozoon into the egg after the membrane formation can be proved by the fact that if we tear the membrane mechanically a spermatozoon can penetrate into the egg. This proves that the surface film, even if it is already preformed in the unfertilized egg, has different qualities or a different structure when it is in close contact with the cytoplasm than when it is lifted off from the cytoplasm by a layer of sea-water.

We have assumed that the membrane formation is determined by the action of a lysin or cytolytic agency upon the cortical layer of the egg, whereby a protein in this layer absorbs sea-water, and is thereby dissolved. This assumption leads to two consequences: first it must be possible to show that the fertilization membrane is permeable for sea-water and crystalloid substances but impermeable for colloids. The correctness of this view can be proved. If we add to the sea-water, containing eggs with a fertilization membrane, a certain quantity of dissolved white of egg, tannin, or blood serum, the membrane collapses and closes tight around the cytoplasm. The reason is that almost all the liquid which existed between the membrane and the cytoplasm diffused into the surrounding sea-water. If the eggs are brought back into normal sea-water (free from protein) it diffuses again into the space between the membrane and the cytoplasm, and the fertilization membrane resumes its former distance from the cytoplasm and its round shape. The membrane is, therefore, impermeable for the colloids dissolved in sea-water.

If salts are added to the sea-water or if it is diluted by the addition of distilled water the tension and the diameter of the membrane do not change. This proves that the membrane is permeable for salts, but not for colloids, and that the lifting up of the fertilization membrane is determined by the swelling and subsequent liquefaction of a colloid. This dissolved colloid exercises an osmotic or colloidal pressure and sea-water must diffuse from the outside under the fertilization membrane of the egg until the tension of this membrane equals the osmotic or colloidal pressure of the dissolved colloid. This explains also why it is that the fertilization membrane as a rule assumes a spherical shape.

We now can understand why not in all cases of fertilization a distinct fertilization membrane is formed. This may be due to the fact that the degree of swelling of the colloid of the cortical layer varies under different conditions.

## XI

We now possess a pretty complete picture of what happens to the egg in the case of "formative stimulation," i.e., when it is caused to develop. Through a lysin or some other cytolytic agency a certain substance of the cortical layer, presumably a lipid, is dissolved or precipitated, whereby a protein substance of that layer is able to absorb water and swell. Formerly it was thought that the spermatozoon caused the development of the egg by carrying a ferment or enzyme into it and that this ferment set the mechanism of development into action. Others expressed the opinion that the entrance of the sperm nucleus or of a centrosome was responsible for the development. We see, however, that it suffices to call forth the artificial membrane formation in the unfertilized sea-urchin egg, in order to observe after two or three hours the formation of normal astrospheres or spindles. This disproves the suggestion that the fusion of egg and sperm nucleus is essential for the development of the egg.<sup>1</sup>

<sup>1</sup> The fusion of the nuclei is of course of importance for the transmission of paternal qualities.

The ferment theory of the activation of the egg by the spermatozoon is also wrong. If it were correct the velocity of development should be accelerated if not doubled if two spermatozoa enter the egg instead of one; or if fertilization by sperm and artificial parthenogenesis are superposed in the same egg. But this is not the case. In neither case is a shortening of the time which elapses between two successive periods of segmentation observed.<sup>1</sup>

The further development will be connected with the question how can the cytolysis of the cortical layer of the egg lead to its development? I may mention the possibility that the cytolysis of the cortical layer facilitates the diffusion of oxygen or of HO ions (bases) or other substances, necessary for the development, into the egg.

## XII

Let us summarize our results concerning the activation or formative stimulation of the egg. For the normal development at least two agencies are required: the one is the cytolysis of the thin cortical layer of the egg. Any agency which causes this cytolysis (without causing the cytolysis of the rest of the egg) induces development. The spermatozoon as well as the blood and the tissues contain a substance (lysin) which causes only cytolysis of the cortical layer. The lower fatty acids, from formic to capronic, cause only the cytolysis of the cortical layer. Since most cytolytic agencies cause a cytolysis of the whole egg they can be used only if the eggs are withdrawn from their influence after the cortical layer is destroyed but before the rest of the egg has undergone destruction.

Cytolysis of the cortical layer leads often but not always to the formation of the membrane of fertilization.

Since all cytolytic substances are lipid soluble (or destroy lipids) it is probable, but not proved, that the formative

<sup>1</sup> Another reason is that the velocity of segmentation is purely determined by the egg, no matter what is the nature of the spermatozoon.

stimulus in the activation of the egg consists in a liquefaction or precipitation or some other modification of the lipoids of the cortical layer of the egg which results in an imbibition or solution of a colloidal substance of the cortical layer. If the cytoplasm has the structure of an emulsion it is possible that lipoids form the stabilizing envelope for the droplets which, according to Lord Rayleigh, is necessary for the durability of the emulsion.

The cytolysis of the cortical layer of the egg causes its development, but this development is often abnormal and comes prematurely to a standstill. In order to induce a more normal type of development a second agency is often required, the mode of action of which is not yet so clearly understood as that of the cytolytic agency, namely, a short treatment of the egg with a hypertonic solution containing oxygen or a longer inhibition of the development of the egg in normal sea-water which is free from oxygen. The spermatozoon carries in addition to the lysin a second substance into the egg, which acts similarly to the hypertonic solution in our method of artificial parthenogenesis.



VIII. THE PREVENTION OF THE DEATH OF THE  
EGG THROUGH THE ACT OF FERTILIZATION



## VIII

### THE PREVENTION OF THE DEATH OF THE EGG THROUGH THE ACT OF FERTILIZATION<sup>1</sup>

#### I

The unfertilized egg dies in a comparatively short time, while the act of fertilization gives rise to a series of generations which, theoretically at least, is of infinite duration. The act of fertilization is, therefore, a life-saving act for the egg. The question arises, in which way can the spermatozoon save the life of the egg?

If the ovaries of a star-fish are put into sea-water the eggs are shed. They are generally immature, and in this condition they cannot be fertilized, either by spermatozoa or by chemical means. If they remain, however, for some time in sea-water, all or a number of them gradually become mature; that is to say, their nuclear mass is diminished by the extrusion of the two so-called polar bodies. If immediately after the extrusion of the polar bodies sperm is added, the eggs develop. They can at that period likewise be caused to develop by certain chemical and physical agencies.

Ten years ago I made the following observations. If the eggs are not caused to develop by sperm or by physico-chemical agencies, they perish very rapidly. At summer temperature they may die in from four to six hours. The death of the egg manifests itself morphologically in a darkening and blackening of the otherwise clear egg. I found that the death of the egg can be prevented by withdrawing the oxygen, or by diminishing the rate of oxidations in the egg through the addition of a trace of potassium cyanide. The life-saving action of lack of

<sup>1</sup> Reprinted from the *Harvey Lectures*, 1911, by courtesy of Messrs. J. B. Lippincott & Co.

oxygen can be shown in various ways. The maturation of the egg itself depends upon oxidations. If the oxygen is withheld from the immature eggs, or if the oxidations in the immature eggs are inhibited by potassium cyanide, the process of maturation does not take place. Maturation is, therefore, also a function of oxidations. The eggs of a female, which were unripe, were divided into two groups: the one group remained in sea-water in contact with oxygen; the other was put into sea-water whose oxygen had been removed by a current of hydrogen. The eggs of the second group remained alive; the eggs of the first group perished in a few hours.

It is not even necessary to drive out the air by hydrogen; the life of the unfertilized eggs can also be preserved by putting large masses of them into a narrow glass tube which is sealed at the bottom. The eggs sink to the bottom of the tube, and those which are lying near the bottom receive no oxygen, since the oxygen which diffuses from the air through the sea-water is consumed by the uppermost layer of the eggs. On account of this lack of oxygen the eggs at the bottom of the tube do not mature and do not perish; hence by withholding oxygen from the immature eggs their maturation and death are prevented.

If the oxygen is withheld from the eggs immediately after they become mature their life is also saved. A. P. Mathews has repeated this experiment and obtained the same results. This proves that the death of the mature but unfertilized egg is determined by oxidations. If these oxidations are inhibited death does not occur. When these experiments were first published they caused opposition. This opposition was based on the fact that potassium cyanide was used in part of the experiments. The objection was raised that the potassium cyanide in these experiments acted only by preventing the development of bacteria. The authors, however, who raised this objection, overlooked the fact that lack of oxygen acts in exactly the same way as the addition of potassium cyanide,

and that it is entirely immaterial how lack of oxygen is produced, whether the oxygen is driven out by carefully purified hydrogen or whether the eggs are put together in a large heap, whereby only those lying on the surface of the heap receive sufficient oxygen.

It is, however, easy to show directly that the above-mentioned objection is incorrect. The eggs of the star-fish can easily be put into sterilized sea-water without bacterial infection. The following experiment was tried. The eggs of a star-fish were separated into three parts: one part was put aseptically into a series of flasks with sterilized sea-water; the second part was put into ordinary sea-water without asepsis; the third part was put into sea-water to which a large quantity of a putrid culture of bacteria had been added that had developed on the dead eggs of the star-fish. It was found that in all three cases the mature eggs died within the same period of time. The sterilization of the eggs of the first group was complete, as was shown by the fact that the eggs although dead preserved their form for two months, while the dead eggs in the normal sea-water were completely destroyed in a few days by the action of the bacteria.

It is, therefore, certain that the death of the star-fish eggs which are not fertilized is not caused by bacteria, but by the process of oxidation in the egg. If no spermatozoon enters the egg, or if the egg is not caused to develop by chemical treatment it perishes very rapidly. If, however, a spermatozoon enters the egg, the latter remains alive in spite of the fact that the entrance of the spermatozoon causes an acceleration of the oxidations in the egg. Warburg found for the eggs of the sea-urchin at Naples that fertilization raises the velocity of the process of oxidations to six times their original value, while Wasteneys and I found that fertilization caused an increase in the velocity of oxidations of *Arbacia* in Woods Hole to three or four times the rate found in the unfertilized eggs.

How can we explain the fact that fertilization saves the life of the egg? Let us make the following preliminary assumption: The unfertilized egg contains a poison, or some faulty combination of conditions which, if oxidations take place, causes the death of the egg. In the unfertilized but mature egg oxidations take place. The spermatozoon carries into the egg among other substances something which protects the egg against the fatal effects of the oxidations, and allows them even to carry on oxidations at an increased rate without suffering. We might say that the mature but unfertilized egg is comparable to an anaerobic being for which oxidations are fatal, and that the spermatozoon transforms the egg into an aerobic organism.

If we compare the eggs of different animals, we find great differences in regard to the above-mentioned conditions. The eggs of certain annelids (*Polynoe*) also perish rapidly if they become mature without being caused to develop, while the eggs of the sea-urchin remain alive for a longer period of time after they have become mature. The problem as to what determines this difference has not yet been investigated.

## II

The analysis of the process of fertilization by the spermatozoon shows that we must discriminate between two kinds of effects, the hereditary effect and the activating or developmental effect. The experiments on artificial parthenogenesis make it very probable that the two groups of substances, the substances which determine the heredity of paternal characters and the substances which cause the egg to develop, are entirely different. In this paper we are concerned only with the second group of substances, namely, those which cause the development of the egg.

The analysis of the causation of development of the egg by a spermatozoon has shown that the latter acts by carrying at least two substances or groups of substances into the egg.

The first of these substances causes the formation of a membrane; the second serves the purpose of rendering the egg immune against the fatal action of oxidations.

I have shown in a number of papers that the essential feature in the causation of the development of the egg is a

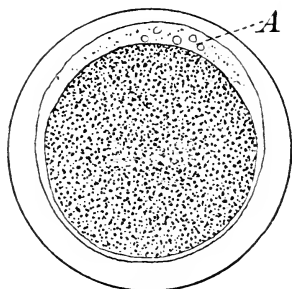

FIG. 48

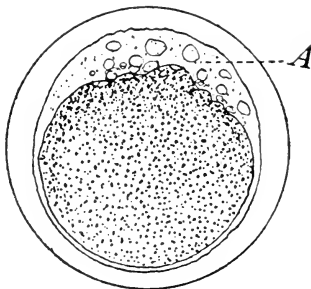

FIG. 49

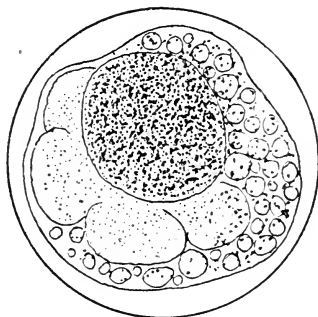

FIG. 50

FIGS. 48-50.—Disintegration of the sea-urchin egg after the membrane formation with butyric acid or with foreign serum or with the extract of sperm or of foreign cells; if the eggs are not treated after the membrane formation with a hypertonic solution or a suppression of oxidations. *A* indicates the area where the disintegration begins.

modification of its surface, which in many cases leads to the formation of a membrane. If we cause membrane formation in an unfertilized sea-urchin egg by artificial means, it begins to develop, but very soon perishes; much more rapidly than if it is not exposed to any treatment. I was able to show that

this rapid death of the sea-urchin egg, after artificial membrane formation, can be prevented either by withdrawing the oxygen from the egg or by inhibiting the oxidations in the egg by the addition of a trace of potassium cyanide. The membrane formation, therefore, causes the rapid death of the egg through an acceleration of oxidations. Warburg has recently shown that the artificial membrane formation in the unfertilized sea-urchin egg causes the same increase in the rapidity of oxidations as the entrance of a spermatozoon.

If we wish to cause the unfertilized eggs to develop to the pluteus stage after the membrane formation, we have to subject them to a second treatment. This may consist in putting them about fifteen minutes after the membrane formation into a hypertonic solution of a certain osmotic pressure (for instance, 50 c.c. of sea-water + 8 c.c.  $n/2\frac{1}{2}$  NaCl) for one-half to one hour. If, after this time, they are put back into normal sea-water they no longer perish, but develop into normal larvae. I ventured the hypothesis that the artificial membrane formation causes a rapid increase of the oxidations in the egg and in this way causes it to develop, but that these oxidations lead to the rapid decay of the eggs at room temperature for the reason that the egg contains a toxic substance, or a toxic complex of conditions, which in the presence of oxidations leads to the rapid death of the egg. The second treatment serves the purpose of rendering the egg immune against the toxic effects of the oxidations.

If we first cause the artificial membrane formation in the unfertilized egg by any of the various means which I have described in former papers, and if we afterward treat the eggs for a short time with a hypertonic solution, they develop after being transferred to normal sea-water in the same way as if a spermatozoon had entered them. They reach the successive larval stages, develop into a blastula, gastrula, and pluteus, and live as long as the larvae produced from eggs fertilized by a spermatozoon.



Hence the physico-chemical activation of the unfertilized egg of the sea-urchin consists of two kinds of treatment. The one is a change in the surface of the egg which may or may not result in the so-called formation of the membrane. This change causes the acceleration of oxidations which in my opinion is the essential feature of the process of fertilization. The second treatment consists in abolishing the faulty condition which makes oxidations fatal to the egg. This second treatment may consist in exposing the eggs for about half an hour or a little more to a hypertonic solution. We can substitute, however, for this treatment another treatment, namely, the deprivation of the egg for three hours from oxidations, either by removing the oxygen from the solution or by adding a trace of potassium cyanide to the solution. If, after the treatment with the hypertonic solution for half an hour, or the treatment with lack of oxygen for about three hours, the eggs are put back into normal sea-water they can develop into normal larvae.

We can show that the spermatozoon also causes the development of the egg by two different agencies comparable in their action to the agencies used in the methods of chemical fertilization which we have just described.

For this purpose we must fertilize the egg of the sea-urchin with a sperm different from its own, and for the following reason: The spermatozoon of the sea-urchin enters so rapidly into the egg that it is impossible to show that it causes the development of the egg by two different substances.

If, however, we fertilize the sea-urchin egg with the sperm of star-fish, it takes from ten to fifty minutes to cause the membrane formation in the eggs, the reason being that the star-fish sperm can penetrate only very slowly into the egg of the sea-urchin.

It is, as a rule, not possible to fertilize the egg of the sea-urchin by star-fish sperm in normal sea-water. But I found

eight years ago that if we make the sea-water slightly more alkaline than it naturally is the eggs of the sea-urchin can be fertilized by the sperm of the star-fish. For the fertilization of the Californian sea-urchin, *Strongylocentrotus purpuratus*, with the sperm of *Asterias*, the best results were obtained when 0.6 c.c. of n/10 NaOH were added to 50 c.c. of sea-water. In this case, with active sperm, in about fifty minutes all the eggs form the typical fertilization membrane.

If we watch the further development of sea-urchin eggs fertilized by star-fish sperm we notice very soon that there are two different kinds of eggs present; the one kind of eggs behave as if they had been fertilized with sperm of their own kind. That is to say, they segment regularly and develop into swimming blastulae and gastrulae. The other kind of eggs, however, act as if they had been treated with one of the agencies which cause the membrane formation in the unfertilized sea-urchin egg; these eggs begin to segment, but at room temperature they slowly perish by cytolysis. If, however, these eggs are treated for half an hour with a hypertonic solution they develop into larvae.

If we examine the eggs of a sea-urchin which have been treated in an alkaline medium with the sperm of the star-fish, we find that only a certain percentage of these eggs contain the sperm nucleus, and this percentage seems to be identical with the percentage of the eggs which develop into larvae. As far as the other eggs are concerned, which form only a membrane and then disintegrate, no sperm nucleus can be found inside of them. I am inclined to draw the following conclusion from these observations: The spermatozoon of the star-fish penetrates very slowly through the surface film of the sea-urchin egg. When it lingers for some time partially imbedded in the surface film, one of the substances of the spermatozoon is dissolved in the superficial layer of the egg and causes the membrane formation. Through the act of

membrane formation the further entrance of the spermatozoon into the egg is prevented, since the fertilization membrane is impermeable to sperm. This membrane formation leads to an increase in the rate of oxidations and the beginning of the development of the egg. The latter, however, contains a toxic substance, or a faulty complex of conditions which has to be abolished, before the oxidations necessary for development can take place without the egg being destroyed by them. The spermatozoon carries a second substance into the egg which renders it immune against the fatal actions of the oxidations. While the membrane-forming substance of the spermatozoon may be situated at its surface, or superficially at least, the second substance which transforms the egg from an anaerobe into an aerobe must be situated in the interior of the spermatozoon; since it can only act if the spermatozoon penetrates into the egg. We see in these observations, concerning the fertilization of the sea-urchin egg by the star-fish sperm, a proof that the activation of the egg by the spermatozoon is also caused by two different substances, one of which causes the membrane formation, while the second renders the egg immune against the toxic action of the oxidations. These data support the assumption made above that the life-saving action of the spermatozoon is due to the fact that it carries a substance into the egg which renders the latter immune against the toxic action of oxidations.

### III

Seven years ago I found that a number of agencies destroy the fertilized egg much more rapidly than the unfertilized egg. Thus, for instance, while in a pure sodium chloride solution the unfertilized egg of the Californian sea-urchin may be kept alive for several days, the fertilized egg is destroyed in such a solution in less than twenty-four hours. If we use slightly alkaline solutions of sodium chloride the greater resistance of the

unfertilized egg is perhaps still more striking. The egg of the Atlantic form of sea-urchin, *Arbacia*, is cytolized in a neutral sodium chloride solution in a few hours, while the unfertilized egg may live for a considerably longer period of time. When we put fertilized and unfertilized eggs into hypertonic solutions, we find also that the fertilized eggs suffer much more than the unfertilized. What causes this difference of sensitiveness between fertilized and unfertilized eggs? It is possible that the permeability of the fertilized eggs is greater than that of the unfertilized. While this is probably to some extent true, yet it is not the whole explanation of the difference in the behavior of the two kinds of eggs. I have been able to show for a number of toxic solutions that their effect can be either completely annihilated or at least diminished if we take the oxygen away from the solution. Thus, for instance, fertilized eggs of the sea-urchin which perish very rapidly in pure salt solutions, or a solution of sodium+calcium, or a solution of sodium+barium, can be kept alive for a considerable period of time in the same solutions if we either carefully remove the oxygen from the solutions, or if we diminish the rate of the oxidations in the eggs by adding a trace of sodium cyanide. In this case we have the direct proof that solutions which are fatal for the egg when the oxidations are allowed to go on are rendered completely, or at least partially, harmless if we stop the oxidations in the egg. Not only the toxic action of salt solutions upon the fertilized egg could be inhibited by the suppression of the oxidations in the egg, but also the toxic action of sugar solutions, or of solutions of alcohol in the sea-water, or of a solution of chloral hydrate.<sup>1</sup>

These observations prove directly that in the presence of certain toxic substances or mixtures of substances the oxidations in the egg lead to its rapid destruction; while a suppression of the oxidation saves the life of the egg.

<sup>1</sup> Or of phenylurethane. This observation does not agree very well with the assumption that the narcotic action of these substances is due to a retardation of oxidation.

We therefore believe that we may conclude that the rapid death of the unfertilized egg of certain species is caused by the oxidations which take place in these eggs; and that the life-saving action of the spermatozoon consists in the fact that the latter, in addition to the membrane-forming substance, carries a second substance, or group of substances, into the egg which renders it immune against the harmful effect or consequences of oxidations.



IX. THE RÔLE OF SALTS IN THE PRESERVATION  
OF LIFE





## IX

### THE RÔLE OF SALTS IN THE PRESERVATION OF LIFE<sup>1</sup>

#### I

Less is known of the rôle of the salts in the animal body than of the rôle of the three other main food-stuffs, namely, carbohydrates, fats, and proteins. As far as the latter are concerned, we know at least that through oxidation they are capable of furnishing heat and other forms of energy. The neutral salts, however, are not oxidizable. Yet it seems to be a fact that no animal can live on an ash-free diet indefinitely, although no one can say why this should be so. We have a point of attack for the investigation of the rôle of the salts in the fact that the cells of our body live longest in a liquid which contains the three salts, NaCl, KCl, and CaCl<sub>2</sub> in a definite proportion, namely, 100 molecules NaCl, 2.2 molecules KCl, and 1.5 molecules of CaCl<sub>2</sub>. This proportion is identical with the proportion in which these salts are contained in sea-water; but the concentration of the three salts is not the same in both cases. It is about three times as high in the sea-water as in our blood serum.

Biologists have long been aware of the fact that the ocean has an incomparably richer fauna than fresh-water lakes or streams and it is often assumed that life on our planet originated in the ocean. The fact that the salts of Na, Ca, and K exist in about the same proportion in our blood serum as in the ocean has led some authors to the conclusion that our ancestors were marine animals, and that, as a kind of inheritance, we still carry diluted sea-water in our blood. Statements of this kind have

<sup>1</sup> Carpenter lecture delivered at the Academy of Medicine of New York, October 19, 1911. Reprinted from *Science*, N.S., XXXIV, No. 881, 653-65, November 17, 1911, by courtesy of Professor James McKeen Cattell.

mainly a metaphorical value, but they serve to emphasize the two facts, that the three salts, NaCl, KCl, and CaCl<sub>2</sub>, exist in our blood in the same relative proportion as in the ocean and that they seem to play an important rôle in the maintenance of life.

I intend to put before you a series of experiments which seem to throw some light on the mechanism by which the solutions surrounding living cells influence their duration of life.

## II

In order to give a picture of the extent to which the life of many animals depends upon the cooperation of the three salts I may mention experiments made on a small marine crustacean, *Gammarus*, of the Bay of San Francisco. If these animals are suddenly thrown into distilled water, their respiration stops (at a temperature of 20° C.) in about half an hour. If they are put back immediately after the cessation of respiration into sea-water, they can recuperate. If ten minutes or more are allowed to elapse before bringing them back into the sea-water, no recuperation is possible. Since in this case death is caused obviously through the entrance of distilled water into the tissues of the animals, one would expect that the deadly effect of distilled water would be inhibited if enough cane sugar were added to the distilled water to make the osmotic pressure of the solution equal to that of the sea-water. If, however, the animals are put into cane-sugar solution, the osmotic pressure of which is equal to that of sea-water, the animals die just about as rapidly as in distilled water. The same is true if the osmotic pressure of the sugar solution is higher or lower than that of the sea-water. The sugar solution is, therefore, about as toxic for these animals as the distilled water, although in the latter case water enters into the tissues of the animal, while in the former case it does not.

If the sea-water is diluted with an equal quantity of distilled water in one case, and of isotonic cane-sugar solution in the

other, in both cases the duration of life is shortened by practically the same amount.

If the crustaceans are brought into a pure solution of NaCl, of the same osmotic pressure as the sea-water, they also die in about half an hour. If to this solution a little calcium chloride be added in the proportion in which it is contained in the sea-water the animals die as rapidly as without it. If, however, both CaCl<sub>2</sub> and KCl are added to the sodium chloride solution, the animals can live for several days. The addition of KCl alone to the NaCl prolongs their life but little.

If KCl and CaCl<sub>2</sub> are added to a cane-sugar solution isotonic with sea-water, the animals die as quickly or more so than in the pure cane-sugar solution.

If other salts be substituted for the three salts the animals die. The only substitution possible is that of SrCl<sub>2</sub> for CaCl<sub>2</sub>. We find also that the proportion in which the three salts of sodium, calcium, and potassium have to exist in the solution cannot be altered to any extent. All this leads us to the conclusion, that in order to preserve the life of the crustacean *Gammarus*, the solution must not only have a definite concentration or osmotic pressure but that this osmotic pressure must be furnished by definite salts, namely, sodium chloride, calcium chloride, and potassium chloride in the proportion in which these three salts exist in the sea-water (and in the blood); this fact could also be demonstrated for many other marine animals. The relative tolerance of various cells and animals for abnormal salt solutions is, however, not the same, a point which we shall discuss later on.

### III

What is the rôle of the salts in these cases? The botanists have always considered salt solutions as nutritive solutions. It is a well-known fact that plants require definite salts, e.g., nitrates and potassium salts, for their nutrition, and the question now arises whether the three salts NaCl, KCl, and CaCl<sub>2</sub>,

which are needed for the preservation of animal life, play the rôle of nutritive salts. Experiments which I made on a small marine fish, *Fundulus*, proved beyond question that this is not the case. If the young, newly hatched fish are put into a pure solution of sodium chloride of the concentration in which this salt is contained in sea-water, the animals very soon die. If, however, KCl and  $\text{CaCl}_2$  be added to the solution in the right proportion, the animals can live indefinitely. These fish, therefore, behave in this respect like *Gammarus* and the tissues of the higher animals, but they differ from *Gammarus* and the majority of marine animals inasmuch as the fish can live long, and in some cases, indefinitely, in distilled and fresh water, and certainly in a very dilute solution of sodium chloride. From this fact I drew the conclusion that KCl and  $\text{CaCl}_2$  do not act as nutritive substances for these animals, that they only serve to render NaCl harmless if the concentration of the latter salt is too high. I succeeded in showing that as long as the sodium chloride solution is very dilute and does not exceed the concentration of  $m/8$ , the addition of KCl and  $\text{CaCl}_2$  is not required. Only when the solution of NaCl has a concentration above  $m/8$  does it become harmful and require the addition of KCl and  $\text{CaCl}_2$ .

The experiments on *Fundulus*, therefore, prove that a mixture of  $\text{NaCl} + \text{KCl} + \text{CaCl}_2$  does not act as a nutritive solution, but as a *protective* solution. KCl and  $\text{CaCl}_2$  are only necessary in order to prevent the harmful effects which NaCl produces if it is alone in solution and if its concentration is too high. We are dealing, in other words, with a case of antagonistic salt action; an antagonism between NaCl on the one hand and KCl and  $\text{CaCl}_2$  on the other. The discovery of antagonistic salt action was made by Ringer, who found that there is a certain antagonism between K and Ca in their action on the heart. When he put the heart of a frog into a mixture of  $\text{NaCl} + \text{KCl}$  he found that the contractions of the heart were not normal,

but they were rendered normal by the addition of a little  $\text{CaCl}_2$ . A mixture of  $\text{NaCl} + \text{CaCl}_2$  also caused abnormal contractions of the heart, but these were rendered normal by the addition of  $\text{KCl}$ . Ringer drew the conclusion that there existed an antagonism between potassium and calcium, similar to that which Schmiedeberg had found between different heart poisons, e.g., atropin and muscarin. Biedermann had found that alkaline salt solutions cause twitchings in the muscle and Ringer found that the addition of  $\text{Ca}$  inhibited these twitchings. Since these experiments were made many examples of the antagonistic action of salts have become known.

It had generally been assumed that the antagonistic action of two salts was based on the fact that each salt, when applied singly, acted in the opposite way from that of its antagonist. We shall see that in certain cases of antagonistic salt action at least this view is not supported by fact.

#### IV

What is the mechanism of antagonistic salt action? I believe that an answer to this question lies in the following observations on the eggs of *Fundulus*. If these eggs are put immediately after fertilization into a pure sodium chloride solution which is isotonic with sea-water, they usually die without forming an embryo. If, however, only a trace of a calcium salt, or of any other salt with a bivalent metal (with the exception of  $\text{Hg}$ ,  $\text{Cu}$ , or  $\text{Ag}$ ) is added to the  $m/2$   $\text{NaCl}$  solution, the toxicity of the solution is diminished or even abolished. Even salts which are very poisonous, namely, salts of  $\text{Ba}$ ,  $\text{Zn}$ ,  $\text{Pb}$ ,  $\text{Co}$ ,  $\text{Ni}$ ,  $\text{Mn}$ , and other bivalent metals, are able to render the pure solution of sodium chloride harmless, at least to the extent that the eggs can live long enough to form an embryo. The fact that a substance as poisonous as  $\text{Zn}$  or lead can render harmless a substance as indifferent as sodium chloride seems so paradoxical that it demanded an explanation,

and this explanation casts light on the nature of the protective or antagonistic action of salts. For the antagonistic action of a salt of lead or zinc against the toxic action of sodium chloride can only consist in the lead salt protecting the embryo against the toxic action of the NaCl. But how is this protective action possible?

We have mentioned that if we put the young fish, immediately after hatching, into a pure  $m/2$  solution of sodium chloride the animals die very quickly, but that they live indefinitely in the sodium chloride solution if we add both  $\text{CaCl}_2$  and KCl. How does it happen that for the embryo, *as long as it is in the egg shell*, the addition of  $\text{CaCl}_2$  to the NaCl solution suffices, while if the fish is *out of the shell* the addition of  $\text{CaCl}_2$  alone is no longer sufficient and the addition of KCl also becomes necessary? Moreover, if we try to preserve the life of the fish *after it is taken out of the egg* in an  $m/2$  sodium chloride solution by adding  $\text{ZnSO}_4$ , or lead acetate, to the solution we find that the fish die even much more quickly than without the addition.<sup>1</sup>

If we look for the cause of this difference our attention is called to the fact that the fish, as long as it is in the egg, is separated from the surrounding solution by the egg membrane. This egg membrane possesses a small opening, the so-called micropyle, through which the spermatozoon enters into the egg. I have gained the impression that this micropyle is not closed as tightly immediately after fertilization as later on, since the *newly fertilized* egg is killed more rapidly by an  $m/2$  solution of NaCl than it is killed by the same solution one or two days after fertilization. One can imagine that the micropyle contains a wad of a colloidal substance which is hardened gradually to a leathery consistency if the egg remains in the sea-water.

<sup>1</sup> R. Lillie has found that in the larvae of *Arenicola* a slight antagonism between NaCl and  $\text{ZnSO}_4$  can be proved. This shows that the general laws of antagonism between two salts differ in degree but not in principle in the living organism and the dead envelop of the fish egg.

With the process of hardening, or tanning, it becomes more impermeable for the NaCl solution. This process of hardening is brought about apparently very rapidly if we add to the  $m/2$  NaCl solution a trace of a salt of a bivalent metal like Ca, Sr, Ba, Zn, Pb, Mn, Ko, and Ni, etc. It is also possible that similar changes take place in the whole membrane. The process of rendering the  $m/2$  Na solution harmless for the embryo of the fish, therefore, depends apparently upon the fact that the addition of the bivalent metals renders the micropyle or perhaps the whole membrane of the egg more impermeable to NaCl than was the case before.

But these are only one part of the facts which throw a light upon the protective or antagonistic action of salts. Further data are furnished by experiments which I made together with Professor Gies, also on the eggs of *Fundulus*. Gies and I were able to show that not only are the bivalent metals able to render the sodium chloride solution harmless, but that the reverse is also the case, namely, that NaCl is required to render the solutions of many of the bivalent metals, for instance  $ZnSO_4$ , harmless. (That the  $SO_4$  ion has nothing to do with the result was shown before by experiments with  $Na_2SO_4$ .)

If the eggs of *Fundulus* are put immediately after fertilization into distilled water, a large percentage of the eggs develop, often as many as 100 per cent, and the larvae and embryos formed in the distilled water are able to hatch. If we add, however, to 100 c.c. of distilled water that quantity of  $ZnSO_4$  which is required to render the NaCl solution harmless, all the eggs are killed rapidly and not a single one is able to form an embryo. If we add varying amounts of NaCl we find that, beginning with a certain concentration of NaCl, this salt inhibits the toxic effects of  $ZnSO_4$ , and many eggs are able to form an embryo. This can be illustrated by the following table:

TABLE I

Nature of the Solution	Percentage of the Eggs Forming an Embryo
100 c.c. distilled water . . . . .	49
100 c.c. distilled water+8 c.c. m/32 ZnSO <sub>4</sub> . . . . .	0
100 c.c. m/64 NaCl+8 c.c. m/32 ZnSO <sub>4</sub> . . . . .	0
100 c.c. m/32 NaCl+8 c.c. m/32 ZnSO <sub>4</sub> . . . . .	3
100 c.c. m/16 NaCl+8 c.c. m/32 ZnSO <sub>4</sub> . . . . .	8
100 c.c. m/8 NaCl+8 c.c. m/32 ZnSO <sub>4</sub> . . . . .	44
100 c.c. m/4 NaCl+8 c.c. m/32 ZnSO <sub>4</sub> . . . . .	38
100 c.c. 3/8 NaCl+8 c.c. m/32 ZnSO <sub>4</sub> . . . . .	37
100 c.c. m/2 NaCl+8 c.c. m/32 ZnSO <sub>4</sub> . . . . .	34
100 c.c. 5/8 NaCl+8 c.c. m/32 ZnSO <sub>4</sub> . . . . .	29
100 c.c. 6/8 NaCl+8 c.c. m/32 ZnSO <sub>4</sub> . . . . .	8
100 c.c. 7/8 NaCl+8 c.c. m/32 ZnSO <sub>4</sub> . . . . .	6
100 c.c. m NaCl+8 c.c. m/32 ZnSO <sub>4</sub> . . . . .	1

This table shows that the addition of NaCl, if its concentration exceeds a certain limit, namely, m/8, is able to render the ZnSO<sub>4</sub> in the solution comparatively harmless.

If we now assume that ZnSO<sub>4</sub> renders the 5/8 m NaCl solution harmless by rendering the egg membrane comparatively impermeable for NaCl we must also draw the opposite conclusion, namely, that NaCl renders the egg membrane comparatively impermeable for ZnSO<sub>4</sub>. We therefore arrive at a new conception of the mutual antagonism of two salts, namely, that this antagonism depends, in this case at least, upon a *common, cooperative* action of *both* salts on the egg membrane, by which action this membrane becomes completely or comparatively impermeable for *both* salts. And from this we must draw the further conclusion that the fact that each of these salts, if it is alone in the solution, is toxic, is due to its comparatively rapid diffusion through the membrane, so that it comes into direct contact with the protoplasm of the germ.

As long as we assumed that each of the two antagonistic salts acted, if applied singly, in the opposite way from its antagonist, it was impossible to understand these experiments



or find an analogue for them in colloid chemistry. But if we realize that NaCl alone is toxic because it is not able to render the egg membrane impermeable; and that ZnSO<sub>4</sub> if alone in solution is toxic for the same reason; while both combined are harmless (since for the "tanning" of the membrane the action of the two salts is required) these experiments become clear.

We may, for the sake of completeness, still mention that salts alone have such antagonistic effects; glycerin, urea, and alcohol have no such action. On the other hand, ZnSO<sub>4</sub> was not only able to render NaCl harmless, but also LiCl, NH<sub>4</sub>Cl, CaCl<sub>2</sub>, and others; and vice versa.

These experiments on the egg of *Fundulus* are theoretically of importance, since they leave no doubt that in this case at least the "antagonistic" action of salts consists in a modification of the egg membrane by a combined action of two salts, whereby the membrane becomes less permeable for both salts.

## V

It is not easy to find examples of experiments in the literature which are equally unequivocal in regard to the character of antagonistic salt action; but I think that some recent experiments by Osterhout satisfy this demand.

It has long been a question whether or not cells are at all permeable for salts. Nobody denies that salts diffuse much more slowly into the cells than water; but some authors, especially Overton and Hoeber, deny categorically that they can diffuse at all into the cells. Overton's view is based partly on experiments on plasmolysis in the cells of plants. If the cells of plants, for example, those of *Spirogyra*, are put into a solution of NaCl or some other salt of sufficiently high osmotic pressure, the volume of the contents of the cell decreases through loss of water and the protoplasm retracts, especially from corners of the rigid cellulose walls. Overton maintains that this plasmolysis is permanent, and concludes from this

that only water but no salt can diffuse through the cell-wall; since otherwise salt should gradually diffuse from the solution into the cell, and through this increase in the osmotic pressure of the cell the water should finally diffuse back into the cell and reconstitute the normal volume of the cell. According to Overton this does not happen.

Osterhout has recently shown that Overton's observations were incomplete in a very essential point and that in reality the plasmolysis, which occurs in this case when the cell is put into the hypertonic solution, disappears again in a time which varies with the nature of the salt in solution. This stage of reversion of plasmolysis had been overlooked by Overton. If the cell, however, remains permanently in the hypertonic sodium chloride solution, a shrinking of the contents of the cell takes place again, which superficially resembles plasmolysis, but which in reality has nothing to do with plasmolysis, but is a phenomenon of death. That this second "false plasmolysis," as Osterhout calls it, has nothing to do with the hypertonic character of the solution was proved by the fact that hypotonic solutions of toxic substances may produce the same phenomenon.

In one experiment which Osterhout describes,

a portion of a *Spirogyra* filament was plasmolyzed in .2 m  $\text{CaCl}_2$ , but not in .195 m  $\text{CaCl}_2$ . A .29 m NaCl solution has approximately the same osmotic pressure as a .2 m  $\text{CaCl}_2$  solution. But on placing another portion of the same *Spirogyra* filament in a .29 m NaCl solution the expected plasmolysis does not occur and it is impossible to plasmolyze the cells until they are placed in .4 m NaCl.

Osterhout explains this difference in the concentration of the two salts required for plasmolysis by the assumption that NaCl diffuses more rapidly into the cell than  $\text{CaCl}_2$ , a conclusion which I reached also on the basis of my earlier experiments on animals.

Osterhout's experiments also show that the antagonism of NaCl and  $\text{CaCl}_2$  depends partly on the facts that the two salts

inhibit each other from diffusing into the cells, and this conclusion is based among others upon the following experiment.

By dividing a *Spirogyra* filament into several portions it was found that it was plasmolyzed in .2 m  $\text{CaCl}_2$  and in .38 m  $\text{NaCl}$ , but neither in .195 m  $\text{CaCl}_2$  nor in .375 m  $\text{NaCl}$ . On mixing 100 c.c. .375 m  $\text{NaCl}$  with 10 c.c. .195 m  $\text{CaCl}_2$  and placing other portions of the same filament in it, prompt and very marked plasmolysis occurred.

The explanation for this observation lies in the fact that in the mixture of  $\text{NaCl}$  and  $\text{CaCl}_2$  the two salts render their diffusion into the cell mutually more difficult. After a longer period of time the plasmolyzed cells can expand again in a mixture of  $\text{NaCl}$  and  $\text{CaCl}_2$ , but that occurs much later than if they are in the pure  $\text{NaCl}$  solution.

These experiments are the analogue of the observation on the embryo of the eggs of *Fundulus* in which a pure solution of  $\text{ZnSO}_4$  diffused rapidly through the membrane or micropyle, while, if both salts were present, the diffusion was inhibited or considerably retarded.

While the observations of Osterhout show that Overton was not justified in using the experiments on plasmolysis to prove that the neutral salts cannot diffuse into the cells, yet they do not prove that these salts diffuse into the cell under normal conditions. In Osterhout's experiments the cells are in strongly hypertonic solutions and it does not follow that such solutions act like isotonic, perfectly balanced solutions.

## VI

Wasteneys and I have recently shown that the toxic action of acids upon *Fundulus* can be annihilated by salts. If we add 0.5 c.c. n/10 butyric acid to 100 c.c. of distilled water these fish die in  $2\frac{1}{2}$  hours or less. In solutions which contain 0.4 c.c. or less acid they can live for a week or more. If we add, however, 0.5 c.c. of butyric acid to 100 c.c. of solutions of  $\text{NaCl}$  of various concentration, we find that above a certain limit

the NaCl can render the acid harmless. It is needless to say that the NaCl used in these experiments was strictly neutral and that the amount of acid present in the mixture of acid and salt was measured. The following experiment may serve as an example. Six fish were put into 500 c.c. of each of the following seven mixtures, namely,

- 1) 100 c.c. H<sub>2</sub>O + 0.5 c.c. n/10 butyric acid
- 2) 96 c.c. H<sub>2</sub>O + 4 c.c. m/2 NaCl + 0.5 c.c. n/10 butyric acid
- 3) 94 c.c. H<sub>2</sub>O + 6 c.c. m/2 NaCl + 0.5 c.c. n/10 butyric acid
- 4) 92 c.c. H<sub>2</sub>O + 8 c.c. m/2 NaCl + 0.5 c.c. n/10 butyric acid
- 5) 90 c.c. H<sub>2</sub>O + 10 c.c. m/2 NaCl + 0.5 c.c. n/10 butyric acid
- 6) 88 c.c. H<sub>2</sub>O + 12 c.c. m/2 NaCl + 0.5 c.c. n/10 butyric acid
- 7) 85 c.c. H<sub>2</sub>O + 15 c.c. m/2 NaCl + 0.5 c.c. n/10 butyric acid

After certain intervals the number of surviving fish was ascertained. The result is given in Table II.

TABLE II

After	Number of Surviving Fish in 0.5 c.c. n/10 Butyric Acid						
	+0	4.0	6.0	8.0	10.0	12.0	15.0
	c.c. m/2 NaCl in 100 c.c. of the Solution						
2 hours.....	0	0	0	2	3	3	6
4 hours.....	..	..	..	0	3	2	5
1 day.....	..	..	..	..	1	1	5
2 days.....	..	..	..	..	1	0	5
3 days.....	..	..	..	..	1	..	5
4 days.....	..	..	..	..	1	..	5

If the amount of acid was increased, the amount of NaCl also had to be increased to render the acid harmless. In order to render 0.5 c.c. n/10 butyric acid pro 100 c.c. solution harmless, 10 c.c. m/2 NaCl had to be added; while 0.8 c.c. butyric acid required 20 c.c. and 1.0 c.c. butyric acid required about 28 c.c. m/2 NaCl in 100 c.c. of the solution.

Not only butyric acid, but any kind of acid, could be rendered harmless by neutral salts, e.g., HCl by NaCl.

Wasteneys and I could show that the rate of the absorption of acid by the fish is the same in solutions with and without salt. This proves that the action of the salts consisted in this case not in preventing the diffusion or absorption of the acid, but in modifying the deleterious effect of the absorbed acid.

We can state a little more definitely the cause of death by acid. If we put the fish into a weak acid solution in distilled water just strong enough to kill the fish in from one to two hours (e.g., 500 c.c.  $H_2O + 2.0$  c.c.  $n/10$  HCl), we notice that the acid very soon makes the normally transparent epidermis of the fish opaque, and a little later the epidermis falls off in pieces and shreds. This, however, is probably not the direct cause of the death, but I am inclined to assume that the fish die from suffocation caused by a similar action of the acid upon the gills.

The action of the acid upon the epidermis of the body as well as upon the gills is prevented through the addition of neutral salts.

It is well known that the action of acids upon proteins can be inhibited by neutral salts.<sup>1</sup> Thus the internal friction of certain protein solutions is increased by acids while the addition of neutral salts inhibits this effect (Pauli). The swelling of gelatin caused by acid is inhibited by salts (Procter).<sup>2</sup>

It is possible that in the experiments with acid the fish is killed in the following way. The acid causes certain proteins in the surface layer of the epithelial cells of the gills and of the skin to swell, whereby this surface layer becomes more permeable for the acid. The acid can now diffuse into the epithelial cells and act on the protoplasm, whereby the cells are killed. If salts are present in the right concentration, the combined action of acid and salt causes a dehydration of the surface film

<sup>1</sup> It seems that the first experiments on the antagonism between acids and salts were published by the author in *Pflügers Archiv*, Vol. LXXV, p. 308, 1899.

<sup>2</sup> The beautiful osmometric experiments of R. Lillie should also be mentioned in this connection.

of these cells, as it does in the experiments on gelatin or as in the cases of tanning of hides by the combined action of acids and salt solutions. This combined dehydrating or "tanning" action of acid and salts on the surface of the epithelial cells of the gills diminishes the permeability of this layer for the acids and prevents them from diffusing into the cells and thus destroying the protoplasm. In this way the gills are kept intact and the life of the fish is saved.

As long as the amount of acid is small the amount absorbed is not essentially diminished by the presence of salts; but while in the presence of salts the acid is consumed in the tanning action of the surface layer of the cells, or is absorbed in this layer; if no salt is present part of the acid diffuses into the epithelial cells and kills the latter.

## VII

We have thus far considered the cases of antagonism between two electrolytes only. The case of the antagonism between three electrolytes is a little more complicated.

We choose as an example the antagonism between NaCl, KCl, and CaCl<sub>2</sub>—the antagonism which is most important in life phenomena. If the mechanism of the antagonism between NaCl, on the one hand, and KCl and CaCl<sub>2</sub>, on the other, is of the same nature as that between NaCl and ZnSO<sub>4</sub> in the case of the eggs of *Fundulus*, it must be possible to show that not only is NaCl toxic if it is alone in solution, and that it is rendered harmless by the two other salts, but that the reverse is true also. This can be proved in the case of KCl. To demonstrate it, we have again to experiment on organisms which are, in wide limits, independent of the osmotic pressure of the surrounding solution since the concentration of the KCl in sea-water is very low. The experiments were carried out by Mr. Wasteneys and myself on *Fundulus*. The method consisted in putting six fish, after washing them twice with distilled water, into 500 c.c.

of the solution. It was ascertained from day to day how many fish survived.

When the fish were put into pure solutions of KCl of the concentration in which this salt is contained in the sea-water (2.2 c.c. m/2 KCl in 100 c.c. of the solution) they died mostly in less than two days. This is not due to the low concentration of the KCl solution, which is only 1/50 of that of the sea-water, since the fish can live indefinitely in a pure NaCl solution of the same concentration as that in which the KCl exists in the sea-water.

If we add to the toxic quantities of KCl increasing quantities of NaCl, we find that as soon as the solution contains 17 or more molecules of NaCl to one molecule of KCl, the toxic action of KCl is considerably diminished, if not completely counteracted. The following table may serve as an example:

TABLE III

AFTER DAYS	NUMBER OF SURVIVING FISH IN 2.2 C.C. M/2 KCl IN 100 C.C.							
	H.O	m/100	m/20	m/8	m/4	3 m/8	m/2	NaCl
1.....	2	1	3	4	6	6	6	
2.....	0	0	0	0	6	5	6	
3.....	..	..	..	..	6	4	6	
4.....	..	..	..	..	5	3	5	
5.....	..	..	..	..	5	3	4	
6.....	..	..	..	..	5	3	1	
7.....	..	..	..	..	5	3	0	
14.....	..	..	..	..	4	3	..	

More accurate determinations showed that already a 3/16 m NaCl solution renders the solution of 2.2 c.c. m/2 KCl in 100 c.c. of the solution harmless.

It was next determined whether different concentrations of KCl required different concentrations of NaCl. It was found that the coefficient of antagonization KCl/NaCl has an approximately constant value, namely, about 1/17, as the following table shows.

TABLE IV

	Coefficient of Antago- nization
0.6 c.c. m/2 KCl rendered harmless in 100 c.c. 3/64 m NaCl...	1/16
0.7 c.c. m/2 KCl rendered harmless in 100 c.c. 4/64 m NaCl...	1/18
0.9 c.c. m/2 KCl rendered harmless in 100 c.c. 5/64 m NaCl...	1/17
1.0 c.c. m/2 KCl rendered harmless in 100 c.c. 5/64-6/64 m NaCl.....	1/16-1/19
1.1 c.c. m/2 KCl rendered harmless in 100 c.c. 6/64 m NaCl...	1/17
1.65 c.c. m/2 KCl rendered harmless in 100 c.c. 5/32 m NaCl...	1/19
2.2 c.c. m/2 KCl rendered harmless in 100 c.c. 6/32 m NaCl...	1/17
2.75 c.c. m/2 KCl rendered harmless in 100 c.c. 7/32 m NaCl...	1/16
3.3 c.c. m/2 KCl rendered harmless in 100 c.c. 9/32 m NaCl...	1/17

What happens if we vary this ratio? If we add too little NaCl to the KCl solution, namely, only 1 to 10 molecules NaCl to 1 molecule of KCl, the solution becomes more harmful than if KCl is alone in solution; if we add considerably more than 17 molecules NaCl, e.g., 50 molecules to one molecule of KCl, the solution becomes toxic again; and the more so the higher the concentration of NaCl. This indicates that the antagonistic effect requires a rather definite ratio of the two salts. This furnishes the reason why an m/2 solution of NaCl can, as a rule, not be rendered completely harmless by the mere addition of KCl, but that in addition CaCl<sub>2</sub> is needed.

If we add to 100 c.c. m/2 NaCl enough KCl to make the ratio KCl:NaCl=1/17 we find that the antagonization of KCl:NaCl becomes incomplete. If the amount of KCl in 100 c.c. of the solution exceeds 2.2 c.c. m/2 KCl, antagonization is still to some extent possible, but it becomes more incomplete the higher the concentration of KCl. For this reason it is not possible to render an m/2 solution of NaCl harmless by the mere addition of KCl.

CaCl<sub>2</sub> acts upon KCl similarly as does NaCl, but it acts more powerfully; i.e., the coefficient of antagonization, KCl/CaCl<sub>2</sub>, is several hundred or a thousand times as great as that of KCl/NaCl, as the following tables shows.



TABLE V

Coefficient of Antagonization KCl/CaCl<sub>2</sub>

1.1	c.c. m/2 KCl in 100 c.c. H <sub>2</sub> O require 0.1 m/100 CaCl <sub>2</sub> . . .	550
1.65	c.c. m/2 KCl in 100 c.c. H <sub>2</sub> O require 0.5 m/100 CaCl <sub>2</sub> . . .	165
2.2	c.c. m/2 KCl in 100 c.c. H <sub>2</sub> O require 0.3 m/100 CaCl <sub>2</sub> . . .	366
2.75	c.c. m/2 KCl in 100 c.c. H <sub>2</sub> O require 1.0 m/100 CaCl <sub>2</sub> . . .	137.5
3.3	c.c. m/2 KCl in 100 c.c. H <sub>2</sub> O require 1.6 m/100 CaCl <sub>2</sub> . . .	103

The coefficients are not as regular as in the case of antagonization of KCl by NaCl. This is due to the fact that the minimal value of CaCl<sub>2</sub> at which it renders the KCl harmless cannot be determined as sharply as the limit for NaCl. Why is less CaCl<sub>2</sub> required than NaCl? We can only answer with a suggestion first offered by T. B. Robertson, namely, that CaCl<sub>2</sub> produces its protective effect through the formation of a comparatively insoluble compound (in this case on the gills or the rest of the surface of the animal) while NaCl acts through the formation of a compound which is more soluble. This view is corroborated by the observation which we made, that Sr is just as effective to antagonize KCl as CaCl<sub>2</sub>, but that Mg is much less efficient. This would correspond with the well-known fact that many strontium salts are just as insoluble, if not more insoluble, than the calcium salts, while the magnesium salts are often incomparably more soluble, for instance, in the case of the sulphates. BaCl<sub>2</sub> antagonizes KCl also powerfully, but, probably, in consequence of the fact that the substances formed at the surface of the animal or the gills, diffuse slowly into the cells, the fish do not remain alive as long if Ba is used as if the more harmless Ca and Sr are used.

It is very remarkable that CaCl<sub>2</sub> renders harmless any given concentration of KCl below 6.6 c.c. m/2 KCl in 100 c.c. of the solution, but not above this limit. This limit is exactly the same which we found in the case of antagonization of KCl by NaCl. Even the combination of NaCl and CaCl<sub>2</sub> does not permit us to render harmless more than 6.6 c.c. m/2 KCl in 100 c.c. of the solution.

If we try to render NaCl harmless by KCl and CaCl<sub>2</sub> we find that CaCl<sub>2</sub> can antagonize even a 6/8 m and a 7/8 m solution of NaCl, while KCl ceases to show any antagonistic effect if the NaCl solution exceeds m/2 or 5/8 m.

Experiments with pure CaCl<sub>2</sub> solutions give the result that this substance is harmless in a solution of that concentration in which this salt is contained in the sea-water. *Fundulus* can live indefinitely in a solution of 1.5 c.c. m/2 CaCl<sub>2</sub> in 100 c.c. Botanists have also found that weak solutions of CaCl<sub>2</sub> are comparatively little toxic. This gives us the impression that the effect upon the surface film of protoplasm produced by CaCl<sub>2</sub> is especially important for the protection of the protoplasm. This conclusion receives an indirect support by the well-known experiments of Herbst, who found that in sea-water deprived of calcium the segmentation cells of a sea-urchin embryo fall apart through the disintegration or liquefaction of a film which surrounds the embryo and keeps the cells together. If such eggs are brought back into solution containing calcium the film is restored and the cells come into close contact again.

It is therefore not impossible that the mechanism of the antagonism between KCl and NaCl is similar to that found between NaCl and ZnSO<sub>4</sub>. It seems only due to the high concentration of the NaCl in the sea-water and in the blood that, in addition to KCl and NaCl, CaCl<sub>2</sub> is needed. But the case is not so unequivocal as the previously mentioned cases of antagonism between only two electrolytes.

## VIII

It is necessary for our understanding of the life-preserving action of salts that we do not depend merely on *conclusions* drawn from experiments, but that we must be able to see directly in which way abnormal salt solutions cause the death of the cell. Such an opportunity is offered us through the

observation of the eggs of the sea-urchin. If we put the fertilized eggs of the sea-urchin into an abnormal salt solution, a destruction of the cell gradually takes place. The destruction, as a rule, begins on the surface of the protoplasm, and consists very often in the formation and falling off of small granules or droplets. This process gradually continues from the periphery toward the center until the whole egg is disintegrated. For different salt solutions the picture of the disintegration is a little different, but sufficiently characteristic for a given solution, so that if one become familiar with these pictures, one is able to diagnose to some extent the nature of the solution from the way in which the cell disintegrates.

This process of disintegration can be observed if the eggs are put into a pure solution of sodium chloride, or in a mixture of sodium chloride and calcium chloride, or in a mixture of sodium chloride and potassium chloride. If, however, all three salts are used in the proportion in which they occur in the sea-water no disintegration takes place and the surface of the egg remains perfectly smooth and normal. One gains the impression as if the protoplasm of the egg were held together by a continuous surface film of a definite texture. If we put the egg into an abnormal solution this surface film is modified and changed, and the change of the surface film is often followed by a gradual process of disintegration of the rest of the cell.

These observations on the sea-urchin egg, therefore, suggest the possibility that the combination of the three salts in their definite proportion and concentration has the function of forming a surface film of a definite structure or texture, around the protoplasm of each cell, by which the protoplasm is kept together, protected against and separated from the surrounding media.

The previously mentioned observation of Herbst again shows the important rôle of calcium in this process.

## IX

The objection might be raised that the beneficial action of the three salts could only be proved on marine animals or on tissues of higher animals, which are said to be "adapted" to a mixture of NaCl, KCl, and CaCl<sub>2</sub> in definite proportions. Experiments on fresh-water organisms, for which "adaptation" to a mixture of NaCl, KCl, and CaCl<sub>2</sub> in these definite proportions cannot be claimed, show that this objection is not valid. Ostwald worked with fresh-water crustaceans which he put into mixtures of various salts. It was found that these animals live longer in a mixture of NaCl+KCl+CaCl<sub>2</sub> than in a solution of NaCl, or NaCl+KCl, or NaCl+CaCl<sub>2</sub> of the same osmotic pressure.

Osterhout was able to show that the spores of a certain variety of *Vaucheria* die in a pure 3/32 m solution of NaCl in 10 to 20 minutes, while they live in 100 c.c. 3/32 m NaCl+1 c.c. 3/32 CaCl<sub>2</sub> 2 to 4 weeks, and in 100 c.c. 3/32 m NaCl+1 c.c. 3/32 m CaCl<sub>2</sub>+2.2 c.c. 3/32 m KCl 6 to 8 weeks. The reaction of the solution was strictly neutral and the NaCl the purest obtainable. The results remained the same after the NaCl had been recrystallized six times. Experiments with *Spirogyra* gave a similar result. The solutions were all 3/32 m. In NaCl the *Spirogyra* died in 18 hours; in NaCl+KCl in two days; in NaCl+KCl+CaCl<sub>2</sub> they lived 65 days. Osterhout caused wheat grains to develop in such solutions and measured the total length of the roots formed.

Nature of the Solution	Total Length of Roots after 40 Days
H <sub>2</sub> O. . . . .	740 mm.
100 c.c. 3/25 NaCl. . . . .	59 mm.
100 c.c. 3/25 NaCl+2.0 3/25 CaCl <sub>2</sub> . . . . .	254 mm.
100 c.c. 3/25 NaCl+2.0 3/25 CaCl <sub>2</sub> +2.2 3/25 m KCl. . . . .	324 mm.

These cases, to which many other similar observations might be added, prove that the life-preserving effect of the combination of NaCl+KCl+CaCl<sub>2</sub> in definite proportions is not due

to the fact that organisms are "adapted" to this mixture but to a specific protective effect of the combination of the three salts upon the cells.

### X

It seems, therefore, to be a general fact that wherever tissues or animals require a medium of a comparatively high osmotic pressure—like our tissues—their life lasts much longer in a mixture of  $\text{NaCl} + \text{KCl} + \text{CaCl}_2$  in the proportion in which these salts exist in the blood and in the ocean, than in any other osmotic solution, even a pure solution of  $\text{NaCl}$ . But the reader has noticed that there are considerable differences in the resistance of various organisms to abnormal solutions. While a marine *Gammarus* dies in half an hour in an isotonic solution of  $\text{NaCl}$  or cane sugar, red blood corpuscles or even the muscle of a frog can be kept for a day or longer in such a solution (of course even the muscle of a frog lives longer if the  $\text{NaCl}$  solution contains in addition  $\text{KCl}$  or  $\text{CaCl}_2$ ). What causes this difference?

Six years ago I found that the *unfertilized* eggs of the sea-urchin (*Strongylocentrotus purpuratus*) can keep alive and remain apparently intact in a pure neutral solution of  $\text{CaCl}_2$  or of  $\text{NaCl}$  for several days at a temperature of  $15^\circ$ , while the *fertilized* eggs of the same female are killed in a pure neutral solution of  $\text{CaCl}_2$  in a few hours. The same difference is found for other salts also. What causes this difference? Several authors have suggested that it is due to the fact that the fertilized egg is more permeable to salts than the unfertilized egg. But recent experiments by Warburg, which were confirmed and amplified by Harvey, make it doubtful whether the salts which are not soluble in fats can enter the fertilized egg at all. I believe that the explanation of the difference is much more simple. The unfertilized egg is surrounded by a cortical layer and this layer is destroyed or modified in the process of fertilization. One result of this modification is the formation of the fertilization membrane, for which I have been able to

show that it is readily permeable for salts. As long as the cortical layer of the unfertilized egg is intact, it prevents the surrounding salt solution from coming in contact with the protoplasm or at least it retards this process. If, however, the cortical layer is destroyed by fertilization the surrounding salt solution comes directly in contact with the protoplasm and if the solution is abnormal it can cause the disintegration of the surface layer of the protoplasm.

I am inclined to believe that differences in the resisting power of various cells or organisms to abnormal salt solutions are primarily due to differences in the constitution of the protective envelopes of the animals or the cells. Microorganisms which can live in strong organic acids or salt solutions of a high concentration probably possess a surface layer which shuts off their protoplasm from contact with the solution. For the protoplasm of muscle the rather tough sarcolemma forms not an absolute but nevertheless an effective wall against the surrounding solution.

But aside from differences of this kind there are other conditions which influence the degree of resistance of cells to various solutions. I have found that the fertilized eggs of the sea-urchin will live longer in abnormal salt solutions if the oxidations in the egg are stopped, either by the withdrawal of oxygen or the addition of KCN or NaCN. Warburg and Meyerhof have drawn the conclusion that in a pure NaCl solution the rate of oxidations of the egg of *Strongylocentrotus* is increased and that it is this increase in the rate of oxidations which kills the eggs. But this increase of oxidations cannot be observed in the eggs of *Arbacia* when they are put into a pure NaCl solution and, moreover, lack of oxygen prolongs the life of the fertilized egg just as well in solutions of NaCl+CaCl<sub>2</sub> or of NaCl+BaCl<sub>2</sub>, for which salts these authors do not claim that they can raise the rate of oxidations of the egg. I am inclined to believe that during or previously to cell-division, besides

phenomena of streaming inside the cell, changes in the surface film of the protoplasm occur, whereby this film is more easily injured by the salts. If we suppress the oxidations we suppress also the processes leading to cell-division and thereby retard the deleterious action of the abnormal salt solution upon the surface layer of the protoplasm of the egg.

## XI

If we now raise the question as to why salts are necessary for the preservation of the life of the cell we can point to a number of cases in which this answer seems clear. Each cell may be considered a chemical factory, in which the work can only go on in the proper way, if the diffusion of substances through the cell-wall is restricted. This diffusion depends on the nature of the surface layer of the cell. Overton and others assume that this layer consists of a continuous membrane of fat or lipoids. This assumption is not compatible with two facts, namely, that water diffuses very rapidly into the cell, and second, that life depends upon an exchange of water-soluble and not of fat-soluble substances between the cells and the surrounding liquid. The above-mentioned facts of the antagonism between acids and salts suggest the idea that the surface film of cells consists exclusively or essentially of certain proteins.

The experiments mentioned in this paper indicate that the rôle of salts in the preservation of life consists in the "tanning" effect which they have upon the surface films of the cells, whereby these films acquire those physical qualities of durability and comparative impermeability, without which the cell cannot exist.

On this assumption we can understand that neutral salts should be necessary for the preservation of life although they do not furnish energy.

As far as the dynamical effects of salts are concerned it is

not impossible that some of them belong also to the type of those mentioned in this paper. The fact that the addition of calcium to an NaCl solution prevents the twitchings of the muscle, which occur in the pure NaCl solution, suggests the possibility that the CaCl<sub>2</sub> merely prevents or retards the diffusion of NaCl through the sarcolemma. But other effects of salts, e.g., the apparent dependence of contractility of the muscle upon the presence of NaCl, or the rôle of PO<sub>4</sub>, do not find their explanation in the facts discussed here.



X. EXPERIMENTAL STUDY OF THE INFLUENCE  
OF ENVIRONMENT ON ANIMALS



## X

### EXPERIMENTAL STUDY OF THE INFLUENCE OF ENVIRONMENT ON ANIMALS<sup>1</sup>

#### I. INTRODUCTORY REMARKS

What the biologist calls the natural environment of an animal is from a physical point of view a rather rigid combination of definite forces. It is obvious that by a purposeful and systematic variation of these and by the application of other forces in the laboratory, results must be obtainable which do not appear in the natural environment. This is the reasoning underlying the modern development of the study of the effect of environment upon animal life. It was perhaps not the least important of Darwin's services to science that the boldness of his conceptions gave to the experimental biologist courage to enter upon the attempt of controlling at will the life phenomena of animals, and of bringing about effects which cannot be expected in nature.

The systematic physico-chemical analysis of the effect of outside forces upon the form and reactions of animals is also our only means of unraveling the mechanism of heredity beyond the results which can be obtained by a mere cytological investigation. The manner in which a germ cell can force upon the adult certain characters will not be understood until we succeed in varying and controlling hereditary characteristics; and this can only be accomplished on the basis of a systematic study of the effects of chemical and physical forces upon living matter.

Owing to limitation of space this sketch is necessarily very incomplete, and it must not be inferred that studies which are

<sup>1</sup> Reprinted from *Darwin and Modern Science* (1909), by courtesy of Professor A. C. Seward, of the University of Cambridge, England.

not mentioned here were considered to be of minor importance. All the writer could hope to do was to bring together a few instances of the experimental analysis of the effect of environment, which indicate the nature and extent of our control over life phenomena and which also have some relation to the work of Darwin. In the selection of these instances preference is given to those problems which are not too technical for the general reader.

The forces, the influence of which we shall discuss, are in succession chemical agencies, temperature, light, and gravitation. We shall also treat separately the effect of these forces upon form and instinctive reactions.

## II. THE EFFECTS OF CHEMICAL AGENCIES

a) *Heterogeneous hybridization*.—It was held until recently that hybridization is not possible except between closely related species and that even among these a successful hybridization cannot always be counted upon. This view was well supported by experience. It is, for instance, well known that the majority of marine animals lay their unfertilized eggs in the ocean and that the males shed their sperm also into the sea-water. The numerical excess of the spermatozoa over the ova in the sea-water is the only guaranty that the eggs are fertilized, for the spermatozoa are carried to the eggs by chance and are not attracted by the latter. This statement is the result of numerous experiments by various authors, and is contrary to common belief. As a rule all or the majority of individuals of a species in a given region spawn on the same day, and when this occurs the sea-water constitutes a veritable suspension of sperm. It has recently been shown by experiment that in fresh sea-water the sperm may live and retain its fertilizing power for several days. It is thus unavoidable that at certain periods more than one kind of spermatozoa is suspended in the sea-water and it is a matter of surprise that the most heterogeneous hybridizations do not

constantly occur. The reason for this becomes obvious when we bring together mature eggs and equally mature and active sperm of different families. When this is done no egg is, as a rule, fertilized. The eggs of a sea-urchin can be fertilized by sperm of their own species, or, though in smaller numbers, by the sperm of other species of sea-urchins, but not by the sperm of other groups of echinoderms, e.g., star-fish, brittle-stars, holothurians, or crinoids, and still less by the sperm of more distant groups of animals. The consensus of opinion seemed to be that the spermatozoon must enter the egg through a narrow opening or canal, the so-called micropyle, and that the micropyle allowed only the spermatozoa of the same or of a closely related species to enter the egg.

It seemed to the writer that the cause of this limitation of hybridization might be of another kind and that by a change in the constitution of the sea-water it might be possible to bring about heterogeneous hybridizations, which in normal sea-water are impossible. This assumption proved correct. Sea-water has a faintly alkaline reaction (in terms of the physical chemist its concentration of hydroxyl ions is about  $10^{-6}$  n at Pacific Grove, California, and about  $10^{-5}$  n at Woods Hole, Massachusetts). If we slightly raise the alkalinity of the sea-water by adding to it a small but definite quantity of sodium hydroxide or some other alkali, the eggs of the sea-urchin can be fertilized with the sperm of widely different groups of animals. In 1903 it was shown that if we add from about 0.5 to 0.8 c.c. n/10 sodium hydroxide to 50 c.c. of sea-water, the eggs of *Strongylocentrotus purpuratus* (a sea-urchin which is found on the coast of California) can be fertilized in large quantities by the sperm of various kinds of star-fish, brittle-stars, and holothurians; while in normal sea-water or with less sodium hydroxide not a single egg of the same female could be fertilized with the star-fish sperm which proved effective in the hyperalkaline sea-water. The sperm of the various forms

of star-fish was not equally effective for these hybridizations; the sperm of *Asterias ochracea* and *A. capitata* gave the best results, since it was possible to fertilize from 50 per cent to 100 per cent of the sea-urchin eggs, while the sperm of *Pycnopodia* and *Asterina* fertilized only 10 or 2 per cent respectively of the same eggs.

Godlewski used the same method for the hybridization of the sea-urchin eggs with the sperm of a crinoid (*Antedon rosacea*). Kupelwieser afterward obtained results which seemed to indicate the possibility of fertilizing the eggs of *Strongylocentrotus* with the sperm of a mollusk (*Mytilus*). Recently, the writer succeeded in fertilizing the eggs of *Strongylocentrotus franciscanus* with the sperm of a mollusk—*Chlorostoma*. This result could only be obtained in sea-water the alkalinity of which had been increased (through the addition of 0.8 c.c. n/10 sodium hydroxide to 50 c.c. of sea-water). We thus see that by increasing the alkalinity of the sea-water it is possible to effect heterogeneous hybridizations which are at present impossible in the natural environment of these animals.

It is, however, conceivable that in former periods of the earth's history such heterogeneous hybridizations were possible. It is known that in solutions like sea-water the degree of alkalinity must increase when the amount of carbon dioxide in the atmosphere is diminished. If it be true, as Arrhenius assumes, that the Ice age was caused or preceded by a diminution in the amount of carbon dioxide in the air, such a diminution must also have resulted in an increase of the alkalinity of the sea-water, and one result of such an increase must have been to render possible heterogeneous hybridizations in the ocean which in the present state of alkalinity are practically excluded.

But granted that such hybridizations were possible, would they have influenced the character of the fauna? In other words, are the hybrids between sea-urchin and star-fish, or better still, between sea-urchin and mollusks, capable of development,

and if so, what is their character? In all cases of heterogeneous hybridization the vitality of the egg or the embryo seems weakened and it is still doubtful whether any heterogeneous hybrid can reach maturity. The number of experiments is still limited and this statement is therefore not yet final.

So far as the question of heredity is concerned, all the experiments on heterogeneous hybridization of the egg of the sea-urchin with the sperm of star-fish, brittle-stars, crinoids, and mollusks have led to the same result, namely, that the larvae have purely maternal characteristics and differ in no way from the pure breed of the form from which the egg is taken. By way of illustration it may be said that the larvae of the sea-urchin reach on the third day or earlier (according to species and temperature) the so-called pluteus stage, in which they possess a typical skeleton (Fig. 10, p. 11); while neither the larvae of the star-fish nor those of the mollusk form a skeleton at the corresponding stage. It was, therefore, a matter of some interest to find out whether or not the larvae produced by the fertilization of the sea-urchin egg with the sperm of star-fish or mollusk would form the normal and typical pluteus skeleton. This was invariably the case in the experiments of Godlewski, Kupelwieser, Hagedoorn, and the writer. These hybrid larvae were exclusively maternal in character.

It might be argued that in the case of heterogeneous hybridization the sperm nucleus does not fuse with the egg nucleus, and that, therefore, the spermatozoon cannot transmit its hereditary substances to the larvae. But these objections are refuted by Godlewski's experiments, in which he showed definitely that if the egg of the sea-urchin is fertilized with the sperm of a crinoid the fusion of the egg nucleus and sperm nucleus takes place in the normal way.

b) *Artificial parthenogenesis*.—Possibly in no other field of biology has our ability to control life phenomena by outside conditions been proved to such an extent as in the domain of

fertilization. The reader knows that the eggs of the overwhelming majority of animals cannot develop unless a spermatozoon enters them. In this case a living agency is the cause of development and the problem arises whether it is possible to accomplish the same result through the application of well-known physico-chemical agencies. This is, indeed, true, and during the last ten years living larvae have been produced by chemical agencies from the unfertilized eggs of sea-urchins, star-fish, holothurians, and a number of annelids and mollusks; in fact this holds true in regard to the eggs of practically all forms of animals with which such experiments have been tried long enough. In each form the method of procedure is somewhat different and a long series of experiments is often required before the successful method is found.

The facts of artificial parthenogenesis, as the chemical fertilization or activation of the egg is called, have, perhaps, some bearing on the problem of evolution. If we wish to form a mental image of the process of evolution we have to reckon with the possibility that parthenogenetic propagation may have preceded sexual reproduction. This suggests also the possibility that at that period outside forces may have supplied the conditions for the development of the egg which at present the spermatozoon has to supply. For this, if for no other reason, a brief consideration of the means of artificial parthenogenesis may be of interest to the student of evolution.

It seemed necessary in these experiments to imitate as completely as possible by chemical agencies the effects of the spermatozoon upon the egg. When a spermatozoon enters the egg of a sea-urchin or certain star-fish or annelids, the immediate effect is a characteristic change of the surface of the egg, namely, the formation of the so-called membrane of fertilization (Figs. 1 and 2). The writer found that we can produce this membrane in the unfertilized egg by certain acids, especially the monobasic acids of the fatty series, e.g., formic, acetic, propionic,



butyric, etc. Carbon dioxide is also very efficient in this direction. It was also found that the higher acids are more efficient than the lower ones, and it is possible that the spermatozoon induces membrane formation by carrying into the egg a higher fatty acid, namely oleic acid or one of its salts or esters.

The physico-chemical process which underlies the formation of the membrane seems to be the cause of the development of the egg. In all cases in which the unfertilized egg has been treated in such a way as to cause it to form a membrane it begins to develop. For the eggs of certain animals membrane formation is all that is required to induce a complete development of the unfertilized egg, e.g., in the star-fish and certain annelids. For the eggs of other animals a second treatment is necessary. Thus the unfertilized eggs of the sea-urchin *Strongylocentrotus purpuratus* of the Californian coast begin to develop when membrane formation has been induced by treatment with a fatty acid, e.g., butyric acid; but the development soon ceases and the eggs perish in the early stages of segmentation, or after the first nuclear division. But if we treat the same eggs after membrane formation, for from thirty-five to fifty-five minutes (at 15° C.) with sea-water the concentration (osmotic pressure) of which has been raised through the addition of a definite amount of some salt or sugar, the eggs will segment and develop normally, when transferred back to normal sea-water. If care is taken, practically all the eggs can be caused to develop into plutei, the majority of which may be perfectly normal and may live as long as larvae produced from eggs fertilized with sperm.

It is possible that the sea-urchin egg is injured in the process of membrane formation. The nature of this injury became clear when it was discovered that all the agencies which cause hemolysis, i.e., the destruction of the red blood corpuscles, also cause membrane formation in unfertilized eggs, e.g., fatty acids or ether, alcohols or chloroform, etc., or saponin, solanin, digitalin, bile salts, and alkali. It thus happens that the

phenomena of artificial parthenogenesis are linked together with the phenomena of hemolysis which at present play so important a rôle in the study of immunity. The difference between cytolysis (or hemolysis) and fertilization seems to be this, that the latter is caused by a superficial cytolysis of the egg, while if the cytolytic agencies have time to act on the whole egg the latter is completely destroyed. If we put unfertilized eggs of a sea-urchin into sea-water which contains a trace of saponin we notice that, after a few minutes, all the eggs form the typical membrane of fertilization. If the eggs are then taken out of the saponin solution, freed from all traces of saponin by repeated washing in normal sea-water, and transferred to the hypertonic sea-water for from thirty-five to fifty-five minutes, they develop into larvae. If, however, they are left in the sea-water containing the saponin they undergo, a few minutes after membrane formation, the disintegration known in pathology as *cytolysis*. Membrane formation is, therefore, caused by a superficial or incomplete cytolysis. It is possible that the subsequent treatment of the egg with hypertonic sea-water is partly needed to overcome the destructive effects of this cytolysis of the cortical layer.

Many pathologists assume that hemolysis or cytolysis is due to a liquefaction of certain fatty or fat-like compounds, the so-called lipoids, in the cell. If this view is correct, it would be necessary to ascribe the fertilization of the egg to the same process.

The analogy between hemolysis and fertilization throws, possibly, some light on a curious observation. It is well known that the blood corpuscles, as a rule, undergo cytolysis if injected into the blood of an animal which belongs to a different family. The writer found last year that the blood of mammals, e.g., the rabbit, pig, and cattle, causes the egg of *Strongylocentrotus* to form a typical fertilization membrane. If such eggs are afterward treated for a short period with hypertonic sea-water they

develop into normal larvae (plutei). Some substance contained in the blood causes, presumably, a superficial cytolysis of the egg and thus starts its development.

We can also cause the development of the sea-urchin egg without membrane formation. The early experiments of the writer were done in this way and many experimenters still use such methods. It is probable that in this case the mechanism of fertilization is essentially the same as in the case where the membrane formation is brought about, with this difference only, that the cytolytic effect is less when no fertilization membrane is formed. This inference is corroborated by observations on the fertilization of the sea-urchin egg with ox blood. It very frequently happens that not all of the eggs form membranes in this process. Those eggs which form membranes begin to develop, but perish if they are not treated with hypertonic sea-water. Some of the other eggs, however, which do not form membranes, develop directly into normal larvae without any treatment with hypertonic sea-water, provided they are exposed to the blood for only a few minutes. Presumably some blood enters the eggs and causes the cytolytic effects in a less degree than is necessary for membrane formation, but in a sufficient degree to cause their development. The slightness of the cytolytic effect allows the egg to develop without treatment with hypertonic sea-water.

Since the entrance of the spermatozoon causes that degree of cytolysis which leads to membrane formation, it is probable that, in addition to the cytolytic or membrane-forming substance (presumably a higher fatty acid), it carries another substance into the egg which counteracts the deleterious effects underlying or following membrane formation.

The question may be raised whether the larvae produced by artificial parthenogenesis can reach the mature stage. This question may be answered in the affirmative, since Delage has succeeded in raising several parthenogenetic sea-urchin larvae

beyond the metamorphosis into the adult stage and since in all the experiments made by the writer the parthenogenetic plutei lived as long as the plutei produced from fertilized eggs.

c) *On the production of twins from one egg through a change in the chemical constitution of the sea-water.*—The reader is probably familiar with the fact that there exist two different types of human twins. In the one type the twins differ as much as two children of the same parents born at different periods; they may or may not have the same sex. In the second type the twins have invariably the same sex and resemble each other most closely. Twins of the latter type are produced from the same egg, while twins of the former type are produced from two different eggs.

The experiments of Driesch and others have taught us that twins originate from one egg in this manner, namely, that the first two cells into which the egg divides after fertilization become separated from each other. This separation can be brought about by a change in the chemical constitution of the sea-water. Herbst observed that if the fertilized eggs of the sea-urchin are put into sea-water which is freed from calcium, the cells into which the egg divides have a tendency to fall apart. Driesch afterward noticed that eggs of the sea-urchin treated with sea-water which is free from lime have a tendency to give rise to twins. The writer has recently found that twins can be produced not only by the absence of lime, but also through the absence of sodium or of potassium; in other words, through the absence of one or two of the three important metals in the sea-water. There is, however, a second condition, namely that the solution used for the production of twins must have a neutral or at least not an alkaline reaction.

The procedure for the production of twins in the sea-urchin egg consists simply in this: the eggs are fertilized as usual in normal sea-water and then, after repeated washing in a neutral solution of sodium chloride (of the concentration of the sea-

water), are placed in a neutral mixture of potassium chloride and calcium chloride, or of sodium chloride and potassium chloride, or of sodium chloride and calcium chloride, or of sodium chloride and magnesium chloride. The eggs must remain in this solution until half an hour or an hour after they have reached the two-cell stage. They are then transferred into normal sea-water and allowed to develop. From 50 to 90 per cent of the eggs of *Strongylocentrotus purpuratus* treated in this manner may develop into twins. These twins may remain separate or grow partially together and form double monsters, or heal together so completely that only slight or even no imperfections indicate that the individual started its career as a pair of twins. It is also possible to control the tendency of such twins to grow together by a change in the constitution of the sea-water. If we use as a twin-producing solution a mixture of sodium, magnesium, and potassium chlorides (in the proportion in which these salts exist in the sea-water) the tendency of the twins to grow together is much more pronounced than if we use simply a mixture of sodium chloride and magnesium chloride.

The mechanism of the origin of twins, as the result of altering the composition of the sea-water, is revealed by observation of the first segmentation of the egg in these solutions. This cell-division is modified in a way which leads to a separation of the first two cells (see Figs. 55 to 57). If the egg is afterward transferred back into normal sea-water, each of these two cells develops into an independent embryo. Since normal sea-water contains all three metals, sodium, calcium, and potassium, and since it has besides an alkaline reaction, we perceive the reason why twins are not normally produced from one egg. These experiments suggest the possibility of a chemical cause for the origin of twins from one egg or of double monstrosities in mammals. If, for some reason, the liquids which surround the human egg a short time before and after the first cell-division

are slightly acid, and at the same time lacking in one of the three important metals, the conditions for the separation of

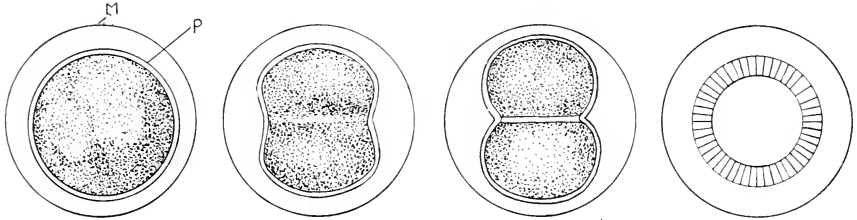

FIG. 51

FIG. 52

FIG. 53

FIG. 54

FIGS. 51-54.—Cell-division in a sea-urchin egg, *Strongylocentrotus purpuratus*, in normal sea-water. This type of cell-division leads to the formation of one embryo from an egg. *M* is the fertilization membrane, *P* a layer of colloidal substance which seems to serve the purpose of keeping all the cells of an egg together.

the first two cells and the formation of identical twins are provided.

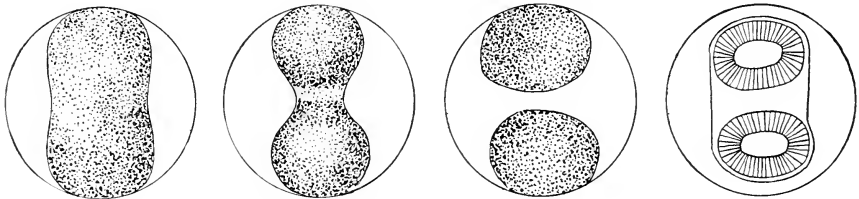

FIG. 55

FIG. 56

FIG. 57

FIG. 58

FIGS. 55-58.—Cell-division in the egg of *Strongylocentrotus purpuratus* which leads to the formation of twins. This cell-division can be observed if the egg is put after fertilization into a neutral mixture of salts in which either KCl, or  $\text{CaCl}_2$ , or NaCl is lacking.

In such a neutral solution the substance which forms the elastic layer (*PM*, Fig. 51) is dissolved. During the segmentation the protoplasm of the egg spreads until its long axis touches the fertilization membrane. The two daughter-cells formed (Fig. 57) are separated from each other, instead of remaining connected as in the normal cell-division (Fig. 53). If about one hour later the eggs are put back into normal sea-water each of the two cells develops into an embryo (Fig. 58), and the egg thus gives rise to two instead of to one embryo.

In conclusion it may be pointed out that the reverse result, namely, the fusion of normally double organs, can also be brought about experimentally through a change in the chemical constitution of the sea-water. Stockard succeeded in causing

the two eyes of a fish embryo (*Fundulus heteroclitus*) to fuse into a single cyclopean eye through the addition of magnesium chloride to the sea-water. When he added about 6 grams of magnesium chloride to 100 c.c. of sea-water and placed the fertilized eggs in the mixture, about 50 per cent of the eggs gave rise to one-eyed embryos.

When the embryos were studied the one-eyed condition was found to result from the union or fusion of the "Anlagen" of the two eyes. Cases were observed which showed various degrees in this fusion; it appeared as though the optic vesicles were formed too far forward and ventral, so that their antero-ventro-median surfaces fused. This produces one large optic cup, which in all cases gives more or less evidence of its double nature.<sup>1</sup>

We have confined ourselves to a discussion of rather simple effects of the change in the constitution of the sea-water upon development. It is a priori obvious, however, that an unlimited number of pathological variations might be produced by a variation in the concentration and constitution of the sea-water, and experience confirms this statement. As an example we may mention the abnormalities observed by Herbst in the development of sea-urchins through the addition of lithium to sea-water. It is, however, as yet impossible to connect in a rational way the effects produced in this and similar cases with the cause which produced them; and it is also impossible to define in a simple way the character of the change produced.

### III. THE INFLUENCE OF TEMPERATURE

a) *The influence of temperature upon the density of pelagic organisms and the duration of life.*—It has often been noticed by explorers who have had a chance to compare the faunas in different climates that in the polar seas such species as thrive at all in those regions occur, as a rule, in much greater density than they do in the moderate or warmer regions of the ocean. This refers to those members of the fauna which live at or near

<sup>1</sup> Stockard, *Archiv f. Entwicklungsmechanik*, XXIII, 249, 1907.

the surface, since they alone lend themselves to a statistical comparison. In his account of the Valdivia expedition, Chun<sup>1</sup> calls especial attention to this quantitative difference in the surface fauna and flora of different regions. "In the icy water of the Antarctic, the temperature of which is below 0° C., we find an astonishingly rich animal and plant life. The same condition with which we are familiar in the Arctic seas is repeated here, namely, that the quantity of plankton material exceeds that of the temperate and warm seas." And again, in regard to the pelagic fauna in the region of the Kerguelen Islands, he states: "The ocean is alive with transparent jelly fish, Ctenophores (*Bolina* and *Callianira*) and of Siphonophore colonies of the genus *Agalma*."

The paradoxical character of this general observation lies in the fact that a low temperature retards development, and hence should be expected to have the opposite effect from that mentioned by Chun. Recent investigations have led to the conclusion that life phenomena are affected by temperature in the same sense as the velocity of chemical reactions. In the case of the latter van't Hoff had shown that a decrease in temperature by 10 degrees reduces their velocity to one-half or less, and the same has been found for the influence of temperature on the velocity of physiological processes. Thus Snyder and T. B. Robertson found that the rate of heart beat in the tortoise and in *Daphnia* is reduced to about one-half if the temperature is lowered 10° C., and Maxwell, Keith Lucas, and Snyder found the same influence of temperature for the rate with which an impulse travels in the nerve. Peter observed that the rate of development in a sea-urchin's egg is reduced to less than one-half if the temperature (within certain limits) is reduced by 10 degrees. The same effect of temperature upon the rate of development holds for the egg of the frog, as Cohen and Peter calculated from the experiments of O. Hertwig.

<sup>1</sup> Chun, *Aus den Tiefen des Weltmeeres*, p. 225, Jena, 1903.



The writer found the same temperature coefficient for the rate of maturation of the egg of a mollusk (*Lottia*).

All these facts prove that the velocity of development of animal life in Arctic regions, where the temperature is near the freezing point of water, must be from two to three times smaller than in regions where the temperature of the ocean is about  $10^{\circ}$  C., and from four to nine times smaller than in seas the temperature of which is about  $20^{\circ}$  C. It is, therefore, exactly the reverse of what we should expect when authors state that the density of organisms at or near the surface of the ocean in polar regions is greater than in more temperate regions.

The writer believes that this paradox finds its explanation in experiments which he has recently made on the influence of temperature on the duration of life of cold-blooded marine animals. The experiments were made on the fertilized and unfertilized eggs of the sea-urchin, and yielded the result that for the lowering of temperature by  $1^{\circ}$  C., the duration of life was about doubled. Lowering the temperature by 10 degrees therefore prolongs the life of the organism  $2^{10}$ , i.e., over a thousand times, and a lowering by 20 degrees prolongs it about one million times. Since this prolongation of life is far in excess of the retardation of development through a lowering of temperature, it is obvious that, in spite of the retardation of development in Arctic seas, animal life must be denser there than in temperate or tropical seas. The excessive increase of the duration of life at the poles will necessitate the simultaneous existence of more successive generations of the same species in these regions than in the temperate or tropical regions.<sup>1</sup>

The writer is inclined to believe that these results have some bearing upon a problem which plays an important rôle in theories of evolution, namely, the cause of natural death.

<sup>1</sup> The high coefficient of temperature of the duration of life may possibly only be found near the upper temperature limit for the life of organisms. But this is sufficient for our theory.

It has been stated that the processes of differentiation and development lead also to the natural death of the individual.<sup>1</sup> If we express this in chemical terms it means that the chemical processes which underlie development also determine natural death. Physical chemistry has taught us to identify two chemical processes even if only certain of their features are known. One of these means of identification is the temperature coefficient. When two chemical processes are identical, their velocity must be reduced by the same amount if the temperature is lowered to the same extent. The temperature coefficient for the duration of life of cold-blooded organisms seems, however, to differ enormously from the temperature coefficient for their rate of development. For a difference in temperature of 10° C., the duration of life is altered five hundred times as much as the rate of development; and, for a change of 20° C., it is altered more than a hundred thousand times as much. From this we may conclude that, at least for the sea-urchin eggs and embryo, the chemical processes which determine natural death are certainly not identical with the processes which underlie their development. T. B. Robertson has also arrived at the conclusion, for quite different reasons, that the process of senile decay is essentially different from that of growth and development.

<sup>1</sup> Weismann showed that infusorians or unicellular organisms in general are immortal, while he assumed that all the other organisms with the exception of their germ-plasm are mortal. Leo Loeb first called attention to the fact that the transplantation of a cancer can be repeated to an unlimited series of generations, and since it is the originally transplanted cancer-cell and the cells derived from it by multiplication that survive, he pointed out that this proved that the principle of immortality must also be granted to cancer-cells (1901). Later he generalized this idea and stated that other cells may be considered immortal in the same sense in which Weismann claimed this for the unicellular organisms. One can indeed well imagine that the same piece of skin might be transplanted through an indefinite series of generations of mice and that such a transplanted piece might outlive an indefinite number of generations of mice in exactly the same way as a cancer cell does.

The natural death of the metazoa is perhaps a secondary phenomenon due to the cessation of respiratory motions or of the heart beat. This leads to the death of the cells through lack of oxygen. If respiratory motions and circulation could be maintained indefinitely even the metazoa might be found to be immortal.

b) *Changes in the color of butterflies produced through the influence of temperature.*—The experiments of Dorfmeister, Weismann, Merrifield, Standfuss, and Fischer on seasonal dimorphism and the aberration of color in butterflies have so often been discussed in biological literature that a short reference to them will suffice. By seasonal dimorphism is meant the fact that species may appear at different seasons of the year in a somewhat different form or color. *Vanessa prorsa* is the summer form, *Vanessa levana* the winter form of the same species. By keeping the pupae of *Vanessa prorsa* several weeks at a temperature of from 0° to 1° Weismann succeeded in obtaining from the summer chrysalids specimens which resembled the winter variety, *Vanessa levana*.

If we wish to get a clear understanding of the causes of variation in the color and pattern of butterflies, we must direct our attention to the experiments of Fischer, who worked with more extreme temperatures than his predecessors, and found that almost identical aberrations of color could be produced by both extremely high and extremely low temperatures. This can be seen clearly from the following tabulated results of his observations. At the head of each column the temperature to which Fischer submitted the pupae is given, and in the vertical column below are found the varieties that were produced. In the vertical column A are given the normal forms:

0° to - 20° C.	0° to + 10° C.	A (Normal Forms)	+ 35° to + 37° C.	+ 36° to + 41° C.	+ 42° to + 46° C.
ichnusoides (nigrita)	polaris	urticae	ichnusa	polaris	ichnusoides (nigrita)
antigone (iokaste)	fischeri	io	.....	fischeri	antigone (iokaste)
testudo	dixeyi	poly-chloros	erythromelas	dixeyi	testudo
hygiaea elymi	artemis wiskotti	antiopa cardui	epione	artemis wiskotti	hygiaea elymi
klymene	merrifieldi	atalanta	.....	merrifieldi	klymene
weismanni	porima	prorsa	.....	porima	weismanni

The reader will notice that the aberrations produced at a very low temperature (from  $0^{\circ}$  to  $-20^{\circ}$  C.) are absolutely identical with the aberrations produced by exposing the pupae to extremely high temperatures (from  $42^{\circ}$  to  $46^{\circ}$  C.). Moreover the aberrations produced by a moderately low temperature (from  $0^{\circ}$  to  $10^{\circ}$  C.) are identical with the aberrations produced by a moderately high temperature (from  $36^{\circ}$  to  $41^{\circ}$  C.).

From these observations Fischer concludes that it is erroneous to speak of a specific effect of high and of low temperatures, but that there must be a common cause for the aberration found at the high as well as at the low temperature limits. This cause he seems to find in the inhibiting effects of extreme temperatures upon development.

If we try to analyze such results as Fischer's from a physico-chemical point of view, we must realize that what we call life consists of a series of chemical reactions, which are connected in a catenary way; inasmuch as one reaction or group of reactions (*a*) (e.g., hydrolyses) causes or furnishes the material for a second reaction or group of reactions, (*b*) (e.g., oxidations). We know that the temperature coefficient for physiological processes varies slightly at various parts of the scale; as a rule it is higher near  $0^{\circ}$  and lower near  $30^{\circ}$ . But we know also that the temperature coefficients do not vary equally for the various physiological processes. It is, therefore, to be expected that the temperature coefficients for the group of reactions of the type (*a*) will not be identical through the whole scale with the temperature coefficients for the reactions of the type (*b*). If, therefore, a certain substance is formed at the normal temperature of the animal in such quantities as are needed for the catenary reaction (*b*), it is not to be expected that this same perfect balance will be maintained for extremely high or extremely low temperatures; it is more probable that one group of reactions will exceed the other and thus produce aberrant

chemical effects, which may underlie the color aberrations observed by Fischer and other experimenters.

It is important to notice that Fischer was also able to produce aberrations through the application of narcotics. Wolfgang Ostwald has produced experimentally, through variation of temperature, dimorphism of form in *Daphnia*.

#### IV. THE EFFECTS OF LIGHT

At the present day nobody seriously questions the statement that the action of light upon organisms is primarily one of a chemical character. While this chemical action is of the utmost importance for organisms, the nutrition of which depends upon the action of chlorophyll, it becomes of less importance for organisms devoid of chlorophyll. Nevertheless, we find animals in which the formation of organs by regeneration is not possible unless they are exposed to light. An observation made by the writer on the regeneration of polyps in a hydroid, *Eudendrium racemosum*, at Woods Hole, may be mentioned as an instance of this. If the stem of this hydroid, which is usually covered with polyps, is put into an aquarium the polyps soon fall off. If the stems are kept in an aquarium where light strikes them during the day, a regeneration of numerous polyps takes place in a few days. If, however, the stems of *Eudendrium* are kept permanently in the dark, no polyps are formed even after an interval of some weeks; but they are formed in a few days after the same stems have been transferred from the dark to the light. Diffused daylight suffices for this effect. Goldfarb, who repeated these experiments, states that an exposure of comparatively short duration is sufficient to produce this effect. It is possible that the light favors the formation of substances which are a prerequisite for the origin of polyps and their growth.

Of much greater significance than this observation are the

facts which show that a large number of animals assume, to some extent, the color of the ground on which they are placed. Pouchet found through experiments upon crustaceans and fish that this influence of the ground on the color of animals is produced through the medium of the eyes. If the eyes are removed or the animals made blind in another way these phenomena cease. The second general fact found by Pouchet was that the variation in the color of the animal is brought about through an action of the nerves on the pigment cells of the skin; the nerve action being induced through the agency of the eye.

The mechanism and the conditions for the change in coloration were made clear through the beautiful investigations of Keeble and Gamble, on the color change in crustaceans. According to these authors the pigment cells can, as a rule, be considered as consisting of a central body from which a system of more or less complicated ramifications or processes spreads out in all directions. As a rule, the center of the cell contains one or more different pigments which under the influence of nerves can spread out separately or together into the ramifications. These phenomena of spreading and retraction of the pigments into or from the ramifications of the pigment cells form on the whole the basis for the color changes under the influence of environment. Thus Keeble and Gamble observed that *Macromysis flexuosa* appears transparent and colorless or gray on sandy ground. On a dark ground their color becomes darker. These animals have two pigments in their chromatophores, a brown pigment and a whitish or yellow pigment; the former is much more plentiful than the latter. When the animal appears transparent all the pigment is contained in the center of the cells, while the ramifications are free from pigment. When the animal appears brown both pigments are spread out into ramifications. In the condition of maximal spreading the animals appear black.

This is a comparatively simple case. Much more complicated conditions were found by Keeble and Gamble in other crustaceans, e.g., in *Hippolyte cranchii*, but the influence of the surroundings upon the coloration of this form was also satisfactorily analyzed by these authors.

While many animals show transitory changes in color under the influence of their surroundings, in a few cases permanent changes can be produced. The best examples of this are those which were observed by Poulton in the chrysalids of various butterflies, especially the small tortoise-shell. These experiments are so well known that a short reference to them will suffice. Poulton<sup>1</sup> found that in gilt or white surroundings the pupae became light colored and there was often an immense development of the golden spots, "so that in many cases the whole surface of the pupae glittered with an apparent metallic luster. So remarkable was the appearance that a physicist, to whom I showed the chrysalids, suggested that I had played a trick and had covered them with goldleaf." When black surroundings were used, "the pupae were as a rule extremely dark, with only the smallest trace, and often no trace at all, of the golden spots which are so conspicuous in the lighter form." The susceptibility of the animal to this influence of its surroundings was found to be greatest during a definite period when the caterpillar undergoes the metamorphosis into the chrysalis stage. As far as the writer is aware, no physico-chemical explanation, except possibly Wieners' suggestion of color photography by mechanical color adaptation, has ever been offered for the results of the type of those observed by Poulton.

#### V. EFFECTS OF GRAVITATION

a) *Experiments on the egg of the frog.*—Gravitation can only indirectly affect life phenomena; namely, when we have in a cell two different non-miscible liquids (or a liquid and a solid)

<sup>1</sup> Poulton, E. B., *Colours of Animals* ("International Scientific Series"), London, 1890, p. 121.

of different specific gravity, so that a change in the position of the cell or the organ may give results which can be traced to a change in the position of the two substances. This is very nicely illustrated by the frog's egg, which has two layers of very viscous protoplasm one of which is black and one white. The dark one occupies normally the upper position in the egg and may therefore be assumed to possess a smaller specific gravity than the white substance. When the egg is turned with the white pole upward a tendency of the white protoplasm to flow down again manifests itself. It is, however, possible to prevent or retard this rotation of the highly viscous protoplasm, by compressing the eggs between horizontal glass plates. Such compression experiments may lead to rather interesting results, as O. Schultze first pointed out. Pflüger had already shown that the first plane of division in a fertilized frog's egg is vertical and Roux established the fact that the first plane of division is identical with the plane of symmetry of the later embryo. Schultze found that if the frog's egg is turned upside down at the time of its first division and kept in this abnormal position, through compression between two glass plates for about twenty hours, a small number of eggs may give rise to twins. It is possible, in this case, that the tendency of the black part of the egg to rotate upward along the surface of the egg leads to a separation of its first cells, such a separation leading to the formation of twins.

T. H. Morgan made an interesting additional observation. He destroyed one-half of the egg after the first segmentation and found that the half which remained alive gave rise to only one-half of an embryo, thus confirming an older observation of Roux. When, however, Morgan put the egg upside down after the destruction of one of the first two cells, and compressed the eggs between two glass plates, the surviving half of the egg gave rise to a perfect embryo of half-size (and not to a half-embryo of normal size as before). Obviously in this case the tendency



of the protoplasm to flow back to its normal position was partially successful and led to a partial or complete separation of the living from the dead half; whereby the former was enabled to form a whole embryo, which, of course, possessed only half the size of an embryo originating from a whole egg.

b) *Experiments on hydroids.*—A striking influence of gravitation can be observed in a hydroid, *Antennularia antennina*, from the Bay of Naples. This hydroid consists of a long, straight, main stem which grows vertically upward and which has at regular intervals very fine and short bristle-like lateral branches, on the upper side of which the polyps grow. The main stem is negatively geotropic, i.e., its apex continues to grow vertically upward when we put it obliquely into the aquarium, while the roots grow vertically downward. The writer observed that when the stem is put horizontally into the water the short lateral branches on the lower side give rise to an altogether different kind of organ, namely, to roots, and these roots grow indefinitely in length and attach themselves to solid bodies; while if the stem had remained in its normal position no further growth would have occurred in the lateral branches. From the upper side of the horizontal stem new stems grow out, mostly directly from the original stem, occasionally also from the short lateral branches. It is thus possible to force upon this hydroid an arrangement of organs which is altogether different from the hereditary arrangement. The writer had called the change in the hereditary arrangement of organs or the transformation of organs by external forces *heteromorphosis*. We cannot now go any farther into this subject, which should, however, prove of interest in relation to the problem of heredity.

If it is correct to apply inferences drawn from the observation on the frog's egg to the behavior of *Antennularia*, one might conclude that the cells of *Antennularia* also contain non-miscible substances of different specific gravity, and that wherever

the specifically lighter substance comes in contact with the sea-water (or gets near the surface of the cell) the growth of a stem is favored; while contact with the sea-water of the specifically heavier of the substances, will favor the formation of roots.

#### VI. THE EXPERIMENTAL CONTROL OF ANIMAL INSTINCTS

a) *Experiments on the mechanism of heliotropic reactions in animals.*—Since the instinctive reactions of animals are as hereditary as their morphological character, a discussion of experiments on the physico-chemical character of the instinctive reactions of animals should not be entirely omitted from this sketch. It is obvious that such experiments must begin with the simplest type of instincts, if they are expected to lead to any results; and it is also obvious that only such animals must be selected for this purpose, the reactions of which are not complicated by associative memory or, as it may preferably be termed, associative hysteresis.

The simplest type of instincts is represented by the purposeful motions of animals to or from a source of energy, e.g., light; and it is with some of these that we intend to deal here. When we expose winged aphides (after they have flown away from the plant), or young caterpillars of *Porthesia chrysorrhoea* (when they are aroused from their winter sleep), or marine or fresh-water copepods and many other animals, to diffused daylight falling in from a window, we notice a tendency among these animals to move toward the source of light. If the animals are naturally sensitive, or if they are rendered sensitive through the agencies which we shall mention later, and if the light is strong enough, they move toward the source of light in as straight a line as the imperfections and peculiarities of their locomotor apparatus will permit. It is also obvious that we are here dealing with a forced reaction in which the animals have no more choice in the direction of their motion than have the iron

filings in their arrangement in a magnetic field. This can be proved very nicely in the case of starving caterpillars of *Porthesia*. The writer put such caterpillars into a glass tube the axis of which was at right angles to the plane of the window: the caterpillars went to the window side of the tube and remained there, even if leaves of their food plant were put into the tube directly behind them. Under such conditions the animals actually died from starvation, the light preventing them from turning to the food, which they eagerly ate when the light allowed them to do so. One cannot say that these animals, which we call positively heliotropic, are attracted by the light, since it can be shown that they go toward the source of light even if in so doing they move from places of a higher to places of a lower degree of illumination.

The writer has advanced the following theory of these instinctive reactions. Animals of the type of those mentioned are automatically oriented by the light in such a way that symmetrical elements of their retina (or skin) are struck by the rays of light at the same angle. In this case the intensity of light is the same for both retinæ or symmetrical parts of the skin.

This automatic orientation is determined by two factors, first a peculiar photosensitiveness of the retina (or skin), and second a peculiar nervous connection between the retina and the muscular apparatus. In symmetrically built heliotropic animals in which the symmetrical muscles participate equally in locomotion, the symmetrical muscles work with equal energy as long as the photochemical processes in both eyes are identical. If, however, one eye is struck by stronger light than the other, the symmetrical muscles will work unequally and in positively heliotropic animals those muscles will work with greater energy which brings the plane of symmetry back into the direction of the rays of light and the head toward the source of light. As soon as both eyes are struck by the rays of light

at the same angle, there is no more reason for the animal to deviate from this direction and it will move in a straight line. All this holds good on the supposition that the animals are exposed to only one source of light and are very sensitive to light.

Additional proof for the correctness of this theory was furnished through the experiments of G. H. Parker and S. J. Holmes. The former worked on a butterfly, *Vanessa antiope*, the latter on other arthropods. All the animals were in a marked degree positively heliotropic. These authors found that if one cornea is blackened in such an animal, it moves continually in a circle when it is exposed to a source of light, and in these motions the eye which is not covered with paint is directed toward the center of the circle. The animal behaves, therefore, as if the darkened eye were in the shade.

b) *The production of positive heliotropism by acids and other means and the periodic depth migrations of pelagic animals.*—When we observe a dense mass of copepods collected from a fresh-water pond, we notice that some have a tendency to go to the light while others go in the opposite direction and many, if not the majority, are indifferent to light. It is an easy matter to make the negatively heliotropic or the indifferent copepods almost instantly positively heliotropic by adding a small but definite amount of carbon dioxide in the form of carbonated water to the water in which the animals are contained. If the animals are contained in 50 c.c. of water it suffices to add from 3 to 6 c.c. of carbonated water to make all the copepods energetically positively heliotropic. This heliotropism lasts about half an hour (probably until all the carbon dioxide has again diffused into the air). Similar results may be obtained with any other acid.

The same experiments may be made with another fresh-water crustacean, namely *Daphnia*, with this difference, however, that it is as a rule necessary to lower the temperature of

the water also. If the water containing the *Daphniae* is cooled and at the same time carbon dioxide added, the animals which were before indifferent to light now become most strikingly positively heliotropic. Marine copepods can be made positively heliotropic by the lowering of the temperature alone, or by a sudden increase in the concentration of the sea-water.

These data have a bearing upon the depth migrations of pelagic animals, as was pointed out years ago by Theo. T. Groom and the writer. It is well known that many animals living near the surface of the ocean or fresh-water lakes, have a tendency to migrate upward toward evening and downward in the morning and during the day. These periodic motions are determined to a large extent, if not exclusively, by the heliotropism of these animals. Since the consumption of carbon dioxide by the green plants ceases toward evening, the tension of this gas in the water must rise and this must have the effect of inducing positive heliotropism or increasing its intensity. At the same time the temperature of the water near the surface is lowered and this also increases the positive heliotropism in the organisms.

The faint light from the sky is sufficient to cause animals which are in a high degree positively heliotropic to move vertically upward toward the light, as experiments with such pelagic animals, e.g., copepods, have shown. When, in the morning, the absorption of carbon dioxide by the green algae begins again and the temperature of the water rises, the animals lose their positive heliotropism, and slowly sink down or become negatively heliotropic and migrate actively downward.

These experiments have also a bearing upon the problem of the inheritance of instincts. The character which is transmitted in this case is not the tendency to migrate periodically upward and downward, but the positive heliotropism. The tendency to migrate is the outcome of the fact that periodically varying external conditions induce a periodic change in the

sense and intensity of the heliotropism of these animals. It is of course immaterial for the result, whether the carbon dioxide or any other acid diffuse into the animal from the outside or whether they are produced inside in the tissue-cells of the animals. Davenport and Cannon found that *Daphniae*, which at the beginning of the experiment react sluggishly to light, react much more quickly after they have been made to go to the light a few times. The writer is inclined to attribute this result to the effect of acids, e.g., carbon dioxide, produced in the animals themselves in consequence of their motion. A similar effect of the acids was shown by A. D. Waller in the case of the response of a nerve to stimuli.

The writer observed many years ago that winged male and female ants are positively heliotropic and that their heliotropic sensitiveness increases and reaches its maximum toward the period of nuptial flight. Since the workers show no heliotropism it looks as if an internal secretion from the sexual glands were the cause of their heliotropic sensitiveness. V. Kellogg has observed that bees also become intensely positively heliotropic at the period of their wedding flight, in fact so much so that by letting light fall into the observation hive from above, the bees are prevented from leaving the hive through the exit at the lower end.

We notice also the reverse phenomenon, namely, that chemical changes produced in the animal destroy its heliotropism. The caterpillars of *Porthesia chrysoorrhoea* are very strongly positively heliotropic when they are first aroused from their winter sleep. This heliotropic sensitiveness lasts only as long as they are not fed. If they are kept permanently without food they remain permanently positively heliotropic until they die from starvation. It is to be inferred that as soon as these animals take up food, the formation of a substance or substances in their bodies takes place, diminishing or annihilating their heliotropic sensitiveness.

The heliotropism of animals is identical with the heliotropism of plants. The writer has shown that the experiments on the effect of acids on the heliotropism of copepods can be repeated with the same result in *Volvox*. It is, therefore, erroneous to try to explain these heliotropic reactions of animals on the basis of peculiarities (e.g., vision) which are not found in plants.

We may briefly discuss the question of the transmission through the sex-cells of such instincts as are based upon heliotropism. This problem reduces itself simply to that of the method whereby the gametes transmit heliotropism to the larvae or to the adult. The writer has expressed the idea that all that is necessary for this transmission is the presence of a photosensitive substance in the eyes (or in the skin) of the animal. For the transmission of this the gametes need not contain anything more than a catalyzer or ferment for the synthesis of the photosensitive substance in the body of the animal. What has been said in regard to animal heliotropism might, if space permitted, be extended, *mutatis mutandis*, to geotropism and stereotropism.

c) *The tropic reactions of certain tissue-cells and the morphogenetic effects of these reactions.*—Since plant-cells show heliotropic reactions identical with those of animals, it is not surprising that certain tissue-cells also show reactions which belong to the class of tropisms. These reactions of tissue-cells are of special interest by reason of their bearing upon the inheritance of morphological characters. An example of this is found in the tiger-like marking of the yolk sac of the embryo of *Fundulus* and in the marking of the young fish itself. The writer found that the former is entirely, and the latter at least in part, due to the creeping of the chromatophores upon the blood-vessels. The chromatophores are at first scattered irregularly over the yolk sac and show their characteristic ramifications (Fig. 36, p. 106). There is at that time no definite

relation between blood-vessels and chromatophores. As soon as a ramification of a chromatophore comes in contact with a blood-vessel the whole mass of the chromatophore creeps gradually on the blood-vessel (Fig. 37) and forms a complete sheath around the vessel, until finally all the chromatophores form a sheath around the vessels and no more pigment cells are found in the meshes between the vessels (Fig. 38). Nobody who has not actually watched the process of the creeping of the chromatophores upon the blood-vessels would anticipate that the tiger-like coloration of the yolk sac in the later stages of development was brought about in this way. Similar facts can be observed in regard to the first marking of the embryo itself. The writer is inclined to believe that we are here dealing with a case of chemotropism, and that the oxygen of the blood may be the cause of the spreading of the chromatophores around the blood-vessels. Certain observations seem to indicate the possibility that in the adult the chromatophores have, in some forms at least, a more rigid structure and are prevented from acting in the way indicated. It seems to the writer that such observations as those made on *Fundulus* might simplify the problem of the hereditary transmission of certain markings.

Driesch has found that a tropism underlies the arrangement of the skeleton in the pluteus larvae of the sea-urchin. The position of this skeleton is predetermined by the arrangement of the mesenchyme cells, and Driesch has shown that these cells migrate actively to the place of their destination, possibly led there under the influence of certain chemical substances. When Driesch scattered these cells mechanically before their migration, they nevertheless reached their destination.

In the developing eggs of insects the nuclei, together with some cytoplasm, migrate to the periphery of the egg. Herbst pointed out that this might be a case of chemotropism, caused by the oxygen surrounding the egg. The writer has expressed



the opinion that the formation of the blastula may be caused generally by a tropic reaction of the blastomeres, the latter being forced by an outside influence to creep to the surface of the egg.

These examples may suffice to indicate that the arrangement of definite groups of cells and the morphological effects resulting therefrom may be determined by forces lying outside the cells. Since these forces are ubiquitous and constant it appears as if we were dealing exclusively with the influence of a gamete; while in reality all that is necessary for the gamete to transmit is a certain form of irritability.

d) *Factors which determine place and time for the deposition of eggs.*—For the preservation of species the instinct of animals to lay their eggs in places in which the young larvae find their food and can develop is of paramount importance. A simple example of this instinct is the fact that the common fly lays its eggs on putrid material which serves as food for the young larvae. When a piece of meat and of fat of the same animal are placed side by side, the fly will deposit its eggs upon the meat on which the larvae can grow, and not upon the fat, on which they would starve. Here we are dealing with the effect of a volatile nitrogenous substance which reflexly causes the peristaltic motions for the laying of the egg in the female fly.

Kammerer has investigated the conditions for the laying of eggs in two forms of salamanders, e.g., *Salamandra atra* and *S. maculosa*. In both forms the eggs are fertilized in the body and begin to develop in the uterus. Since there is room only for a few larvae in the uterus, a large number of eggs perish and this number is the greater the longer the period of gestation. It thus happens that when the animals retain their eggs a long time, very few young ones are born; and these are in a rather advanced stage of development, owing to the long time which elapsed since they were fertilized. When the animal lays its eggs comparatively soon after copulation, many eggs (from twelve to

seventy-two) are produced and the larvae are of course in an early stage of development. In the early stage the larvae possess gills and can therefore live in water, while in later stages they have no gills and breathe through their lungs. Kammerer showed that both forms of *Salamandra* can be induced to lay their eggs early or late, according to the physical conditions surrounding them. If they are kept in water or in proximity to water and in a moist atmosphere they have a tendency to lay their eggs earlier and a comparatively high temperature enhances the tendency to shorten the period of gestation. If the salamanders are kept in comparative dryness they show a tendency to lay their eggs rather late and a low temperature enhances this tendency.

Since *Salamandra atra* is found in rather dry alpine regions with a relatively low temperature and *Salamandra maculosa* in lower regions with plenty of water and a higher temperature, the fact that *S. atra* bears young which are already developed and beyond the stage of aquatic life, while *S. maculosa* bears young ones in an earlier stage, has been termed adaptation. Kammerer's experiments, however, show that we are dealing with the direct effects of definite outside forces. While we may speak of adaptation when all or some of the variables which determine a reaction are unknown, it is obviously in the interest of further scientific progress to connect cause and effect directly whenever our knowledge allows us to do so.

#### VII. CONCLUDING REMARKS

The discovery of DeVries, that new species may arise by mutation and the wide if not universal applicability of Mendel's law to phenomena of heredity, as shown especially by Bateson and his pupils, must, for the time being, if not permanently, serve as a basis for theories of evolution. These discoveries place before the experimental biologist the definite task of producing mutations by physico-chemical means. It is true that

certain authors claim to have succeeded in this, but the writer wishes to apologize to these authors for his inability to convince himself of the validity of their claims at the present moment. He thinks that only continued breeding of these apparent mutants through several generations can afford convincing evidence that we are here dealing with mutants rather than with merely pathological variations.<sup>1</sup>

What was said in regard to the production of new species by physico-chemical means may be repeated with still more justification in regard to the second problem of transformation, namely, the making of living from inanimate matter. The purely morphological imitations of bacteria or cells which physicists have now and then proclaimed as artificially produced living beings, or the plays on words by which, e.g., the regeneration of broken crystals and the regeneration of lost limbs by a crustacean were declared identical will not appeal to the biologist. We know that growth and development in animals and plants are determined by definite although complicated series of catenary chemical reactions, which result in the synthesis of a *definite* compound or group of compounds, namely, *nucleins*.

The nucleins have the peculiarity of acting as ferments or enzymes for their own synthesis. Thus a given type of nucleus will continue to synthesize other nuclein of its own kind. This determines the continuity of a species; since each species has, probably, its own specific nuclein or nuclear material. But it also shows us that whoever claims to have succeeded in making living matter from inanimate will have to prove that he has succeeded in producing nuclear material which acts as a ferment for its own synthesis and thus reproduces itself. Nobody has thus far succeeded in this, although nothing warrants us in taking it for granted that this task is beyond the power of science.

<sup>1</sup> Since this was written the beautiful experiments of Kammerer as well as those of Tower seem to have furnished proof that external conditions can cause hereditary changes in animals.



## INDEX

- Abraxas*, 17.  
 Acid poisoning, 18 ff.  
 Acids, influences of, on heliotropism, 42, 220; acids and salts, antagonism, of, 179 ff.  
 Action of potassium cyanide, 156 ff.  
 Activation of the egg, 6 ff.  
*Agalma*, 208.  
*Amphitrite*, 144.  
 Animal instincts, experimental control of, 218.  
 Antagonism of acids and salts, 179 ff.  
 Antagonism of three salts, 182 ff.  
 Antagonistic salt action, 172 ff.  
*Antedon rosacea*, 198.  
*Antennularia antennina*, 85, 91, 107, 217.  
 Ants, 47, 48.  
 Aphides, 19, 37 ff., 41 ff., 46.  
*Arabacia*, 157, 164, 190.  
*Area striata*, 79.  
 Arrhenius, 5, 198.  
 Artificial causation of positive heliotropism, 43, 220.  
 Artificial parthenogenesis, 7, 116 ff., 127 ff., 199 ff.  
 Artificial production of double and multiple monstrosities in sea-urchins, 100 ff.  
 Artificial production of living matter, 5.  
 Ascidians, 68.  
 Associative memory, 55, 73.  
*Asterias capitata*, 198.  
*Asterias forbesii*, 135.  
*Asterias ochracea*, 138, 162, 198.  
*Asterina*, 132, 198.  
 Atwater, 4.  
 "Aura seminalis," 113.  
 Baer, K. E. von, 114.  
*Balanus perforatus*, 46, 53.  
 Baltzer, 15.  
 Bancroft, 51.  
 Bardeen, 92.  
 Barry, 114.  
 Bases as membrane-forming substances, 134.  
 Bataillon, 11.  
 Bateson, 226.  
 Bees, 49.  
 Beginning of scientific biology, 4.  
 Berzelius, 4.  
 Biedermann, 173.  
 Biology, beginning of scientific, 4.  
 Bischof, 115.  
 Blaauw, 29.  
 Bohm, 40, 49, 54, 55.  
*Bolina*, 208.  
 Boveri, 15.  
 Bütschli, 145, 146, 147.  
 Bunsen, 27, 29, 30, 41, 58.  
 Bunsen-Roscoe law, 27, 28 ff., 40, 58.  
 Butyric acid, treatment of egg, 10.  
*Callianira*, 208.  
 Cannon, 222.  
 Catalysis of esters, 43.  
 Catalyzer, 4, 5.  
 "Center of coordination," 72.  
*Cerianthus membranaceus*, 93.  
*Chaetopterus*, 117.  
 Change in intensity of light, 54 ff.  
 Changes in color of butterflies produced through influence of temperature, 211.  
 Chemical agencies, effects of, 196 ff.  
 Chemical symmetry, 38, 39.  
 Chemotropism, 224.  
*Chlorostoma*, 198.  
 Chromosomes, 16 ff.  
 Chun, 208.  
 Ciamician, 38.  
 Cincarias, 37.  
*Ciona intestinalis*, 68, 92.  
 Claparède, 51.  
 Cohen, 208.  
 Color, changes in, of butterflies, through influence of temperature, 211; color adaptation, 80 ff., 213 ff.; color blindness, 16.  
 Compulsory movements, 38.  
 Consciousness, 72.  
 Contents of life, 26 ff.  
 Cooke, 99.  
 Cooperative action of salts causing impermeability of the egg membrane, 176 ff.  
 Coordinated movements in reflexes, 70.  
 Copepod, 43, 62.  
 Correns, 21.  
 Cortical layer, of unfertilized egg, 10, 189; mechanical destruction of, 10, 11.  
 Cosine law of illumination, 41.  
 Crabs, fiddler, 60.  
*Ctenolabrus*, 25.  
*Cuma Rathkii*, 51.  
 Cytolysis, of the egg, 146; mechanical causation of, 145.  
 Cytolytic agents, 10, 132 ff., 136, 144 ff., 202.  
 De Vries, 226.  
*Daphnia*, 43, 208, 213, 220.  
 Darwin, Charles, 195, 196.  
 Darwin, F., 58.  
 Davenport, 222.  
 Death and development, different chemical processes, 209 ff.  
 Delage, 11, 131, 203.  
 Depth migration, 220.  
 Development, death and, different chemical processes, 209 ff.  
 Difference of salt permeability of various membranes, 189 ff.  
 Diffusion of salts, 177 ff.

- Doncaster, 21.  
 Dorfmeister, 211.  
 Driesch, 101, 108, 204, 224.  
 Drosophila, 21.  
 Dumas, 114.  
 Dzierzon, 116.
- Ear, otoliths of, and orientation to center of gravity of the earth, 57.  
 Effect of retarded oxidations on poisonous salt action, 190 ff.  
 Effects of chemical agencies, 196 ff.; of gravitation, 215; of light, 213.  
 Egg, activation of, 6 ff.; butyric acid, treatment of, 10; cortical layer of unfertilized, 10, 189; increased sensitiveness of unfertilized, to cytolytic agents, 163 ff.; production of twins from, 204 ff.  
 Eggs, factors which determine time and place for the deposition of, 225; immunity of, to body extracts of same species, 142; varying susceptibility of, 144.  
 Emulsion theory of membrane formation, 145, 147 ff.  
 Enzymes, 5, 122, 123.  
 Esters, catalysis of, 43.  
 Ethics, 3, 5, 31 ff., 62.  
*Eudendrium racemosum*, 213.  
 Experimental control of animal instincts, 218.  
 Experiments, on hydroids, 217; on the egg of the frog, 216; on the mechanism of heliotropic reactions, 218; localization, 35.
- Factors which determine time and place for the deposition of eggs, 225.  
 Ferments of oxidation, 5.  
 Fertilization, 6; fertilization membrane, 8, 148 ff.  
 Fiddler crabs, 60.  
 Fischer, 211, 212, 213.  
 Fischer, Emil, 115.  
*Fovea centralis*, 39.  
 Francé, 58.  
 Fröschl, 29.  
*Fundulus heteroclitus*, 25, 105, 172 ff., 175, 179 ff., 223.  
 Fusion of normally double organs, 207.
- Galvanotropism, 50 ff.  
 Gamble, 214, 215.  
*Gammarus*, 170 ff., 189; poisonous action of distilled water on, 170 ff.  
 Gemmill, 121.  
 Geotropism, 56 ff., 89, 217, 223.  
 Gies, 175.  
 Godlewski, 15, 95, 198, 199.  
 Goldfarb, 213.  
 Gravitation, effects of, 215.  
 Groom, 221.  
 Growth, 96 ff., 100 ff.; mechanics of, in animals, 95.  
 Growth and light, 213.  
 Guyer, 17, 18.
- Haberlandt, 58.  
 Hagedoorn, 15, 199.  
 Handovskl, 99.  
 Hardy, 148.
- Harmonious character of organisms, 23 ff.  
 Hartmann, E. von, 35.  
 Harvey, 189.  
 Heliotropic animals, 41; heliotropic reactions, experiments on the mechanism of, 218.  
 Heliotropism, 27 ff., 220 ff.; artificial causation of positive, 43, 220; influence of acids on, 42, 220.  
 Henking, 16.  
 Henschen, 79.  
 Herbst, 92, 134, 186, 187, 204, 207, 224.  
 Heredity, 4, 15 ff., 49, 52, 101.  
 Hertwig, O., 116, 134, 208.  
 Hertwig, R., 7.  
 Heterogeneous hybridization, 24, 25, 196 ff.  
 Heteromorphosis, 85 ff., 217 ff.  
*Hippolyte cranchii*, 215.  
 His, 100, 101, 115.  
 Hoeber, 177.  
 Holmes, 51, 60.  
 Holmes, S. J., 220.  
 Huxley, 15.  
 Huyghens, 104, 107.  
 Hybridization, heterogeneous, 24, 25, 196 ff.  
 Hybrids, maternal character of heterogeneous, 199.  
*Hydra*, 93 ff.  
 Hydroids, Experiments on, 217.  
 Hypertonic sea-water, 7, 116 ff., 131 ff.  
*Hypotricha*, 55.
- Illumination, Cosine law of, 41; intensity of, 44.  
 Immunity, 142.  
 Immunity of eggs to body extracts of same species, 142.  
 Increased sensitiveness of unfertilized egg to cytolytic agents, 163 ff.  
 Influence of membrane formation in causing the egg to develop, 150 ff.  
 Influence of temperature, 207 ff.  
*Infusoria Coelenterates*, 74.  
 Instincts, 69.  
 Intensity of illumination, 44.
- Jacobi, 113.  
 Jennings, 55, 60.
- Kammerer, 225, 226, 227.  
 Keeble, 214, 215.  
 Kellogg, V., 49, 222.  
 Knaffl, von, 136, 147.  
 Koeppe, 148.  
 Kupelwieser, 15, 21, 125, 198, 199.
- Laplace, 4, 5.  
 Lavoisier, 4, 5.  
 Law of segregation, 16, 20 ff.  
 Leeuwenhook, 113.  
 Liebig, 115.  
 Life, contents of, 26 ff.  
 "Life principle," 14, 15.  
 Light, change in intensity of, 54 ff.; effects of, 213; growth and, 213; photochemical action of, 30, 36; selection of intensity of, by animals, 52 ff.  
 Lillie, F., 12.  
 Lillie, R., 10, 132, 136, 174, 181.

- Living matter, artificial production of, 5.  
 Localization experiments, 35.  
 Loeb, Leo, 48, 210.  
*Lottia*, 209.  
 Lucas, 208.  
 Luther, 38.  
 Lyon, 57.  
 "Lysin theory," 143.  
 Lysins, 139 ff.
- McClung, 16, 17.  
 Mach, 57.  
*Macromysis flexuosa*, 214.  
*Margelis*, 89, 107.  
 Maternal character of heterogeneous hybrids, 199.  
 Mathews, A. P., 11, 144, 156.  
 Maxwell, S. S., 39, 208.  
 Mead, 7, 117.  
 Mechanical causation of cytolysis, 145.  
 Mechanical destruction of cortical layer, 10, 11.  
 Mechanics of growth in animals, 95.  
 Membrane of fertilization, 8, 148 ff.; membrane-forming substances, bases as, 134; membrane formation, emulsion theory of, 145, 147 ff.; membrane formation, influence of, in causing egg to develop, 150 ff.
- Memory, associative, 55, 73.  
 Mendel, 4, 16, 20, 21, 49, 52, 59, 60, 226.  
 Mendel's laws, 4, 15 ff., 20, 49, 52, 59 ff., 226.  
*Menidia*, 25.  
 Merrifield, 211.  
 Meyerhof, 190.  
 Miescher, 114, 115.  
 Minkowski, 79.  
 Moenkhaus, 24.  
 Monstrosities, artificial production of, in sea-urchins, 100 ff.
- Montgomery, 16.  
 Morgan, 7, 17, 19, 21, 92, 117, 119, 216.  
 Morphology, physiological, 109.  
 Movements, compulsory, 38.  
 Munk, 35, 79.  
 Muscles, osmotic phenomena in, 99.  
*Mytilus*, 198.
- Natural selection, 50 ff.  
 Němec, 58.  
*Nereis*, 12.  
 Neuberg, C., 38.  
 Norman, 117.
- Organisms, harmonious character of, 23 ff.  
 Organs, fusion of normally double, 207.  
 Osmotic phenomena in muscles, 99.  
 Osterhout, 177, 178, 179, 188.  
 Ostwald, Wilhelm, 4.  
 Ostwald, Wolfgang, 38, 213.  
 Otoliths of ear and orientation to center of gravity of the earth, 57.  
 Overton, 148, 177, 178, 179, 191.  
 Oxidation, ferments of, 5.  
 Oxidations, and their relation to the egg after fertilization, 13, 157, 160 ff., 164; in their relation to life and death, 14, 15; effect of retarded, on poisonous salt action, 190 ff.
- Parker, 39, 49, 220.  
 Parthenogenesis, 117 ff.; artificial, 7, 116 ff., 127 ff., 199 ff.  
 Parthenogenetic development, varying susceptibility of eggs to, 144.  
 Pauli, 99, 181.  
 Pawlow, 62.  
*Pennaria*, 91.  
 Peter, 208.  
 Pettenkofer, 4.  
 Pflüger, 216.  
 Photochemical action of light, 30, 36.  
 Photochemical, effects, 27, 38, 39, 39, substances, 39.  
 Photosensitive surfaces, 39.  
 Photosensitiveness, varying, in animals, 45.  
*Phyllozera*, 19.  
 Physiological morphology, 109.  
 Planarians, 39, 54.  
 Plasmolysis, 177.  
 Poisoning, acid, 18 ff.; salt, 186 ff.  
 Poisonous action of distilled water on *Gammarus*, 170 ff.
- Polarization, 92 ff.  
*Polygordius*, 53.  
*Polynoe*, 132, 158.  
*Porthezia chrysorrhoea*, 47, 48, 218 ff., 222.  
 Potassium cyanide, action of, 156 ff.  
 Pouchet, 80, 214.  
 Poulton, 215.  
 Prevost, 114.  
 Procter, 181.  
 Production of twins from one egg through a change in the chemical constitution of the sea-water, 204 ff.
- Protective solution, 172.  
 Purposeful character of reflexes, 66.  
*Pycnopodia*, 198.  
*Pyrhocoris*, 16.
- Rádl, 49.  
 Ranke, 99.  
 Rayleigh, 147, 152.  
 Reflex, 65 ff.  
 Reflexes, coordinated movements in, 70; purposeful character of, 66.  
 Reinke, 24.  
 "Riddle of life," 5.  
 Ringer, 172, 173.  
 Robertson, T. B., 185, 208, 210.  
 Rôle of water in segmentation, 99.  
 Roscoe, 27, 29, 30, 41, 58.  
 Roux, 24, 216.  
 Rubner, 4.
- Sachs, 104, 107.  
*Salamandra atra*, 225.  
*Salamandra maculosa*, 225.  
 Salt poisoning, 186 ff.; difference of permeability of various membranes, 189 ff.  
 Salts, antagonism of acids and, 179 ff.; antagonism of three salts, 182 ff.; cooperative action of, causing impermeability of egg membrane, 176 ff.; diffusion of, 177 ff.
- Schmiedeberg, 173.  
 Schopenhauer, 15.  
 Schultze, 216.  
 Sea-water, hypertonic, 7, 116 ff., 131 ff.  
 Segregation, law of, 16, 20 ff.

- Selection, of intensity of light by animals, 52 ff.; natural, 50 ff.  
 Sex determination, 16.  
 Shearer, 11.  
*Sipunculides*, 141.  
 Snyder, C. D., 39, 208.  
 Solution, protective, 172.  
 Spallanzani, 113.  
 Spermatozoa, 113 ff.  
 Spermatozoon, twofold action of, in fertilization, 12 ff., 132 ff., 161 ff.  
 "Spezifische Bildungstoffe," 104.  
 Spontaneous movements, 71.  
*Spyrogyra*, 177 ff., 188.  
 Standfuss, 211.  
 Stereotropism, 91 ff., 223.  
 Stevens, 17.  
 Stieglitz, 43.  
 Stockard, 206, 207.  
*Strongylocentrotus franciscanus*, 140, 198.  
*Strongylocentrotus purpuratus*, S, 139 ff., 144, 162, 189, 197, 201, 205.  
 Sumner, 80.  
 Symmetry, chemical, 38, 39.  
  
 Temperature as a cytolytic agent, 135 ff., 138 ff.  
 Tower, 90, 227.  
 Traube, 96.  
 Tropisms, 26, 36 ff., 54, 55, 60, 62, 69, 70, 72.  
*Tubularia mesembryanthemum*, 95, 97.  
*Tunicates*, 92.  
 Twin formation, 19, 205.  
 Twins, production of, from egg, 204 ff.  
 Twofold action of spermatozoon in fertilization, 12 ff., 132 ff., 161 ff.  
  
 Tyrosin, 23.  
  
 Uexkuell, 70.  
 "Unterschiedsempfindlichkeit," 54.  
  
 Van Duyne, 92.  
 van't Hoff, 208.  
*Vanessa antiope*, 220.  
*Vanessa levana*, 211.  
*Vanessa prorsa*, 211.  
 Varying photosensitiveness in animals, 45.  
 Varying susceptibility of eggs of different species to parthenogenetic development, 144.  
*Vaucheria*, 188.  
 Virchow, 127, 128.  
 Vision, 79 ff.  
 Voit, 4.  
*Volvox*, 51, 223.  
  
 Waller, A. D., 222.  
 Warburg, 13, 157, 160, 189, 190.  
 Wasteneys, 13, 157, 181, 182.  
 Water, distilled, poisonous action of distilled water on, 170 ff.; rôle of, in segmentation, 99.  
 Weismann, 91, 210, 211.  
 Wiener, 215.  
 "Will," 35 ff., 40.  
 Wilson, 17, 18, 19.  
  
 X-chromosomes, 18 ff.  
  
 "Zielstrebigkeit," 24.  
 Zuntz, 4.





