

Metal Spinning

PRACTICAL INSTRUCTION IN
A FASCINATING ART



FIFTY CENTS

POPULAR MECHANICS HANDBOOKS

A

0
0
0
5
0
3
3
5
2
7



California
National
Library

UNIVERSITY OF CALIFORNIA
AT LOS ANGELES

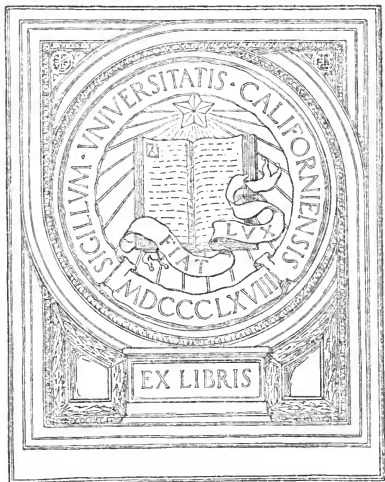

EX LIBRIS

UNIVERSITY of CALIFORNIA
AT
LOS ANGELES
LIBRARY

Metal Spinning

BY

Prof. FRED D. CRAWSHAW, M. E.,

Assistant Dean,

College of Engineering, University of Illinois

22865

POPULAR MECHANICS HANDBOOKS

CHICAGO
POPULAR MECHANICS CO.

Copyrighted, 1909,
By H. H. WINDSOR

REPRODUCED TO THE
PUBLIC BY THE NATIONAL ARCHIVES

TT
206
C85m

THIS book is one of the series of handbooks on industrial subjects being published by the Popular Mechanics Co. Like the magazine, these books are "written so you can understand it," and are intended to furnish information on mechanical subjects at a price within the reach of all.

The texts and illustrations have been prepared expressly for this Handbook Series, by experts; are up-to-date, and have been revised by the editor of Popular Mechanics.

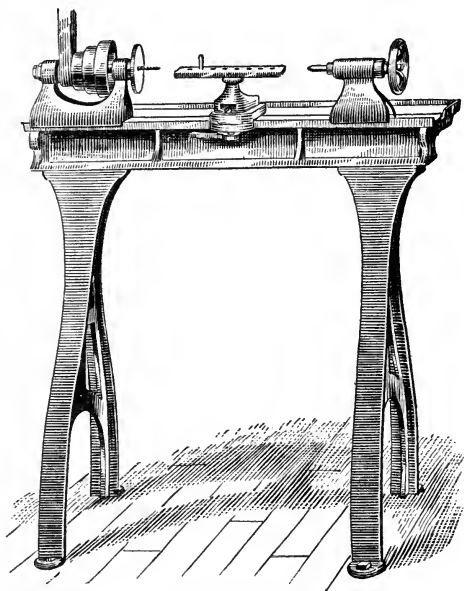

Fig. 1—Lathe for Metal Spinning

Chapters

The Lathe and Its Parts . . .	Chapter	I
Tools	Chapter	II
The Preparation of Metal for Spinning	Chapter	III
How to Spin a Hollow Dish .	Chapter	IV
How to Spin a Deep Dish .	Chapter	V
How to Spin a Vase . . .	Chapter	VI
How to Spin Some Unclassified Forms	Chapter	VII

METAL SPINNING

22865
INTRODUCTION

Sheet metal, which is now pressed and stamped into a great variety of forms for commercial uses, was, up to a few years ago, either hammered or spun into the desired shapes by a comparatively few artisans who had learned the art of cold-metal working in Europe. Like so many other of the old-time crafts, the one of metal spinning has partially come into disuse because of commercial competition and the failure of the younger generation of men to familiarize themselves with the handwork of their fathers. In the United States, it is only in the larger cities that one occasionally finds an artisan who does metal spinning; when such a person is found, he is usually occupied in producing forms out of thin metal that require great care in making or are difficult to produce with a stamp or press. Sometimes, however, where only a comparatively few articles of any particular shape are desired, they are spun instead of stamped out, to save the cost of dies.

It is believed in some quarters, particularly among metal spinners, that pressing and stamping metal can never fully take the place of spinning it. It is impossible to press or stamp some forms except as they are produced in parts and these parts soldered, brazed or riveted together. This is manifestly undesirable for many kinds of work.

The fact that modern commercial tendencies are in the direction of abolishing metal spinning wherever possible does not mean that large sheet-metal working establishments do not employ metal spinners; it does mean, however, that these men are called upon to do the hardest kind of spinning without much possibility of learning how to do the simpler forms of this work.

It is for the double purpose, therefore, of making it possible for amateurs to be helped in metal spinning and to renew this craft where metal spinning is really more serviceable than its substitutes, that this book is written.

From the standpoint of the craftsman, metal spinning is a craft which is highly desirable of attainment and which may replace beaten-metal work in some cases, or, in many cases be used in connection with it. The principal field of the metal spinner, however, is the production of forms for plated ware. Practically all silver plate has white metal, which has been pressed or spun into shape, as a base. There are also many forms used in connection with manufactured articles, notably electric fixtures, which can be, and many times are, spun with greater certainty of good results than could be possible if other methods are used.

For those who take up this work for the first time, it is suggested that forms be undertaken after the order of those described in the following chapters and that copper well annealed be used as the practice metal.

FRED D. CRAWSHAW

CHAPTER I

THE LATHE AND ITS PARTS

Metal spinning does not take a particularly prominent place among the trades in the United States. Inasmuch as it is perfectly possible to spin metal on an engine lathe or a speed lathe, if either is properly equipped for this work, few manufacturers of machine tools make a lathe specially for spinning. The work requires a lathe which will not move side-wise to any great extent as a result of heavy work running at a high speed. The ordinary engine lathe does not fulfil the requirements of speed; on the other hand the speed lathe, unless it is designed for heavy work, is liable to be unstable.

The frontispiece, Fig. 1, illustrates a strong speed lathe equipped for metal spinning. It will be noticed that the legs of the lathe are particularly well braced and that the entire machine presents the appearance of strength. Inasmuch as the writer has worked upon a lathe similar to the one illustrated and has spun different kinds of metal of varying disk diameters on it without inconvenience from lathe vibration, he feels that he can safely recommend a strong speed lathe for ordinary metal spinning work.

The principal lathe requirement for good spinning is a speed ranging from 1,800 r.p.m. to 2,500 r.p.m., which can be maintained with but slight variation whether light or heavy spinning is being done. The length of the spinning tools and the method of holding them produce a firm contact be-

Fig. 2

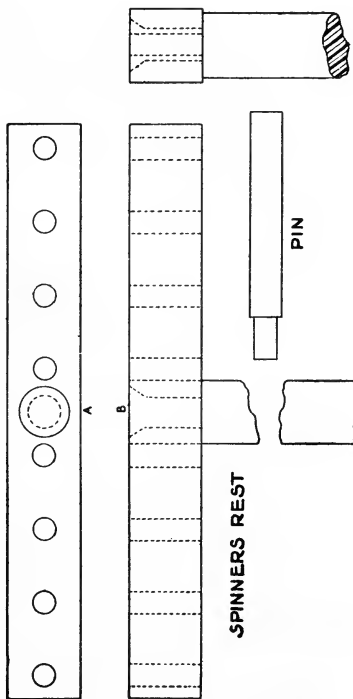

tween the tool and the metal, and this requires a lathe which has in store a considerable amount of reserve power. For ordinary work, a spinner should use at least a half-horsepower lathe, but for work in schools or light work in shops, good results can be obtained with a quarter-horsepower lathe which has a large head cone and is strongly belted.

The parts of the lathe, when equipped for metal spinning, which differ from corresponding parts when the lathe is used for metal turning, are the headstock, faceplate, tool-rest and tail center. The dog which is so commonly used in the metal working shop to hold work from slipping in the lathe as it revolves is never used in metal spinning. The ordinary center screw faceplate or outside screw faceplate used in wood-turning is screwed onto the headstock spindle. Upon the faceplate is screwed a block of hard wood, usually hard maple; this is turned with wood-turning tools to the shape desired for the first form in the process of spinning. The circular disk of metal which is to be spun is centrally placed against this turned form and held in place by the tail center which is brought in contact with it. Prior to the time when spinning begins, the circular disk of metal is held in place by friction between the wooden form fastened to the faceplate, over which the metal is to be spun, and the tail center. The process of spinning will be described later.

The lathe rest commonly used is shown in Fig. 2. A and B are both pieces of wrought iron which have been fastened together by turning a shoulder on the upper end of B and fitting the part thus made into a hole bored in the middle of A and counter-

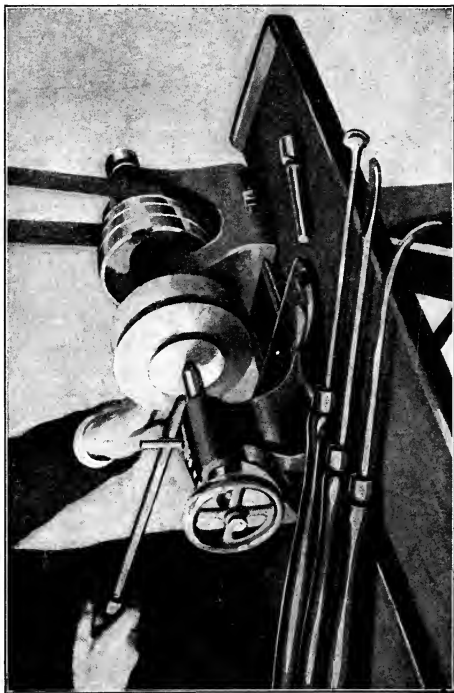
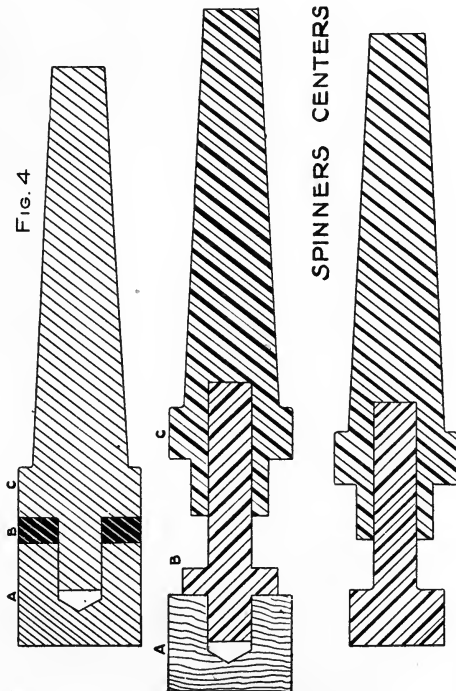

Fig. 3—Position of the Tool on the Rest

sunk at the top. The two pieces are securely fastened together by riveting the end of B into the countersunk part of A. This simple "T"-rest is fastened into the slide-rest of the lathe. It replaces the tool-rest in the wood lathe equipment. Now, as will be explained in a succeeding chapter, the plying of the tool over the disk of metal, to press it securely over the turned form, requires the spinning tool to act as a lever. The direction of motion of the lever varies from a vertical plane at the beginning of operations to a horizontal plane at the completion of the spinning process. In order that this may be done without the tool slipping on the rest, vertical holes are bored about $\frac{3}{4}$ in. to 1 in. apart in the horizontal portion of the rest in which is inserted a movable pin. The position of the tool on the rest is shown in the illustration, Fig. 3. As the metal is gradually pressed over the form the pin is moved toward the headstock of the lathe by changing it from one hole to another. For small work the horizontal portion of the "T"-rest can be made out of $\frac{3}{4}$ -in. or $\frac{7}{8}$ -in. square stock. A $\frac{3}{8}$ -in. rod will answer the purpose for the rest-pin. The pin should be shouldered squarely at the bottom to fit into $\frac{1}{4}$ -in. holes bored in the rest.

The size of the vertical portion of the "T"-rest will depend upon the hole in the slide-rest which receives it. I am assuming, in this description, that an ordinary speed lathe is remodeled to serve for spinning purposes. Some difficulty may be found in the rest slipping when considerable pressure is used in the spinning process. This might be avoided by using a "T" or square pin joint to fasten

FIG. 4



SPINNERS CENTERS

the two parts of the rest together. However, if the operator will shift the lathe carriage from time to time to keep the fulcrum point as nearly as possible over the central portion of the rest, little difficulty will be experienced in this direction.

In describing the spinner's center I shall illustrate and refer to three. All of these are shown in Fig. 4. The one at the top is to be found in the market. The one in the center of the illustration is described because a practical spinner, after years of experience and after using many forms of centers, finally concluded that this one filled all requirements better than any other he had ever seen or used.

Two things are absolutely necessary in any center which is used in metal spinning. The first: light contact must be kept between the end of the center and the surface of the metal being spun. In other words, there must be absolutely no slipping at this point. The second: this portion of the center which sticks, as it were, to the spinning metal should move freely and without much, if any, wear on the remainder of the center which is inserted in the tailstock. In order to have these two essential factors present in spinners' centers many devices have been constructed. Different spinners use different centers, often devices of their own; but experience has shown that the two centers here described have worked well—I do not say perfectly. The center illustrated at the bottom of Fig. 4 is one which the writer tried as a result of some trouble which he had with the top center shown in Fig. 4, and before he used the one shown in the center of

this illustration. It has the advantage of having but one moving metal part, which serves a good purpose in some respects, viz, it reduces to a minimum the trouble due to many parts. On the whole, the middle center shown in Fig. 4 proves the most satisfactory.

The stock center is made in three parts—A, B and C. A and C are cast-iron parts and B is a washer made of some hard substance such as hard rubber or vulcanized fiber, against which cast-iron will run freely. B is supposed to fit tightly upon the pin of C so that A alone revolves when the center is firmly pressed against the disk of metal to be spun. A may be made in different shapes to accommodate different forms and sizes in spinning and should be lubricated by occasionally dropping oil upon the pin of C. This pin should not enter A farther than is necessary to form a good bearing, and should fit about as tightly in A as a shaft in a high-grade machine fits in its bearing. The one difficulty which the writer has had with this center, as well as with the second center described, is the impossibility of making the diameter of A small enough for some work. This may not be considered an objection in the trade work, but in schools, where small pieces will naturally be spun more than large ones, it sometimes forms a serious drawback to accomplishing good results. The center shown at the bottom of Fig. 4 was found to overcome this difficulty because the revolving part of the center can be turned as small as one desires. Here, however, it should be mentioned that, if the end bearing surface in contact with the work is made too small, a perfect

contact between the tail center and the work cannot be secured and a very undesirable slipping will occur. It is true, nevertheless; that small work requires slight pressure from the tool, and, as a result, less pressure from the center than is required in large work. A small center, then, for small work is as serviceable, comparatively, as a large center is for large work.

The center illustrated in the middle of Fig. 4 has three parts as does the stock center, but two of them, A and B, are movable, or supposedly so; whereas, in the first center described, only one part, A, is supposed to revolve. A is a piece of wood; B is made of wrought iron or steel; C is preferably made of the same material as B. It has been stated that both A and B are supposed to revolve. Such revolution is not necessary, however. If A revolves upon B, the necessary requirements are fulfilled; or, if A and B together revolve, the same results are obtained; likewise if A revolves slightly upon B, and B revolves slowly in C, the same result is obtained. Herein lies one supposed or imaginary advantage which this center has over the stock center, viz, that if one part, A, sticks upon another, B,—similarly if B sticks in C—there still remains the possibility of a perfect bearing at a second point. While this is undoubtedly true, there is always the possibility of both A and B sticking, and as this center has more parts than the others, there is more danger of its getting out of order. Furthermore, as A is made of wood, it will burn as it revolves upon B, unless the movement between A and B is slight, or A is well lubricated upon B. Of course, it is an

easy matter to duplicate A, and it may be said here that it is well to have a number of this part of the center in stock. A broom handle, sawed into one-inch lengths with the proper hole drilled at the center of each sawed-off part, will provide pieces for a considerable length of time.

There is an idea among some spinners that the part coming in contact with the metal to be spun should be made of wood so that a better "stick" may be secured than is possible with a metal end. Whether this is a fact or not, however, must be decided by each workman. It is sometimes found advantageous to put a little resin on the end of the center in order to increase the friction between it and the metal to be spun. Again, when the part A is made of wood, it is possible to drive into the end next to the work a few small brads. These may be left extending from the center-end just enough to catch on the disk as it revolves in the spinning process.

Any one of the three centers described work well, but, as has been intimated, not at all times perfectly. I believe there is an opportunity for someone to devise a more perfect spinning center. I have wondered if some ball bearing center might not solve the present difficulties. Such a center is illustrated in Fig. 4. It has been used with success in school work according to the statement of the individual who devised it.

CHAPTER II

TOOLS

The tools used by metal spinners are difficult to name. Very few spinning operations require the use of any one particular tool. This fact contributes to the present condition regarding metal spinning tools in general, viz:—They are usually not to be found in stock and, when found, the forms used for the different processes vary considerably in different sections of the country. There are a few standard forms, however, and while it is true that old spinners usually make their own tools, they conform to regular practice in making these few standard forms.

The tools commonly spoken of by the machinist as the hand-tool diamond point and the cut-off tool are the only edge tools used in metal spinning; consequently, there is little danger of the operator being cut while spinning metal. To aid further in eliminating the factor of danger in the use of tools, nearly all spinning tools, except the above-mentioned two, may be used with the end of the tool placed under the work. In most lathe processes the tools are pushed into a revolving piece or placed on top of it as is the case in some kinds of wood turning. This feature of comparative safety is one which recommends itself to many who contemplate starting metal spinning in schools.

Because all spinning tools are used by pressing their ends against the work, considerable friction

results, and to minimize this as much as possible, the tools in a spinner's kit, except those mentioned for cutting and trimming (the diamond point and cutting-off tools), should be ground perfectly smooth and then well polished with emery.

I have said it is difficult to find spinners' tools kept in stock. Perhaps this is the reason why their names are not well known. In talking with an old spinner concerning the names of the tools in his set, he said, "Why sir, I have been a spinner for thirty years in Sweden and in the United States and it seems as though I had always known how to use every tool on this shelf, but I cannot give you the name of one of them. As a boy I was carefully taught how, why and where to use each one but I always heard them called 'this tool' or 'that tool.' I don't believe they have any names." I suggested that no one ought to be better prepared to name spinners' tools than he after his life's experience and so, with some persuasion, he suggested the names which I shall use in connection with the tools described and illustrated in the next few pages. Some were named because of their shape, and for others names were suggested by the kind of work which they performed.

In the average set of tools in an expert spinner's set will be found from one to two dozen forms. Perhaps not more than six or eight tools are in ordinary use. As it is with most specialists, the individual metal spinner will collect a number of forms which he will use only once in a great while. I shall make reference to only six of the more important tools here, and I venture to say from some

experience that any spinning except that which may be designated as "special" can be done with a part or all of these.

The round-nose, Fig. 5, is made of $\frac{1}{2}$ -in. round, hexagonal or octagonal steel. Round stock, for the work which this tool does, is probably the best. It is forged into the desired shape and at least 3 in. of the end carefully ground; probably one-half or more of this distance ought to be polished. The kind of work to be done, and the peculiar tastes of the workman can alone determine the exact shape most suitable for this or other tools. For this reason two or three round-nose tools, varying in form from the long to the short pointed, may be used to advantage. The extreme end must not be a sharp point in any case for fear of its catching the revolving metal and tearing it. It is advisable, however, in order to press the tool into small grooves, to have the end as pointed as possible and yet have it slightly rounded.

The round-nose is used to a greater or less degree according to the regularity of form in the object being spun, but, in general, it is used to the exclusion of all others in starting to spin a piece, and by many workmen it is used more than any other one tool. It is especially useful in compressing metal into cavities and in pressing out any irregularities or wrinkles before removing work from the lathe.

The tool which is probably as difficult of construction as any is shown in Fig. 6 and, for lack of a better name, will be called the raising-up tool. As this tool is used in operations which require considerable force applied by the workman, and,

FIG. 5

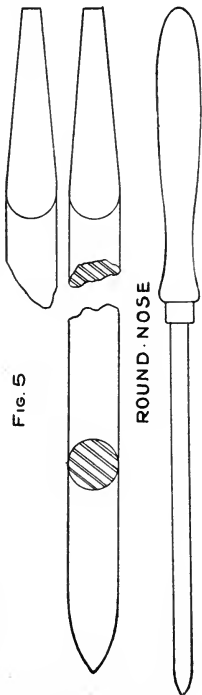
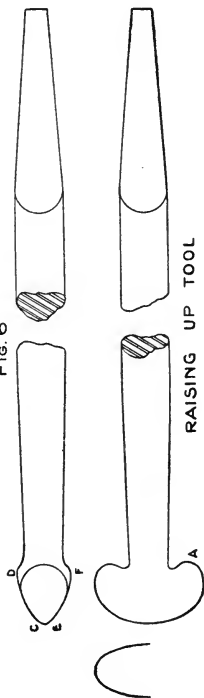
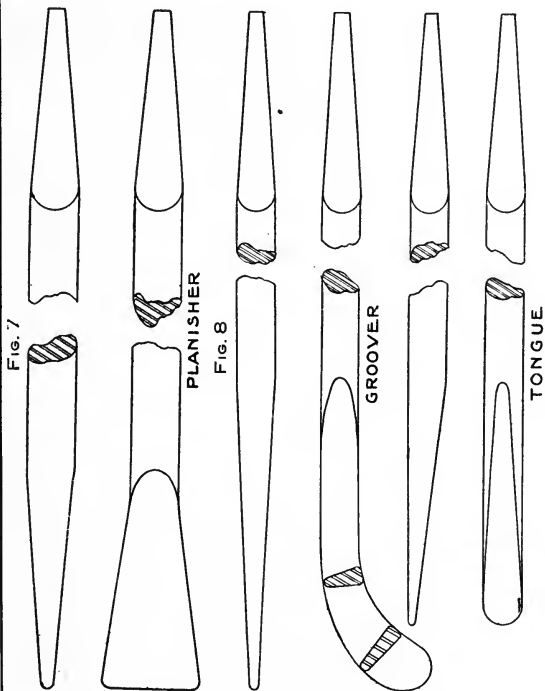

FIG. 6



also, because in forging the tool a neck is formed smaller than the regular stock, it is well to use steel a trifle larger than that used for the round-nose. Where $\frac{1}{2}$ -in. stock is used for the tool just described, $\frac{5}{8}$ -in. or even $\frac{3}{4}$ -in. material can profitably be used in the construction of the one now under discussion. Hexagonal or octagonal steel is generally considered more desirable for the raising-up tool than round stock. The forging of this tool must be done with a great deal of care. The first process is to upset the end of the tool. The second process is to draw down the neck, leaving a knob of metal on the end which is sufficient in size to form the finished end. There is one danger against which the forger must constantly guard in upsetting and hammering the tool into shape. I refer to the leafing or lapping of metal which, unless a welding heat is reached, will leave seams in the finished tool that will make it almost useless. Again, in tempering, great care must be taken not to produce a crack in the neck just back of the head. The use to which the raising-up tool is principally put—that of forming concave bottoms on dish forms or operations which require surfaces to be spun concave instead of convex toward the headstock—makes it necessary that the head of this tool should have a lobe left at the point lettered A, Fig. 6, in order that the tool can hook under the metal and draw it up into an undercut groove.

I have endeavored to make the drawings of these tools as nearly correct as possible according to the suggestions which I have received from spinners and from my own experience, and in the case of this



particular tool the form as illustrated has been made with special care. It should be noticed that the surfaces CD and EF are slightly convex outward.

The planisher is the name given to the tool considered third in importance. Hexagonal $\frac{5}{8}$ -in. steel is used to make it and is hammered into the form shown in Fig. 7. All that portion of the steel which has been changed in shape by forging the tool should be ground and polished. Especially, should care be taken to have the two flat tapering surfaces true and perfectly smooth. It is quite important, also, that the end should be straight with reference to the width of tool and neatly rounded with reference to the thickness. The principal use to which this tool is put is that of a burnisher. It is used, therefore, almost entirely as a finishing tool. The flat surfaces are placed against cylindrical or conical surfaces and the end is used in perfecting small grooves by pushing it into the concavity as one would push a cutting-off tool into a piece of spindle wood turning.

So far we have spoken of tools which seem to have been designed to make concave surfaces, principally, such as large or small grooves or cup-shaped formations. The tongue tool shown in Fig. 8 has its principal use in forming convex surfaces, or, as the spinners sometimes say, in "turning over" the metal. It is usually made from stock as small or smaller than that used in the construction of the other tools described. The planisher is used in its stead when large convex surfaces are spun. It is not necessary that the tongue should be forged. If

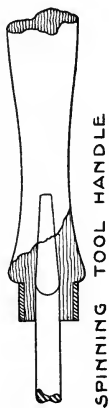
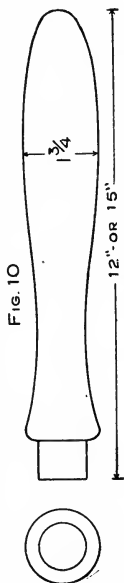
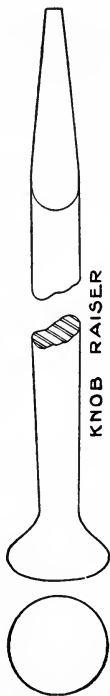

care is taken, the flat surface can be ground without burning the steel. This flat surface is the part of the tool which is used principally; the one operation of grinding together with polishing puts it in condition. It is well to have the cylindrical part of the tool, opposite the flat surface, ground and polished. This surface can sometimes be used.

It is believed that the tools of which mention has already been made might conclude the list of those making up the necessary tools in a spinner's kit, if it were not for some extraordinary or unusual shapes in spun work. For the purpose of spinning these peculiar forms special tools may be made at any time.

There are two other tools, the groover and the knob-raising tool—illustrated in Figs. 8 and 9 respectively—which may be used in places as substitutes for those already described, with perhaps some additional ease.

The groover, as the name implies, is used in making grooves. The operator finds the use for this tool almost entirely in spindle forms and, then, only for small grooves. It will be noticed from the cross-sectional view shown that small grooves of varying sizes may be made by simply using the tool in contact with the metal at different points on the curve of the tool. It is placed on top of the lathe-rest with the end hanging down and on the lathe side of the rest. The operator presses down on the handle, thus making a lever of the tool with the rest as the fulcrum.

As will be discerned later, the knob-raiser may be used in raising up or hooking under the metal in

spinning a dish concave toward the headstock; or it may be used by pressing it endwise toward the line of centers on the lathe, to form a concavity on a spindle form. It should be a comparatively easy matter to forge the knob-raiser, inasmuch as the end is simply upset in the fire and afterwards ground into the desired shape and polished.

Figure 10 gives the shape and the dimensions of the accepted handle for spinning tools. In this figure, also, is represented the method used in fastening the tool into the handle. Probably the best wood out of which handles may be turned is straight-grained, hard maple.

It is necessary that all tools, except those used for cutting and trimming purposes, should be long enough to permit the end of the handle to rest under the arm and thus aid the workman in getting a strong leverage by throwing the weight of his body downward. The handles are usually made from 12 to 15 in. in length and the tool long enough to admit of its being driven into the handle from 4 to 5 in. Pieces of gas or water pipe make very good ferrules. The tool and handle when fastened together should be from 2 ft. to 30 in. in length. Inasmuch as the tools are highly tempered, the wearing due to the spinning process does not change their shape rapidly. Consequently, reforging is not necessary except after the tool has been in service for a considerable length of time.

CHAPTER III

THE PREPARATION OF METAL FOR SPINNING

The metals commonly used in spinning are copper, white metal, brass, zinc and aluminum. Metals must be used which, by some process such as annealing, can be made perfectly pliable. It must be evident that only when metal is perfectly pliable can it be spun over irregular shapes. The constant friction between the tool and the metal tends to harden the metal, and hence it must be softened and made pliable, many times it may be, during a spinning process.

The thickness of metal most suitable for ordinary work varies from Brown and Sharpe gage No. 22 to No. 26, inclusive. Metal gaging 22 is used for the largest work only and then principally when the metal is copper. Gage 24 in brass and zinc becomes pliable with proper treatment and can be successfully used for forms varying in diameter and height from 3 in. up to 5 or 6 in. Metal of B. and S. gage No. 26 is more easily spun than thicker material, due to the fact that it assumes easily and quickly the desired form. Because of this fact, however, articles spun from it are sooner ruined than those spun from thicker metal. Gage 26 will not stand the continual pressure of the spinning tool very long. Metal of No. 26 gage is naturally adapted to the smallest work, but to be successfully spun should be used by workmen of some experience.

Thus far we have spoken of metals in a general way, and of no one metal in particular. We will discuss briefly the preparation and best uses of the four metals mentioned above.

Copper

Copper, varying in thickness between the gages referred to above, is perhaps most suitable for all general spinning, especially for school work and for amateurs. It is tough and when heated is very pliable. It is not so easily shattered by overheating, numerous heatings or long continuous working as are the other metals mentioned. It should be understood that all operations, in preparing the metal for spinning and those used after spinning is begun, should be as brief as possible and never duplicated unless necessary. As a matter of fact the annealing process will be repeated many times of necessity, especially by beginners. In learning to spin, one will keep the tool in one place on the metal until it becomes hard and tempered in a sense. As a young spinner will probably find difficulty in successfully producing a desired form in one operation it will be necessary for him to anneal or soften the copper before he completes spinning.

One must first calculate, with some degree of precision, the size of circular disc necessary to form the spun article. If spinning is properly done, the metal will be thinned very little, if any, in working it; consequently the computation of the disc size will involve in most cases some mensuration, but, principally, a good supply of common sense and judgment is needed. The workman will be greatly aided in his computation if he will make a cross-

sectioned drawing (through the axis of revolution) of the object he is spinning, and, with a pair of dividers, set to a small span, step off the length of the outline desired. Thus if in B, Fig. 11, (Cup and Chucks) one should start at O and step carefully by 1 and 2 to 3 he would have the radius of the disc out of which the cup could be spun. It will be desirable to make the radius of the disc slightly greater than the distance thus determined, if the metal is to be compressed any. If, on the other hand, the metal is thinned due to unnecessarily working the tool over the metal, the radius need not be quite as large as the outline distance spoken of.

The disc after being cut from a large sheet—in which form the metal is best purchased—is heated in an annealing furnace or over a Bunsen burner until it changes to an iridescent color and a film of copper oxide burns off. If an annealing furnace is used, the temperature may be controlled; but in case a Bunsen burner or blow-lamp is used—one of which methods would be followed probably for small work—the coloring of the metal, when the proper temperature is reached, must be the means of determining when the copper has been heated sufficiently. If it is heated beyond the proper point the strength of the metal is weakened and it may be even exhausted entirely. Nevertheless, in rough work, copper is heated until it is “red” hot and immediately plunged in water. This constitutes the annealing process. Some spinners, especially where considerable care is taken to preserve the strength of the metal, cover copper with oil when annealing it. This is by no means an undesirable

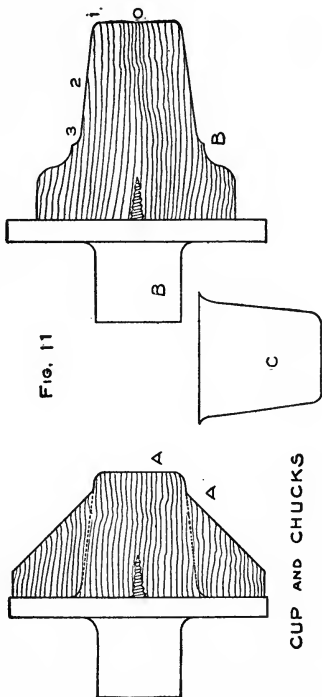

plan. The film of oil will evaporate and burn off as heat is applied; when the oil has completely disappeared the metal should be annealed. This, as well as the first method described, will not necessarily give accurate results. Both methods are simple, practical means which, together with a little experience, will aid in reaching uniform results.

If very precise work is necessary, as, for example, in spinning some article which must be kept under intense pressure, the best temperature for annealing must be carefully ascertained by experiment. In this case the annealing or some similar furnace should be used where accurate temperatures can be recorded.

To make this description perfectly clear it may be said that the following steps should be taken in spinning a piece of copper.

First: Cut from a plate of soft copper a circular disc of a calculated size to spin from it a particular object.

Second: If the copper is not quite soft and pliable heat it to a red heat and immediately plunge it into cold water.

Third: Place the disc in the lathe ready to spin. Apply the tool to it until the copper begins to harden perceptibly.

Fourth: Remove the copper from the lathe and anneal as previously described.

Fifth: Repeat the above instructions in the order given as few times as possible, but until the spinning process is completed.

White Metal

White metal is very easily spun and does not

need to be annealed. In the trades it is used as the base for most silver-plated ware; and consequently for forms which cannot be pressed out, the spinning process is a necessary one. If the lightness of the plated piece has not a large consideration in its production, it is advisable to use quite heavy white metal. There will be an explanation made in a future chapter concerning the drawing-out of metal in spinning. As the spinning process continues, the metal is liable to be worked thin by being drawn out. This is especially true in the case of white metal and thus the suggestion with reference to the use of heavy metal is opportune.

Brass

Brass is prepared for spinning in the manner describing the annealing of copper. The change of color in brass is not so perceptible, when sufficient heat has been applied, as in copper, and consequently the method of covering the metal with oil before heating will probably be the safest in annealing brass. For ordinary spinning it is quite immaterial whether or not one applies the same amount of heat for each annealing, so long as the metal is not overheated. Brass hardens more rapidly through the use of the spinning tool than copper does. When we remember, then, that there is greater danger of spoiling the metal by annealing it many times than by slightly overheating it once, we will understand why brass is more difficult to spin than copper. Wherever possible, one should use as thin brass as will be consistent with the strength required.

Zinc

We have said that it was perhaps advisable to immerse copper and brass in oil before annealing. This is still more important with zinc. Whether it is necessary or not to oil or grease zinc while heating it may be a question, but it is certainly advisable in the minds of old spinners. The theory seems to be that the oil tends to soften the metal when heat is applied. Zinc has a decidedly crystalline formation and the friction caused by the spinning tool rubbing against it tends to make it more, rather than less, crystalline. This molecular condition weakens the metal by decreasing its tensile strength and it becomes decidedly difficult to spin; especially is this true in thick pieces which have to be turned over abrupt corners. The melting point for zinc is about 780° Fahrenheit, which is considerably lower than the melting point for copper or good brass. This necessitates much more care in annealing zinc than is necessary with any other metal which is capable of being spun. It is decidedly advisable not to reach a temperature above 350° or 400° F. Of course this point in temperature cannot be determined except in an annealing furnace. It should be understood that after zinc is heated as above explained it is plunged into cold water before any attempt is made to spin it.

Aluminum

Ordinarily, aluminum does not need annealing. It may be better to heat it slightly when the metal is thick, but this is a matter which the operator must determine for himself by experiment. Like white metal, aluminum is easily worked, but it is

also easily shattered; and consequently the ease with which it can be spun sometimes results in a spoiled piece after considerable work has been done on it. Aside from the point of its being a good base for plated ware, there is no advantage in using aluminum. It is, however, light, and therefore may be desirable to use for large spun pieces.

CHAPTER IV

HOW TO SPIN A SHALLOW DISH

The very simplest spinning operations possible are involved in the spinning of a shallow dish of small diameter, such as a pin tray. Shallow forms may be difficult to spin, however, if they are irregular and complicated in cross-sectional outline. The one thing which makes them good examples for amateurs is their shallowness. They should be simple in form, also, if they are first pieces in spinning. I should say the amount of depression should not exceed 1 in. and the diameter should not be greater than 6 in. in the spinner's initial dish.

A shallow dish may be in either of two general classes, depending upon form, viz:—one in which the curve of depression is gradual from the rim to the bottom; or one in which the bottom of the dish is comparatively flat and the rim is formed by abruptly turning the metal over a corner, the rim being perpendicular to the general plane of the bottom. In the first class we find the saucer, and in the second such a form as the cover to a tin box—a baking-can, for example.

It will be evident that one of two things will tend to make a dish difficult to spin; either its great depth or some sharp corner which forms the dividing line between two surfaces. Right angle corners, therefore, are difficult to spin; especially so when the surface turned over, as in the rim of a dish, is very high.



Attractive in Shape and Finish

Either of the two faceplates sent with a wood-turning lathe may be used for the wooden form-blocks over which the metal is spun. It is best to use the center-screw faceplate for work of small diameter, such as a cup, for example; and the surface-screw faceplate for work of large diameter. If this suggestion is followed, one will probably use the surface-screw faceplate to spin low dish forms. The wooden form-block is made according to accepted methods of wood-turning. Two things must be true if the form is to serve satisfactorily the purpose for which it was turned: It must be perfectly smooth and it must be hard. Hard maple, well-scraped and sandpapered, makes a very good form for most spun work.

In some cases, as will be illustrated later, it is necessary to split a form in order to release it from the spun article. Dogwood is considered the best for this purpose, although straight-grained hard maple will answer the purpose very well. When a number of one particular form are to be spun, it is economy of time and labor to construct a cast-iron form-block. It is best not to loosen a form-block from the faceplate after it is once put in place until all spinning is finished. This may require the construction of duplicate faceplates for each lathe in case a lathe is used for some purpose besides the one in question before a spinning job is completed. It is better to do this, however, than to have the work running out of true due to removing the form-block from a faceplate to allow other work to be put on it.

When the metal disc has been cut and centered

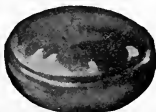

Artistic Designs

moderately well in the lathe between the spinners' center and the form over which it is to be spun, the workman is ready to begin spinning. (A cut showing the work in this stage is found on page 14.) It will be remembered from the discussion on spinners' centers that at first nothing holds the disc in a central position except the pressure of the center against the piece to be spun.

It is necessary to keep metal well greased when spinning it. Before putting it in the lathe it is well to apply whatever lubricant is to be used, and during the spinning process to make further applications whenever the disc becomes dry or at any time after it is annealed. Soft soap is considered as satisfactory as anything to use on copper. On brass and zinc spinners rub a tallow candle and this may be used, too, on copper. White metal and aluminum need only a little heavy oil from time to time to keep the tool from grinding the metal.

The illustration on page 14, Fig. 3, shows the general position of spinning tool and workman when the spinning process begins. In the right hand, with the handle under the right arm above the elbow, is held the spinner's tool and in the left, the end of a broom handle or some hard piece of wood of similar shape. Until it is possible to press the metal firmly against the form-block fastened on the faceplate the end of the piece of wood held in the left hand is kept opposite the end of the tool as it moves from the center of revolution outward and downward. The piece of metal as it is revolving has a piece of wood (tapered to allow a flat surface to come in contact with the spinning metal) on its

left, and the spinning tool on its right. The revolution of the lathe draws the tool down so that it is nearer the axis and a little lower than the end of the wooden support held in the left hand. The body throws the handle to the right, which causes the end of the tool to press to the left and consequently move the metal gradually toward and finally against the form-block. When the metal has at last been spun tightly against the form-block, the diamond point is used to trim the edge and the spun piece is complete. Usually in spinning a low dish of regular shape it is not necessary to anneal the metal after it is first put in the lathe. It should be understood, however, that annealing is necessary whenever the metal becomes hard. If it is not annealed as soon as it becomes hard it will shatter.

The spinning process may be accomplished also by holding the tool as described, except to have the tool end above the center of the lathe instead of below it. If this position is taken, the movement of the body must be two-fold, viz: downward and to the right, which will result in the tool point working upward instead of downward.

Probably in spinning a simple dish form no difficulty will be experienced in keeping the metal to a uniform thickness and the same thickness approximately as it was in the sheet. If, however, it is found that the metal is thinning, the tool, by reversing the movements of the body, must be made to travel toward the center of revolution. This will compress instead of draw out the metal. It must be very evident that an inward movement of the tool point will tend to bulge the metal at the point

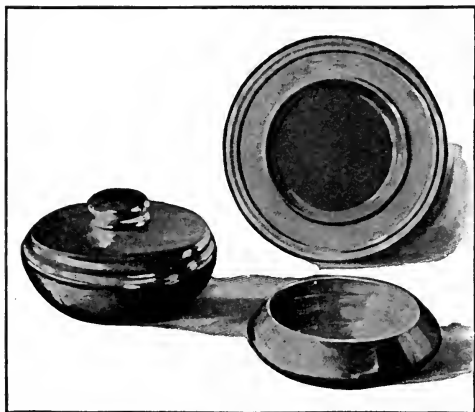

Three Attractive Pieces

where it is held between the center and the form-block. It is to avoid this, principally, that the first movement of the tool is taken away from the center or axis. Moreover, the metal must be worked against the form, at first, at the center until it is firmly in contact with the form-block. This is very important. If spinning is successfully done, it will be largely due to first establishing a firm contact between the metal and its form-block at the center. Gradually this contact surface is increased as the tool continues to work outward.

It has been assumed that the dish form will be spun with comparative ease. This will probably be true if the bulging, just referred to, and buckling do not together or separately hinder. As has been explained, bulging is the result of over-compression with the tool. Buckling is one phase of bulging. While the tool is working toward the center, bulging may take place. While the tool is working outward and when it is pressing against metal that is not in contact with the form-block but is simply being supported by the stick in the left hand, buckling is a common danger. The metal begins to feel rough under the tool and the tool will seem to jump from point to point. Upon investigation it will be found that the metal is folding or lapping in places. If it is at once annealed, the difficulty may be overcome, but otherwise it will continue and finally the metal will shatter, ruining the piece. There are two reasons for this. The first one: the stick is not kept directly opposite the tool point, and, in addition to this, is probably not pressed firmly enough against it. It may be true, also, that pressure is being ap-

plied too far from the contact surface, yet this in large work must be true, else the outer portion of the metal will tend to curl back toward the tailstock and the metal will take the form of a sombrero hat. The second reason: hard metal. With amateurs this is often the principal cause of buckling. The only remedy is to anneal the metal as previously mentioned.

It must be remembered that lubrication in spinning is quite as essential as the use of oil in machine

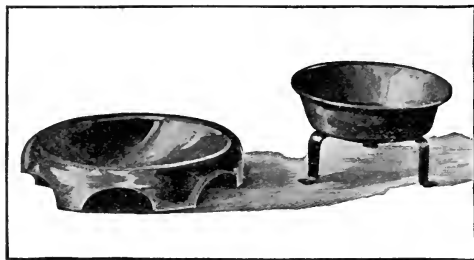

Two Popular Forms

bearings. Soap or tallow applied often and in small quantities is much better, as experience will prove, to both metal and workman than large quantities applied less frequently.

The speed of a lathe used for dish spinning depends somewhat upon the diameter of the disc when spinning is commenced. For disc diameters less than 7 or 8 in. a speed of from 1500 to 1800 r.p.m. is sufficient. For larger diameters lower

speeds are required. When the dish has finally been formed and smoothing and polishing are the only operations left, the speed may profitably be increased to 2000 r.p.m. or even more than this for small diameters. Too great a speed will, through centrifugal force, throw the metal away from the form-block.



CHAPTER V

HOW TO SPIN A DEEP DISH

Under this head I shall treat forms which approach the cylinder and require the use of two form-blocks (for beginners at least) instead of one. The illustration on page 42 shows forms of this character—cups, toothpick and match holders, etc. Spinning metal into a cylindrical form involves a difficult operation—that of turning the outer portion of the circular disc which is being spun, through an angle approaching 90° and consequently compressing very materially the metal at the outer portion of the disc. In addition to this there is the difficulty of turning the sharp corner between the bottom of the form and the cylindrical surface forming the sides. An experienced hand will do both of these things with apparent ease by using the tool and stick as described in Chapter III. However, as the metal is bent or turned through an angle approaching 90° the operator must spin in the air, as it is called. In other words, nothing supports the metal from the time it leaves the circular disc shape until it reaches the finished form except the tool and the supporting stick; the metal is therefore spinning in the air. If one is proficient in the art of spinning in the air, only one form-block will be needed for deep forms as was the case with shallow forms. Few men, however, are capable of spinning large pieces in the air when the metal at the outer portion of the disc must be compressed considerably. Intermediate form-blocks are therefore used.

To explain better deep dish spinning I shall refer to a specific problem which I have shown by line drawings on page 34, Fig. 11. A and B are vertical cross-sections through two form-blocks which in this case may be fastened on center screw faceplates, each form-block being turned and kept on a single faceplate until all spinning is done. A is the intermediate form-block and B the finished form-block for the cup illustrated at C, Fig. 11. The dotted line in A is a duplicate of the form B, so that one can easily estimate the relative amount of spinning which must be done on each block. It is supposed that the metal being spun will be annealed after it is taken from form-block A and before it is put on form-block B.

In showing only one intermediate form-block the writer is taking it for granted that the instructions given in Chapter IV will enable one to spin the metal on each of the two form-blocks without difficulty. If this is not true as many intermediate form-blocks as desired may be prepared consistent with the number of annealings which the metal will stand. It is always necessary to do some spinning in the air, otherwise the supporting stick which is held in the left hand would not be needed. This supporting stick, however, is in reality, only a makeshift form-block, and when the intermediate form-blocks are many, the process of supporting the metal by the use of the supporting stick is not called spinning in the air.

It will be noticed that the dotted outline and the solid outline in A coincide at the right, not only on the line which pictures the end of the chuck, but also for $\frac{3}{8}$ in. or $\frac{1}{2}$ in. on the cylindrical surface.

The object of the preliminary form-block and all intermediate form-blocks hereafter described is two-fold: first, to provide easy steps in the process of spinning; and, second, to give a contact surface when spinning is begun on succeeding form-blocks. The imagination, I believe, will easily lead one to appreciate the significance of the first of these objects, but the second will be fully appreciated only when one has endeavored to spin some form similar to the one illustrated where a contact surface is not maintained throughout the spinning process. When the metal is taken from form A and put on form B, a portion of the cup is in its final shape and is firmly seated on the form-block at the end, making the work secure.

The method of bringing the metal down to the block B after the block A has been produced is somewhat different than has heretofore been described. In obtaining form A the tool has been moved outward, with possibly a few exceptional strokes of the tool, toward the center. This has prevented bulging and has gradually drawn the metal into the desired shape without necessarily thinning it. If this same manipulation of the tool is continued when the intermediate block B is used the metal will be thinned until it will be liable to crack before the form-block is reached by the metal. Furthermore, it will buckle very probably, not because of its hardening or its being worked too far from the contact surface, but because it is thin and consequently weak. For these reasons the tool is moved toward the axis when using form-block B. This compresses the metal, as previously described, decreasing its circular measurements and at the

same time thickening it. It will not bulge during this process because the base of the cup is firm against the chuck. It must not be supposed that the inward movement must be used to the exclusion of the outward one. I mean to infer that the former should predominate. By careful work and gradual pressure the metal will finally touch the form-block at all points.

Mention has not been made thus far of the tools to be used, as it is believed enough was said in Chapter IV to enable the beginner to use his judgment in the selection of tools. My opinion is that the round-nose and lifting tool, if they are properly formed, can successfully do all dish and cup spinning of an ordinary character. For the purpose of smoothing, however, some tool with a flat surface, such as the tongue or planisher, will undoubtedly be used with more facility and possibly with better results. I would suggest the use of copper or aluminum for all work thus far described, if strength of material is an object and if the operator is an amateur of spinning work. However, white metal is more easily worked than copper and is the customary metal for the base in plated ware. Brass is rather too tough and hard, and zinc is too brittle for one to use in the experimental stage of spinning.

If considerable difficulty is experienced in securing the desired results, I offer the following as suggestive helps. First:—Endeavor to spin a saucer of small diameter and of simple outline, or a cup whose sides make an angle of about 75° with the base, before attempting something more difficult.

Second:—In cup spinning use three or even four form-blocks, if perseverance will not accomplish the desired result with two.

The speed of the lathe for work coming in the class here considered can be a trifle higher than that given as average in a previous chapter.



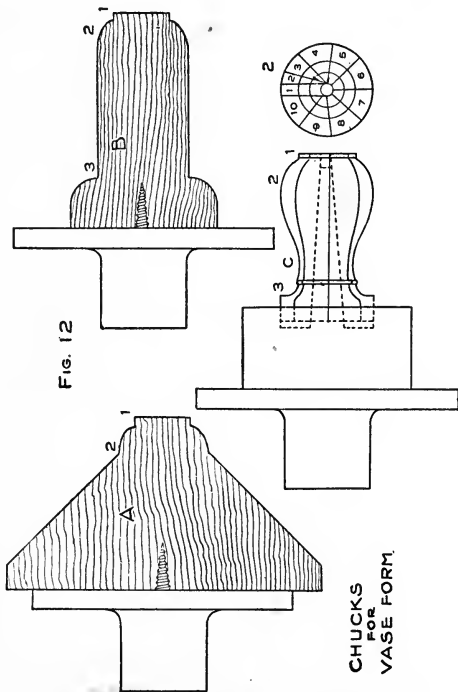

CHAPTER VI

HOW TO SPIN A VASE

In this chapter we will consider all forms which may be called vases. In some cases the word vase form implies a neck or a top smaller in diameter than the bottom. It is this peculiarity which seems to make it necessary that the spinning of vases should be dealt with separately.

The manipulation of the tools in this group or class of forms will be spoken of briefly as very few new operations in tool work are introduced. Usually a greater number of tools are required to complete a vase form than are used for simpler objects; these will be mentioned later.

The principal variation from the general method of work comes in making the form-blocks. Usually three form-blocks will be needed for a vase-form which has a neck smaller than its base, unless one is an adept at spinning in the air. As this book is supposed to be used by amateur workmen, as well as others, I shall consider that preliminary and intermediate form-blocks will be used in beginning work at least. We will consider a specific problem again in order to illustrate and describe to the best advantage detailed methods of spinning. Figure 12 shows vertical cross-sectional drawings of a preliminary and intermediate chuck, and the end view and elevation of the final form-block used in spinning a vase-form represented at C in this same cut. In Fig. 13 also will be seen a vertical cross-section

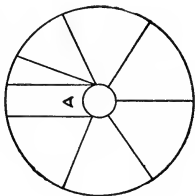
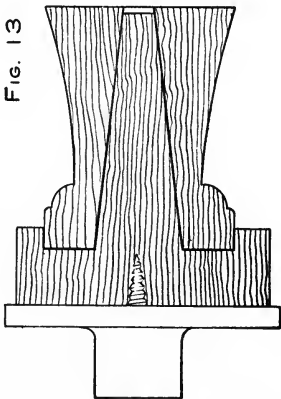

Fig. 13



view of a form-block showing the construction of a block or chuck for a vase with a small neck.

Here (Fig. 12), as in Chapter V, A and B are simply used as easy steps in obtaining the form shown at C. It is only necessary, I believe, to call attention to the fact that the diameters shown at 1 and 2, in A, B and C, and 3, in B and C, are the same. The object of this is to produce contact surfaces for each succeeding form-block.

One is not advised to undertake the spinning of a vase-form before simpler forms have been tried. This is because the work as a whole is more difficult than it is in simpler pieces. There is a particular difficulty, too, which should be mentioned. The neck of the vase being smaller than its base the metal must be compressed to an unusual degree as it is drawn over toward the several form-blocks. After this compression comes a drawing-out process, the result of which is the neck of the vase. Such severe treatment of the metal is safe only in the hands of spinners of some experience.

In order to draw the form-block out of the vase-form after it is spun, some kind of split-chuck must be used, such as is shown at C, or else the solid chuck must be burned and bored out of the finished article. As this last operation is much more difficult than one might at first suppose, and, also, as by this method of ridding the vase from its form the vase is liable to be damaged, it has become customary to devise some form of split-chuck with a key piece which, when withdrawn, will allow the remainder of the chuck parts to loosen, when they may be removed with ease.

In preparing these split-chucks one should first

carefully select a piece of dogwood or a very straight-grained piece of hard maple, and bore a hole, with the grain, through the block from end to end. It is desirable that this hole should taper slightly. This may be accomplished by first boring a straight hole and then carefully gouging it to a taper.

A better method of tapering the hole is to use a taper reamer after the straight hole is bored. The reamer will leave a hole that will be true and consequently an arbor will touch the stock at all points. If neither of these methods seems feasible, the straight, cylindrical hole may be made tapering by using a tapering, wooden spindle covered with sandpaper. When the hole has been properly prepared to receive the spindle, the two parts of the chuck should be put together and the desired form turned. This form or form-block, as we have called it, is next driven off of its arbor (the spindle) and split as illustrated in C, Fig. 12. The form-block is split so that all parts taper toward the center of the block except one, marked "1" in the illustration. This piece, the key piece, will be large at the center and small on the outside of the form-block. Besides being careful in turning and in splitting the chuck, one must use judgment in so proportioning all parts that the key piece may be first withdrawn through the hole which was bored for the arbor, and then others may be withdrawn without difficulty if they are not left too thick. When the chuck has finally been prepared as described, it is ready for use. The parts will be held together at the base by the metal, which has the same shape at the base of the vase as the last formed chuck. The parts are held to-



Specimens of the Spinner's Finest Effects

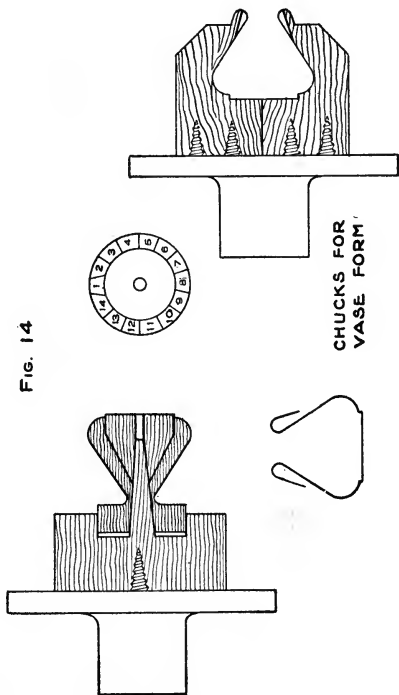

Fig. 14

CHUCKS FOR
VASE FORM

gether at the top of the vase by some device similar to the one shown at 3, Fig. 12, or a similar device more clearly illustrated in Fig. 13.

Probably the most difficult spinning to be done in the vase-form shown in Fig. 12 will be changing the form from A to B. Here the means of compressing the metal by spinning in the air will be employed. Bulging ought not to be the result, if the metal fits tightly at the base of the vase. A considerable amount of compressing must be done, however, to get the metal into the cylindrical form shown in B and one must use a great deal of care to prevent trouble in this operation. Instead of keeping the metal as thick as the original sheet one must compress it enough (in the vase-forms which have a neck) to allow it to be drawn out on chuck C, in making the concavity for the neck. This requires simply that the process of compression should be continued longer than usual. The neck is formed by placing the tool point under the axis of revolution and working from the larger diameters toward the smaller diameters after the cylindrical form spun on B is placed on block C. Attention is called to the fact that the diameters at 3 in B and C are the same, and also the same as the diameter at 2. Another method for forming the neck is to use such a tool as the lifter; it is pushed toward the axis and worked downward from each side toward the small diameter.

Should a form be desired with a substantial roll at the top, as in Fig. 14, an additional chuck may be required which will allow the whole vase, with the exception of the top, to be admitted, as shown in Fig. 14 at the bottom of the sheet. In this kind

of a vase-form, in which the base is larger than the top, the chuck used in making the rolled neck must be split in halves or quarters in order to allow the chuck to be withdrawn from the finished vase-form.

I have only indicated the methods employed by old spinners in obtaining double-curve vase-forms. There is great opportunity for original devices and methods in spinning any article, but in this class of work perhaps there is more chance for the development of individuality on the part of the workman than in work such as has been described in previous chapters.

Little more need be said concerning the use of tools, annealing, etc. than has already been said. Annealing must take place whenever necessary, but workmen should be proficient enough in spinning, when undertaking a difficult form, to require the minimum number of annealings for a particular piece of work. The tools used for any form should be selected with reference to their size and shape. As a rule the round-nose is considered the general tool. The knob raiser is the tool used particularly for lifting or raising in shallow portions of the form or in grooves. The planisher or the tongue is a satisfactory tool for smoothing straight, conical or cylindrical surfaces.

CHAPTER VII

HOW TO SPIN SOME UNCLASSIFIED FORMS

Whatever a man's occupation may be he is at any time liable to be confronted with new problems. The school cannot teach all, even though it strives to lay the foundation for all. I have attempted in these chapters to give the foundation for all metal spinning as it is now practised. In this chapter I shall speak only of a few operations which may add to the information thus far given, and, should the reader spin other forms than those previously described, this chapter may be helpful.

Spinning in the air has been referred to as the control of the metal when it is spinning between the tool in the right hand and a stick in the left. It is true that this is one kind of spinning in the air, but there is another kind that I wish to describe. In general, air spinning or spinning in the air is any spinning operation in which the desired form is obtained without the use of a form-block or chuck. Usually this kind of spinning requires great skill, but there are operations in this class which, with little practice, are performed with comparative ease. The illustration, Fig. 15, shows a piece of spindle spinning which has an irregular shape in the center where the diameters are smaller than those at the ends of the spindle. If all of this should be spun over a solid form, it would be impossible to withdraw the form when spinning was completed. It is also practically impossible to make a workable

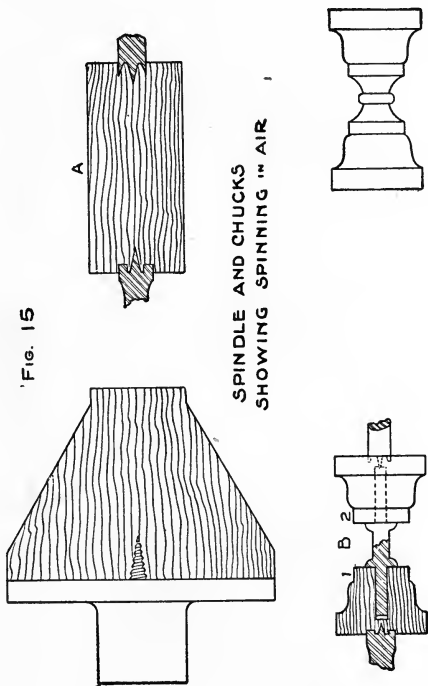

split form, due to the small diameters. Either one of the following two methods seems possible. One, that of spinning over a solid form which will, in the end, be burned or bored out, or, the other, that of spinning the metal without the use of a definite form. The former of these two methods is slow, and dangerous to the article spun. The latter is quickly accomplished and, when the spinning operations are completed, additional work is unnecessary.

Figure 15 shows two chucks used in forming the spindle. A is solid and is the form first used. B shows the second form used. It will be noticed that the shape of the chuck A permits of its removal from the spun article without difficulty. The shape of the finished piece, however, would interfere in such a removal, consequently some chuck is devised which will hold the metal spindle at each end and may be withdrawn when the central part of the spindle is finished.

The part of the spindle between points 1 and 2 is spun in the air. The tool is carefully pressed against the metal as it revolves, working from the large diameter which was formed on chuck A to the small diameters as indicated in the drawing. Here one can use such tools as the groover and tongue to good advantage. This illustration of spinning in the air will serve to explain the meaning of this expression and to show the possibilities in this direction. The scope of this particular kind of spinning can only be realized as one practises and strives to be ingenious in the invention of means whereby difficult forms may be produced.

Thus far, with the exception of a single mention of a means of producing a large roll at the top of

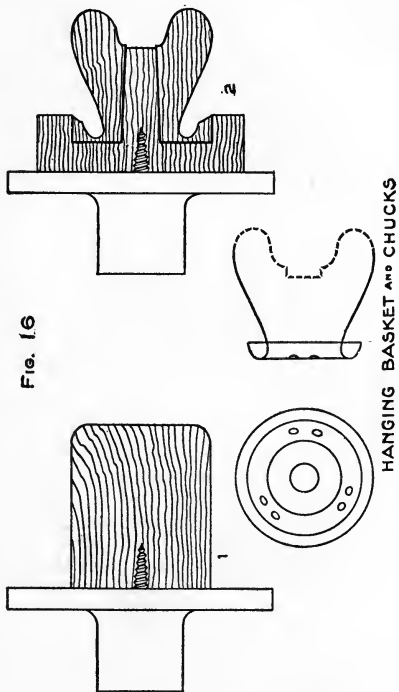

Fig. 16

HANGING BASKET AND CHUCKS

a vase, all faceplate chucks described have been convex toward the faceplate. Some work requires a chuck which is concave toward the head of the lathe. Usually, when this is true, a preliminary chuck of the first kind is used to spin the base of the article desired and also to spin the metal above the base into a cylindrical shape.

An example of work which will require both the convex and concave chucks is given in a hanging flower pot, Fig. 16. Most plants which may be kept in a hanging pot require considerable water and many of them require water continually standing in the pot. At the same time earth ventilation is necessary. The spun pot illustrated on page 66 is designed to fill these needs, and serves in this instance as a good example for a problem in spinning.

The style of chuck ordinarily used for spinning cups will first be employed. The end of this form is flat and as the metal which will form the bottom of the pot will be concave, as illustrated, considerable metal should be compressed near the axis of revolution for this purpose. Usually the first movement of the tool is outward from the center. This operation produces a contact surface and thins the metal slightly. To compress the metal we must move the tool toward the center, but this will possibly loosen the metal at the base and may also bulge it. These risks must be taken, however, and can be overcome by using both the outward and inward motions of the tool in successive strokes. The outward strokes will tend to keep the metal in its proper shape, while the inward strokes, if sufficient force is exerted, will compress the metal slight-

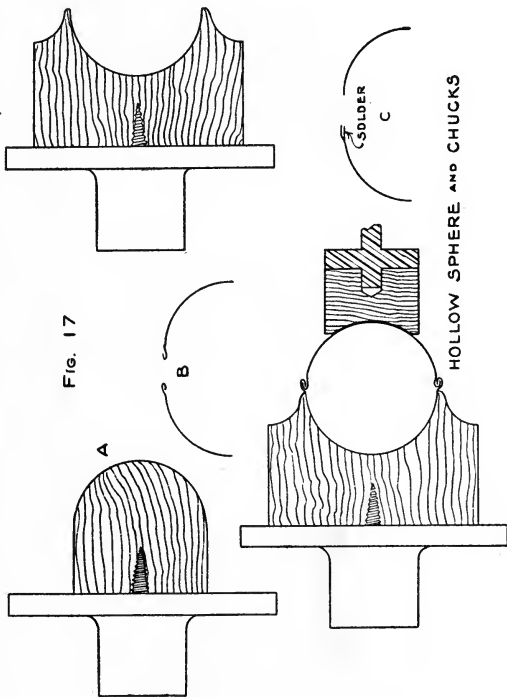

Fig. 17

ly with each movement. When sufficient compression has been obtained, the metal may be drawn over the chuck as described in previous chapters.

The chuck with the concave bottom is used when the metal has been spun to the first form. The basket as it comes from chuck 1 has a large contact surface prepared for chuck 2, and if the contact is a good one, the center may here be dispensed with and the rest may be placed at right angles to the lathe-bed and directly in front of the work after the neck of the basket is spun. The raising-up tool, round-nose or knob raiser may be employed in concaving the bottom by gradually working the tool outward, principally, and inward but slightly. The hole in the bottom can be drilled through while the work is still on the chuck, by placing a drill in a tailstock chuck as in regular machine-shop work. Probably the hole may be as satisfactorily cut by using the point of a diamond point hand-tool just before removing the basket from this chuck or form-block, which must be split as in Fig. 14, as by drilling.

I believe we have considered all the necessary operations for spinning single pieces of metal. I shall attempt to give the reader an idea of the method of spinning two pieces of metal together. No better example, I believe, can be given than the hollow sphere. Illustrations of this are shown in Fig. 17.

Two hemispheres are separately spun as illustrated at A. In fact each should be greater in depth than in diameter to allow for the inward and outward turns of the edges shown at B. After the two pieces have come from the convex chuck, each is

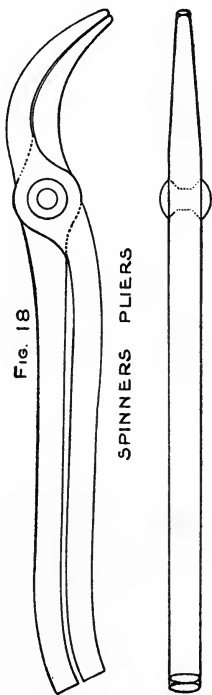

put into a concave chuck which permits the hemispheres to set inside with the amount, which was left for the turn, projecting. The outward turn is easily made by gently pressing the round-nose or the back of the tongue tool against the edge of the metal on the inside of the hemisphere and allowing the tool to follow the metal as it rolls outward. After the roll has been made it may be pressed down to the regular shape and thickness.

The half which has the edge turned inward is placed in the same chuck which was used for the first half and the turn accomplished in practically the same manner, except that the tool is pressed against the metal from the outside and follows it as it turns inward. When the turn has been completed to the satisfaction of the workman, he presses the end of the grooving tool or round-nose against the inside of the hemisphere just at the end of the turn and makes the slight roll shown at B. This forms a slight shoulder against which the second half of the sphere presses when the two are formed together. Either the inward or outward rolled edge may be formed by the use of the spinners' pliers which are shown in Fig. 18. If these are employed instead of the ordinary spinning tools, they grasp the edge of the metal as it revolves and the workman throws the handle in or out, depending upon the formation of the inward or outward turn. It is best to complete last the half having the inward roll. This half should remain in the chuck when the two halves are formed together.

Leaving the first half in its place in the chuck, the second half is pressed into it until the two rolls come together, when the tail center is drawn up

and presses the two halves firmly together. A firm but slight pressure with the end of the groover spins the two halves together. If the sphere is desired perfectly air or water tight, a bit of solder may be run into the seam.

The method of making the sphere just described is by no means a simple one nor is it one that can be followed with success by all workmen. C in Fig. 17 shows another means of reaching the same results in an easier way, but here an extra strip is soldered on the inside of one of the hemispheres which does not permit of spinning operations alone being used in the production of the finished article. Such a problem as this is more practically done by pressing machines than by spinning methods as herein described.

In closing this chapter, and as a last word, I wish to express the hope that many will undertake this almost entrancing form of cold metal work. It deserves a place among the crafts, and, I believe, is worthy of consideration from a commercial standpoint.





Examples in Copper



Contents

Aluminum	37
Brass	36
Copper	32
Dish, Deep, How to Spin	49
Dish, Shallow, How to Spin	39
Lathe and Its Parts	11
Metal, Preparation for Spinning	31
Metal, White	35
Preparation of Metal for Spinning	31
Tools	21
Unclassified Forms, How to Spin	63
Vase, How to Spin	55
White Metal	35
Zinc	37

University of California
SOUTHERN REGIONAL LIBRARY FACILITY
305 De Neve Drive - Parking Lot 17 • Box 951388
LOS ANGELES, CALIFORNIA 90095-1388

Return this material to the library from which it was borrowed.

52 ml



A 000 503 352 7

TT
206
C85m

UNIVERSITY OF CALIFORNIA
LOS ANGELES
LIBRARY

Uni
S