



MBL/WHOI



0 0301 0010292 7

THE MICROSCOPE

1



X6

2

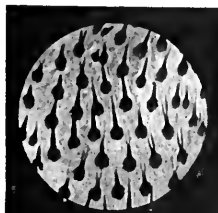

X510

3



X510

5

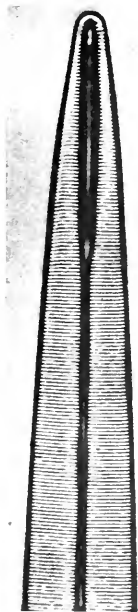

X1860

4

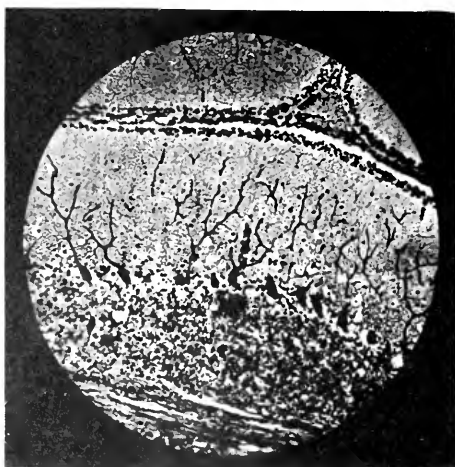

X77

6



X490

7

8

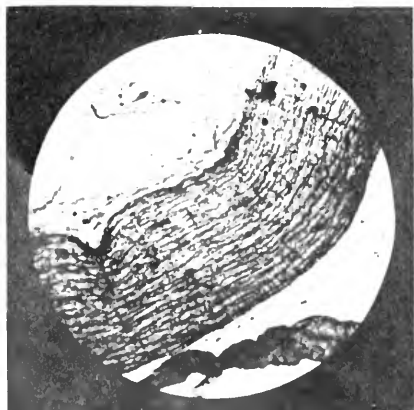

X140



X138

1

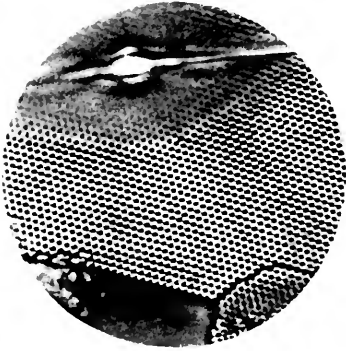

X1750

2

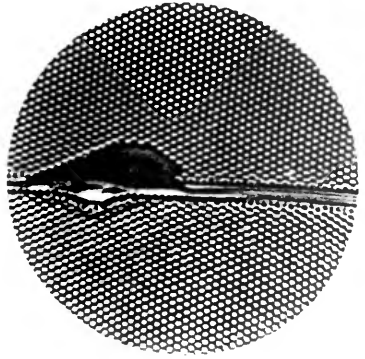

X1750

3

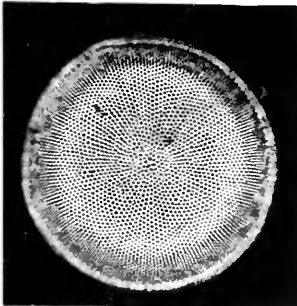

X110

4

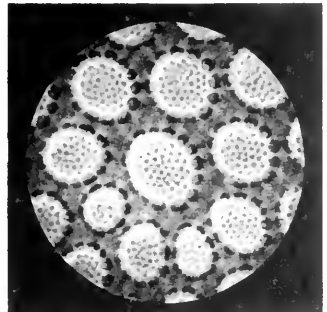

X2000

5

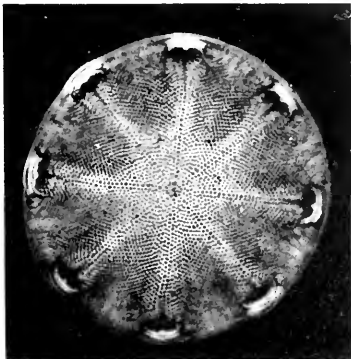

X270

6

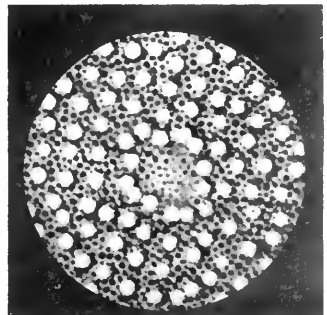

X2000

THE
MICROSCOPE
AND
ITS REVELATIONS

BY THE LATE
WILLIAM B. CARPENTER, C.B., M.D., LL.D., F.R.S.

EIGHTH EDITION

IN WHICH THE FIRST SEVEN AND THE TWENTY-THIRD CHAPTERS HAVE
BEEN ENTIRELY REWRITTEN, AND THE TEXT THROUGHOUT
RECONSTRUCTED, ENLARGED, AND REVISED

BY THE REV.
W. H. DALLINGER, D.Sc., D.C.L., LL.D., F.R.S., &c.

WITH XXII PLATES AND NEARLY NINE HUNDRED WOOD ENGRAVINGS



LONDON
J. & A. CHURCHILL
7 GREAT MARLBOROUGH STREET
1901



P R E F A C E

ALTHOUGH no changes of so important a character as those which distinguished the VIIth Edition of this book from the editions that had preceded it have been necessitated, yet a thorough and complete revision of the entire text has been made, and everything of importance to Microscopy which has transpired in the interval has been noted. This applies to the theory of the microscope as well as to its use.

We have adopted a classification of microscopes that we hope may be of value to many in the purchase of a stand, especially as we also point out with pleasure the great and successful efforts which English, Continental, and American makers have made within the last few years to supply good and useful microscopes at a greatly reduced price.

Invaluable aid and suggestion have been given me by my friend MR. E. M. NELSON, ex-President of THE ROYAL MICROSCOPICAL SOCIETY, to whom my thanks are due. MR. ARTHUR BOLLES LEE has rendered unique service in the section dealing with the Preparation and Mounting of Objects; and to PROF. E. CROOKSHANK I am indebted for valuable and useful help. In the matter of the Application of the Microscope to Geological Investigation the REV. PROF. T. BONNEY, F.R.S., has been, fortunately, my valued co-adjutor. On the subjects of Micro-crystallisation, Polarisation, and Molecular Coalescence, I have received the expert advice and help of MR. W. J. POPE, F.I.C., F.C.S., &c., Chemist to the Goldsmiths' Technical Institute, whose large practical knowledge of this department of chemistry is widely known.

For the valued help of PROF. A. W. BENNETT, M.A., B.Sc., Lecturer on Botany at St. Thomas's Hospital, and of PROF. F. JEFFREY BELL, M.A., Professor of Comparative Anatomy and Zoölogy, King's College, London, I have, as in the former Edition, to make my appreciative acknowledgments.

It is hoped that this Edition may, as its predecessors have done, prove of practical help to many in understanding the scientific use of the microscope.

W. H. DALLINGER.

LONDON: MARCH 1901.

P R E F A C E

TO

T H E S E V E N T H E D I T I O N

THE use of the Microscope, both as an instrument of scientific research and as a means of affording pleasure and recreative instruction, has become so widespread, and the instrument is now so frequently found in an expensive form capable of yielding in skilled hands good optical results, that it is eminently desirable that a treatise should be within the reach of the student and the tiro alike, which would provide both with the elements of the theory and principles involved in the construction of the instrument itself, the nature of its latest appliances, and the proper conditions on which they can be employed with the best results. Beyond this it should provide an outline of the latest and best modes of preparing, examining, and mounting objects, and glance, with this purpose in view, at what is easily accessible for the requirements of the amateur in the entire organic and inorganic kingdoms.

This need has been for many years met by this book, and its six preceding editions have been an extremely gratifying evidence of the industry and erudition of its Author. From the beginning it opened the right path, and afforded excellent aid to the earnest amateur and the careful student.

But the Microscope in its very highest form has become—so far at least as objectives of the most perfect construction and greatest useful magnifying power are concerned—so common that a much more accurate account of the theoretical basis of the instrument itself and of the optical apparatus employed with it to obtain the best results with ‘high powers’ is a want very widely felt.

The advances in the mathematical optics involved in the construction of the most perfect form of the present Microscope have been very rapid during the last twenty years; and the progress in the principles of practical construction and the application of theory

has, even since the last edition of this book was published, been so marked as to produce a revolution in the instrument itself and in its application. The new dispensation was dimly indicated in the last edition; but it has effected so radical a change in all that appertains to Microscopy that a thorough revision of the treatment of this treatise was required. The great principles involved in the use of the new objectives and the interpretation of the images presented by their means, are distinct and unique; and unless these be clearly understood the intelligent use of the finest optical appliances now produced by mathematical and practical optics cannot be brought about. They have not rendered the use of the instrument more difficult—they have rather simplified its employment, provided the operator understand the general nature and conditions on which his Microscope should be used. If the modern Microscope be, as a mechanical instrument with its accompanying optical apparatus, as good as it can be, a critical image—a picture of the object having the most delicately beautiful character—is attainable with ‘low powers’ and ‘high powers’ alike. Microscopists are no longer divisible into those who work with ‘high powers’ and those who work with ‘low powers.’ No one can work properly with either if he does not understand the theory of their construction and the principles upon which to interpret the results of their employment. If he is familiar with these the employment of any range of magnifying power is simply a question of care, experiment, and practice; the principles applicable to the one are involved in the other. Thus, for example, a proper understanding of the nature and mode of optical action of a ‘sub-stage condenser’ is as essential for the very finest results in the use of a 1-inch object-glass as in the use of a 2 mm. with N.A. 1.40 or the 2.5 mm. with N.A. 1.60, while it gives advantages not otherwise realisable if the right class of condenser used in the right way be employed with the older $\frac{1}{30}$ th inch or $\frac{1}{35}$ th inch achromatic objectives, and especially the $\frac{1}{12}$ th inch and $\frac{1}{20}$ th inch objectives of Powell and Lealand, of N.A. 1.50. Without comparing the value of the respective lenses, the best possible results in every case will depend upon a knowledge of the nature of the instrument, the quality of the condenser required by it, and its employment upon right principles.

This is but one instance out of the whole range of manipulation in Microscopy to which the same principles apply.

In its present form, therefore, a treatise of this sort, preserving the original idea of its Author and ranging from the theory and construction of the Microscope and its essential apparatus, embracing a discussion of all their principal forms, and the right use of each, and passing to a consideration of the best methods of preparation and

mounting of objects, and a review of the whole Animal, Vegetable, and Inorganic Kingdoms specially suited for microscopic purposes, must be essentially a cyclopaedic work. This was far more possible to one man when Dr. Carpenter began his work than it was even when he issued his last edition. But it is practically impossible now. It is with Microscopy as with every department of scientific work—we must depend upon the specialist for accurate knowledge.

In the following pages I have been most generously aided. In no department, not even that in which for twenty years I have been specially at work, have I acted without the cordial interest, suggestion, and enlightenment afforded by kindred or similar workers. In every section experts have given me their unstinted help. To preserve the character of the book, however, and give it homogeneity, it was essential that all should pass through one mind and be so presented. My work for many years has familiarised me, more or less, with every department of Microscopy, and with the great majority of branches to which it is applied. I have therefore given a common form, for which I take the sole responsibility, to the entire treatise. The subject might have been carried over ten such volumes as this; but we were of necessity limited as to space, and the specific aim has been to give such a condensed view of the whole range of subjects as would make this treatise at once a practical and a suggestive one.

The first five chapters of the last edition are represented in this edition by seven chapters; the whole matter of these seven chapters has been re-written, and two of them are on subjects not treated in any former edition. These seven chapters represent the experience of a lifetime, confirmed and aided by the advice and practical help of some of the most experienced men in the world, and they may be read by any one familiar with the use of algebraic symbols and the practice of the rule of three. They are not in any sense abstruse, and they are everywhere practical.

In the second chapter, on The Principles and Theory of Vision with the Compound Microscope, so much has been done during the past twenty years by Dr. ABBE, of Jena, that my first desire was to induce him to summarise, for this treatise, the results of his twenty years of unremitting and marvellously productive labour. But the state of his health and his many obligations forbade this; and at length it became apparent that if this most desirable end were to be secured, I must re-study with this object all the monographs of this author. I summarised them, not without anxiety; but that was speedily removed, for Dr. ABBE, with great generosity, consented to examine my results, and has been good enough to write that he has 'read [my] clear expositions with the greatest interest;' and, after

words which show his cordial friendliness, he says: 'I find the whole . . . much more adequate to the purposes of the book than I should have been able to write it. . . . I feel the greatest satisfaction in seeing my views represented in the book so extensively and intensively.'

These words are more than generous; but I quote them here in order that the reader may be assured of the accuracy and efficiency of the account given in the following pages of the invaluable demonstrations, theories, and explanations presented by Dr. ABBE on the optical principles and practice upon which the recent improvement in the construction of microscopical lens systems has so much depended.

It will not be supposed that I implicitly coincide with every detail. Dr. ABBE is too sincere a lover of independent judgment to even desire this. But it was important that his views as such should be found in an accessible English form; in that form I have endeavoured to present them; and in the main there can be no doubt whatever that these teachings are absolutely incident with fact and experience. In details, as may appear here and there in these pages, especially where it becomes a question of practice, I may differ as to method, and even interpretation, from this distinguished master in Mathematical Optics. But our differences in no way affect the great principles he has enunciated or the comprehensive theory of microscopical vision he has with such keen insight laid down.

In preparing the remainder of the seven new chapters of this book I have sought and, without hesitancy, obtained advice and the advantage of the support of my own judgment and experience from many competent men of science, who have shown a sincere interest in my work and have aided me in my endeavours. But first on the list I must place my friend Mr. E. M. NELSON. Our lines of experience with the Microscope have run parallel for many years, although the subjects of our study have been wholly different; but the advantages of his suggestion, confirmation, and help have been of constant and inestimable value to me. He placed his knowledge, instruments, and experience at my disposal, fully and without limit or condition; and his exceptional skill in Photo-micrography has enabled me to add much to the value of this book.

To Count CASTRACANE I am indebted for valuable suggestions regarding the Diatomacea, to be used at my discretion; to Dr. VAN HEURCK I am also under much obligation for his courtesy in preparing Plate XI. of this book, giving some of his photo-micrographic work with the new object-glass of 2.5 mm. N.A. 1.60. The full description of this plate is given, with some critical remarks, in the General Description of Plates. To the late and deeply

lamented Dr. H. B. BRADY, F.R.S., I am under obligation for valuable suggestions regarding the Foraminifera.

From Dr. HUDSON I have received cordial aid in dealing with his special subject, the Rotifera; and to Mr. ALBERT MICHAEL I am under equal obligation for his assistance in regard to the Acarina.

Mr. W. T. SUFFOLK gave me his most welcome judgment and advice regarding my chapter on Mounting, and I received also the suggestions of Mr. A. COLE with much pleasure and advantage. I have received help from Dr. A. HILL, of Downing College, Cambridge, and from Professor J. N. LANGLEY, of Trinity College, Cambridge—from both of whom special processes of preparation for histological work were sent.

Mr. FRANK CRISP, with characteristic generosity, aided me much by suggestions of special and practical value; and Mr. JOHN MAYALL, jun., the present Secretary of the Royal Microscopical Society, has been untiring in his willingness to furnish the aid which his influence was able to secure.

To Professor W. HICKS, F.R.S., Principal of Firth College, Sheffield, I am indebted for the revision of special sheets; so also I owe acknowledgments to Dr. HENRY CLIFTON SORBY, F.R.S., and to Dr. GROVES, as well as to others, whose suggestions, advice, or confirmation of my judgments have been much esteemed; and prominent amongst these are Professor ALFRED W. BENNETT, B.Sc., and Professor F. JEFFREY BELL, M.A., whose constant advice in their departments of Biology I have received throughout; while in Micro-geological subjects I have been aided by the suggestions and experience of Professor J. SHEARSON HYLAND, D.Sc.

It will be observed that every endeavour has been made to bring each of the many subjects discussed in this book into conformity with the most recent knowledge of experts. Many of the sections, in fact, have been wholly rewritten and illustrated from new and original sources; this may be seen in the sections on the History as well as the Construction and Use of the Microscope and its appliances, as also in those on Diatomaceæ, Desmids, Saprophytes, Bacteria, Rotifera, Acarina, and in the chapters on Microscopic Geology and Mineralogy. To the same end nineteen new plates have been prepared and 300 additional woodcuts, many of which are also new, and for the use of the majority of those which are not so, I am indebted to the Editors and Secretary of the Royal Microscopical Society.

There certainly never was a time when the Microscope was so generally used as it now is. With many, as already stated, it is simply an instrument employed for elegant and instructive relaxation and amusement. For this there can be nothing but commendation, but it is

desirable that even this end should be sought intelligently. The social influence of the Microscope as an instrument employed for recreation and pleasure will be greater in proportion as a knowledge of the general principles on which the instrument is constructed are known, and as the principles of visual interpretation are understood. The interests of these have been specially considered in the following pages; but such an employment of the Microscope, if intelligently pursued, often leads to more or less of steady endeavour on the part of amateurs to understand the instrument and use it to a purpose in some special work, however modest. This is the reason of the great increase of 'Clubs' and Societies of various kinds, not only in London and in the provinces, but throughout America; and these are doing most valuable work. Their value consists not merely in the constant accumulation of new details concerning minute vegetable and animal life, and the minute details of larger forms, but in the constant improvement of the quality of the entire Microscope on its optical and mechanical sides. It is largely to Amateur Microscopy that the desire and *motive* for the great improvements in object-glasses and eye-pieces for the last twenty years are due. The men who have compared the qualities of respective lenses, and have had specific ideas as to how these could become possessed of still higher qualities, have been comparatively rarely those who have employed the Microscope for professional and educational purposes. They have the rather simply *used*—employed in the execution of their professional work—the best with which the practical optician could supply them. It has been by amateur microscopists that the opticians have been incited to the production of new and improved objectives. But it is the men who work in our biological and medical schools that ultimately reap the immense advantage—not only of greatly improved, but in the end of greatly cheapened, object-glasses. It is on this account to the advantage of all that the amateur microscopist should have within his reach a handbook dealing with the principles of his instrument and his subject.

To the medical student, and even to the histologist and pathologist, a treatise which deals specifically with the Microscope, its principles, and their application in practice, cannot fail, one may venture to hope, to be of service.

This book is a practical attempt—the result of large experience and study—to meet this want in its latest form; and I sincerely desire that it may prove useful to many.

W. H. DALLINGER.

CONTENTS

CHAPTER	PAGE
I. ELEMENTARY PRINCIPLES OF MICROSCOPICAL OPTICS	1
II. THE PRINCIPLES AND THEORY OF VISION WITH THE COM- POUND MICROSCOPE	36
III. THE HISTORY AND DEVELOPMENT OF THE MICROSCOPE	117
IV. ACCESSORY APPARATUS	270
V. OBJECTIVES, EYE-PIECES, THE APERTOMETER	353
VI. PRACTICAL MICROSCOPY: MANIPULATION AND PRESERVATION OF THE MICROSCOPE	397
VII. PREPARATION, MOUNTING, AND COLLECTION OF OBJECTS	438
VIII. MICROSCOPIC FORMS OF VEGETABLE LIFE—THALLOPHYTES	530
IX. FUNGI	633
X. MICROSCOPIC STRUCTURE OF THE HIGHER CRYPTOGAMS	665
XI. OF THE MICROSCOPIC STRUCTURE OF PHANEROGAMIC PLANTS	684
XII. MICROSCOPICAL FORMS OF ANIMAL LIFE—PROTOZOA	726
XIII. ANIMALCULES—INFUSORIA AND ROTIFERA	753
XIV. FORAMINIFERA AND RADIOLARIA	795
XV. SPONGES AND ZÖOPHYTES	855
XVI. ECHINODERMA	884
XVII. POLYZOA AND TUNICATA	904
XVIII. MOLLUSCA AND BRACHIOPODA	919
XIX. WORMS	943
XX. CRUSTACEA	957
XXI. INSECTS AND ARACHNIDA	972
XXII. VERTEBRATED ANIMALS	1017
XXIII. APPLICATION OF THE MICROSCOPE TO GEOLOGICAL INVESTIGA- TION	1066
XXIV. CRYSTALLISATION, POLARISATION, MOLECULAR COALESCENCE	1094
INDEX	1137

EXPLANATION OF PLATES

FRONTISPIECE

Fig. 1. $\times 6$ diameters. Horizontal and transverse section of an orbitolite.

Fig. 2. An imperfect or uncritical image of the minute hairs on the lining membrane of the extremity of the proboscis of the blow-fly $\times 510$ diams., taken with a Zeiss apochromatic $\frac{1}{4}$ -inch objective of $\cdot 95$ N.A. $\times 3$ projection eye-piece; but it was illuminated by a cone of small angle, viz. of $0\cdot 1$ N.A., and illustrates the unadvisability of small cones for illumination.

The first obvious feature in the picture is the doubling of the hairs which are out of focus; but the important difference lies in the bright line with a dark edge round the hairs which are precisely in focus. This is a diffraction effect which is always present round the outlines of every object illuminated by a cone of insufficient angle. Experiment shows that this diffraction line always ceases to be visible when the aperture of the illuminating cone is equal to about two-thirds the aperture of the objective used; but it will become again distinctly apparent when the aperture of the cone is reduced less than half that of the objective.

Fig. 3. $\times 510$ diams. A correct or critical image of the minute hairs on the lining membrane of the extremity of the blow-fly's proboscis. In this picture the focus has been adjusted for the long central hair. It will be observed that this hair is very fine and spinous; it has not the ring socket which is common to many hairs on insects, but grows from a very delicate membrane, which in the balsam mount is transparent. This photograph was taken with a Zeiss apochromatic $\frac{1}{4}$ of $\cdot 95$ N.A. $\times 3$ projection eye-piece. The illumination was that of a large solid axial cone of $\cdot 65$ N.A. from an achromatic condenser, the source of light being focussed on the object.

Fig. 4. Section of cerebellum of a lamb, $\times 77$ diams., by apochromatic 1-inch $\cdot 3$ N.A. This preparation was courteously supplied to the present Editor by Dr. Hill, whose imbedding and staining processes for these tissues it beautifully illustrates.

Fig. 5. *Amphipleura pellucida* $\times 1860$ diams., by apochromatic $\frac{1}{8}$ $1\cdot 4$ N.A. illuminated by a very oblique pencil in one azimuth along the valve.

Fig. 6. A hair of *Polyxenus lagurus*, a well-known and excellent test object for medium powers $\times 490$ diams. by apochromatic $\frac{1}{4}$ $\cdot 95$ N.A.

Fig. 7. A small vessel in the bladder of a frog, prepared with nitrate of silver stain, showing endothelium cells, $\times 40$ diams., by Zeiss A. $\cdot 2$ N.A. This object has been photographed for the purpose of exposing the fallacy which underlies the generally accepted statement that 'low-angled' glasses are the most suitable for histological purposes. The supposition that it is so has been founded on the fact that the penetration of a lens varies inversely as its aperture; therefore, it is said, a 'low-angled' glass is to be preferred to a wide-angled one, because 'depth of focus,' which is supposed to enable one to see into tissues, is the end in view.

On carefully examining this figure it will be noticed that it is almost impossible to trace the outline of any particular endothelium-cell because its image is confused with that of the lower side of the pipe. In a monocular microscopical image a perspective view does not exist; it is better, therefore, to use a wide-angled lens, and so obtain a clear view of a thin plane at one time, and educate the mind to appreciate solidity by means of focal adjustment. It will be admitted that unless one approaches fig. 7 with a pre-conceived idea of

what an endothelium-cell is like, the knowledge gained of it will be small indeed.

Fig. 8 represents the same structure, $\times 138$ diams., by an apochromatic $\frac{1}{2}$ ·65 N.A. Here only the upper surface of the pipe is seen, so that the outline of the endothelium-cells can be clearly traced. The circular elastic tissue is also displayed. There is, moreover, an increased sharpness over the whole picture, due to the greater aperture of the objective.

PLATE I

Fig. 1. The inside of a valve of *Pleurosigma angulatum*, showing a 'postage-stamp' fracture, $\times 1750$ diams., with an apochromatic $\frac{1}{12}$ 1·4 N.A. by Mr. T. F. Smith, and illustrating his view of the nature of the *Pleurosigma* valve.

Fig. 2. The outside of a valve of *Pleurosigma angulatum*, showing a different form of structure, $\times 1750$ diams., with an apochromatic $\frac{1}{12}$ 1·4 N.A. by Mr. T. F. Smith. These two photo-micrographs demonstrate the existence of at least two layers in the angulatum.

Fig. 3. *Coscinodiscus asteromphalus*, $\times 110$ diams., with an apochromatic 1-inch ·3 N.A.

Fig. 4. A portion of the preceding, $\times 2000$ diams., to show the lacework inside the areolations. This lacework is believed to be a perforated structure, as a fracture passes through the markings. In the central areolation there are forty-six smaller perforations surrounded by a crown of fifteen larger ones.¹ Photographed with an apochromatic $\frac{1}{8}$ 1·4 N.A.

Fig. 5. *Aulacodiscus Kittonii*, $\times 270$, by an apochromatic 1-inch ·3 N.A.

Fig. 6. A small portion in the centre of an *Aulacodiscus Sturtii*, $\times 2000$, by an apochromatic $\frac{1}{8}$ 1·4 N.A. Broadly speaking, the difference between the *Coscinodisci* and the *Aulacodisci* lies in the fact that in the former the secondary structure is inside the primary, while in the latter it is exterior to it. This definition, however, is not strictly accurate, as it is believed that the fine perforated structure covers the entire valve, it being only optically hidden by the primary structure.

The whole of these demonstrations were photographed for the present Editor by his friend E. M. Nelson, Esq., and have been reproduced from the negatives by a process of photo printing.

PLATE II. (Facing p. 274)

ARRANGEMENT OF THE MICROSCOPE WITH A STAND FOR THE MICROMETER EYE-PIECE, TO SECURE STEADINESS AND ACCURACY IN MEASUREMENT

PLATE III. (Facing p. 286)

ARRANGEMENT OF THE MICROSCOPE AND ACCESSORIES FOR THE EMPLOYMENT OF THE CAMERA LUCIDA

PLATE IV. (Facing p. 334)

THE METHOD OF USING THE SILVER SIDE REFLECTOR OR PARABOLOID

PLATE V. (Facing p. 410)

METHOD OF USING DIRECT TRANSMITTED LIGHT WITHOUT THE EMPLOYMENT OF THE MIRROR

PLATES II. to V. are engraved from photographs, taken at the request of the Editor by Mr. E. M. Nelson, from the arranged instruments.

¹ A section of this diatom will be found in the *Transactions of the County of Middlesex Natural History Society* for 1889, Plate I, fig. 2.

PLATE VI. (Facing p. 550)

SEXUAL GENERATION OF VOLVOX GLOBATOR. (After Cohn)

Fig. 1. Sphere of *Volvox globator* at the epoch of sexual generation: *a*, sperm-cell containing cluster of antherozoids; *a*², sperm-cell showing side-view of discoidal cluster of antherozoids; *a*³, sperm cell whose cluster has broken up into its component antherozoids; *a*⁴, sperm-cell partly emptied by the escape of its antherozoids; *b*, flask-shaped germ-cells showing great increase in size without subdivision; *b*², *b*³, germ-cells with large vacuoles in their interior; *b*⁴, germ-cell whose shape has changed to the globular.

Fig. 2. Sexual cell, *a*, distinguishable from sterile cells, *b*, by its larger size.

Fig. 3. Germ-cell, with antherozoids swarming over its endochrome.

Fig. 4. Fertilised germ-cell, or oosphere, with dense envelope.

Fig. 5. Sperm-cell, with its contained cluster of antherozoids, more enlarged.

Figs. 6, 7. Liberated antherozoids, with their flagella.

PLATE VII. (Facing p. 553)

OSCILLARIACEÆ AND SCYTONEMACEÆ

Fig. 1. *Lyngbya estuarii*, Lieb. × 160.

Fig. 2. *Spirulina Jenneri*, Ktz. × 400.

Fig. 3. *Tolypothrix cirrhosa*, Carm. × 400.

Fig. 4. *Oscillaria insignis*, Thw. × 400.

Fig. 5. *O. Frolichii*, Ktz. × 400.

Fig. 6. *O. tenerrima*, Ktz. × 400.

These figures are after Cooke.

PLATE VIII. (Facing p. 554)

DESMIDIACEÆ, RIVULARIACEÆ, AND SCYTONEMACEÆ

Fig. 1. Zygospore of *Micrasterias denticulata*, Bréb. (After Ralfs.)

Fig. 2. *Cosmarium Brebissonii*, Men. (After Cooke.)

Fig. 3. *Euastrum pectinatum*, Bréb. (After Ralfs.)

Fig. 4. Zygospore of *Staurastrum hirsutum*, Bréb. (After Ralfs.)

Fig. 5. *S. gracile*, Ralfs. (After Cooke.)

Fig. 6. *Xanthidium aculeatum*, Ehrb. (After Ralfs.)

Fig. 7. *Rivularia dura*, Ktz. (After Cooke.)

Fig. 8. *R. dura*, Ktz. × 400. (After Cooke.)

Fig. 9. *Scytonema natans*, Bréb. × 400. (After Cooke.)

Fig. 10. *Staurastrum hirsutum*, Bréb. (After Cooke.)

PLATE IX. (Facing p. 580)

DESMIDIACEÆ

Fig. 1. *Micrasterias crux-melitensis*, Ehrb. (After Cooke.)

Fig. 2. *Closterium setaceum*, Ehrb. (After Cooke.)

Fig. 3. *Desmidiium Swartzii*, Ag. (After Cooke.)

Fig. 4. *Penium digitus*, Ehrb. (After Cooke.)

Fig. 5. *P. digitus*, Ehrb. (transverse view).

Fig. 6. *Spirotonia condensata*, Bréb. (After Cooke.)

Fig. 7. *Docidium baculum*, Bréb. (After Cooke.)

Fig. 8. *Gonatozygon Brebissonii*, De Bary, conjugating. (After Cooke.)

PLATE X. (Facing p. 593)

PLEUROSIGMA ANGULATUM

This is a direct photo-micrograph, taken by Dr. R. Zeiss, as magnified 4900 diameters. We direct attention specially to it as giving evidence of the presence (however originated) of the intercostal markings, which may be seen with considerable clearness on the right-hand side of the midrib and in the middle of the valve.

PLATE XI. (Facing p. 594)

This plate has a twofold purpose. It is designed, first, to justify the opinions held by Dr. Henry van Heurck upon the structure of the valves of diatoms, and also to show how the usual microscopical tests present themselves when examined with the new objective with N.A. 1.60, lately constructed by the firm of Zeiss. This objective is believed by Dr. van Heurck to realise what he considers the highest results of photographic optics, which in his judgment could only be surpassed by finding a new immersion liquid of still higher refractive index presenting all the necessary qualities, and which at the same time would not affect the very delicate flint of which it is necessary to make the front lens of this objective. This medium he hopes may be some day realised. Unfortunately, up to this time, no indication permits us to foresee the discovery of the liquid desired.

The following is the way in which Dr. Henry van Heurck summarises his ideas upon the structure of the valve:—

1. The valve of diatoms¹ is formed by two membranes or thin plates and by an intermediate septum. By this he understands a plate pierced with openings. The superior membrane, often very delicate, may be destroyed in the treatment by acids in the washings, by rubbing, &c. It is possible also that it sometimes only exists in a very rudimentary state. The majority of the students of diatoms agree in believing that these membranes may be sufficiently permeable to permit of exchange by endosmose between the contents of the valve and the surrounding outer water, but that these membranes have no real openings so long as the diatom is living and intact.

2. When the openings of the septum are disposed in alternate rows, then they take an hexagonal form. When in perpendicular rows then the openings are square or elongated. The hexagonal form, which is besides so frequent in nature, seems to be the typical form of the openings of the septum, and it is found most frequently when the valve is large, destitute of consolidated sides, and must offer resistance to outside agents. Even in the forms of the square openings we see very frequently deviations and returns to the hexagonal type upon certain parts of the valve. It is possible that the septa may be sometimes composed of many layers, placed one above another, formed successively and closely united; but up to this time we have no proof of it, neither have we met with any form presenting layers placed one above another.

Such, in brief, is the view held by Dr. van Heurck as an interpretation of our present knowledge of the structure of the valve of the diatoms. We give now a description of the objects represented on the plate.

Figs. 1, 2, 3. *Amphipleura pellucida*, Kütz. 1 and 2, valve resolved into pearls. Fig. 2 $\times 2000$ diams. Fig. 1 $\times 3000$ diams. Fig. 3. Valve resolved in striae at about 2300 diams.

Fig. 4. *Amphipleura Lindheimeri*, Gr., $\times 2500$ diams.

Fig. 5. *Pleurosigma angulatum*, in hexagons, \times (about) 10,000 diams.

Fig. 6. *Idem* $\times 2000$ diams., illusory pearls which are formed by the angles of the hexagonal cells when the focussing is not perfect.

Fig. 7. The nineteenth band of Nobe's test plate. This photo-micrograph has been made exceptionally with the apochromatic $\frac{1}{12}$ of 1.4 N.A. The lines being traced upon a cover in crown-glass, the objective of N.A. 1.6 cannot be used here.

Fig. 8. *Sarirella gemma*, Ehrb. \times (about) 1000 diams.

Fig. 9. *Van Heurckia crassinervis*, Bréb. (*Frustulia saxonica*, Rabh) $\times 2000$ diams.

All the photo-micrographs (except fig. 7) have been done with the new $\frac{1}{10}$ -inch N.A. 1.60 of MM. Zeiss.

These micro-photographs have been produced by sunlight in a monochromatic form, the special compensating eye-piece 12, and the Abbe condenser of N.A. 1.6.

¹ 'The Structure of the Valve of Diatoms' in *Records of the Belgian Society*, v. xiii. 1890.

Covers and slides in flint of 1.72; diatoms in a medium 2.4.

We are bound, however, to note that the condenser used is not corrected in any way; its aberrations are enormous. Although the highest admiration must be expressed for the skill exercised by Dr. van Heurck in these remarkable photo-micrographs, and the highest esteem for his courtesy to the present Editor in supplying them, it must not be forgotten that Dr. van Heurck was obliged to employ an imperfect condenser—a condenser absolutely uncorrected—and although we can testify to the high quality and fine corrections of at least one of the lenses of N.A. 1.6, we are convinced that much of its real perfection in image-forming is destroyed by uncorrected sub-stage illumination. Upon the corrections and large aplanatic area presented by the condenser and its careful and efficient employment depends entirely the nature of the image presented by the finest objective ever constructed; and as the perfection of the objective, with a high amplification and a great aperture, is more nearly approached, the more dependent are we upon perfect corrections in the condenser to bring out the perfect image-forming power of the objective. No image formed by such an objective as that possessing N.A. 1.60 can be considered reliable until a condenser corrected for all aberrations like the objective itself is produced; and so convinced are we of the possible value of this objective that we trust its distinguished deviser and maker may be soon induced to produce the condenser referred to.

If, then, by the aid of the chemist we can discover media which will be of sufficiently high refractive index, and still tolerant or non-injurious to organic tissues immersed in it, a new line of investigation may be open to histology and pathology.—W. H. D.

PLATE XII. (Facing p. 597)

ARACHNOIDISCUS JAPONICUS. (After R. Beck)

The specimens attached to the surface of a seaweed are represented as seen under a $\frac{1}{4}$ th objective, with Lieberkühn illumination: A, internal surface; B, external surface; C, front view, showing incipient subdivision.

PLATE XIII. (Facing p. 651)

BACTERIA, SCHIZOMYCETES, OR FISSION FUNGI

1. Cocci singly and varying in size. 2. Cocci in chains or rosaries (streptococcus). 3. Cocci in a mass (staphylococcus). 4 and 5. Cocci in pairs (diplococcus). 6. Cocci in groups of four (merismopedia). 7. Cocci in packets (sarcina). 8. *Bacterium termo*. 9. *Bacterium termo* \times 4000 (Dallinger and Drysdale). 10. *Bacterium septicæmiæ hæmorrhagicæ*. 11. *Bacterium pneumoniae crouposæ*. 12. *Bacillus subtilis*. 13. *Bacillus murisepticus*. 14. *Bacillus diphtheriæ*. 15. *Bacillus typhicus* (Eberth). 16. *Spirillum undula* (Cohn). 17. *Spirillum volutans* (Cohn). 18. *Spirillum cholerae Asiaticæ*. 19. *Spirillum Obermeieri* (Koch). 20. *Spirochæta plicatilis* (Flügge). 21. *Vibrio rugula* (Prazanowski). 22. *Cladothrix Försteri* (Cohn). 23. *Cladothrix dichotoma* (Cohn). 24. *Monas Okenii* (Cohn). 25. *Monas Warmingii* (Cohn). 26. *Rhabdomonas rosea* (Cohn). 27. Spore-formation (*Bacillus alvei*). 28. Spore-formation (*Bacillus anthracis*). 29. Spore-formation in bacilli cultivated from a rotten melon (Fränkel and Pfeiffer). 30. Spore-formation in bacilli cultivated from earth (Fränkel and Pfeiffer). 31. Involution-form of *Crenothrix* (Zopf). 32. Involution-forms of *Vibrio serpens* (Warming). 33. Involution-forms of *Vibrio rugula* (Warming). 34. Involution-forms of *Clostridium polymyxa* (after Prazanowski). 35. Involution-forms of *Spirillum cholerae Asiaticæ*. 36. Involution-forms of *Bacterium aceti* (Zopf and Hansen). 37. Spirulina-form of *Beggiatoa alba* (Zopf). 38. Various thread-forms of *Bacterium merismopedioides* (Zopf). 39. False-branching of *Cladothrix* (Zopf).

PLATE XIV. (Facing p. 664)

PURE-CULTIVATIONS OF BACTERIA

Fig. 1. *In the depth of Nutrient Gelatine.* A pure-cultivation of Koch's comma-bacillus (*Spirillum cholerae Asiaticæ*) showing in the track of the needle a funnel-shaped area of liquefaction enclosing an air-bubble, and a white thread. Similar appearances are produced in cultivations of the comma-bacillus of Metchnikoff.

Fig. 2. *On the surface of Nutrient Gelatine.* A pure-cultivation of *Bacillus typhosus* on the surface of obliquely solidified nutrient gelatine.

Fig. 3. *On the surface of Nutrient Agar-agar.* Pure-cultivation of *Bacillus indicus* on the surface of obliquely solidified nutrient agar-agar. The growth has the colour of red sealing-wax, and a peculiar crinkled appearance. After some days it loses its bright colour and becomes purplish, like an old cultivation of *Micrococcus prodigiosus*.

Fig. 4. *On the surface of Nutrient Agar-agar.* A pure-cultivation obtained from an abscess (*Staphylococcus pyogenes aureus*).

Fig. 5. *On the surface of Nutrient Agar-agar.* A pure-cultivation obtained from green pus (*Bacillus pyocyaneus*). The growth forms a whitish, transparent layer, composed of slender bacilli, and the green pigment is diffused throughout the nutrient jelly. The growth appears green by transmitted light, owing to the colour of the jelly behind it.

Fig. 6. *On the surface of Potato.* A pure-cultivation of the bacillus of glanders on the surface of sterilised potato.

PLATE XV. (Facing p. 756)

COMPLETE LIFE-HISTORIES OF TWO SAPROPHYTES

(Drawn from nature by Dr. Dallinger)

PLATE XVI. (Facing p. 763)

The various stages of the development of the nucleus in two saprophytic organisms, as studied with recent homogeneous and apochromatic objectives both in the several stages of fission and genetic fusion, indicating *karyokinesis*, and proving, as established in detail by the text, that all the steps in the cyclic changes of these unicellular forms are initiated in the nucleus before being participated in by the whole body of the organism. (Drawn from nature by Dr. Dallinger.)

PLATE XVII. (Facing p. 792)

ROTIFERA

Fig. 1. *Floscularia campanulata*.

Fig. 2. *Stephanoceros Eichhornii*

Fig. 3. *Melicerta ringens*.

Fig. 4. *Pedalion mirum* (side view).

Fig. 5. *P. mirum* (dorsal view, showing muscles).

Fig. 6. *Copeus cerberus* (side view).

Fig. 7. *Philodina aculeatu* (side view, corona expanded).

Fig. 8. Male of *Pedalion mirum*.

All these figures, save fig. 2, are reduced to scale from the beautiful plates in Hudson and Goss's *Rotifera*.

PLATE XVIII. (Facing p. 797)

FORAMINIFERA

Fig. 1. *Miliolina seminulum* (a and b, lateral aspects).

Fig. 2. *Alveolina Boscii* (a, lateral aspect; b, longitudinal section).

Fig. 3. *Astrorhiza limicola* (*a*, lateral aspect; *b*, portion of the test more highly magnified, showing structure).

Fig. 4. *Haliphysena Tumanoviczii*, showing the pseudo-polythalamous foot.

Fig. 5. *Ibid.* (group of specimens *in situ*).

Fig. 6. *Haplophragminum agglutinans* (*a*, lateral aspect; *b*, longitudinal section).

Fig. 7. *H. nanum* (*a*, superior aspect; *b*, peripheral aspect).

Fig. 8. *Textularia gramen* (*a*, lateral aspect; *b*, oral aspect).

Fig. 9. *T. gramen* (peripheral aspect).

Fig. 9*a*. *Pavonina flabelliformis* (*a*, lateral aspect; *b*, oral aspect).

Fig. 10. *Bulminia spinulosa*.

Fig. 11. *Chilostomella ovoidea* (*a* and *b*, lateral aspects; *c*, specimen mounted in Canada balsam and seen with transmitted light).

PLATE XIX. (Facing p. 799)

FORAMINIFERA

Fig. 12. *Lagena sulcata*.

Fig. 13. *L. sulcata*.

Fig. 14. *L. sulcata*.

Fig. 15. *L. sulcata* (*a*, lateral aspect; *b*, oral aspect).

Fig. 16. *Nodosaria raphanus*.

Fig. 17. *Cristellaria calcar* (*a*, *b*, *c*, lateral aspects).

Fig. 18. *Ramulina globulifera*.

Fig. 19. *R. globulifera*.

Fig. 20. *Globigerina bulloides* (var. *triloba*, pelagic specimen).

Fig. 21. *G. bulloides* (*a*, *b*, *c*, adult typical shell).

Fig. 22. *Rotalia Beccarii*.

Fig. 23. *Polystomella craticulata*.

Fig. 24. *Amphistegina Lessonii* (*a*, superior lateral aspect; *b*, inferior lateral aspect; *c*, peripheral aspect).

Fig. 25. *Nummulites levigata* (*b*, lateral aspect; *c*, vertical section).

Fig. 26. Portion of *Orbitoides nummulitica*.

PLATES XX, XXI, XXII

ACARINA

All the figures, except fig. 4, Plate XXII, are copied from plates drawn by Mr. A. D. Michael, F.L.S., &c. by the kind permission of the respective societies that published them. Figs. 1 to 6, Plate XX., and 1 to 3, Plate XXI., are from 'British Oribatida,' published by the Ray Society; fig. 7, Plate XX., from the 'Journal of the Linnean Society;' fig. 4, Plate XXI., and fig. 3, Plate XXII., from the 'Journal of the Royal Microscopical Society;' fig. 5, Plate XXI., and figs. 1 and 2, Plate XXII., from the 'Journal of the Quekett Microscopical Club.' Fig. 4, Plate XXII., is drawn after Fürstenberg by the Editor.

PLATE XX. (Facing p. 1008)

ORIBATIDÆ

Fig. 1. Anatomy of *Nothrus theleproctus* (male, dorsal aspect, \times about 60). The dorsal portion of the chitinous exo-skeleton, and the fat and muscles which underlie it, have been removed from the abdomen. The internal organs are shown protruding, as they usually do when the creature is opened, as though they were too large to be contained in the ventral exo-skeleton. Part of the œsophagus is seen at the top (the brain having been removed). The preventricular glands (brown) lie on each side of the œsophagus. The ventriculus is coloured pink; part of it and the whole of the cæca are covered with

botryoidal tissue (yellow). The testes (white shaded with blue) show at the sides protruding from beneath the alimentary canal.

Fig. 2. *Hoplophora magna* (female, lateral aspect, \times about 50). The chitin at the side and the fatty tissue and muscles have been removed. Alimentary canal pink; cæca of the ventriculus spotted; pre-ventricular glands brown; supercoxal gland white; its vesicles yellow; expulsory vesicle, between supercoxal and ovaries, grey; ovary and oviducts white shaded with blue and yellow. The genital and anal plates are open, and the genital suckers protruding. One maxilla, white, is seen between the legs.

Fig. 3. *Tegeocranus latus* (female, dorsal aspect, \times about 55). Dorsal exo-skeleton, fatty tissue, and muscles removed. Same colours as before. Brain (between pre-ventricular glands) blue grey. Mandibles seen from above and behind, their retractor muscles cut short. The tracheæ, which are present in this species, are seen proceeding to their stigmata in the acetabula of the legs.

Fig. 4. Female genital organs of *Cepheus tegeocranus* (\times about 25), Vigt. Central Ovary, oviducts with eggs, vagina, and ovipositor.

Fig. 5. The same of *Damæus geniculatus* (\times about 20). The genital plates and the muscles and tendons which move them, and the genital suckers, are shown.

These two figures are reduced from the originals.

Fig. 6. Nymph (active pupal stage) of *Tegeocranus hericius* (\times about 100) (carrying its cast dorsal skins).

TYROGLYPHIDÆ

Fig. 7. Hypopial (travelling) nymph of *Rhizoglyphus Robini* (ventral aspect, \times 100).

PLATE XXI. (Facing p. 1010)

ORIBATHIDÆ

Fig. 1. *Lciosoma palmicinctum* (\times about 40).

Fig. 2. Nymph of same species, fully grown (\times about 55). The central ellipse with the innermost set of scales attached is the cast larval dorsal abdominal skin. The other rows of scales belong to the successive nymphal skins.

Fig. 3. One of the scales more highly magnified.

CHEYLETIDÆ

Fig. 4. Rostrum and great raptorial palpi, with their appendages of *Cheyletus venustissimus* (\times about 150).

MYOBIIDÆ

Fig. 5. *Myobia chiropteralis* (female, \times about 125).

PLATE XXII. (Facing p. 1012)

Claw of first leg of same species, being an organ for holding the hair of the bat.

GAMASIDÆ

Fig. 2. *Gamasus terribilis* (male, \times 30). A species found in moles' nests.

ANALGIDÆ

Fig. 3. *Freyana heteropus* (male, \times about 95, a parasite of the cormorant).

Fig. 4. *Sarcoptes scabiei* (the itch mite, \times about 150, adult female).

THE MICROSCOPE

CHAPTER I

ELEMENTARY PRINCIPLES OF MICROSCOPICAL OPTICS

To be the owner of a well-chosen and admirably equipped *microscope*, and even to have learnt the general purpose and relations of its parts and appliances, is by no means to be a master of the instrument, or to be able to employ it to the full point of its efficiency even with moderate magnifying powers. It is an instrument of precision, and both on its mechanical and optical sides requires an intelligent understanding of *principles* before the best optical results can be invariably obtained.

We may be in a position, with equal facility, to buy a high-class microscope and a high-class harp; but the mere possession makes us no more a master of the instrument in the one case than the other. An intelligent understanding and experimental training are needful to enable the owner to use either instrument. In the case of the microscope, for the great majority of purposes to which it is applied in science, the amount of study and experimental training needed is by comparison incomparably less than in the case of the musical instrument. But the amount required is absolutely essential, the neglect of it being the constant cause of loss of early enthusiasm and not infrequent total failure.

In the following pages we propose to treat the elementary principles of the optics of the microscope in a practical manner, not merely laying down dogmatic statements, but endeavouring to show the student how to demonstrate and comprehend the application of each general principle. But in doing this we are bound to remember a large section of the readers who will employ this treatise, and to so treat the subject that all the examples given, or that may be subsequently required by the ordinary microscopist, may be worked out with no heavier demand upon mathematics than the employment of vulgar fractions and decimals.

In like manner, although we shall again and again employ the trigonometrical expression 'sine,' its use will not involve a mathematical knowledge of its meaning. The sines of angles may be

found by published tables. A table to quarter degrees is given in Appendix A of this book, which will, in the majority of cases, suffice; it is not difficult to find such tables as may be required.¹

Of course it is more than desirable that the microscopist should have good mathematical knowledge; but there are many men who desire to obtain a useful knowledge of the principles of elementary optics who are without time or inclination, or both, to obtain the large mathematical knowledge required.

Now, just as a man who is without any accurate knowledge of astronomy or mathematics may find *time* from a sun-dial by applying the equation of time taken from a table in an almanac, so by the use of a table of sines the microscopist may reach useful and reliable results, although he may have no clear knowledge of trigonometry, physical optics, nor the mathematical proof of formulæ.

All microscopes, whether *simple* or *compound*, in ordinary use depend for their magnifying power upon the ability possessed by lenses to *refract* or bend the light which passes through them. Refraction acts in accordance with the two following laws, viz. :—

1. A ray which in passing from a rare medium into a denser medium makes a certain angle with the *normal*, i.e. *the perpendicular* to the surface or plane at which the two media join, will, on entering the denser medium, make a *smaller angle with the normal*. Conversely, a ray passing out from a dense medium into a rarer one, making a certain angle with the normal, will, on emergence from the dense medium, make a greater angle with the normal.

The ray in one medium is called the *incident ray*, and in the other medium the *refracted ray*.

The incident and refracted rays are always in the same plane.

2. The sine of the angle of incidence divided by the sine of the angle of refraction is a constant quantity for any two particular media.

When one of the media is air (accurately a vacuum) the ratio of these sines is called the absolute refractive index of the medium. As every known medium is denser than a vacuum, it follows that the angle of the refracted ray in that medium will be less than the angle of the incident ray in a vacuum; consequently, the absolute refractive index of any medium is greater than unity.

Further, the absolute refractive index for any particular substance will differ according to the colour of the ray of light employed. The refraction is least for the red, and greatest for the violet. The difference between these refractive values determines what is called the *dispersive power* of the substance.

This will be understood by fig. 1. Let I C, a ray of light travelling in air, meet the surface A B of water at the point C. Through C draw N N' at right angles to the surface of the water A B. The line N N' is called the *normal* to the surface A B. The ray I C will not continue its path through the water in a straight line to Q; but, because water is denser than air, it will be bent to R, that is towards N'. The whole course of the ray will be I C R, of which the part I C is called the *incident ray*, and C R the *refracted ray*.

¹ Vide Chambers's *Mathematical Tables*.

The angle ICN makes with the normal NN' , viz. ICN , is called the *angle of incidence*: and the angle RCN' makes with the normal NN' , viz. RCN' , is called the *angle of refraction*.

Conversely, if a ray RC , travelling in water, meet the surface of air AB in the point C , it will not continue in a straight line, but will be bent to the point I farther away from N . Thus, when a ray passes from a rarer to a denser medium it is bent or refracted *towards* the normal, and when it passes out of a dense medium into a rarer one it is bent or refracted *away* from the normal.

Further, if the shaded portion of the figure were glass instead of water, the refracted ray RC would be bent still nearer N' , and, conversely, if the ray passed out of glass into air, it would be more

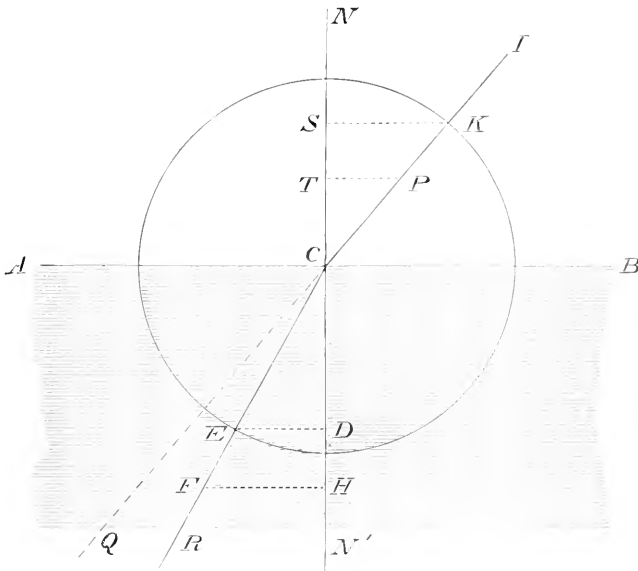

FIG. 1.—The refraction of light. The law of sines.

bent away from the normal than if it had passed out of water into air.

The angle of incidence ICN is connected with the angle of refraction RCN' (as stated above) by what is known as Snell's Law of Sines. The constant relation between the two sines for two specific media is called the *refractive index* of the medium, and is usually indicated in problems by the symbol μ .

This law, stated with reference to the figure, would be:

$$\frac{\text{sine } ICN}{\text{sine } RCN'} = \mu = \text{the refractive index of water.}$$

In IC take any point, P , and from P draw PT perpendicular to NN' . Similarly in RC take any point, F , and draw FH perpendicular to NN' .

Now, as $\text{sine } ICN = \frac{PT}{PC}$, and $\text{sine } RCN' = \frac{FH}{FC}$, then, by

$$\text{Snell's law, } \frac{\frac{PT}{PC}}{\frac{FH}{FC}} = \mu.$$

As any points may be taken in IC and RC if the points had been more judiciously selected, we might have greatly simplified the above expression. Thus, if we take two other points, K and E , such that $KC = EC$, and draw the perpendiculars as before, we shall have

$$\text{sine } ICN = \frac{KS}{KC} \text{ and sine } RCN' = \frac{ED}{EC}, \text{ and therefore } \frac{\frac{KS}{KC}}{\frac{ED}{EC}} = \mu.$$

But as $KC = EC$ by construction, we can write KC for EC

$$\text{thus: } \frac{\frac{KS}{EC}}{\frac{ED}{EC}} = \mu. \quad KC \text{ is cancelled, which leaves } \frac{KS}{ED} = \mu$$

As μ can be experimentally determined for any two particular media, it follows that if one of the other terms is known, then the remaining term can be found. Thus, if μ and the angle of incidence are known, the angle of refraction can be found; and if μ and the angle of refraction are known, the angle of incidence can be found. The unknown quantity can be found either geometrically or by calculation when the other two terms are given.

It will, of course, be understood that, for the same medium in every case, a red ray would be bent or refracted less than a violet ray. The value therefore of μ for a red ray will be less than that of μ' for a violet ray. As a practical illustration: The refractive index for a red ray in crown glass is $1.5124 = \mu$, and for a violet ray is $1.5288 = \mu'$, the difference being $\mu' - \mu = .0164$.

The refractive index for a red ray in dense flint glass is $1.7030 = \mu$, and for a violet ray is $1.7501 = \mu'$, the difference being $\mu' - \mu = .0471$.

Consequently there will be a greater difference between the bending of the refracted red and violet rays in the case of dense flint than in the case of crown glass, the angle of the incident ray with the normal being the same in either case.

Where air (more correctly a vacuum) is not one of the media, then the refractive index is called the *relative* refractive index.

The *normal to a plane surface* is always the perpendicular to it; the *normal to a spherical surface* is the radius of curvature. The angle of the incident ray and the angle of the refracted ray are always measured *with the normal*, and not with the surface.

Fig. 2 *a, b*, shows the *normals* A, B to both a plane and a spherical surface, CD .

In the case of the spherical surface, B is the centre of curvature, $E F$

is the incident ray in air, FG the refracted ray in crown glass. The angle $A F E$ is the angle of incidence, $B F G$ the angle of refraction.

Sine $A F E$ divided by sine $B F G$ is equal to the refractive index of air into crown glass, or, in other words, the absolute refractive index of crown glass, μ ; thus in this particular case :

(Problem) I. :

$$\frac{\sin A F E}{\sin B F G} = \frac{\sin 45^\circ}{\sin 28^\circ} = \frac{.707}{.472} = \frac{3}{2} = \mu.$$

This problem, however, is not actually needed by the reader of this book, for a table of absolute refractive indices is given in Appendix B.

It will be clear from the above that when the refractive index, absolute or relative, of a ray from any first medium is given, the refractive index from the second to the first may be found.

Thus, the absolute refractive index μ from air into glass being given as $\frac{3}{2}$, find μ' , the refractive index from glass into air.

(Problem) II. :

$$\mu' = \frac{1}{\mu} = \frac{1}{\frac{3}{2}} = \frac{2}{3}.$$

When the absolute refractive indices of any two media are given, the relative refractive indices between the media can be found.

Thus, the absolute refractive index μ of crown glass is 1.5, and the absolute refractive index μ' of flint glass is 1.6; find the relative refractive index μ'' from crown to flint.

(Problem) III. :
$$\mu'' = \frac{\mu'}{\mu} = \frac{1.6}{1.5} = 1.066.$$

The relative refractive index μ''' from flint to crown is determined by (problem) ii. :

$$\mu''' = \frac{1}{\mu''} = \frac{1}{1.066} = .938.$$

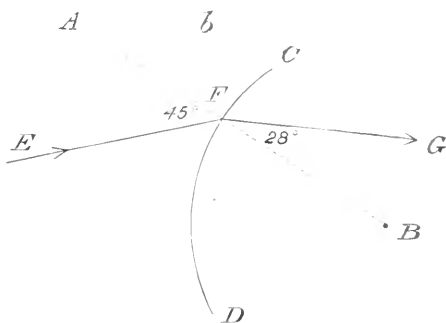
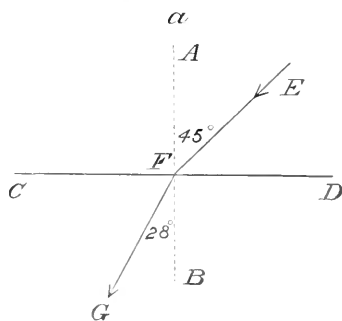

FIG. 2.—The normals to a plane and a curved surface.

Let us now suppose that in fig. 2 the ray is travelling in the opposite direction, $G F$ in the denser medium will now be the incident ray, and $F E$ in the rarer medium will be the refracted ray. Now, if the angle $B F G$ be increased, the angle $A F E$ will also be in-

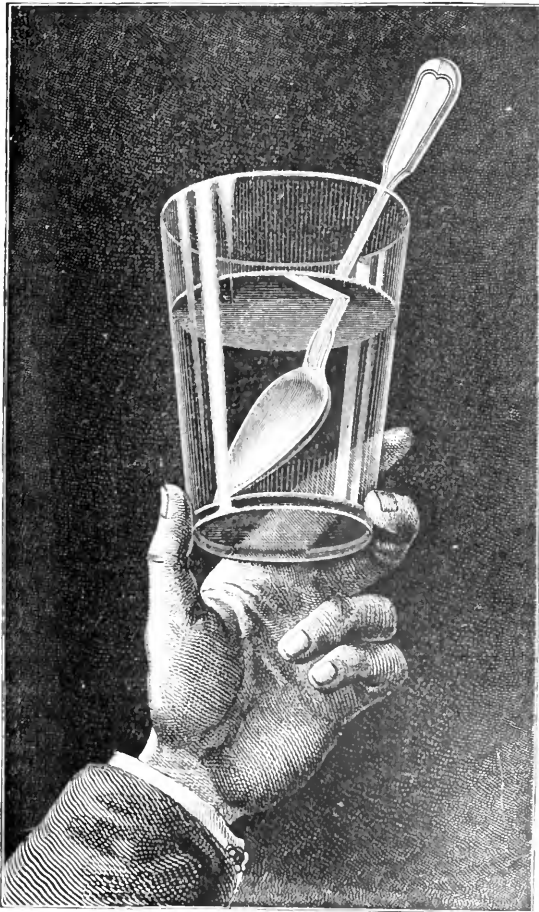

FIG. 3. — The phenomenon of total reflexion. (From the 'Forces of Nature,' published by Macmillan.)

creased in a greater proportion, and the ray $F E$ will approach the surface $F D$.

When $F E$ coincides with $F D$, $G F$ is said to be incident at the *critical angle* of the medium. When this critical angle is reached, none of the incident light will pass out of the denser medium, but it

will be totally reflected from the surface C D back into the denser medium.

A simple illustration of this is shown in fig. 3. It represents a glass of water so held that the surface of the water is above the eye. If we look obliquely from below at this surface, it appears brighter than polished silver, and an object placed in the water has the upper portion of it brightly reflected.

The action on all light incident on C D in the denser medium (fig. 2) at an angle greater than the critical angle is precisely the same in fact as if C D were a silvered mirror.

A critical angle can only exist in a denser medium, for obviously there can be no critical angle in the rarer medium, since a ray of any angle of incidence can enter.

When the relative or absolute refractive index of the denser medium is given, the critical angle for that medium can be found, thus: The absolute refractive index of water is $1.33 = \mu$; find its critical angle θ .

$$\begin{aligned} \text{(Problem) IV. : } \quad \sin \theta &= \frac{1}{\mu} = \frac{1}{1.33} = .75; \\ \theta &= 48\frac{1}{2}^\circ \text{ (found by table).} \end{aligned}$$

So the sine of the critical angle is the reciprocal of the refractive index.

The connection between the path of an incident ray in a first medium and its refracted ray in a second medium is established by the formula

$$\mu \sin \phi = \mu' \sin \phi',$$

where μ is the absolute refractive index of the first medium, ϕ the angle of the incident ray in it, μ' the absolute refractive index of the second medium, and ϕ' the angle of the refracted ray in it.

The angle $\phi = 45^\circ$ of the incident ray in the first medium A F E (fig. 2) and $\mu = 1$, $\mu' = \frac{3}{2}$, the absolute refractive indices of both the media, air and glass respectively, being given, find ϕ' , the angle of the refracted ray in glass.

(Problem) V. 1 :

$$\begin{aligned} \sin \phi' &= \frac{\mu \sin \phi}{\mu'} = 1 \times \frac{\sin 45}{1.5} = \frac{1 \times .707}{1.5} = .471; \\ \phi' &= 28^\circ \text{ (found by table).} \end{aligned}$$

To put another case. Suppose the angle $\phi' = 28^\circ$ (fig. 2, B F G) is given; find ϕ , the refractive indices remaining the same as before.

(Problem) V. 2 :

$$\begin{aligned} \sin \phi &= \frac{\mu' \sin \phi'}{\mu} = \frac{1.5 \times \sin 28^\circ}{1} = \frac{1.5 \times .471}{1} = .7065, \\ \phi &= 45^\circ \text{ (found by table).} \end{aligned}$$

Now, suppose the A side of C D (fig. 2) is crown glass, $\mu = 1.5$, and the B side of C D is flint glass, $\mu' = 1.6$. The angle of the incident ray A F E $\phi = 45^\circ$, find the angle of the refracted ray ϕ' or B F G.

(Problem) V. 3 :

$$\sin \phi' = \frac{\mu \sin \phi}{\mu'} = \frac{1.5 \times \sin 45}{1.6} = \frac{1.5 \times .707}{1.6} = \frac{1.0605}{1.6} = .663 ;$$

$$\phi' = 41\frac{1}{2}^\circ \text{ (found by table).}$$

As a final instance. Suppose the ray to be travelling in the opposite direction, so that G F is the incident ray and B F G, or $\phi' = 41\frac{1}{2}^\circ$, be given, the media being the same as in the last case, $\mu' = 1.6$ and $\mu = 1.5$, find ϕ , or the angle of the refracted ray.

(Problem) V. 4 :

$$\sin \phi = \frac{\mu' \sin \phi'}{\mu} = \frac{1.6 \sin 41\frac{1}{2}^\circ}{1.5} = \frac{1.6 \times .663}{1.5} = \frac{1.0608}{1.5} = .707 ;$$

$$\phi = 45^\circ \text{ (found by table).}$$

The importance of the prism in practical optics is well known. Its geometrical form in perspective and in section is shown in fig. 4.

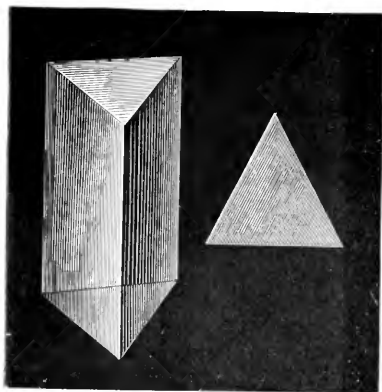

FIG. 4.—The geometrical form of the prism.
(From the 'Forces of Nature'.)

By means of the above problems and their solutions we are now able to trace the divergence of a ray through a prism.

In fig. 5 let A B C represent a prism of very dense flint glass whose absolute refractive indices μ' for red light is 1.7, and μ'' for blue light is 1.75. Let the refracting angle B A C of the prism $= 50^\circ$, and let the angle of incidence of a ray of white light D E $= 45^\circ = \phi$ in air. $\mu = 1$. The dotted lines show the normals. Then by (problem) v. 1 for red light we have for the angle of refraction ϕ' .

$$\sin \phi' = \frac{\mu \sin \phi}{\mu'} = \frac{1 \sin 45^\circ}{1.7} = \frac{.707}{1.7} = .416 ;$$

$$\phi' = 24\frac{1}{2}^\circ \text{ (found by table).}$$

And for blue light :

$$\sin \phi'' = \frac{\mu \sin \phi}{\mu''} = \frac{1 \sin 45^\circ}{1.75} = \frac{.707}{1.75} = .404 ;$$

$$\phi'' = 23\frac{3}{4}^\circ \text{ (found by table).}$$

Now, for the red ray draw E F (fig. 5), $24\frac{1}{2}^\circ$ to the normal, and let it meet the other side of the prism A C in F. At F draw another normal.

On the scale of our diagram it is not possible to draw two lines E F, one for the red ray and the other for the blue, for they are too close together, their angular divergence being only $\frac{3}{4}^\circ$. But by

measurement it will be found that $E F$ makes, with the normal at F , an angle ϕ' of $25\frac{1}{2}^\circ$, and for the blue ray an angle ϕ'' of $26\frac{1}{4}^\circ$.

It should be remembered, however, that if the refracting angle of the prism is known, there is no necessity for this measurement, because it is always the difference between this and the angle of refraction before determined, thus $50^\circ - 24\frac{1}{2}^\circ = 25\frac{1}{2}^\circ$.

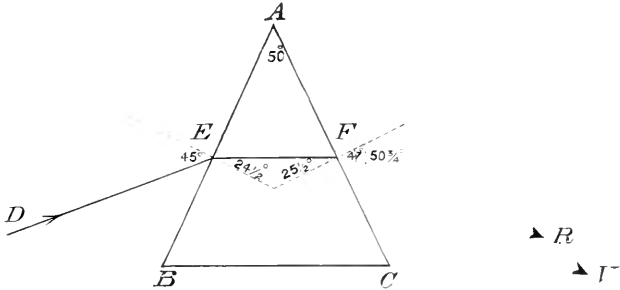

FIG. 5.—Diagram of deviation of luminous ray by a prism.

This ray $E F$ now becomes the incident ray on the surface $A C$; and as the angle it makes with the normal at F is known, and as the refractive indices remain the same, we can, by (problem) v. 2, find the angles of refraction for each colour.

If we take red light :

$$\sin \phi = \frac{\mu' \sin \phi'}{\mu} = \frac{1.7 \sin 25\frac{1}{2}^\circ}{1} = \frac{1.7 \times .43}{1} = .732 ;$$

ϕ , the angle of refraction $= 47^\circ$ (found by table).

If we take blue light :

$$\sin \phi = \frac{\mu'' \sin \phi''}{\mu} = \frac{1.75 \sin 26\frac{1}{4}^\circ}{1} = \frac{1.75 \times .442}{1} = .774 ;$$

ϕ , the angle of refraction $= 50\frac{3}{4}^\circ$ (found by table).

This *dispersion* can now be represented in the diagram, seeing that it amounts to $3\frac{3}{4}^\circ$.

In optics it is convenient to use an expression to measure the dispersive power of diaphanous substances, which does not depend on the refracting angle of the prism employed. Further, in order that various substances may be compared, their dispersive powers are all measured with reference to a certain selected ray. (For this purpose the bisection of the D or sodium lines is the point in the spectrum often chosen.)

In the crown and flint glasses mentioned on page 4 the dispersion between the lines C and F, in the spectrum, referred to the bisection of the sodium lines D, is as follows. Crown glass:—refractive index bisection of lines D, $1.5179 = \mu$; line F, $1.52395 = \mu'$; line C, $1.51535 = \mu''$. Then the dispersive power ω

$$= \frac{\mu' - \mu''}{\mu - 1} = \frac{1.52395 - 1.51535}{1.5179 - 1} = \frac{.0086}{.5179} = .01661.$$

The values of the same lines for the flint glass are as follows: D, $1.7174 = \mu$; F, $1.73489 = \mu'$; C, $1.71055 = \mu''$.

$$\omega = \frac{\mu' - \mu''}{\mu - 1} = \frac{1.73489 - 1.71055}{1.7174 - 1} = \frac{.02434}{.7174} = .0339.$$

So the dispersive power of the flint between the lines C and F is slightly more than twice that of the crown for the same region of the spectrum. In the above formula the expression $\mu' - \mu''$ is usually written $\delta \mu$; in full it is therefore $\omega = \frac{\delta \mu}{\mu - 1}$.

Having thus traced a ray experimentally through a prism, our next step is to show that a *convex lens is only a curved form of two such prisms* with their bases in contact, as is shown in A, fig. 6, where the curved line shows the lenticular character and the shaded elements the two prisms. A concave lens is in effect two prisms reversed, that is, with their apices in contact, as in B, fig. 6, where, again, the curved line shows the form of the lens and the

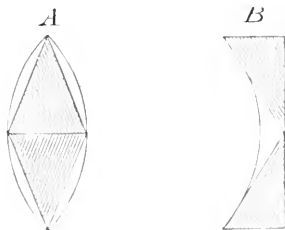

FIG. 6.—Convex and concave lenses are related to the prism.

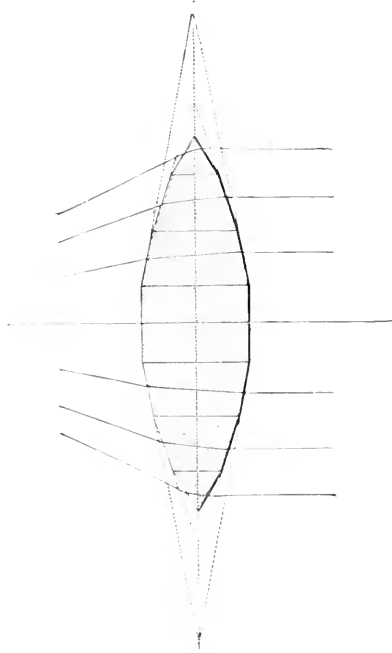

FIG. 7.—Proof that a lens may be considered as an assemblage of prisms. (From the 'Forces of Nature'.)

shaded parts its relation to a pair of prisms. The fact that a lens is, in effect, as such, but an assemblage of superposed prisms is seen in fig. 7, the refracting angle of the prism being more acute as the principal axis is approached, and the deviation being greater as the angle is more obtuse.

In fig. 8 let OP be the axis in each case; then, from what we have seen, it is manifest that rays parallel to the axis falling on the prisms with their bases in contact and acting like a convex lens will be refracted towards the axis OP . But in the other case, where the prisms have their apices together, as in fig. 9, acting as a concave lens, the light is refracted away from the axis OP .

V_R
 $V'R'$

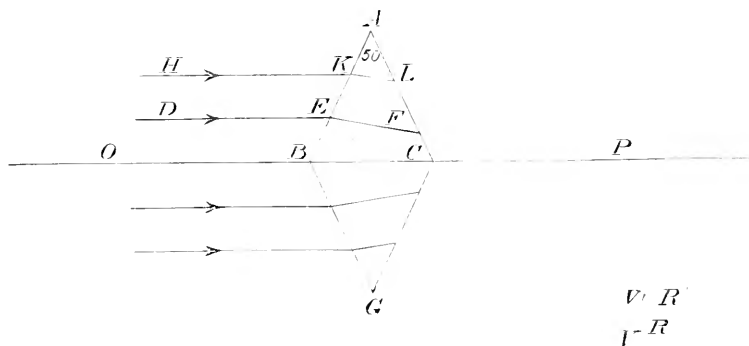

FIG. 8.—Action of a pair of prisms with their bases in contact on parallel light.

$I'R$
 $V'R$
 R'

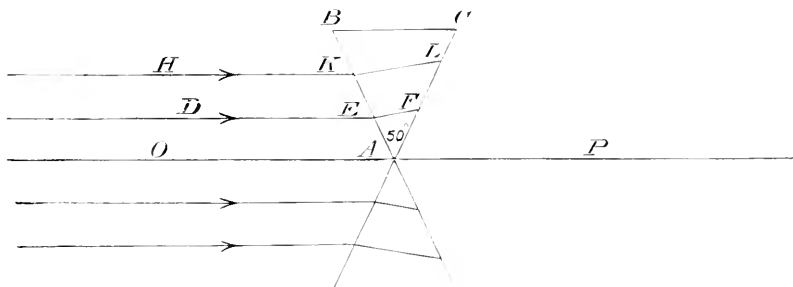

FIG. 9.—Action of a pair of prisms with their apices in contact on parallel light.

R'
 V'
 R

It must, however, be understood that there is a very important difference between the action of spherical lenses, *which is due to the different positions of the normals*.

In the prisms (figs. 8, 9) the incident surface A B is a plane; and as the normals are perpendicular to it, they must be parallel to one another, whether near the base or near the apex. Thus the normal at E is parallel to the normal at K; therefore, whatever angle D E makes with the normal at E, H K will make a similar angle with the normal at K, *because the normals are parallel and the incident rays are parallel*.

But in the case of a spherical lens *the normals are radii*; parallelism is therefore impossible, and parallel incident rays will not make equal angles with them, and so the refracted rays will not be parallel.

This explains how it is that when rays parallel to the axis fall on the prism (see fig. 8) those which pass through the prisms *near their bases* cut the axis *nearer* the prisms than those which pass through near the apex.

But in a convex lens the reverse takes place; the rays passing through near the middle of the lens cut the axis *further from* the lens than those which pass through the edge of the lens. The typical form of a biconvex or magnifying lens is shown in fig. 10.

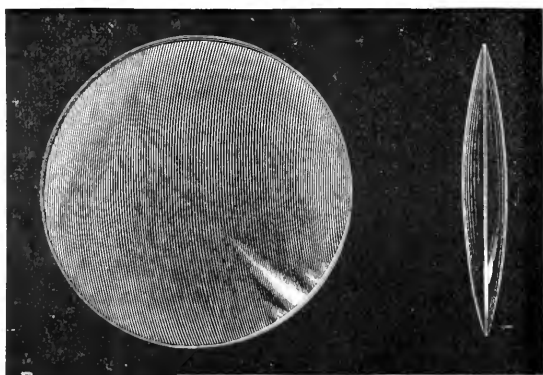

FIG. 10.—Front and edge views of a biconvex lens.
(From the 'Forces of Nature'.)

both in perspective, as seen from the edge, and with a full view of the disc; while the various forms which for various optical purposes are given to lenses is shown in figs. 11 and 12.

Now, if we study the four following figures, we shall see the principal action of lenses on light incident on their surfaces. Fig. 13 shows that if a radiant is placed at the principal focus of a converging lens, the rays are rendered parallel; conversely, if parallel rays fall on a converging lens, they are brought to a principal focus or point upon the axis.

Fig. 14 shows that if a radiant be placed *beyond* the principal

focus of a converging lens, the rays are brought to a focus *beyond* the principal focus on the other side of the lens. The nearer the radiant is to the principal focus, the farther away will be its *conjugate focus* from the other principal focus. In other words, there are two points in the axis such that if the object is one point its focus will be the other; these are reciprocal one to the other. These points,

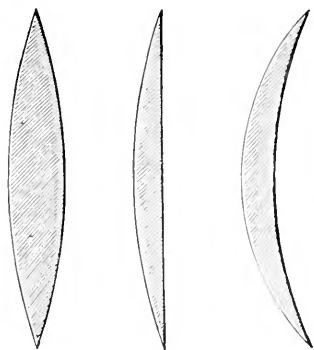

FIG. 11.—Biconvex, plano-convex, and converging meniscus lenses. (From the 'Forces of Nature.')

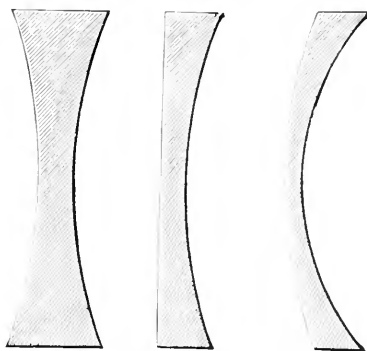

FIG. 12.—Biconcave, plano-concave, and diverging meniscus lenses. (From the 'Forces of Nature.')

the focal distances of which can always be calculated, are known as *conjugate foci*.

Should the radiant be at a distance from the principal focus equal to the focal length of the lens (i.e. twice the focal length from the lens), then its conjugate will be at the same distance from the focus

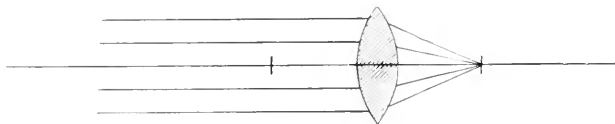

FIG. 13.—A radiant at the principal focus of a biconvex lens makes the refracted rays parallel.

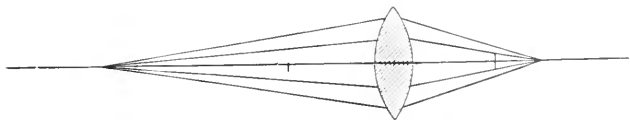

FIG. 14.—A radiant placed beyond the principal focus causes rays to converge beyond the principal focus on the other side of the lens.

on the other side of the lens (i.e. twice the focal length from the lens). In other words, when the object and its image are equidistant on either side of the lens, they are equal to each other *in size*, and are four times the focal length of the lens apart.

This law forms a ready means of determining the focal length of a lens. An object is placed in front of a lens, and the distances between this object and the lens and a screen to receive the image of the object are so adjusted that *the image of the object becomes equal in size to the object itself*. The distance of the object from the screen divided by 4 gives the focal length of the lens.

If a radiant be placed *between* a lens and its principal focus, the rays on the other side of the lens are still *divergent*, and will never meet in a focus on that side. This is seen in fig. 15; but if they are traced backwards, as in the dotted lines of fig. 15, they will then

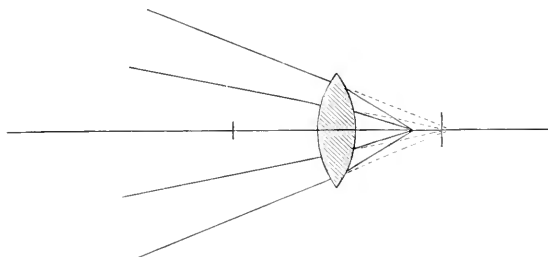

FIG. 15.—Rays diverge when a radiant is placed between a lens and its principal focus. Focus of divergent rays is virtual.

meet in a point. This is called the *virtual conjugate* focus of the radiant. The principal focus of a concave (or diverging) lens is shown in fig. 16. It will be seen that the principal focus is not *real* but *virtual*.¹ Parallel rays falling on a concave lens are rendered

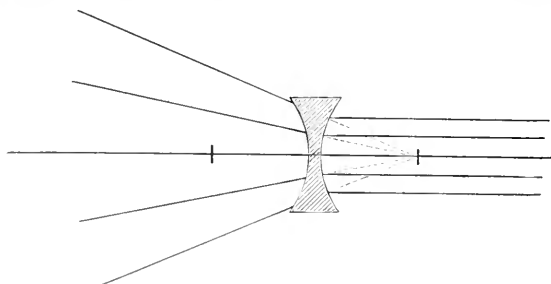

FIG. 16.—'Virtual' focus of concave lens.

divergent on the other side of the lens, and consequently can never come to a focus. But if we trace these divergent rays backwards, as in the dotted lines of fig. 16, we find that they meet in a point, and this point is called the *virtual principal* focus of the lens.

It will be manifest that since the rays in passing through lenses of various kinds are *unequally refracted* they cannot all meet *exactly* in a single focal point. This gives rise to what is a most important feature in the behaviour of lenses, which is known as **spherical aberration**.

Figs. 17 and 18 show the refraction of rays of monochromatic

¹ A *real* image can be received on a screen, but a *virtual* image cannot.

light parallel to the axis falling on a plano-convex lens of crown glass. These figures illustrate: (1) Longitudinal spherical aberration and (2) the focal length of a plano-convex lens and the point from which it is measured.

(1) In regard to the former it will be seen that the longitudinal spherical aberration is greatest in fig. 17, where the parallel rays of light fall upon the plane surface, and least where, as in fig. 18, they fall upon the spherical surface.

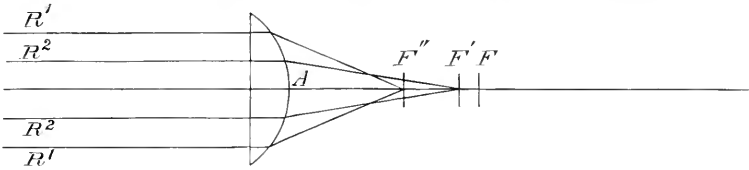

FIG. 17.—Spherical aberration.

distance of the focus for any ray passing through a lens from the principal focus of that lens.

Thus in figs. 17, 18, the spherical aberration is $F F'$ for the rays $R^2 R^2$, and $F F''$ for the rays $R^1 R^1$, and the difference between the

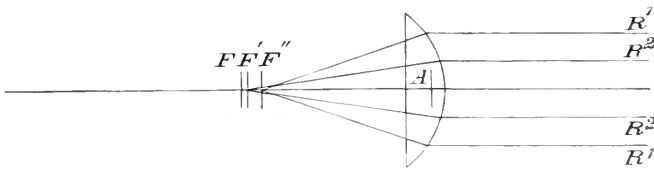

Fig. 18.—Spherical aberration.

spherical aberration of the rays $R^1 R^1$ and that of the rays $R^2 R^2$ is $F F'' - F F'$, which is $F' F''$.

Thus $F F'$ and $F F''$ in (fig. 17), $\hat{c}f = -\frac{9}{2} \cdot \frac{y^2}{f}$; $F F'$ and $F F''$ in (fig. 18) $\hat{c}f = -\frac{7}{6} \cdot \frac{y^2}{f}$, where $\hat{c}f$ signifies the distances $F F'$, $F F''$ respectively, y the distance from the axis where the incident ray enters the lens, and f the focus.

(2) In regard to the focal length of a plano-convex lens, it may be incidentally noted that the focal length in fig. 17 is twice the radius, measured from the vertex A , that is, $A F$. But in fig. 18 it is twice the radius measured from the point A ; that is, the point F is distant from the lens twice the radius less two-thirds the thickness of the lens.

It will be seen, then, that the *amount* of spherical aberration is due to the *shape* of the lens, and is least in a *biconvex lens*, when the radii of curvature are in the proportion of 6 : 1, *when the more curved surface faces the incident light*. But when the lens is turned round, so that the other side faces the incident light, the spherical aberration reaches a maximum.

It would be well for the student who desires to become familiar with these facts, without attempting any profound mathematical

grasp of them, to draw such a lens, and trace the paths of two rays through it, one near the axis, the other near the edge; then do the same with the lens reversed.

Formula for spherical aberration: ¹

$$-\delta f = \frac{y^2}{f} \cdot \frac{\mu - 1}{2\mu^2} \left\{ \frac{1}{r^3} + \left(\frac{\mu + 1}{f} - \frac{1}{r'} \right) \left(\frac{1}{f} - \frac{1}{r'} \right)^2 \right\} f^3,$$

where f = principal focal length; y = semi-aperture; μ = refr. index; and $r, -r'$, radii.

In an equi-convex of crown, where $\mu = \frac{3}{2}, r = -r' = f,$

$$\delta f = -\frac{5}{3} \cdot \frac{y^2}{f}.$$

In a plano-convex of crown, where $\mu = \frac{3}{2}, -r' = \infty, r = \frac{f}{2},$

$\delta f = -\frac{7}{6} \cdot \frac{y^2}{f}.$ Here parallel rays are incident on the convex surface. But when parallel rays are incident on the plane surface, $\mu = \frac{3}{2}, r = \infty, -r' = \frac{f}{2}, \delta f = -\frac{9}{2} \cdot \frac{y^2}{f};$ consequently the spherical aberration is four times as great (see figs. 17 and 18).

When $-r' = \infty,$ and $\mu = 1.69,$ the plano-convex becomes the form of minimum aberration.

In a crossed ² biconvex lens, where $-r' = 6r,$ and $\mu = \frac{3}{2},$

$\delta f = -\frac{15}{14} \cdot \frac{y^2}{f},$ the parallel rays being incident on the more curved surface.

Formula for finding the principal focus F of a lens equivalent to two other lenses whose foci are f, f' and their distance apart d :

$$\frac{1}{F} = \frac{1}{f} + \frac{1}{f'} - \frac{d}{ff'}.$$

In figs. 5, 8, and 9 we see that when the incident ray D E consists of *white light*, the colours of which it is composed are unequally refracted; the two extremes, R (red light) and V (violet light), being bent in different directions, the other colours lying between them in their proper order.

This unequal refraction of the different colours takes place in like manner in spherical lenses, and it is then known as *chromatic aberration*.

The effect of this upon the action of a lens is that, if parallel white light fall upon a convex surface, the most refrangible of its component rays (which, as we have seen, is the violet) will be brought to a focus at a point somewhat nearer the lens than the principal focus; and the red ray, having the least refrangibility, will be brought to a focus at a point farther from the lens than its principal focus, which is, in effect, the mean of the chromatic foci.

¹ *Encyclopædia Brit.* vol. xvii.

² A biconvex lens is said to be 'crossed' when the radii of its surfaces are in the proportion of 1 : 6.

This will be fully understood by the aid of fig. 19.

The white light, $A A''$, falling on the peripheral portion of the lens, is so far dispersed or decomposed that the violet rays are brought to a focus at C , and, crossing there, diverge again and pass on towards $F F'$; whilst the red rays are not brought to a focus until they reach the point D , crossing the divergent violet rays at $E E$. The foci of the intermediate rays of the spectrum (indigo, blue, green, yellow, and orange) are intermediate between these two extremes. The distance $C D$, limiting the violet and the red, is termed the *longitudinal chromatic aberration of the lens*.

If the image be received upon a screen placed at C , violet will predominate, and will be surrounded by a prismatic fringe in which blue, green, yellow, orange, and red may be distinguished. If, on the other hand, the screen be placed at D , the image will have a

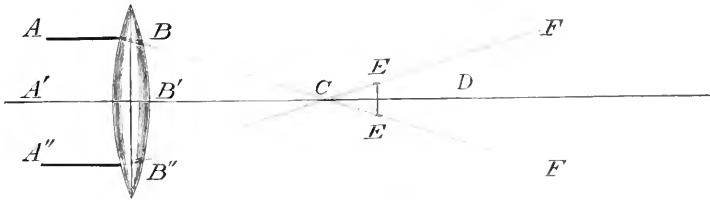

FIG. 19.—Chromatic aberration.

predominantly red tint, and will be surrounded by a series of coloured fringes, in inverted order, formed by the other rays of the spectrum which have met and crossed.

The line $E E'$ joins the points of intersection between the red and the violet rays which marks the *mean focus*, or the point where the dispersion of the coloured rays will be least.

The axial ray undergoes neither refraction nor dispersion, and the nearer the rays are to the axial the less dispersion do they undergo. Similarly, when the refraction of the rays is greatest at the periphery of a lens, there the dispersion will be most. Hence the peripheral portions of uncorrected lenses are stopped out, and the centre only often used that the chromatic aberration may be reduced to a minimum.

Manifestly, therefore, the correction or neutralisation of this chromatic aberration, which is known in optics as *achromatism*, is a matter of the first moment. Multiplied colour foci between C and D (fig. 19) make a perfect optical image impossible.

It is a question of interest and importance to the microscopist to know *how achromatism is obtained*.

In a prism the amount of dispersion or unequal bending of R and V (fig. 5) depends on two things: (1) the nature of the glass of which the prism is composed, and (2) the refracting angle $B A C$.

If, for example, another prism were taken, made of a different kind of glass, possessing only half the dispersive power of that in the figure, but with the angle $B A C$ 50° , as in this case, the separa-

tion of R and V would only be *half as great* as that effected by the prism in the figure.

Then if another prism were made of the *same material* as that assumed in fig. 5, but with only *half the refracting angle*, viz. 25° , the dispersion between R and V would also be but half that represented. Also a prism having 50° of refracting angle gives the same amount of dispersion as that from a prism of 25° of refracting angle, but of twice its dispersive power.

Under these conditions, when one prism, exactly like another in angle and dispersive power, is placed close to it in an inverted position, the dispersion of the first prism is entirely neutralised by that of the second because it is precisely equal in amount and

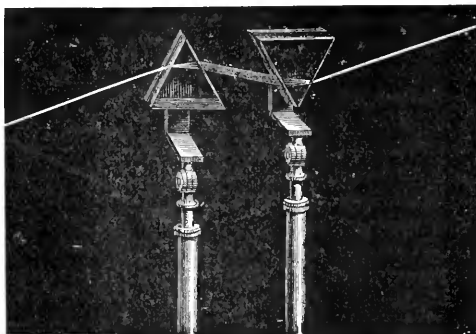

FIG. 20.—Recomposition of light by prisms. (From the 'Forces of Nature.')

opposite in power. This will be understood by a glance at fig. 20. But it will be seen that not only is dispersion reversed, but refraction also is neutralised, the emergent ray being parallel to the incident ray. Therefore the equal and inverted system of prisms can be of no possible use to the practical optician in the correction of lenses because

the *convergence* and *divergence* of rays are both essential to the construction of optical instruments. The dispersion, in fact, must be destroyed without neutralising all the refraction.

Suppose we take a prism with an angle of 50° , composed of glass having a certain dispersive power, and invert next it a prism of 25° angle, composed of glass having twice the dispersive power of the former. Dispersion will be manifestly destroyed, because it is equal in amount and opposite in nature to that possessed by the prism of 50° ; but the prism with an angle of 25° will not neutralise all the refraction effected by the prism of 50° .

These conditions plainly suggest the solution of the problem, for part of the convergence is maintained while the whole of the dispersion is destroyed.

The spherical lenses which answer to these prisms are a crown biconvex, fitting into a flint plano-concave of double the dispersive power

It has been pointed out above that all the other colours lie in their proper order between the rays R and V (fig. 5). Let us select one, green, and represent it by G. Now if G lies midway between R and V in the prism of 50° of angle, and also between R and V in the prism of 25° of angle, its dispersion will also be neutralised. This means that when the dispersion between the three colours in

one kind of glass is proportional to their dispersion in the other, then when any two are destroyed the third is destroyed with them. This unfortunately is not the case in practice, because two kinds of glass having proportional dispersion powers cannot be obtained. This, however, is what really happens. G may lie midway between R and V in one kind of glass, but in the other it may lie, for instance, much nearer R, say a third instead of half the distance of R from V. If now the dispersion of R V be destroyed, G will be left outstanding. If a different angle of prism be chosen, so that R and G are neutralised, then V must be left outstanding.

This want of proportion in the dispersion of the various colours of the spectrum in two kinds of glass is termed the *irrationality of the spectrum*, and the colour or colours left outstanding in a corrected combination of lenses is known as the *secondary spectrum*.

In some subsequent pages we shall have to call attention to the manufacture in Germany of some new vitreous compounds by the combination of which with fluor spar the secondary spectrum has been removed from microscope objectives, and an *apochromatic* system of construction has been introduced.

Meanwhile, we may remember that it has only been in comparatively recent times that the construction of achromatic object-classes for microscopes has been brought about, but the gradual enlargement of aperture and the greater completeness of the corrections soon after the discovery of achromatism rendered sensible an imperfection in the performance of these lenses under certain circumstances, which had previously passed unnoticed, and Andrew Ross made the important discovery that the use of cover-glass in mounting minute objects introduced aberration, and that a very obvious difference exists in the precision of the image, according as it is viewed *with* or *without* a covering of thin glass, an object-glass which may be perfectly adapted to either of these conditions being sensibly defective under the other.

He also devised the means of correcting this error, and published his device in vol. li. of Transactions of the Society of Arts for 1837.

Fig. 21 will illustrate the effect produced on the corrections of an object-glass by the interposition of a cover-glass between the object and the objective.

The rays radiating from the object O in every direction fall upon the cover-glass C C ($\mu = 1.6$). On tracing two definite rays, such as O A and O B, it will be found that they will be refracted to R and P (shown by the dotted lines of the figure). On their emergence into air they will be again refracted in a direction parallel to their first path, and will enter the front lens of the objective at the points M and N.

Now as M R and N P, produced, meet in Y, it follows that, so far as the objective is concerned, the rays M R, N P might have diverged from the point Y.

Similarly, by tracing two of the less divergent rays from O they will be made by the refraction of the cover-glass to appear as if they diverged from X. Therefore, in consequence of the cover-glass the objective has to deal with rays radiating *apparently from two dis-*

tinct points, X and Y. If there were no cover-glass all the rays would diverge from O, and then the objective would require to be perfectly *aplanatic*. This word (derived from \acute{a} = privative, and $\pi\lambda\alpha\rho\acute{\alpha}\omega$, to wander, i.e. free from wandering or error) means, as used by opticians,

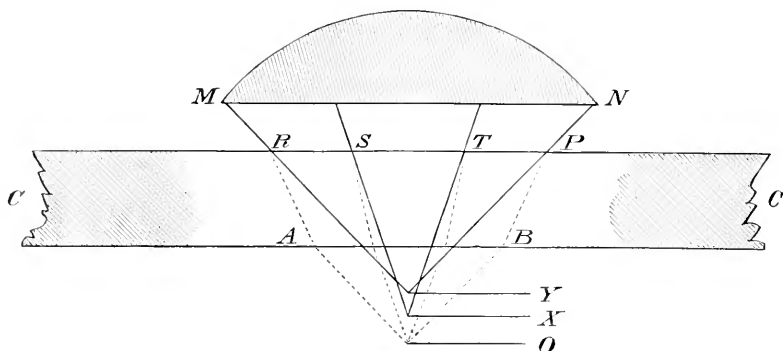

FIG. 21.—The effect produced by a cover-glass on the corrections of an object-glass.

that all the rays passing through a lens system are brought to an identical conjugate focus, as shown in fig. 22. But as affected by the cover-glass the marginal rays diverge, apparently, from a focus, *nearer the objective* than the central rays; therefore the objective, to meet this condition, must be what is called *under-corrected*; a condition presented in fig. 23, so as to focus both these points at once. Here the

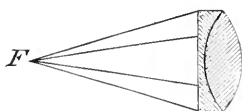

FIG. 22.—Aplanatic system.

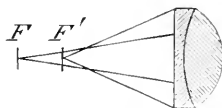

FIG. 23.—Under-corrected system.

curvature of the surface of the crown lens being increased, the flint plano-concave is not sufficiently powerful to neutralise all the spherical aberration of the crown. As a consequence the peripheral rays are brought to a focus at F' , while the central rays pass on to F . This is what is meant by 'under-correction' in an object-glass.

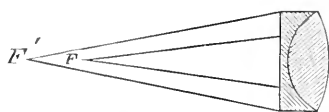

FIG. 24.—Over-corrected system.

In fig. 24 the reverse condition is presented, for the incident curve of the crown lens has been flattened, while that of the flint has been deepened, which increases the corrective power of the flint, and thus destroys the balance of the combination in other directions. The rays passing through the periphery of the combination will be brought to a focus F' , while the central rays will be focussed at F . This is what is known as *over-correction*.

An *aplanatic objective* can be made into an *under-corrected* objective by (1) causing the back lenses of which it is composed to approach the front lens. This is the device of Andrew Ross, and is now effected¹ by means of a special 'collar' arrangement, which, by the action of a screw, approximates or separates the suitable lenses. But for this a special device is needed for each objective. (2) The result can moreover be secured by causing the eye-piece to approach the objective. This of course is accomplished by the use of the draw-tube, and must be employed with objectives having rigid mounts.

Closing lenses, that is, bringing them together, whether in the objective itself or in the microscope as a whole, by shortening the distance between the eye-piece and the objective, *under-corrects the objective*, that is, gives negative aberration; while the *separation of lenses over-corrects* or gives positive aberration.

In using the *collar correction*¹ for a longer body or a thicker cover-glass the collar adjustment must be moved so as to cause the back lenses of the objective to approach the front lens, while for a shorter body or a thinner cover-glass, the adjustment must be moved so as to cause their separation.

In *correcting by tube length* for a thicker cover shorten the tube, and for a thinner one lengthen it.

For the benefit of those who aim at work with lenses, that is such as may be compassed with the aid of the most elementary mathematics, it may be well to indicate a simple method for the deduction of the *foci of plano-convex and biconvex lenses*.

In fig. 17 the focus is twice the radius measured from the vertex A, that is, A F. But in fig. 18 it is twice the radius measured from the point A, that is, the point F is distant from the lens twice the radius less two-thirds the thickness of the lens.

Similarly, in fig. 25, the focus of a *biconvex lens* is measured from the point A; in other words, F is distant from the lens the length of the radius less one-sixth the thickness of that lens (nearly).

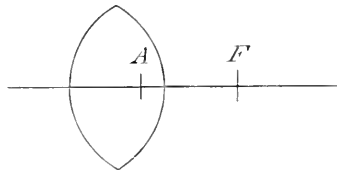

FIG. 25.—The focus of a convex lens

Formulae relating to a biconvex lens.—Where P is one focus, P' its conjugate, F principal focus (solar focus, or that for a very distant object), R radius of curvature for one surface, R' for the other surface, μ the refractive index of the medium, then

$$\frac{1}{P} + \frac{1}{P'} = (\mu - 1) \left(\frac{1}{R} + \frac{1}{R'} \right);$$

$$\frac{1}{F} = (\mu - 1) \left(\frac{1}{R} + \frac{1}{R'} \right);$$

$$\frac{1}{P} + \frac{1}{P'} = \frac{1}{F}$$

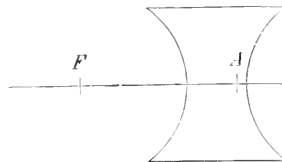

FIG. 25A.—Focus of a concave lens.

¹ See Chapter V.

Also, if x is the distance of a focus from F , the *principal focus*, and y , the distance of its conjugate from F' , the other *principal focus* on the other side, then

$$x y = F F' ;$$

or,

$$x y = F^2.$$

In an equiconvex lens of crown glass if $\mu=1.5$, F =radius of curvature. But in a plano-convex lens of crown glass if $\mu=1.5$, F =twice the radius of curvature.

In the above formula the thickness of the lens has been neglected. In thick lenses, however, its effect must not be disregarded, even if only approximate results are required. A very approximate determination of the principal focal length of an equiconvex lens *measured from the surface* may be made by subtracting from the result obtained by the foregoing formulæ one-sixth of the thickness of the lens. (See fig. 25.)

Examples.—Equiconvex lens of crown glass $\mu=1.5$, $r=\frac{1}{2}$, thickness= $\frac{1}{4}$. By above formula $F=\frac{1}{2}$. Subtracting from this one-sixth of the thickness of the lens, we get $F=\frac{11}{24}$ as the distance between the focus and the surface of the lens. This is only $\frac{1}{256}$ inch from the truth. If the lens were a sphere it would be necessary to subtract $\frac{1}{4}$ of its thickness.

In the case of a plano-convex lens the principal focus on the convex side is equal to twice the radius as above, but on the plane side two-thirds of the thickness of the lens must be subtracted from it.

In a hemispherical lens of crown glass $\mu=1.5$, radius= $\frac{1}{2}$, thickness= $\frac{1}{2}$, the principal focus on the convex side will be one inch from the curved surface and on the plane side $\frac{2}{3}$ inch from the plane surface.

In an equiconcave lens the foci are virtual and are crossed over; thus, the lens in fig. 25A is equiconcave, the focus F , instead of being measured from A to the right hand, must be measured to the left hand; consequently, $\frac{3}{4}$ of the thickness must be subtracted from the focal length in order to determine the distance of F from the surface of the lens.

A plano-concave lens follows the plano-convex, but the foci are virtual and crossed over. From the principal focus on the curved side subtract $\frac{2}{3}$ of the thickness, and from that on the plane side subtract the whole thickness of the lens.

Examples.—Equiconcave of dense flint $\mu=1.75$, radius= $-\frac{1}{2}$, thickness $\frac{1}{4}$, F by formula= $-\frac{1}{3}$; subtract from this $\frac{3}{4}$ of the thickness of the lens, we obtain $-\frac{1}{4}$, which is only $\frac{1}{140}$ inch too short.

Plano-concave of dense flint $\mu=1.75$, radius= $-\frac{1}{2}$, thickness $\frac{1}{4}$, F by formula= $-\frac{2}{3}$, subtract from this the thickness of the lens. Then $F=-\frac{5}{12}$; this is the focal distance from the plane side. For the focal distance from the curved side subtract $\frac{2}{3}$ of the thickness, then $F=-\frac{5}{6}$, which is $\frac{1}{4}$ inch too long.

The *principal focus of a combination of two or more lenses*, whose

principal foci and distances are known, can be found from the formula $\frac{1}{p} + \frac{1}{p'} = \frac{1}{f}$ by assigning for the value of p the distance of the principal focus of the first lens from the second, and so on.

Example.—Parallel rays fall on an equiconvex lens of four inches focus. Two inches from this lens is another equiconvex lens of three inches focus. Find the distance of the focal point from this last lens, to which the rays will be brought. It is evident that the rays would be brought by the first lens to a focus two inches behind the second if it were not there. This point, which is negative with regard to the second lens, must be taken as the value of p in the formula. We have, therefore :

$$\frac{1}{-2} + \frac{1}{p'} = \frac{1}{3};$$

$$p' = \frac{6}{5}.$$

Hitherto our attention has been confined, in studying the action of lenses, to the manner in which they act upon a bundle of parallel rays, or upon a pencil of rays issuing from a radiant point. Moreover, we have considered this point as situated in the line of axis. But the surface of every luminous body may be regarded as comprehending an infinite number of such points, from every one of which a pencil of rays proceeds, to be refracted in its passage through the lens according to the laws enunciated. In this way a complete *image*, i.e. picture of the object, will be formed upon a suitable surface placed in the position of the focus.

There are two kinds of image formed by lenses, a *real* image and a *virtual* image.

1. *The formation of a real image* means the production of a

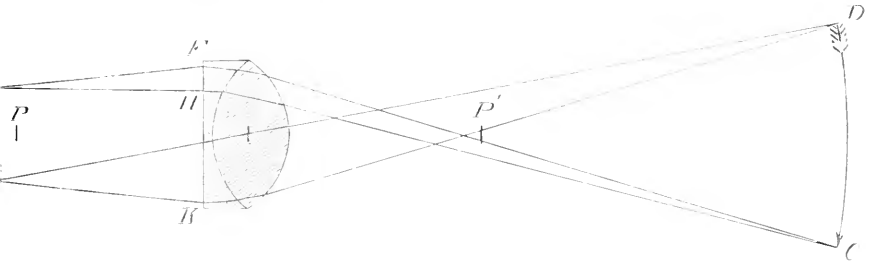

FIG. 26.—The formation of a real image.

picture by a lens, or a combination of lenses, which can be thrown upon a screen; such are the images of a projection lantern and the image produced by the camera upon the focussing glass. The manner in which this takes place will be understood by reference to fig. 26, where AB is an object placed *beyond* P , the principal focus of the aplanatic combination. From every point of AB are rays radiating at every possible angle. Let AF and AH be two such rays radiating from the point A . Now if the refraction of these rays be

traced, in the manner already indicated, through the aplanatic combination, it will be found that the rays which before immergence were diverging are by the refraction of the combination on emergence rendered converging. Thus the ray FC meets HC at the point C . The point C is called the conjugate focal point of A , and wherever there is a focal point there will be an image. Therefore, at C , there will be an image of A . In the same manner the rays issuing from every point along AB may be traced, and will be found to have each one its respective conjugate lying on CD , so the conjugate of B is at D . Hence it is at once manifest that an *inverted* conjugate image of the object AB is formed at CD . Further, it will be noticed that, although the object is straight, the image of it is curved towards the lens.

If the object AB had been curved, so that it presented a convex aspect to the lens, then its conjugate image CD would have been more curved; but if AB had been slightly concave towards the lens, then its conjugate would have been straight.

As before stated, the point C has been determined by tracing the refraction of two rays,¹ AF and AH , through the lens. Another method is, however, often employed.

In every lens there is a point which is called its optical centre. This point is such that any ray, which in its refraction through the lens passes through this point, will emerge in a direction parallel to its path before immergence. Now as lenses for graphic and theoretical purposes are often assumed to be of insensible thickness, it has become the practice to draw any ray passing through the optical centre of the lens a straight line. Obviously, if the lens has sensible thickness the ray cannot be considered a straight line, and in the microscope, where the lenses are very thick in proportion to the length of their foci, this method will lead to much error. Of course, in those cases where it can be taken as a straight line, it saves the trouble of computing a second ray to intersect the first, as any ray intersecting the straight line will determine a conjugate focal point.

In the upper part of fig. 26 the two rays, AF and AH , are traced through the lens to determine the point C , but in the lower part of the figure only the ray BK is traced, and the intersection of this ray by the straight line BD passing through the optical centre gives the point D .

2. An image is said to be *virtual* when it cannot be received on a screen. Fig. 27 shows how a virtual image is formed. The letters are the same as in the preceding figure, so as to show the analogy between the two. The fundamental difference between this figure and the last is that the object AB is placed *between* P , the principal focus, and the lens.

We have already seen from fig. 15 that when a radiant is placed before a converging lens, and nearer to it than its principal focus, the rays emerging from the lens are still divergent even after their refraction through the lens; consequently they will never intersect,

¹ In the majority of the preceding diagrams the drawing has represented the facts accurately; in this instance they are diagrammatic, the size of admissible illustrations making an accurately traced ray impossible.

and as there is no focal point, there can be no screen image. Thus two rays radiating from the point A of the object A B fall on the lens and are refracted in the directions A F, A H : these are divergent and will never meet : but if the human eye is placed near the lens, so that it can receive the rays F and H, the rays will be converged by the lens of the eye, and will be brought to a focal point in the retina.

Similarly, from every point in A B there will be a corresponding retinal point. Now if we produce F and H backwards (see the dotted lines in the figure) we shall find that they intersect at the point C. As the rays F and H are precisely identical with rays which would have diverged from the point C had it been an entity, the retinal image therefore will be an image of a non-existent picture C D.

The method of drawing this is exactly similar to that of the

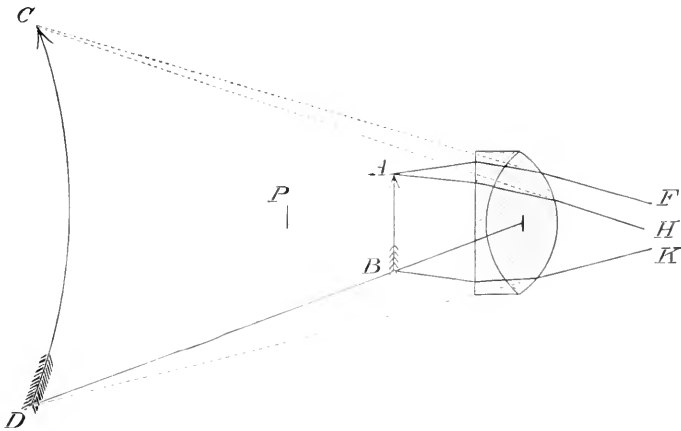

FIG. 27.—The formation of a 'virtual image.'

preceding figure. The rays A F and A H are traced through the lens, and their prolongation backwards (see the dotted lines in the figure) gives the point C. Also, as in the preceding figure, any point of the picture can be found by tracing one ray, such as K : then the intersection of its backward prolongation with a straight line joining B with the optical centre, produced, will give D.

The points C and D are called the *virtual conjugate foci* of A and B respectively. In mathematical optics it appears as a negative quantity which satisfies an equation, and is a sort of metaphysico-mathematical truth. In this case the virtual image is convex towards the lens.

Fig. 27 illustrates the action of a simple microscope. The object itself is not seen, but the picture presented to the eye is an enlarged ghost of it. As some eyes can take in rays of less divergence than others, it might happen that the rays C F, C H, were too divergent for the observer's eyesight, in which case the lens would

have to be withdrawn from the object. Similarly, if the observer were short-sighted, the lens must be placed nearer the object to render the rays more divergent. Dr. Abbe points out¹ that the generally adopted notion of a 'linear amplification at a certain distance' is, in fact, a very awkward and irrational way of defining the 'amplifying power' of a lens or a lens-system.

In the formula $N = \frac{l}{f}$ the amplification of one and the same system varies with the length of l , or the 'distance of vision,' and an arbitrary conventional value of l (i.e. 10 inches, or 250 mm.) must be introduced in order to obtain comparable figures. The actual 'linear amplification' of a system is, of course, different in

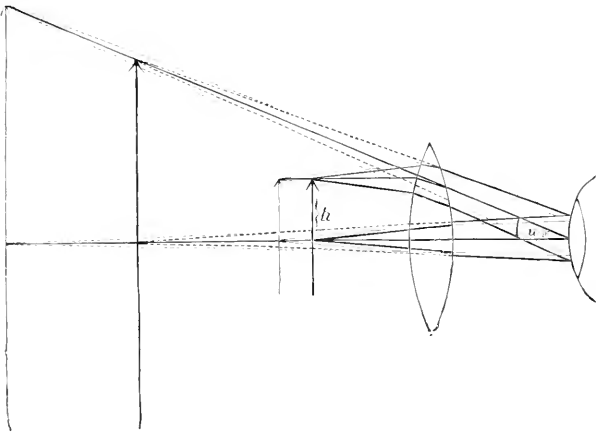

FIG. 28.—The amplifying power of a lens.

the case of a short-sighted eye, which projects the image at a distance of 100 mm., and a long-sighted one, which projects it at 1000 mm. Nevertheless, the 'amplifying power' of every system is always the same for both, because the short-sighted and the long-sighted observers obtain the image of the same object under the same visual angle, and consequently the same real diameter of the retinal image. That this is so will be seen from fig. 28, where the thick lines show the course of the rays for a short-sighted eye, and the thin lines for a long-sighted one, the eye in each case being supposed at the posterior principal focus of the system.

The other generally adopted expression of the power by $N = \frac{l}{f}$ may be put on a somewhat more rational basis than is generally done by defining the length l (10 inches) not as 'distance of distinct vision,' but rather as 'distance of projection of the image.' As far as 'distinct vision' is assumed for determining the amplification, the value of N has no real signification at all in regard to an observer

¹ *Journ. R.M.S.* vol. iv, ser. ii, p. 318.

who obtains distinct vision at 50 inches instead of 10 inches, and, in fact, many microscopists declare the ordinary figures of amplification to be useless for them because they cannot observe the image at the supposed distance. It appears as if—and many have this opinion—the performance of the microscope in regard to magnification depended essentially on the accommodation of the observer's eye. This misleading idea, resulting from the common expression, is eliminated by defining the 10 inches merely as the distance from the eye at which the image is measured—whether it be a distinct or an indistinct image. For, if an observer, owing to the accommodation of his eye, obtains a distinct image at a distance of 10 feet, I may nevertheless assume a plane at a distance of 10 inches from the eye on which the distant image is virtually projected, and measure the diameter of that projection. Now this diameter is strictly the same as the diameter of that image, which another observer would really obtain with distinct vision at that same distance of 10 inches.

The only difference is that in the former case we must take the centres of the circles of indistinctness instead of the sharp image-points in the latter case. If the conventional length of $l=10$ inches is interpreted in this way (as distance of projection, independently of distinct vision) the absurdity at least of a real influence of the accommodation on the power of a microscope is avoided. It becomes obvious that for long-sighted and for short-sighted eyes the same N must indicate the same visual angle of the enlarged objects, or the same magnitude of the retinal image, because it indicates the same diameter of the projection at 10 inches distance.

It was long since pointed out by Amici, that the introduction of a drop of water between the front surface of the objective, and either the object itself or its covering glass, would diminish the loss of light resulting from the passage of the rays from the object or its covering glass into air, and then from air into the object-glass. This, which is known as 'water immersion,' was, however, first suggested by Sir D. Brewster in 1813. But it is obvious that when the rays enter the object-glass from water instead of from air, both its refractive and its dispersive action will be greatly changed, so as to need an important constructive modification to suit the new condition. This modification seems never to have been successfully effected by Amici himself; and his idea remained unfruitful until it was taken up by Hartnack, who showed that the application of what is now known as the *immersion system* to objectives of high power and large aperture is attended with many advantages not otherwise attainable. For, as already pointed out, the loss of light increases with the obliquity of the incident rays; so that when objectives of very wide aperture are used 'dry,' the advantages of its increase are in great degree nullified by the reflection of a large proportion of the rays falling very obliquely upon the peripheral portion of the front lens. When, on the other hand, rays of the same obliquity enter the peripheral portion of the lens from water, the loss by reflection is greatly reduced, and the benefit derivable from the large aperture is proportionately augmented. Again, the 'immersion

system' allows of a greater working distance between the objective and the object than is otherwise attainable with the same extent of aperture; and this is a great advantage in manipulation. Further, the observer is rendered less dependent upon the exactness in the correction for the thickness of the covering glass, which is needed where objectives of large aperture are used 'dry;' for as the amount of 'negative aberration' is far smaller when the rays which emerge from the covering glass pass into water than when they pass into air, variations in its thickness produce a much less disturbing effect. And it is found practically that 'immersion' objectives can be constructed with magnifying powers sufficiently high, and apertures sufficiently large, for the majority of the ordinary purposes of scientific investigation, without any necessity for cover-adjustment; being originally adapted to give the best results with a covering glass of suitable thinness, and small departures from this in either direction occasioning comparatively little deterioration in their performance. But beyond all these reasons for the superiority of the 'immersion system' is, as will be presently seen, the fact that it admits into the lens a larger number of 'diffraction spectra' than can be possibly admitted by a lens working in air; and upon this depends the perfect presentation of the image.

The *immersion system* has still more recently been advanced upon by the application of a principle which lies at the root of the optical interpretation of the images which modern lenses present, and which has greatly increased the value of the microscope as a scientific instrument. It is an improvement that primarily depends upon a correct theoretical understanding of the principles of the construction of microscopical lenses, and the interpretation of the manner in which the image is realised by the observer. The late Mr. Tolles was the first to adopt this system, as we point out subsequently; but it is to Professor Abbe we are indebted for its practical application, through whom it is now known as the *homogeneous system*. The word 'homogeneous' was, however, first applied to microscope lenses by Tolles (1871), as may be seen in the following passage. . . . 'two hemispherical lenses balsam-cemented, with a diatom or other small object at the centre, together constituting a nearly homogeneous transparent globe' (M. M. J., vol. vi. p. 214). 'The idea of realising the various advantages of such a system by constructing a certain class of homogeneous objectives had, Professor Abbe says,¹ for some time presented itself to his mind.' 'The matter assumed, however, subsequently, a different shape in consequence of a suggestion made by Mr. John Ware Stephenson, . . . of London, who independently discovered the principle of homogeneous immersion.'²

This method consists of the replacement of water between the covering glass of the mounted object and the front surface of the object-glass by a liquid having the same refractive and dispersive power as crown glass. With such a fluid taking the place of air, it

¹ On 'Stephenson's System of Homogenous Immersion for Microscopic Objectives' (Abbe), *Journ. R.M.S.* vol. ii. 1879, p. 257.

² *Ibid.*

follows that the correction collar, though still a refinement and aid in the attainment of the finest critical images, would be a necessity no more.

The desirability of the construction of a combination of lenses which would satisfy these conditions was urged by Mr. Stephenson upon Professor Abbe, and he secured the profound knowledge, which, as a mathematical optician he possessed, for the complete and practical solution of the problems involved, and the production of a remarkable series of lenses, marking a distinct epoch in the progress of theoretical and practical optics.

He had, in fact, as we have hinted, already approached the consideration of the subject from another point of view, believing that petrographic work—the study of thin sections of mineral substances—could be far more efficiently accomplished by the use of homogeneous lenses. But in the new aspect in which the problem was presented by Mr. Stephenson it carried with it new interest to Abbe, not only as promising to largely dispense with the 'correction collar,' but also to greatly enlarge the 'numerical aperture,' and therefore secure a greater resolving power in the objective.

One of the difficulties was to find a suitable fluid to meet the necessities as to refraction and dispersion. But after a long series of experiments Professor Abbe found that oil of cedar wood so nearly corresponds with crown glass in these respects that it served the purpose well.

The result of Abbe's calculations based on Mr. Stephenson's suggestion was the construction by Carl Zeiss of a $\frac{1}{2}$ th with a N.A.¹ of 1.25 of fine quality, and still higher promise, and subsequently of a $\frac{1}{8}$ th and a $\frac{1}{18}$ th in. objective of a like character.

It may be well to note that Amici suggested the use of oil instead of water prior to 1850, and Mr. Wenham again revived the suggestion in 1870.² But neither of these is in even a remote sense an anticipation of the 'homogeneous system' of lenses as we now understand it. The 'oil immersion' in both instances was an expedient. The principle on which the construction carried out by Professor Abbe depended was the 'optical' principle that a medium of high refractive power gives an aperture greatly in excess of the maximum (180°) of a dry lens; while Abbe's explanation, propounded in 1874, of the important bearing which the *diffraction pencils* have on the formation of the microscopic image makes the resolving power of the object-glass dependent upon the diffraction pencils that are taken up by it.

All this was unknown or unadmitted by those who had previously suggested oil as an *immersion* medium, which leaves the homogeneous system as now employed wholly dependent upon the principles enunciated by Abbe, arising from the practical suggestion of Stephenson and resulting in the beautiful object-glasses of Abbe and Zeiss, although it is best just to remember that Tolles always maintained that his immersion objectives had a greater aperture than 180° air

¹ The meaning of this expression will be found on p. 49, but the whole of Chap. II. must be carefully read.

² *Monthly Micro. Journ.*, vol. iii, p. 303.

angle. Dr. Royston-Pigott constructed the first aperture table giving the relative values of dry, water, and homogeneous (nascent pencil) immersion objectives; it is given in M. M. J., vol. iv. p. 26. (1870).

One of the essential advantages of this system, beyond those stated, is that by the suppression of spherical aberration in front of the objective, facilities are afforded for correcting objectives of great numerical aperture, both in theory and practice, that reduce it to the level of the problem of correcting objectives of moderate 'angle.' As a result, stimulated by the manifest advantage to be obtained and the wants of those engaged in actual research, Messrs. Powell & Lealand, of London, very soon made a $\frac{1}{35}$ th inch and a $\frac{1}{50}$ th inch objective on the homogeneous principle, with numerical apertures respectively of 1.38, and during the year 1885 produced lenses of an excellence impossible to any previous system of $\frac{1}{6}$ th inch, $\frac{1}{12}$ th inch, and $\frac{1}{20}$ th inch power, having respectively numerical apertures of 1.50, while 1.52 is the theoretical maximum.

The use of a 'correction collar' in homogeneous object-glasses has been dispensed with, correction being obtained by alteration of the tube length solely, but this must also be aided in endeavouring to secure the most perfect 'critical images' by a body-tube provided with rack and pinion motion; this should be of the best quality, and if the object-glass is of perfect construction and of latest form (apochromatic, *q.v.*), results never before attainable can be got with comparative ease.

With such evidence of advance in the optical construction of microscopes, dependent apparently on such accessible conditions, the question of what is possible in the future of the instrument no doubt obtrudes itself; that, however, can only be considered as having application to the area of our present knowledge and resources. It is impossible to forecast the future agencies which may be at the disposal of the practical optician. To photograph stars in the immeasurable amplitudes of space, absolutely invisible to the human eye, however aided, was hardly within the purview of the astronomers of a quarter of a century ago; that there may be energies and methods discoverable by man that will open up possibilities to the eager student of the minute in nature which will just as widely overstep our present methods of optical demonstration, there can be little reason to question. But it is no doubt true that with the instruments and media now at the disposal of the practical optician no indefinite and startling advance in microscopic optics is to be looked for. The 'atom' is infinitely inaccessible with any conceivable application of all the resources within our reach. But optical improvement of great value, bringing nature more and more nearly and accurately within our ken and reducing more and more certainly the interpretation of the most difficult textures and constructions in the minutest accessible tissue to an *exact method*, is certainly within our sight and reach. It is not a small matter that the homogeneous lenses were, in a comparatively short period of time, carried from a N.A. of 1.25 to 1.50; and this carried with it the capacity theoretically indicated.

High refractive media can greatly reduce the *value* of even the wave-length of light, and what is possible in the production of vitreous combinations, refractive fluid media, and mounting substances we may not forecast; but, judging from the past, we have by no means reached their limit. At the same time, it may be remembered that photo-micrography, by constantly covering a wider area of application with its ever increasingly delicate and subtle methods, is more penetrating in the revelation of structure than the human eye.

It may be taken for granted that in the present state of optical mathematics the opticians, English, Continental, and American, have given up the quest of many things fruitlessly sought. Empty amplification is a folly of lenses of the past. Magnification without concurrent disclosure of detail is of no more scientific value for the disclosure of structure than the projection of the photo-micrograph by an electric arc upon a screen would be. What is needed is an ever-increasing exactitude in the formation of the dioptrical image. The imperfection of this at the focal point springs from two causes: one, as we have just demonstrated, arises from the *residual spherical and chromatic aberrations*, the other takes origin in the *want of homogeneity, absolute precision of curve, and perfect centering of the system of lenses* in a combination. This causes the cone of rays proceeding from the object to unite, not in perfect image points, but in light surfaces of greater or less extent—circles of dissipation—which limits the distinctness of minute details. It is the faults of the *objective* that in practice are alone important, and with the crown and flint glass commonly at the disposal of the optician there are two great drawbacks to perfection, or rather to an approximation to it.

1. The first arises from the unequal course of the *dispersion* in crown and flint glass, already described, which makes it impossible to unite perfectly, with the properties they possess, *all the coloured rays in an image*. Absolute achromatism cannot by their means be attained, the dispersion at different parts of the spectrum being so greatly disproportional. It has never been possible to unite more than two different colours of the spectrum. The rest, in spite of all effort, deviate and form the *secondary spectrum*, leaving, in the very finest lenses, circles of dispersion not to be excluded.

2. The second defect arises in the impossibility of correcting by means of ordinary crown and flint glass the *spherical aberration* for more than *one* colour. If the spherical aberration be removed as far as may be for the centre of the spectrum, there remains under-correction for the red, and over-correction for the blue and violet rays, presenting a want of balance between the *chromatic corrections* for the central and marginal zones of the objective. Although perfect chromatic corrections for the central rays may be effected, giving images of great beauty, the chromatic over-correction for the peripheral rays with oblique illumination will show the borders of the image with distinct chromatic fringes.

To compensate these aberrations in the construction of an object-glass, what is needed is a vitreous material applicable to optical purposes possessed of such properties that a relatively smaller re-

fractive index could be united with a higher dispersive power, or a higher refractive index with a relatively lower dispersive power. By proper combination of such materials, if they be provided with ordinary crown and flint glass to partly remove the chromatic and spherical aberrations independently of each other, and so to obey the conditions on which the removal of the chromatic difference depends, these aberrations could be compensated.

All this was seen and fully demonstrated and set forth by Abbe as far back as 1876,¹ and he pointed out that the further perfecting of the microscope in its dioptrical working was dependent on the art of glass making; the production, that is to say, of vitreous compounds possessing different relations of refractive and dispersive power by means of which the secondary spectrum could be removed.

For practical purposes the matter was in abeyance until 1881, but since that time Dr. Schott and Professor Abbe, with the active co-operation of the optical workshops of Zeiss, undertook the laborious and prolonged investigation into the improvement of optical glass, to which we have alluded; the result has been the production of 'crown' and 'flint' glass possessing exactly the qualities foreshown as indispensable by Abbe.

By chemical, physical, and optical research of a most laborious nature, and by spectrometric observations of numerous experimental fusions systematically carried out with a large variety of chemical elements, the relation between the vitreous products and their chemical composition has been more closely investigated.

In the crown and flint glass produced up to the time of these investigations, the uniformity of property arose from the relatively small number of materials employed. Aluminium and thallium, with silica, alkali, lime, and lead, formed the limit. By the use of more chemical elements, especially phosphoric and boric acid as the essential constituents of glass fluxes in the place of silica alone, flint and crown glass have been produced in which *the dispersion in the different parts of the spectrum is nearly proportional*; so that in achromatic combinations it is now a question of detail and practical optics to eliminate almost entirely the secondary spectrum. It is unfortunate, nevertheless, that a large number of these glasses, especially those of most value to the optician, have proved to be so unstable in their composition that opticians refrain from using them. It may be hoped that further experiment and research will greatly reduce this defect. On the other hand, the kinds of glass which can be used for optical purposes have been so increased in variety that, while the mean index of refraction is constant, considerable variations can be given to the dispersion or to the refractive index while the dispersion remains constant. A high index of refraction is no longer of necessity accompanied by a high dispersion in flint glass, but may be retained in crown glass with a low degree of dispersion.

The practical consequence of this is that both the imperfections

¹ Hoffman, A. W., *Bericht über die wissenschaftlichen Apparate auf der Londoner Internationalen Ausstellung im Jahre 1876.*

inalienable from an objective constructed of ordinary crown and flint glass, *can be, and have been, eliminated*, and the secondary spectrum annulled; it is removed and reduced to a residue of chromatism of a tertiary character, while the chromatic difference of spherical aberration can be eliminated or completely corrected for *two different colours* of the spectrum at once, and therefore practically for all.

In the lenses formed of the crown and flint glass as used prior to the new German glass, we were provided with what (in comparison with non-achromatised lenses) were called 'achromatic;' but in the new system of lenses, which may be 'dry' or 'homogeneous,' we have so great a freedom from colour defect as to admit of their being designated *apochromatic lenses* ($\acute{\alpha}$ =privative; $\chi\rho\acute{\omega}\mu\alpha$ =colour; $\acute{\alpha}\rho\acute{\alpha}$ =from, away from; $\chi\rho\acute{\omega}\mu\alpha$ =colour).

The *practical advantages* obtained by this system of object-glass construction are so great as in delicate researches to be invaluable—provided always that the work in all its details is of the most perfect kind. The accidental juxtaposition of lenses of the required curves, and, relatively, even the careful selection of lenses not homogeneously related to each other by a unity of purpose and work on the part of the practical optician, cannot yield perfect results. 'Division of labour' is not compatible with perfect results in the making and building up of an apochromatic lens; and therefore, in their best form, these objectives must apparently command a high price. But, given such an object-glass—which is the production of a thoroughly competent practical optician—and its advantages, theoretical and practical, are great.

1. *The aperture of the objective can be utilised to its full extent.*

In the best of the older object-glasses at least one-tenth of the available aperture was useless; the inalienable defect in the convergence of the rays prevented a proper combined action of the outermost zone and the central parts of the aperture, and therefore by those objectives it has never been possible to *realise* the amount¹ of resolving power indicated by theory with a given aperture. But in a well-constructed apochromatic objective—the secondary spectrum being removed, and the spherical aberration being *uniformly* corrected for different parts of the spectrum—there is a practically perfect focal concentration of the rays in the image.

2. *Increase of magnifying power by means of specially constructed eye-pieces* is also a most important feature of objectives of this class. The result of this is that great magnifying power can be obtained by objectives of relatively large focal lengths. We have always maintained the utility of high eye-piecing under proper conditions, and with suitable apertures and fine corrections in the objective; the physical brightness, we learn from Abbe, in every case depends only upon the aperture and the total magnifying power; and it is of no moment in what way the latter is produced—by means of focal length of the objective, length of tube, and focal length of eye-piece.

¹ Excepting when resolution is effected by light of extreme obliquity. If the outermost zone of the objective is corrected alone, and that only be employed, at that limit equally good resolution may be accomplished.

But he has further shown us¹ that with the best objectives of the old construction, and with large apertures, the *limits* of a completely satisfactory clearness of image are reached when the *super-amplification* is four- to six-fold; that is, when the total magnifying power of the objective and eye-piece together is four to six times as great as that obtained with the objective when used by itself as a magnifying lens. On the other hand, with apochromatic objectives the available super-amplification—even with the greatest apertures—is at least twelve- to fifteen-fold, and considerably higher with medium and low objectives.

3. *Achromatism touches almost an ideal point in these objectives.* The images are practically free from colour over the entire area. This is of great value in photo-micrography. The correction errors of the ordinary achromatic systems are much more powerful as disturbing influences than in ordinary observation with the eye.

4. In spite of the removal of the secondary spectrum certain colour deviations of a tertiary nature remained, and are inevitable in all objectives of great aperture in which the front lens cannot be made achromatic by itself. With ordinary achromatic objectives, from the properties of the glass used, the amount of this is very unequal in the central and peripheral parts, but in the apochromatic object-glass it is approximately *constant for all parts of the opening*, and therefore it allows of correction by the eye-piece, a special construction possessing equal but opposite differences of magnifying power for different colours. The eye-piece is so constructed as to completely secure the desired result, and, as we have stated above, images free from colour are obtained.

5. *The classification of the eye-pieces* for this system of objectives has been established by Abbe, and depends on the increase in the total magnifying power of the microscope obtained by means of the eye-piece as compared with that given by the objective alone. The number which denotes how many times an eye-piece increases the magnifying power of the objective, when used with a given body-tube, gives the proper measure of the eye-piece magnification, and at the same time the figures for rational numeration.²

From their properties these are known as 'compensating eye-pieces.'

The following is a fair typical selection of the objectives and eye-pieces furnished from the workshops of Carl Zeiss, of Jena, on this important system, viz.:

¹ 'On the Relation of Aperture to Power,' *Journ. R.M.S.* 1883, p. 803.

² 'On Improvements of the Microscope with the aid of new kinds of optical glass' (Abbe), *Journ. R.M.S.* 1887, p. 25 *et seq.*

Apochromatic Objectives.

	Numerical aperture	Equivalent focus in mm.	Initial magnification	English equivalent focus in inches
Dry series	0.30	24.0	10.5	$\frac{1}{2}$
		16.0	15.5	$\frac{2}{3}$
	0.65	12.0	21	$\frac{1}{2}$
		8.0	31	$\frac{1}{3}$
	0.95	6.0	42	$\frac{1}{4}$
		4.0	63	$\frac{1}{6}$
	3.0	83	$\frac{1}{8}$	
Water immersion	1.25	2.5	100	$\frac{1}{16}$
Homogeneous immersion	1.30	3.0	83	$\frac{1}{8}$
		2.0	125	$\frac{1}{12}$
		1.5	167	$\frac{1}{15}$
	1.40	3.0	83	$\frac{1}{8}$
		2.0	125	$\frac{1}{12}$

Compensating Eye-pieces for English Bodies.

2 4 8 12 18 27

It is of interest to note that Messrs. Powell and Lealand have since produced a remarkable lens on the same system, having a N.A. of 1.50, with a power of $\frac{1}{10}$ th of an inch. Object-glasses are also now made by other makers, English, European, and American, those having fluorite in them being termed apochromatic, while others made of new kinds of glass are called semi-apochromatic. Semi-apochromats are being daily improved, so much so that some recent objectives nearly equal apochromatic objectives themselves.

CHAPTER II

THE PRINCIPLES AND THEORY OF VISION WITH THE
COMPOUND MICROSCOPE

WE are now prepared to enter upon the application of the optical principles which have been explained and illustrated in the foregoing pages to *the construction of microscopes*. These are distinguished as *simple* and *compound*, each kind having its peculiar advantages to the student of nature. Their essential difference consists in this, that in the former, the rays of light which enter the eye of the observer proceed directly from the *object* itself, after having been subjected only to a change in their course, as we have shown by fig. 26, which fully explains the action of the simple lens; whilst in the compound microscope an enlarged *image* of the object is formed by one lens, which image is magnified to the observer by another, as if he were viewing the object itself. In the *compound* microscope not less than two lenses *must* be employed: one to form the enlarged image of the object, immediately over which it is placed, and hence called the *object-glass*; whilst the other again magnifies that image, and, being interposed between it and the eye of the observer, is called the *eye-glass*. A perfect object-glass, as we have seen, must consist of a combination of lenses, and the eye-glass is best combined with another lens interposed between itself and the object-glass, the two together forming what is termed an *eye-piece*. The compound microscope must be the subject of careful and detailed consideration; but it must be remembered that the shorter the focus of the simple magnifying lens, the smaller must be the diameter of the sphere of which it forms part; and, unless its aperture be proportionately reduced, the distinctness of the image will be destroyed by the spherical and chromatic aberrations necessarily resulting from its high curvature. Yet notwithstanding the loss of light and other drawbacks attendant on the use of single lenses of high power, they proved of great value to the older microscopists (among whom Loeuwenhoek should be specially named), on account of their freedom from the errors to which the compound microscope of the old construction was necessarily subject; and the amount of excellent work done by means of them surprises every one who studies the history of microscopic inquiry. An important improvement on the single lens was introduced by Dr. Wollaston, who devised the *doublet*, still known by his name, which consists of two plano-convex lenses, whose focal lengths are in the proportion of one to three or nearly so, having their convex sides directed towards

the eye, and the lens of shortest focal length nearest the object. In Dr. Wollaston's original combination no perforated diaphragm (or 'stop') was interposed, and the distance between the lenses was left to be determined by experiment in each case. A great improvement was subsequently made, however, by the introduction of a 'stop' between the lenses, and by the division of the power of the smaller lens between two (especially when a very short focus is required), so as to form a *triplet*, as first suggested by Mr. Holland.¹ When combinations of this kind are well constructed, both the spherical and the chromatic aberrations are so much reduced that the angle of aperture may be considerably enlarged without much sacrifice of distinctness; and hence for all, save very low powers, such 'doublets' and 'triplets' are far superior to single lenses. These combinations took the place of single lenses among microscopists (in this country at least), who were prosecuting minute investigations in anatomy and physiology prior to the vast improvements effected in the compound microscope by the achromatisation of its object-glasses.

Another form of simple magnifier, possessing certain advantages over the ordinary double-convex lens, is that commonly known by the name of the 'Coddington' lens.² The first idea of it was given by Dr. Wollaston, who proposed to apply two plano-convex or hemispherical lenses by their plane side, with a 'stop' interposed, the central aperture of which should be equal to one-fifth of the focal length. The great advantage of such a lens is, that the oblique pencils pass, like the central ones, at right angles to the surface, so that they are but little subject to aberration. The idea was, however, greatly improved upon by Sir D. Brewster, who pointed out that the same end would be much better answered by taking a sphere of glass, and grinding a deep groove in its equatorial part, which should be then filled with opaque matter, so as to limit the central aperture; in other words, Brewster made Wollaston's plano-convex lenses hemispheres. Such a combination gives a large field of view, admits a considerable amount of light, and is equally good in all directions; but its power of definition is by no means equal to that of an achromatic lens, and its working distance is inconveniently small. This form is chiefly useful, therefore, as a hand-magnifier, in which neither high power nor perfect definition is required, its peculiar qualities rendering it superior to an ordinary lens for the class of objects for which a hand-magnifier of medium power is required. Many of the magnifiers sold as 'Coddington' lenses, however, are not really portions of spheres, but are manufactured out of ordinary double-convex lenses, and are therefore destitute of the special advantages of the real 'Coddington.' The 'Stanhope' lens somewhat resembles the preceding in appearance, but differs from it essentially in properties. It is nothing more than a double-convex lens, having two surfaces of unequal curvatures, separated from each other by a

¹ *Transactions of the Society of Arts*, vol. xlix.

² This name, however, is most inappropriate, since Mr. Coddington neither was, nor ever claimed to be, the inventor of the mode of construction by which this lens is distinguished.

considerable thickness of glass, the distance of the two surfaces from each other being so adjusted that when the more convex is turned towards the eye minute objects placed on the other surface shall be in the focus of the lens. This is an easy mode of applying a rather high magnifying power to scales of butterflies' wings, and other similar flat and minute objects, which will readily adhere to the surface of the glass; and it also serves to detect the presence of the larger animalcules or of crystals in minute drops of fluid, to exhibit the 'eels' in paste or vinegar &c. A modified form of the 'Stanhope' lens, in which the surface remote from the eye is plane instead of convex, has been brought out in France under the name of 'Stanlioscope,' and has been especially applied to the enlargement of minute pictures photographed on its plane surface in the focus of its convex surface. A good 'Stanlioscope,' magnifying from 100 to 150 diameters, is a very convenient form of hand-magnifier for the recognition of diatoms, infusoria, &c., all that is required being to place a minute drop of the liquid to be examined on the plane surface of the lens and then to hold it up to the light. But no hand lenses we have yet seen will compare with the Steinheil 'loups' of six and ten diameters made by Zeiss, and Reichart's pocket loupes.

For the ordinary purposes of microscopic dissection *single lenses* of from 3 inches to 1 inch focus answer very well. But when higher powers are required, and when the use of even the lower powers is continued for any length of time, great advantage is derived from the employment of achromatic combinations, now made expressly for this purpose by several opticians. The Steinheil combinations give much more light than single lenses, with much better definition, a very flat field, longer working distance (which is very important in minute dissection), and, as a consequence, greater 'focal depth' or 'penetration,' i.e. a clearer view of those parts of the object which lie above or below the exact focal plane. And only those who have carried on a piece of minute and difficult dissection through several consecutive hours can appreciate the advantage in comfort and in *diminished fatigue of eye* which is gained by the substitution of one of these achromatic combinations for a single lens of equivalent focus, even where the use of the former reveals no detail that is not discernible by the latter.



FIG. 29.—The Brücke lens.

Although not strictly its position, it is convenient here to refer to what is known as the 'Brücke lens'; it is much used on the Continent, but does not appear in any English treatise we have seen. It has two achromatic lenses for the objective, and a concave eye lens. It is illustrated in fig. 29.

To remedy the inconvenience of the lens being too close to the object in all but low powers, Charles Chevalier, in his 'Manuel du Micrographe' (1839), proposed to place above a doublet a concave achromatic lens, the distance of which could be varied at pleasure. The effect of this combination is to increase the magnifying power and lengthen the focus. Thus arranged, this instrument will

be the most powerful of all simple microscopes, and the space available for scalpels, needles, &c. will be much greater than with a doublet alone. The further the concave lens is removed from the latter, the greater will be the amplification.¹ Even in this, however, Chevalier had been anticipated by Professor Joblot in 1718.

This combination, applied to lenses for examining the eye and skin, allows the use of doublets which leave a considerable distance above the object, and it is this idea which has governed the construction of the Brücke lens.

‘The lens has a very long focus, and the construction is that of the Galileo telescope as applied to opera-glasses, but the amplification of the objective is much greater than that usually obtained in opera-glasses. The focus is about 6 cm., and the power three to eight times. The latter power is obtained by lengthening the tube, by which means the distance between the two lenses is much enlarged, and the amplification increased without inconveniently modifying the focus.’

This lens may be used in place of the body of a compound microscope, when it is desired to dissect or to find small objects, or it can be adapted to a simple microscope or lens-holder, with from 3 to 8 cm. between the object and objective. But the Brücke lens, like the Galilean opera glass, has a very small field.

Compound microscope.—The compound microscope, in its most simple form, consists of only two lenses, the *object-glass* and the *eye-glass*, and is a Keplerian telescope adapted for viewing very near objects. The former receives the light-rays direct from the object brought into near proximity to it, and forms an enlarged but *inverted* and *reversed* image at a greater distance on the other side; whilst the latter receives the rays which are diverging from this image, as if they proceeded from an object actually occupying its position and enlarged to its dimensions, and brings these to the eye, so altering their course as to make that image appear far larger to the eye, precisely as in the case of the simple microscope. It is obvious that, in the use of the very same lenses, a considerable variety of magnifying power may be obtained by merely altering their position in regard to each other and to the object. For if the eye-glass be carried farther from the object-glass, whilst the object is approximated nearer to the latter, the image will be formed at a greater distance from the object-glass, and the dimensions of the magnified image will consequently be augmented; whilst, on the other hand, if the eye-glass be brought nearer to the object-glass, and the object removed further from it, the distance of the image from the object-glass will be less than it was before, and the dimensions of the magnified image will be correspondingly diminished. The amplification may also be varied by altering the magnifying power of the eye-pieces. In practice, variations in power must be obtained by altering either the objective or the eye-piece, or both, and the use of the draw-tube for this purpose must be altogether abandoned, because objectives are

¹ Robin, C., *Traité du Microscope et des Injections*, 2nd ed. 8vo. pp. 33, 34. Paris, 1887.

corrected for a certain length of draw-tube, and, in order that they may work efficiently, that definite length of draw-tube must be maintained.

In general it is not advisable to use with an achromatic objective a greater super-amplification than can be obtained with a 10-power eye-piece, or with an apochromatic objective that yielded with a 12 or 18 power one.

We shall facilitate the comprehension by the student of the principles of the modern form of a compound microscope by means of fig. 30. In this figure the optical portion, that is, the objective and eye-piece, are drawn to the full size, but the distance between these has, from the exigencies of space, been much curtailed. A low-power objective has been specially chosen for simplicity, and a compensating eye-piece (*vide* Chapter V.) has been introduced to show its form and mode of action.

The objective is a copy of an old Ross 1-inch of 1856. The incident front (that is, the lens on which the incident beams from the object first strike) is a convex of long radius; the incident surface of the flint lens of the back combination is a concave of very long radius, being in fact about twenty inches.

The object F has only rays drawn from one side in order that a clearer perception of the path of the rays may be seen. This pair of rays passes from the arrow (object) through the combination of lenses forming the objective, giving an *inverted* real image at A B. This image, in fact, has a convex curve towards the eye-piece: this is a position that will tend to increase the curvature of the virtual image C D given by the eye-piece, the inverted image (A B) at the diaphragm of the eye-piece being the subject of still further and often great magnification.

In addition to the two lenses of which the compound microscope may be considered to essentially consist, it was soon found needful to introduce another lens, or a combination of lenses, between the object-glass and the image formed by it, the purpose of this being to change the course of the rays in such a manner that the image may be formed of dimensions not too great for the whole of it to come within the range of the eye-glass. As it thus allows more of the object to be seen at once, it has been called the *field-glass*; but it is now usually considered as belonging to the ocular end of the instrument, the *eye-glass* and the *field-glass* being together termed the *eye-piece*, or *ocular*. Various forms of this eye-piece have been proposed by different opticians, and one or another will be preferred according to the purpose for which it may be required. That which, until the construction of the compensation eye-pieces by Abbe, was considered the most advantageous to employ with achromatic object-glasses, to the performance of which it is desired to give the greatest possible effect, was termed the *Huyghenian*, having been employed by Huyghens for his telescopes, although without the knowledge of all the advantages which its best construction renders it capable of affording. This eye-piece, with others, will be considered in detail in the chapter (v.) given in part to their consideration; but this eye-piece consists of two plano-convex lenses, with their plane sides

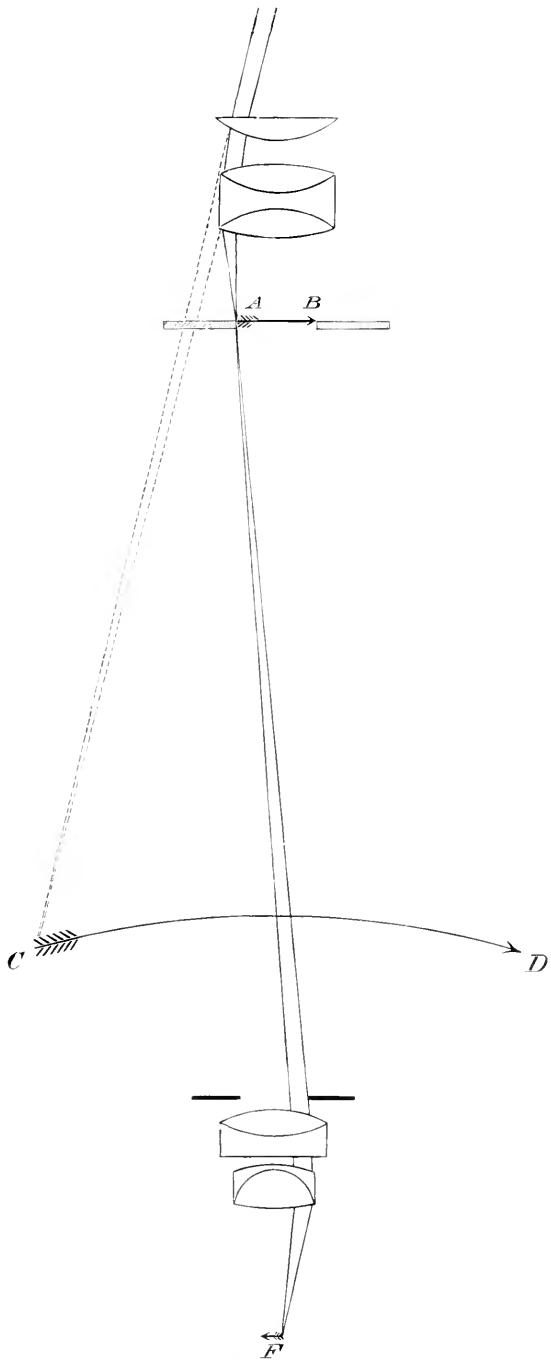

FIG. 30.—Path of a ray of light through a modern combination of lenses for compound microscope.

towards the eye. A 'stop' or diaphragm, B B, must be placed between the two lenses, in the visual focus of the eye-glass, which is, of course, the position wherein the image of the object will be formed by the rays brought into convergence by their passage through the field-glass. Huyghens devised this arrangement merely to diminish the spherical aberration; but it was subsequently shown by Boscovich that the chromatic dispersion was also in great part corrected by it. With the apochromatic lenses of the highest and best quality (see Chapter V.) no amount of obtainable eye-piecing, if it be of the 'compensation' form, can break down the image. The editor has tried in vain to break down the image formed by a 24 mm., a 12 mm., a 6 mm., and a 4 mm., all dry apochromatics by Zeiss, and especially with a $\frac{1}{4}$ th by Powell and Lealand. It is, however, a matter of moment and interest to note that with *good* objectives of the ordinary achromatic construction of large N.A. the compensating eye-pieces give better results than Huyghenian.

But of the old form of achromatic object-glass it is true of the majority that they will not bear high eye-piecing. 'B,' $1\frac{1}{3}$ inch in focus, is a convenient and useful eye-piece for viewing large flat objects, such as transverse sections of wood or of echinus-spines, under low magnifying powers. A flat large field may be obtained by means of a Kellner; but, on the other hand, there is a very serious falling off of defining power, which renders the Kellner eye-piece unsuitable for objects presenting minute structural details; and it is an additional objection that the smallest speck or smear upon the surface of the field-glass is made so unpleasantly obvious that the most careful cleansing of that surface is required every time that this eye-piece is used. Hence it is better fitted for the occasional display of objects of the character already specified than for the scientific requirements of the working microscopist.

A 'positive' or Ramsden's eye-piece—in which the field-glass, whose convex side is turned upwards, is placed so much nearer the eye-glass that the image formed by the objective lies below instead of above it—is sometimes used for the purpose of micrometry, a divided glass being fitted in the exact plane occupied by the image, so that its scale and the image are both magnified together by the lenses interposed between them and the eye. The same end, however, is also attained with the Huyghenian eye-piece, and it is doubtful if any advantage is gained by the Ramsden in microscope work. The compensating eye-piece is also used in conjunction with the micrometer.

Aperture in microscopic objectives and the principles of microscopic vision.—It is now of the utmost moment that we should understand clearly the meaning and importance of 'aperture' in microscopic objectives, and by that means be led to a perception of the principles of the most recent and only rational theory of microscopic vision. Within the last twenty-five years this entire subject has undergone a rigorous and exhaustive reinvestigation by one of the most competent and masterly mathematical and practical

opticians in the world, Professor Abbe of Jena; and, as a result, some of the judgments and opinions, as well as what were supposed to be established truths, depending apparently upon the simplest principles, and not believed to be open to change, have been shown to be absolutely without foundation; while principles hitherto quite unknown and unsuspected have been shown to operate and to rest on clearly demonstrable mathematical and physical bases. The result has been a complete revolution of what were held to be fundamental principles of microscopic optics and the theory of vision with microscopic object-glasses.

Professor Abbe contends that one of the foremost errors relates to the mode in which microscopic images are formed. It was assumed that their formation took place on ordinary dioptric principles. As the camera or the telescope formed images, so it was assumed that the image in the compound microscope was brought about. The delicate and complex structure of an insect's scale or of a diatom were believed to form their images according to the same precise dioptric laws by which the image of the moon or Mars is formed in the telescope. Hence it was taken for granted that every function of the microscope was determined by the geometrically traceable relations of the refracted rays of light. We would nevertheless remark that visibility of detail in, for example, the moon depends on the aperture of the telescope: of course, what is known as its 'aperture' is simply estimated by the diameter of the object-glass, but accuracy appears to require that $u \sin u = a$ ought to be applied to the telescope. In practice the diameter is taken conventionally for the sake of simplicity, as it makes no numerical difference, because the sines of small angles such as are dealt with in the telescope are proportional to the angles themselves. The microscope, on the other hand, deals with large angles: consequently the sine cannot be dispensed with.

But Professor Abbe argues that a close examination in theory and practice of the conditions of vision with microscopic objectives shows that such an estimate of aperture is wholly wrong in principle. The front lens of a $\frac{1}{2.5}$ -in. objective may be no more than the $\frac{1}{50}$ th of an inch in diameter, while a 3-in. objective may have a diameter of half an inch. Yet it is the smaller lens that has by far the larger 'aperture.'

Light is dispersed from every point on the surface of an object in all directions up to 180° . Only an extremely narrow pencil of this can be received by the human eye, a large pencil of light emanating from the object being lost on each side of what the eye receives. The apparent problem of practical optics is to be able, by means of lenses, to gather up and bring to a focus as many of the unadmitted rays as possible. The general manner in which lenses act in doing this we have endeavoured in an elementary manner to show.

Soon after achromatic object-glasses were first made, Dr. Goring found that the markings on special objects—such as the scales of the wings of insects—could be seen by some object-glasses, while with others, although the magnifying power was equal, it was in-

possible to discern them. In every case the greater 'angle' was shown to possess the greater 'resolving' or delineating power; and this led to the important conclusion that power of 'resolution' in a lens was dependent upon 'angular aperture.'

This, however, was at a time when only 'dry' objectives were in use; the immersion and homogeneous systems, as we use them, were unknown.

But (as we shall subsequently see), even with objectives employed only with air, the angle of the radiant pencil did not afford a true comparison; when immersion objectives were introduced—objectives in which water or cedar oil replaced the air between the objective and the upper surface of the cover of the mounted object—the use of *angles* of aperture became in the utmost degree misleading; for different media with different refractive indices were employed, and the *angle* of the radiant pencil was supposed not only to admit of a comparison of two apertures in the same medium, but also to be a standard of comparison when the media were different. It was, in short, believed that an angle of 180° in air represented a large excess of aperture in comparison with 96° in water and 82° in balsam or oil, denoting, in reality, what was believed to be the *maximum* aperture of any kind of objective, which could not, it was held, be exceeded, but only equalled, by 180° in water or oil; in other words, that a radiant pencil has exactly the *same* value, when the *angles* are equal, no matter what the refractive index of the medium through which the pencil might be passing.

But to a thorough physical and mathematical study of the question such as that in which Professor Abbe engaged, it soon became apparent that even in the same medium the only exact method of comparison for objectives—when the fundamental phenomena of optics (which the older opticians had disregarded) were taken into account—was not a comparison by the angles of the radiant pencils only, but a comparison by their sines; while, when the media are different, the indices of those media would be found to form an essential factor in the problem; for an angle of 180° in air is equal to 96° in water or 82° in oil; hence three angles might all have the same number of degrees and yet denote different values, according as they were in air, water, or oil.

Thus there might be large divergence of *aperture* in two or more cases while the *angle* was identical, and from this the greatest confusion was not only possible but was realised.

A solution of the difficulty was (as we have indicated above) discovered by Professor Abbe; and it is to Mr. Frank Crisp's lucid exposition of Abbe's elaborate monographs that the English student is immensely indebted.¹

The definition of 'aperture' in its legitimate sense of 'opening' is shown by Abbe to be obtained when we compare the diameter of

¹ 'On the Estimation of Aperture in the Microscope' (Abbe), *Journ. R.M.S.* ser. ii, vol. i. 388; 'Notes on Aperture, Microscopical Vision, and the Value of wide-angled Immersion Objectives,' *ibid.* 303; 'The Aperture of Microscope Objectives,' *English Mechanic*.

the pencil *emergent* from the objective with the focal length of that objective.

It will be desirable to explain somewhat more in detail how this conclusion is arrived at, as given in Professor Abbe's papers.

Taking in the first case a *single-lens* microscope, the number of rays admitted within one meridional plane of the lens evidently increases as the diameter of the lens (all other circumstances remaining the same), for in the microscope we have at the back of the lens the same circumstances as are in front in the case of the telescope. The larger or smaller number of emergent rays will therefore be properly measured by the clear diameter; and, as no rays can *emerge* that have not first been *admitted*, this must also give the measure of the admitted rays.

Suppose now that the focal lengths of the lenses compared are not the same—what, then, is the proper measure of the rays admitted?

If the two lenses have equal openings but different focal lengths, they transmit the same number of rays to equal areas of an image at a definite distance, because they would admit the same number if an object were substituted for the image—that is, if the lens were used as a telescope-objective. But as the focal lengths are different, the amplification of the images is different also, and equal areas of these images correspond to different areas of the object from which the rays are collected. Therefore the higher-power lens, with the same opening as the lower power, will admit a *greater* number of rays in all from the same object, because it admits the *same* number as the latter from a *smaller* portion of the object. Thus, if the focal lengths of two lenses are as 2 : 1, and the first amplifies N diameters, the second will amplify $2N$ with the same distance of the image, so that the rays which are collected to a given field of 1 mm. diameter of the image are admitted *from* a field of $\frac{1}{N}$ mm. in the first case and of $\frac{1}{2N}$ mm. in the second. Inasmuch as the 'opening' of the objective is estimated by the diameter (and not by the area), the higher-power lens admits *twice* as many rays as the lower power, because it admits the *same* number from a field of *half* the diameter, and in general the admission of rays with the same opening but different powers must be in the inverse ratio of the focal lengths.

In the case of the single lens, therefore, its aperture must be determined by *the ratio between the clear opening and the focal length*, in order to define the same thing as is denoted in the telescope by the *absolute* opening.

Consider now the compound objective—the most important case in the microscope. What is the opening of this composite system? We must adhere to the diameter of the admitted cone at that plane where it has its *ultimate maximum value*, which is obviously the diameter of the pencil at its emergence, from the system, or, practi-

cally, the *clear, effective diameter of the back lens*. The emergent pencil from a microscope-objective converging to a relatively distant focus has its rays approximately parallel, and the conditions are once more similar to those of the telescope-objective on the side of the object. The diameter of this emergent pencil, whether it emerges from a single lens or from a composite system, must therefore always have the same signification. The influence of the power on focal length also remains the same as in the case of the single lens. An objective with a focal length equal to half that of another admits, with the same linear opening, twice as many rays as the latter, because the amplification of the image at one and the same distance is doubled, and the same number of rays consequently are admitted by the higher power from a field of half the diameter. And this will hold good whether the medium around the object is the same in the case of both objectives or different; for an immersion system and a dry system always give the *same* amplification when the focal length is the same.

Thus we arrive at the general proposition for all kinds of objectives. First, when the power is the same, the admission of rays varies with the diameter of the pencil at its emergence. Secondly, when the powers are different the *same admission* requires *different openings* in the proportion of the focal lengths, or, conversely, with the *same opening the admission is in inverse proportion* to the focal length—that is, the objective which has the wider pencil relatively to its focal length has the larger aperture.

Thus we see that, just as in the telescope the absolute diameter of the object-glass defines the aperture, so in the microscope the ratio between the utilised diameter of the back lens and the focal length of the objective defines its aperture.

This definition is clearly a definition of aperture in its primary and only legitimate meaning as ‘opening’—that is, the capacity of the objective for admitting rays from the object and transmitting them to the image; and it at once solves the difficulty which has always been involved in the consideration of the apertures of immersion objectives.

So long as the angles were taken as the proper expression of aperture, it was difficult for those who were not well versed in optical matters to avoid regarding an angle of 180° in air as the maximum aperture that any objective could attain. Hence, water-immersion objectives of 96° and oil-immersion objectives of 82° were looked upon as being of much *less* aperture than a dry objective of 180° , whilst, in fact, they are all *equal*, that is, they all transmit the same rays from the object to the image. Therefore, 180° in water and 180° in oil are unequal, and both are much larger apertures than the 180° which is the maximum that the air objective can transmit.

If we compare a series of dry and oil-immersion objectives, and, commencing with very small air-angles, progress up to 180° air-angle, then taking an oil-immersion of 82° and progressing again to 180° oil-angle, the ratio of opening to power progresses continually

also, and attains its maximum, not in the case of the air-angle of 180° (when it is exactly equivalent to the oil-angle of 82°), but is greatest at the oil-angle of 180° .

If we assume the objectives to have the same power throughout, we get rid of one of the factors of the ratio, and we have only to compare the diameters of the emergent beams, and can represent their relations by diagrams. Fig. 31 illustrates five cases of different apertures of $\frac{1}{4}$ -in. objectives—viz. those of dry objectives of 60° , 97° , and 180° air-angle, a water-immersion of 180° water-angle, and an oil-immersion of 180° oil-angle. The inner dotted circles in the two latter cases are of the same size as that corresponding to the 180° air-angle.

A dry objective of the full maximum air-angle of 180° is only able (whether the first surface is plane or concave) to utilise a diameter of back lens equal to twice the focal length, while an immersion lens of even only 100° (in glass) requires and utilises a *larger* diameter, i.e. it is able to transmit more rays from the object to the image than *any* dry objective is capable of transmitting. Whenever the angle of an immersion lens exceeds twice the critical angle for the immersion-fluid, i.e. 96° for water or 82° for oil, its aperture is in excess of that of a dry objective of 180° .

Having settled the principle, it was still necessary, however, to find a proper notation for comparing apertures. The astronomer can compare the apertures of his various telescopes by simply expressing them in inches; but this is obviously not available to the microscopist, who has to deal with the *ratio* of two varying quantities.

Professor Abbe here again conferred a boon upon microscopists by his discovery (in 1873, independently confirmed by Professor Helmholtz shortly afterwards) that a general relation existed between the pencil admitted into the front of the objective and that emerging from the back of the objective, so that the ratio of the semi-diameter of the emergent pencil to the focal length of the objective could be

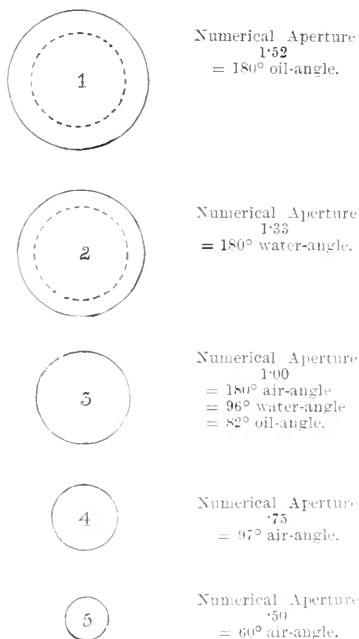

FIG. 31.—Relative diameters of the (utilised) back lenses of various dry and immersion objectives of the same power ($\frac{1}{4}$) from an air-angle of 60° to an oil-angle of 180° .

expressed by the sine of half the angle of aperture (u)¹ multiplied by the refractive index of the medium (n) in front of the objective, or $n \sin u$ (n being 1.0 for air, 1.33 for water, and 1.5 for oil or balsam).

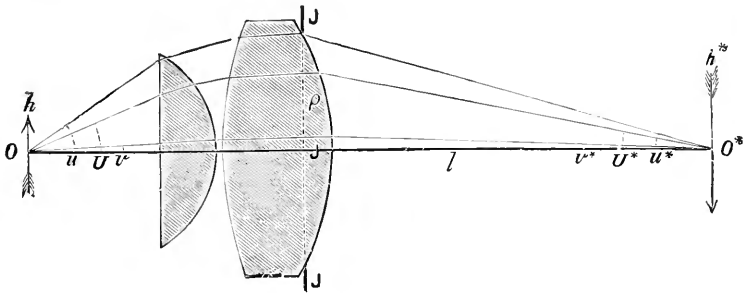

FIG. 32.—Illustration of the law of consequence for aplanatic systems.

Let O and O* (fig. 32) be the conjugate aplanatic foci of a wide-angled system ; u , U the angles of inclination of *any two* rays admitted

¹ In the original translation of the papers of Professor Abbe from German into English the German mathematical symbols have been retained. In the summary of

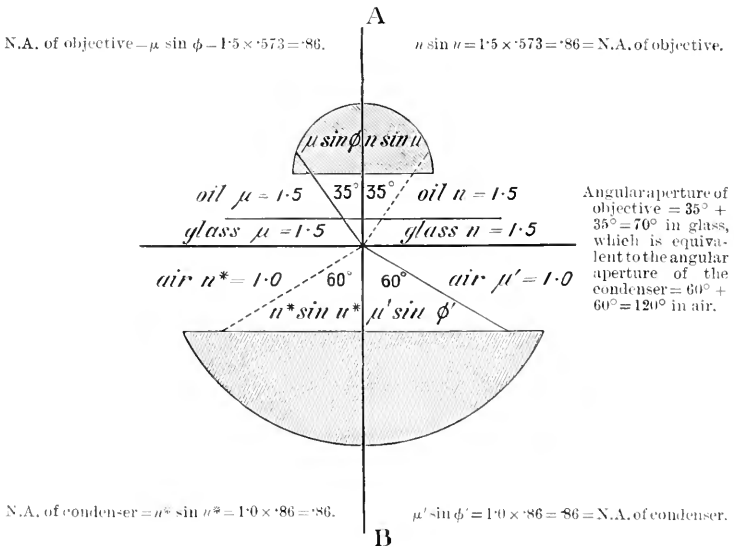

FIG. 31.—Identity of $n \sin u$ (German math. form) with $\mu \sin \phi$ (English). Also N.A. and angular aperture.

Abbe's theories and demonstrations presented in the following pages the Editor has scarcely felt justified in altering this, especially as the German form of symbol ob-

from the radiant, and u^* , U^* the angles of the same rays on their emergence; then we shall have always

$$\sin U^* : \sin u^* :: \sin U : \sin u ;$$

or,

$$\frac{\sin U^*}{\sin U} = \frac{\sin u^*}{\sin u} = \text{const.} = c ;$$

that is, the *sines* of the angles of the conjugate rays on both sides of an *aplanatic* system always yield one and the same quotient c , whatever rays may be considered, so long as the same system and the same foci are in question.

This proposition holds good for every arrangement of media, and refracting surfaces that may go to the composition of the system, and for every position of object and image. It is the law upon which depends the delineation of an image by means of wide-angled pencils.

When, then, the values in any given cases of the expression $n \sin u$ (which is known as the 'numerical aperture' and expressed by N.A.) has been ascertained, the objectives are instantly compared as regards their aperture, and, moreover, as 180° in air is equal to 1.0 (since $n=1.0$ and the sine of half 180° or $90^\circ=1.0$), we see with equal readiness whether the aperture of the objective is smaller or larger than that corresponding to 180° in air.

Thus, suppose we desire to compare the relative aperture of three

tains in our Universities, and is thoroughly understood amongst University men. But to those unaccustomed to mathematical formulae confusion might easily arise from the juxtaposition of different symbols meaning precisely the same thing. To meet the possible necessity of these this footnote is inserted with an accompanying diagram to illustrate the identity of ' $n \sin u$ ' with ' $\mu \sin \phi$ '.

The student who has mastered Snell's Law of Sines, given and illustrated on p. 3 (fig. 1), will by a glance at the figure A1 on p. 48 understand the meaning and importance of the expression 'N.A.' (numerical aperture) and at the same time will grasp wherein it differs from 'angular aperture' (*q.v.*). He will also perceive how it comes to pass that an angular aperture of 70° in *glass* is equivalent to an angular aperture of 120° in *air*.

In the figure the upper hemispherical lens represents the *front* of a homogeneous immersion objective. It is supposed to be focussed on an object in contact with the lower side of a cover-glass. Between the plane front of the lens and the upper surface of the cover-glass is a drop of oil of cedar-wood, whose refractive index is 1.5, being thus identical with the cover-glass and the front lens.

It is understood that no slip is used, and that there is nothing between the object and the front lens of the condenser.

In this case the axis A B is the *normal* (p. 5, fig. 2); on the left-hand side there is a ray which makes an angle of 35° with the normal in glass issuing into air on the right-hand side of the normal. By Snell's formula (p. 3)—

$$\begin{aligned} \mu \sin \phi &= \mu' \sin \phi'; \\ \sin \phi' &= \frac{\mu \sin \phi}{\mu'} = \frac{1.5 \times .573}{1.0} = .86; \\ \phi' &= 60^\circ \text{ (from Table I.)} \end{aligned}$$

Therefore the ray on emerging from the under surface of the cover-glass will make an angle of 60° from the normal.

The dotted lines show the path of the ray *where the German symbols are used*.

$$\begin{aligned} n \sin u &= n^* \sin u^*; \\ \sin u^* &= \frac{n \sin u}{n^*} = \frac{1.5 \times .573}{1.0} = .86, \\ u^* &= 60^\circ \text{ (from Table I.)} \end{aligned}$$

Numerical aperture, therefore, is the sine of half the *angular aperture* multiplied by the refractive index of the medium.

It will be observed that the rays passing through the oil of cedar enter the front lens without refraction: this is due to the fact that the media in which the rays are travelling are of the same refractive index, i.e. they are homogeneous.

objectives, one a dry objective, the second a water-immersion, and the third an oil-immersion. These would be compared on the angular aperture view as, say, 74° air-angle, 85° water-angle, and 118° balsam-angle; so that a calculation must be worked out to arrive at a due appreciation of the actual relation between them. Applying, however, 'numerical' aperture, which gives $\cdot60$ for the dry objective, $\cdot90$ for the water-immersion, and $1\cdot30$ for the oil-immersion, their relative apertures are immediately appreciated, and it is seen, for instance, that the aperture of the water-immersion is somewhat less than that of a dry objective of 180° , and that the aperture of the oil-immersion exceeds that of the latter by 30 per cent.

When these considerations have been appreciated, the advantage possessed by immersion in comparison with dry objectives is no longer obscured. Instead of this advantage consisting merely in increased working distance or absence of correction-collar, it is seen that a wide-angled immersion objective has a larger aperture than a dry objective of the maximum angle of 180° ; so that for any of the purposes for which aperture is desired an immersion must necessarily be preferred to a dry objective.

1. There exists then a definite ratio between the linear opening and the focal length of a system, which must be entirely independent of the composition and arrangement of the system, and solely determined by the above-mentioned aperture equivalent of the admitted cone of rays. When the equivalent is the same we have always the same proportion of opening to focal length, whatever may be the particular arrangement of refracting media in the system.

2. If the objectives whose apertures are compared work in the *same* medium, and admit angles of, say, 60° , 90° , 180° , their apertures are not in the ratios of those numbers, but are as $\cdot50$, $\cdot70$, and $1\cdot0$. The 180° , for instance, does not represent *three* times the aperture of the 60° , but *twice* only.

3. If the objectives work in *different* media, as air and oil, the latter may have an aperture exceeding that of a dry objective of 180° angle. For with the dry objective the refractive index (n) and the sine of half the maximum angle (u) both = 1, so that $n \sin u = 1$ also, whilst with the immersion objective n is greater than 1 (say $1\cdot5$ for oil), and the angle u may therefore be much less than in the case of the dry objective, and yet the value of the expression $n \sin u$ (i.e. the aperture) may be greater than $1\cdot0$.

The two latter deductions are so directly opposed to what was accepted by the older opticians and microscopists that a closer if brief consideration of some of the points which bear upon this branch of the subject may here be serviceably summarised.

Take, first, the case of the medium being the same.

Difference of aperture involves a different *quantity of light* admitted to the objective provided all other circumstances are equal. Hence the question of aperture leads to the consideration of the *photometrical* equivalent of different apertures or aperture angles. It is not of the essence of the problem, but it affords an additional *illustration* of numerical aperture, and is thus of great service in its exposition. It is manifest that aperture cannot be based on quantity

of light alone—more light can always be obtained in the image by throwing more upon the object—but no increase in the amount of illumination can make a dry lens equal in performance as regards aperture to a wide-angled immersion lens.

The popular notion of a pencil of light may be illustrated by fig. 33, which assumes that there is equal intensity of emission in all directions, and that the intensity of a portion of the pencil taken close to the perpendicular is identical with that of another portion of equal angular extension, but more removed from the perpendicular. On this view, therefore, the *quantity of light* contained in any given pencils may be compared by simply comparing the contents of the solid cones.

When, however, *aperture* is considered, and the values of $n \sin a$ are worked out for particular cases, they are seen to differ from

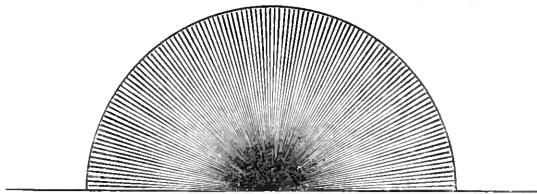

FIG. 33.—Diagram showing erroneous inference as to the intensity of emitted rays.

those obtained by estimating in the above manner the amount of light in the solid cones, and some perplexity naturally arises from the supposition that the measure of the aperture of the objective does not correspond to that of the quantity of light which it admits.

All this arises from the mistaken assumption that a luminous pencil is properly represented by fig. 33.

In the last century (1760) Bouguet¹ and Lambert² established the important fact that with any surface of *uniform radiation* the intensity of the emitted rays is *not* the same in all directions. The *power of emission* and the intensity of the rays (i.e. the quantity of light emanating from a given surface-element within a cone of given narrow angle) varies in the proportion of the *cosine* of the angle of obliquity under which the ray is emitted: in other words, in the proportion of the *cosine* of the angle of deflection from the perpendicular to the luminous surface under

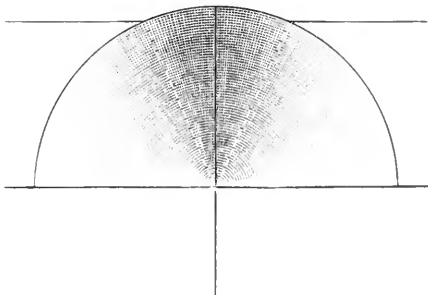

FIG. 34.—The intensity of emitted rays is not the same in all directions.

¹ *Traité d'Optique sur la Gradation de la Lumière*, 1760.

² *Photometria*, 1760.

which the ray is sent out. The rays are more intense in proportion as they are inclined to the surface which emits them, so that a pencil varies in proportion as it is taken close to or is removed from the perpendicular. A pencil is not, therefore, correctly represented by fig. 33, but by fig. 34, the density of the rays decreasing continuously from the vertical to the horizontal.

Owing to the different emission in different directions, the quantities of light emitted by an element in the same medium in cones of different angle such as w and w' , fig. 35, are not in the ratio of the solid cones, as would be the case with equal emission, but in the ratio of the squares of the sines of the semi-angles so that the squares of the sines of the semi-angles constitute the true measure of the quantity of light contained in any solid pencil.

When, therefore, the medium is the same, it is seen that there

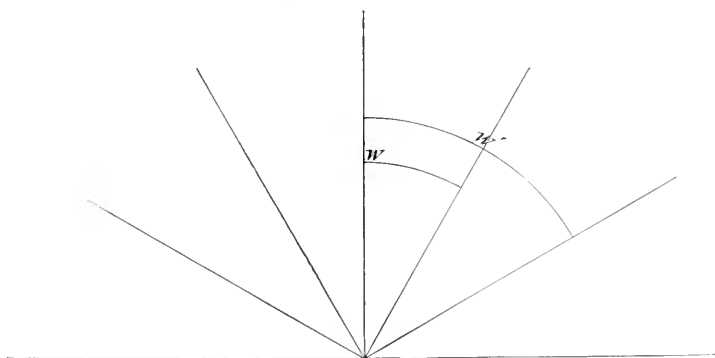

FIG. 35.—The unequal emission of rays.

is no contradiction between the measure of the aperture of an objective ($\mu \sin u$) and that of the quantity of light admitted by it the latter being $(\mu \sin u)^2$.

The simplest experimental proof of the unequal emission in different directions will be found in the fact that the sun, the moon the porcelain globe of a lamp or any other bright spherical object with so-called uniform radiation in all directions, is seen projected as a surface of *equal* brightness. If there were equal intensity of emission in all directions, what would be the necessary result? Compare two equal portions of the surface, one, a (fig. 36), perpendicular to the line of vision, and the other, b , greatly inclined. Every infinitesimal surface-element of b sends to the pupil of the eye a cone of the same angle u' , as a similar point of a (the slight difference of the distance from the eye being disregarded). If the intensity of the rays were equal as supposed, the whole area b would send to the eye the same quantity of light as the equal area a , since both areas contain exactly the same number of elements. But the *whole* quantity of light from b would be projected upon a smaller area of the retina than that from a (as b appears under a smaller visual angle, being diminished according to the obliquity, or

as $1 : \cos w$). Consequently, if the assumption were true, b must appear to be brighter than a , and the sphere would show increasing brightness from the centre to the circumference. Close to the margin the increase ought to be very rapid, and the brightness a large multiple of that at the centre.

This, as is well known, is not the case, the projection of the sphere showing equal brightness. The quantity of light, therefore, emitted from b within a given small solid cone w' in an oblique direction must be less than that which is emitted from a within an equal solid cone u in a perpendicular direction, and the intensity of the rays must decrease in the proportion of $1 : \cos w$ when the obliquity w increases.

As then in one and the same medium the number of rays conveyed by a pencil and the photometrical quantity of light are proportional, this theorem of Lambert, established for more than a century, is sufficient of itself to overthrow the very basis of the *angular* expression of aperture, and to prove that, when we are dealing with one and the *same medium* only, the *angle* is not the sufficient expression, but that it is the *sine of the semi-angle* which must be taken.

We may pass now to the case of the media being *different*, as air and oil, and comparing the aperture of a dry objective of 180° with that of an oil-immersion objective of 100° , the values of $u \sin u$ (or the 'numerical' aperture) give 1.0 for the former and 1.17 for the latter, which is therefore represented to have a *larger* aperture than a dry objective of the greatest possible angle.

In this case also considerable perplexity has arisen. It has been assumed that the total amount of light emitted from a radiant point under a given fixed illumination must be the same, whether the point is in air, water, or oil, and that that being so, the 180° admitted by the dry objective must represent a maximum quantity of light, a 'whole' which cannot be exceeded, but only equalled, by a water- or oil-immersion objective. The numerical aperture notation giving figures in excess of 1.0 (which represents 180° in air) is consequently supposed to be clearly erroneous and misleading. Here the whole difficulty lies in the absolutely false assumption that there is identity of radiation in different media.

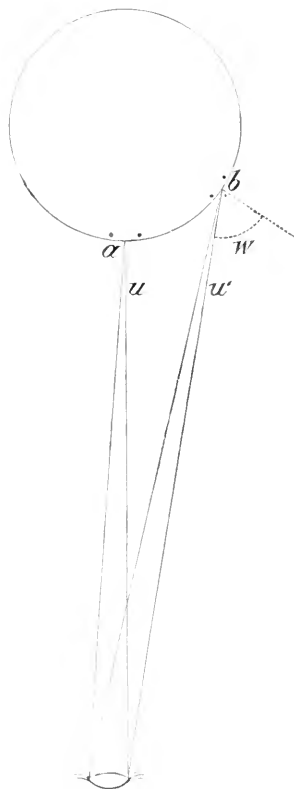

FIG. 36.—Diagram of a bright spherical object emitting light.

In 1864 R. Clausius established, by distinguished research, the proposition¹ that the *power of emission* of a body—in regard to heat as well as light—is *not the same in different media*, but varies in the ratio of the squares of the refractive indices, so that the whole emitted light from any surface-element of a self-luminous body is increased in the proportion of $1 : n^2$ when this body is brought from air into a denser medium of refractive index n . If a glowing body at a constant temperature, such as a bar of iron, could be immersed in a medium of 1.5 refractive index in such a way that the surface were in optical contact with the medium, and the eye of the observer immersed likewise in suitable conditions, the body would be seen *brighter in all directions* in the proportion of 9 : 4 than it appeared in air.

The whole hemisphere of radiation in air is indeed *less* than the whole hemisphere of radiation in water or oil, as the squares of the refractive indices of the media, viz. as 1.0, 1.77, and 2.25.

Thus it is seen that the *quantity of light* emitted from an object under a given illumination is *not* measured by the angle of the emitted cone at the radiant, nor can it be measured in any way by means of the angle *alone*. The quantity depends under all circumstances on *the product of the sine of the semi-angle and the refractive index of the medium in which the object is luminous*, and is expressed by the square of this product, or by the square of the ‘numerical aperture’ of the pencil.

It thus follows that the estimation of the *quantity of light* is found to be in complete accordance with the expression of *aperture*.²

We are now prepared to advance to another point. It was a view very commonly held until recently, that the superiority of immersion objectives over dry ones was confined to the case of the former being used with balsam-mounted objects.

If we have a pencil in air, say 170° , as shown in fig. 37, a dry objective of large aperture will be able to admit it. If, however, the object is in balsam, as in fig. 38, it is no longer possible for so large a pencil to emerge from the balsam. The rays shown by the dotted

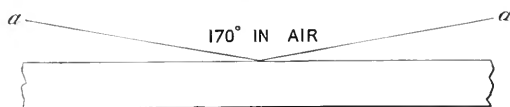

FIG. 37.

lines in fig. 38 will be totally reflected by the cover-glass, and only those within a smaller angle of 82° will pass out. Although these are expanded into 180° on emerging into air, of which the objective takes up 170° , yet this 170° contains, it is supposed, less light than the 170° in fig. 37, as it has been ‘diluted’ by the refraction.

¹ ‘Ueber die Concentration von Wärme- und Lichtstrahlen &c.’ *Pogg. Annalen d. Physik*, cxxi. 1864.

² Fig. A 2 gives a good, practical illustration of the relative illuminating power of objectives of varying apertures, and at the same time affords a simple explanation of the reason why $(n \sin u)^2$ is a measure of this illuminating power. Let the circles A and B represent the backs of two objectives of the same power but of different apertures; then the radii C D and E F will represent the angle $n \sin u$ (or $\mu \sin \phi$) in fig. A 1 (p. 48, note). Now because the areas of circles are to one another in the

A dry objective was therefore supposed to be placed at a disadvantage when used upon balsam-mounted objects, its aperture being supposed to be 'cut down' by the balsam, and the advantage of the immersion objective was considered to rest on the fact that it restored, in the case of the balsam-mounted object, the same conditions as subsisted in the case of the dry-mounted object, allowing as large (but no larger) an aperture to be obtained with the former object as is obtained by the dry objective with the latter.

The error here lies in the assumption of the identity of radiation in air and balsam. If there were in fact any such identity, the

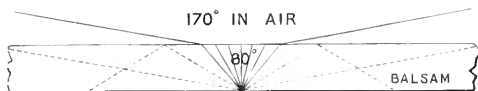

FIG. 38.

conclusion above referred to would, of course, be correct, for if in fig. 37 the *air* pencil of 170° was identical with the *balsam* pencil of 170° (shown by the *dotted lines* in fig. 38), there would necessarily be a relative loss of light in the latter case in consequence of so much of the pencil being reflected back at the cover-glass.

When, however, the increase of radiation with the increase in the refractive index of the medium is recognised, the mistake of the preceding view is appreciated. The 170° in *air* of fig. 37 is not equal to, but much less than, the 170° in *balsam* of fig. 38, and notwithstanding that a great part of the latter does not reach the

proportion of the squares of their radii, it follows that if we designate the radius by $n \sin u$ (or $\mu \sin \phi$), the area of the circle A will be to the area of the circle B as the square of the radius of A is to the square of the radius of B, or as $(n \sin u)^2$ is to $(n' \sin u')^2$.

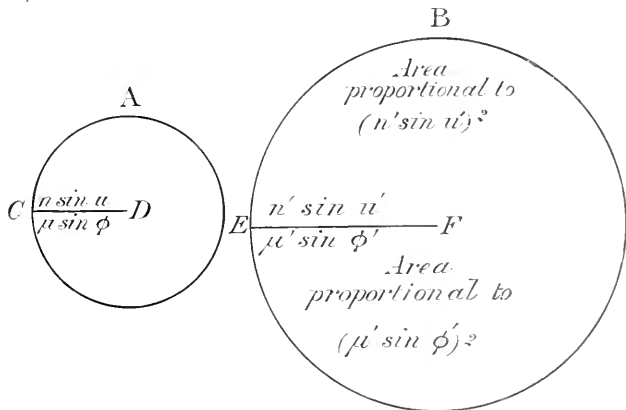

FIG. A 2.—The backs of two objectives of the same power but different apertures.

The student will observe that the radius of B is twice that of the radius of A; consequently the area of B will be four times as great as that of A; which means that, since the numerical aperture of the objective B is twice as great as that of the objective A, its illuminating power will be four times as great.

objective in consequence of total reflection, yet the remainder (80°) which *does* reach it is the exact equivalent of the air-pencil of fig. 37, the two air-pencils of 170° being in all respects identical.

The immersion objective, therefore, which is able to receive the whole *balsam* pencil of 170° (dotted lines in fig. 38), takes up a *greater* quantity of light than the *air* pencil of fig. 37, and so not merely equals the dry objective but surpasses it.

Let it be specially noted that in dealing with the quantity of light in connection with aperture, the idea has not been that we have been engaged with what is in any sense essential, but to remove a difficulty felt by many. It must be clear to all that if a greater aperture signified nothing more than a greater quantity of light, that is to say, if there were no such *specific* difference of the rays which can be utilised by different apertures, as we have demonstrated above, the whole question would be of quite subordinate interest.

Another subject requiring some further elucidation here is the 'different angular distribution of the rays in different media.' The essence of the idea of 'aperture' is *relative opening*. However defined, its significance can only be appreciated by taking into account the image-forming pencil *emergent* from the objective, and the change in its diameter consequent upon the admission of different cones of light. This diameter affords a visible indication of the *number of rays* (not mere quantity of light photometrically, which can be readily varied) which are collected to a given area of the image, and which must have been gathered in by the lens from the conjugate area of the object. If the diameter of the emergent pencil is seen to be increased, whilst the amplification of the image and the focal length are unchanged, it is clear that the objective must have admitted *more rays* from every element of the object because it has collected more to every element of an equally *enlarged* image. Manifestly we get an accurate measure of what is *admitted* into an objective by being able to estimate what it *emits*. It is physically impossible that a system of lenses should emit more light than it has taken in.

Hence 'aperture' means the greater or less capacity of objectives for gathering-in rays from luminous objects.

When the admitted pencil is in the same medium, we see the additional portions of the solid cone from the radiant, which correspond to the additional portions of the enlarging opening. But if in any other case (e.g. where the medium is different) we see that a certain solid cone, A, from a radiant is transmitted through a certain opening, a , and that another solid cone of rays, B, cannot be transmitted through the same opening, a , but requires a wider one, β , whilst all other circumstances, except those of the radiant, have remained the same, we can only conclude that the pencil B must contain rays which are not contained in A, even if the admitted cone is not increased in size. For the additional portion ($\beta - a$) of the wider opening, β conveys rays to the image which are certainly not conveyed by the smaller opening a . From the radiant only can this surplus come, and the pencil B which requires the additional opening must embrace *more rays, even if it should not be of greater angle*.

A given objective may, in fact, collect the rays from a radiant *in*

air almost to the entire hemisphere, and it then utilises a definite opening double its focal length. But when the radiant is in balsam (without any other alteration), the same opening is seen to be utilised by the rays which are within a smaller cone of not more than 82° , and rays which are outside this cone require a surplus opening which is never required for rays in air.

This holds good whether there be refraction or no refraction at the front surface of the system; the difference is based solely on the difference of the medium. Consequently we arrive at the conclusion that the solid cone of 82° in balsam embraces the same rays which, in air, are embraced by the whole hemisphere, and every wider cone in balsam exceeding the 82° conveys *more* rays from the object than are admitted by the whole hemisphere of radiation in air.

It follows, therefore, that the same rays which in air are spread over the whole hemisphere are closed together or compressed in balsam within a narrower conical space of 41° around the perpendicular, and all rays which travel in balsam outside this cone constitute a *surplus of new rays*, which are never met with in air—that is, *are not emitted when the object is in air*. The loss which takes place in the latter case can never be compensated for by increase of illumination because the rays which are lost are *different* rays physically to those obtained by any illumination, however intense, in a medium like air.

In the paper of Professor Abbe there is an elaborate and careful elucidation of this change in the angular distribution of the radiating light when the medium is changed; but to Mr. Crisp's paper on the same subject, giving an exposition and simplification of Abbe's demonstration, the novice will look with the utmost profit.¹ The following extract will give clearness and emphasis to the above deductions of Abbe:—

If we take the case of *refraction*, then one of the most fundamental of optical principles shows that the *same* rays which in air occupy the whole hemisphere are compressed in a medium of higher refractive index within a smaller angle, viz. twice the critical angle. If in fig. 39 the object is illuminated by an incident cone of rays of nearly 82° within the slide, and the slide has air above in the first case and oil in the second, it is obvious that the same ray which is incident on the object at nearly 41° will always emerge in air at an angle of nearly 90° (a'), and in oil at nearly 41° (a''), so that the same rays which in air are expanded over the whole hemisphere are compressed into 82° in oil, and, therefore, rays beyond 82° in oil must represent surplus rays in excess of those found in the air-hemisphere.

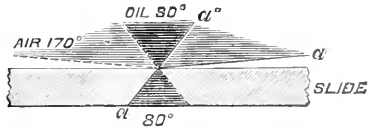

FIG. 39.—Comparative compression of light rays in two different media.

If, on the other hand, the case of *diffraction* is considered, then Fraunhofer's law shows that the same diffracted beams which in air

¹ *Journ. R.M.S.* ser. ii. vol. i. p. 303.

occupy the whole hemisphere (fig. 40) are in oil compressed within an angle of 82° round the direct beam (fig. 41), so that there is room for additional beams.'

The unequal equivalent of equal angles becomes, therefore, a de-

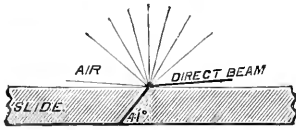

FIG. 40.—Diffracted beams in air.

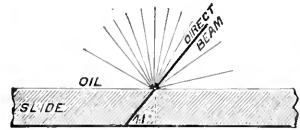

FIG. 41.—Diffracted beams in oil.

monstrated truth—a truth which is capable of experimental proof by every owner of a fair microscope.

Any one possessing a dry object-glass of an aperture of 170° , for example, may readily do so. In this case, α , α , fig. 42, will represent

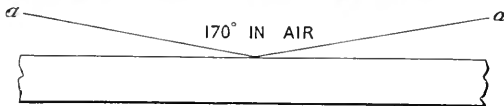

FIG. 42.

the pencil radiating from an object in air, and capable of being taken up by that objective. This pencil, on its emergence from the back lens of the combination, will present a diameter somewhat less than twice the focal length of the objective presented in fig. 43.

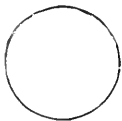

FIG. 43.

But let the object be now placed in Canada balsam and covered in the usual way; the *angle* of the pencil, by the greater refractive power of the medium, will be demonstrably reduced to 80° , as shown in fig. 44. But it will be found, on examination of the *emergent* pencil from the back lens, that this pencil occupies exactly the same diameter (fig. 43) as before. The medium in which

the object is has not, of course, altered the *power* of the objective; and since the diameter of the emergent pencil is the same in both cases, the ratio of 'opening' to focal length, which is the aperture, is the same also. Hence it is seen in the simplest way that *different angles* in media of different refractive indices may

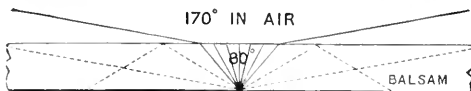

FIG. 44.

denote *equal apertures*, and *equal angles* in different media denote *different apertures*.

That 'immersion' objectives may have greater apertures than the maximum attainable by a dry objective is capable of equally simple proof by accessible experiment.

If an oil-immersion objective of 122° balsam angle be taken, and so illuminated that the whole aperture is filled with the incident rays, and if we use first an object mounted in air, we really find that we

have a *dry* object-glass of nearly 180° angular aperture. This is readily seen by fig. 45. By the arrangement presented in the figure the cover-glass is practically the first surface of the objective, for the front lens, the immersion fluid, and the cover-glass are all homogeneous, and of the same refractive index, and consequently they form a front lens of extra thickness. When the object is close to the cover-glass the pencil radiating from it will be very nearly 180° , and the emergent pencil will be seen to utilise so much of the back lens of the combination as is equal to twice the focal length of the objective, as shown in the *inner* circle of fig. 46.

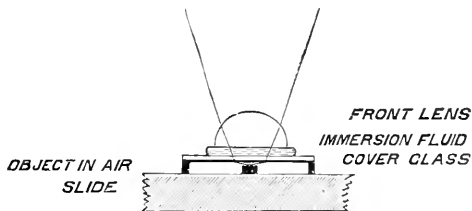

FIG. 45.—Diagram illustrating difference of emerging pencil without and with balsam.

If now we run Canada balsam beneath the cover-glass so as to immerse the object, the pencil taken up by the objective is no longer 180° , but only 122° ; but in spite of that the diameter of the emergent pencil is *larger* than it was when the angle of the pencil was 180° in air, and is represented by the outer circle in fig. 46. In both these cases the power is identical; it follows, therefore, that the greater diameter of the emergent pencil from the back of the combination denotes the greater *aperture* of the immersion objective over that of the dry one, although it possessed an *angle* of 180° . From this escape is impossible, and it is for this reason that opticians make the back lenses of their immersion object-glasses larger than those of dry ones of the same power.

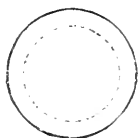

FIG. 46.

Many further illustrations might be given, but none affording greater facility than the following, viz.: 'Select a good specimen of *Amphipleura pellucida* and use oblique illumination, bringing out clearly the striation.

On removing the eye-piece, placing the pupil on the air-image of the diatom, and looking down on the lens, the direct incident beam will be seen emerging as a bright spot, and exactly opposite and *close to the margin* a faint bluish light (see fig. 47). If now a small piece of paper is placed on the back lens of the objective so as to just cover up the blue light, and the eye-piece is replaced, the diatom is still visible, but all the striation which was imaged by the blue marginal light has entirely disappeared. The latter must therefore consist of image-forming rays.'

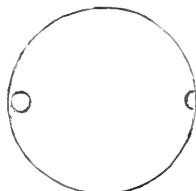

FIG. 47.—Back of lens on removing eye-piece when *A. pellucida* has been resolved, showing spot of bright light and faint bluish spot opposite.

Enough has thus been advanced to enable the student of even the elementary principles of modern object-glass construction to

demonstrate for himself that immersion lenses not only possess an excess of aperture over dry lenses, but that the rays so in excess are image-forming.

The refractive indices of (cedar) oil, water, and air are respectively 1.52, 1.33, and 1.0. 'Angular aperture' claimed that the *angles* of the admitted pencils to lenses of these three constructions expressed equal 'apertures.' But this is a fallacy, now so palpable, but which has exerted an influence so deterrent on the progress of the construction of our higher object-glasses and condensers, that its final disappearance as an unjustified assumption which had crept into the area of theoretical and practical optics, unverified by facts and devoid of the wedding garment of deduction, is a triumph which will make the name of Abbe long and gratefully remembered.

The principle upon which increase of numerical aperture gives increased advantage to an object-glass manifestly needs careful study and elucidation. We have but to refer to the best work done by those who have employed the microscope to any scientific purpose for the past fifty years to discover that there has been an admission, which has steadily strengthened, that by enlargement of aperture an increase in the efficiency of the objective, when well made, was inevitable. During the last thirty-five years this has been especially manifest. To increase the aperture of an objective under the name of greater 'angle' has been *the* special aim of the optician and the constant and increasing desire of all workers with moderate and high powers.

The true explanation of this is quite independent of any consideration of apertures in excess of the maximum in air, and indeed of the whole question of immersion objectives. The old view that all high and excellent results depended on the *angle* at which the light emerged from the object, involving some assumed property of a special kind in the obliquity as such, has been most tenaciously held; but it is an *x* in the problem which has not only never been demonstrated, but the scientific explanations of all the optical properties of lens combinations in the formation of images by means of numerical aperture, prove that it is hopeless to attempt to attach any value to angle *as* angle.

About thirty years ago it presented itself to Professor Abbe as a problem worthy of most careful inquiry as to why great 'angle' or obliquity as such gave to objectives an enhanced capacity in the disclosure of obscure structure. The first step was a consideration of the grounds on which the theory of the value of *angle* of aperture rested. But no such basis was found to exist; no investigation of the question had been made. It was demonstrated that a pencil of 170° would show minuter structure than one of 80° in the same medium; and from *this* a generalisation had been made that upon the obliquity of the 'angle' of light depended the delineating power. *It was taken as a self-evident proposition that the formation of the image in the microscope took place in every particular according to the same dioptric laws by which images are formed in the telescope,* and it was tacitly taken for granted that every function of the

microscope was determined by the geometrically traceable relations of the refracted rays of light.

A prolonged course of able and exhaustive experiments conducted by Abbe showed that, whilst the old view held good in certain cases capable of definite verification, yet that the vast majority of objects, and especially those with which the highest qualities of an objective are called into operation, the production of the microscopic image is wholly and absolutely dependent, not upon the obliquity of the rays *to the object*, as it had been so long and so stoutly maintained, but upon their obliquity *to the axis of the microscope*.

Such coarse objects as require only a few degrees of aperture to disclose them are dependent on 'shadow effects;' but when extremely minute and delicate structures are to be disclosed small apertures are absolutely useless, and mere increase of obliquity of pencil as such is powerless to alter the result. It can be effected only by increased numerical aperture, showing that the greater obliquity of the rays incident on, or remitted from, the object is not, and cannot be, *of itself* an element in the superior optical performance of greater aperture. If it were so, all the results of increased aperture would be secured by *inclining the object* to the axis of the microscope; but it may be readily tested that when a given object cannot be 'resolved,' or its structure delineated, by an objective with an aperture of 80° in the ordinary position, but *can* be resolved in the ordinary position by an objective with an aperture of 90° , *no inclination of the object* to the axis of the instrument will enable the objective of 80° to do the work easily done by one of 90° . This may be tested by any one possessing the instruments.

As a matter of fact, this so-called but imaginary 'angular grip' is greater in a wide-angled dry lens than in one of 90° balsam-angle, and it is certainly cut down more and more when with one and the same objective preparations are observed in water, balsam, and cedar oil successively. If now the angles *quâ* angles are effective in *any way*, *something* must be *lost* by change of angle in this direction, and something ought to be gained by change in the reverse direction, other conditions remaining the same. It is needless to say that all experience and the entire course of proof and reasoning given above are diametrically opposed to such conclusions.

Similarly it will be manifest that the conception that 'solid vision' or perspective effect in a microscopic image is one of the consequences of oblique 'angular' illumination is equally invalid. It assumes that the different perspective views of a preparation examined with the microscope, which correspond to the different obliquities, produce the same effects as if they were seen separately by different eyes, as in the case with the binocular microscope. In reality, whenever we have the advantage of solid vision, owing to a different perspective projection of different images, in the microscope or otherwise, this is solely because the different images are seen by *different eyes*. In microscopic vision there is no difference of *projection* connected with different obliquities; in the binocular microscope there is a diversity of images which are depicted by pencils of

different obliquities at the object which is a *certain kind* of perspective difference; but the above and other observations and experiments show that even here there is essential divergence from the conditions of ordinary vision.

It is thus plain that whenever aperture is effective in delineation the mode in which it becomes so is *not* by means of the obliquity of the rays to the object; while it has already been shown that increase of light, always concomitant with the use of immersion objectives, is a relative advantage, but no part of the explanation of the superior action of the combination of lenses. *Angle* is demonstrably not the true basis for the comparison of objectives; it fails in regard to aperture in general, so far as it has relation to opening: it fails equally in regard to the number of rays and the quantity of light admitted to the system of lenses; while its failure in regard to the delineating power of objectives is everywhere seen and admitted.

At the same time it is plain that the cause of increased power of performance in the objective is directly connected with the larger *opening* or 'aperture' of the immersion and homogeneous systems. In other words, it becomes clear that *something* is admitted into the objectives with greater apertures which contributes to the formation of an image, such as objectives of lesser aperture *cannot form* because their 'openings' or 'apertures' cannot admit that 'something.'

What this is becomes explicable by the researches of Abbe. It is demonstrated that microscopic vision is *sui generis*. There is, and can be, *no* comparison between microscopic and macroscopic vision. The images of minute objects are not delineated microscopically by means of the ordinary laws of refraction: they are not *dioptrical* results, but depend entirely on the laws of *diffraction*. These come within the scope of and demonstrate the undulatory theory of light, and involve a characteristic change which material particles or fine structural details, in proportion to their minuteness, effect in transmitted rays of light. The change consists generally in the breaking up of an incident ray into a group of rays with large angular dispersion within the range of which periodic alternations of dark and light occur.

If a piece of wire be held in a strong beam of divergent light so that its shadow fall upon a white surface, the shadow will not be sharp and black, but surrounded by luminous fringes having the colours of the spectrum, and the centre, where the black shadow of the wire should be, is a luminous line, as if the wire were transparent. This phenomenon, as is generally known, is due to the *inflection* of the diverging rays on either side of the wire. The inflected rays, in passing over one edge of the wire, meet the rays inflected by the other edge and 'interfere,' producing alternate increase and diminution of amplitude of oscillation or undulatory intensity, and giving rise to coloured fringes if white light is used, and if homogeneous light be employed giving origin to alternate bands of light and dark, the centre always being luminous.

Again, if a disc perforated with a very small hole in the centre be held in a pencil of diverging light, those undulations which pass

directly through the aperture interfere with those passing obliquely at the edge of the disc and produce, at certain distances, a dark spot, at other distances increased brightness, on that part of the shadow which is opposite the aperture in the disc; so that light is supplanted by darkness, and darkness changed to light, by the discord or concord of the luminous waves.

Independently of all experiment, the first principles of undulatory optics lead to these experimental conclusions. The laws of rectilinear propagation of the luminous rays of reflection and refraction are not *absolute* laws. They arise from, and depend upon, a certain *relation* between the wave-lengths and the absolute dimensions of the objects by which the waves are intercepted, or reflected, or refracted.

Taking as illustrative the waves of *sound*, an *acoustic* shadow is only produced if the obstacle be many times greater than the length of the sound-waves. If the obstacle is reduced, the waves pass completely round it and there is no shadow, or if the notes are of higher pitch, so that the waves are reduced, a smaller obstacle than before will produce the shadow. In the case of light there are similar phenomena. If the obstacles to the passage of light be large in comparison with the wave-lengths, shadow effects result: but if the linear dimensions of objects are reduced to *small multiples* of the wave-lengths of light, all shadows or similar effects of solidity must cease. As in the instances given above, light and dark, or maxima and minima of luminosity, interchange their normal positions by harmony or disharmony of luminous waves.

It is then by means of diffraction phenomena that Abbe is enabled to explain the formation of the images of objects containing delicate striæ or structure, and requiring large apertures for their complete or approximate delineation. In the interests of this exposition we must here for a moment diverge on slightly personal grounds. It has been the good fortune of the present editor to obtain the courteous consent of Dr. Abbe to read and criticise the whole of the present chapter; however careful and earnest a student of such complex and original work as Dr. Abbe has done and recorded in German and English during the last thirty years or more, it is impossible to be wholly satisfied with the most sympathetic and sincere desire to give such work a popular form unless it should have been perused and accepted by the author. Dr. Abbe has read the entire chapter, and, with many generous words besides, relieves the editor in his consciousness of great responsibility by saying that he distinctly approves of the 'lively interest and care which (the present editor) has bestowed on the exposition of his (Dr. Abbe's) views,' and that he feels 'the greatest satisfaction in seeing (his) views represented . . . so extensively and intensively.'

But beyond this, an original worker like Dr. Abbe would almost inevitably find, in the course of years, reason for slight verbal and other more serious modifications of his inferences, explanations, and views; and the editor has great satisfaction in being able to put these modifications where they occur, with the approval of Dr. Abbe.

In the expositions of Dr. Abbe's views on the diffraction theory

of microscopic vision given up to this time, it has been usual to state that he held and taught that the microscopic image consists of *two superimposed images*, each having a distinct character as well as a different origin, and capable of being separated and examined apart from each other. The one called the 'absorption image' is a similitude of the object itself, an image of the main outlines of the larger parts; but by the *other* image all *minute* structures, striation, and delicate complexity of detail *whose elements lie so close together as to occasion diffraction phenomena* can alone be formed, because these *could* not be geometrically imaged. So that in the case of an object with lines closer than the $\frac{1}{2500}$ of an inch apart, the image seen by the eye is formed, not simply by the central dioptric beam, but by the joint action of that and the superimposed diffraction images, and their exact union in the upper focal plane of the objective.

The first of these was held to be a *negative* image, representing geometrically the constituent parts of the object; but the second was considered a *positive* image because it delineates structure, the parts of which appear self-luminous on account of the diffraction phenomena which they cause. It was this 'diffraction image' that was said to be the instrument of what has so long been known as the 'resolving' power of lenses.

But Dr. Abbe, with the full light of further investigation and experience, does not hesitate to modify this explanation. He says: 'I no longer maintain in principle the distinction between the "absorption image" (or direct dioptrical image) and the "diffraction image," nor do I hold that the microscopical image of an object consists of two superimposed images of *different origin* or different mode of production.

'This distinction, which, in fact, I made in my first paper of 1873, arose from the limited experimental character of my first researches and the want of a more exhaustive theoretical consideration at that period. I was not then able to observe in the microscope the diffraction effect produced by relatively coarse objects because my experiments were not made with objectives of sufficiently long focus; hence it appeared that coarse objects (or the *outlines* of objects containing fine structural details) were depicted by the directly transmitted beam of light solely, without the co-operation of diffracted light.

'My views on this subject have undergone important modifications. Theoretical considerations have led me to the conclusion that there must always be the *same* conditions of the delineation *as long as the objects are depicted by means of transmitted or reflected light*, whether the objects are of coarse or very fine structure. Further experiments with a large microscope, having an objective of about twelve inches focal length, have enabled me to actually observe the diffraction effect and its influence on the image, viewing gratings of not more than forty lines per inch.¹

¹ Diffraction effects may be observed without a microscope; they can be easily demonstrated by observing a lamp-flame through a linen pocket-handkerchief or a fine gauze wire blind. This can be done readily by placing the eye close to the linen or wire.

My present views may be thus expressed: With coarse objects the diffracted (bent off) rays belonging to an incident ray or pencil are *all* confined within a *very narrow angular space around that incident ray*, and do not appear separated from this except with objectives of very long focus. The *whole* of such a narrow diffraction pencil is consequently always admitted to the objective *together* with the direct (incident) beam, whatever may be the direction of incidence, axial or oblique. According to the proposition of p. 72 (1) the image is in this case strictly similar to the object, i.e. the effect is the same as if we had a direct delineation by the incident cones of light alone, and as if the image did not depend at all upon the diffractive action of the object.

If we have a preparation like a diatom—a relatively coarse object, including fine structural details—or another preparation containing coarse elements and fine ones in juxtaposition, the total diffraction effect may be separated (theoretically and practically) into two parts: (1) that which depends on, or corresponds with, the coarse object (e.g. the outlines of the diatom) or to the coarse elements; and (2) that depending upon, or resulting from, the fine structural detail or the minute elements. The foregoing consideration applies to (1): this constituent part of the total diffraction pencil of the preparation which is admitted to the objective *completely*, independently of the limiting action of the lens opening, and hence the corresponding parts of the object (outlines &c.) are depicted as if there were a direct delineation, i.e. in perfect similarity—even with low apertures. Those diffracted rays within the whole diffraction pencil which are due to the *minute* elements are strongly deflected from the incident beams to which they belong.¹

According to the less or greater aperture of the objective and the axial or oblique incidence of the illuminating pencil or cone, *this* part of the total diffraction pencil will be subject to a more or less incomplete admission to the objective, and the corresponding image will therefore show the characteristic traces of the diffraction image, that is to say, change of aspect with different apertures and different illumination, dissimilarity to the real structure, and so forth. Thus we have *practically*, in most cases, a composition of the microscopical image, consisting of two superimposed images of different behaviour. But the difference is not to be considered one of *principle*, so far as the *production* of the image is concerned: for it depends solely upon the different angular expression of the diffraction fans resulting from coarse and from extremely fine elements.²

Resuming, then, our illustration of diffraction phenomena as applied to the theory of microscopic vision, we would point out that perhaps the most serviceable illustration for our purpose is a plate of glass ruled with fine parallel lines. If the flame of a candle be so placed that its image may be seen through the centre of the plate, this

¹ Letter from Dr. Abbe.

² Thus it appears that both the 'absorption image' and the 'diffraction image' are now held to be equally of diffraction origin; but, whilst a lens of small aperture would give the former with facility, it would be powerless to reveal the latter because of its limited capacity to gather in the strongly deflected diffraction rays due to the minuter elements.

central image will be clear and uncoloured, but it will be flanked on either side by a row of coloured spectra of the flame which are fainter and more dim as they recede from the centre : fig. 48 illustrates this.

A similar phenomenon may also be produced by dust scattered over a glass plate and by other objects whose structure contains very minute particles, the light suffering a characteristic change in passing through such objects, that change consisting in the breaking up of a parallel beam of light into a group of rays diverging with wide angle, and forming a regular series of maxima and



FIG. 48.

minima of intensity of light due to difference of phase of vibration.

In the same way in the microscope the diffraction pencil originating from a beam incident upon, for instance, a diatom appears as a fan of isolated rays, decreasing in intensity as they are further removed from the direction of the incident beam transmitted through the structure, the interference of the primary waves giving a number of successive maxima of light with dark interspaces.

With daylight illumination if a diaphragm opening be interposed between the mirror and a plate of ruled lines placed upon the stage, the appearance shown in fig. 49 will be observed at the back of the objective on removing the eye-piece and looking down the tube of the microscope.

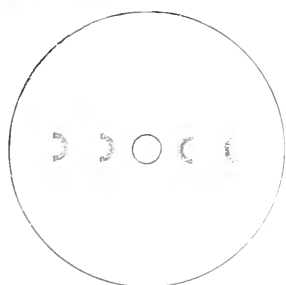

FIG. 49.

The central circle is an image of the diaphragm opening produced by the direct, so-called non-diffracted rays, while those on either side are the diffraction images produced by the rays which are bent off from the incident pencil. In homogeneous light the central and lateral images agree in size and form, but in white light the diffracted images are radially drawn out with the outer edges red and the inner blue (the reverse of the ordinary spectrum), forming, in fact, regular spectra, the distance separating each of which varies inversely as the closeness of the lines, being, for instance, with the same objective twice as far apart when the lines are twice as close.

The formation of the microscopical image is explained by the fact that the rays collected at the back of the objective, depicting there the direct and spectral images of the source of light, reach in their further course the plane which is conjugate to the object, and give rise there to an interference phenomenon (owing to the connections of the undulations), this interference effect giving the ultimate image which is observed by the eye-piece, and which therefore depends essentially on the number and distribution of the diffracted beams which enter the objective.

It would exceed the limits and the object of this handbook to attempt a theoretical demonstration of the action of diffraction spectra in forming the images of fine structure and striation so as to afford 'resolution.' Those who desire to pursue this part of the

subject may do so most profitably by the study of the only book in our language that deals exhaustively with the theory of modern microscopical optics, viz. the translation of Naegeli and Schwendener's 'Microscope in Theory and Practice,' translated and placed within the reach of English microscopists by the joint labour of Mr. Frank Crisp and Mr. John Mayall, jun. The experimental proof of the diffraction theory of microscopical vision lies within the range of our

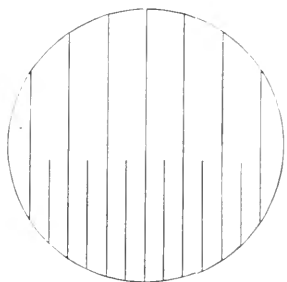

FIG. 50.—Diffraction grating

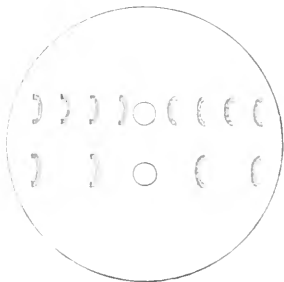

FIG. 51.—Diffraction image at back of lens without eye-piece.

purpose, and the following experiments will suffice to show those who possess the instruments, and desire the evidence, that to the action of diffraction spectra we are indebted for microscopical delineation.

The first experiment shows that with, for instance, the central beam, or any one of the spectral beams alone, only the contour of the object is seen, the addition of at least one diffraction spectrum being essential to the visibility of the structure.

Fig. 50 shows the appearance presented by an object composed of wide and narrow lines ruled on glass when viewed in the ordinary way with the eye-piece in place, and fig. 51 the appearance presented at the back of the objective when the eye-piece is removed, the

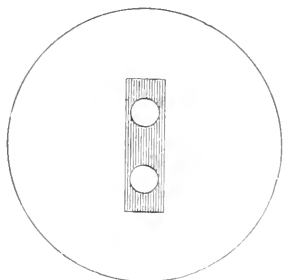

FIG. 52.

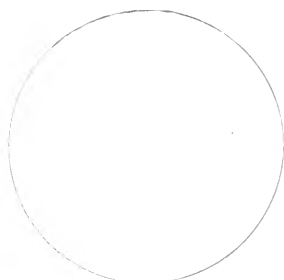

FIG. 53.

spectra being ranged on either side of the central (white) image, and at right angles to the direction of the lines: in accordance with theory, they are farther apart for the fine lines than for the wide ones.

If now, by a diaphragm at the back of the objective, like fig. 52, we cover up all the diffraction-spectra, allowing only the direct rays to reach the image, the object will appear to be wholly deprived of

fine details, only the outline remaining, and every delineation of minute structure disappearing just as if the microscope had suddenly lost its optical power (see fig. 53).

This illustrates a case of the *obliteration* of structure by obstructing the passage of the diffraction-spectra to the eye-piece.

The second experiment shows how the appearance of fine structure may be *created* by manipulating the spectra.

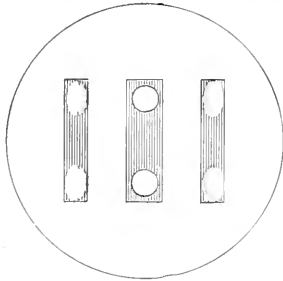

FIG. 54.

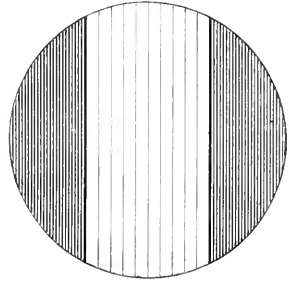

FIG. 55.

If a diaphragm such as that shown in fig. 54 is placed at the back of the objective, so as to cut off each alternate one of the upper row of spectra in fig. 50, that row will obviously become identical with the lower one, and if the theory holds good, we should find the image of the upper lines identical with that of the lower. On replacing the eye-piece we see that it is so: the upper set of lines are doubled in number, a new line appearing in the centre of the space between each of the old (upper) ones, and upper and lower sets having become to all appearance identical (fig. 55).

In the same way, if we stop off all but the outer spectra, as in fig. 56, the lines are apparently again doubled, and are seen as in fig. 57.

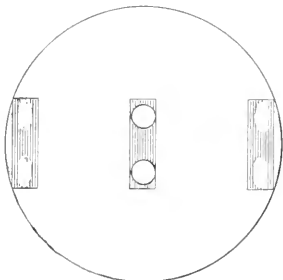

FIG. 56.

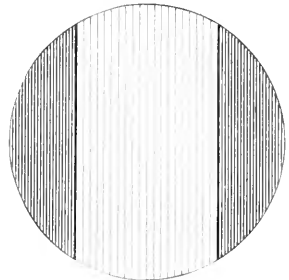

FIG. 57.

A case of apparent creation of structure similar in principle to the foregoing, though more striking, is afforded by a network of squares, such as fig. 58, having sides *parallel* to the page, which gives the spectra shown in fig. 59, consisting of vertical rows for the horizontal lines and horizontal rows for the vertical ones. But it is readily seen that two diagonal rows of spectra exist at right

angles to the two diagonals of the squares, just as would arise from sets of lines in the direction of the diagonals, so that if the theory holds good we ought to find, on obstructing all the other spectra and

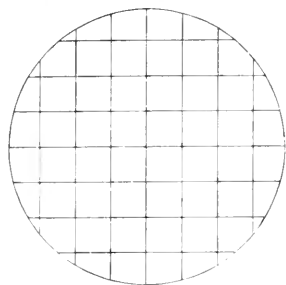

FIG. 58.

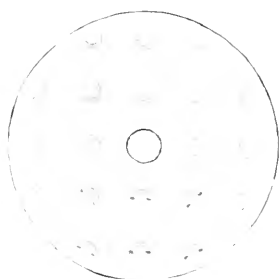

FIG. 59.

allowing only the diagonal ones to pass to the eye-piece, that the vertical and horizontal lines have disappeared, and two new sets of lines at *right angles to the diagonals* have taken their place.



FIG. 60.

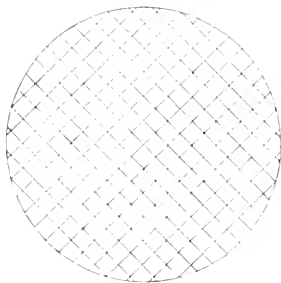

FIG. 61.

On inserting the diaphragm, fig. 60, and replacing the eye-piece, we find, in the place of the old network, the one shown in fig. 61.

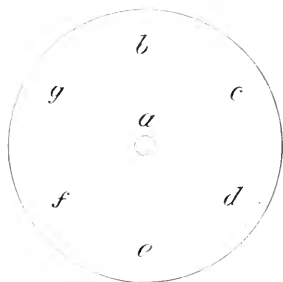

FIG. 62.

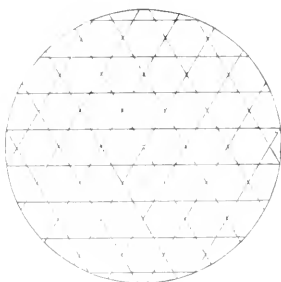

FIG. 63.

the squares being, however, smaller in the proportion of $1 : \sqrt{2}$, as they should be in exact accordance with theory.

An object such as *Pleurosigma angulatum*, which gives six

diffraction spectra arranged as in fig. 62, should, according to theory, show markings in a hexagonal arrangement. For there will be one set of lines at right angles to bac , another set at right angles to caf , and a third at right angles to gad . These three sets of lines will obviously produce the appearance shown in fig. 63.

A great variety of other appearances may be produced with this same arrangement of spectra. Any two adjacent spectra with the central beam (as bca) will form equilateral triangles and give hexagonal markings. Or by stopping off all but gce (or bdf) we again have the spectra in the form of equilateral triangles; but as they are now further apart, the sides of the triangles in the two cases being as $\sqrt{3} : 1$, the hexagons will be smaller and three times as numerous. Their sides will also be arranged at a different angle to those of the first set. The hexagons may also be entirely obliterated by admitting only the spectra gc or gf or bf , &c., when new lines will appear parallel at right angles or obliquely inclined to the median line.

By varying the combinations of the spectra, therefore, different figures of varying size and positions are produced, all of which cannot of course represent the true structure.

In practice, indeed, it has been proved that if the position and relative intensity of the spectra, as found in any particular case, be given, what the resultant image will be can be reached by mathematical calculations wholly, and with an exactness that may even to some extent transcend the results of previous observation on the actual image of the object whose spectra formed the mathematician's data.

If *P. angulatum* be illuminated by central light transmitted from an achromatic condenser, and examined by means of a homogeneous lens of large aperture, Mr. Stephenson points out¹ that under ordinary conditions it would show, on withdrawing the eyepiece and looking down the tube, one bright central light from the lamp with six equidistant surrounding diffraction spectra, produced by the lines ('if, indeed, lines they be') in the object itself. But let a stop made of black paper, which *entirely* excludes the central beam of light, be placed at the back of the objective and close to the posterior lens; in the stop let six marginal openings be made through which the diffraction spectra may pass. On examining the image we find that in lieu of the ordinary hexagonal markings the valve appears of a beautiful blue colour on a black ground, and covered with circular spots, clearly defined, and admitting of the use of deep eye-pieces.

This is precisely what we learn from Abbe that the diffraction theory involves. In support of this, the philosophical faculty of the University of Jena had proposed as a question to the mathematical students the effect produced in the microscope by these interference phenomena. One problem was that of the appearance produced by six equidistant spectra in a circle; they correspond precisely with the spectra of *P. angulatum*, as accessible to us with our present numerical aperture; and the diagram of the diffraction image, de-

¹ *Journ. R.M.S.* vol. i. 1878, p. 186.

duced from theory, of what spectra of the given position and intensity of the proposed data should give is seen in fig. 64. But what seems quite as much to the purpose is, that Dr. Zeiss has produced a fine photograph of *P. angulatum*, given in Plate X., where it will be seen that the details shown in fig. 64 appear.

Let it be clearly understood that this does not pretend to be an interpretation of the markings of the diatom; it is only held by Abbe to be an accurate indication by calculation of what image the given diffraction spectra should produce. An optical glass and media for 'mounting' and 'immersion' of immensely greater refractive and dispersive indices—at present wholly inaccessible to us—must, he contends, be found and employed before *all* the diffraction spectra of *P. angulatum* could be admitted to form its absolute and

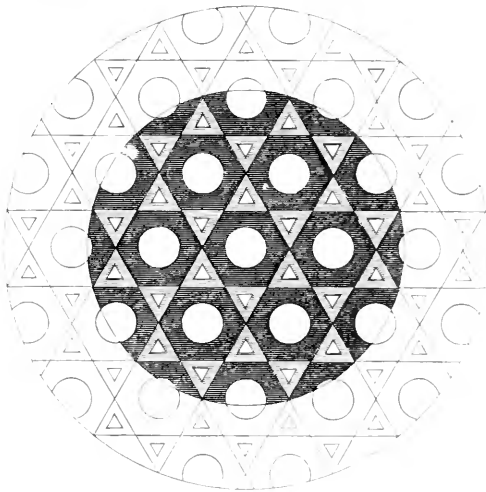

FIG. 64.

complete 'diffraction image;' but from such spectra as the objective employed can admit, it is maintained by Abbe that the mathematician can accurately show what the image will be. In the case of *P. angulatum* theory indicated the *optical, but not necessarily the structural* existence¹ of smaller markings, shown in fig. 64, between the circular spots. These had not been before *seen* by observers; and the mathematician who made the calculation (Dr. Eichhorn) had never seen the diatom under the microscope; but when Mr. Stephenson re-examined the object—stopping out the central beam as above described and allowing the six spectra only to pass—he saw the small markings, and showed them at a meeting of the Royal Microscopical Society to many experts who were there. They were small and faint, and no doubt purely optical; and, we learn from experiment, may readily escape observation; but by careful investigation they

¹ *Conf.* Abbe's recent note, pp. 72 *et seq.*

are as present to the observer as they are capable of being demonstrated by calculation to the mathematician.

Clearly, then, on these assumptions and with all other considerations put aside, our finest homogeneous objectives of greatest aperture inevitably fail to reveal to us the real structure of the finer kinds of diatom valves. We learn that *dissimilar* structures will give *identical microscopical images* when the *difference* of their diffractive effect is removed, and conversely *similar structures* may give *dissimilar images* when their diffractive images are made dissimilar. A purely dioptric image answers point for point to the object on the stage, and therefore enables a safe inference to be drawn as to the true nature of that object; but the diffraction or interference images of minute structure stand in no direct relation to the nature of the object, and are not of necessity conformable to it. As Dr. Abbe has already insisted, minute structural details are not imaged by the microscope geometrically or dioptrically and cannot be interpreted as *images of material forms*, but only as *signs* of material differences of composition of the particles composing the object, so that nothing more can safely be inferred from the image as presented to the eye than the presence in the object of such structural peculiarities as will produce the specific diffraction phenomena on which the images depend.¹

It follows, therefore, that the larger the number of diffracted rays admitted into the objective *the greater is the similarity between the image and the object*. But carefully observe—

(1) *Perfect similarity* between these depends always on the admission to, and utilisation by, the optical combination of *the whole* of the diffracted rays which the structure is competent to emit.

For the same reason the diffraction fan of *isolated corpuscles* or *flagella* in a clear field must be exactly identical to that of equal-sized holes or slits of equal shape in a dark background, and theory shows that there must be a continuous and nearly uniform dissipation of diffracted light over the whole hemisphere, provided the diameter of the object is a small fraction of the wave-length of light; and this would be so even in a medium of highest known refractive index. *Such isolated objects can be seen, however minute they may be*; it is merely a question of contrast in the distribution of light, of good definition in the objective, and of sensibility of the retina. The diffraction theory does not put a limit to *visibility* with microscopic objectives; it simply proves, in theory and practice, what is the limit of visible *separation* in fine striation and structure.

In the visible flagellum of *Bacterium termo* only a fraction of a wave-length in diameter appears as of considerably increased diameter, even with a very wide aperture. The image seen is that of another thread, the composition of which theory can be employed to

¹ See Abbe's note, p. 65. But we cannot pass over in this connection the remarkable paper in the *Journ. Quakett Club*, ser. ii, vol. iv, on the 'Sub-stage Condenser,' by Mr. Nelson. His photo-micrographs illustrating the mutable diffraction effects of the 'small cone' of oblique illumination, as distinct from a 'solid central cone,' and the curious 'ghostly' diffraction images of the former, as distinct from the immutable diffraction images of the latter, deserve careful consideration. From p. 125 of the paper this matter is carefully discussed.

compute, which would give an exactly similar diffraction fan, but abruptly broken off at the limit of the aperture. Theory shows that a thread-shaped object which could yield such a particular diffraction effect must (without considering other differences) be *greater in breadth* than another one yielding the full continuous dissipation of light; in other words the actual thread, so inconceivably fine, belonging to the Bacterium has produced a 'diffraction effect' through the microscope, resulting in the appearance of a thread which is the 'diffraction image.' But this latter is greater in width than the actual thread or protoplasmic fibre would be could it be seen directly without the aid of diffraction.

(2) Whenever a *portion* of the total diffraction fan appertaining to a given structure is lost, the image will be more or less *incomplete and dissimilar* from the object; and in general the dissimilarity will be the greater the smaller the fraction of light admitted. With structures of every kind (regular and irregular) the image will lose more and more the indications of the minuter details, as the peripheral (more deflected) rays of the diffraction pencil are more and more excluded. The image then becomes that of a *different* structure, namely, of one the *whole of whose diffracted beams* would (if it physically existed) be represented by the *utilised* diffracted beams of the structure in question.

At this place it is suitable to point out that Dr. Abbe emphasises to the present editor the importance of interpreting the 'intercostal points' shown by Mr. Stephenson in *P. angulatum* (fig. 64) as not a revelation of *real* structure. 'The fact is that the image, which is obtained by stopping off the direct beam, will be *more dissimilar* from the real structure than the *ordinary* image. It has already been shown that the directly transmitted ray is a constituent and most essential part of the total diffraction pencil appertaining to the structure; it is the central *maximum* of this pencil. If this be stopped off a greater part of the total diffraction pencil is lost than otherwise, and the image, consequently, is a more incomplete one, and therefore more dissimilar than the ordinary image.

The interest of the experiment in question is consequently confined to two points, viz.—

i. 'It is an exemplification of the general proposition that the *same* object affords different *images* if different *portions* of the total diffraction fan are admitted to the objective.

ii. 'The image in question shows to the observer what would be the *true aspect* of that structure which will split up an incident beam of light into six isolated maxima of second order of equal intensity, suppressing totally the (central) maximum of the first order, as fig. 65; a structure of such a particular and unusual diffraction effect is theoretically possible, although it may be probably impossible to realise it practically. Mr. Stephenson's experiment shows, in fact, the true projection of the hypothetical structure.

(3) 'As long as the elements of a structure are large multiples of the wave-length of light, the breaking up of the rays by diffraction is confined to smaller and smaller angles; that is, all diffracted rays of perceptible intensity will be comprised within a narrow cone

around the direction of the incident beam from which they originate. In such a case even small apertures are capable of admitting the *whole*. The images of such *coarse* objects will therefore be always perfectly similar to the object, and the result of the interference effect is the same as if there were no diffraction at all, and the object were a self-luminous one.

(4) 'When the elements of a structure are reduced in diameter to smaller and smaller multiples of the wave-length which corresponds to the medium in which the object is, the diffraction pencil originating from an incident beam has a wider and wider angular expansion (the diffracted rays are further apart); and when they are reduced

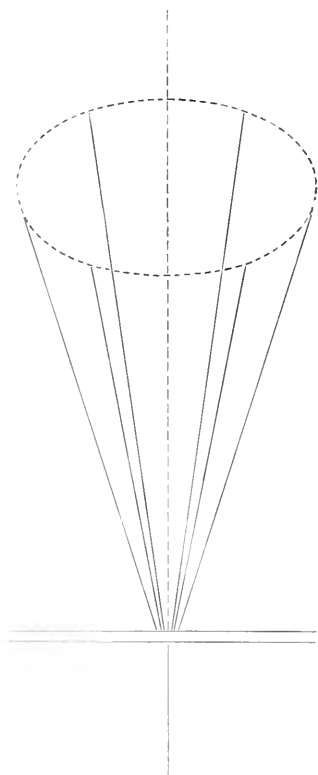

FIG. 65.

to only a few wave-lengths, not even the hemisphere can embrace the *whole* diffraction effect which appertains to the structure. In this case the whole can only be obtained by shortening the wave-length, i.e. by increasing the refractive index of the surrounding medium to such a degree that the linear dimensions of the elements of the object become a large multiple of the *reduced* wave-length. With very minute structures, the diffraction fan which can be admitted in air, and even in water or less balsam, is only a greater or less *central portion* of the whole possible diffraction fan corresponding to these structures, and which could be obtained if they were in a medium of much shorter wave-length. Under these circumstances no objective, however wide may be its aperture, can yield a *complete or strictly similar image*.

It is at points of such extreme delicacy and moment as this that the diffraction hypothesis of Dr. Abbe is so liable to misapprehension and misinterpretation, and a further note from him relating to the *dissimilarity* of the image in the case of incomplete admission of the diffraction pencil will be of great value here.

i. In the case of regular *periodic* structures (i.e. equidistant striae, rows of apertures, 'dots,' and so forth) the distance of the lines apart is, even with an incomplete admission of the diffracted light, always *depicted correctly*; that is to say, the number of the lines per inch is never changed, *provided* the direct beam (i.e. the central maximum of the diffraction fan) is *admitted to the objective and at least one of the next diffracted rays*, or, in other words, one of the next maxima of second order. The *range of dissimilarity*

is in this case confined to the proportion between the bright and the dark interspaces of the striation and to the appearance of the contours of the striae.

• If not more than the said *two* rays of the total diffraction fan are admitted, the dark and the light intervals are *always* shown of approximately *equal breadth*, even if the real proportion of both intervals differs much from 1 : 1 ; and the dark and bright striae show always *gradually* increasing and decreasing brightness ; in other words, want of distinct contours.

• This phenomenon shows the typical picture of every regular striation for the depiction of which not more than two diffraction rays can be utilised. For example, *Amphipleura pellucida*, or any other striation which is near to the limit of resolution for the optical system in use, and, therefore, even with oblique light, brings only *one* diffracted beam into the objective.

ii. • Whenever a structure gives rise to a diffraction fan of considerable angular extension, the observation with a central incident beam or axial light may lose a greater or smaller portion of the whole diffracted light if the angular expansion of the fan extends to the aperture of the objective in use. But oblique illumination *must* always involve a loss, and this loss is not confined to the external (peripheral) rays of the diffraction pencil (as is the case in central light), but the portion *lost* will more and more extend to one full half of the whole when the obliquity is gradually increased to the utmost limit, so that the direct beam touches the edge of the aperture. It follows that the images which are obtained with *oblique* light will always be incomplete and *not similar* to a geometrical projection of the object ; and generally (though not always) more dissimilar than those by central light in regard to the minuter details.

• Strictly similar images cannot be expected, except with a *central* illumination with a narrow incident pencil, because this is the necessary condition for the possible admission of the whole of the diffracted light.

Let it be noted that these principles of the diffraction theory of microscopical vision relate to structures of all kinds, whatever may be their physical and geometrical composition. Irregular structures, isolated elements of any shape, equally produce diffraction effects, observed either by transmitted or reflected light, and being either transparent, semitransparent, or opaque.

The value of $a = n \sin u$ indicates the number of rays which an objective can admit ; the aperture equivalent measures the very essence of microscopical performance. It measures the degree in which a given objective is competent to exhibit a true, complete delineation of structures of given minuteness, and conversely the proportion of a in different objectives is the exact measure of the different *degree of minuteness* of structural details which they can reach, either with perfect similarity of the image or with an equal degree of incompleteness of the image, provided that the purely dioptrical conditions are the same.

• 'Resolving' power is thus a special function of aperture. The limit of visible separation in delicate structure and striation is

determined by the fact that no resolution can be effected unless at least two diffraction pencils are admitted, and the admission of these we have seen is absolutely dependent on the aperture of the objective.

The rule given by Professor Abbe for determining the greatest number of lines per inch which can be resolved by oblique light will be found (taking any given colour as a basis) to be equal to *twice the number of undulations in an inch multiplied by the numerical aperture*.

To those who have studied this subject it will be seen that the 'numerical aperture' here takes the place of what was formerly the 'sine of half the angle of aperture;' and it has the effect of giving the proposition a broader generality. By using the 'sine of half the angle of aperture,' the proposition is only true with the addition that the number of undulations be calculated from the wave-length within the special medium to which the angle of aperture relates.

In introducing the numerical aperture instead of the sine of the angle, the latter (the sine) is increased in the proportion of $1 : n$ (n standing for the index of the medium), and that has the same effect as increasing the other factor the number of undulations.

What the colour employed should be is only capable of individual determination, since the capacity for appreciating light varies with different individuals.

If, for instance, we take 43μ in the solar spectrum as being sufficiently luminous for vision, we find the maximum—so far as seeing is concerned—to be 118,000 to the inch (the object, in this case, being in air); but as the non-luminous chemical rays remain in the field after the departure of the visible spectrum, a photographic image of lines much closer together might be produced.

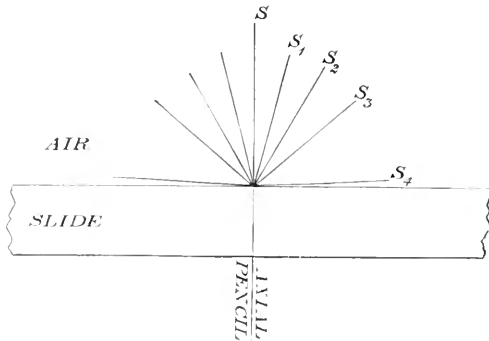

FIG. 66.

This important subject can scarcely be considered complete, even in outline, without a brief consideration, in their combined relations, of apertures in excess of 180° in air and the special function these apertures possess.

1. Suppose any object composed of minute elements in regular arrangement, such as a diatom valve; and, to confine the consideration to the most simple case, suppose it illuminated by a narrow

axial pencil of incident rays. If this object is observed in air, the radiation from every point of the object is, in consequence of the diffraction effect, composed of an axial pencil S , fig. 66 (the direct continuation of the incident rays), and a number of bent-off pencils, S_1, S_2, \dots surrounding S .¹

If, now, instead of air, the object is immersed in a medium of greater refractive index, n , it results from Fraunhofer's formula that the sine of the angle of deflection of the first, second, \dots bent-off

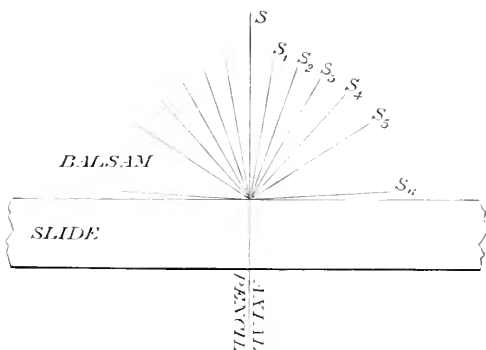

FIG. 67.

beam is *reduced* in the exact proportion of n , and the angle is reduced also—that is, the whole fan of the diffracted rays is *contracted* in comparison with its extension in air. Fig. 67 will represent the case of the same object in oil.

If now any dry objective (with a given angular semi-aperture u) is capable of gathering-in from air the first, or the first and second, diffraction beams on every side of the axial pencil, another objective with a more dense front medium of the refractive index, n , will be capable of admitting, from within the dense medium, exactly the *same* beams (no more and no less), if its *angular* semi-aperture, v , is *less* than u in the proportion:

$$\sin v : \sin u = 1 : n,$$

or

$$n \sin v = \sin u,$$

all other circumstances—object and illumination—remaining the same.

For example, a diatom for which the distance of the stria is 0.6μ , will give the *first* bent-off beam of green light ($\lambda = .55 \mu$) in *air* under an angle of 66.5° . This will be just admitted by a dry objective of 133° *angular* aperture. In *balsam* ($n = 1.5$) the same pencil will be deflected by 37.5° only, and would be admitted, therefore, by an objective of not more than 75° *balsam-angle*. Again, if the distance of the lines should be greater, as 1.2μ , the *second* deflected beam

¹ In figs. 66, 67, and 68 S_1 and S_n are supposed to be identical with the surfaces, but are drawn at a slight inclination to them for the purpose of clearness in the diagrams.

would be emitted in *air* under an angle of 66.5° , but in *balsam* the *third* would attain the same obliquity. Whilst now the dry objective of 133° air-angle cannot admit more than the two first diffraction beams on each side of the axis, the immersion of 133° balsam-angle is capable of admitting from balsam three on each side under exactly the same illumination.¹

It follows, therefore, that a balsam-angle of 75° denotes the same aperture as the larger air-angle of 133° , and a balsam-angle of 133° a much greater aperture than an air-angle of the same number of degrees, and in general two apertures of different objectives must be equal if the sines of the semi-angles are in the inverse ratio of the refractive index of the medium to which they relate—or, which is the same thing, if the product of the refractive index multiplied by sine of the angular semi-aperture ($n \sin u$) yields the same value for both, i.e. if they are of the same numerical aperture.

2. Suppose the same object to be observed by a dry objective of a given air-angle, at first in air uncovered, and then in balsam protected by a cover-glass. The first case would be represented by

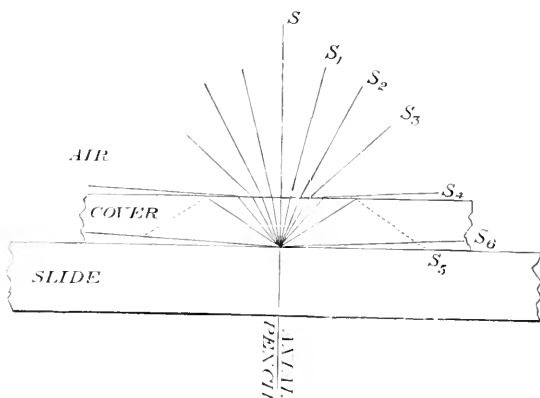

FIG. 68.

fig. 66, and the second by fig. 68. As we have seen, the group of diffracted beams from the object in balsam is *contracted* in comparison to that in air in the ratio of the refractive index. But

¹ The following are the actual angles represented in the diagrams, viz.:

(Striae: 2.2μ , wave-length $\lambda = .55 \mu$, medium air $n = 1$.)

$\alpha_1 = 14^\circ 30'$
 $\alpha_2 = 30^\circ 0'$
 $\alpha_3 = 48^\circ 36'$
 $\alpha_4 = 90^\circ 0'$

(Striae: 2.2μ , wave-length $\lambda = .55 \mu$, medium balsam $n = 1.5$.)

$\alpha_1 = 9^\circ 36'$
 $\alpha_2 = 19^\circ 28'$
 $\alpha_3 = 30^\circ 0'$
 $\alpha_4 = 41^\circ 18'$
 $\alpha_5 = 56^\circ 26'$
 $\alpha_6 = 90^\circ 0'$

according to the law of refraction, this group, on passing to *air* by the plane surface of the covering-glass, is *spread out*—the sines of the angles being compared—in the ratio of the same refractive index. Consequently the various diffraction pencils, the first, second, . . . on every side, after their *transmission into air*, have exactly the same obliquity which they have in the case of direct *emission in air* from an uncovered object.

If now any dry objective of, say, 133° air-angle is capable of admitting a certain number of these pencils from the uncovered object, it will admit exactly the *same* pencils from the balsam-mounted object. The contracted cone in balsam of 75° angular aperture embraces all rays which are emitted in air within a cone of 133° .

The aperture of an objective is not, therefore, cut down by mounting the object in a dense medium, for no ray which could be taken in from the uncovered object is lost by the balsam-mounting.

3. A comparison of figs. 66, 67, and 68 will show that a cone of 82° within the balsam medium embraces *all* the diffracted rays which are emitted from the object in air or transmitted from balsam to air. This, however, is not the totality of rays which are emitted in the balsam. The formula of Fraunhofer shows that the number of the emitted beams is *greater* in balsam than in air in the same ratio as the refractive index.

A structure the distance of whose elements equals $2 \cdot 2\mu$ emits in balsam *six* distinct beams on each side of the direct beam, but in air only *four* (see figs. 66, 67, and 68): the fifth and sixth are completely lost in air. A dry objective of an angular aperture closely approaching 180° will not even take in the fourth deflected beam, as this is deflected at an angle of 90° . But any immersion-glass of a balsam-angle slightly exceeding 82° will take in the fourth, and if the balsam-angle should exceed 112° it will take in the fifth beam also, provided the object is in balsam, and in optical continuity with the front of the lens.

Thus, again, it is seen (as was before shown by the purely dioptric method) that an immersion objective of balsam-angle exceeding 82° has a wider aperture than any dry objective of maximum angle can have, for it is capable of gathering in from objects in a dense medium rays which are not accessible to an air-angle of 180° .

It is, then, by the above facts and reasoning, placed beyond all dispute—

1. That a wide-angled 'immersion' or 'homogeneous' objective possesses an aperture in excess of 180° 'angular aperture' in air;

2. That the great value of this—always manifest practically—is fully accounted for and explained by the *diffraction* theory of microscopic vision; and

3. That 'dry' objectives, so far as regards the perfect delineation of *very minute structures*, can only be considered as representing an imperfect phase of construction. When made by the best hands, with every precaution and care employed to secure the best possible corrections, their defects do not lie in the direction of the presentation of false or even partially erroneous and distorted images.

Their defects are their inevitable incapacity to open up details in structure that can be disclosed with relative ease by the *inclusion into* an oil immersion, and especially an 'apochromatic' objective of great aperture, of the all-revealing diffraction beams *excluded* by the dry lens of equivalent power.

With dry objectives splendid results have been attained both in low and high power work; but all the latter is being advanced upon by revision with lenses of greater aperture in a striking manner. For twenty years we have been urging our best English microscope makers to enlarge the 'angle' of our objectives, and employing them from a $\frac{1}{6}$ -inch to a $\frac{1}{50}$ -inch focus. We have seen them advance from dry to water immersion, and from this to oil; from $\frac{1}{2.5}$ -inch, a $\frac{1}{3.5}$ -inch, and a $\frac{1}{5.0}$ -inch of N.A. 0.95 each, and respectively to water immersions of N.A. 1.04 and then to 'oil immersions' or homogeneous lenses of N.A. 1.38 for the $\frac{1}{2.5}$ -inch and $\frac{1}{5.0}$ -inch respectively, and ultimately by a $\frac{1}{2.0}$ -inch with N.A. of 1.50; and from that we have progressed to the apochromatic objectives with compensating eye-pieces.

Now the objectives with which the earlier work done by the present editor and his colleague, Dr. Drysdale, was effected—to which allusion is made only as being the instance with which we have most practical familiarity—are still in our possession; what was revealed by them fifteen, twelve, or ten years ago we can exactly repeat to-day; and in the general features of the work—in the broad characteristics of the life histories of the saprophytic organisms, minute as they are, revision with objectives of N.A. 1.50 and other lenses of the best English and German makers, reveals no positive error, even in the *minutest* of the details then discovered and delineated. But the later lenses of great aperture and beautiful corrections have opened up *structure absolutely invisible before*.

Thus, for example, a minute oval organism from the $\frac{1}{30000}$ th to the $\frac{1}{50000}$ th of an inch in long diameter was known to possess a distinct nucleus; the long diameter of this was from the $\frac{1}{10}$ th to the $\frac{1}{15}$ th of the diameter of the whole body of the organism. In the observations of fifteen to twenty-five years since the cyclic changes of the entire organism were clearly visible and constantly observed; but of the *nucleus* nothing could be made out save that it *appeared* to share the changes in self-division and genetic reproduction, *initiated* by the organism as a whole. But by lenses of N.A. 1.50 and the finest apochromatic objectives of Zeiss, especially a most beautifully corrected 3 mm. and 2 mm., structure of a remarkable kind has been demonstrated in the nucleus, and it has been shown that the *initiation* of the great cyclic changes takes place in the *nucleus*, and is then shared in by the organism as a whole. In short, we have discovered as much concerning the 'inaccessible' nucleus—which may be not more than, say, a twelfth of the long diameter of the whole organism—by means of *lower powers*, but *greater apertures*, as we were able to find concerning the complete body of the saprophyte with dry objectives.

But in spite of these facts there is a certain class of even high power work in biology from which the dry lens can never be dis-

missed. It must always be an indispensable instrument in a large part of the work done in the study of the life history of active living organisms; and whatever accessories in research on such subjects be employed, the main path of accurate and well correlated discovery must be by ultimate and consecutive reference to the changes of the *living* organism. But we cannot with any certainty do this with either a water immersion or a homogeneous objective. With an active organism under investigation, we desire, as far as practicable, to limit the area of its excursions; a cover-glass of not more than four-tenths or a quarter of an inch in diameter is large enough when objectives from a $\frac{1}{20}$ inch to a $\frac{1}{50}$ inch are used, or when the recent 2 mm. objective with 27 eye-piece is employed. To have oil or water on the top of the cover, between it and the front lens of the objective combination, is, with almost inevitable certainty, sooner or later, in following the object with counter movements of the stage, to reach the edge of the cover, and cause the oil or water above to mingle by capillarity with the minute drop of fluid under observation, and thus to involve the whole in catastrophe.

To do the main work of studying consecutively the life history of unknown organisms, dry objectives will and must be used: but in all cases such work must be supplemented by the use of objectives of great aperture. The details and relations of minute structure must be studied in one field, and their general origin and sequences in another. The latter will be 'continuous,' the former will be employed as necessity indicates. The diffraction theory of microscopic vision does not invalidate, but in reality, under definable conditions, directs the employment of 'narrow' apertures. All depends on the minuteness of microscopic detail. The law has been enunciated above: the minuter the dimensions of the structural elements, the wider *must be* the aperture; the larger the details of ultimate structure, the narrower the aperture that will *suffice*. This is true in regard to objects of every kind; there is no variation in the conditions of microscopical delineation.

The men engaged in microscopical research have different aims, nay, the same worker at different times differs in the object pursued. 'Ultimate structure' is not the *one* consideration of the microscopist; he often, as indicated above, has to take a comprehensive view of the whole object or objects of his research, apart from the most complex and delicate details.

It is folly to suppose that because great apertures have been proved theoretically and practically to be able to open out minute structure so perfectly, therefore there is no *raison d'être* for small apertures. Low amplification cannot render distinctly visible details beyond a certain limit of minuteness, and wide apertures cannot be utilised unless there is a concurrent linear amplification of the image which is competent to exhibit to the eye the smallest dimensions which are by optical law *within the reach and grasp* of such an aperture.

In the same way great amplification will be useless if we have small apertures which delineate details of dimensions only capable of being distinctly seen in an image of much lower amplification.

It will be 'empty amplification,' because there is nothing in the image which requires so much power for distinct recognition. If the *power* be deficient, aperture will not avail; if the aperture be wanting, nothing is gained by high power. If the angular aperture of the microscope is such that the delineation of fine lines, whose interspaces are one *micron*,¹ is just possible, it is fruitless labour to increase the amplification beyond what we know to be sufficient for their observation. We potentially differentiate what we are powerless to see.

Thus it may be inferred from the diffraction theory, as such, that wide aperture should accompany high amplification, and moderate aperture be the accompaniment of low or moderate amplification. We have observed with great regret that students at our Biological Schools in these days of low-priced objectives frequently abandon a fairly good $\frac{1}{2}$ -inch objective of suitable numerical aperture, and obtain in its place a $\frac{1}{8}$ inch or $\frac{1}{10}$ inch with scarcely any increase of numerical aperture, merely for the ease with which amplification is effected. But it would be well to remember that high amplification effects nothing unless accompanied by suitably widened aperture.

The circumstances on which what has been called 'penetration' in objectives is dependent will be shortly considered;² it may be stated here that theory and experience alike show that 'penetration' is reduced with increasing aperture under one and the same amplification. As we have indicated, there are many subjects of study and research presented to the biologist for which he needs as much 'penetration' as possible. This is always the case where the recognition of solid forms—as the infusoria, for example—is important. A fair vision of different planes at once is required.³ Indeed the greater part of all morphological work is of this kind; here, then, in the words of Abbe, 'a proper economy of aperture is of equal importance with economy of power.'⁴

Whenever the depth of the object or objects under observation is not very restricted, and for the purposes of observation we require depth dimension, low and moderate powers must be used; 'and no greater aperture should therefore be used than is required for the effectiveness of these powers—an excess in such a case is a real damage.'⁵

Moreover, in biological work—constant application of the instrument to varied objects—lenses of moderate aperture and suitable power facilitate certainty of action and conserve labour. Increase of aperture involves a diminished working distance in the objective, and it is inseparable from a rapid increase of sensibility of the objectives for slight deviations from the conditions of perfect correction. If it be not *necessary* to encounter the possible difficulties these things involve, to do so is to lose valuable moments. These difficulties, of course, are diminished by the use of homogeneous, and

¹ A *micron* is $\mu = \frac{1}{1000}$ mm. *Vide Journ. R.M.S.* 1888, pp. 502 and 526; and *Nature*, vol. xxxviii, pp. 221, 244.

² See p. 83.

³ Abbe's explanation of the reason of the non-stereoscopic perception of these is given (see pp. 93 *et seq.*).

⁴ 'The Relation of Aperture to Power,' *Journ. R.M.S.* series ii, vol. ii, p. 304.

⁵ *Ibid.*

especially apochromatic objectives, but even with these they are not, in practice, eliminated where the best results are sought.

Employ the full aperture suitable to the power used. This is the practical maxim taught in effect by the Abbe theory of microscopic vision.

It has been suggested that all objectives be made of relatively wide apertures, and that they be 'stopped down' by diaphragms when the work of 'lower apertures' has to be done. But this is not a suggestion that commends itself to the working biologist. If there were no other defects in such a method, the fact that the working distance remains unaltered would be fatal; and we may safely adopt the statement of Abbe,¹ that 'scientific work with the microscope will always require, not only high power objectives of the widest attainable apertures, but also carefully finished lower powers of small and very moderate apertures.'

We complete this section with a *table of numerical apertures*, which will be found on the following page. As already stated, the resolving powers are exactly proportional to the numerical apertures, and the expressions for this latter will allow the resolving power of different objectives to be compared, not only if the medium be the same in each, but also if it be different. The resolving power for an objective, when illuminated by a $\frac{3}{4}$ solid axial cone of white light, is found by multiplying its N.A. by 70,000, and for monochromatic blue-green light (Gifford's screen) by 80,000.²

The first column gives the numerical apertures from .40 to 1.52. The second, third, and fourth, the air-, water-, and oil- (or balsam-) angles of aperture, corresponding to every .02 of N.A. from 47° air-angle to 180° balsam-angle. The theoretical resolving power in lines to the inch is shown in the sixth column; the line E of the spectrum about the middle of the green ($\lambda = 0.5269\mu$) being taken.

The column giving 'illuminating power,' we have already seen, is of less importance; while it must be borne in mind in using the column of 'penetrating power' that several data besides $\frac{1}{a}$ go to make up the total depth of vision with the microscope.

Penetrating Power in Objectives.—Intelligibility and sequence, more than custom, suggest the consideration of this subject at this point. The true meaning and real value of 'depth of focus,' or what is known as 'penetrating power,' follows logically upon the above considerations.

That quality in an objective which was supposed to endow it with a capacity of visual range in a vertical direction, that is, in the direction of the axis of vision, has been called 'penetration,' it being supposed that by this 'property' parts of the object not in the focal plane could be specially presented, so as to enable their perspective and other relations with what lies precisely in the focal plane to be clearly traced out.

Concerning the manner in which this quality of the objective operated, there have been most diverse opinions; indeed, the whole

¹ 'The Relation of Aperture to Power,' *Journ. R.M.S.* series ii. vol. ii, p. 309.

² *Journ. R.M.S.* (1893), p. 17.

I. NUMERICAL APERTURE TABLE.

Numerical Aperture (N.A. = $n \sin \theta$)	Corresponding Angle (2θ) for		Limit of Resolving Power, in Lines to an Inch		Illuminating Power (N.A.) ²	Penetrating Power ($\frac{1}{\text{N.A.}}$)
	Airy	Walter	White Light, ($\lambda = 0.549 \mu$, Line E.)	Mono-chromatic (Blue) Light, ($\lambda = 0.481 \mu$, Line F.)		
1.52	180	0'	146,543	158,815	2.310	658
1.51	166	51'	165,579	157,800	2.280	662
1.50	161	23'	144,615	156,755	2.250	667
1.49	157	12'	143,651	155,710	2.220	671
1.48	153	39'	142,687	154,665	2.190	676
1.47	150	32'	141,723	153,620	2.161	680
1.46	147	12'	140,759	152,575	2.132	685
1.45	145	6'	139,795	151,530	2.103	690
1.44	142	39'	138,830	150,485	2.074	694
1.43	140	22'	137,866	149,440	2.045	699
1.42	138	12'	136,902	148,395	2.016	704
1.41	136	8'	135,938	147,350	1.988	709
1.40	134	10'	134,974	146,305	1.960	714
1.39	132	16'	134,010	145,260	1.932	719
1.38	130	26'	133,046	144,215	1.904	725
1.37	128	40'	132,082	143,170	1.877	729

NOTE.—The Resolutions of Diatoms as given in this column refer solely to the resolution of spurious striae, i.e. diffraction effects, the illumination being an oblique beam in one azimuth.

Appearance at the back of the objective when the eye-piece is removed.
Back of objective full of light. The object will be obliterated except when the power is very low. When the illuminating cone is reduced so that the object can be seen, the illuminating power will be less and the penetrating power greater than the values given below.

Under the above conditions false images are obtained; e.g. a perforated structure would be seen as spurious striae. The resolving limit is therefore one for fallacious images.

Maximum aperture of homogeneous immersion with crown glass covers

Powell and Lealand's lenses constructed with the Abbe-Schott optical glass $\frac{1}{2}$ inch, $\frac{1}{4}$ inch, and $\frac{3}{16}$ inch objectives
Powell and Lealand's $\frac{1}{2}$ inch homogeneous objective

Zeiss's homogeneous and apochromatic objectives; Powell and Lealand's apochromatic $\frac{1}{2}$ inch objective
Powell and Lealand's $\frac{3}{16}$ inch and $\frac{1}{8}$ inch homogeneous objectives

Limit of the resolution of Nobert's 19th band = 113,000 lines to the inch with vertical illumination. It has been resolved to the 19th band by objectives of N.A. 1.4 achromatic

1.26	142° 39'	110° 59'	121,477	131,674	160,017	1588	794
1.25	140° 3'	110° 39'	130,513	130,629	158,747	1563	800
1.24	137° 36'	109° 20'	119,548	129,584	157,477	1538	806
1.23	135° 17'	108° 25'	118,584	128,539	156,207	1513	813
1.22	133° 4'	106° 45'	117,620	127,494	154,937	1488	820
1.21	130° 57'	105° 30'	116,656	126,449	153,668	1464	826
1.20	128° 55'	104° 15'	115,692	125,404	152,397	1440	833
1.19	126° 58'	103° 2'	114,728	124,359	151,128	1416	840
1.18	125° 3'	101° 50'	113,764	123,314	149,857	1392	847
1.17	123° 13'	100° 38'	112,799	122,269	148,588	1369	855
1.16	121° 26'	99° 29'	111,835	121,224	147,317	1346	862
1.15	119° 41'	98° 20'	110,872	120,179	146,048	1323	870
1.14	118° 0'	97° 11'	109,907	119,134	144,777	1300	877
1.13	116° 20'	96° 2'	108,943	118,089	143,508	1277	885
1.12	114° 44'	94° 55'	107,979	117,044	142,237	1254	893
1.11	113° 9'	93° 47'	107,015	115,999	140,968	1232	901
1.10	111° 36'	92° 43'	106,051	114,954	139,698	1210	909
1.09	110° 5'	91° 38'	105,087	113,909	138,428	1188	917
1.08	108° 36'	90° 31'	104,123	112,864	137,158	1166	926
1.07	107° 8'	89° 30'	103,159	111,819	135,888	1145	935
1.06	105° 42'	88° 27'	102,195	110,774	134,618	1124	943
1.05	104° 16'	87° 24'	101,231	109,729	133,348	1103	952
1.04	102° 53'	86° 21'	100,266	108,684	132,078	1082	962
1.03	101° 30'	85° 19'	99,302	107,639	130,808	1061	971
1.02	100° 10'	84° 18'	98,338	106,593	129,538	1040	980
1.01	98° 50'	83° 17'	97,374	105,548	128,268	1020	990
1.00	180° 0'	97° 31'	96,410	104,503	126,998	1000	1000
0.99	163° 48'	96° 12'	95,446	103,458	125,728	980	1010
0.98	157° 2'	94° 56'	80° 17'	102,413	124,458	960	1020
0.97	151° 52'	93° 40'	93,182	101,368	123,188	941	1031
0.96	147° 29'	92° 24'	92,554	100,323	121,918	922	1042
0.95	143° 36'	91° 16'	91,590	99,278	120,648	903	1053
0.94	140° 6'	89° 56'	76° 21'	98,233	119,378	884	1064
0.93	136° 52'	88° 44'	89,661	97,188	118,108	865	1075
0.92	133° 51'	87° 32'	74° 30'	88,697	116,838	846	1087
0.91	131° 0'	86° 20'	73° 33'	87,733	115,568	828	1099
0.90	128° 19'	85° 10'	72° 36'	86,769	114,298	810	1111
0.89	125° 15'	84° 0'	71° 40'	85,805	113,028	792	1124
0.88	123° 17'	82° 51'	70° 44'	84,841	111,758	774	1136
0.87	120° 55'	81° 12'	69° 49'	83,877	110,488	757	1149
0.86	118° 38'	80° 31'	68° 54'	82,913	109,218	740	1163
0.85	116° 25'	79° 37'	68° 0'	81,949	107,948	723	1176
0.84	114° 17'	78° 26'	67° 6'	80,984	106,678	706	1190

Maximum aperture of 'Dry' or air objectives

Limit of resolution of *Amphipleura pellucida*, 95,000 to 95,000 lines to the inch

In actual practice this diatom has been resolved to 95,000 lines per inch. The transverse striae may be easily resolved, and are just discernible with a new apochromatic dry N.A. 1.40 by Powell and Le. Limit of resolution of the form of *Narecia rhomboides* known as *Frostalia sarocina* and *N. crassius*, 78,000 to 87,000 lines to the inch. In *N. crassius* transverse striae 80,500 to the inch have been seen with Powell and Lealand's dry N.A. 1.0

NUMERICAL APERTURE TABLE continued.

Numerical Aperture (N.A.)	Gathering Angle (2θ) for		Hemispherical Apertures (mm)	Limit of Resolving Power, in Lines to an Inch				Illuminating Power (N.A.) ²	Penetrating Power (N.A.) ³
	to	from		White Light (λ = 0.5259 μ, Lohr E.)	Monochromatic (Blue) Light (λ = 0.4861 μ, Lohr F.)	Photography (λ = 0.1000 μ, near Line h _γ)			



Appearance at the back of the objective when the eyepiece is removed.
 Back of objective full of light. The object will be obliterated except when the power is very low. When the illuminating cone is reduced so that the object can be seen, the illuminating power will be less and the penetrating power greater than the values given below.

Under the above conditions false images are obtained; e.g. a perforated structure would be seen as spurious striæ. The resolving limit is therefore one for fallacious images.

0.83	112	12'	77	11'	66	12'	80,020	86,738	105,408
0.82	110	10'	76	8'	65	18'	79,056	85,693	104,138
0.81	108	10'	75	3'	64	24'	78,092	84,648	102,868
0.80	106	16'	75	58'	63	31'	77,128	83,603	101,598
0.79	104	22'	72	53'	62	38'	76,164	82,558	100,328
0.78	102	31'	71	49'	61	45'	75,200	81,513	99,058
0.77	100	42'	70	45'	60	52'	74,236	80,468	97,788
0.76	98	56'	69	42'	60	0'	73,272	79,423	96,518
0.75	97	11'	68	40'	59	8'	72,308	78,378	95,248
0.74	95	28'	67	37'	58	16'	71,343	77,333	94,079
0.73	93	46'	66	34'	57	24'	70,379	76,288	92,709
0.72	92	6'	65	32'	56	32'	69,415	75,242	91,439
0.71	90	28'	64	29'	55	41'	68,451	74,197	90,169
0.70	88	51'	63	31'	54	50'	67,487	73,152	88,899
0.69	87	16'	62	30'	53	59'	66,523	72,107	87,629
0.68	85	41'	61	30'	53	9'	65,559	71,062	86,359
0.67	84	8'	60	30'	52	18'	64,595	70,017	85,089
0.66	82	36'	59	30'	51	28'	63,631	68,972	83,819
0.65	81	9'	58	30'	50	38'	62,667	67,927	82,549

Fig. 40. Resolution of *Dactynotus* (a) with resolution table scale, (b) with resolution table scale, (c) with resolution table scale, (d) with resolution table scale, (e) with resolution table scale. The illumination is not an oblique beam of one seventh.

Resolution of *Colletes coraculata* on Lohr ann. objective, 1.95 N.A., and *Sarcophaga graminis* (type) into checks.

Resolution of *Sarcophaga graminis*, 64,000 to 69,000 lines per inch.

Resolution of *N. rhomboides* from Chesham field.

inch	73° 44'	53° 38'	46° 30'	57,846	62,702	76,199	1,067
→	0.60	53° 38'	46° 30'	57,846	62,702	76,199	360
	0.59	72 18'	52 40'	56,881	61,657	74,923	348
	0.58	70 54'	51 42'	55,918	60,612	73,659	336
	0.57	69 30'	50 45'	54,954	59,567	72,389	325
	0.56	68 6'	49 48'	53,990	58,522	71,119	311
	0.55	66 44'	49 51'	53,026	57,477	69,849	303
	0.54	65 22'	47 51'	52,061	56,432	68,579	292
	0.53	64 0'	46 58'	51,097	55,387	67,309	281
	0.52	62 40'	46 2'	50,133	54,342	66,039	270
	0.51	61 26'	45 6'	49,169	53,297	64,769	260
	0.50	60 0'	44 10'	48,205	52,252	63,499	250
	0.48	57 22'	42 18'	46,277	50,162	60,959	230
	0.46	54 17'	40 28'	44,349	48,072	58,419	212
	0.45	53 30'	39 33'	43,385	47,026	57,149	203
	0.44	52 13'	38 38'	42,420	45,981	55,879	191
	0.42	49 10'	36 19'	40,492	43,891	53,339	176
	0.40	47 9'	35 0'	38,564	41,801	50,799	160
	0.38	44 10'	33 12'	36,636	39,711	48,259	144
	0.36	42 12'	31 24'	34,708	37,621	45,719	130
	0.35	40 58'	30 30'	33,744	36,576	44,449	123
	0.34	39 14'	29 37'	32,779	35,531	43,179	116
	0.32	37 20'	27 51'	30,851	33,441	40,639	102
	0.30	34 56'	26 4'	28,923	31,351	38,099	90
	0.28	32 32'	24 18'	26,995	29,261	35,559	78
	0.26	30 9'	22 33'	25,067	27,171	33,019	68
	0.25	28 58'	21 40'	24,103	26,126	31,719	63
	0.24	27 46'	20 48'	23,138	25,081	30,479	58
	0.22	25 26'	19 2'	21,210	22,991	27,940	48
	0.20	23 4'	17 18'	19,282	20,901	25,400	40
	0.18	20 44'	15 31'	17,354	18,811	22,860	32
	0.16	18 24'	13 50'	15,426	16,721	20,320	26
	0.15	17 11'	12 58'	14,462	15,676	19,030	23
	0.14	16 5'	12 6'	13,498	14,630	17,780	20
	0.12	13 47'	10 22'	11,570	12,540	15,240	11
	0.10	11 29'	8 58'	9,641	10,450	12,700	6
	0.08	9 11'	6 54'	7,713	8,360	10,160	4
	0.06	6 53'	5 10'	5,785	6,270	7,620	3
	0.05	5 44'	4 18'	4,821	5,225	6,350	2

Example illustrating the accompanying Table.

The apertures of four objectives, two of which are dry, one water-immersion, and one oil-immersion, would be compared on the angular aperture view as follows :

Air	Air	Water	Oil
106	157	142	130
.80	.98	1.26	1.38

Their true aperture are, however, as or as their numerical apertures.

matter was involved in obscurity. The remarkable insight and learning of Professor Abbe have, however, found for this important subject a sound scientific basis.

The delineation of *solid* objects by a system of lenses is by virtue of the most general laws of optical delineation, subject to a peculiar disproportion in amplification. The linear amplification of the *depth*-dimension is, when both the object and the image are in the same medium (air), found to be always equal to the *square* of the linear amplification of the dimensions at right angles to the optical axis; but if the object be in a more highly refracting medium than air, it is equal to this square divided by the refractive index of the medium. In proportion to the lateral amplification there is a progressive, and with high powers a rapidly increasing, *over-amplification* of the depth of the three-dimensional image. If a transverse section of an object is magnified 100 times in breadth the distance between the planes of parts lying one behind the other is magnified 10,000 times at the corresponding parts on the axis when the object is in air, 7500 times when it is in water, and 6600 times when it is in Canada balsam.

This excessive distortion in the case of high amplifications is not, however, *of itself* so complete a hindrance to correct appreciation of solid forms in the microscopical image as at first appears. The appreciation of solid form is not a matter of sensation only; it is a mental act—a conception—and, therefore, the peculiarity of the optical image, however great the amplification, would not prevent the conception of the solidity of the object so long as salient points for the construction of a *three-dimensional* image were found. But for this the solid object, as such, must be simultaneously visible; a single layer of inappreciable depth can convey no conception of the *three* space dimensions possessed by the object.

Owing to the disproportional amplification of the depth-dimension normal to the action of optical instruments, the visual space of the microscope loses more and more in depth as the amplification increases, and thus constantly approximates to a bare horizontal section of the object.

The visual space, which at one adjustment of the focus is plainly visible, is made up of two parts, the limits of which as regards the *depth* are determined in a very different manner.

First, *the accommodation of the eye* embraces a certain depth, different planes being successively depicted with perfect sharpness of image on the retina, whilst the eye, adjusting itself by conscious or unconscious accommodation, obtains virtual images of greater or less distance of vision. This depth of accommodation, which plays the same part in microscopical as in ordinary vision, is wholly determined by the extent of power in this direction possessed by the particular eye, the limits being the greatest and the least distance of distinct vision. Its exact numerical measure is the difference between the *reciprocal* values of these two extreme distances. The depth of distinct vision is directly proportional to this numerical equivalent of the accommodation of the eye, directly proportional to the refractive medium of the object, and inversely proportional to the square of the amplification when referred always to the same

image-distance. For example, a moderately short-sighted eye sees distinctly at 150 mm. as its shortest distance, and at 300 mm. as its longest distance; then the numerical equivalent of the extent of accommodation would be equal to $\frac{1}{300}$ mm.; the calculation for an object in air would give a depth of vision by accommodation amounting to

2.08 mm.	with 10 times amplification	
0.23	.. 30	..
0.02	.. 100	..
0.0023	.. 300	..
0.00021	.. 1000	..
0.00002	.. 3000	..

These figures are modified by the medium in which the object is placed and by the greater or less shortness and length of vision.

Secondly, the perception of depth is assisted by the insensibility of the eye to small defects in the union of the rays in the optic image, and therefore to small circles of confusion in the visual image. Transverse sections of the object which are a little above and below the exact focal adjustment are seen without prejudicial effects. *The total effect so obtained is the so-called penetration or depth of focus of an objective.* This may be determined numerically by defining the allowable magnitude of the circles of confusion in the microscopical image by the visual angle under which they appear to the eye. It is found that one minute of arc denotes the limit of sharply defined vision, two to three minutes for fairly distinct vision, and five to six minutes the limits of vision only just tolerable. This being determined, the focal depth depends only on the refractive index of the medium in which the object is placed, the amplification, and the angle of aperture, and it is directly proportional to the refractive index of the object medium, and inversely proportional to the 'numerical aperture' of the objective, as also to the first power of the amplification. These assume the visible angle of allowable indistinctness to be fixed at 5', the aperture angle of the image-forming pencils to be 60° in air; the depth of focus of an object in air will then be—

0.073 mm.	for 10 times amplification	
0.024	.. 30	..
0.0073	.. 100	..
0.0024	.. 300	..
0.00073	.. 1000	..
0.00024	.. 3000	..

By limiting or enlarging the allowable magnitude of indistinctness in the image we correspondingly modify these figures, as we should do with media of different refractive indices and increased aperture-angle.

It is plain, then, that the actual *depth of vision* must always be the exact sum of the *accommodation depth* and *focal depth*. The former expresses the object space through which the eye by the play of accommodation can penetrate and secure a sharp image; the latter gives the amount by which this object-space is extended in its limits—reckoning both from above and below—because without perfect sharpness of image there is still a sufficient distinctness of vision.

As the amplification increases the over-amplification of the depth dimension presents increasingly unfavourable relation between the depth and width of the object-space accessible to accommodation. When low powers are employed we have relatively great depth of vision, because we have large accommodation-depth; but as we pass to medium powers, the accommodation-depth diminishes in rapid ratio, becoming equal to only a small depth of focus; while when the magnifying power is greatly increased the accommodation-depth is a factor of no moment, and we have vision largely, indeed almost wholly, dependent on depth of focus.

The following table shows the total depth of vision from ten to 3,000 times:—

Amplification	Diameter of Field	Accommodation Depth	Focal Depth	Depth of Vision, Accommodation Depth, and Focal Depth	Ratio of Depth of Vision to Diameter of Field
	mm.	mm.	mm.	mm.	1
10	25.0	2.08	0.073	2.153	11.6
					1
30	8.3	0.23	0.024	0.254	32.7
					1
100	2.5	0.02	0.0073	0.0273	91.6
					1
300	0.83	0.0023	0.0024	0.0047	176.6
					1
1000	0.25	0.00021	0.00073	0.00094	266
					1
3000	0.083	0.00002	0.00024	0.00026	319

It has been pointed out by Abbe that this over-amplification of depth-dimension, though it limits the direct appreciation of solid forms, yet is of great value in extending the indirect recognition of space relations. When with increase of magnifying power the depth of the image becomes more and more flattened, the images of different planes stand out from each other more perfectly in the same ratio, and in the same degree are clearer and more distinct. With an increase of amplification the microscope acquires increasingly the property of an optical *microtome*, which presents to the observer's eye sections of a fineness and sharpness which would be impossible to a mechanical section. It enables the observer, by a series of adjustments for consecutive planes, to *construe* the solid forms of the smallest natural objects with the same certainty as he is accustomed to *see* with the naked eye the objects with which it is concerned. This is a large advantage in the general scientific use of the instrument; a greater gain, in fact, than could be expected from the application of stereoscopic observation.

Stereoscopic Binocular Vision.—This subject has been elaborately considered and partially expounded and demonstrated by Professor Abbe; his exposition differs in some important particulars from that of the original author of this book, but in its present incomplete

forms it appears to the editor to be the wiser way to allow Dr. Carpenter's treatment of the subject to stand, and to place below it as complete a digest of Professor Abbe's theory and explanation of the same subject as the data before us will admit.

The admirable invention of the *stereoscope* by Professor Wheatstone has led to a general appreciation of the value of the *conjoint use of both eyes* in conveying to the mind a notion of the *solid forms* of objects, such as the use of either eye singly does not generate with the like certainty or effectiveness; and after several attempts, which were attended with various degrees of success, the principle of the stereoscope has now been applied to the microscope, with an advantage which those only can truly estimate who (like the Author) have been for some time accustomed to work with the stereoscopic binocular¹ upon objects that are peculiarly adapted to its powers. As the result of this application cannot be rightly understood without some knowledge of one of the fundamental principles of binocular vision, a brief account of this will be here introduced. All vision depends in the first instance on the formation of a picture of the object upon the retina of the eye, just as the camera obscura forms a picture upon the ground glass placed in the focus of its lens. But the two images that are formed by the two eyes respectively of any solid object that is placed at no great distance in front of them are far from being identical, the perspective projection of the object varying with the point of view from which it is seen. Of this the reader may easily convince himself by holding up a thin book in such a position that its back shall be at a moderate distance in front of the nose, and by looking at the book, first with one eye and then with the other: for he will find that the two views he thus obtains are essentially different, so that if he were to represent the book as he actually sees it with each eye, the two pictures would by no means correspond. Yet on looking at the object with the two eyes conjointly, there is no confusion between the images, nor does the mind dwell on either of them singly; but from the blending of the two a conception is gained of a solid projecting body, such as could only be otherwise acquired by the sense of touch. Now if, instead of looking at the solid object itself, we look with the *right* and *left* eyes respectively at *pictures* of the object, corresponding to those which would be formed by it on the retine of the two eyes if it were placed at a moderate distance in front of them, and these visual pictures are brought into coincidence, the same conception of a solid projecting form is generated in the mind, as if the object itself were there. The stereoscope—whether in the forms originally devised by Professor Wheatstone or in the popular modification long subsequently introduced by Sir D. Brewster—simply serves to bring to the two eyes, either by reflexion from mirrors or by refraction through prisms or lenses, the two dissimilar pictures which would accurately represent the solid object as seen by the two eyes respec-

¹ It has become necessary to distinguish the binocular microscope which gives true *stereoscopic* effects by the combination of two dissimilar pictures from a binocular which simply enables us to look with both eyes at images which are essentially identical (p. 106).

tively, these being thrown on the two retinae in the precise positions they would have occupied if formed there direct from the solid object, of which the mental image (if the pictures have been correctly taken) is the precise counterpart. Thus in fig. 69 the upper pair of pictures (A,B) when combined in the stereoscope suggest the idea of a *projecting* truncated pyramid, with the small square in the centre and the four sides sloping equally away from it; whilst the combination of the lower pair, C, D (which are identical with the upper, but are transferred to opposite sides), no less vividly brings to the mind the visual conception of a *receding* pyramid, still with the small square in the centre, but the four sides sloping equally towards it.

Thus we see that by simply *crossing* the pictures in the stereoscope, so as to bring before each eye the picture taken for the other, a 'conversion of relief' is produced in the resulting solid image, the projecting parts being made to recede and the receding parts brought into relief. In like manner, when several objects are com-

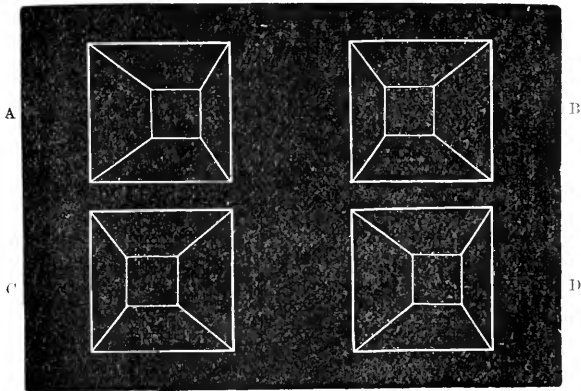

FIG. 69.

bined in the same crossed pictures, their apparent relative distances are reversed, the remoter being brought nearer and the nearer carried backwards; so that (for example) a stereoscopic photograph representing a man standing in front of a mass of ice shall, by the crossing of the pictures, make the figure appear as if imbedded in the ice. A like conversion of relief may also be made in the case of actual solid objects by the use of the *pseudoscope*, an instrument devised by Professor Wheatstone, which has the effect of reversing the perspective projections of objects seen through it by the two eyes respectively; so that the interior of a basin or jelly-mould is made to appear as a projecting solid, whilst the exterior is made to appear hollow. Hence it is now customary to speak of *stereoscopic* vision as that in which the conception of the true natural relief of an object is called up in the mind by the normal combination of the two perspective projections formed of it by the right and left eyes respectively; whilst by *pseudoscopic* vision we mean that 'conversion of relief' which is produced by the combination of two *reversed*

perspective projections, whether these be obtained directly from the object (as by the pseudoscope) or from 'crossed' pictures (as in the stereoscope). It is by no means every solid object, however, or every pair of stereoscopic pictures which can become the subject of this conversion. The degree of facility with which the 'converted' form can be apprehended by the mind appears to have great influence on the readiness with which the change is produced. And while there are some objects—the interior of a plaster mask of a face, for example—which can always be 'converted' (or turned inside out) at once, there are others which resist such conversion with more or less of persistence.¹

Now it is easily shown theoretically that the picture of any projecting object seen through the microscope with only the *right*-hand half of an objective having an even moderate angle of aperture, must differ sensibly from the picture of the same object received through the *left* hand of the same objective; and, further, that the difference between such pictures must increase with the angular aperture of the objective. This difference may be practically made apparent by adapting a 'stop' to the objective in such a manner as to cover either the right or the left half of its aperture, and then by carefully tracing the outline of the object as seen through each half. But it is more satisfactorily brought into view by taking two photographic pictures of the object, one through each lateral half of the objective; for these pictures when properly paired in the stereoscope give a magnified image *in relief*, bringing out on a large scale the solid form of the object from which they were taken. What is needed, therefore, to give the true stereoscopic power to the microscope is a means of so bisecting the cone of rays transmitted by the objective that of its two lateral halves one shall be transmitted to the right and the other to the left eye. If, however, the image thus formed by the *right* half of the objective of a compound microscope were seen by the *right* eye, and that formed by the *left* half were seen by the *left* eye, the resultant conception would be not *stereoscopic* but *pseudoscopic*, the projecting parts being made to appear receding, and *vice versa*. The reason of this is, that as the microscope itself reverses the picture, the rays proceeding through the *right* and the *left* hand halves of the objective must be made to cross to the *left* and the *right* eyes respectively, in order to correspond with the *direct* view of the object from the two sides; for if this second reversal does not take place, the effect of the first reversal of the images produced by the microscope exactly corresponds with that produced by the 'crossing' of the pictures in the stereoscope, or by that reversal of the two perspective projections formed direct from the object, which is effected by the pseudoscope. It was from a want of due appreciation of this principle (the truth of which can now be practically demonstrated) that the earlier attempts at producing a stereoscopic binocular microscope tended rather to produce a 'pseudoscopic conversion' of the objects viewed by it than to represent them in this true relief.

¹ For a fuller discussion of this subject see the Author's *Mental Physiology*, §§ 168-170.

In contradistinction to this explanation of binocular vision Dr. Abbe, as we have seen, has demonstrated that oblique vision in the microscope is wholly unlike ordinary vision; there is, in fact, no perspective. The perspective shortening of lines and surfaces by oblique projection is entirely lost in the microscope, and, as a consequence, it is contended that the special dissimilarity which is the *raison d'être* of ordinary stereoscopic effects does not exist, but that an essentially different mode of dissimilarity is found between the two pictures. The outline or contour of a microscopic object is unaltered, whether viewed by an axial or an oblique pencil; there is no foreshortening, there is simply lateral displacement of the images of consecutive layers. But Abbe contends that, whilst the manner in which dissimilar pictures are formed in the binocular microscope is different from that by which they are brought about in ordinary stereoscopic vision, yet the activities of the brain and mind by which they are so blended as to give rise to sensations of solidity, depth, and perspective are practically identical.

The fact that lateral displacements of the image are seen in the microscope depends on a peculiar property of microscopic amplification, which is in strong contrast to the method of ordinary vision. It depends entirely on the fact, enunciated above, that the amplification of the depth is largely exaggerated. Hence solid vision in the binocular microscope is confined to large and coarse objects, the dimensions of which are large multiples of the wave-length. It therefore follows that when moderate or large apertures have to be employed—that is to say, whenever delineation requires the employment of oblique rays—the elements of the object are no longer depicted as solid objects seen by the naked eye or through the telescope would be depicted; nevertheless the brain arranges them so that the characteristics of solid vision are still presented.

Professor Abbe demonstrates¹ that in an aplanatic system pencils of different obliquities yield *identical* images of every plane object, or of a single layer of a solid object. This is true however large the aperture may be.

This carries with it, as we have said, a total absence of perspective and an essential geometrical difference between vision with the binocular microscope and vision with the unaided eye.

An object, not quite flat, as a curved diatom, when observed with an objective of wide aperture will present points of great indistinctness. This has been by some supposed to arise from the assumption that there was a dissimilarity between the images formed by the axial and oblique pencils; but this is not so. It is wholly explicable by the fact that the depth of the object is too great for the small depth of vision attendant upon a large aperture.

It will be seen, then, that so long as the depth of the object is within the limits of the depth of vision, corresponding to the aperture and amplification in use, we obtain a distinct *parallel projection* of all the successive layers in one common plane perpendicular to the axis of the microscope—a ground plan, as it were, of the object. Manifestly, then, since depth of vision decreases with increasing

¹ *Journ. R.M.S.* series ii. vol. iv. pp. 21-24.

aperture, good delineation with these must be confined to *thinner objects* than can be successfully employed with objectives of narrow apertures.

Stereoscopic vision with the microscope, therefore, is due solely to difference of projection exhibited by the different parallaxic displacements of the images of successive layers on the common ground plane and to the *perception of depth*, not to the delineation of the plane layers themselves. For, if there were dissimilar images perceptible at different planes, the out-of-focus layers must appear confused and *no vision of depth* would be possible.

Now stereoscope vision requires, as shown by Dr. Carpenter, that the delineating pencils shall be so divided that one portion of the admitted cone of light is conducted to one eye and another portion to the other eye. If this division of the image is effected in a symmetrical way, the cross section of, e.g., a circle must be reduced to two semicircles representing one of these two arrangements seen in O and P, fig. 70.



FIG. 70.

Dr. Abbe's theory is that the only condition necessary for *orthoscopic* effect in any binocular system is that these semicircles or their equivalents should be depicted according to diagram O, fig. 70, and for *pseudoscopic* effect according to diagram P in the same figure; and he demonstrates that all other circumstances, such, e.g., as the crossing of the images, are wholly immaterial.

Orthoscopic vision is always obtained when the right half of the right pupil and the left half of the left pupil only are employed; pseudoscopic vision in the opposite conditions. It is quite indifferent whether the effect is obtained with crossing or non-crossing rays, whether the image be erect, or inverted, or semi-inverted, and whatever may be components of the optical arrangement.

The observant reader will perceive that it is at this point that there is a radical divergence from the interpretation given by Dr. Carpenter, who, as we have seen above, insisted that orthoscopic vision is not to be obtained in a binocular with non-erecting eye-pieces unless the axes of the two halves of the admitted cone *cross each other*.

Of course we must keep clearly before us the fact that in microscopic vision it is not the object but its virtual image only that we see. This apparently solid *image* is placed in the binocular microscope under circumstances similar to those of common *objects* in ordinary vision. Clearly, then, it is the perspective projections of this *image* which require to be compared to the projections of solid objects in ordinary vision, in respect to which the criteria of orthoscopic and pseudoscopic vision have been defined. But it can be geometrically demonstrated that right-eye perspective of the apparently solid *image* is always obtained from the right-hand portion of the emergent pencils, left-eye perspective from the left-hand portion :

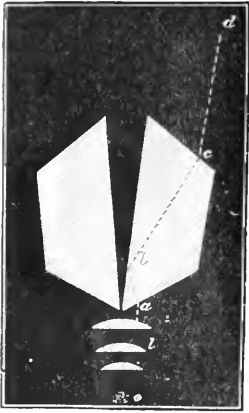

FIG. 72.

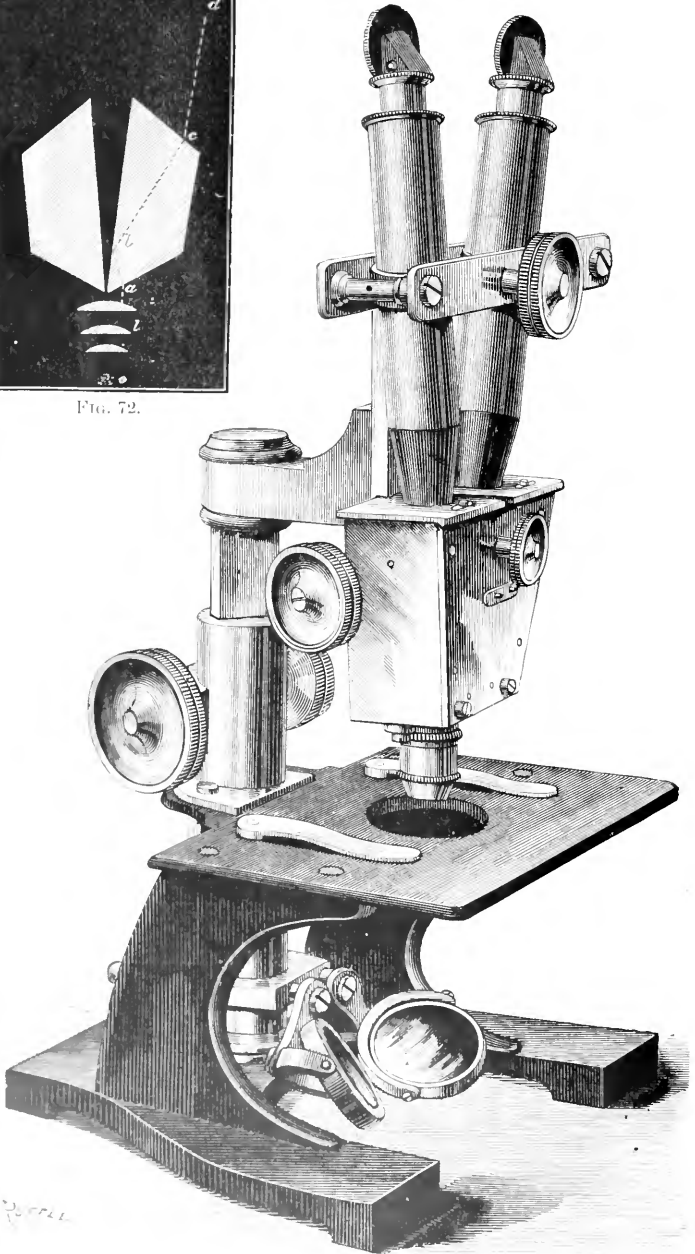

FIG. 71.

and it is quite immaterial, as regards this result, which portion of the emergent rays is admitted by the right or the left part of the objective.

The manner in which the delineating pencils are transmitted through the system may be such as to require crossing over of the rays from the right-hand half of the objective to the left eye-piece, and *vice versa*. But it is not essential to binocular effect. In the Wenham and Nacet binocular (pp. 98, 99) crossing over is required because the inversion of the pencils is not changed by two reflexions. If the delineating pencils have been reflected an *even number* of times in the same plane, it will be necessary for the rays to cross; but if they have been reflected an odd number of times, it is not only unnecessary, but is destructive of orthoscopic effect, provided ordinary eye-pieces (non-erecting) are employed. Hence in the Stephenson binocular it is not only not required, but would give pseudoscopic effect.

Principal Forms of Binocular Microscopes.—The first binocular of a practical character was the arrangement of Professor J. L. Riddell, of New Orleans. It was devised in 1851 and constructed in 1852, and a description of its nature and its genesis was given by him in the second volume of the first series of the 'Quarterly Journal of Microscopical Science' in the year 1854.¹

A representation of his original instrument is presented in fig. 71, and the arrangement of the prisms by which the binocular effect was obtained is shown in fig. 72.

It will be seen that the pencil of rays emerging from the back lens of the combination *l* is divided into two, each half passing respectively into the right and left prisms; the path of the rays is indicated at *a, b, c, d*, the object being at *o*.

To secure coincidence of the images in the field of view for varying widths between the eyes Professor Riddell devised (1) a means of regulating the inclination of the prisms by mounting them in hinged frames, so that, while their lower edges, near *a*, fig. 72, remain always in parallel contact, the inclination of the internal reflecting surfaces can be varied by the action of the milled head in front of the prism box; (2) the lower ends of the binocular tubes are connected by travelling sockets, moving on one and the same axis, on which are cut corresponding right- and left-handed screws, so that the width of the tubes may correspond with that of the prisms; and (3) the upper ends of the tubes are connected by racks, one acting above and the other below the same pinion, so that right- and left-handed movements are communicated by turning the pinion.

This instrument could only be used in a vertical position, as shown in the figure (71). The two prisms in fig. 72 correct the inversion of the image in a lateral direction, two more prisms are needed to correct the inversion in the vertical direction. These Professor Riddell placed above the eye cups, but now they are placed immediately above the binocular prisms, fig. 78.

This system of binocular excited much interest in England immediately after its publication, and Mr. Wenham in London and MM. Nacet, of Paris, soon suggested and devised a variety of binocular systems.

¹ P. 13.

Nachet's Binocular was early in the field, but was not a practical construction on account of the parallelism of its tubes, and is not now advocated by its inventor or adopted by opticians of any country.

Wenham's Stereoscopic Binocular.—All these objections are overcome in the admirable arrangement devised by the ingenuity of

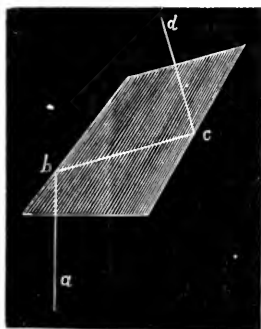

FIG. 73.—Wenham's prism (1860).

Mr. Wenham, in 1860 (Trans. Microscopical Soc. of London, vol i. N.S. p. 15), in whose binocular the cone of rays proceeding upwards from the objective is divided by the interposition of a prism of the peculiar form shown in fig. 73, so placed in the tube which carries the objective (figs. 74, 75, *a*), as only to interrupt one half, *a c*, of the cone, the other half, *a b*, going on continuously to the eyepiece of the principal or right-hand body, R, in the axis of which the objective is placed. The interrupted half of the cone (figs. 73, 74, *a*), on its entrance into the prism, is scarcely subjected to any *refraction*, since its axial ray is perpendicular to the surface it meets; but within the prism it is subjected to two *reflections* at *b* and *c*, which send it forth again obliquely in the line

towards the eye-piece of the secondary or left-hand body (fig. 74, L); and since at its emergence its axial ray is again perpendicular

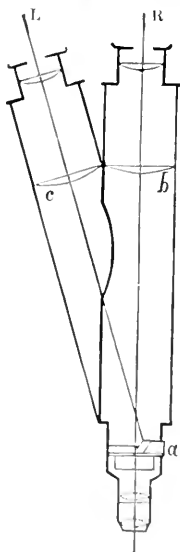

FIG. 74.

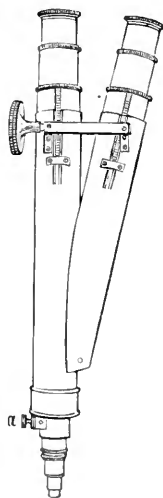

FIG. 75.

Wenham's stereoscopic binocular microscope (1860).

towards the eye-piece of the secondary or left-hand body (fig. 74, L); and since at its emergence its axial ray is again perpendicular

to the surface of the glass, it suffers no more refraction on passing out of the prism than on entering it. By this arrangement the image received by the *right* eye is formed by the rays which have passed through the *left* half of the objective, and have come on without any interruption whatever; whilst the image received by the *left* eye is formed by the rays which have passed through the *right* half of the objective, and have been subjected to two reflexions within the prism, passing through only *two* surfaces of glass. The adjustment for the variation of distance between the axes of the eyes in different individuals is made by drawing out or pushing in the eye-pieces, which are moved consentaneously by means of a milled head, as shown in fig. 75. Now, although it may be objected to Mr. Wenham's method (1) that, as the rays which pass through the prism and are obliquely reflected into the secondary body traverse a longer distance than those which pass on uninterruptedly into the principal body, the picture formed by them will be somewhat larger than that which is formed by the other set; but this can be easily compensated for by (*a*) altering the power of one of the eye-pieces, (*b*) by increasing the tube length of the direct tube: and (2) that the picture formed by the rays which have been subjected to the action of the prism must be inferior in distinctness to that formed by the uninterrupted half of the cone of rays; these objections are found to have no practical weight. For it is well known to those who have experimented upon the phenomena of stereoscopic vision (1) that a slight difference in the size of the two pictures is no bar to their perfect combination; and (2) that if one of the pictures be good, the full effect of relief is given to the image, even though the other picture be faint and imperfect, provided that the outlines of the latter are sufficiently distinct to represent its perspective projection. Hence if, instead of the two equally *half-good* pictures which are obtainable by MM. Nacet's original construction, we had in Mr. Wenham's one *good* and one *indifferent* picture, the latter would be decidedly preferable. But, in point of fact, the deterioration of the *second* picture in Mr. Wenham's arrangement is less considerable than that of *both* pictures in the original arrangement of MM. Nacet: so that the optical performance of the Wenham binocular is in every way superior. It has, in addition, these further advantages over the preceding: First, the greater comfort in using it (especially for some length of time together), which results from the convergence of the axes of the eyes at their usual angle for moderately near objects; secondly, that this binocular arrangement does not necessitate a special instrument, but may be applied to any microscope which is capable of carrying the weight of the secondary body, the prism being so fixed in a movable frame that it may in a moment be taken out of the tube or replaced therein, so that when it has been removed the principal body acts in every respect as an ordinary microscope, the entire cone of rays passing uninterruptedly into it; and thirdly, that the simplicity of its construction renders its derangement almost impossible.¹

¹ The Author cannot allow this opportunity to pass without expressing his sense of the liberality with which Mr. Wenham freely presented to the public this im-

Stephenson's Binocular.—A new form of stereoscopic binocular has been introduced by Mr. Stephenson,¹ which has certain distinctive features, and at the time Mr. Stephenson devised it he was

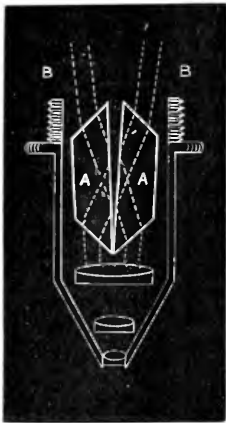

FIG. 76.—Riddell's binocular prisms, as applied by Mr. Stephenson (1870).

entirely unaware that any part of the method he employed had been used by another. He had, however, independently conceived Riddell's device for dividing the beam as a part of his very ingenious instrument. This he discovered and acknowledged about three years after the full description and completion of his binocular.²

The cone of rays passing upwards from the object-glass meets a pair of prisms (A A, fig. 76) fixed in the tube of the microscope immediately above the posterior combination of the objective, so as to catch the light-rays on their emergence from it; these it divides into two halves and behaves as described in the Riddell prisms, which, in fact, they are. As the cone of rays is equally divided by the two prisms, and its two halves are similarly acted on, the two pictures are equally illuminated, and of the same size; while the close approximation of the prisms to the back lens of the objective enables even high powers to be used with very little loss of light or of definition, provided that the angles and surfaces of the prisms are worked with exactness; and as the two bodies can be made to converge at a smaller angle than in the Wenham arrangement, the observer looks through them with more comfort. But Mr. Stephenson's ingenious arrangement is liable to the great drawback of not being convertible (like Mr. Wenham's) into an ordinary monocular by the withdrawal of a prism, so that the use of this form of it will be probably restricted to those who desire to work with a binocular when employing high powers.

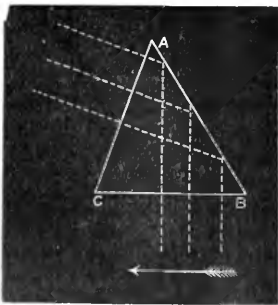

FIG. 77.—Stephenson's erecting prism (1870).

But one of the greatest advantages attendant on Mr. Stephenson's construction is its capability of being combined with an *erecting* arrangement, which renders it applicable to purposes for which the Wenham binocular cannot be conveniently used. By the interposition of a plane silvered mirror, or (still better) of a reflecting

without invention, by which, there can be no doubt, he might have largely profited if he had chosen to retain the exclusive right to it.

¹ *Monthly Microscopical Journal*, vol. iv. (1870), p. 61, and vol. vii. (1872), p. 167.

² *Ibid.* vol. x. p. 11.

prism (fig. 77), above the tube containing the binocular prisms, each half of the cone of rays is so deflected that its image is reversed *vertically*, the rays entering the prism through the surface C B, being reflected by the surface A B, so as to pass out again by the surface A C in the direction of the dotted lines. Thus the right and the left half-cones are directed respectively into the right and the left bodies, which are inclined at a convenient angle, as shown in fig. 78; so that—the stage being horizontal—the instrument becomes a most useful compound dissecting microscope, and as thus arranged by Swift, with well adjusted rests for the hands, has but few equals for the purposes of minute dissections and delicate mounting operations; indeed, the value of the erecting binocular consists in its applicability to the picking out of very minute objects, such as *Diatoms*, *Polycystina*, or *Foraminifera*, and to the prosecution of minute dissections, especially when these have to be carried on in fluid. No one who has only thus worked *monocularly* can appreciate the guidance derivable from *binocular* vision when once the habit of working with it has been formed.

Tolles's Binocular Eye-piece.

An ingenious eye-piece has been constructed by Mr. Tolles (Boston, U.S.A.), which, fitted into the body of a monocular microscope, converts it into an erecting stereoscopic binocular. This conversion is effected by the interposition

of a system of prisms similar to that originally devised by MM. Nacet, but made on a larger scale, between an 'erector' (resembling that used in the eye-piece of a day-telescope) and a pair of ordinary Huyghenian eye-pieces, the *central* or *dividing* prism being placed at or near the plane of the secondary image formed by the erector, while the two eye-pieces are placed immediately above the two *lateral* prisms, and the combination thus making that division in the pencils forming the secondary image which in the Nacet binocular it makes in the pencils emerging from the objective. As all the image-forming rays have to pass through the two surfaces of four lenses and two prisms, besides sustaining two internal reflexions in the latter, it is surprising that Professor H. L. Smith, while admitting a loss of light, should feel able to speak of the definition of this instrument as not inferior to that of either the Wenham or the Nacet binocular. It is obviously a great advantage that this eye-piece can be used with any microscope and with objectives of high power; but as its effectiveness must depend upon extraordinary accuracy of workmanship its cost must necessarily be great.¹

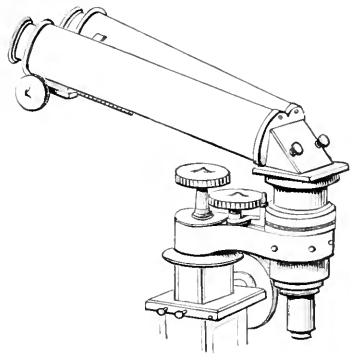

FIG. 78.—Stephenson's erecting binocular (1870).

¹ See *American Journal of Science*, vol. xxxviii. (1864), p. 111, and vol. xxxix. (1865), p. 212; and *Monthly Microsc. Journal*, vol. vi. (1871), p. 45.

A form of this binocular eye-piece was made by Professor Abbe with the ingenuity and thoroughness characteristic of the firm of Zeiss; but in spite of its beauty as an optical instrument, and its usefulness as applicable to any tube, and especially the shorter tubes to which the Wenham binocular could not well apply, the double image in the right-hand tube was most conspicuously apparent, greatly interfering with the perfection of the stereoscopic image. On this account chiefly it has not come into general use. We are nevertheless indebted to the firm of Zeiss for the introduction of a very satisfactory form of binocular instrument, of which we can speak with unconditional praise. It is designated as Greenough's binocular microscope, and we can confidently affirm that it furnishes an accurate solid and withal an *erect* image, so that for all the

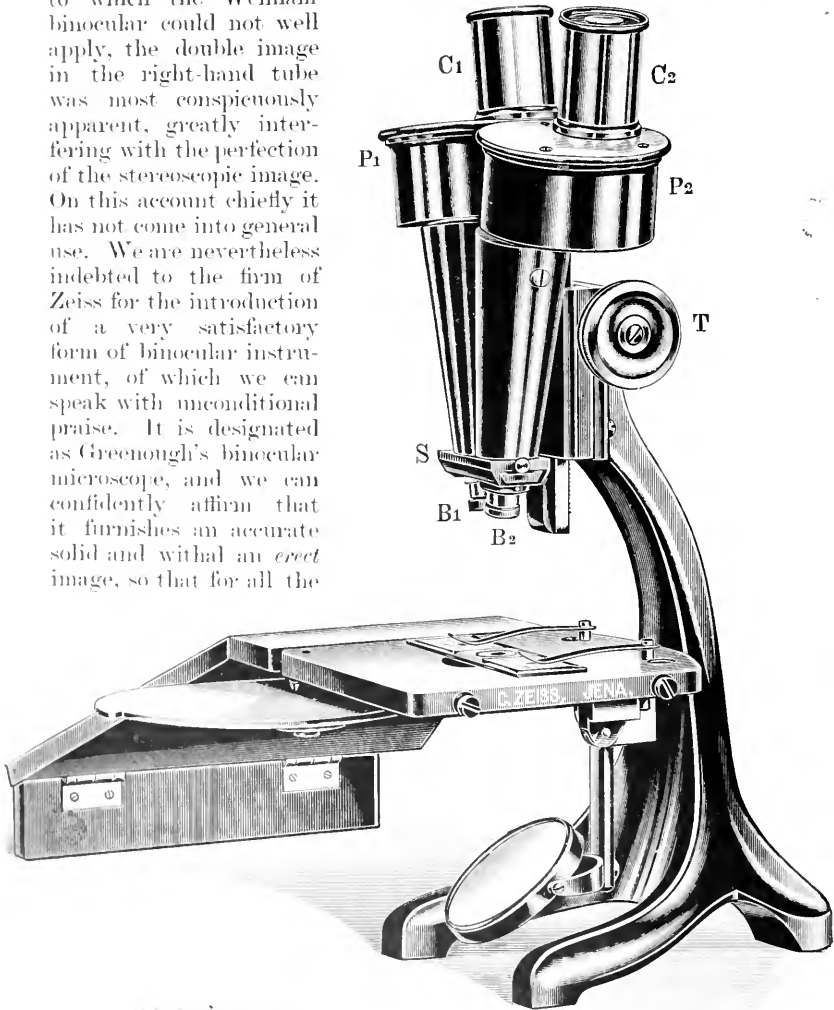

FIG. 79.—Greenough's binocular microscope (1897).

purposes for which the use of the binocular is at present desirable it accomplishes what is sought, and will be found invaluable for zoologists, botanists, and embryologists. The microscope is shown in fig. 79.

and has been constructed by means of a combination of *Porro* prisms with a compound microscope of the usual optical type; it possesses many of the advantages of the compound microscope, but inevitably loses light by the passing of the ray through so many prisms, yet by means of the *Porro* prisms the inverted image is rendered erect. This may be practically illustrated by fig. 80, which shows that the rays of light in passing from the object to the eye undergo four successive reflexions at the surfaces of the prisms and emerge from the last prism with undiminished intensity. The prisms, it will be seen, have the effect of erecting the inverted image formed by the object-glass. But in this microscope binocular vision is obtained, not as in the usual form of binocular microscope, by the subsequent division of a pencil of light passing through *one object-glass*; but two complete microscopes, each having its own objective and eye-pieces, are simultaneously directed upon the object. This secures perfect stereoscopic (orthomorphic) vision, but of course no power higher than $1\frac{1}{2}$ inch can be employed. The path of the rays is more clearly seen in fig. 81, giving a diagram by Mr. Nelson with one of the prisms turned round 90° to make clearer the action of the prisms on the ray. It is well to note that, when two of these erectors with a double objective binocular are used, the distance between the eyes can be compensated for by merely turning the erector adaptors round in the microscope tube.

This method of erection, which is both valuable and practical, was first described in Zalm's 'Oculus Artificialis' (1702), only reflectors were used instead of prisms, but the path of the rays is diverted in precisely the same way as with the *Porro* prisms.

The stereoscopic binocular is put to its most advantageous use when applied either to *opaque* objects of whose solid forms we are desirous of gaining an exact appreciation or to *transparent* objects which have such a thickness as to make the accurate distinction between their nearer and their more remote planes a matter of importance. All stereoscopic vision with the microscope, so far as it is anything more than mere seeing with two eyes, depends, as already seen, exclusively upon the unequal inclination of the pencils which form the two images to the plane of the preparation, or the axis of the microscope. By uniform halving of the pencils—whether by prisms above the objective or by diaphragms over the eye-pieces—the difference in the directions of the illumination in regard to the preparation reaches approximately the half of the angle of aperture of the objective, provided that its whole aperture is filled with rays. By the one-sided halving we have been considering, the direct image is produced by a pencil the axis of which is perpendicular to the

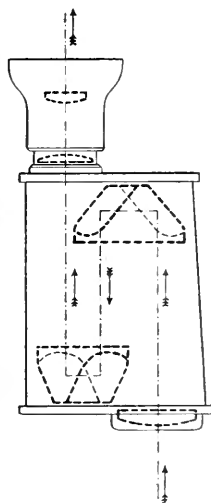

FIG. 80.—Showing the combination of prisms and the path of the rays (1894).

plane of the preparation, and the deflected image by one whose axis is inclined about a fourth of the angle of aperture.

With low powers, which allow of a relatively considerable depth-perspective, the slight difference of inclination, which remains

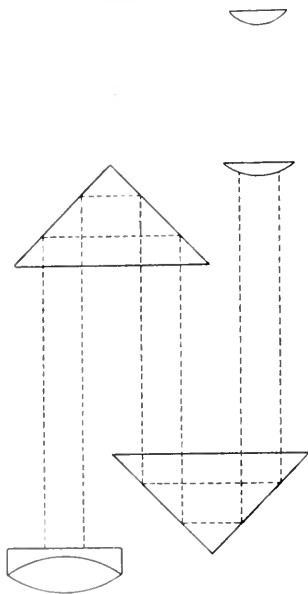

FIG. 81.—Simpler illustration of the path of the ray with one prism turned through an angle of 90° to make the path of the rays clearer.

in the latter case, is quite sufficient to produce a very marked difference in the perspective of the successive layers in the images. But with high powers the difference in the two images does not keep pace—even when both eye-

pieces are half covered—with the increase of the angle of aperture, so long as ordinary central illumination is used. For in this case the incident pencil does not fill the whole of the opening of the objective, but only a relatively small central part, which, as a rule, does not embrace more than 40° of angle, and in most cases cannot embrace more without the clearness of the microscopic image being affected and the focal depth also being unnecessarily decreased. But as those parts of the preparation which especially allow of solid conception are always formed by direct transmitted rays in observation with transmitted light, it follows that under these circumstances the difference of the two images is founded, not on the whole aperture-angle of the objective, but on the much smaller angle of the incident and directly trans-

mitted pencils, which only allow of relatively small differences of inclination of the image-forming rays to the preparation. It is evident, however, that when objectives of short focus and correspondingly large angle are used, a considerably greater differentiation of the two images with respect to parallax can be produced if, in place of one axial illuminating pencil, two pencils are used oppositely inclined to the axis in such a way that each of the images is produced by one of the pencils. This kind of double illumination, though it cannot be obtained by the simple mirror, can be easily produced by using with the condenser a diaphragm with two

openings (fig. 82), placed in the diaphragm stage under the condenser. We then have it in our power to use, at pleasure, pencils of narrower or wider aperture and of greater or less inclination



FIG. 82.

towards the axis by making the openings of different width and different distance apart.

With diaphragms of this form (which can easily be made out of cardboard) the larger aperture angles of high-power objectives may be made use of to intensify the stereoscopic effect without employing wide pencils, which are prejudicial both as diminishing the clearness of the image and the focal depth.

Of course with this method of illumination both eye-pieces must be half covered in order that one image may receive light only from one of the two illuminating cones, and the other only from the other. The division of light in both the aperture-images will then be as shown in fig. 83; and it is evident that in this case the brightness of the image for both eyes together is exactly the same as would be given by one of the two cones alone without any covering.



FIG. 83.

The method of illumination here referred to—which was originally recommended by Mr. Stephenson for his binocular microscope—has, in fact, proved itself to be by far the best when it is a question of using higher powers than about 300 times. It necessarily requires very well corrected and properly adjusted objectives if the sharpness of the image is not to suffer; but if these conditions are satisfied it yields most striking stereoscopic effects, even with objectives of 2 mm. and less focal length, provided the preparation under observation presents within a small depth a sufficiently characteristic structure.

Non-Stereoscopic Binoculars.—The great comfort which is experienced by the microscopist from the conjoint use of both eyes has led to the invention of more than one arrangement by which this comfort can be secured when those high powers are required which cannot be employed with the ordinary stereoscopic binocular. This is accomplished by Messrs. Powell and Lealand by taking advantage of the fact already adverted to, that when a pencil of rays falls obliquely upon the surface of a refracting medium a part of it is reflected without entering that medium at all. In the place usually occupied by the Wenham prism, they interpose an inclined plate of glass with parallel sides, through which one portion of the rays proceeding upwards from the whole aperture of the objective passes into the *principal* body with very little change in its course, whilst another portion is reflected from its surface into a rectangular prism so placed as to direct it obliquely upwards into the *secondary* body (fig. 84). Although there is a decided difference in brightness between the two images, that formed by the reflected rays being the fainter, yet there is marvellously little loss of definition in either, even when the 50th of an inch objective is used. The disc and prism are fixed in a short tube, which can be readily substituted in any ordinary binocular microscope for the one containing the Wenham prism. Other arrangements were long since devised by Mr. Wenham,¹ and subsequently by Dr. Schröder,



FIG. 84. (1865.)

¹ *Transactions of the Microsc. Soc.*, N.S. vol. xiv. (1866), p. 105.

for securing binocular vision with the highest powers. We have used the latter of these with perfect satisfaction, but all that is required is at the disposal of the student in the arrangement of Powell and Lealand.

To those who have used these forms of binocular habitually it has been a frequent source of surprise and perplexity that, although theoretically such a form as that of Powell and Lealand's is non-stereoscopic, yet objects studied with high powers have *appeared* as if in relief, and the effect upon the mind of stereoscopic vision has been distinctly manifest. The Editor was conscious of this for many years in the use of the Powell and Lealand form, with even the $\frac{3}{50}$ th of an inch power of the achromatic construction; at the time he interpreted it as a conceptual effect; but it always arose when the pupils fell upon the outer halves of the Ramsden circles. The explanation, Dr. A. C. Mercer considers,¹ is due to Abbe. Since (fig. 85) when the eye-pieces are at such a distance apart that the Ramsden circles correspond exactly with the pupils of the eyes, centre to centre, the object appears flat. But if the eye-pieces be racked down, so as to be nearer together, the centres of the pupils fall upon the *outer* halves of the Ramsden circles and we

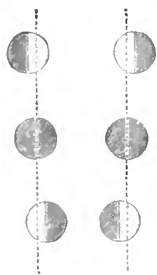

FIG. 85.

have the conditions of orthoscopic effect: while if they be racked up so as to be more separated, the centres of the pupils fall on the *inner* halves, and we have pseudoscopic effect.

The Optical Investigations of Gauss.— Before leaving this section of our subject, in which we have endeavoured, with as much clearness as we could command, to enable the general reader to comprehend with intelligibility *the principles of theoretical and applied optics* as they relate to the microscope, we believe we shall serve the higher interests of microscopy, and the wants or desires of the more advanced microscopical experts, if we endeavour to present in a form either devoid of technicality or with inevitable technicalities explained *a general outline and then an application of the famous dioptric investigations of Gauss*, an eminent German mathematician, who, amongst many other brilliant labours in applied mathematics, *expounded the laws of the refraction of light in the case of a co-axial system of spherical surfaces, having media of various refractive indices lying between them.*

Although the assumptions upon which the formula of Gauss rest are not coincident with the conditions presented by the lens-combinations which are employed in the construction of modern objectives of great aperture, the results, nevertheless, furnish an admirable presentation of the path of the rays and the positions of cardinal points, even in the microscope as we know and use it.

We remember that the microscope is largely used in England and America by men who can only employ it in their more or less brief recessions from professional and commercial pursuits, but who often employ it with enthusiasm and intelligent purpose. Much

¹ *Journal, R.M.S.*, ser. ii, vol. ii, p. 271.

scientific work may be done by such men, and it will promote the accomplishment of this, in our judgment, if the frequently expressed desire be met which will enable such students to understand in a general but thoroughly intelligent manner the principles involved in the employment of systems of lenses.

Many such either have scanty knowledge of algebra, or in the continuous pressure of other claims have lost much that they once possessed. We believe that in these cases the following exposition of the dioptric system of Gauss, with a following example worked out in full and with every step made clear, will be of real and practical value. Without some intelligible understanding of the ultimate principles of the microscope no results of the highest order can, at least with moderate and high-power lenses of the best modern construction, be anticipated. On this ground we commend the study to the earnest reader.

Let $R N$, $S N'$ (fig. 86) be the spherical surfaces of a lens of density greater than air, and let $P R S p$ be the course of a ray of light passing through it; C, C' , the centres of the spherical surfaces.

Let $P R$, $R S$ be produced to meet the perpendiculars through C and C' in A and A' .

Let $C R = r$, $C' S = r',^2 \mu =$ index of refraction out of air into the medium. $N N' = d$, the thickness of the lens. $N R = b$, $N' S = b'$. These may be considered as straight lines.

Let the equation to $P R$ be $y - b = m(x - O N)$ (1)

Let the equation to $R S$ be $y - b = m'(x - O N)$ (2)

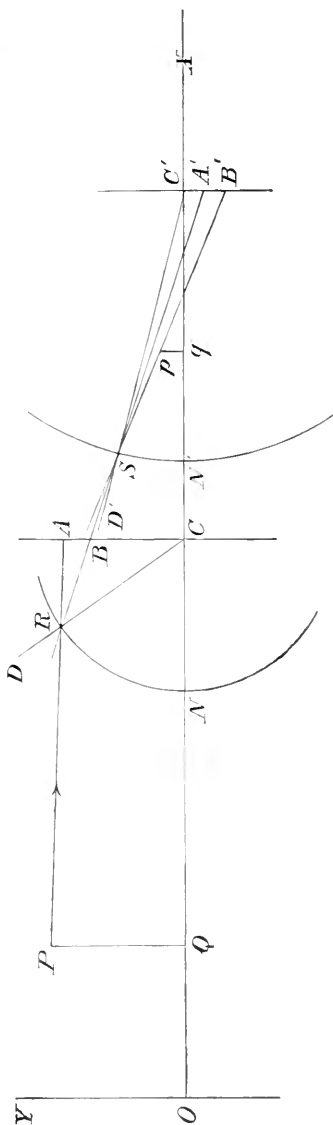

FIG. 86.

¹ This figure is greatly exaggerated for the sake of clearness.

² If either of the curvatures be turned in the opposite direction the sign of the corresponding r must be changed.

or, $y - b' = m'(x - ON')$ (3)

Let the equation to Sp be $y - b' = m''(x - ON')$ (4)

From (2) and (3)

$$b' - b = m'(ON' - ON) = m' N' N = m' d (5)$$

Now $\frac{CA}{\sin CRA} = \mu, \frac{CB}{\sin CBR}$;

or, $\frac{CA}{CR} \cdot \sin CAR = \mu \cdot \frac{CB}{CR} \cdot \sin CBR$.

Now CA and CB are the values of y in equations (1) and (2) when $x = OC$;

$$\therefore CA = b + m(OC - ON) = b + m'r;$$

and similarly $CB = b + m'r$;

$$\therefore (b + m'r) \sin CAR = \mu (b + m'r) \sin CBR.$$

Now CAR, CBR do not in general differ much from each other, so that for a first approximation we may consider them to be equal.

$$\therefore b + m'r = \mu(b + m'r), \text{ i.e. } \mu m' = m - \frac{\mu - 1}{r} \cdot b.$$

Let $\frac{\mu - 1}{r} = a$; then $\mu m' = m - b a$ (6)

Similarly, $\sin C'SB' = \mu \cdot \sin C'SA'$;

or, $\frac{C'B'}{C'S} \cdot \sin C'B'S = \frac{C'A'}{C'S} \cdot \sin C'A'S$;

and, as before,

$$C'B' = b' + m''r', C'A' = b' + m'r' \text{ from equations (4) and (3);}$$

\therefore as before we may take

$$b' + m''r' = \mu(b' + m'r'), \text{ or } \mu m' = m'' - \frac{\mu - 1}{r'} b'.$$

Let $\frac{\mu - 1}{r'} = a'$, then $\mu m' = m'' - b' a'$ (7)

From (5) and (6) $b' = b + \frac{m - b a}{\mu} d = b \left(1 - \frac{d a}{\mu}\right) + \frac{m d}{\mu}$.

$$\therefore \text{ this and (7) } m'' = \mu m' + b a' \left(1 - \frac{d a}{\mu}\right) + \frac{m d a'}{\mu}$$

$$\begin{aligned} \text{and from (6)} &= m - b a + b a' \left(1 - \frac{d a}{\mu}\right) + \frac{m d a'}{\mu} \\ &= m \left(1 + \frac{d a'}{\mu}\right) + b \left(a' - a - \frac{d a a'}{\mu}\right). \end{aligned}$$

Assume

$$\frac{d}{\mu} = h, 1 - \frac{d a}{\mu} = g, 1 + \frac{d a'}{\mu} = l, a' - a - \frac{d a a'}{\mu} = k$$

then $\left. \begin{aligned} b' &= g b + h m \\ m'' &= k b + l m \end{aligned} \right\}$, where $g l - h k = 1$ (8)

Now let X, Y be the coordinates of P , the point from which the ray of light proceeds;

then by (1) $b = Y - m(X - ON)$;

substituting in (8) $b' = g Y + m \frac{(h - g)(X - O N)}{l - k}$;
 $m' = k Y + m \frac{(l - k)(X - O N)}{l - k}$;

whence

$$m = \frac{m' - k Y}{l - k} ; b' = g Y + (m' - k Y) \frac{h - g}{l - k} \frac{(X - O N)}{(X - O N)}$$

Now substituting in (4) the equation to the refracted ray becomes

$$g - Y \left(g - k \frac{h - g}{l - k} \frac{(X - O N)}{(X - O N)} \right) = m'' \left(x - O N' + \frac{(h - g)(X - O N)}{(l - k)(X - O N)} \right) ;$$

or by (8)

$$g - \frac{Y}{l - k} \frac{(X - O N)}{(X - O N)} = m'' \left(x - O N' + \frac{h - g}{l - k} \frac{(X - O N)}{(X - O N)} \right) \quad (9)$$

First: If X be taken such that $l - k \frac{(X - O N)}{(X - O N)} = 1$, i.e. $X = O N - \frac{l - l}{k} = O E$, suppose:

then when

$$x - O N' - h + g \frac{l - l}{k} = O N' + \frac{l - g}{k} = O E', \text{ suppose,}$$

$g = Y$, or P and p are equally distant from the axis.

Also, if $Y = 0$, $g = 0$; or if a ray proceed from E, it will after refraction pass through E'. Also $m = \frac{m' - k Y}{l - k} = m''$, that is, the ray will be equally inclined to the axis before and after refraction.

E and E' are called the 'principal points.'

$$\left. \begin{aligned} O E &= O N - \frac{l - l}{k} = O N + \frac{\frac{d u'}{\mu} \mu}{u' - u - \frac{d u u'}{\mu}} \\ &= O N + \frac{d u'}{\mu(u' - u) - d u u'} ; \\ O E' &= O N' + \frac{l - g}{k} = O N' + \frac{\frac{d u}{\mu} \mu}{u' - u - \frac{d u u'}{\mu}} \\ &= O N' + \frac{d u}{\mu(u' - u) - d u u'} \end{aligned} \right\}$$

Secondly: If $m'' = 0$, or the ray be parallel to the axis after refraction, we have from (8)

$$h = - \frac{l}{k} m, \text{ and the equation to the incident ray becomes}$$

$$g + \frac{l}{k} m = m(x - O N), \text{ or } g = m \left(x - O N - \frac{l}{k} \right) ;$$

$$\therefore \text{ when } y = 0, x = \text{ON} + \frac{l}{k} = \text{ON} + \frac{1 + \frac{d u'}{\mu}}{u' - u - \frac{d u u'}{\mu}}$$

$$= \text{OF, suppose.}$$

If $m = 0$, or the ray be parallel to the axis before refraction, we have from (8)

$$h' = y h = \frac{g}{k} m'', \text{ and the equation to the refracted ray becomes}$$

$$y - \frac{g}{k} m'' = m'' (x - \text{ON}') \text{, or } y = m'' \left(x - \text{ON}' + \frac{g}{k} \right) ;$$

$$\therefore \text{ when } y = 0, x = \text{ON}' - \frac{g}{k} = \text{ON}' - \frac{1 - \frac{d u}{\mu}}{u' - u - \frac{d u u'}{\mu}}$$

$$= \text{O F}', \text{ suppose.}$$

F and F' are called the 'focal points.'

$$\text{O F} = \text{O N} + \frac{\mu + d u'}{\mu (u' - u) - d u u'}$$

$$\text{O F}' = \text{O N}' - \frac{\mu - d u}{\mu (u' - u) - d u u'}$$

$$\text{The focal distance } -f' = \text{O F} - \text{O E} = \text{O E}' - \text{O F}$$

$$= \frac{\mu}{\mu (u' - u) - d u u'} = \frac{1}{k}.$$

Similarly, it may be shown that if there be two lenses, and sub-script numbers refer to the first and second lens respectively, while E, E', F, F' refer to the entire system, and if

$$\hat{c} = \text{O E}_2 - \text{O E}'_1,$$

$$c_1 = -\frac{\mu_1}{f_1} = \mu_1 (u'_1 - u_1) - d_1 u_1 u'_1,$$

$$c_2 = -\frac{\mu_2}{f_2} = \mu_2 (u'_2 - u_2) - d_2 u_2 u'_2,$$

$$\text{O E} = \text{O E}_1 + \frac{\mu_1 \hat{c} c_2}{\mu_2 c_1 + \mu_1 c_2 + \hat{c} c_1 c_2} ;$$

$$\text{O E}' = \text{O E}'_2 - \frac{\mu_2 \hat{c} c_1}{\mu_2 c_1 + \mu_1 c_2 + \hat{c} c_1 c_2} ;$$

$$\text{O F} = \text{O E}_1 + \frac{\mu_1 (\mu_2 + \hat{c} c_2)}{\mu_2 c_1 + \mu_1 c_2 + \hat{c} c_1 c_2} ;$$

$$\text{O F}' = \text{O E}'_2 - \frac{\mu_2 (\mu_1 + \hat{c} c_1)}{\mu_2 c_1 + \mu_1 c_2 + \hat{c} c_1 c_2} ;$$

We are now prepared to *work out an example of the Gauss system* by tracing a ray through two or more lenses on an axis, showing how any conjugate may be found through two or more lenses on that axis.¹

¹ Remembering our object, and the assumed conditions of some for whom we write, we do not hesitate to preface this with the following notes to remind the reader of the sense attached to certain mathematical expressions.

$\frac{1}{\infty}$ means infinity. A plane surface of a lens is considered a spherical surface of infinite radius. Any number divided by $\infty = 0$ any number divided by $0 = \infty$;

The Gauss system of tracing a ray through two or more lenses on an axis illustrated by means of a worked-out example.

Two lenses, 1 and 2, fig. 87, on an axis xy are given. No. 1 is a double convex of crown $\frac{1}{2}$ inch thick, the refractive index μ being $\frac{3}{2}$, the radius of the surface A is $\frac{3}{4}$ and that of B 1 inch. No. 2 lens is a plano-concave of flint $\frac{1}{10}$ inch thick, the refractive index μ being $\frac{3}{2}$, the radius of the surface C is $\frac{3}{8}$, and the surface D is plane. The distance between the lenses, that is, from B to C measured on the axis, is $\frac{1}{4}$ inch. The problem is to find the conjugate focus of any given point V.

In order to accomplish this two points have first to be found with regard to each lens. These points are called principal points (see PP', QQ' in fig. 87). When the radii of curvature r and r' , d , the thickness, and $\mu_1 \mu_2$, the refractive indices of the respective lenses,¹ are known, the distance of these points from the vertices, i.e. the points where the axis cuts the surfaces of the lens, can be found. Thus by applying Professor Fuller's formulæ to lens 1 the distance of P from the vertex A can be determined—see p. 115 (i)—similarly P' from B—p. 115 (ii). In the same way the points QQ' from C and D in lens 2 can be measured off—(v) (vi), pp. 115, 116.

It must be particularly noticed that in measuring off any distance if the number is + it must be measured from left to right, and if - from right to left. Thus in (i) p. 115 because the sign of .158 is + P lies .158 of an inch to the right of A. And in (ii) because .21 is - P' lies .21 of an inch to the left of B. The same rule applies to the radii; thus the radius of A, being measured from the vertex to the centre or from left to right, is +; but the radius of B, being measured from the vertex to its centre or from right to left, is -. Similarly with the concave surface, C being measured from right to left is -.

In both the examples before us the points PP', QQ' fall inside any number multiplied by 0=0. ∞ plus, or minus, or multiplied by any number is still ∞ .

The following are the rules for the treatment of algebraical signs:

In the *multiplication or division of like signs* the result is always *plus*; but if the signs are *dissimilar* it is always *minus*.

In addition, add all the terms together that have a plus sign; then all the terms with a minus sign; subtract the less from the greater and affix the sign of the greater. Example:

$$+3 - 4 + 2 - 5 = -4.$$

In subtraction change the sign of the term to be subtracted and then add in accordance with the previous rule. Example:

$$\begin{array}{r} -3 \\ +2 \\ -5 \end{array}$$

An example occurs in the annexed equations (x) and (xi), p. 116, of $- \div - = +$, but then the + is changed into a - by the negative sign in front of the fraction. In (xii), p. 116, however, there being a + in front of the fraction, the result remains positive.

¹ In the worked-out example no distinction has been made between the r, r' of one lens and the r, r' of the other lens, as well as of μ and d , because when the principal points and focal length are determined for one lens those expressions are not again needed, so the same letters with different values assigned to them may be equally well used for the next lens. Too many different terms are apt to confuse the student, while those who are familiar with mathematical expressions will understand the arrangement.

their respective lenses, but it does not follow that they will do so in every instance. In some forms of menisci, for example, they will fall outside the lens altogether.

With regard to the focus of the lens it follows the same rule; thus, f in lens 1 is measured to the left from P, and f' to the right from P'; similarly in lens 2, f'' is measured to the right from Q, and f''' to the left from Q'.

Having determined the focal length of each lens, the distance between the right-hand principal point of the first lens P' and the left-hand principal point of the second lens Q must next be found. It manifestly is the distance of B from P' + the distance B C between the lenses, Q being at the point C. Therefore,

$$P' Q = .21 + .25 = .46 = \hat{c}.$$

When these three data have been obtained—that is, the focal length of each lens, and the distance between them—we are in a position to apply the formula (ix) and (x), p. 116, to find the principal points E and E' of the combination.

In selecting the value of the focus to be put into the equations for both lenses, the last must be taken, that is, in lens 1 (iv) or +.947, and in lens 2 (viii), or -1.875.

It will be noticed that the value of E being negative, it will be measured .314 inch to the left from P. Similarly, E' is measured .622 inch to the left from Q'.

ϕ also is 1.28 to the left from E, and ϕ' 1.28 to the right from E'.

These four points, E E' and ϕ ϕ' , are called the cardinal points of the combination.

Here it must be observed that in this work it has been necessary for want of space to restrict the problem to dry lenses, that is, to those cases where the ray emerges from the combination into air, the same medium in which it was travelling on immersion. It is on that account that the values of ϕ and ϕ' are the same.

Having now obtained the four cardinal points, we may at once proceed to find the conjugate of x .

Let x equal the distance of the point x from the focal plane ϕ , and y the distance of its conjugate from ϕ' . Then by formula (xiii)

$$xy = \phi^2, \text{ and as } x = 1 \text{ inch, } y = \frac{1.6384}{1} = 1.6384.$$

This numerically determines the position of the conjugate plane.

If the rays incident on the combination are parallel, then $x = \infty$, and $y = \frac{\phi^2}{\infty} = 0$, which means that y is coincident with ϕ' .

The following is the graphic method of finding the conjugate of V. From V, fig. 87, draw a line parallel to the axis to meet E', and from the point where it meets E' draw a line through N, the point where ϕ' cuts the axis, to W.

From V draw another line through M, the point where ϕ cuts the axis, to meet E and from the point where it meets E draw a line parallel to the axis, cutting the other line in W. W will be the conjugate of V, which was required.

If it is required to find the conjugate of a ray passing through three lenses on an axis, two of the lenses must be combined and their four cardinal points found.

The principal points and the focal length of the third lens must then be calculated, and then combined in their turn by formulæ (ix), (x), (xi), and (xii), p. 116, with the cardinal points of the double combination. δ is taken as the distance of the first principal point of the combination, nearest the third lens, to the second principal point of the lens, nearest the combination. A fresh set of cardinal points is determined in this manner for the three lenses.

So also with four lenses; the cardinal points of each pair being found, they are combined by the same formulæ, and new cardinal points for the whole combination of four lenses are obtained. Similarly, the cardinal points of five, six, or any number of lenses can be found and the conjugate of any point localised.

Finally, no one need be discouraged by the appearance of the length of the calculation; the example is given in full, so that any one acquainted only with vulgar fractions and decimals can work it, or any other similar problem, out.

In lens No. 1, for instance, the numerators of the fractions are all very simple, and the denominators of the four equations are all alike; so, too, in

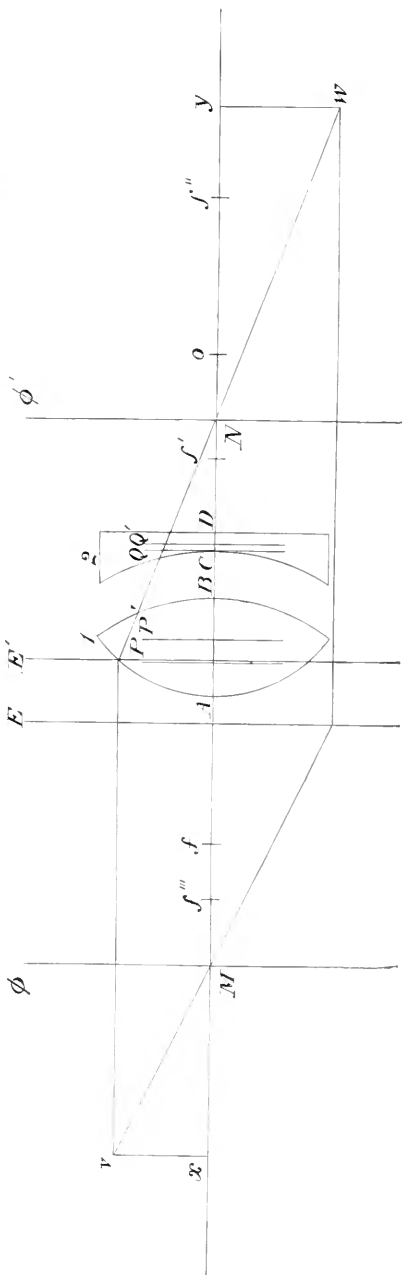

FIG. 87.

the equations for No. 2 and in those for both lenses. Further, f is the same as f'' , f''' as f'' , and ϕ' as ϕ . Hence the problem is much shorter than it looks.

If the conjugate of a point on the *axis* is only required, and if the principal points and foci of each lens have been determined, it will not be necessary to enter into the further calculation to find E, E' and ϕ , ϕ' , the cardinal points of the combination.

The method of procedure is as follows: If x is the given point, its distance from f_1 , the focus of lens No. 1, must first be measured. Call this distance x . Then the distance of o its conjugate from the other focus, f' , supposing lens No. 2 to be removed, can be found by formula

$$\begin{aligned} o \cdot x &= f'^2, \quad o = \frac{f'^2}{x}, \\ f'^2 &= \cdot 897, \quad x = 1\cdot 65; \\ \therefore o &= \frac{\cdot 897}{1\cdot 65} = \cdot 543. \end{aligned}$$

This is the distance from f' to o .

As the distance from x to f is positive, the distance between f' and o is also positive; so o is to the right of f' .

Before proceeding it will be as well to examine other possible cases which might occur.

Suppose that x was at the point f , then x would equal 0, and $o = \infty$; that is, o would lie at an infinite distance from f' . If, on the other hand, the point x was to the right of f , x would be negative, and o would be also negative, because f'^2 is always positive: o would then be measured off to the left of f' , and the conjugate would be virtual. This means that there will be no real image, because the rays will be divergent on the f' side of the lens, as if they had come from some focus on the f side of the lens. But to return. The point o having been found to be the conjugate of x , due to the sole influence of No. 1 lens, we have next to measure the distance between o and f'' , and, by applying the same formula, find the distance of its conjugate from f''' , owing to the exclusive effect of No. 2 lens now replaced. This distance $o \cdot f''$ may be found thus:

$$\begin{aligned} P' o &= P' f' + f' o = \cdot 947 + \cdot 543 = 1\cdot 49; \\ P' f'' &= P' B + B C + Q f'' = \cdot 21 + \cdot 25 + 1\cdot 875 = 2\cdot 335; \\ P' f'' - P' o &= o \cdot f'' = 2\cdot 335 - 1\cdot 49 = \cdot 845. \end{aligned}$$

Calling this distance O, then, by formula $y \cdot O = f'''^2$, we shall find the distance of y from f''' , which we shall call y . $y = \frac{f'''^2}{O} = \frac{3\cdot 515}{\cdot 845} = 4\cdot 16$, which is positive; therefore y lies 4·16 inches from f''' to the right hand. y is therefore the conjugate of x , due to the influence of both lenses 1 and 2. Similarly, the conjugate of any point on the *axis* may be found through any number of lenses.

Lens No. 1: Data. - Radius A = $\frac{3}{4} = r$; radius B = $-1 = r'$; foci, f, f' ; thickness = $\frac{1}{2} = d$; $\mu = \frac{3}{2}$; P = principal point mea-

sured from A; P' = principal point measured from B

$$\begin{aligned} u &= \frac{\mu-1}{r} = \frac{2-1}{3} = \frac{1}{3}; \quad u' = \frac{\mu-1}{r'} = \frac{2-1}{-1} = -\frac{1}{2}; \\ \mu(u'-u) &= \frac{3}{2} \left(-\frac{1}{2} - \frac{2}{3} \right) = -\frac{7}{4}; \quad d u u' = \frac{1}{2} \times \frac{2}{3} \times -\frac{1}{2} = -\frac{1}{6}; \\ \mu(u'-u) - d u u' &= -\frac{7}{4} + \frac{1}{6} = -\frac{19}{12} = -1.583; \\ P &= A + \frac{d u'}{\mu(u'-u) - d u u'} = A + \frac{\frac{1}{2} \times -\frac{1}{2}}{-\frac{19}{12}} = A + \frac{3}{19} \\ &= A + .158 \end{aligned} \quad (i)$$

$$\begin{aligned} P' &= B + \frac{d u}{\mu(u'-u) - d u u'} = B + \frac{\frac{2}{3}}{-\frac{19}{12}} = B - \frac{4}{19} \\ &= B - .21 \end{aligned} \quad (ii)$$

$$\begin{aligned} f &= P + \frac{\mu}{\mu(u'-u) - d u u'} = P + \frac{2}{-\frac{19}{12}} = P - \frac{18}{19} \\ &= P - .947 \end{aligned} \quad (iii)$$

$$\begin{aligned} f' &= P' - \frac{\mu}{\mu(u'-u) - d u u'} = P' - \frac{2}{-\frac{19}{12}} = P' + \frac{18}{19} \\ &= P' + .947 \end{aligned} \quad (iv)$$

Lens No. 2: Data.—Radius C = $-\frac{9}{8} = r$; radius D = $\infty = r'$; foci, f'', f''' ; thickness = $\frac{1}{10} = d$; $\mu = \frac{8}{5}$; Q = principal point measured from C; Q' = principal point measured from D.

$$\begin{aligned} u &= \frac{\mu-1}{r} = \frac{8-1}{-\frac{9}{8}} = -\frac{8}{15}; \quad u' = \frac{\mu-1}{r'} = \frac{8-1}{\infty} = 0; \\ \mu(u'-u) &= \frac{8}{5} \left(0 + \frac{8}{15} \right) = \frac{64}{75}; \quad d u u' = \frac{1}{10} \times -\frac{8}{15} \times 0 = 0; \\ \mu(u'-u) - d u u' &= \frac{64}{75} - 0 = \frac{64}{75} = .853; \\ Q &= C + \frac{d u'}{\mu(u'-u) - d u u'} = C + \frac{0}{\frac{64}{75}} = C + 0 \end{aligned} \quad (v)$$

$$Q' = D + \frac{d \mu}{\mu(u' - u) - d u u'} = D + \frac{1}{64} \times \frac{-8}{75} = D - \frac{1}{16} = D - 0.0625 \quad (vi)$$

$$f'' = Q + \frac{\mu}{\mu(u' - u) - d u u'} = Q + \frac{5}{64} = Q + \frac{15}{8} = Q + 1.875 \quad (vii)$$

$$f''' = Q' - \frac{\mu}{\mu(u' - u) - d u u'} = Q' - \frac{5}{64} = Q' - \frac{15}{8} = Q' - 1.875 \quad (viii)$$

Both Lenses. - Distance apart = BC = $\frac{1}{4}$ = .25 ; P'Q = .21 + .25 = .46 = c ; f = focus of No. 1 lens = .947 ; f' = focus of No. 2 lens = -1.875.

$$E = P + \frac{c f}{f + f'} - c = P + \frac{.46 \times .947}{.947 - 1.875 - .46} = P + \frac{.436}{-1.388} = P - .314 \quad (ix)$$

$$E' = Q' - \frac{c f'}{f + f'} - c = Q' - \frac{.46 \times -1.875}{.947 - 1.875 - .46} = Q' - \frac{.862}{-1.388} = Q' + .621 \quad (x)$$

$$q = E - \frac{f f'}{f + f'} - c = E - \frac{.947 \times -1.875}{.947 - 1.875 - .46} = E - \frac{1.775}{-1.388} = E + 1.28 \quad (xi)$$

$$\phi' = E' + \frac{f f'}{f + f'} - c = E' + \frac{.947 \times -1.875}{.947 - 1.875 - .46} = E' - \frac{1.775}{-1.388} = E' + 1.28 \quad (xii)$$

$$y = \phi^2 \quad y = \frac{\phi^2}{1.0} = 1.6384 \quad (xiii)$$

CHAPTER III

THE HISTORY AND DEVELOPMENT OF THE MICROSCOPE

THE historic progression of the modern microscope from its earliest inception to its most perfect form is not only full of interest, but is also full of the most valuable instruction to the practical microscopist. In regard to the details of this, our knowledge has been greatly enriched during recent years. The antiquarian knowledge and zeal in this matter possessed by Mr. John Mayall, jun., and the unique and valuable collection of microscopes made by Frank Crisp, Esq., LL.B., ranging as they do through all the history of the instrument, from its earliest employment to its latest forms, have furnished us with a knowledge of the details of its history not possessed by our immediate predecessors.

We may obtain much insight into the nature of what is indispensable and desirable in the microscope, both on its mechanical and optical sides, by a thoughtful perusal of these details. It will do more to enable the student to infer what a good microscope should be than the most exhaustive account of the varieties of instrument at this time produced by the several makers (always well presented in their respective catalogues) can possibly do. Availing ourselves of the material placed at our disposal by the generosity of these gentlemen, we shall therefore trace the main points in the origin and progress of the microscope as we now know it.

Mr. Mayall¹ gives what we must consider unanswerable reasons for looking upon the microscope, 'as we know and employ it,' as a strictly modern invention. Its occurrence at the period when the spirit of modern scientific research was asserting itself, and when the necessity for all such aids to physical inquiry and experimental research was of the highest value, is as striking as it is full of interest.

It may be held as fairly established that magnifying lenses were not known to the ancients, the simplest optical instruments as we understand them having no place in their civilisation.

A large number of passages taken from ancient authors, and having an apparent or supposed reference to the employment of magnifying instruments, have been collected and carefully criticised, with the result that all such passages can be explained without involving this assumption.

We learn from Pliny the elder and others, that crystal globes filled with water were employed for cauterisation by focussing the

¹ *Cantor Lectures on the Microscope*, 1886, p. 1.

sun's rays as a burning-glass, and that these were used to produce ignition; but there is no trace of suggestion that these refracting globes could act as magnifying instruments.

Seneca (*Quest. Nat.* i. 6. § 5) states, however, that 'letters though small and indistinct are seen enlarged and more distinct through a globe of glass filled with water.' He also states that 'fruit appears larger when seen immersed in a vase of glass.' But he only concludes from this that all objects seen through water appear larger than they are.

In like manner it could be shown that Archimedes, Ptolemy, and others had no knowledge of the principles on which refraction took place at curved surfaces.

Nor is there any ancient mention of spectacles or other aids to vision. Optical phenomena were treated of; Aristotle and the Greek physician Alexander dealt with myopy and presbyopy; Plutarch treated of myopy, and Pliny of the sight. But no allusion is made to even the most simple optical aids; nor is there any reference to any such instruments by any Greek or Roman physician or author. In the fifth century of the Christian era the Greek physician Actius says that myopy is incurable; and similarly in the thirteenth century another Greek physician, Actuarius, says that it is an infirmity of sight for which art can do nothing. But since the end of the thirteenth century, which is after the invention of spectacles, they are frequently referred to in medical treatises and other works.

If we turn to the works of ancient artists we find amongst their cut gems some works which reveal extreme minuteness of detail and delicacy of execution, and some have contended that these could only have been executed by means of lenses. But it is the opinion of experts that there is no engraved work in our national collection in the gem department that could not have been engraved by a qualified modern engraver by means of unaided vision; and in reference to some very minute writing which it was stated by Pliny that Cicero saw, Solinus and Plutarch, as well as Pliny, allude to these marvels of workmanship for the purpose of proving that some men are naturally endowed with powers of vision quite exceptional in their excellence, no attempt being made to explain their minute details as the result of using magnifying lenses.

These and many other instances in which reference to lenses must have been made had they existed or been known are conclusive; for it is inconceivable that even simple dioptric lenses, to say nothing of spectacles, microscopes and telescopes, could have been known to the ancients without reference to them having been made by many writers, and especially by such men as Galen and Pliny.

The earliest known reference to the invention of spectacles is found in a manuscript dating from Florence in 1299, in which the writer says, 'I find myself so pressed by age that I can neither read nor write without those glasses they call spectacles, lately invented, to the great advantage of poor old men when their sight grows weak.'¹ Giordano da Rivalto in 1305 says that the invention

¹ Smith's *Optics*, Cambridge, 1738, 2 vols. ii. pp. 12, 13.

of spectacles dates back 'twenty years,' which would be about 1285. It is now known that they were invented by Salvino d'Armato degli Armati, a Florentine, who died in 1317. He kept the secret for profit, but it was discovered and published before his death. But there is a singular evidence that a lens used for the purpose of magnification was in existence as early as between 1513 and 1520, for at that time Raphael painted a portrait of Pope Leo X. which is in the Palazzo Pitti, Florence. In this picture the Pope is drawn holding a hand magnifier, evidently intended to examine carefully the pages of a book open before him. But no instruments comparable to the modern telescope and microscope arose earlier than the beginning of the seventeenth century and the closing years of the sixteenth century respectively.

It is, of course, known that there is in the British Museum a remarkable piece of rock crystal, which is oval in shape and ground to a plano-convex form, which was found by Mr. Layard during the excavations of Sargon's Palace at Nimroud, and which Sir David Brewster believed was a lens designed for the purpose of magnifying. If this could be established it would of course be of great interest, for it has been found possible to fix the date of its production with great probability as not later than 721-705 B.C.

A drawing of this 'lens' in two aspects is shown in figs. 88 and 89, and we spent some hours in the careful examination of this piece of worked rock crystal, which by the courtesy of the officials we were permitted to photograph in various positions, and we are convinced

that its lenticular character as a dioptric instrument cannot be made out. There are cloudy striae in it, which would prove fatal for optical purposes, but would be even sought for if it had been intended as a decorative boss: while the grinding of the 'convex' surface is not smooth, but produced by a large number of irregular facets, making the curvature quite unfit for optical purposes. In truth, it may be fairly taken as established that there is no evidence of any kind to justify us in believing that lenses for optical purposes were known or used before the invention of spectacles.

From the simple spectacle-lens, the transition to lenses of shorter and shorter focus, and ultimately to the combination of lenses into a compound form, would be—in such an age as that in which the invention of spectacles arose—only a matter of time. But it is almost impossible to fix the exact date of the production of the first microscope, as distinguished from a mere magnifying lens.

There is nevertheless a consent on the part of those best able to judge that it must have been between 1590 and 1609; while it is



FIG. 88.

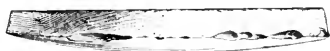

FIG. 89.—An Assyrian 'lens' (?).

probable (but by no means certain) that Hans and Zacharias Janssen, spectacle makers, of Middelburg, Holland, were the inventors. But it would appear that the earliest microscope was constructed for observing objects by reflected light only.

At the Loan Collection of Scientific Instruments in London in 1876 an old microscope, which had been found at Middelburg, was shown, which, Professor Harting considered, might possibly have been made by the Janssens. It is drawn in fig. 90, and consists of a combination of a convex object-lens and a convex eye-lens, which form was not published as an actual construction until 1646 by Fontana, which, as Mr. Mayall points out, does not harmonise with the assumption that this instrument was constructed by one of the Janssens.



FIG. 90.
Janssen's
compound
microscope
(1590)?

It is strictly a compound microscope, and the distance between the lenses can be regulated by two draw-tubes. There are three diaphragms, and the eye-lens lies in a wood cell, and is held there by a wire ring sprung in. The object-lens, *a*, is loose in the actual instrument, but was originally fixed in a similar way to *b*.

It cannot be an easy task—if it be even a possible one—to definitely determine upon the actual individual or individuals by whom the compound microscope was first invented. Recently some valuable evidence has been adduced claiming its sole invention for Galileo. In a memoir published in 1888¹ Professor G. Govi, who has made the question a subject of large and continuous research, certainly adduces evidence of a kind not easily waived.

Huyghens and, following him, many others assign the invention of the compound microscope to Cornelius Drebbel, a Dutchman, in the year 1621; but it has been suggested that he derived his knowledge from Zacharias Janssen or his father, Hans Janssen, spectacle makers, in Holland about the year 1590; while Fontana, a Neapolitan, claimed the discovery for himself in 1618. It is said that the Janssens presented the first microscope to Charles Albert, Archduke of Austria; and Sir D. Brewster states, in his 'Treatise on the Microscope,' that one of their microscopes which they presented to Prince Maurice was in 1617 in the possession of Cornelius Drebbel, then mathematician to the Court of James I., where 'he made microscopes and passed them off as his own invention.'

Nevertheless we are told by Viviani, an Italian mathematician, in his 'Life of Galileo,' that 'this great man was led to the discovery of the microscope from that of the telescope,' and that 'in 1612 he sent one to Sigismund, King of Poland.'

We now receive evidence through the researches of Govi that the invention was solely due to Galileo in the year 1610. Professor Govi understands by 'simple microscope' an instrument 'consisting of a single lens or mirror,' and by 'compound microscope' one 'con-

¹ *Atti della R. Accad. Sci. Fis. Nat. Napoli*, vol. ii, series ii, 'Il microscopio composto' (1888), ed. Galleani Juvon, R.M.S. Pt. IV, 1889, p. 574.

sisting of several lenses or a suitable combination of lenses and mirrors.'

In a pamphlet published in 1881, treating of the invention of the binocular telescope, Govi pointed out that Chomez, a spectacle maker, in 1625, used the Dutch telescope as a microscope, and stated that with it 'a mite appeared as large as a pea; so that one can distinguish its head, its feet, and its hair—a thing which seemed incredible to many until they witnessed it with admiration.'

To this quotation he added:—

'This transformation of the telescope into a microscope (or, as opticians in our own day would say, into a Brücke lens) was not an invention of the French optician. Galileo had accomplished it in the year 1610, and had announced it to the learned by one of his pupils, John Wodderborn, a Scotchman, in a work which the latter had just published against the mad "Peregrinazione" of Horky. Here are the exact words of Wodderborn (p. 7):—

'Ego nunc admirabilis huius perspicilli perfectiones explanare nō conabor: sensus ipse index est integerrimus circa obiectum proprium. Quid quod eminus mille passus et ultra cum neque videre iudicares obiectum, adhibito perspicillo, statim certo cognoscas, esse hunc Socratem Sophronici filium venientem, sed tempus nos docebit et quotidiana novarum rerum detectiones quam egregie perspicillum suo fungatur munere, nam in hoc tota omnis instrumenti sita est pulchritudo.

'Audieram, paucis ante diebus authorem ipsum Excellentissimo D. Cremonino purpurato philosopho varia narrantem scitu dignissima et inter cetera quomodo ille minimorum animantium organa motus, et sensus ex perspicillo ad vnguem distinguat: in particulari autem de quodam insecto quod utrumque habet oculum membrana crassiuscula vestitum, que tamen septē foraminibus ad instar larvæ ferree militis cataphracti terebrata, viam præbet speciebus visibilibus. En tibi [so says Wodderborn to Horky] novum argumentum, quod perspicillum per concentrationem radiorum multiplicet obiectū; sed audi prius quid tibi dicturus sum: in cæteris animalibus eiusdem magnitudinis, vel minoris, quorum etiam aliqua splendidiore habent oculos, gemini tantum apparent cum suis superciliis adisque partibus annexis.'

To this Govi adds:—

'I have wished to quote this passage of Wodderborn textually, so that the honour of having been the first to obtain from the Dutch telescope a *compound* microscope should remain with Galileo, which the latter called *occhialino*, and that the glory of having reduced the *Keplerian* telescope to a microscope (in 1621) should rest with Drebbel. The apologists of the Tuscan philosopher, by attributing to him the invention of the microscope without specifying with what microscope they were dealing, defrauded Drebbel of a merit which really belongs to him; but the defenders of Drebbel would act unjustly in depriving Galileo of a discovery which incontestably was his.'

I turn now to Wodderborn's account, published in 1610 (the date of the dedication to Henry Wotton, English Ambassador at Venice, is October 16, 1610), which reads thus:—

‘I will not now attempt to explain all the perfections of this wonderful *occhiale*; our sense alone is a safe judge of the things which concern it. But what more can I say of it than that by pointing a glass to an object more than a thousand paces off, which does not even seem alive, you immediately recognise it to be Socrates, son of Sophronicus, who is approaching? But time and the daily discoveries of new things will teach us how admirably the glass does its work, for in that alone lies all the beauty of that instrument.

‘I heard a few days back the author himself (Galileo) narrate to the Most Excellent Signor Cremonius various things most desirable to be known, and amongst others in what manner he perfectly distinguishes with his telescope the organs of motion and of the senses in the smaller animals; and especially in a certain insect which has each eye covered by a rather thick membrane, which, however, perforated with seven holes, like the visor of a warrior, allows it sight. Here hast thou a new proof that the glass concentrating its rays enlarges the object; but mind what I am about to tell thee, viz. in the other animals of the same size and even smaller, some of which have nevertheless brighter eyes, these appear only double with their eyebrows and the other adjacent parts.’

After reading this document Govi judges that it is impossible to refuse Galileo the credit of the invention of a *compound microscope* in 1610, and the application of it to examine some very minute animals; and if he himself neither then nor for many years after made any mention of it publicly, this cannot take away from him or diminish the merit of the invention.

It is not to be believed, however, that Galileo after these first experiments quite forgot the microscope, for in preparing the ‘*Saggiatore*’ between the end of 1619 and the middle of October, 1622, he spoke thus to Lotario Sarsi Segensano (anagram of Oratio Grassi Salonense):—

‘I might tell Sarsi something new if anything new could be told him. Let him take any substance whatever, be it stone, or wood, or metal, and holding it in the sun examine it attentively and he will see all the colours distributed in the most minute particles, and if he will make use of a telescope arranged so that one can see very near objects, he will see far more distinctly what I say.’

It will not therefore be surprising if, in 1624 (according to some letters from Rome, written by Girolamo Aleandro to the famous M. de Peiresc), two microscopes of Kuffler, or rather Drebbel, having been sent to the Cardinal of S. Susanna, who at first did not know how to use them, they were shown to Galileo, who was then in Rome, and he, as soon as he saw them, explained their use, as Aleandro writes to Peiresc on May 24, adding, ‘Galileo told me that he had invented an *occhiale* which magnifies things as much as 50,000 times, so that one sees a fly as large as a hen.’

This assertion of Galileo, that he had invented a telescope which magnified 50,000 times, so that a fly appears as big as a hen, must, without doubt, be referred to the year 1610, and from the magnitude given of the amplification by the solidity or volume the

linear amplification (as it is usually expressed now) would have been equal to something less than the cubic root of 50,000—that is, about 36—and that is pretty fairly the relative size of a fly and a hen.

Aleandro's letter of May 24 (1624) does not state at what time Galileo saw the telescope and explained the use of it, but another letter of Faber's to Cesi, amongst the autograph letters in the possession of D. B. Boncompagni, says (May 11): 'I was yesterday evening at the house of our Signor Galileo, who lives near the Madalena; he gave the Cardinal di Zoller a magnificent eye-glass for the Duke of Bavaria. I saw a fly which Signor Galileo himself showed me. I was astounded, and told Signor Galileo that he was another creator, in that he shows things that until now we did not know had been created.' So that even on May 10, 1624, Galileo had not only seen the telescope of Drebbel, and explained the use of it, but had made one himself and sent it to the Duke of Bavaria.

We lack documents to show how this microscope of Galileo was made, that is, whether it had two convergent lenses like those of Drebbel. A letter of Peirese of March 3, 1624, says that 'the effect of the glass is to show the object upside down . . . and so that the real natural motion of the animalcule, which, for example, goes from east to west, seems to go contrariwise, that is, from west to east,' or whether it was not rather composed of a convex and a concave lens, like that made earlier by him, and used in 1610, and then almost forgotten for fourteen years.

It is, however, very probable that this last was the one in question, for Peirese, answering Alejandro on July 1, 1624, wrote:—'But the *occhiale* mentioned by Signor Galileo, which makes flies like hens, is of his own invention, of which he made also a copy for Archduke Albert of pious memory, which used to be placed on the ground, where a fly would be seen the size of a hen, and the instrument was of no greater height than an ordinary dining-room table.' Which description answers far better to a Dutch telescope used as a microscope, in the same way exactly as Galileo had used it, rather than to a microscope with two convex lenses.

One cannot find any further particulars concerning Galileo's *occhialini* (so he had christened them in the year 1624), either in Bartholomew Imperiali's letter of September 5, 1624, in which he thanks Galileo for having given him one in *every way perfect*, or in that of Galileo to Cesi of September 23, 1624, accompanying the gift of an *occhialino*, or in Federico Cesi's answer of October 26, or in a letter of Bartholomeo Balbi to Galileo of October 25, 1624, which speaks of the longing with which Balbi is awaiting 'the little *occhiale* of the new invention,' or in that of Galileo to Cesar Marsili of December 17 in the same year, in which Galileo says to the learned Bolognese 'that he would have sent him an *occhialino* to see close the smallest things, but the instrument maker, who is making the tube, has not yet finished it.' This, however, is how Galileo speaks of it in his letter to Federico Cesi, written from

Florence on September 23, 1624, more than three months after his departure from Rome:—

I send your Excellency an *occhialino*, by which to see close the smallest things, which I hope may give you no small pleasure and entertainment, as it does me. I have been long in sending it, because I could not perfect it before, having experienced some difficulty in finding the way of cutting the glasses perfectly. The object must be placed on the movable circle which is at the base, and moved to see it all, for that which one sees at one look is but a small part. And because the distance between the lens and the object must be most exact, in looking at objects which have relief one must be able to move the glass nearer or further, according as one is looking at this or that part; therefore the little tube is made movable on its stand or guide, as we may wish to call it. It must also be used in very bright, clear weather, or even in the sun itself, remembering that the object must be sufficiently illuminated. I have contemplated very many animals with infinite admiration, amongst which the flea is most horrible, the gnat and the moth the most beautiful; and it was with great satisfaction that I have seen how flies and other little animals manage to walk sticking to the glass and even feet upwards. But your Excellency will have the opportunity of observing thousands and thousands of other details of the most curious kind, of which I beg you to give me account. In fact, one may contemplate endlessly the greatness of Nature, and how subtilly she works, and with what unspeakable diligence.—P.S. The little tube is in two pieces, and you may lengthen it or shorten it at pleasure.

It would be very strange, knowing Galileo's character, that in 1624, and after the attacks made on him for having perhaps a little too much allowed the Dutch telescope to be considered his invention, he should have been induced to imitate Drebbel's glass with the two convex lenses, and have wished to make them pass as his own invention, whilst he had always used, and continued to use to the end of his days, telescopes with a convex and a concave lens without showing that he had read or in the least appreciated the proposal made by Kepler, ever since 1611, to use two convex glasses in order to have telescopes with a large field and more powerful and convenient.

In any case it is impossible to form a decided opinion on such a matter, the data failing; but the very fact that from 1624 onwards Galileo thought no more of the *occhialino* (probably because he found it less powerful and less useful than the *occhiale* of Drebbel), as he had not occupied himself with it or had scarcely remembered it from the year 1610 to 1624, seems sufficient to show that the *occhialino*, like the microscope of 1610, was a small Dutch telescope with two lenses, one convex and one concave, and not a reduced Keplerian telescope like that invented by Drebbel in 1621.

The name of microscope, like that of telescope, originated with the Academy of the Lincei, and it was Giovanni Faber who invented it, as shown by a letter of his to Cesi, written April 13, 1625, and which is amongst the Lincei letters in the possession of D. B. Boncompagni. Here is the passage in Faber's letter:—

I only wish to say this more to your Excellency, that is, that

you will glance only at what I have written concerning the new inventions of Signor Galileo; if I have not put in everything, or if anything ought to be left unsaid, do as best you think. As I also mention his new *occhiale* to look at small things and call it microscope, let your Excellency see if you would like to add that, as the Lyceum gave to the first the name of telescope, so they have wished to give a convenient name to this also, and rightly so, because they are the first in Rome who had one. As soon as Signor Rikio's epigram is finished, it may be printed the next day; in the meanwhile I will get on with the rest. I humbly reverence your Excellency.—From Rome, April 13, 1625. Your Excellency's most humble servant, GIOVANNI FABER (Lynceo).'

The Abbé Rezzi, in a work of his on the invention of the microscope, thought that he might conclude from the passage of Wodderborn, reproduced above, that Galileo did not invent the compound microscope, but gave a convenient form to the simple microscope, and in this way as good as invented it, for the Latin word used by Wodderborn, *perspicillum*, 'signified at that time, it is clear,' Rezzi says, 'no other optical instrument than spectacles or the telescope, never the microscope, of which there is no mention whatever in any book published at that time, nor in any manuscript known till then.'

But Rezzi was not mindful that on October 16, 1610, the date of Wodderborn's essay, the name of microscope had not yet been invented, nor that of telescope, which, according to Faber, was the idea of Cesi, according to others of Giovanni Demisiano, of Cephalonia, at the end, perhaps, of 1610, but more probably at the time of Galileo's journey to Rome from March 29 to June 4, 1611. If, therefore, the word microscope had not yet been invented, and if the telescope, or the *occhiale* as it was then called, was by all named *perspicillum*, one cannot see why Wodderborn's *perspicillum* cannot have been a *cannocchiale* (telescope) smaller than the usual ones, so that it could easily be used to look at near objects, but yet a *cannocchiale* with two lenses, one convex and one concave, like the others, and, therefore, a real *compound microscope*, although not mentioned by that name either by Wodderborn or others. And, besides that, how could it be that Wodderborn beginning to treat 'admirabilis huius perspicilli,' that is, of the *telescope* in the first line, should then have called *perspicillum* a single lens in the eleventh line of the same page? Rezzi's mistake is easily explained, remembering that he had not under his eyes Wodderborn's essay, but only knew a brief extract reported by Venturi.

It thus appears as in the highest degree probable that Galileo, in 1610, was the inventor of the compound microscope: it was subsequently invented, or introduced, and zealously adopted in Holland: and when Dutch invention penetrated into Italy in 1624 Galileo attempted a reclamation of his invention (which was undoubtedly distinct from that of Drebbel): but as these were not warmly seconded and responded to abroad he allowed the whole thing to pass. Nevertheless the facts Govi gives are as interesting as they are important.

In regard to the discovery of the simple lens Govi points out

that after the year 1000, minds having reopened to hope and intellects to study, there began to dawn some light of science, so that in 1276 a Franciscan monk, Roger Bacon, of Ilchester, in his 'Opus Majus,' dedicated and presented by him to Clement IV., could show many marvellous things, and amongst these the efficacy of *crystal* lenses, in order to show things larger, and in this wise he says make of them 'an instrument useful to old men and those whose sight is weakened, who in such a way will be able to see the letters sufficiently enlarged, however small they are.' As long as no documents anterior to him are discovered, Roger Bacon may be considered the first inventor of convergent lenses, and therefore of the *simple microscope*, however small the enlargement by his lenses may have been.

As, however, that man of rare genius, the initiator of experimental physics, had brought on himself the hatred of his contemporaries, they kept him for many years in prison, then shut him up in a convent of his order to the end of his long life of nearly eighty years. His writings had to be hidden, at least those treating on natural science, to save them from destruction, and so the invention of lenses, or the knowledge of their use to enlarge images and to alleviate the infirmities of sight, remained unknown or forgotten in the pages of the famous 'Opus Majus,' which only came to light in 1733 by the care of Samuel Jebb, a learned English doctor.

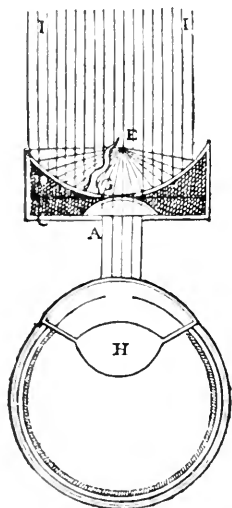

FIG. 91.—Descartes' simple microscope with reflector (1637).

A Florentine, by name Salvino degli Armati, at the end of the thirteenth century (? 1280) (in Bacon's lifetime), had therefore the glory of inventing spectacles, and it was a monk of Pisa, Alexander Spina, who suddenly charitably divulged the secret of their construction and use.

Perhaps Salvino degli Armati and Spina really discovered more than Roger Bacon had discovered; that is, they found out the use of converging lenses for long-sighted people, and of diverging lenses for short sight, whilst the English monk had only spoken of the lenses for long sight, and perhaps they added to this first invention the capability of varying the focal lengths of the lenses according to need, and the other of fixing them on to the visor of a cap to keep them firm in front of the eyes, or to fasten them into two circles made of metal, or of bone joined by a small elastic bridge over the nose. However it may be, the discovery of spectacles, or, as it may be called, of the *simple microscope*, may be equally divided between Roger Bacon and Salvino degli Armati, leaving especially to the latter the invention of spectacles.

The earliest known illustration of a simple microscope is given by Descartes in his 'Dioptrique' in 1637; fig. 91 reproduces it. It is practically identical with one devised by Lieberkühl a century

after and shown on p. 139. A lens is mounted in a central aperture in a polished concave metal reflector. Descartes apparently devised another and much more pretentious instrument, but it appears impracticable and could never have existed save as a suggestion. But he appears to have been the first to publish figures and descriptions for grinding and polishing lenses.

In the Museo di Fisica there

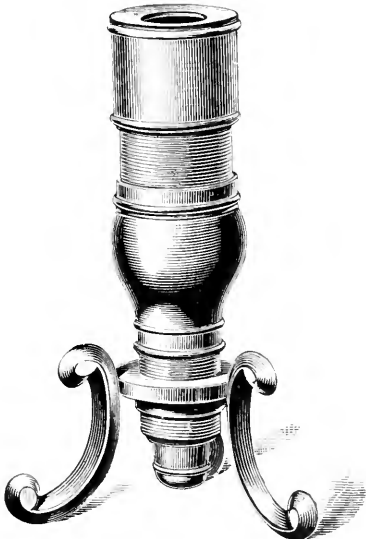
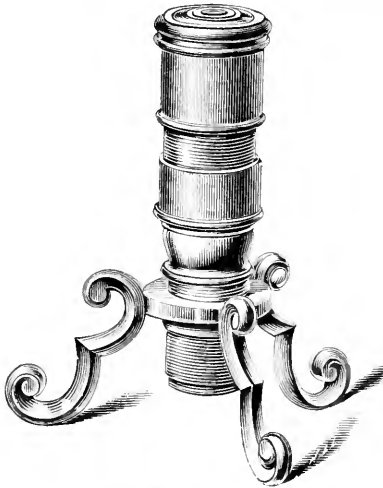

FIG. 92.—Galileo's microscopes.
? Campani or later.

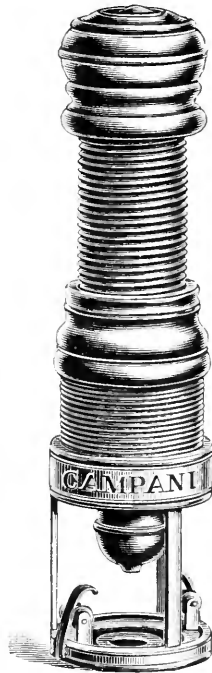

FIG. 93.—Campani's microscope (1660)?

are two small microscopes which it is affirmed have been handed down from generation to generation since the dissolution of the Accademia del Cimento in 1667, with the tradition of having been constructed by Galileo. They are shown in fig. 92, but from the superiority of construction of these instruments it is very improbable that they belong to the days of Galileo, who died in 1642; and there is a specially interesting compound

are two small microscopes which it is affirmed have been handed down from generation to generation since the dissolution of the Accademia del Cimento in 1667, with the tradition of having been constructed by Galileo. They are shown in

microscope, by Giuseppe Campani, which was published first in 1686, which is presented in fig. 93; its close similarity to 'Galileo microscopes' is plainly apparent, making it still more improbable that these could be given a date prior to 1642.

In a journal of the travels of M. de Monconys, published in 1665, there is a description of his microscope which is of much interest. He states that the distance from the object to the first lens is one inch and a half; the focus of the first lens is one inch; the distance from the first lens to the second is fifteen inches; the focus of the second lens, one inch and a half; distance from the second to the third, one inch and eight lines; the focus of the third lens, one inch and eight lines; and the distance from the eye to the third lens, eight lines.

This would form the data of a practical compound microscope with a field lens; and as Monconys had this instrument made in 1660 by the 'son-in-law of Viselius,' it becomes probable in a very high degree that to him must be attributed the earliest device of a microscope with a field-lens.

In 1665 Hooke published his 'Micrographia,' giving an account and a figure of his compound microscope. He adopted the field-lens employed by Monconys and gives details as to the mode and object

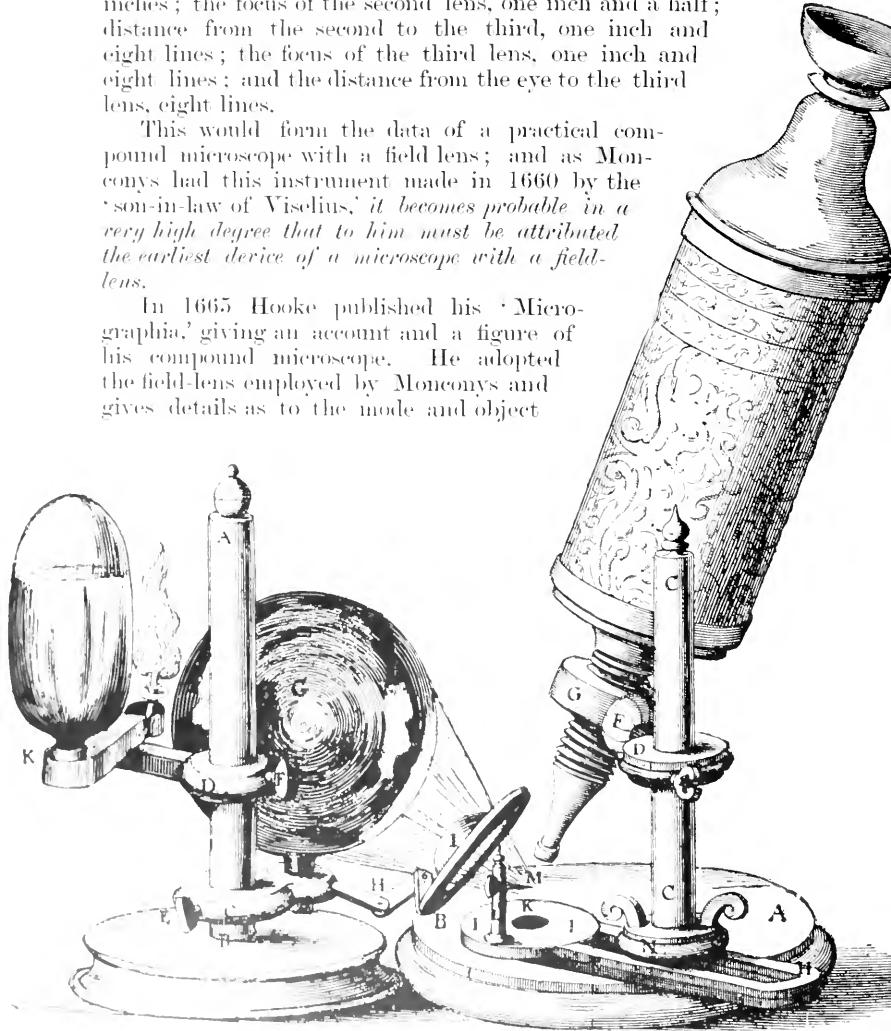

FIG. 91.—Hooke's compound microscope (1665).

of its employment, which are at once interesting and instructive; for they show quite clearly that it was not employed by him to correct the spherical aberration of the eye-lens, but merely to increase the size of the field of view. He tells us that he used it 'only when he had occasion to see much of an object at once. . . . But whenever I had occasion to examine the small parts of a body more accurately I took out the middle glass (field-lens) and only made use of one eye-glass with the object-glass.'

Fig. 94 is a reproduction of the original drawing, and the general design appears to be claimed by Hooke. There is a ball-and-socket movement to the body, of which he writes: 'On the end of this arm (D), which slides on the pillar C C) was a small ball fitted into a kind of socket F, made in the side of the brass ring G, through which the small end of the tube was screwed, by means of which contrivance I could place and fix the tube in whatsoever posture I desired (which for many observations was exceedingly necessary), and adjusted it most exactly to any object.'

It need hardly be remarked that, useful as the ball-and-socket joint is for many purposes in microscopy, it is not advantageously employed in this instrument.

Hooke devised the powerful illuminating arrangement seen in the figure, and employed a stage for objects based on a practical knowledge of what was required. He described a useful method of estimating magnifying power, and was an industrious, wide, and thoroughly practical observer. But he worked without a mirror, and the screw-focussing arrangement seen in the drawing must have been as troublesome as it was faulty. But as a microscopist, Hooke gained a European fame, and gave a powerful stimulus to microscopy in England.

In 1668 a description was published in the 'Giornale dei Letterati' of a compound microscope by Eustachio Divini, which Fabri had previously commended. It was stated to be about $16\frac{1}{2}$ inches high, and adjustable to four different lengths by draw-tubes, giving a range of

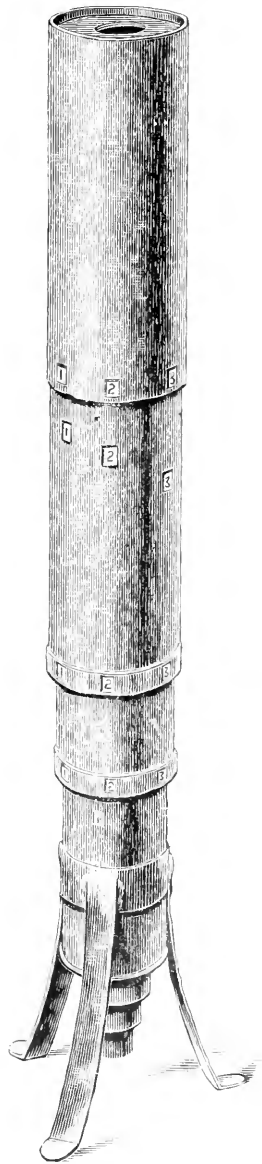

FIG. 95.—Divini's compound microscope (1668).

magnification from 41 to 143 diameters. Instead of the usual bi-convex eye-lens, two plano-convex lenses were applied with their convex surfaces in contact, by which he claimed to obtain a much flatter field. Mr. Mayall found in the Museo Copernicano at Rome a microscope answering so closely to this description that he does not hesitate to refer its origin to Divini. He made the sketch of

it given in fig. 95. But the optical construction had been tampered with and could not be estimated.

Chérubin d'Orléans published, in 1671, a treatise containing a design for a microscope, of which fig. 96 is an illustration. The scrolls were of ebony, firmly attached to the base and to the collar encircling the fixed central portion of the body-tube. An exterior sliding tube carried the eye-piece above on the fixed tube, and a similar sliding tube carried the object-lens below, these sliding tubes serving to focus the image and regulate (within certain limits) the magnification. He also suggested a screw arrangement to be applied beneath the stage for focusing. He devised, or recommended, several combinations of lenses for the optical part of the micro-

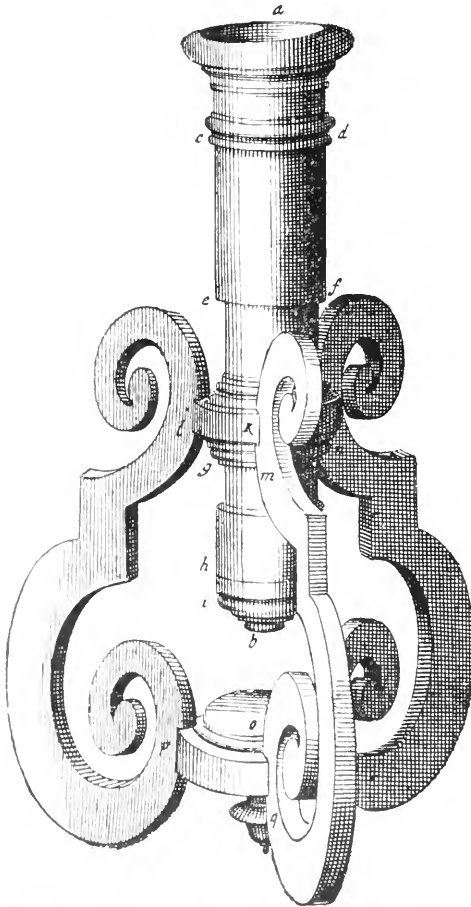

FIG. 96.—Chérubin d'Orléans' compound microscope (1671).

scope, and refers to combinations of three or four separate lenses, by which objects could be seen erect, which he considered 'much to be preferred.'

He also invented a binocular form of microscope and published it in his work, 'La Vision Parfaite,' in 1677. It consisted of two compound microscopes joined together in one setting, so as to be

applicable to both eyes at once; a segment of each object-lens (supposed to be of one-inch focus) was ground away to allow the convergent axes starting from the two eyes to meet at about 16 inches distance at the common focus. Mechanism was provided for regulating the width of the axes to correspond with the observer's eyes.

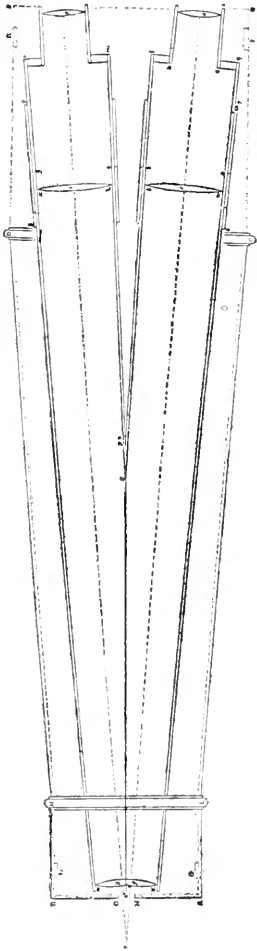

FIG. 97 (1677).

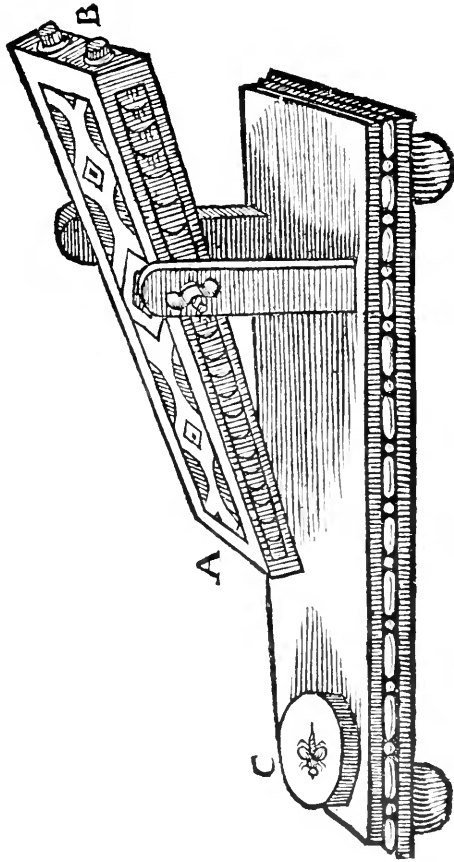

FIG. 98. — Clérubin d'Orléans' binocular microscope (1685).

Fig. 97, showing the optical construction, is copied from the original diagram ('*La Vision Parfaite*,' tab. i. fig. 2. p. 80). According to the arrangement of the lenses as shown in the figure a pseudo-stereoscopic image would have been obtained.

A drawing of this binocular, as known to Zalm, was given in the first edition of his '*Oculus Artificialis*' in 1685 (*Fundamen III.* p. 233), and is reproduced in fig. 98.

In 1672 Sir Isaac Newton communicated to the Royal Society a note and diagram for a reflecting microscope; we have, however, no evidence that it was ever constructed. But in 1673 Leeuwenhoek began to send to the Royal Society his microscopical discoveries. Nothing was known of the construction of his instruments, except that they were simple microscopes, even down to so late a period as 1709. We know, however, that his microscopes were mechanically rough, and that optically they consisted of simple bi-convex lenses, with worked surfaces mounted between two plates of thin metal with minute apertures through which the objects were directly seen. At his death Leeuwenhoek bequeathed a cabinet of twenty-six of his microscopes to the Royal Society; unhappily, they have mysteriously

disappeared. But Mr. May all was enabled to figure one lodged in the museum of the Utrecht University, which is given in figs. 99 and 100 in full size. The lens is seen in the upper third of the plate. It has a $\frac{1}{4}$ -inch focus. The object is held in front of the lens, on the point of a short rod, with screw arrangements for adjusting the object under the lens.

Many modifications of this and the preceding instruments are found with some early English forms, but no important constructive or optical modification immediately presents itself. But some ingenious arrangements are found in the simple microscopes devised by Musschenbroek in the early years of the eighteenth century.

Grindl figured a microscope in his 'Micrographia Nova' in 1687, in which optical modifications arise. Divini had, as was stated, combined two plano-convex lenses, with their convex surfaces facing, to form an eye-piece: this idea was carried further in 1668 by a London optician, who used two pairs of these lenses; Grindl did this also, but in addition he used two similar (but smaller) lenses in the same manner as an objective. The form of the microscope itself was copied from that of Cherubin d'Orléans (fig. 97), but was modified by the application of an external screw.

In 1691 Bonanni modified preceding arrangements by devising some means of flipping the object between two plates pressed away from the object by a spiral spring, the focussing being then effected by a screw barrel.

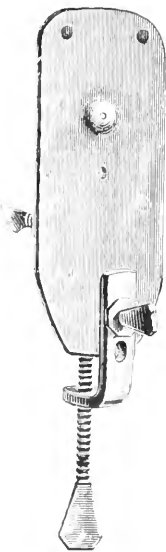

FIG. 99.

Leeuwenhoek's microscope (1673).

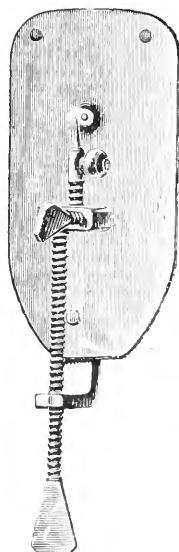

FIG. 100.

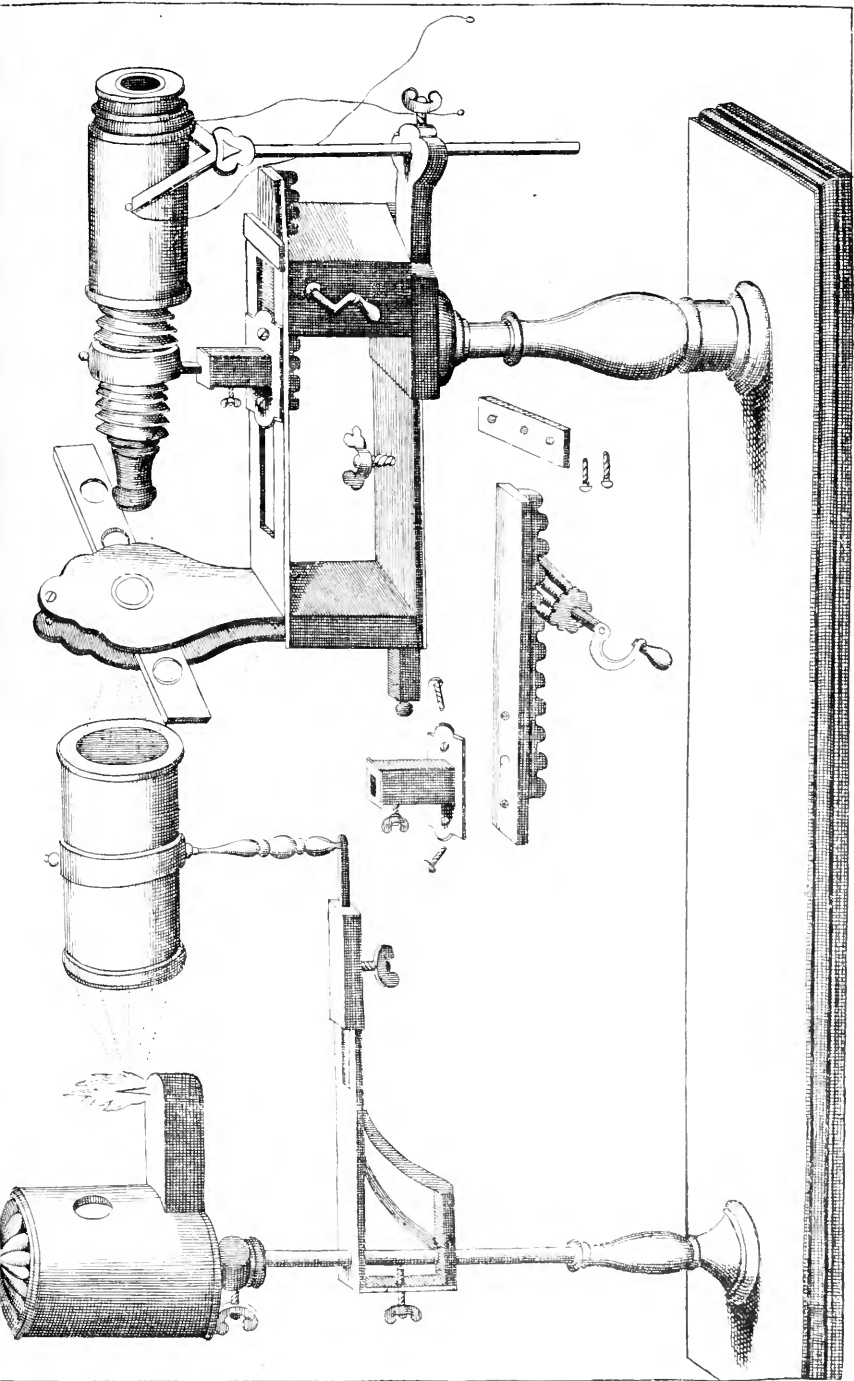

FIG. 10].—Bonham's horizontal compound microscope (1691).

This system of focussing was employed in a more practical form by Hartsoeker in 1694 and was adopted by Wilson in 1702. It became a very popular form for the microscope in the eighteenth century.

We are indebted to Bonannus also for originating a horizontal form of microscope, which is interesting and which, in a drawing of the instrument, is shown to possess a sub-stage *compound condenser fitted with focussing arrangements for illuminating transparent objects*. There was great convenience in using the microscope in a horizontal position with a lamp and condenser in the same axis, especially as all the compound microscopes previously constructed had been employed vertically, or had been directed towards the sky for purposes of illumination. Remarkably crude as the mechanism appears, it is a very early instance of the use of what has become—though slowly and late on the continent—a now universally acknow-

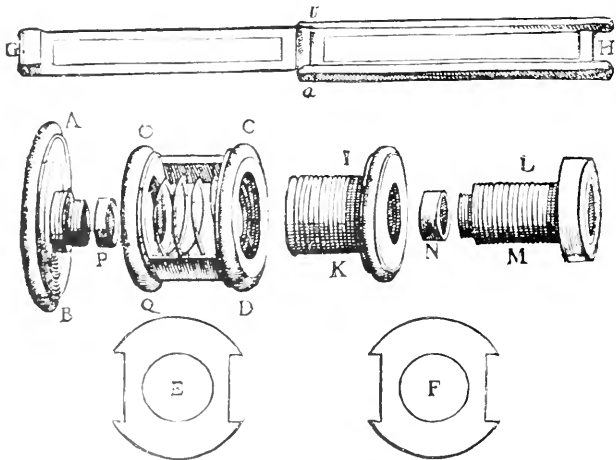

FIG. 102.—Hartsoeker's simple microscope (1694).

ledged optical arrangement indispensable for the best results, viz. a compound condenser fitted with focussing mechanism for illuminating transparent objects. The picture of the entire instrument is shown in fig. 101.

In Hartsoeker's microscope the lens-carrier A B, fig. 102 (on which the cell P, containing the lens, is screwed), screws into the body O C, Q D at O Q; the thin brass plates E and F fit within the body, the portions cut out allowing them to slide on the short pillars O C and Q D, and the spiral spring pressing them towards C D; the object slides, or an animalcule cage G H (hinged at *a b* to allow the bar G to fit into H, enclosing the objects between strips of tale), slip between the plates E and F when in position, and the "screw-barrel," I K, fits into the screw-socket C D and regulates the focus; the focussing lens, N, fits, on a second "screw-barrel," L M, which is applied to the screw-socket of I K. This arrangement of

the condenser is better than the plan adopted by Wilson, as it allows the illumination to be focussed on the object independently of the focal adjustment of the object to the magnifying lens; whereas in Wilson's microscope, the condenser being mounted in I K, without facility of adjustment, remained at a fixed distance from the object, and hence the control of the illumination was very limited.'

Another microscope dated 1702 is shown in fig. 103 as drawn by Zahn in his 'Oculus Artificialis.' Fig. 103 presents a back view of it and shows an oval wooden plate;

on the other side of this is a similar plate which holds the lens in such a position that it is opposite the aperture A. Between the two plates there is a rotary multiple object holder shown in fig. 103A M N, the object being inserted in the apertures in the circumference of the disc. Focussing is accomplished

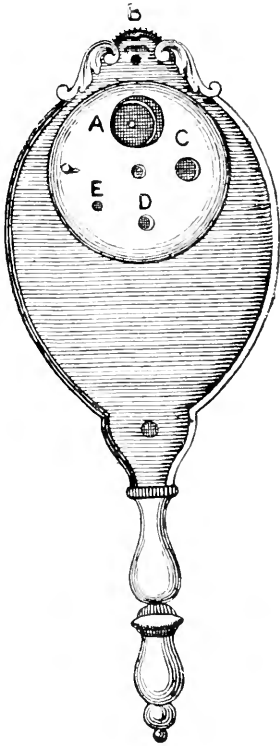

FIG. 103 (1702).

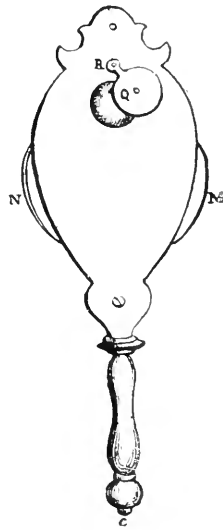

FIG. 103A (1686).

by means of the milled head B which is attached to a screw regulating the distance between the two plates, one of which carries the lens, the other the rotary object holder. The point worthy of note in this instrument is the rotating wheel of graduated diaphragms A, C, D, E, placed on the side away from the lens. This is the first instance of a useful appliance surviving in our present microscopes.

In Harris's 'Lexicon Technicum' (1704, 2 vols. fol.), under the word microscope, Marshall's compound microscope (fig. 104) is described and figured. Several important innovations in micro-

JOHN MARSHALL'S New Invented DOUBLE MICROSCOPE, For Viewing the CIRCULATION of the BLOOD

Made & Sold by him at the Archimedes &
Golden Spectacles in Ludgate Street.

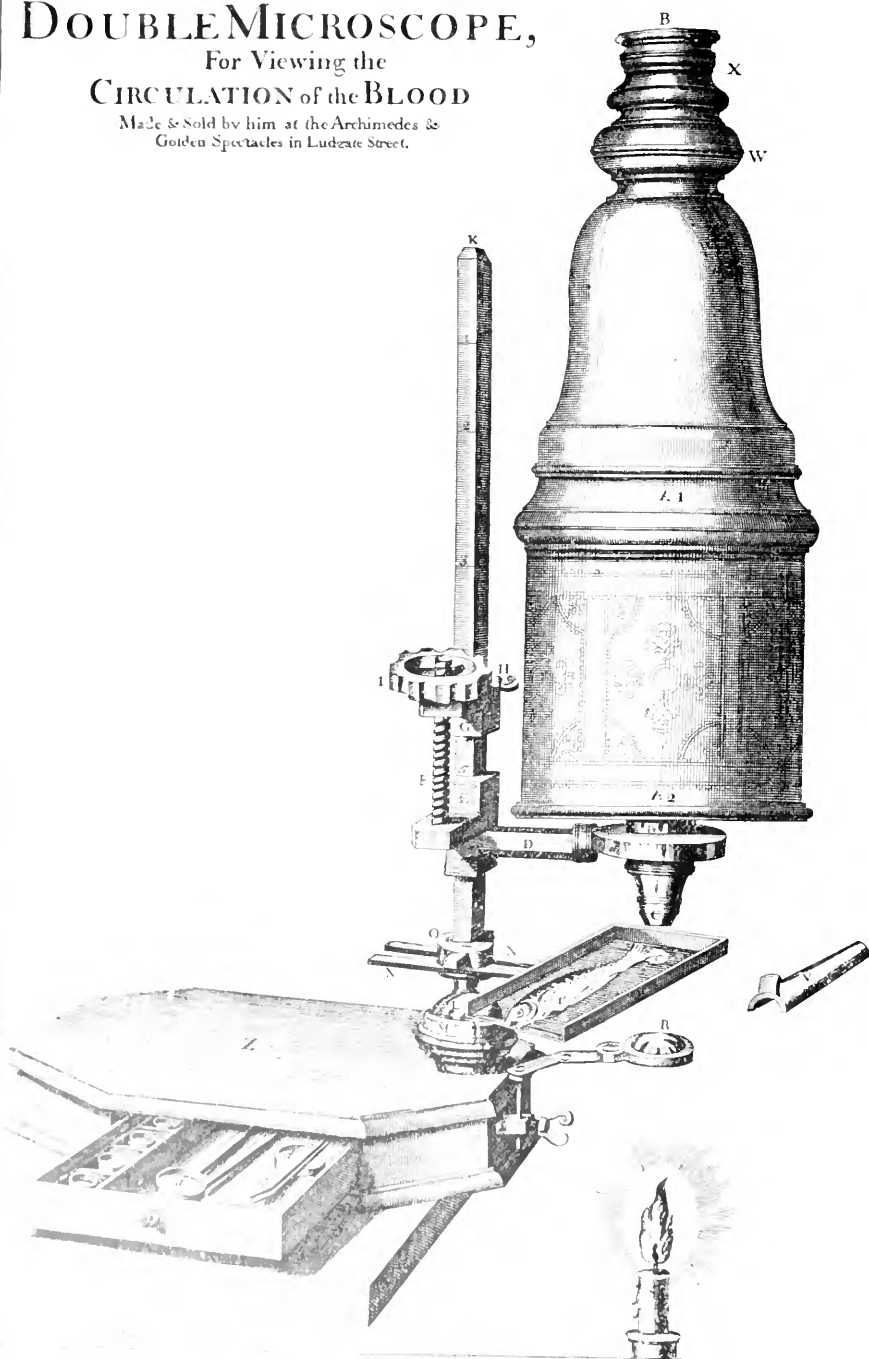

FIG. 101.

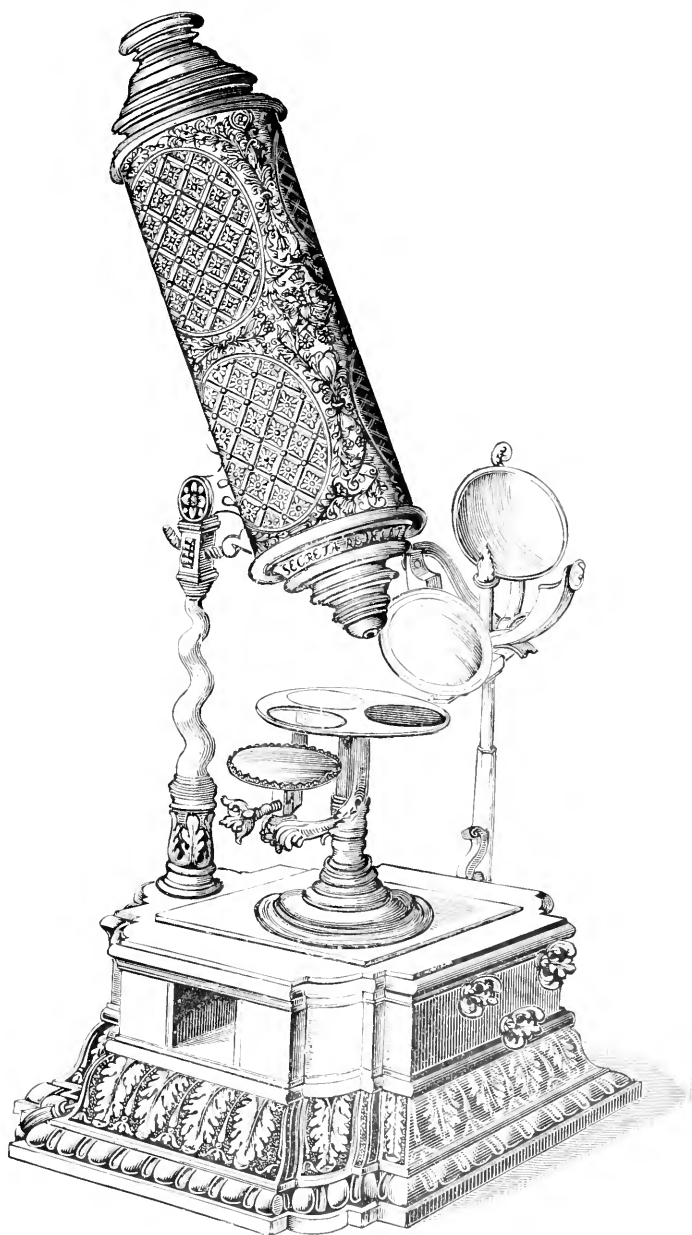

FIG. 105.—Hertel's microscope (1716).

scopical construction were here embodied. (1) A fine-adjustment screw F is connected with the sliding socket E, supporting the arm D, in which the body-tube is screwed; the focussing could thus be controlled in a far more effective manner than by any system previously applied to a large microscope. The previous systems involved the direct movement of the body-tube either by rotating in a screw-socket (as in Hooke's) or by sliding in a cylindrical socket (as in Divini's and Chérubin's); in a few instances the object was moved

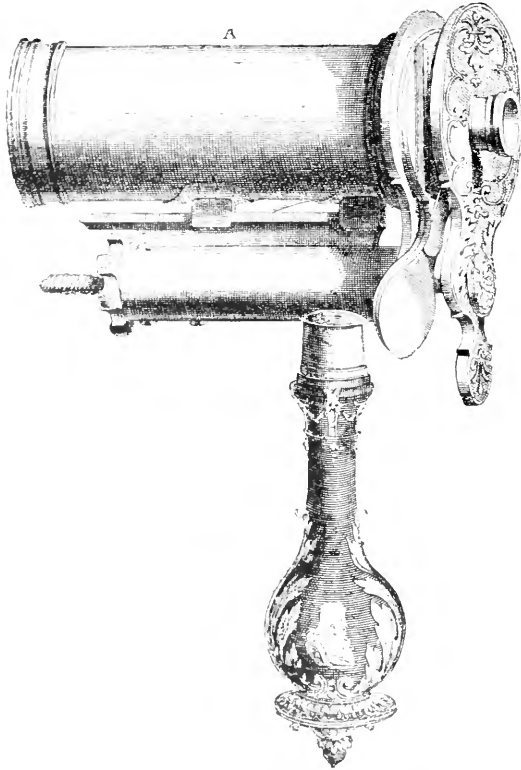

FIG. 106. — M. Joblot's microscope (1718).

in relation to the object lens, but all these plans were more or less defective, especially with microscopes of large dimensions. Marshall's system was a distinct mechanical improvement, for the object could now be viewed during the actual process of focussing, as the image would remain steadily in the field. (2) A fork, N N, is here applied to the body-tube, which is here applied to the pillar itself. (3) Hooke's ball-and-socket joint, which was applied to the arm I, is here shifted to the base of the pillar, where it would give the movements of the body-tube to the whole microscope instead of to the body-tube only.

as in Hooke's; the ball L could be tightly clamped by the screw collar M, in which slots were cut to give spring. (4) A condensing lens on jointed arms appears; this probably was the first application of such adjustments to the condenser. From the singular position of the candle beneath the condenser, we may infer, without doubt, that the mirror was still unknown as a microscopical accessory in England.

In fact, in no microscope up to this time has there been any trace of, or reference to, a mirror;

but in 1716 Hertel employed it and introduced some other considerable modifications. The general appearance of the instrument as originally figured by Hertel is given in fig. 105. Not only have we the mirror below the stage, but also above the stage a concave metal mirror reflecting light through a condenser on the object, while the stage has focussing movement by the right-hand ornamental 'butterfly' nut, and is capable of movement to and from the pillar by the middle nut, and also of rotary movement by the left-hand nut. These two last movements form what is now known as a 'mechanical stage.' The body-tube is hinged and is inclined by a screw-sector mechanism. A distinct advance on the simple microscopes which had preceded it was made by one devised by M. Joblot, and illustrated in fig. 106. The ornamental plate holds the lens, the focus being adjusted by the nut and screw; the plate next to the ornamental one is a concentric rotary stage, of good mechanical quality. The tube A was called by Joblot 'the Canon,' and was lined with black cloth or velvet, and has a diaphragm at each end. These diaphragms are movable, which was practically a considerable optical benefit.

In 1738 Dr. N. Lieberkühn devised, what had been employed in principle by Descartes a century before,¹ the instrument that has ever since been known by his name, and which is still of considerable value to the microscopist. Fig. 107 is a reproduction from the earliest drawing known of Lieberkühn's microscope. A A is a concave mirror of silver; from its form the light is reflected from it to a focus on the object C. The mirror is pierced in the centre at B, and the lens, or object-glass, is inserted and adjusted,

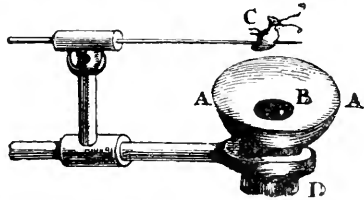

FIG. 107.—Lieberkühn's microscope (1738).

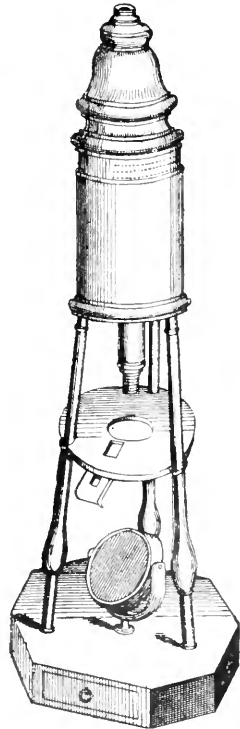

FIG. 108.—Culpeper and Scarlet's microscope (1738).

¹ See pp. 126-7.

the eye being placed behind in the direction D at any point the single lens or a combination might require.

Culpeper and Scarlet's microscope requires a note, and is illustrated in fig. 108. It was inappropriately designated a 'reflecting' microscope, but this arose merely from the fact that it was the first English model which employed an illuminating mirror. It was, however, a dioptric, not a catoptric instrument, and is figured in Dr. Smith's 'Opticks,' 1738.

'A Pocket Reflecting Microscope' was figured by Benjamin Martin in his 'Micrographia Nova' in 1742, having the interesting feature of a micrometer eye-piece depending on a screw with a certain number of threads to the inch, and by which accurate measurements could be taken. It was called a *reflecting* microscope because it had a mirror fitted into its cylindrical base; but it was, in reality, a compound refracting form, and appears to have been the original from whence the modern 'drum' microscopes were taken.

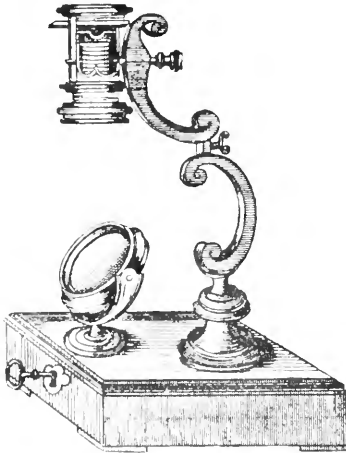

FIG. 109. Wilson's simple microscope on scroll standard (as made by Adams, 1746).

Wilson devised a simple 'screw-barrel' microscope in 1702, and Baker describes and figures in 1742 the Wilson model mounted on a scroll standard and with a mirror mounted on the base in a line with the optic axis. Fig. 109 reproduces the drawing of Adams.

But Martin originated a large number of improvements both in the optical arrangements and the mechanism of the microscope, and was an excellent maker. He applied rack-and-pinion focussing adjustments, to the compound microscope he added inclining movements to the pillar carrying the stage and mirror, and he furnished the stage with rectangular movements.

It was to this maker that the late Professor Quekett was indebted for an early microscope, of which he evidently to the last thought highly, and which was subsequently purchased by the Royal Microscopical Society. A drawing of this instrument is given in fig. 110, and should be described in Quekett's own words. He says: 'It stands about two feet in height, and is supported on a tripod base, A; the central part or stem, B, is of triangular figure, having a rack at the back, upon which the stage, O, and frame, D, supporting the mirror, E, are capable of being moved up or down. The compound body, F, is three inches in diameter; it is composed of two tubes, the inner of which contains the eye-piece, and can be moved up and down by rack and pinion, so as to increase or diminish the magnifying power. At the base of the triangular bar is a cradle

joint, G, by which the instrument can be inclined by turning the screw-head, H [connected with an endless screw acting upon a worm-wheel]. The arm, I, supporting the compound body, is supplied with a rack and pinion, K, by which it can be moved backwards and forwards, and a joint is placed below it, upon which the body can be turned into a horizontal position; another bar carrying a stage and mirror can be attached by the screw, L N, so as to convert it into a horizontal microscope.

The stage, O, is provided with all the usual apparatus for clamping objects, and a condenser can be applied to its under surface; the stage itself may be removed, the arm, P, supporting it, turned round on the pivot C, and another stage of exquisite workmanship placed in its stead, the under surface of which is shown at Q.

This stage is strictly a micrometer one, having rectangular movements and a fine adjustment, the movements being accomplished by fine-threaded screws, the milled heads of which are graduated.

The mirror, E, is a double one, and can be raised or depressed by rack and pinion; it is also capable of removal, and an apparatus for holding large opaque objects, such as minerals, can be substituted for it. The accessory instruments are very numerous, and amongst the more remarkable may be mentioned a tube, M,

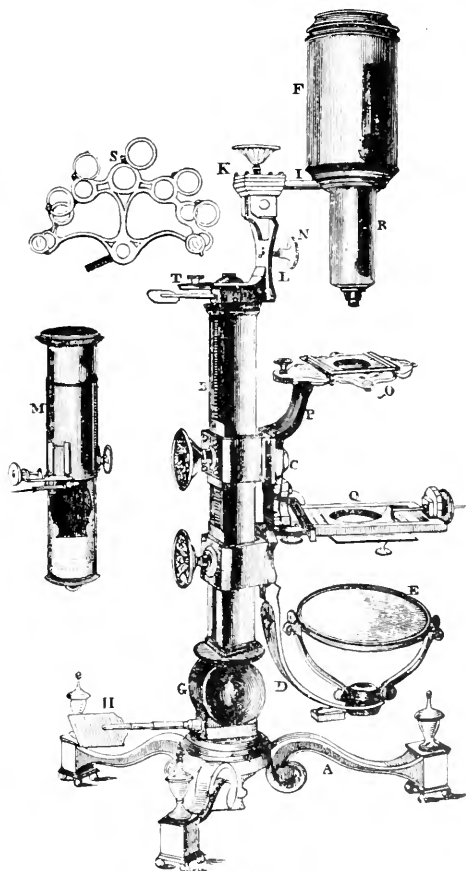

FIG. 110.—Martin's large universal microscope as used by Quekett (1780).

containing a speculum, which can take the place of the tube, R, and so form a reflecting microscope. The apparatus for holding animalcules or other live objects, which is represented at S, as well as a plate of glass six inches in diameter, with four concave wells ground in it, can be applied to the stage, so that each well may be brought in succession under the magnifying power. The lenses belonging to

this microscope are twenty-four in number; they vary in focal length from four inches to one-tenth of an inch; ten of them are supplied with Lieberkühns. A small arm, capable of carrying single lenses, can be applied at T, and when turned over the stage the instrument becomes a single microscope; there are four lenses suitable for this purpose, their focal length varying from $\frac{1}{10}$ th to $\frac{1}{40}$ th of an inch. The performance of all the lenses is excellent, and no pains appear to have been spared in their construction. There are numerous other pieces of accessory apparatus, all remarkable for the beauty of their workmanship.⁷

Benj. Martin not only in this way greatly advanced the mechanical arrangements of the microscope, but he improved the optical part. He used a Huyghenian eye-piece on the telescope formula, where the focus of the eye-lens was that of the field-lens 3, and the distance between them 2; but instead of employing a single eye-lens he broke it up into two of equal foci, that nearest the eye being a 'crossed' lens, and the other a plano-convex, the steeper convexities of these lenses being towards each other. In addition to this he placed at a short distance above the nose piece an equi-convex lens of $5\frac{1}{2}$ inches focus; this acted as a back lens to all the objectives, so that when an objective was changed it was really only the front lens of a compound objective that was altered.

Cuff designed and made a microscope, in 1744, which Baker figured and described in his 'Employment for the Microscope' in 1753, which possessed several conveniences and improvements. Not the least of these is that which gives greater delicacy to the fine adjustment than is found in any preceding model. It was subsequently further improved by the addition of a cradle joint at the bottom of the pillar by Adams. Cuff also designed a simple form of micrometer.

There were three designs of microscopes by George Adams, of London, in 1746 and 1771, which have many points of interest, but scarcely contribute enough of distinctive improvement to the modern forms of the microscope to detain us long. That designed in 1771 is figured in the Adams 'Micrographia Illustrata,' and is reproduced in fig. III.

In this instrument Adams claims to have embodied a number of improvements on all previous constructions. He applied 'two eye-glasses at A, a third near B, and a fourth in the conical part between B and C,' by which he increased 'the field of view and of light;' draw tubes were at A and B, by which these lenses could be separated more or less, but the probability is very great that these were simply copied from the improvements of a like kind devised by B. Martin and described above. He also arranged the object-lenses, or 'buttons,' *a* and *b*, to be combined; seven 'buttons' were provided, and six silver specula ['Lieberkühns'] highly polished, each having an angle adapted to the focus of its concavity, one of which is represented at *c*, and the 'buttons' could also be used with 'any one of these specula' by means of the adapter, *d*.

⁷ *Treatise on the Use of the Microscope*, 3rd. ed. London, 1855, 8vo,

THE VARIABLE MICROSCOPE

By George Adams, N^o. 60. Fleet Street, LONDON

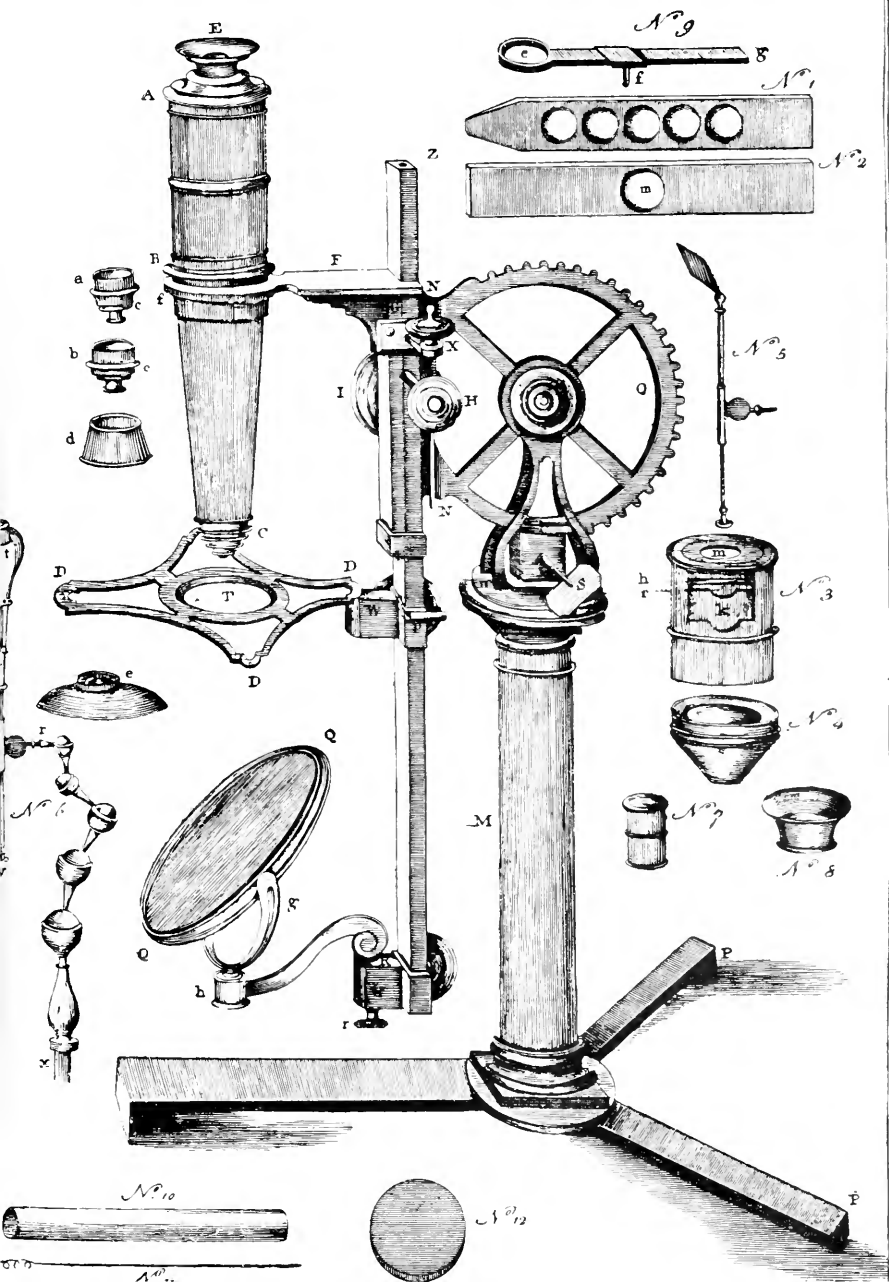

The body-tube, A B C, with its arm, F (in which it screwed at *f*), and stem attachment with the fine adjustment were clearly modified from a design which Cuff originated. The large ivory head, I, actuated a pinion and rack for raising or depressing the body-attachment on the stem, but as there was only one slide the rackwork could not be used unless the fine adjustment was first put out of action by unclamping it. The stage and mirror were adjustable on the stem. The large ratchet-wheel controlled by the pinion-handle, S, gave the required inclination to the stem.

Nos. 1 and 2 were ivory and glass 'sliders' for objects, to be applied in the spring-stage No. 3 fitting at T; the 'hollow at K [No. 3] is to receive the glass-tube No. 10.' No. 4 was a diaphragm called a cone, from its conical shape; this was invented by Baker in 1743, and was used in all microscopes up to about 1820, when the wheel of diaphragms was re-invented by Mons. Le Baillif of Paris fitting in the lower end of No. 3, 'to exclude some part of the light which is reflected from the mirror Q.' The forceps, No. 5, could be placed 'in one of the small holes near the extremities of the stage, or in the socket, R, at the end of the chain of balls No. 6.' No. 6 was an arm composed of a series of ball-and-socket joints, similar to the system employed by Musschenbreeck, by Joblot, and by Lyonet, and was intended to be applied at W, when the stage was removed. No. 7 was a box of ivory in which discs of talc and brass rings were packed; No. 8, a hand-magnifier; No. 9, a sliding arm lens-carrier fitting on Z, when the instrument was required to be used as a simple microscope; No. 11, a rod of wire with spiral at the end for picking up soft objects from bottles &c.; and No. 12, an ivory disc, black on one side and white on the other, fitting at T, to carry opaque objects.

To use the instrument as a simple microscope the body-tube, A B C, was removed from the ring, F; the lens-carrier, No. 9, was placed on Z, and a lens with reflector, E, screwed in the ring, *c*; the ball-and-socket arm, No. 6, was applied at W, by the part X, and the object held by either of the forceps could be turned and viewed as desired. For dissections &c. the stage could be screwed on at F, and a glass plate applied at T.

One of the best examples of this design has a nose-piece with a slide carrying three objectives—one of the first arrangements of 'triple nose-piece,' or, indeed, of changing nose-piece for objectives (as distinguished from simple lens-carriers) that have been met with.

A microscope devised by Dellebarre was made the subject of a special report to the 'Académie des Sciences' in June 1777, but there is nothing in it deserving special consideration in comparison with contemporary or even anterior forms as bearing upon the evolution of the microscope as we now know it. In fact, up to the time when achromatism exerted so powerful an influence upon the form and construction of the instrument, there is no microscope that calls for further consideration save one—by an English maker named Jones. It was called Jones's 'Most Approved Compound Microscope and Apparatus,' and although, in principle, it does not differ from Adams's arrangement, fig. 111, it yet presented differences of detail.

Its date was 1798, and is seen in fig. 112, which is taken from the original figure in Adams's 'Essays on the Microscope.'

The base is a folding tripod, and the stem inclines upon a compass-joint on the top of the pillar. Mr. Mayall justly remarks that this was the best system devised up to this date. The arm

carrying the body-tube can be rotated on the top of the limb E, and is also provided with a rack and pinion D. An extra carrier, W, is provided for special purposes pivoting at S, so that objects will remain in the optic axis though the stage be moved in arc. There are also clips provided for the stage. There is a condenser at U, which slides on the stem by the socket *u*. The mirror also slides on the stem. There is provided a rotating multiple disc, P, of object-lenses, and a brass cell contains a high power, of $\frac{1}{30}$ or $\frac{1}{40}$ inch focus, which on the removal of the lens-disc can be screwed into the nose-piece.

There were also designed some interesting forms of reflecting microscopes, to the details of which we can afford no space, their influence having been of no value in the develop-

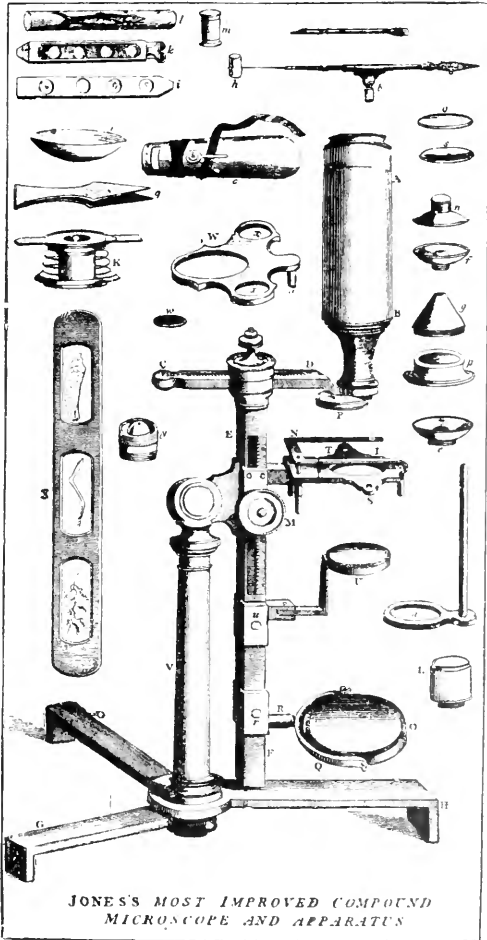

JONES'S MOST IMPROVED COMPOUND MICROSCOPE AND APPARATUS

FIG. 112 (1798).

ment of the microscope as we know it. There was a reflecting microscope suggested by Sir Isaac Newton in 1672, and one was devised on the principle of the Gregorian telescope by Barker in 1736; another of the Cassegrainian form was made in 1738 by Smith, which was, perhaps, the most perfect of the Catoptric forms.

An outline of its construction and the path of the light-beams is

given in fig. 113. It was for examining transparent objects and was similar to the Cassegrainian telescope, but with an extra long eyepiece tube to permit the focussing by movement of the eye-lens. The object was placed at M N; the image was taken up by the concave, reflected on the convex, and again reflected to the eye-lens. He advised the use of a condensing lens for the illumination, to prevent 'the mixture of foreign rays with those of the object,' otherwise the instrument gave confused images of distant objects when it was used as a microscope.

Even without a condenser there are good images attainable with this instrument, but with the condenser they would be, of course, improved.

We have not followed in any detail the forms of simple microscopes as they presented themselves, but in 1755 a form was made by Cuff that can only be regarded as the precursor of the most com-

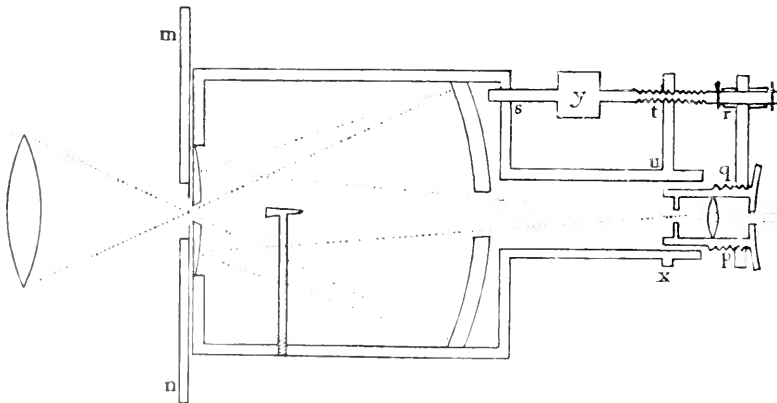

FIG. 113.—Smith's reflecting microscope (1738).

plete and perfect of our simple dissecting microscopes: it is shown in fig. 114. A disc of plane glass, C, or a concave, M, was applied, on the stage of which dissections &c. could be made; a mirror, I, was fitted in a gimbal with a stem sliding in a socket in the pillar; the lens-carrier, P, alone, or with Lieberkühn, F, screwed in a ring on the end of a horizontal arm, E, sliding through a socket, attached to a vertical rod, D, sliding and rotating in a socket at the back of the pillar for focussing &c. This motion of the lens over the object became very popular and was employed in nearly all microscopes up to the time of the establishment of achromatism; the last microscope so fitted was that designed by Mr. W. Valentine and made by Andrew Ross 1831. The movement in arc lasted much longer, and the best remnant of it is still to be found in Powell's No. 1. The pillar, screwed on the lid of the box, within which the instrument was packed with sundry accessories.

It was to the discovery of achromatism as applied to microscopic

object-glasses that we must attribute the strictly scientific value and progress in development of this now extremely valuable and beautiful instrument. An exhaustive account of the earliest discovery and progressive application to our own day of achromatism, so far as it can be given in this treatise, will be found in the chapter on objectives. We can here only attempt, for the sake of completeness, a very broad outline of the facts.

Martin appears to have constructed an achromatic objective in 1759, but no results of practical value were obtained, Martin having formed the judgment that his achromatic microscope was not equal to a reflecting microscope with which he compared it. But it certainly gives him a place of interest in the history of the achromatism of object-glasses for the microscope.

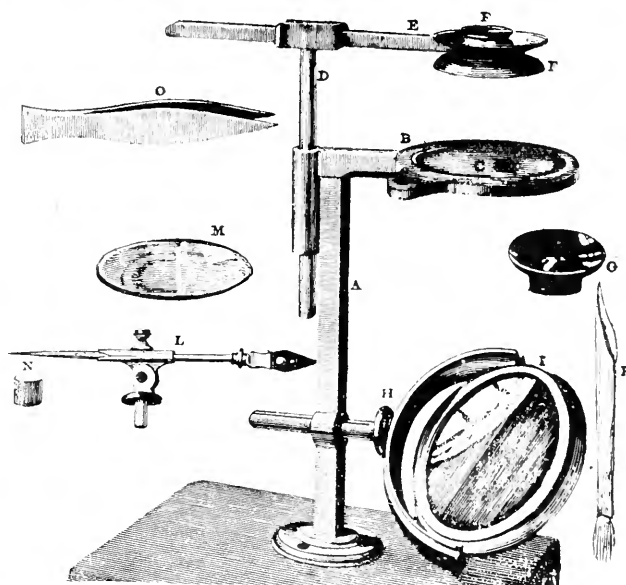

FIG. 114.—Ellis's aquatic microscope (1755)

In 1762 Euler began to discuss the theory of achromatic microscopes, and in 1771, in his 'Dioptrica,' he entered upon the subject at more considerable length. A pupil of his, named Nicholas Fuss, published in St. Petersburg, in 1774, a volume entitled 'Detailed instruction for carrying lenses of different kinds to a greater degree of perfection, with a description of a microscope which may pass for the most perfect of its kind, taken from the dioptric theory of Leonard Euler, and made comprehensible to workmen by Nicholas Fuss.' This was translated into German by Klügel in 1778, but no result of these discussions of the theory of achromatism can be discovered earlier than 1791, when François Beeldsnyder made an achromatic objective which was presented by Harting to the museum of the University of Utrecht; but it was far from satisfactory. It

was composed of two biconvex crown-glass lenses, and a biconcave flint lens placed between them.

C. Chevalier tells us¹ that between 1800 and 1810 M. Charles, of the 'Institut,' Paris, made small achromatic lenses; but they were too imperfect to be of real service. In 1811 Fraunhofer made achromatic doublets with no great success; and in 1823-4 an achromatic microscope was made by the Messrs. Chevalier, with four doublet lenses arranged according to a plan devised by Selligue. Their 'Microscope d'Euler' followed, and in 1827 Amici constructed a horizontal microscope on achromatic principles, which was spoken

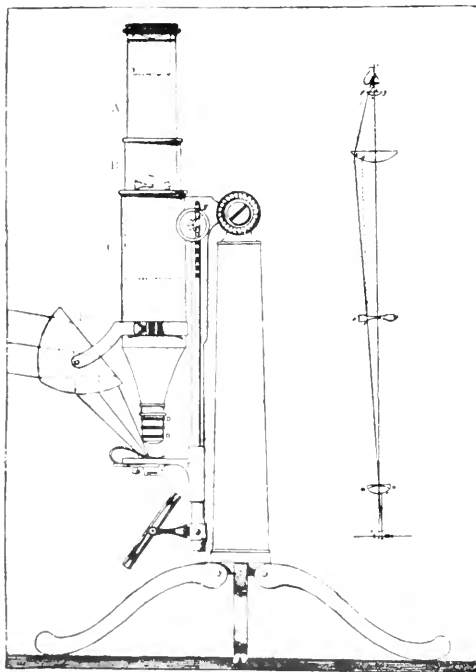

FIG. 115.—Selligue's achromatic microscope (1823-4).

well of. But while up to a very recent date it was common to assert that the first to suggest the plan of combining two, three, or four plano-convex achromatic doublets of similar foci, one above the other, to increase the power and aperture, was Selligue in 1823, it is now known that this had been anticipated by Marzoli (ch. v. 353). Selligue's plan was carried into execution by the Messrs. Chevalier. The instrument embodying this plan is shown in fig. 115.

In a report to the Académie Royale des Sciences, the well-known mathematician Fresnel says, concerning this mi-

croscope, that in comparing the objectives with those of one of Adams's best non-achromatic instruments—that up to a magnification of two hundred times—Selligue's was decidedly superior; but beyond that magnification there was no superiority in the achromatic form, and he preferred Adams's form for prolonged observations because it gave a larger field than Selligue's.

The mechanism of this microscope was similar to the English model of Jones, shown at fig. 112. The focussing was by rack and pinion acting on the stage, the pinion travelling with the stage on the rack. Two draw tubes, A and B, were applied within the

body tube, C, the upper one having a biconcave lens, S, at the

¹ *Des Microscopes*, Paris, 1839, p. 86.

lower end, serving as an amplifier, which was probably the first application of a 'Barlow lens' to a microscope.

Illumination for opaque objects was accomplished by a lenticular prism, P, which was gimballed, and connected with a ring embracing the body tube.

We learn from Fresnel that the range of magnification was from 40 to 1,200 diameters. The object-glasses were composed either of two doublet systems for low-power work or of four doublet systems all screwed together for high-power work, and two oculars were provided of different power.

It is interesting to place one of the earliest known English models of the achromatic microscope beside that of Selligue. It was made by Tully the optician, of London, who at Dr. Goring's instance had been working at the achromatizing of the microscope. Selligue's is a manifest modification of one of the best forms as made by Adams, Jones, or Dollond. Tully made the microscope figured in 116 from the working drawings supplied by Mr. J. J. Lister, who saw that great accuracy of workmanship and complete steadiness in the stand were needful for achromatic microscopes, and to this end they adopted struts, such as

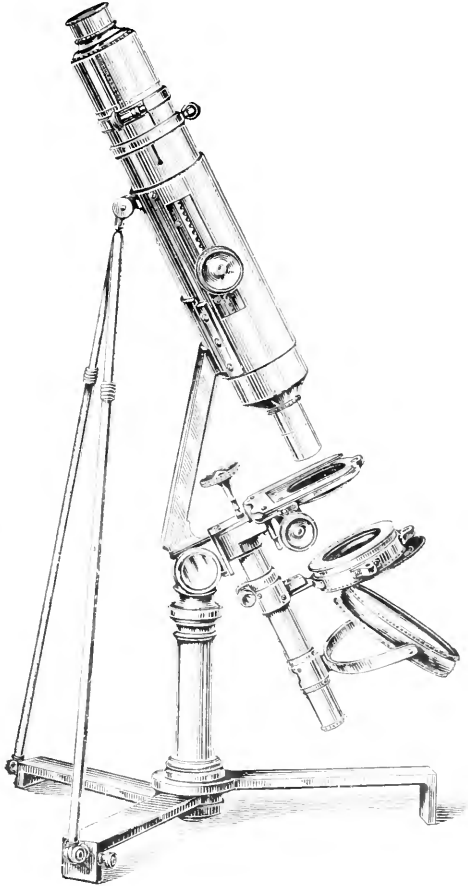

Fig. 116.—Lister's achromatic microscope made by Tully (1826).

were used in telescopes, connecting the body-tube with the base. The instrument is shown in fig. 116. He also provided mechanical movements to the stage, but no fine adjustment was applied. There was a sub-stage provided with a rotating disc of graduated diaphragms. This microscope was made in the year 1826 by Tully, but it was made from working drawings supplied by Mr. J. J. Lister, who therefore is responsible for the entire design. The sub-stage held a combination of lenses for a condenser.

As compared with single lenses of equal power, from which so

much light was inevitably stopped out by the small diaphragm that it was needful to use in order to secure a fair image, the objectives used with this instrument gave a vast increase of light by permitting the employment of the full aperture.

An extremely interesting instrument by C. Chevalier, made very probably not long after 1824, and bearing much resemblance to that of Selligie, is shown in fig. 117. It is provided with a revolving disc of diaphragms applied below the dark chamber under the stage, and this is a plan which obtained a permanent place in the microscopes of the future.

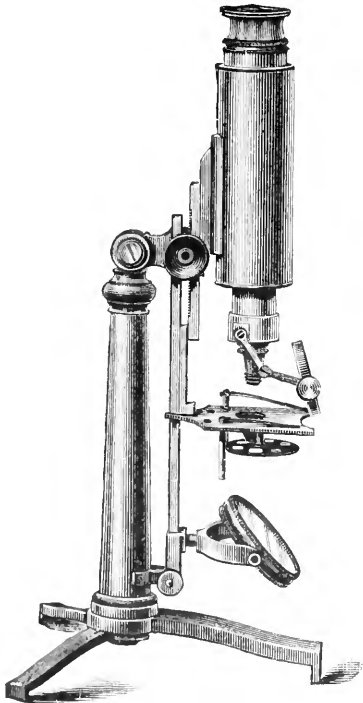

FIG. 117.—C. Chevalier's achromatic microscope (circa 1824).

The report of Fresnel concerning Selligie's achromatic microscope determined Professor Amici, who for nine years had abandoned his experiments on achromatic object-glasses, to recommence them in 1826, and in 1827 he exhibited in Paris and in London a horizontal microscope. The real novelty shown in it was the application of a right-angled prism immediately above the objective to deflect the rays through the horizontal body-tube. The object-glasses were composed of three lenses superposed, each having a focus of three lines and a greatly increased aperture. It had also extra eye-pieces by means of which the amplification could be increased.

Meantime the subject of achromatism was engaging the attention of the most distinguished English mathematicians. Sir John Herschel, Sir George (then Professor) Airy, Professor Barlow, Mr. Coddington, and several others, worked more or less at the general subject. Coddington alone, however, confined his attention to the microscope, and his work was limited to the eye-piece. Also, for some years, Joseph J. Lister had been earnestly working experimentally and mathematically on the same subject, and he discovered certain properties in an achromatic combination, which were of importance, although they had not been before observed.¹ In 1829 a paper from Lister was received and published by the Royal Society,² and putting the principles it laid down into practice, Lister was enabled to obtain a combination of lenses capable of transmitting a

¹ *Phil. Objectives*, ch. v, p. 355.

² *Trans. Roy. Soc.* for 1829.

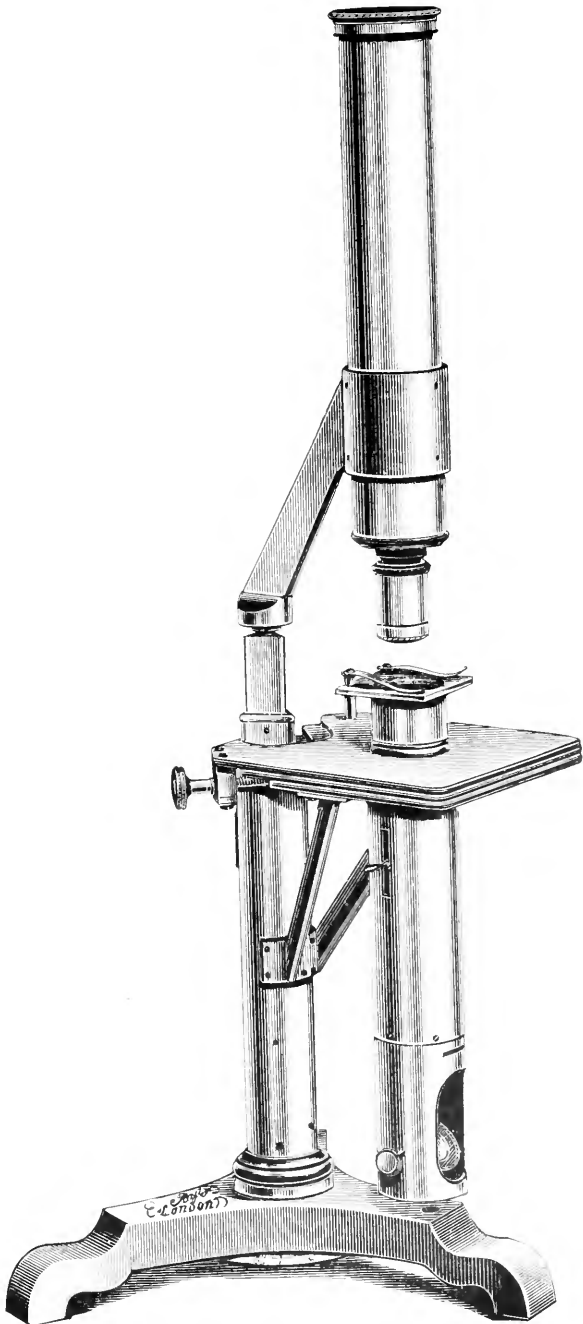

FIG. 118.—One of Ross's early microscopes designed by W. Valentine (1831)

pencil of 50° with a large corrected field. This paper and its results exerted a very powerful influence on the immediate improve-

ment of English achromatic object-glasses, and formed a permanent basis of advancement for the microscope, not only in its optical, but also indirectly in its mechanical construction and refinements.

For convenience, at this point we may advance a little in order to complete our brief outline of the mechanical application of achromatism to object-glasses. Mr. A. Ross became practically acquainted with the principles of achromatism as applied to combinations of lenses in working with Professor Barlow on this subject, and having applied Lister's principles with great success, he discovered, as we have already pointed out in Ch. I.,¹ that by covering the object under examination by a thin film of glass or tale the corrections were disturbed if they had been adapted to an uncovered object; and we have seen that it was in 1837 that Ross devised a simple means of correcting this. He was an indefatigable worker in the interests of the advancement of the mechanical as well as the optical side of the microscope. Fig. 118 presents a form of

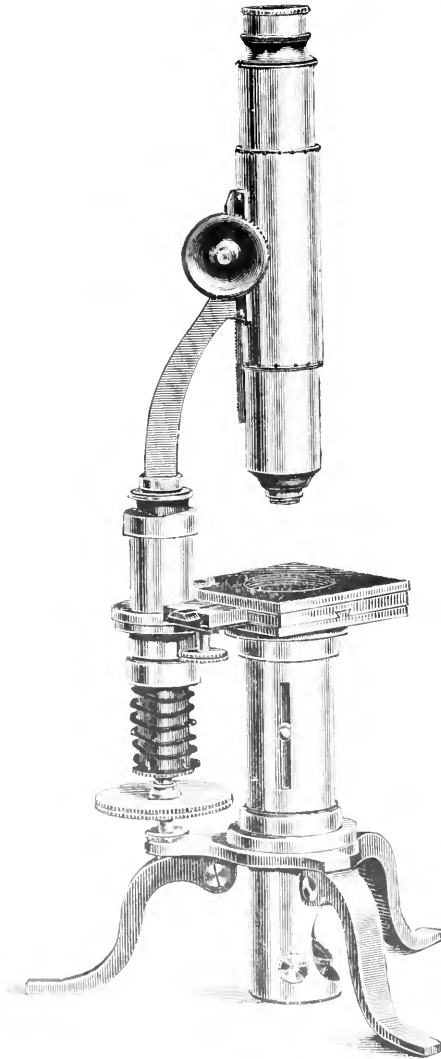

FIG. 119. Pritchard's microscope with 'Continental' fine adjustment (1835).

microscope, from an extant example which was designed by W. Valentine of Nottingham in March 1831 and made by Andrew Ross.

The stage is actuated in diagonal directions on either side of the stem. A Pritchard microscope probably made by Ross is shown in fig. 119. It is not at all like fig. 118. The stage movement is by rack and pinion and not by screw as in fig. 118, but it will be seen that it has also a curious spiral fine adjustment, which is plainly an uncovered 'Continental' form, either adopted in England from G. Oberhäuser, or it may have even preceded it. It is interesting to note, however, that the sub-stage arrangements are the same as those employed by Wollaston in connection with his celebrated doublets, an account of which was given in the *Philosophical Transactions* of that date.¹

The Ross form cannot be inclined, nor can the Pritchard; and 'the fine adjustment in the former is effected by means of a long screw passing up the pillar and acting on a triangular sheath, within which the stem is applied, to move with rack and pinion, the top of the stem being hollow to receive either the cross-arm support for the single lens or the limb of the compound body. The screw is actuated by a large, graduated, milled head below the tripod.'

The stage has supports evidently to enable dissection to be effected without flexure by the weight or pressure of the hands, which makes it clear that it is the Valentine microscope that is referred to, as may be seen by reference to fig. 118. Rectangular mechanical movements are employed acting diagonally on either side of the stem by rather fine screws, so that the motions are slow.

But A. Ross at an early period worked out a 'Lister' form of microscope, with the limb supporting the body-tube. He applied a fine adjustment in this to act upon the nose-piece only, which, as we shall subsequently see, is a very inferior method. This instrument dates from 1839, and is shown in fig. 120. In 1842 he

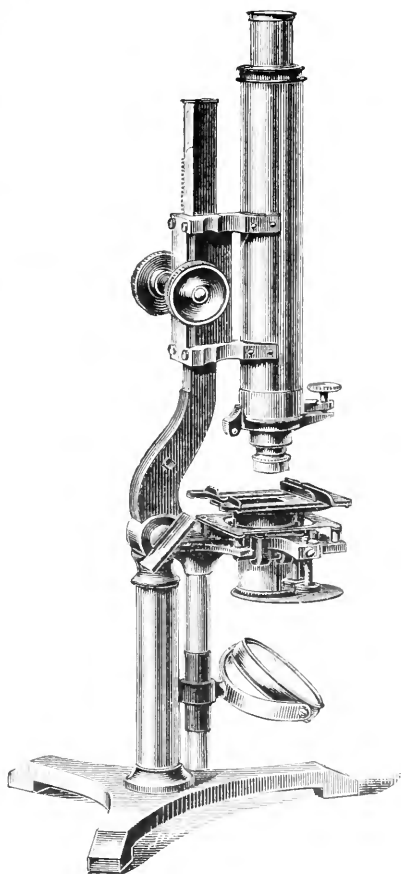

FIG. 120.—A Ross microscope (1839).

¹ *Trans. Roy. Soc.* 1829.

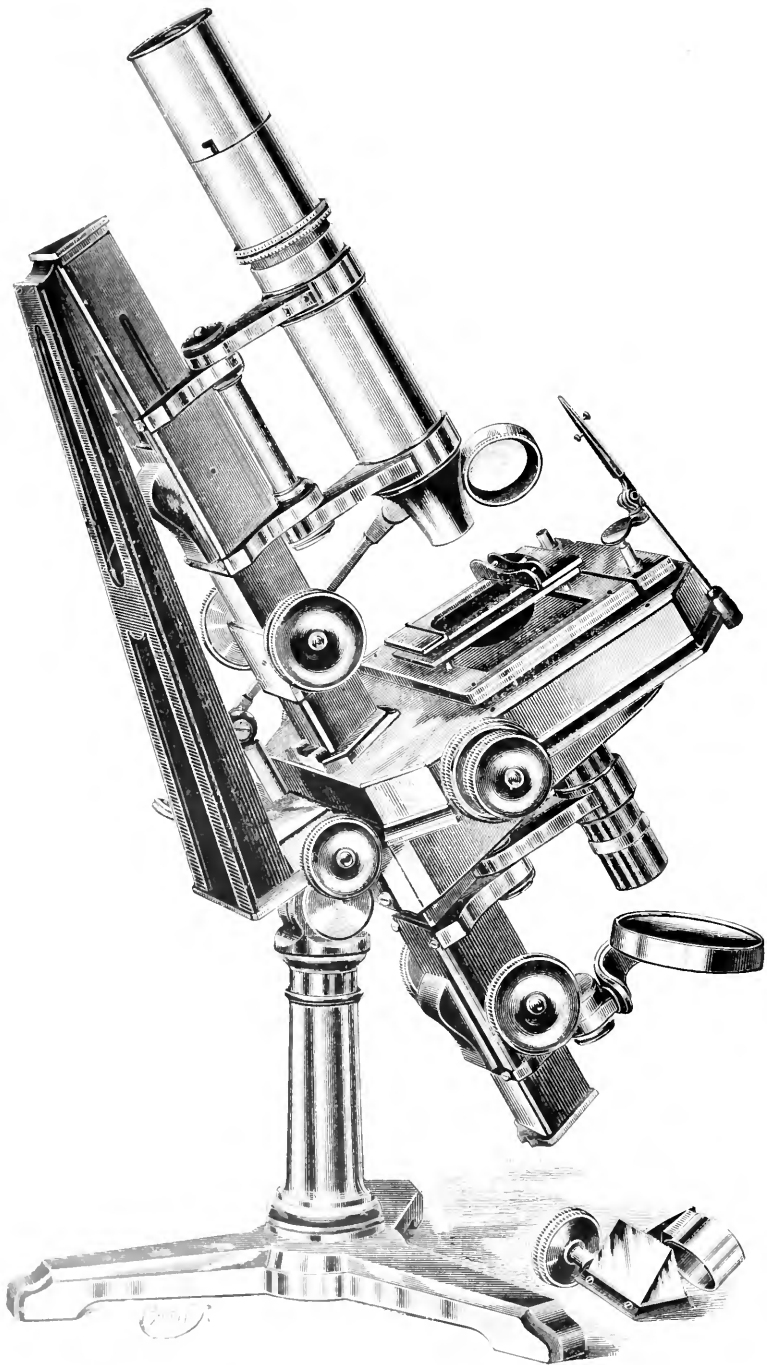

Fig. 121. —H. Powell's microscope, purchased by R.M. Society in 1841.

changed the form to that shown in fig. 123, p. 158. Ross tried various modifications of this fine adjustment and model, but from about 1843 he worked only at the lever method as applied to the nose-piece through the 'cross arm' and brought it to a relatively high state of perfection. But the full possibilities of this method, as concerned its sensitiveness, were never utilised by Ross, and it was Hugh Powell who first published an account of his long lever fine adjustment in the 'London Physiological Journal,' November 1843. The published account of Ross's long lever fine adjustment did not appear until a month later, viz. December 1843.

In 1835 Powell made a microscope with an extremely delicate fine adjustment applied to the stage. The mechanism and the workmanship were excellent (we give a drawing of a later form of the instrument at fig. 121), and this fine adjustment is one of the slowest and steadiest as yet made. In one we have measured the movement only amounts to $\frac{1}{670}$ of an inch for one revolution of the milled head; this is six times slower than the fine adjustment applied to the best Continental microscopes. The disadvantage of this fine adjustment is that it slightly disturbs the focus of the sub-stage condenser; therefore, if the fine adjustment is much moved, the sub-stage condenser will require refocussing. The movement usually required is so slight that the refocussing of the condenser is seldom required.

James Smith also made an instrument on an entirely new plan. It is illustrated in fig. 122, being the first model made by this firm in this form, and it has many features of interest from the point of view of our present requirements. But after we have once secured steadiness, the crucial points in a microscope are the quality of the fine adjustment, and the delicacy, firmness, and ease with which we can centre, focus, and otherwise modify the sub-stage illumination. To the former certainly this model does not contribute.

We are now prepared to examine and endeavour to judge impartially from a practical point of view the merits of the principal English, Continental, and American models which are offered to the microscopical public. It is impossible, no less than it is undesirable, to attempt to describe all the microscopes of every maker, or even the principal forms made by the increasing multitude of opticians. We have sought no opticians' aid; we have carefully examined all the forms that lay any just claim to presenting an instrument which meets the full requirements of modern microscopy; and, although we have reason to know that the judgments we express are shared by the leading experts of this country, we take the sole responsibility for these judgments. Having sought for twenty years the best that could be produced in microscopes and objectives our judgment is given with deliberation and wholly in the interests of science.

In examining the principal modern microscopes we shall point out whatever is of absolute importance or relative value; and the absence or presence of this in any form provisionally selected is all that the reader will need to enable him to become convinced of our

estimate of the value of such an instrument, whether the form be illustrated in these pages or found in the catalogues of the makers.

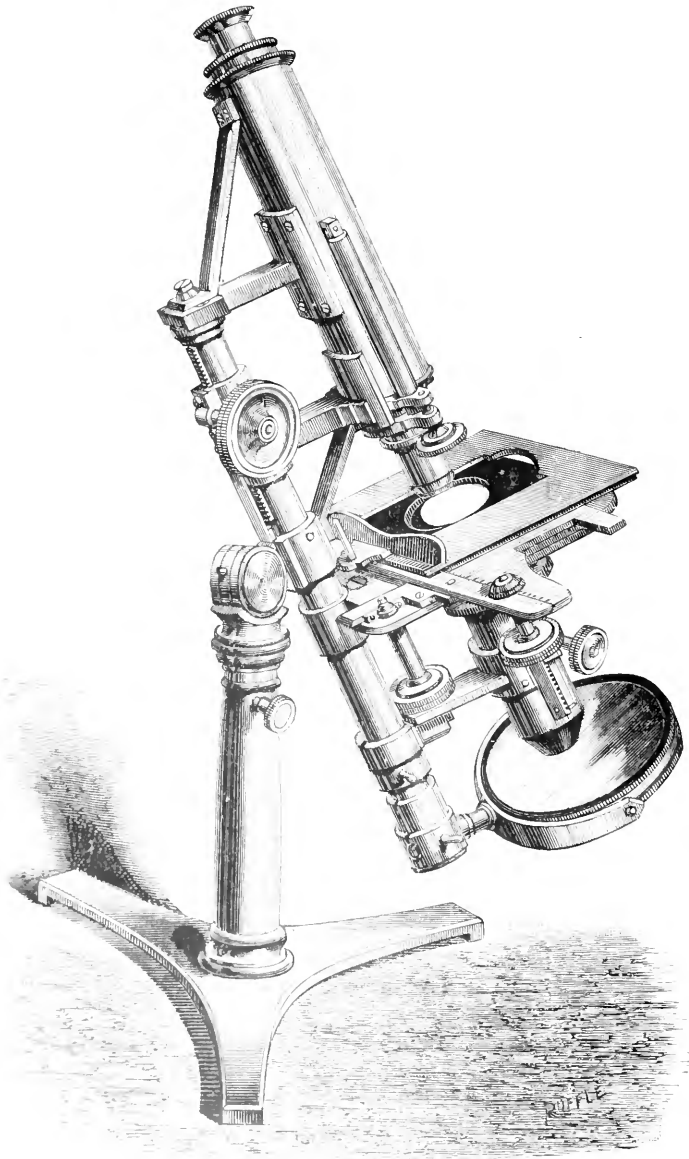

FIG. 122. James Smith's Microscope (1839).

With this object before us we shall facilitate its attainment by at once considering what are the *essentials* of a good microscope. What are the attributes of the instrument without the possession of which it cannot meet modern requirements?

I. **Steadiness** is absolutely indispensable: this would, in fact, appear to be obvious. But we are bound to admit that it is, in what sometimes claim to be stands of the first class, disregarded; and when the height of the centre of gravity in the English and American stands of the first class is considered, this is a fatal mistake.

It is pointed out in the section on micrometry¹ and drawing that the optic axis of the microscope should be ten inches from the table; therefore a first-class microscope whose optic axis when placed horizontally is either more or less than this is found wanting in a material point. But to possess this characteristic it must have a high centre of gravity.

Now it is possible to secure steadiness by (1) weight or (2) design. The Continental method has invariably been weight. The pillar of the instrument is fixed to a cumbrous metal foot of horse-shoe form, which bears so high a ratio to the whole remainder of the instrument that it is usually steady. This secures the end certainly, but by coarse and unwieldy means. It promises little for the instrument as a whole.

What is wanted is the maximum of steadiness with the minimum of weight. An old plan designed by Cuff, *circa* 1765, of rotating the foot below the pillar has been frequently reinvented. It was used by Adams 1771, by Ross 1842, by Sidle and Poalk in America 1880, by A. McLaren 1884, and recently again by Ross. This is a very simple method of obtaining great stability for the instrument when in either the vertical or horizontal positions. An instance of this form, made by Andrew Ross in 1842, is given in fig. 123: the foot is seen to be circular, with a vertical pillar attached eccentrically to it, and the base rotates, securing stability in either a vertical or inclined position.

Palpably, the mechanical compensation for the difficulty of an elevated centre of gravity is an *extended base*. The leading fault of many stands claiming the first rank is their narrowed bases. A broad base, resting on three points only, and these plugged with cork, is the ideal for a perfect instrument.

II. Next in order to the *stand* of the microscope comes what is known as **the body** of the instrument—the tube or tubes for receiving the objective at one end and the eye-pieces at the other. The tube of the monocular is always provided with an inner tube called the *draw-tube*. In a first-class instrument this latter should always be provided with a rack-and-pinion motion, and should have a scale of from two to three inches, divided into tenths or millimetres. This enables the operator the more accurately to adjust apochromatic objectives so sensitive, for their best action, to accurate adjustment of tube-length. In fact, it is always important to remember that objectives are corrected for a special tube-length; that is to say, for the formation of the image at a certain definite distance.

¹ Chapter IV.

There are, however, two kinds of tube-length: (1) an optical and (2) a mechanical.

The optical tube-length is measured from the posterior principal point of the objective to the anterior principal point of the eye-piece.

The mechanical tube-length should be measured from the top of the tube into which the eye-piece fits, and upon which the bearings

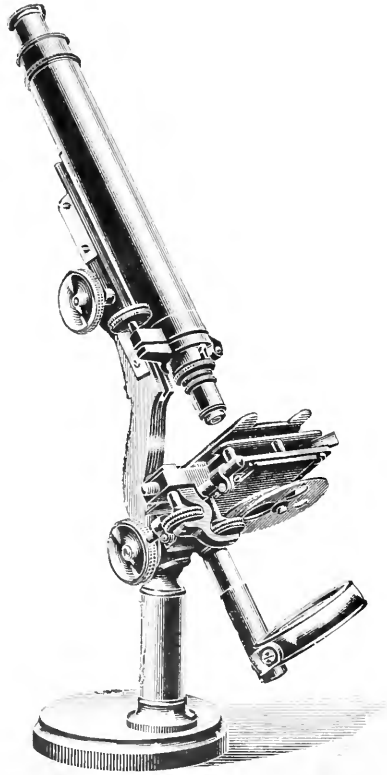

FIG. 123. — Old Ross stand (1842), rotating foot below the pillar. From the cabinet of the Royal Microscopical Society.

of the eye piece rest to the end of the nose-piece into which the objective is screwed.

Unfortunately different makers estimate tube-length differently and take different points from which to make their measurements. Looking at the matter broadly, there are two estimates for tube-length in practical use: these are the English and the Continental.

What was formerly known as the English standard tube had an optical length for high and moderate power objectives of *ten inches*; with low powers, however, it was less. The mechanical tube-length was $8\frac{3}{4}$ inches.

Professor Abbe, in constructing his apochromatic objectives for the English body, has taken the mechanical tube-length at 9.8 inches = 250 mm.; and the optical tube-length at 10.6 inches = 270 mm. This has caused an increase in the length of the English standard tube, since all good microscopes are made to work with these objectives; and *the addition of a rack and pinion to the 'draw-tube'* becomes of great practical value.

The tube-length of the *Continental mechanical tube* is 6.3 inches = 160 mm., and the *optical tube-length* is 7.08 inches = 180 mm., and some Continental objectives can only be accurately adjusted on an absurdly short tube of $4\frac{3}{4}$ or 5 inches.

The question has been asked, 'Which is the better of these two differing tube-lengths?' So far as the image in the instrument is concerned, there is not much difference. It is of little importance whether the initial magnifying power of an objective be increased by a slightly lower eye-piece used at a longer distance or a slightly deeper (higher) eye-piece at a shorter distance. But it is of practical importance to note that *a small difference of tube-length produces a greater effect on adjustment with a short body than with a long one.* Critical work is carried on in this country to $2\frac{1}{2}$ mm. adjustment on the long tube; with a short tube the delicacy would be greater. A difference of 5 mm. on a short tube is equivalent to the difference between a good and a bad objective. When small cones of illumination are used lenses are far less sensitive, but, on the other hand, they are not doing their work. Biologists in a vast majority of cases use a high power insufficiently worked; thus a $\frac{1}{2}$ -inch objective with a small cone is used in place of a 1-inch objective, and an oil immersion $\frac{1}{2}$ -inch objective with small cone is used to do what a $\frac{1}{4}$ -inch would have done. The oil $\frac{1}{2}$ -inch objective is never fully utilised, and the objects that it will show if properly used are never seen. The principal difference, however, between the long and the short body as affording a datum for their respective values is that when a short body is used by a person having *normal accommodation of sight*, the stage of the microscope cannot be seen unless the head is removed from the eye-piece, whereas with the long body the eye need not be taken from the eye-piece at all, as the stage can be seen with the unused eye. We are informed by a highly competent German optician that short sight is the most common form of vision amongst German microscopists. This, of course, for Germans so far alters the case, but it does not apply in this country. The diameter of the body tube is also a matter of importance, because when a microscope is used for photomicrography it is essential that it should have a body with a large diameter.

III. Arrangements for focussing stand next in order of importance. Every microscope of the first class is provided with two arrangements for focussing, one a *coarse adjustment*, acting rapidly, and the other a *fine adjustment*, which should act with great delicacy

and precision. A good 'coarse adjustment' or primary movable part of the instrument is of great importance. The first requisite is that the body or movable part should move easily, smoothly, but without 'shake' in the groove or slot or whatever else it slides in. We have found in practice that a bar shaped like a truncated prism sliding in a suitable groove acts best and longest. But a bar planed true and placed in a groove ploughed to suit it is not enough. The inevitable friction determines wear, and this brings with it a fatal

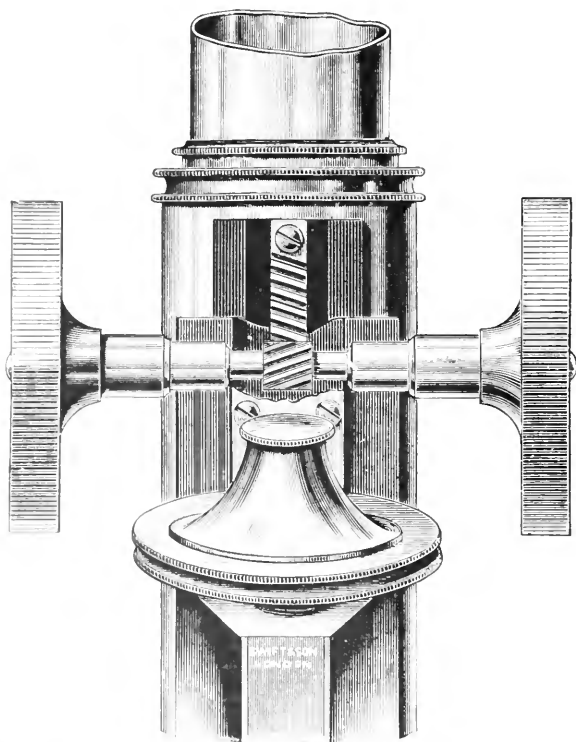

FIG. 121. Diagonal rack and twisted pinion devised in 1881.

'shake.' All such grooves, which are usually V-shaped, *should be cut and sprung on one side*, so that by 'tightening up' the V's by means of screws the bar or limb is again firmly gripped. Further, the bars should not 'bear' for its whole length along the groove, but only on points at either end and in the middle. Powell introduced these prime essentials to a good 'coarse adjustment' more than 60 years ago (1825-60) when thousands of instruments in which these principles have not been applied have been, by sheer friction wear, soon changed into useless brass since then! But instruments made by

this firm are as good after thirty years' use as they were when new.

Frequently bad workmanship is concealed by the free employment of what is known as 'optician's grease' and an over-tightening of the pinion, driving its teeth into the rack, which, of course, speedily ends in disaster.

If we desire to practically test this part of a microscope, we must remove the pinion, take out the bar, clean off the 'optician's grease' with petroleum from both bar and groove, oil with watch-maker's oil, and replace the bar in the groove, and before refixing the pinion see if it slides smoothly and without lateral shake.

What has been said about the 'springing' of the bar in this special instance applies equally to all moving parts, in stage and sub-stage movements, and wherever constant friction is incurred: equally applicable, too, is the lubricant we suggest.

An instrument left unused in its native 'grease' for twelve months becomes so immobile in most of its parts by the hardening of its 'normal' lubricant that motion becomes a peril to its future if persisted in in that condition.

If a 'coarse adjustment' be what it should be, all lower powers should be exclusively and perfectly focussed by it, and with the highest powers objects should be found and focussed up to the point of clear visibility.

The exceedingly useful method of 'diagonal rack and twisted pinion' was introduced by Messrs. Swift and Son about 1880 and has since been universally adopted. Its mode of operation is seen in fig. 124, a sectional drawing of this part of one of Swift's microscopes. The advantages gained by this method are due to the twist in the pinion being a shade steeper than the diagonal of the rack, by which expedient there is more gearing contact between rack and pinion, which prevents 'loss of time' and obviates the necessity for unduly forcing the teeth of this pinion into those of the rack.

Mr. Nelson has had made by Messrs. Watson and Sons a still better form of rackwork. It is what is called a 'stepped' rack (not of the diagonal, but of the straight type). In this very admirable form two parallel racks engage in the same pinion: one rack, however, is placed so that its teeth are stepped an amount equal to the 'back-lash' behind those of the other, e.g. $\frac{1}{11}$ of the pitch.

These racks have to be cut together and fixed in the position they were cut: the object of this plan is that one of the racks shall be in action when the bar is racked up, and the other when it is

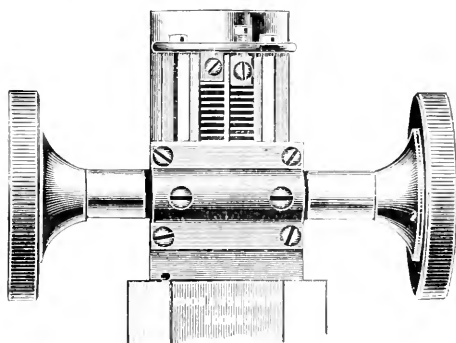

FIG. 124A.—Nelson's 'stepped' rack, invented in 1899.

racked down; so that if the racks are properly placed relatively to one another 'loss of time' is impossible; and the result is obtained without forcing the teeth of the pinion into the rack. If the teeth are true, the friction is of the least, and the smoothness and firmness all that can be desired. But what gives great value to this form of rack is that any loss of time as the result of wear can be taken up by a slight alteration of the position of the second rack. The arrangement is shown in fig. 124 A, and it will be seen that at the top of the right-hand rack as we look at the illustration there is a small screw. Now the racks are set side by side, one being fixed finally. The pinion is then made to work freely and smoothly with this one rack: the second rack is then introduced, and is provided with slots and clamping screws, and its position is gradually altered in the right-hand rack until the smoothest position of action is secured. The clamping screws are then tightened and the rackwork becomes fixed; and subsequent irregularity in it is at once corrected by the small screw to which we have referred.

When the best position is found the teeth of the two racks, as we have stated, will not be in a line, but those of the loose rack will be found to occupy a position slightly below the teeth of the fixed one.

There is a defect in either microscope or microscopist if the 'fine adjustment' is resorted to before the object is focussed into clear view, even with the highest powers.

The Fine Adjustment.—This part of the modern microscope possesses an importance not easily exaggerated, and deficiency or bad principle in the construction of this makes not only inferior, but for critical purposes absolutely useless, what are otherwise instruments of excellent workmanship and real value.

There are two kinds of fine adjustment usually employed:—

- i. Those which *simply move the nose-piece* which receives the objective.
- ii. Those which *move the whole body*, or the whole body including the coarse adjustment.

All constructions of the second class formerly proved impracticable, and even pernicious. They inevitably broke down just as the purchaser, by practice, began to realise the value of perfect action. With a large experience of stands of every class, we are obliged to say that generally with one or two years of *work* they lost whatever value they at first possessed.

To this broad statement there are possibly two or three exceptions, viz. Swift's side lever and Campbell's differential¹ screw and Watson's long lever, to which we shall subsequently refer.

It is, however, upon the model above referred to, with all its radical and glaring imperfections, that the majority of Continental microscopes have been built.

A screw with an extremely fine thread, and therefore of extremely fine division—a micrometer screw in fact—*has to bear the strain of*

¹ The differential screw fine adjustment was first suggested by Dr. Goring in 1790. It was first actually made by Nobert about 1865.

lifting and lowering the entire weight of the body, with its coarse adjustment, lenses, and so forth; while the *sole object* of the adjustment should be to give a delicate, almost imperceptible, motion to the *object-glass alone*. It needs no great experience to foresee the inevitable result; the screw loses its power to act, and something incomparably worse than a tolerable coarse adjustment is left in its place.

Yet it is the Continental model that has become the darling of English laboratories, and that still receives the appreciation of professors and their students. True they answer in the main the purposes sought — the exigencies of a limited course of practical instruction. But how many of those who receive it are the medical men of the future, and to whom a microscope—not of necessity a costly one—of the right construction would be of increasing value through a lifetime?

Almost any instrument, however inferior, could be employed successfully with a $\frac{1}{4}$ -inch objective of 'low angle' (to give it what has been called 'the needful penetration' for histological subjects!) to

obtain an image corresponding to a figure in a text-book of, say, a Malpighian corpuscle, or a section of kidney, brain, or spinal cord. The quality of a fine adjustment is never tested by these means, for, in point of fact, a delicate fine adjustment is not even necessary. We write in the interests of microscopical research. It certainly may be taken for granted that the end sought is not simply to use the microscope to verify the illustrations of a text-book, a treatise, or a course of lectures; without doubt it is a subsidiary purpose; but the larger aim is to inspire in the young student confidence, enthusiasm, and anticipation in the methods and promise of histology and all that it touches. But for this there must be *potentiality* (with-

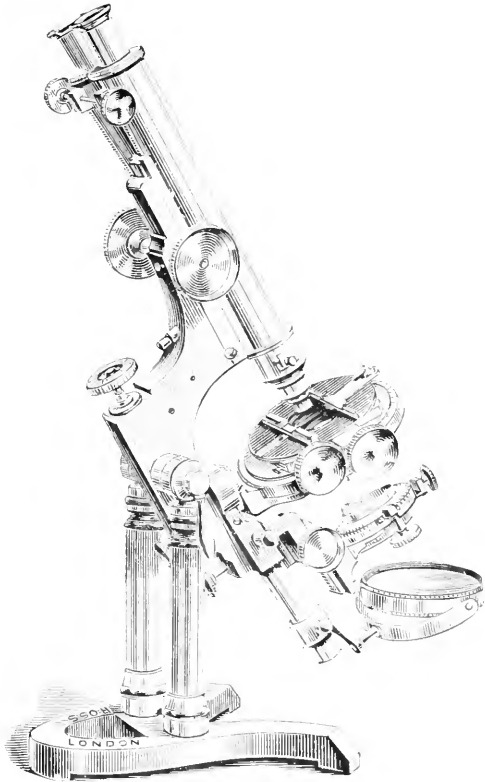

FIG. 125.—Ross-Zentmayer model 1878.

out costliness) in the mechanical and optical character of the microscopes commended and approved.

A low-priced student's microscope of good workmanship and perfect design could easily be devised if the demand for it arose. Indeed, quite recently a certain class of students' microscopes have been improved greatly: this has been a concomitant of the science of bacteriology, which has compelled the use of the sub-stage condenser. We have said enough of the value of this instrument in a succeeding chapter, but until recent years histologists did not use it because it was not used in Germany or with German instruments! Its present use, nevertheless, has had the effect of improving the definition obtained by the objectives used by students generally. Some who perceive this, endeavour to attribute it to the improvement effected in modern objectives, but this is not the case; the objectives in many cases are not even new, and until the introduction of the Jena glass¹ the ordinary students' objectives were not really so good as the English objectives of forty-five years ago. But it could easily be shown that one of these early objectives, used as it always was with a *condenser*, would surpass in the sharpness of its definition the majority of those now supplied to 'students' with Continental models.

But it must not be supposed that it is *only* the Continental model that is deformed by the adoption of this radical error in the 'fine adjustment' with which we are dealing. Even during the last twenty years it has been applied to some of the most imposing and expensive instruments made in England and America on what is known as the 'Lister' model. This model has one supreme virtue, in the possession of a solid limb. This may take many distinct forms, but it is sufficiently represented in fig. 125, where it will be seen that the 'limb,' which is swung between the pillars, and which carries the body-tubes and the fine adjustment, is in one solid piece. If nothing were sacrificed this would be a boon. Formerly, this model was supplied with a fine adjustment which only moved the nose-piece, but on a principle which we shall see was wrong, and from its imperfections it was abandoned, and the solid Lister arm was *cut*, and the whole body and its coarse adjustment was pivoted on the lever of the fine adjustment. Thus its normal virtue (a *solid* limb) was sacrificed, and a 'fine adjustment,' doomed to failure, was given to it.

A complex roller, a wedge, and a differential screw have in turn been since employed to redeem this instrument from the failure that had overtaken it. Partially, or completely, each has failed. The differential screw certainly comes theoretically nearest to success with this form of instrument. But at the outset this is the case only where it wholly abandons the lifting and lowering of the body-tube &c. by the action of a 'fine adjustment,' and its motion is only brought into operation upon the equivalent of a nose-piece.

*The form of differential screw brought into practical operation by the Rev. J. Campbell, of Fetlar, Shetland, was adopted by Swift and Son in 1891, but had been exhibited in a stand made by Baker in the year 1886 at the Quekett Micro. Club.*² Its object is to sup-

¹ *Ibid.* Chapter I.

² *Journal Q.M.C.*, ser. 2, vol. ii, pp. 283 and 287 (1886).

plant the direct-action screw, where the form of the microscope may appear to make that a necessity. This has been the case with the Continental model. It was applied by its inventor to a microscope made by himself, and was brought before the Quekett Club by Mr. E. M. Nelson.

It is very simple, and is made by cutting two threads in the micrometer screw. Fig. 126 will illustrate the exact method. D is the milled head of the direct-acting screw. The upper part, S, of the screw has (say) twenty threads to the inch, and the lower part, T, twenty-five threads to the inch. B is the fixed socket forming part of the limb of the microscope, and H is the travelling socket connected with the support of the body-tube. The revolution of D causes the screw thread S to move up and down in B at the rate of

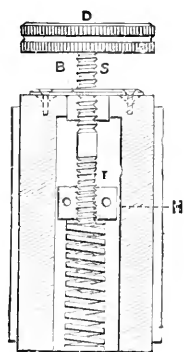

FIG. 126.—Campbell's differential screw fine adjustment (1886).

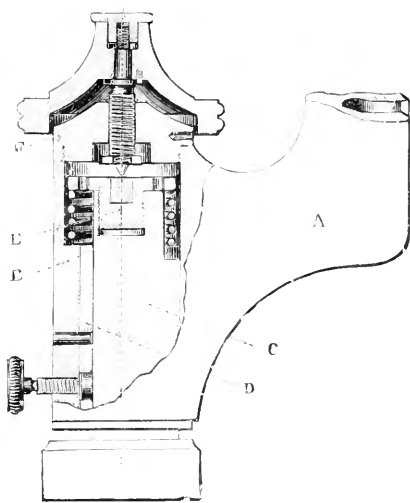

FIG. 127.—Zeiss's usual 'new' fine adjustment (1886)

twenty turns to the inch, whilst the screw thread T causes the travelling socket H to move in the reverse direction at the rate of twenty-five turns to the inch. The combined effect, therefore, of turning D twenty revolutions is to raise or lower T, and with it the body-tube $\frac{1}{3}$ th of an inch, or $\frac{1}{100}$ th of an inch for each revolution. The spiral spring below H keeps the bearings in close contact.

Of course any desired speed can be attained by proper combination of the threads: thus 32 and 30 would give $\frac{1}{480}$ th of an inch for each revolution, and 31 and 30 would give $\frac{1}{900}$ th of an inch.

This screw has provided for the Continental model what Swift's vertical lever has done for the Jackson model; Mr. Baker, of Holborn, has adopted it and with very satisfactory results; for it has passed through that most crucial of tests for a fine adjustment, its employment in photo-micrography, with excellent results; and

we hope that it may become the general fine adjustment for this form of microscope in place of the old form of direct-acting screw.

In contrast and comparison with Campbell's differential screw we may put the principle on which the usual simplified construction of the fine adjustment of the Zeiss stands rests.¹ In fig. 127 the triangular bar C is screwed firmly to the stage; on it moves a hollow piece B, which is connected inseparably with the arm A carrying the tube. At its upper end C is cut away for about 15 mm. and B hollowed out at a corresponding place so that space is obtained for a spiral spring. This spring bears below against the hollowed-out part of B, its upper end being connected with the projections of the piece E screwed into C. The piece B is closed above by the cap F, in which is the female screw. On the top of the micrometer screw is fitted a bell-shaped head, and at its lower end is a small nut for preventing over-screwing. The lower end of the screw is rounded off and bears against the flat surface of a hard steel cylinder let into E.

Clearly, when worked, the screw remains in the same place, bearing against C. The female screw, on the other hand, moves over it, raising and lowering the tube carrier B A connected with it. By its own weight A B counteracts the rise and thus supplies the place of the strong spiral spring formerly employed. The weak spring here adopted acts in the same direction as the weight of A B, and serves to assist the latter when the upper part of the microscope is placed horizontally.

Our appreciation of all that is done by the great firm of Zeiss we need not reiterate; it is well known; but our opinion of the form of stand adopted by these opticians we freely expressed, and we believe justified in the last edition of this book; but it is well to get the opinion of one who with practical knowledge would certainly not be prejudiced against the Continental stand. Dr. H. E. Hildebrand says² that in teaching establishments, where as many as two hundred microscopes may be used, the weak points of the Continental stand are soon brought to light. The fine adjustment screw soon becomes unsteady (an inevitable consequence of the weight so fine a screw has to carry), the prism suffers bending or rotation, the prism flange or the hinge-block under the object stage loosens its connection with the stage plate, &c. &c., all of which and much more, as we believe, is the result of the adaptation of a simple and primitive form to complex appliances for which it was never designed or intended.

It is, however, an admirable characteristic of the firm of Zeiss, that while they adhere doggedly to the old Continental model, they are continuously putting forth their ingenuity and skill to counteract what are shown to be its defects. In their best usual form the speed of the fine adjustment is $\frac{1}{100}$ inch for each revolution of the milled head. This is undoubtedly too rapid, but it could scarcely be made a finer screw, because, as we have seen, it had the coarse adjustment and tube to lift, and the wear and tear on so fine an adjustment on constant use led to rapid failure. But the firm has

¹ *Zeiss Catalogue*, introduced in 1886, and was a great improvement on its predecessor, which was mechanically bad. *Trans. R.M.S.J.*, 1886, p. 1051.

² *Ibid.*, 87 (1895) pp. 145-54.

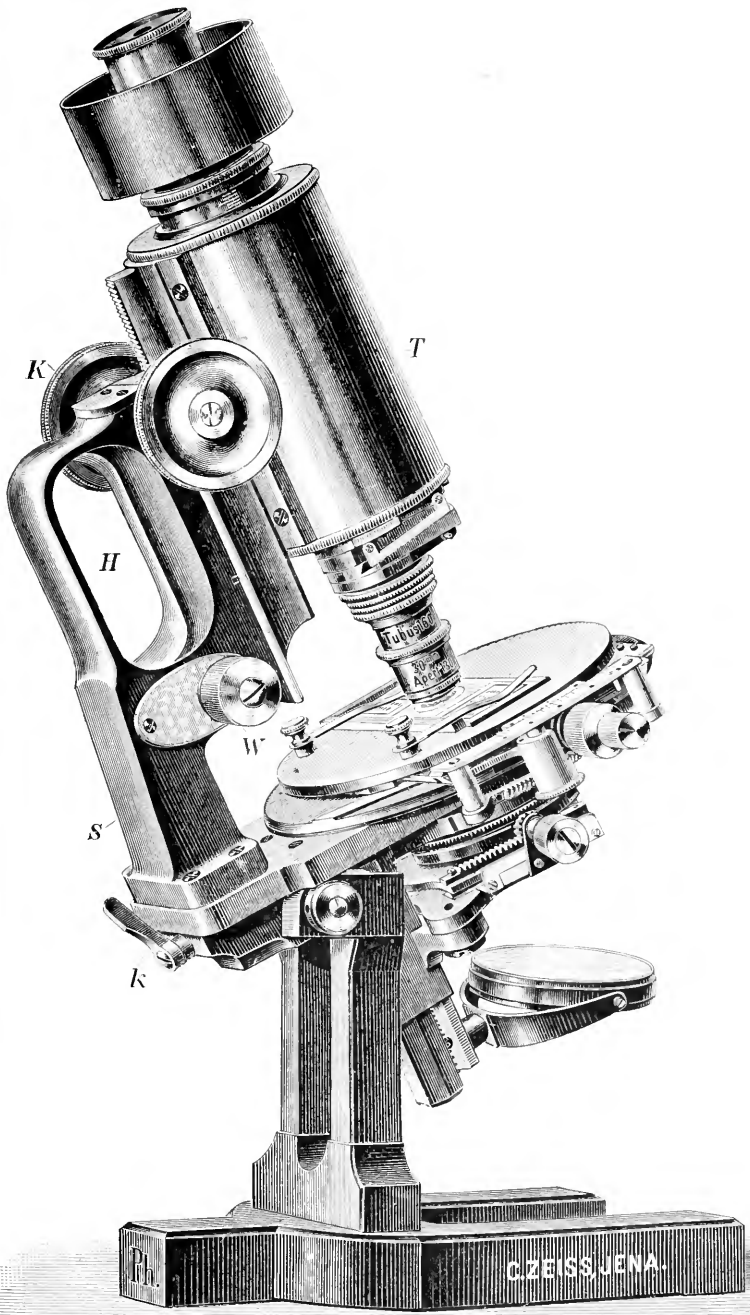

FIG. 128 (1898).

X.A. M. Hunger, Jena.

introduced a very complex but very remarkable modification of their fine adjustment which is intended to obviate both the above defects. It is a model ostensibly constructed for photo-micrographic purposes, but if successful will speedily be applied to all their stands. The entire microscope is shown in fig. 128, while a vertical section of the fine adjustment is presented in fig. 129, and a ground plan of the same in fig. 130. A point which seems to be considered of importance to some German microscopists is the provision of a handle by means of which the instrument may be readily moved, and with the provision of this the usual large milled head controlling the fine adjustment has been displaced. This is shown at H in fig.

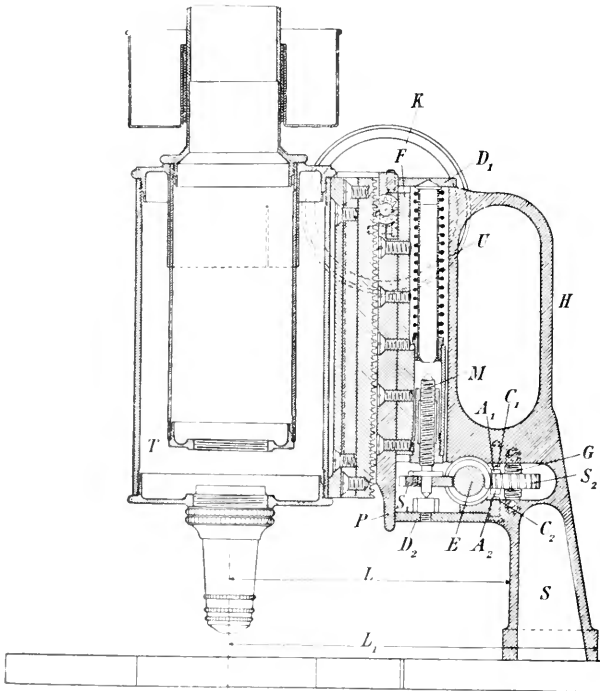

FIG. 129 (1898).

128. But with the accomplishment of this there was a great desire to bring about what we have so often endeavoured to show was an indispensable necessity in the beautiful productions of Jena, viz. that the fine adjustment should not have the burden of carrying the coarse adjustment and the tube. They have not succeeded in doing this; the weight of the coarse adjustment and tube is still on the fine micrometer screw. They have diminished the weight that the fine adjustment has to support by making the body and draw tube of aluminium. The fine adjustment is placed close behind the coarse one, both being fastened quite independently, so that in

fact the object holder can be made to receive, and the optical apparatus arranged to examine, preparations of almost any required size.

To accomplish this H (fig. 128) is made hollow, and in place of the usual triangular 'conductor' of the fine adjustment, a swallow-tail-shaped slide F (figs. 129, 130) is placed, the upper part of which is hollowed out to receive the spiral spring U (fig. 129). The lower part of this is also hollowed and conceals the long box which receives

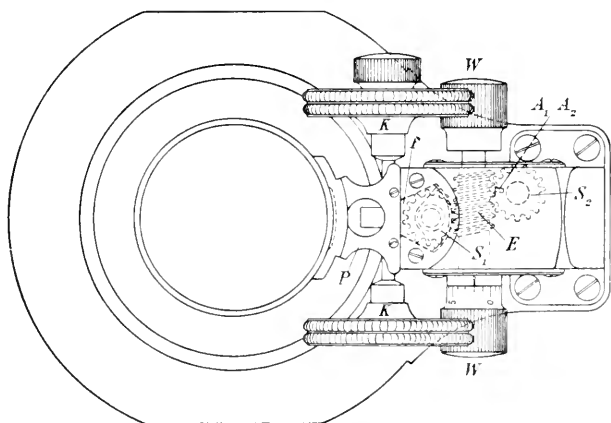

FIG. 130 (1898).

the micrometer screw M (fig. 129). The pressure of the spiral spring is in the direction of the axis of the micrometer screw, which works against a hardened point shown at D_2 fixed on the dust-tight under-cover of H (fig. 128). This 'conducting slide' F (fig. 129) is firmly screwed to the part carrying the coarse adjustment, and the aluminium tube T is connected in the usual manner with the rackwork.

To avoid what appears to have been considered a peril in the exposure of the milled head carrying the fine adjustment screw in the usual form of the

Zeiss stand, Dr. Czapski caused the fine adjustment to be placed in the hollow of the upright H (fig. 128), so that the screw itself is completely removed from direct contact with the hand; the turning of the 'micrometer' or

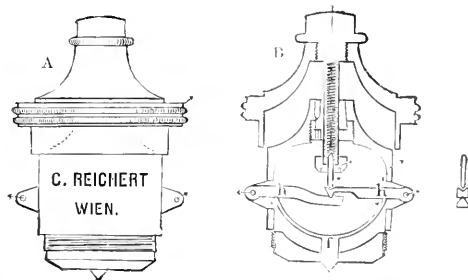

FIG. 131.—Reichert's new patent lever fine adjustment (1899).

fine adjustment screw only takes place by means of the motion of the small milled heads W W (figs. 128 and 130) which work the endless screw E (fig. 130). This engages the wheel S, which being fastened on to the flange of the fine adjustment screw, replaces or

rather supplants the usual milled head ordinarily placed at the top of H (fig. 128). One consequence of this is that the speed of the fine adjustment is slowed down so much that while Zeiss stands of the

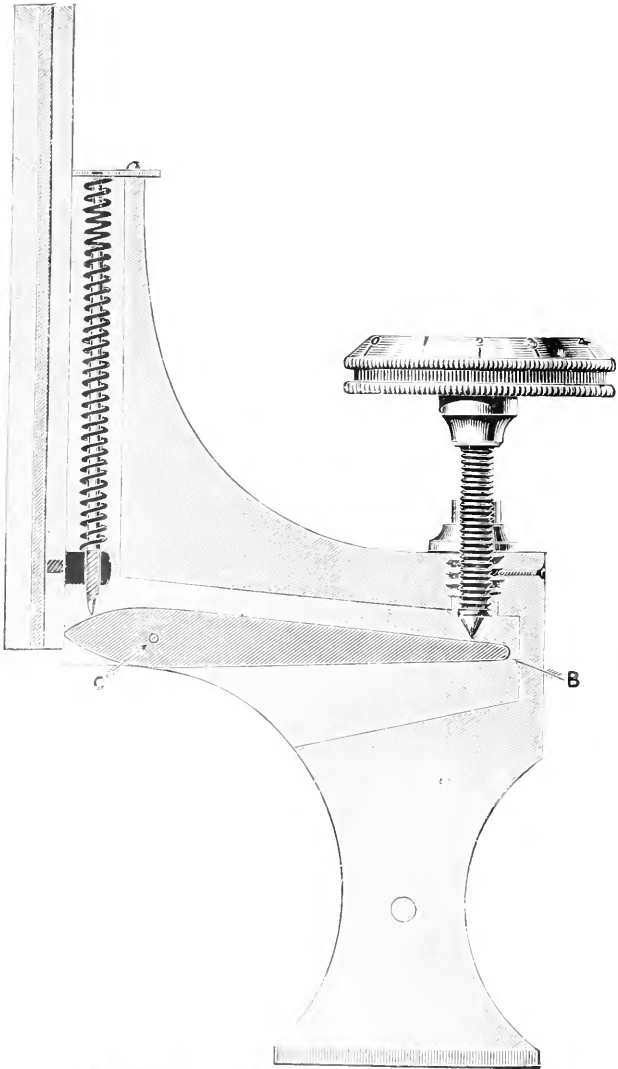

FIG. 132. Watson's lever fine adjustment (1889).

0.0001 of a centimetre gives only $\frac{1}{100}$ th inch for a revolution of the milled head of the ordinary micrometer head, this form of fine adjustment gives $\frac{1}{100}$ th inch for a revolution of the small milled heads W W (figs. 128,

130). That this is an advantage of a very high order—if experience proves it to be a practical method—there can be no doubt. Moreover, the weight which this newly arranged micrometer screw has to lift is, as the firm informs us, only one-fifth of that which was borne by the older form, and there are special arrangements made to prevent this delicate construction from being overscrewed either way.

The mechanical stage of this microscope has some features worthy of note. It will be seen that the milled heads which work the stage are on Turrell's plan, but the outer head gives transverse movement to the stage plate instead of vertical movement. The pitch of the screw on this pinion is fine, so that the motion is slow. The vertical movement which is actuated by the inner pinion head is on altogether a novel plan. The motion is one in arc, this stage plate being pivoted on the left-hand side; the circular portion on the right-hand side has rack teeth cut in it into which a pinion is geared. This pinion has a toothed wheel fixed to it, which engages an endless screw attached to the pinion that carries the inner pinion head.

The speed of the object at the centre of the stage is about half that of the rack, because the object is placed about halfway between the rack on the right and the pivot on the left hand side of the stage.

The stage is concentric with simple non-mechanical rotation: it can be clamped in any desired position by a small screw at the side of the stage (not shown in the figure).

We may now describe the exceedingly simple, and as we think beautiful because essentially practical, fine adjustment invented by Reichert, which we believe will prove itself the most useful and conservative adjunct ever devised

to make the Continental stand of service for high-class work without increasing its expense or reducing its value in ordinary work. It consists in adapting in a very ingenious manner a lever of the second order to the usual direct acting screw. It will be seen by fig. 131, which represents this part of the microscope open at B and closed as in use at A. The micrometer screw presses on two

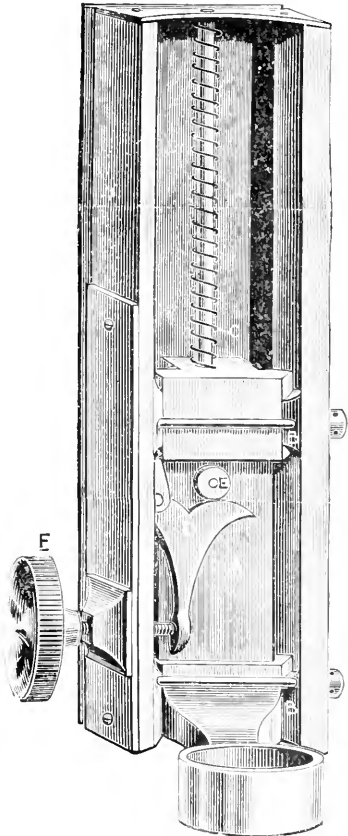

FIG. 133.—Swift's patent fine adjustment (1881).

levers, h. h. which in turn press the arched piece with its appendix f on to the prism support. The principal screw has three threads to the millimeter, which by the levers is reduced by about one third. The pointer for reading the micrometer scale on the milled head is conveniently arranged so that it can be changed to any figure on the scale. The speed of the adjustment is $\frac{1}{210}$ th inch to one revolution of the milled head.

We may now profitably consider the best forms of fine adjustment that apply to the Lister model, and one of the steadiest and

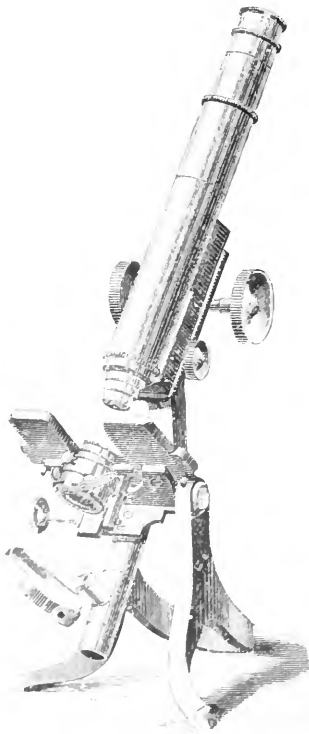

FIG. 131.—Nelson's model with screw fine adjustment, as used to the day (Jan. 1882).

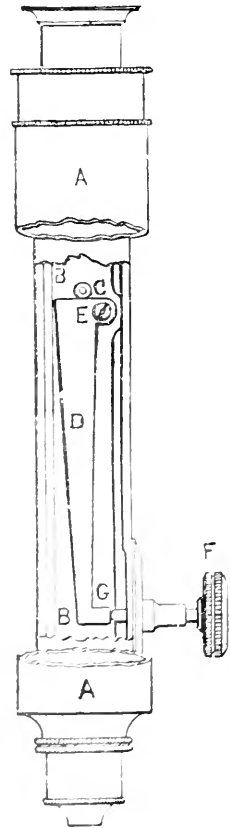

FIG. 132 (1885).

most delicate of these is that devised by Messrs. Watson and Sons. The entire body is raised or lowered by means of a milled head fixed to the base, having a hardened steel point, acting on a lever with two curved and highly polished contact surfaces, against a point of contact, the body slide, in a perfect dovetailed fitting, about $2\frac{1}{2}$ inch long. This is seen in the section shown in fig. 132. By turning the milled head at the top of the screw at B, which has its fulcrum

at C, raises or lowers the body with great smoothness and with the great delicacy of $\frac{1}{320}$ th inch for every revolution of the milled head, and therefore capable of yielding good service with the highest power objectives.

We may now direct our attention to the *form* of the two divisions into which we have separated the various kinds of fine adjustment, viz. that in which the *base-piece only is controlled* by the adjustment-screw.

Swift's optical slide lever is one of the new forms of fine adjustment worthy of careful trial; it has in its elements a great merit. It can, however, only be applied to the Lister model, and with the adjustment described above certainly places this form of adjustment beyond the danger that some years ago promised its "early" form its extinction as a first-class microscope.²

The first form of this adjustment (1881) was small in principle, ingenious in construction, and although the patentee later made a modification² of it (1885), we believe the original remains the best, because it always, in the hands of a skilful operator, the modification acts on the body-tube.

The early form employed by Swift, with the following exceptions, shows the necessity of all successful fine adjustments of this type, viz. of the accuracy and perfection of the fitting of their several parts. This was done, as shown in fig. 133, by attaching a screw, *A*, to a sliding bar, *A*, to the nose-piece, and sliding this bar, *V*, against a V-groove at the back of the body. A forked, flattened metal screw with milled head, *F*, acts on a vertical screw, *D*, and the latter, *E*, is fixed to the prism-holder.

There is also an adjustment of the right-hand screw, *F*, against the V-grooves, *B B'*. Shims, *S S'*, and brass, *G G'*, are used in connection with this form of adjustment, while the power of the adjustment is obtained means of the capstan-headed screws, *C C'*, which are also finely compensated. It is obvious that the screw, *F*, is not directly controlled by the base-piece, *V*, but by the sliding bar, *V*, and the distance of the lifting-screw, *E*, from the base-piece, *V*, controls the pitch of the screw, *F*, and *F'*.

Manifestly, when a microscope of this type is constructed, the screws employed should be as true as possible, and the shims, *S S'*, should be on the side of the operation, where they will be most readily compensated. We should leave the right-hand screw, *F*, moving the slide, *V*, against the V-groove, *B B'*, for adjustments. And, in every case, the adjustment-screw, *F*, should be made to have the right-hand thread, and that of the lifting-screw, *E*, the left-hand. Mr. Nelson, when this form of adjustment was first used, had a student's microscope constructed, and we can give a description of the head on the left side, showing the adjustment-screw, *F*, and the shims, *S S'*, if it would greatly improve this adjustment. The shims, *S S'*, and the screws were carried right to the right-hand side of the microscope, and the shims, *S S'*, on the right and the left sides, *S S'*, on the left.

An early form of a microscope of this type was also constructed and employed by Andrew Ross. It is shown in fig. 134, and is similar to the

bar movement. It consisted of a *lever of the second order inserted within the bar*, and actuated by a micrometer screw with a milled head at one end, the fulcrum being at the other, and the nose-piece between them. This served admirably in the days of low-angled objectives; but there were two faults belonging to it: one was that the tube of the nose-piece had not a sufficient length of bearing and was liable to a lateral shake; the other was that the adjustment screw, being near the middle of the bar, involved tremor.

The application of this principle in its very highest and most perfectly practical form was invented by Powell. His instrument also had a bar movement: but the bar being of relatively great length, he employed a *lever of the first order*, the micrometer-screw being at one end, the nose-piece at the other, and the fulcrum between them. The ratio of the arms of the lever was 4:1; and the screw is so arranged that a complete revolution of the milled head is equal to the $\frac{1}{2000}$ th of an inch. The position of the screw is immediately behind the pivot on which the bar turns, and this precludes the possibility of the impartation of vibration to the body; and, as the nose-piece tube is very long, and only bears on three points at either end, this adjustment is the steadiest, the smoothest, and the most reliable for all objectives of any of the several devices which have come before us during the last twenty years. In fact, this fine adjustment has held an unrivalled position for the past fifty years (fig. 157).

The fine adjustment that was employed as its rival on the earlier forms of the Lister model was known as the *short-side lever*, and it was sometimes employed in the commoner bar-movement microscopes. Its position and character will be seen on the right-hand side of the body of the Smith model, fig. 122. In the light of what we now need, we are bound to say to the intending purchaser of a microscope, 'Avoid it!' it is bad alike in design and construction. The screw is so placed that tremor is inevitable in the body when it is touched, while the nose-piece tube is so short that steadiness of movement does not belong to it. It is only that it was concurrent with the belief in 'low angles,' and consequent 'penetration' in objectives (with which no critical work could be done), that it is possible to account for the toleration for so long in numbers of English microscopes of this wholly inefficient adjustment.

From the foregoing we learn that there are three types of microscope models for which a suitable fine adjustment has been found.

i. The bar movement model, for which Powell's first order of lever is the perfect method.

ii. The Lister model, for which Swift's vertical lever and Watson's long horizontal lever are the best forms known.

iii. The Continental model, for which Campbell's differential screw is the most smooth and delicate device yet suggested, unless we take into consideration the beautiful lever fine adjustment of Boscich.

The full value of delicacy in the fine adjustment can of course only be fully appreciated by the expert. A tolerable speed may be perceived in this adjustment when uncritical images with small illuminating cones are used, because objectives so used are far less

sensitive to focal adjustment. When, however, a critical image is obtained with a $\frac{3}{4}$ cone the conditions are changed and an objective with a wide aperture becomes excessively sensitive to minute focal alterations. Hence the need with the highest class of microscopic investigation of at least as slow an action as can with safety to the mechanism be secured, and therefore comes out the danger of burdening the screw of the fine adjustment with a fraction of an ounce of lifting more than can be avoided.

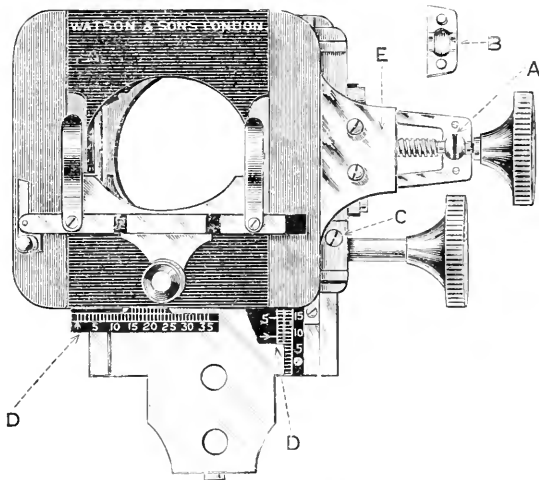

FIG. 136.—Watson's new stage (1898).

So far as we can ascertain the speeds of the several fine adjustments now within the reach of the worker, they are as follows, viz.:

Model	Speed for one revolution of the milled head in fraction of an inch
Bausch and Lomb	$\frac{1}{31}$ st = two threads to 1 mm.
Reichert (old form)	$\frac{1}{2}$ th
Zeiss (ordinary)	$\frac{1}{101}$ st = four threads to 1 mm.
Powell	$\frac{1}{300}$ th
Baker and Swift (Campbell differential screw)	$\frac{1}{210}$ th
Reichert new patent	$\frac{1}{210}$ th
Swift vertical lever	$\frac{1}{300}$ th
Watson's long lever	$\frac{1}{350}$ th
Zeiss's new endless screw arrangement for photo-micrographic stand	$\frac{1}{337}$ th

IV. **The stage of the microscope** will next call for consideration. What is known as a *mechanical stage* must be a part of every first-class microscope; but by this we mean one of perfect workmanship and construction, otherwise it is an impediment and not a help.

To this end we would say at the outset there must be thoroughly well-made movements. The employment of levers, cams, and that class of stage-gear is in practice, for critical purposes, a mere

mechanical mockery. Better trust to and educate the *fingers* to move the object than be beguiled by any such practically tormenting delusions. They are simply impossible as accompaniments of a first-class microscope.

The principle upon which alone a perfect mechanical stage can be constructed, so as to work smoothly without 'loss of time,' and endure constant use without failure, must be the employment of prism-shaped plates sliding in sprung V-shaped grooves, and bearing only on four points.

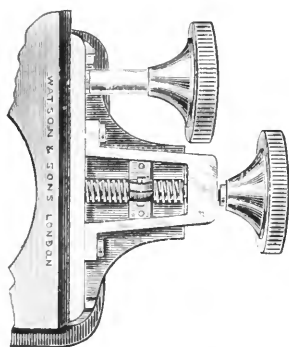

FIG. 137 (1898).

We may test the mechanical quality of the movements of a stage, as in the case of the coarse adjustment, by removing the parts, cleaning them, and replacing them, when they should work smoothly and without shake. Where the sliding parts are tightened into easily fitting and merely ploughed grooves by pressing the pinion into the rack, the desirable result of smooth working and instant responsiveness of sliding plates to milled heads will not present itself.

But besides the perfect action of the sliding parts, a perfect mechanical stage should have *equal speed of motion vertically and horizontally*. A common fault is that the speed of the rackwork giving vertical motion is greatly in excess of that of the screw giving lateral or horizontal motion. If, for example, a pinion has eight leaves, and the rack it works has twenty-four teeth to the inch, then three turns of the milled head (and pinion) would cause one inch of movement to the stage. In order, therefore, to get the same rate of movement in the lateral motion, the screw should be so pitched as only to move the stage through an inch with three revolutions of the milled head.

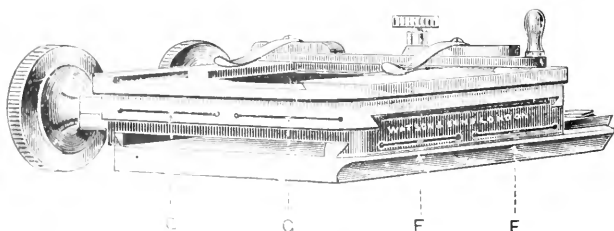

FIG. 138 (1898).

It is most desirable that *the pinions should be fixed*, not movable with the movements of the stage, and the *milled heads* carrying the responsive parts *should be as near to each other as possible*. The best form is that of Turrell's, devised in 1832, where one (a screw) is *hollow*, and the other (a pinion) passes through it; this permits both to be turned at the same time with one hand, giving a diagonal

motion, as well as the separate rectangular ones, and gives great facility for instantly producing any motion required without removing the hand from its position; a most desirable attribute of a stage when the rapid movements of a living and minute organism are being followed.

It still further enhances such a stage if a pinion is carried right through the stage with a milled head at each end.

A new stage devised by Watson has in it some features of interest, a principal one being that the milled head controlling the horizontal movements is in a fixed position; in other words, does not travel with the plate. This is shown in fig. 136. A is a ball upon which the turning of the screw takes place; it will be noticed that this ball has a groove in it into which grease or dust can drift without affecting the motion. The cap B covers the ball when fitted together. The manner in which verniers are fitted is shown at D, D, and the screw for adjusting the vertical rack movement of the stage is shown at C. Fig. 137 shows the manner in which the plate E is attached to the stationary screw; while fig. 138 indicates the careful manner in which this stage is sprung to counteract continuous wear. The saw-cuts shown are compressed by means of screws which are situated at the points F F, G G, and any amount of wear can be corrected by the use of these screws in these slots.

The aperture in the stage should always be large, not less than $1\frac{1}{4}$ inches in diameter. There ought always to be space enough above the ordinary slip when it is in position to permit of the easy insertion of the index finger, for by its proper use, focussing with the highest powers may be greatly facilitated. The object is to raise or lower the slip, as the objective approaches the object, so as to discover how nearly it may be to contact with the front lens of a high power in approaching focus. The focal distance should always be felt, and not sought with the eye.

Let it be supposed that we are using a dry object-glass with a full aperture, and consequently short working distance. With the right hand the coarse adjustment is worked; with the elbow of the left arm on the table, the second finger of the left hand resting on an immovable part of the stage, which steadies the whole hand, the index finger should rest lightly on the edge of the slip, and the thumb be so placed as to graze the objective as it advances towards the slip. The touch of the thumb indicates whether the objective is an inch off or only a quarter of an inch away from the cover of the slip. The movement of the coarse adjustment may be rapid up to $\frac{1}{4}$ th or $\frac{1}{3}$ th of an inch, but after this there must be a cautious but steady advance. The body may be racked down until by gentle upward movement the slip is found to touch the front of the objective; then proceed cautiously by delicately lifting the slip from time to time, by doing which we can proceed in perfect safety until the focus of the object is obtained. In this way focussing becomes easy and rapid, a matter of touch, and not of discontinuous procedure to 'discover where the front of the lens is'—a search requiring a hand glass and often, with its cumbrousness, considerable loss of time. The above simple plan with brief practice will enable the operator to

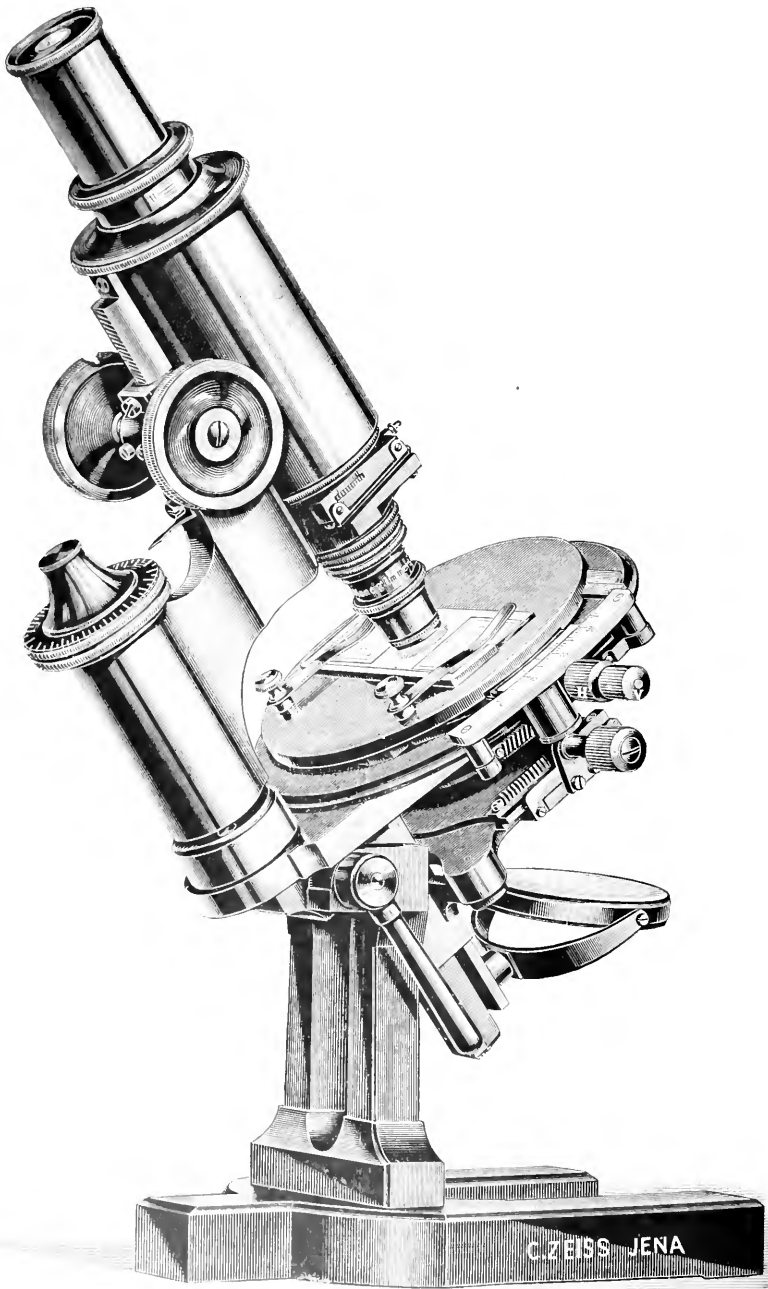

FIG. 139.—Zeiss photo-micrographic stand (1895).

PROB. 1895/1896

focus an object in the field with a $\frac{1}{25}$ -inch objective in ten or twelve seconds.

If a *perfect mechanical stage* cannot be obtained, take no middle course, have a *firm, well-made plain one* with a *smoothly sliding ledge*. The stage should be large, and the ledge should glide with perfect ease and without catching when gently pushed from one corner. For this purpose the side-guides should be long, and only the ends of the bar should bear on the stage. The aperture should be as in the mechanical stage, and for the same reason.

Mr. Nelson suggested a stage of large size, which should have a $1\frac{1}{2}$ or $1\frac{3}{4}$ inch aperture bored in it, and then have the intervening brass between it and the front taken away, so that the stage assumes a horse-shoe form. This is thoroughly efficient, and the principle is seen in fig. 134.

It is a matter of great interest to English microscopists to note that their German collaborators in Germany and the leading German makers have not only surrendered to the sub-stage condenser, and even in its achromatic form, but that at length they have also adopted the mechanical stage; the latest form adopted by Zeiss is figured in the accompanying illustration which shows the complete instrument (fig. 139). We specially call attention to it here, as it has Turrell heads, marked H V, and a rotating stage of 4 inches diameter.

It must, however, be noted that the usual Continental model adopts a *small stage* with a $\frac{3}{8}$ -inch aperture and two *fixed spring clips* with *no sliding ledge*; that is, wanting almost everything *required* to do good modern work.

One of the most practical rules for the young microscopist in this relation is, 'Have your mounted slide in a fixed position, but never *clip* it if it can possibly be avoided.'

In addition to perfect rectangular movements a first-class microscope should have *concentric rotary motion to the stage*. This is usually effected by rack and pinion, but it is at times desirable to move it with greater rapidity than this admits of. In very well made instruments the pinion engages the rack so lightly that this rapid motion may easily be given to it. In others the pinion can be disengaged and rapid movement effected.

The centre of rotation of the stage should be closely approximate to coincidence with the optic axis, so that in rotation the object should never be out of the field when a fairly high power is used. Elaborate rectangular centring gear has been used by some makers, and is found in some high-class instruments; but this is not needful, for all that is really required is to rotate an object without losing it. In fact *exact* centring would have to be readjusted for every separate objective if it were needed. But any slight departure from the axial centre can be much more readily met by bringing the object into centre by the mechanical stage.

There are *four movements* in every microscope *which should be graduated*: these are (1) the milled head of the fine-adjustment screw; (2) the stage movements for finders; (3) the extension draw-tube carrying the eye-piece; and (4) the rotation of the stage. Divided arcs are imposing, and to the multitude look 'scientific';

but in practice they are superfluous in the most complete instrument beyond those indicated.

There is a simple form of attachable mechanical stage now employed by many, and we think with advantage, when the cost of a complete mechanical stage must be forgone. This consists of a clip to receive the object, made of glass or brass, so arranged that the friction shall be reduced to a minimum.

Such an attachable stage can be made to work with remarkable smoothness; and since some persons have not sufficient delicacy of touch to move so small and thin an object as a 3×1 -inch slide upon the stage with steadiness and precision, it is in favour of the super-stage that it is larger, moves easily, and can be furnished with convenient points of hold-fast for the hands, and consequently is more manageable. Against its employment is the fact: 1st, that the slide is clipped into a rigid position; and 2ndly, that the aperture is often too small to admit of the employment of the finger in

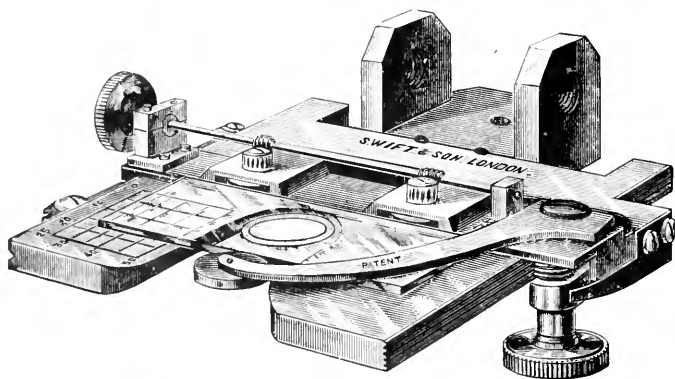

FIG. 140.—Swift's attachable mechanical stage (1894).

moving the slide to assist in rapid focussing. But these are defects which are rapidly disappearing.

Amongst those that claim the attention of the microscopist is that of Messrs. Swift and Son, shown in fig. 140. It can be adapted to most microscopes; it is easily applied and removed, leaving the stage, if required, free. The up and down motion is effected by a milled head below the stage. The lateral movement is produced by two endless screws engaging in worm-wheels fixed to smooth rollers. The lower edge of the slide rests on these, and is kept in gentle apposition with them during traverse by a third smooth roller at the free end of a curved spring as shown in the figure. This is readily turned aside when changing the object. In its most recent form we have used this stage with comfort and pleasure.

Another of these stages, made by Baker from designs by Mr. Allen, is shown in fig. 141, which in its latest form is so arranged that the width of space between the rest and the spring clip can be

enlarged so that a much wider preparation than the usual one inch may be worked with great facility on this stage. The method of attachment practically makes the mechanical stage one with the stage of the microscope, as it is in contact with the fixed stage throughout its entire length, and is clamped at the lower end to the top, and at the upper end to the bottom of the stage.

Both the rectangular movements are effected by rack and pinion, the vertical one of which carries a bar (fixed as to horizontal movement) against which the slide is pressed by a spring clip, and upon which is mounted the rack and pinion for the horizontal movement; the end which presses upon the slip is tipped with cork in order to grip the slide, and move it along the fixed bar; when the milled head is rotated, the slide actually rests on two small raised surfaces at either end of the bar to minimise friction. This is without question a well-

made practical and useful stage. Amongst stages of this kind, however, the most original and useful has been devised by Mr. Nelson. As seen in fig. 142, the sliding bar has been slotted and a movable piece, which may be called the shuttle, has been fitted in the slot; this shuttle has a diagonal rackwork at the back, and a vertical spiral pinion gears in it, as is shown in fig. 143. Above this pinion there is a horizontal bevel wheel which is geared by friction to a vertical wheel fixed on the usual horizontal pinion. The cock which holds, and is close to, the vertical

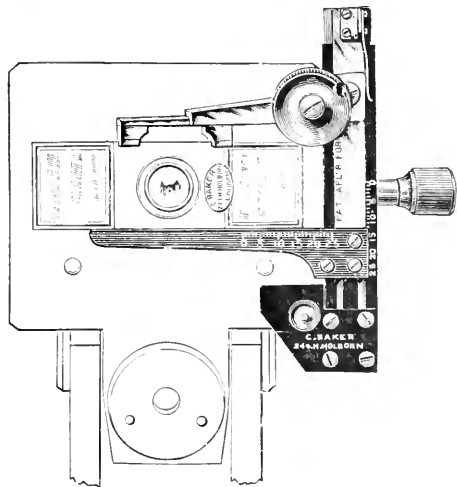

FIG. 141.—Baker's attachable stage (1898).

bevel wheel in fig. 143 is slotted underneath, a capstan-headed screw (not shown in the figure) is fitted for the purpose of compressing this spring part; the amount of friction between the copper bevel wheels can therefore be regulated at will. This capstan-headed screw is placed some distance from the bearing, so that the length of the bar between it and the bearing may form a stiff spring; this renders the motion equable. It will be noticed, therefore, that the transverse movement is confined to the sliding bar. This sliding bar can be removed so as to leave the stage perfectly plain. The heads of the pinions which control the vertical movement have been kept below the level of the stage so as to be out of the way of culture plates. Three and a half inches of transverse movement is given to this stage, and the manner of the holding the clip is quite new and eminently serviceable. On the shuttle there are two sliding pieces,

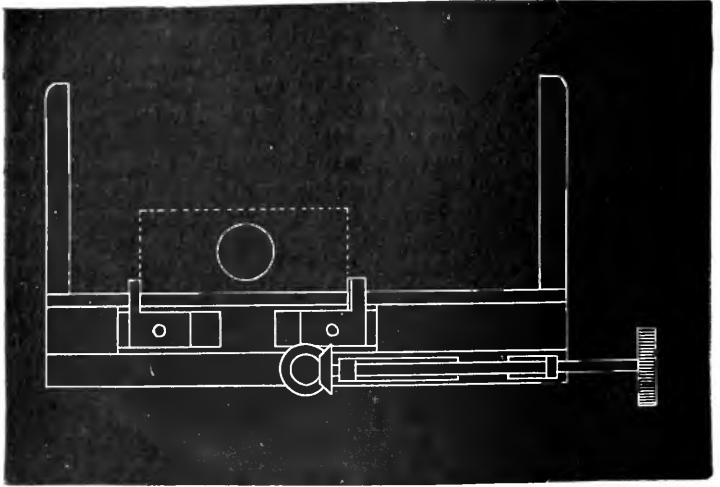

FIG. 142. Nelson's new mechanical stage (1897).

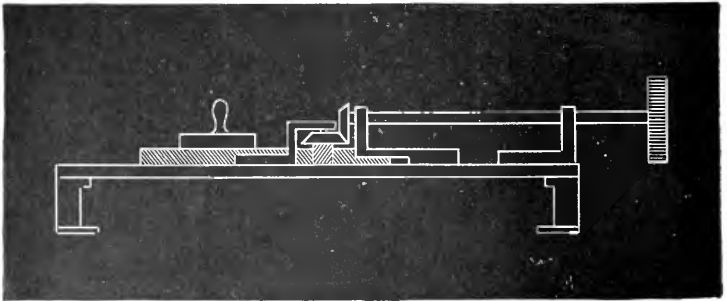

FIG. 143. Nelson's new mechanical stage (1897).

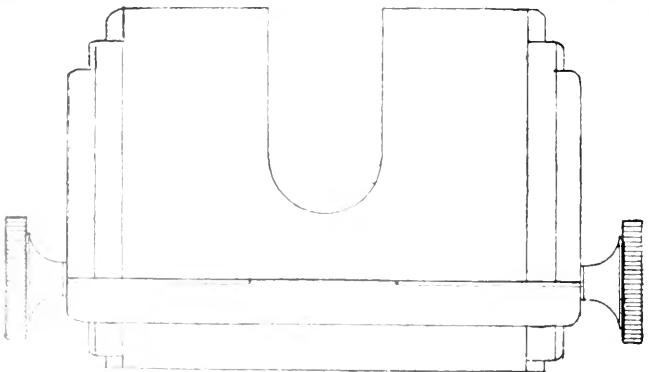

FIG. 144. Nelson's new mechanical stage (1888).

and these hold the slip by the two lower corners, as seen in fig. 142; and this mode of gripping allows for the employment of the invaluable method of touch on the edge of the slide for discovering working distance and focus. A plain sliding bar may be substituted for the mechanical bar; this forms a semi-mechanical stage as shown in fig. 144. The mechanical movement being only imparted to the lugs at the side of the stage, the bar may be moved by the hand by sliding as in an ordinary plain stage without the employment of the mechanical movement.

The stage is of aluminium, and its size is $4\frac{1}{2} \times 7$ inches.

Another attachable stage having many advantages is made by Reichert and shown by fig. 145. It can be used with any instrument of the Continental type, is very carefully made, and the scales

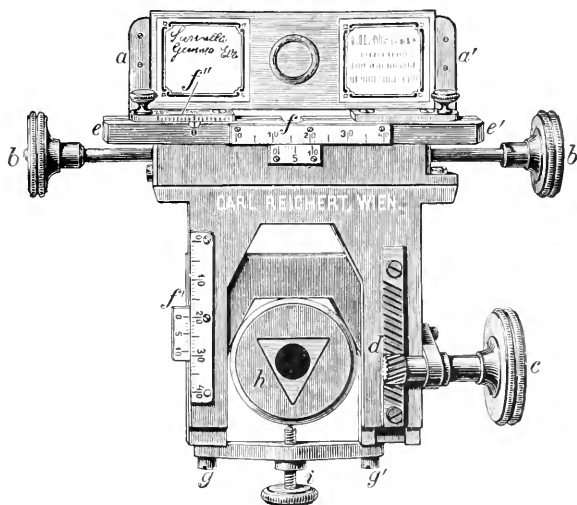

FIG. 145.—Reichert's attachable stage. (About half natural size.) (1892.)

attached are divided to read by means of a vernier to 0.10 mm., and the range of movement is an inch in both directions.

An attachable mechanical stage is also made by the Bausch and Lomb Optical Company of Rochester, New York, having great merit and some special points; and this firm is in advance of all other makers that we know of in making an attachable *revolving* mechanical stage.

There is much similarity to the American mechanical stage in one made by Carl Zeiss and illustrated in fig. 146. Of course the principle, as primarily in all the others, is that suggested by the late Mr. Mayall, and afterwards by Reichert. Two sliding pieces, mounted at right angles to one another, are moved by means of two milled heads, S, T. They pass along millimetre scales which serve to record any particular position.

The demand for these attachable stages is, we presume, consider-

able, for they are made by most leading opticians. The last mechanical stage we illustrated is by Messrs. R. & J. Beck, which is illustrated in fig. 147. It has vertical rack and pinion and horizontal screw motions with graduated finer divisions.

To Messrs. Bausch and Lomb, however, we are indebted for the introduction of an attachable stage in which the iris diaphragm is on the plane of the stage. We illustrate this in fig. 147A. Its use with a condenser we do not commend. But especially when the illumina-

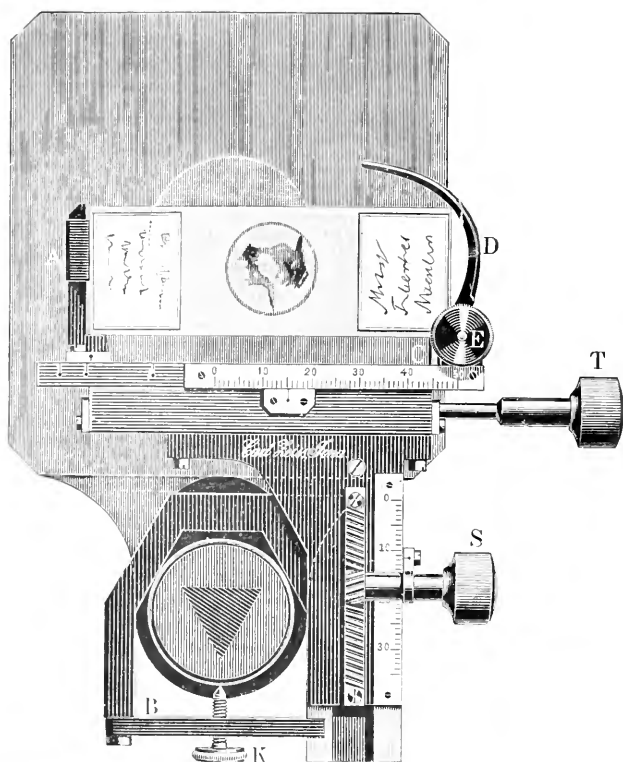

FIG. 146.—Zeiss's attachable mechanical stage. ($\frac{2}{3}$ full size.) (1895.)

tion is daylight, and very critical results are not sought, it will be useful, and is admirably made.

V. **The sub-stage** is scarcely second in importance in a first-class microscope to the stage itself. It is intended to receive and enable us to use in the most efficient manner the optical and other apparatus employed to illuminate the objects suitably with the various powers found needful. Upon this much of the finest critical work with the modern microscope depends.

To accomplish this a good sub-stage must have rectangular movements, and a rack-and-pinion focussing adjustment.

The vertical and lateral movements need not be as elaborate as those of the stage, since only a small movement in each direction is required. The object is to secure a centring motion, a motion that will make the optical axis of the sub-stage combinations continuous with the optical axis of the objective. It must therefore be a steady motion; the sub-stage must move decisively, and must rigidly remain in the position in which it is left.

A bad sub-stage moves in jerks, and is liable to spring from the position intended to be final.

It is not needful that the motion should be in right lines; *motion in arcs whose tangents intersect at right angles* are quite as efficient. A steady, even, reliable motion that will enable *a centre to be found* is all that is required.

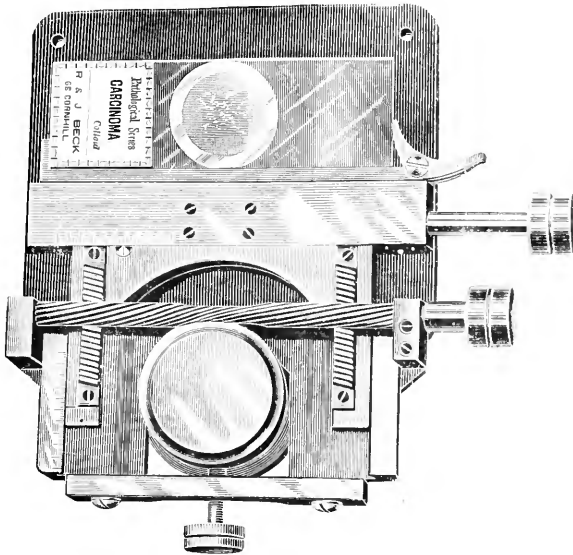

FIG. 147.—Beck's mechanical attachable stage (1896).

The focussing adjustment must be smooth, steady, and firm, acting readily and remaining rigid. The recent employment of achromatic condensers of wide apertures has led such critical workers as Mr. E. M. Nelson to suggest *a fine adjustment to the sub-stage*. There are times when it is a great luxury and a facile path to delicate and desirable results; but it may be quite simple, a direct-action screw of fine thread, or a cone which the revolution of a screw pushes horizontally forward upon the bottom of a sliding bar to which the sub-stage is fixed, or an inclined plane acting in a slot in the same way. In fact, any simple device for focussing the condenser more slowly than the rackwork will do, pushing the condenser up to, or causing it to recede from, the under surface of the slide with sufficient delicacy. But no means should be employed

for this end which will imperil the absolute *firmness* of the sub-stage, or else more will be lost than can be gained. The need of such a device for the most delicate and critical microscopical work is shown plainly by the fact that during the past few years several ingenious and practical devices have been used, nearly every principal English maker employing a method of his own. The first arrangement was made in Powell and Lealand's sub-stage and is shown in fig. 148. The nature of this device, which was suggested by Mr. Nelson, will be readily understood. It does not interfere with the general

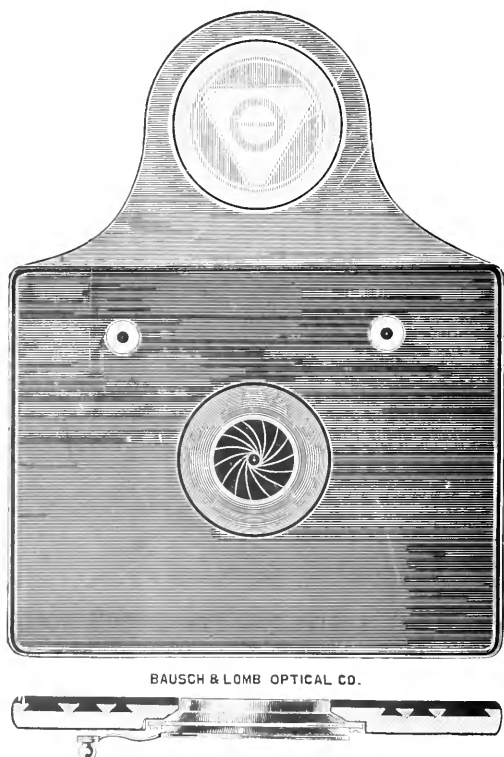

FIG. 147A.—Attachable stage with diaphragm in the plane of the stage. Top view and cross section showing construction of stage and attachment of iris diaphragm.

mechanical arrangements of the sub-stage; it will be seen that the milled head A controls a screw spindle terminating in a steel cone B. On rotating A, B turns, and with a very slow motion forces up (or releases as the case may be) a pin C, inserted in the base plate E of the sub-stage. The motion of C carries with it the condenser. At right angles to and forming part of E at the back an inner sliding plate works against a spring at the upper end between bearings F at each side, which are fixed upon the usual racked slide D of the sub-

stage; the inner sliding plate is the essential addition to the usual racked slide, in the application of the new fine adjustment to the sub-stage. The range of motion is about $\frac{1}{2}$ th in.—the difference in radius between the smaller and larger ends of the steel cone.

A very simple and practical device for the same purpose was suggested by Mr. G. C. Karop, who knew that if the best possible resolutions are required, the image of the flame given by the condenser should be as accurately adjusted in the focal plane as the object itself. This arrangement of Mr. Karop's, admirably suited to the stands of Messrs. Swift and Son, was patented by that firm. It consists in the adaptation of their well-known 'climax' or 'challenge' fine adjustment to the slide carrying the sub-stage; but it is actuated by a milled head borne on the spindle to which is connected the coarse rack motion. As will be seen in fig. 149, it is a lever actuating a stud fixed to the dovetailed slide which carries the

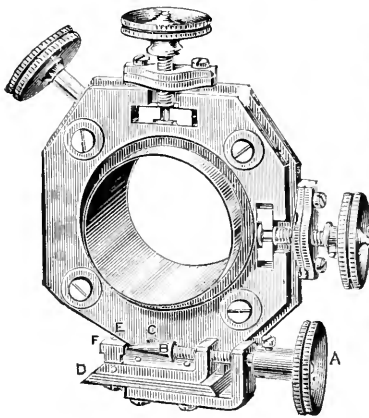

FIG. 148.—Fine adjustment to sub-stage. Powell (1882).

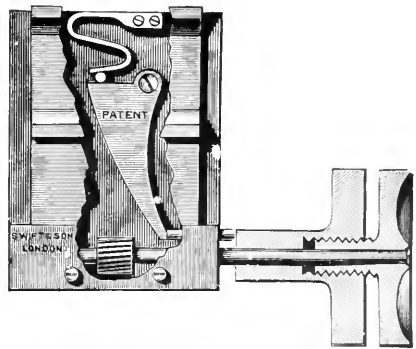

FIG. 149.—Karop's fine adjustment for sub-stage, made by Swift (1892).

sub-stage. The extreme end of the lever is not acted upon by a fine screw, but there is a cylindrical pin one end of which engages the point of the lever, the other the face of the inner milled head; the milled heads resemble the Turrell stage arrangement, but the inner milled head works on a screw on the stem of the outer milled head; when the inner milled head is turned it traverses the stem of the outer one, and pressure by the S-shaped spring in the fig. causes the stud to slowly raise or lower, as may be desired, the sub-stage which carries it. One complete turn of the inner head presses the sub-stage the $\frac{1}{125}$ th in. So that small fractions of this may be easily obtained, and it is an advantage that the milled heads of both movements are so close to each other.

Messrs. W. Watson and Sons have also devised a useful arrangement to serve the same end. As applied to their Van Heurck microscope it is shown in figs. 150 and 151. A is a controlling milled head, B the lever which is seen from the side in fig. 150

and from the front in fig. 151. This is brought round at one end at right angles to the front. The fulcrum of this lever is at C, and it fits under the pin D which is attached to a dovetailed piece, having at the back of it enclosed in a metal casing the counteracting spring

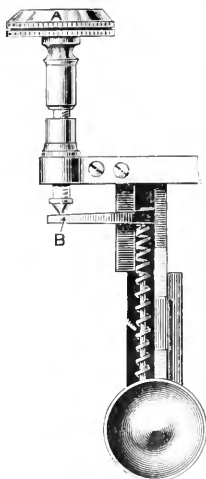

FIG. 150.
Watson's sub-stage fine adjustment (1899).

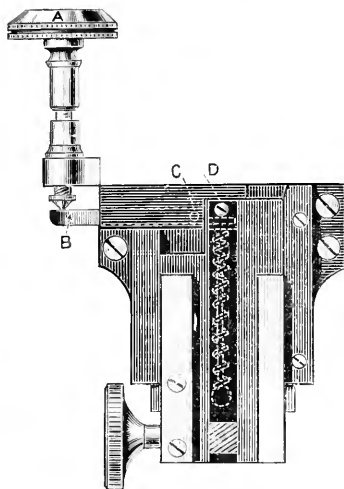

FIG. 151.

shown in fig. 151; when, therefore, the lever is depressed at B, the sub-stage is raised at D and *vice versa*. The milled head A is placed at the side of the stage of the microscope towards the back slightly higher than the surface of the stage.

The fine sub-stage adjustment of these makers as applied to their 'Royal' microscope is shown as it is in its complete form in fig. 152.

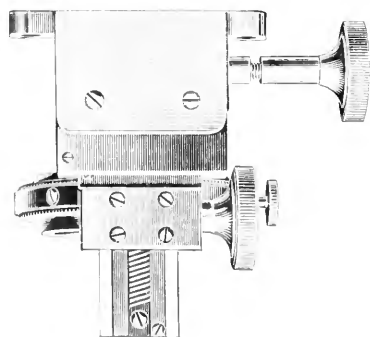

FIG. 152.—Sub-stage fine adjustment complete in 'Royal' microscope (1899).

Another sub-stage fine adjustment has been devised by Baker, which, we are of opinion, it will be of advantage to the student to understand. It employs the differential screw, and by this means obtains a very slow movement. The student has already understood that the principle of this screw is the cutting

of two threads of a different 'pitch,' one at either end of the screw, the proportion of one to the other determining the amount of movement. The threads found most suitable for their sub-stage fine adjustment were 40 and 50 to the inch. In fig. 153 the screw A C

has 40 threads to the inch, and works through an immovable fitting, the thread is discontinued at C, and from C to D a screw having 50 threads to the inch is cut, working through a fitting E. If now the milled head F be rotated 40 times, the screw A C will have travelled one inch. So will the screw C D as it is cut on the same stem, but it would take 50 revolutions of screw C D to travel one inch through the fitting E, hence the fitting E must have been carried up bodily the remaining 10 revolutions—that is to say, $\frac{1}{3}$ th

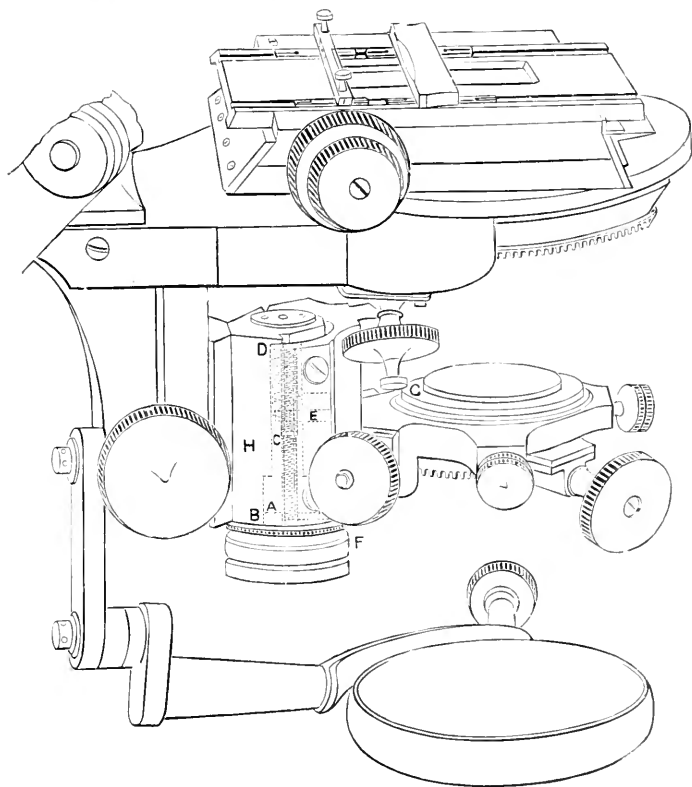

FIG. 153.—Baker's fine adjustment to sub-stage (1888).

of an inch—therefore one revolution raises the fitting E $\frac{1}{200}$ th of an inch.

The fitting E is attached to the sub-stage G through a slot cut in the cover of the adjustment; the cover is also grooved on either side to receive that part of the sub-stage H which insures the true vertical movement so essential with this screw.

It is almost a matter of compulsion to refer here to a comparatively recent arrangement known as a *swinging sub-stage*, which is, as its name implies, a sub-stage so arranged as to be capable of

being moved *laterally out of the axis in an arc which has the object on the stage for its centre.*

The sole purpose of this is to secure *oblique illumination*, which practically, at the time the swinging sub-stage was devised, meant obtaining a more oblique pencil than the condensers then provided could command; and since this also meant sending into the object a small portion of a cone of light in *one azimuth*, many tacitly assumed that this alone was taken to be 'oblique illumination.' But whatever sends oblique light through an object into the objective is an oblique illuminator. Two condensers may have numerical apertures of 1.4 and 1.5 respectively; a stop behind the back lens in each has a narrow sector cut out, representing the conditions of the so-called 'oblique illuminators;' by the former we get an oil angle of $134^{\circ} 10'$, by the latter a similar angle of $161^{\circ} 23'$. These sectors of the cone of light of $67^{\circ} 5'$ and $80^{\circ} 41'$ respectively are in every sense 'oblique illuminators,' and the one more oblique than the other.

Whether or not it is needful or best to use such a sector is scarcely an open question; it is manifest that by taking the stop with its sector away from each condenser and sending in the *complete cone of light* formed by the condenser, we are still using *oblique illuminators, but the obliquity is in all azimuths.*

There can be no doubt that a large aperture in a condenser provides the microscopist with far greater wealth of resource than an oblique illuminator in one azimuth can ever give him. A condenser with an oil angle of $161^{\circ} 23'$ is much more valuable than even the semi-angle obtained by a mere section of a luminous cone. The power to utilise the entire cone is a gain of the highest order.

It will be manifest to all that we want concentration as well as obliquity.

Ordinary concentration depends upon the *power of the condenser*. If it is required to concentrate the light from the edge of the flame of a paraffin lamp upon an *Amphipleura pellucida*, the condenser must be at least a $\frac{1}{4}$ th inch or $\frac{1}{3}$ th inch in power, which will give an image of the flame nearly the same size as the object. The *amount of light* which is concentrated upon that object will of course depend upon the aperture of the condenser. An oblique cone of great intensity is here what is needed; the illuminating cone should be equal and conjugate to that which exists between the object and the objective.

Now it is certain that this condition cannot be met by an 'oblique illuminator' of the kind commonly understood by that name; to get immersion contact, which is of course a *sine qua non*, we must employ a hemispherical button—or one greater than a hemisphere—placed in immersion contact with the under surface of the slide. This may be illuminated by a beam from a dry combination, made oblique by the sub-stage being swung out of the axis. Granted that the angle is attained which can be got with a condenser of great aperture, we manifestly obtain only a portion, and an attenuated and small portion, of the light given in every, or at will any, azimuth by the condenser.

Theoretically perfect illumination of an objective, for example,

a $\frac{1}{8}$ th of N.A. 1·4 or 1·5, would be obtained by using a precisely similar objective as a condenser, with its back lens stopped down by a slotted stop, the slot being of the size of the peripheral sector required to be illuminated. The cone of illumination would precisely equal that taken up by the objective, and would be of maximum intensity.

Now these conditions are more nearly approached by a high-class achromatic condenser of great aperture and of homogeneous construction than by *any* other means.

The *value* of oblique illumination is not here in question; what we believe clearly shown is that, however much may have been done by oblique illuminators dependent on swinging sub-stages, and the like, the same things can be *better done with immersion condensers of great apertures and perfect corrections.*

The swinging sub-stage, with these considerations—as well as all other ‘oblique illuminators’ of its order—is a useless and defective, not to say deceptive, adjunct to the microscope; and this judgment has so far obtained amongst practical microscopists as to cause the virtual disappearance of the swinging sub-stage. It has no valid function—is unfruitful specialisation in fact—which does not promote the progress of either the instrument or the worker.

And this will apply to those complex forms of microscope known as ‘radial,’ ‘concentric,’ and those provided with stages that revolve or ‘turn over’ in an axis at right angles to the optical axis of the microscope.

In addition to the features enumerated hitherto, *a complete sub-stage should also be provided with a rack-and-pinion rotary motion;* that is only really needed in order to use the *polariscope.* For the purposes of its successful employment this is important, but otherwise its use is very limited.

VI. **The mirror** is also an indispensable part of a complete microscope. In a first-class stand it should be *plane* and *concave* and from $2\frac{1}{2}$ to 3 inches in diameter. It may be mounted on either a single or a double crank arm. In any microscope, if there be only one mirror, it should be *concave.* This mirror, from its curve, has a focus, a point in which the reflected rays all meet; and the mirror should not be fixed, but so mounted that it may be focussed on the object.

The plane mirror is sometimes found to give several reflexions of a lamp flame at one time; we find a very efficient explanation of them in a paper by Mr. W. B. Stokes in Vol. VI. of the second series of the Journal of the Quekett Micro. Club, p. 322 (1896). His idea of their origin is explained in fig. 154. A is the glass surface, B the silver surface, O the object, and E the eye. In the direction 1, 2, 3 appear the first three images. No. 1 is from the glass surface, No. 2 from the silver, and No. 3 is from the silver and *air* surfaces.

Move a card along A towards 1, and No. 3 disappears first, No. 2 immediately after, and No. 1 when the card reaches that point. This being their origin it may be asked how the images can alter their position when the mirror is revolved in the plane of A. They cannot; the mirror A B has parallel surfaces, but microscope mirrors

are not completely parallelised; they may be regarded as wedges. With that fact before us we can see how images approximate and retire when the mirror is revolved. Let the surfaces A and B, fig. 155, have an inclination of 1° ; then, viewing a small object at E (close to the eye), one image appears towards 1—i.e. at right angles to A—and another in the direction E 2, $1\frac{1}{2}^\circ$ from E 1, which, after

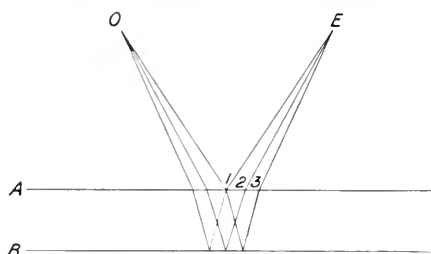

FIG. 154.

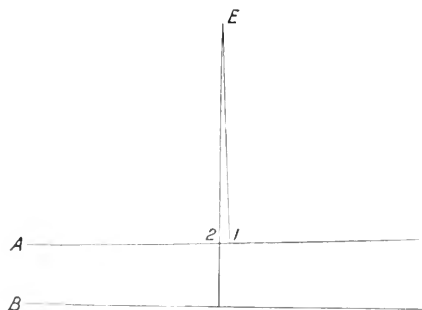

FIG. 155.

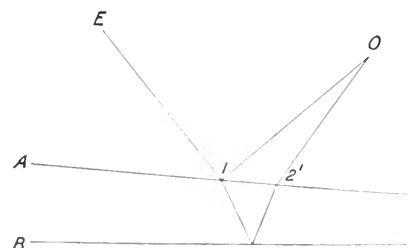

FIG. 156.

being refracted to 1° in the glass, is reflected at right angles from surface B. If this mirror is revolved in the plane of A, of course No. 1 image will remain still, and No. 2 and subsequent images will revolve with the mirror round No. 1. If we exaggerate the wedge shape of our mirror, we can see that at a particular angle these images can be made to superimpose. In fig. 156 let the signs be as before, and the images whose rays pass respectively from O to 1 and 2^1 will be reflected to E as one image. The images vary in size owing to the various distances. No. 2 is the brightest except at great obliquity.

In practice we find that these images may be obviated by rotating the mirror in its cell until a certain point is reached where all the images will be superimposed. All mirrors should be so mounted as to admit of this rotation.

The present Editor is greatly in favour of the employment of a rectangular

prism cut with care and precision. We get by this means total reflexion and no double reflexions; and he believes that finer images can be obtained by its means than with the plane mirror. It may be mounted in the place of the plane mirror—that is to say, the concave mirror may be as usual in its cell—and in the other cell, which would have received the plane mirror, the rectangular prism may be mounted and be capable of rotation as the plane mirror would have been.

It should, however, be noted that this applies only when the

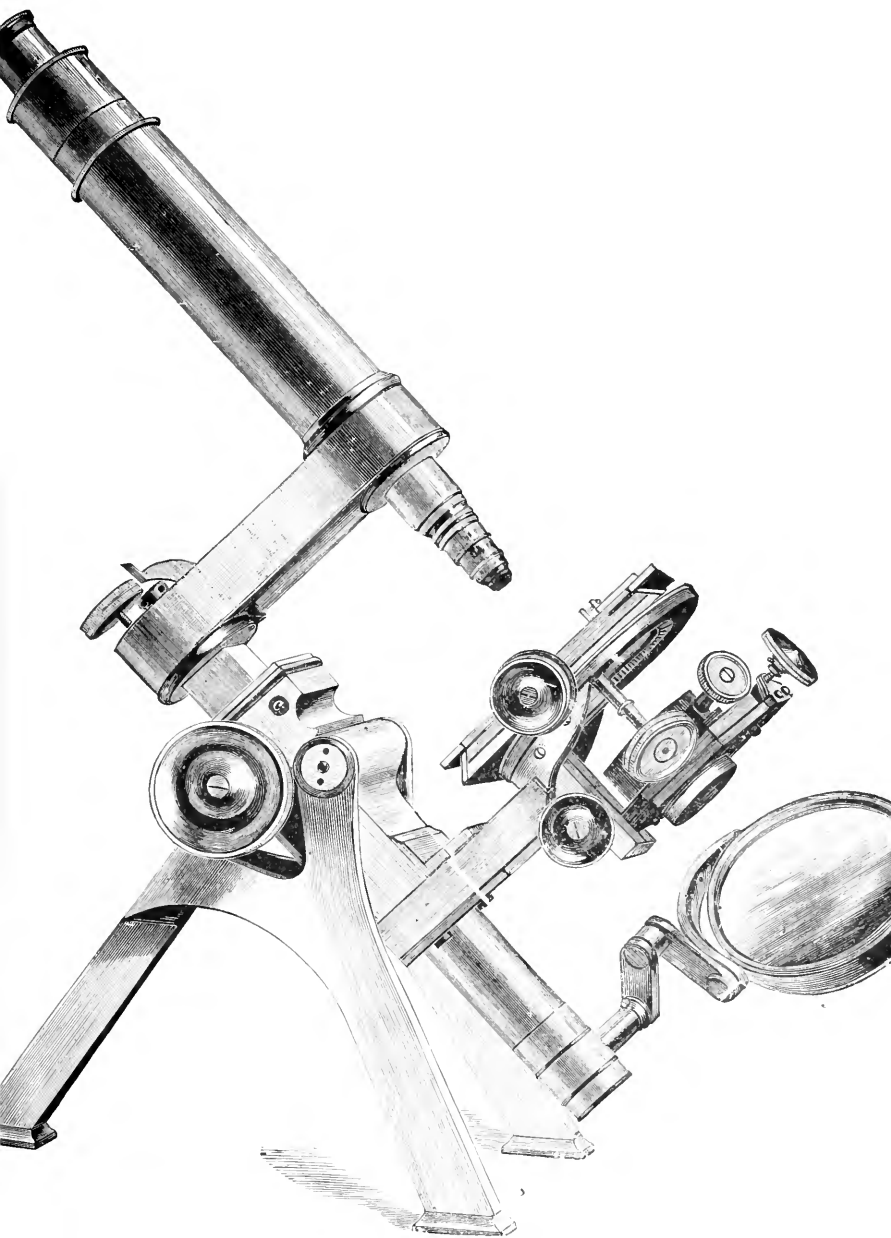

FIG. 157.—Powell and Lealand's No. 1 stand (1872)

light is required to be reflected at an exact right angle. It is of the greatest service when the microscope is of necessity used in a rigidly upright position.

If it be used for angles other than right angles, there will be refraction as well as reflexion; and as the necessary decomposition of the light into a spectrum will accompany the refraction, care must be exercised to see that the rays emerging from the prism are at right angles to those incident to it, and that the areas of the square faces of the prism are sufficiently large to have inscribed within them a circle equal to the back lens of any condenser used.

Some employ what has been known as a '*white cloud illuminator*,' that is, a disc of plaster of Paris, or opal glass with a polished surface. But a disc of finely ground glass dropped into the diaphragm-holder of the condenser will give a precisely similar result.

Mr. A. Michael has, however, pointed out the curious fact that an *opalescent mirror* becomes an inexpensive and excellent substitute for a *polarising prism*.

Typical Modern Microscopes.—We are now in a position to carefully inspect the characteristics of the chief forms of microscope which the modern manufacturers of England, the Continent, and America offer to the microscopist.

We confine ourselves to the chief models, indicating more or less suggestively their merits or defects. We neither discuss all the instruments of any maker nor in every case even one instrument of some makers. This would involve simple repetition in the main features. The reader can compare for himself the microscope of any given maker from whose catalogue he proposes to select, and can discover by comparison *its incidence or otherwise with the type given here* to which it corresponds.

Beginning with the highest types we place first on the list *Powell and Lealand's No. 1*. This instrument may claim a seniority over all the foremost instruments, because for nearly fifty years it has practically remained the same. All its principal features were brought to their present perfection nearly fifty years ago, while all other microscopes during this period have been redesigned and materially altered over and over again. This is no small commendation, for during that period, as the reader so well knows, the apertures of objectives have been enormously enlarged, and with this has come a great increase of focal sensibility. As a result the majority of the microscopes of forty years ago are absolutely useless for the objectives of to-day, but the focussing and stage movements of Powell and Lealand's microscope still hold the first place.

Fig. 157 represents the instrument in its monocular form. The foot of the stand is a tripod in one casting; it has an extended base of 7×9 inches, forming at once the steadiest and the lightest foot of any existing microscope. The feet are plugged with cork, and when the body is in a horizontal position the optic axis is (as it should be) 10 inches from the table.

The coarse adjustment is effected by a bar, consisting of a massive gun metal truncated prism in form, which bears only on a narrow part at the angles. It extends sufficiently to focus a

4-inch objective. The arm which carries the body is of unusual length for the type it represents; but this gives a large radius from the optic centre of the instrument, and makes the complete rotation of the stage easy. Great efforts have been made to accomplish this in other instruments. The older Ross form from the shortness of the arm only allowed of a two-thirds rotation, and in the Lister model many different devices have been tried, the latest being the placing of the stage pinions in a vertical position above the stage, which is an unquestionable error.

The rotation of the stage in the Powell and Lealand model is by means of a milled head most conveniently placed, and the divided circle is on a plate of silver.¹ It will also rapidly rotate by hand.

The arm is on a pivot, which allows it to be turned away from the stage altogether, and, as we have already indicated, the length of the arm lent itself to the use of a longer lever for the fine adjustment (p. 174). The milled head is placed behind the strong pivot of the arm, where vibration is impossible, and it is in an easy and natural position for the access of either hand.

The body may be, with great ease, *entirely removed from the arm*; this makes the use of the binocular or monocular body or of a short or long body a matter of choice, while it gives access for cleaning and other purposes to the nose-piece tube, as well as for the insertion and focussing of the lens used with an apertometer,² or an analysing prism. So also it is of service in low-power photo-micrography.

We have already referred to the stage of this instrument; but it may be briefly stated that it is large, has complete rotation, it has one inch of rectangular motion, being graduated to the $\frac{1}{100}$ th inch for a finder. There is *the same speed* in the vertical and the lateral movements, and the pinions do not alter their positions. The aperture of the stage is amply large.

The ledge of the stage has a stop placed on its left-hand side; this is held by a screw, but is removable at pleasure. Two massive brackets under the stage remove all possibility of *flexure*.

The sub-stage has rectangular movements by screw in either direction, as well as a rotary movement by pinion. The coarse adjustment is by rackwork, and a *fine adjustment* is added when desired. Fig. 158 illustrates this stage, showing its under side in order to enable the fine adjustment to be seen.

The vertical and upper horizontal milled heads are centring screws, acting at right angles to each other, while the diagonal screw to the left is the milled head, which causes the stage to rotate, the whole acting with great smoothness and accuracy, also enabling the operator to centre with complete precision, while, as we have already seen (pp. 187 and 196), the milled head A works by an advancing cone the fine adjustment to this stage.

The mirror is plane and concave, with double-jointed arm.

The finish and workmanship of this instrument are of the highest order. The seen and the unseen receive equally scrupulous care.

¹ This is now made of platinum if desired, and thus tarnish is obviated.

² Chapter V, p. 337.

The present Editor has had one of these microscopes in constant, and often prolonged and continuous, use for over twenty years, and the most delicate work can be done with it to-day. It is nowhere defective, and the instrument has only once been 'tightened up' in some parts. Even in such small details as the springing of the sliding clip—the very best clip that can be used—the pivots of the mirror, and the carefully *springed* conditions of all cylinders intended to receive apparatus, all are done with care and conscientiousness.

An instrument of this kind may be made to appear perfect to the eye, but at the same time may lack some most important elements as a finished instrument. But this is an instrument of the highest order as such, and at the same time a very fine specimen of highly finished brass work.

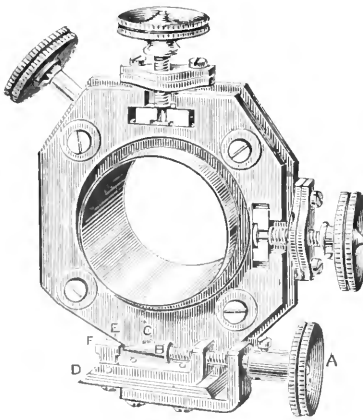

FIG. 158.—Powell and Lealand's sub-stage with fine adjustment (1882).

A note must be made before leaving this microscope upon the size of the tubes in the body and the sub-stage.

Powell and Lealand were the only makers whose gauge of tubing had a *raison d'être*; the size of the tube was such that it would take in a binocular body a Huyghenian 2-inch eye-piece, having the largest field-glass possible. The size of this field-glass depends on two factors.

1. The distance between the centres of the eyes.
2. The mechanical tube-length.

In order that the binocular may suit persons with 'narrow centres' to their eyes, the distance between them should not be greater than $2\frac{1}{2}$ inches. The mechanical tube-length is $8\frac{3}{4}$ inches for the standard tube. When the eye-pieces were 'home' in their places in the tubes they just touched each other, the inner sides of the binocular tubes being cut away; so under the above conditions a larger field than is thus obtained is simply impossible. The size of the field-glass determines the size of the eye-piece, and that was made to fix the diameter of the body-tube.

Very wisely these makers made the tube of the sub-stage the same size, so as to have one gauge of tubing throughout. This allows a Kellner or other eye-piece to be used as a condenser, thus reducing the number of adapters.

Lately this firm have altered their sub-stage tube to a gauge recommended by the Royal Microscopical Society. This involves an adapter where the sub-stage apparatus was adapted to the old gauge, or when an eye-piece is used as a condenser; as the size is too large for a binocular.

The Ross model, in its completest form as left by Andrew Ross,

except specially ordered is never made by this firm, but for its qualities and historical relations it is of much interest. It was

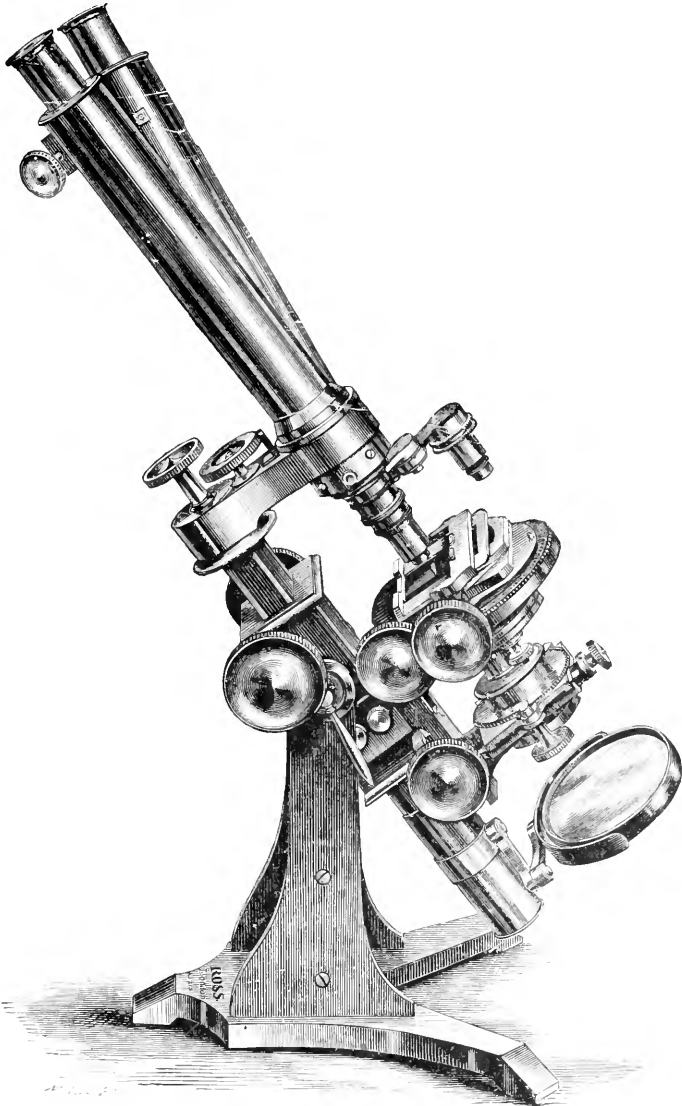

FIG. 159.—The model by T. Ross (1862).

very similar to the model by T. Ross shown in fig. 159. A. Ross's first model had a triangular bar, was monocular, possessed no proper sub-stage, the condenser was attached to the main stage,

which was without arrangement for rotation; and the mirror was not jointed. The model of T. Ross had, as will be seen, a bar movement, with a foot formed of a triangular plate to which were bolted two parallel upright plates to carry the trunnions of the microscope. The fine adjustment is a lever of the second order, with the milled head in the middle of the bar, which involves tremor, and the tube of the nose-piece is short, making shake possible.

The stage movements are of unequal speed, the lateral movement being slower than the vertical. There is no finder, and the

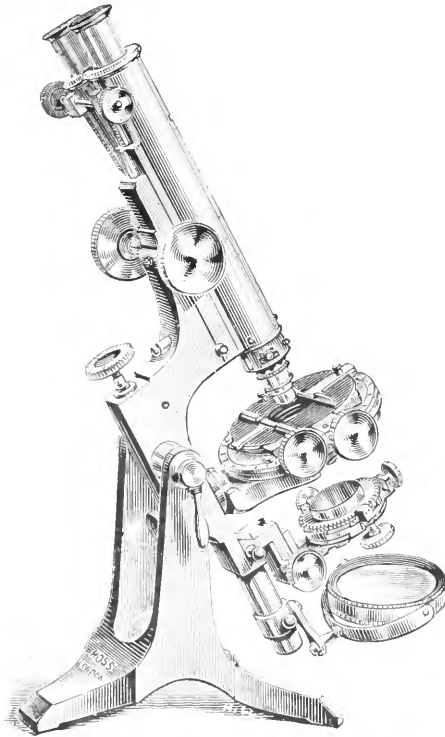

FIG. 160.—Ross-Zentmayer model (1878). 309

rotation of the stage is but partial. The sub-stage and mirror are good. It was a commanding instrument in its day, and was of excellent workmanship and finish; but it was not equal to the strain of critical work with immersion objectives of great aperture. Nevertheless the defects of this stand could have been readily corrected. With a more extended base, a better arrangement of the fine adjustment, a mechanical stage constructed on better principles, and the rotation made complete and concentric—which it was not—this would have been, even for our present requirements, an admirable instrument.

This important firm were otherwise advised, however; and, instead of correcting the errors of the instrument whose

history they had made, they designed an *entirely new model* in which a Lister limb was substituted for the bar movement. Fig. 160 illustrates this form of the instrument, from which it will be seen that the foot also was changed for the worse; the base was not sufficiently extended, and the hinder part of the foot was too large, so that it sometimes rocked on *four* points, because the hinder part was too wide—a flat surface, in fact. A true tripod will stand firm on an uneven table, but this form will not. It is a form frequently used by various makers now, and is known as the ‘bent claw.’ It is a bad design, and may be, as it has been, easily thrown over laterally. It

was, however, eventually cast in one piece, which gave it a solidity which the former did not possess.

The introduction of the Lister limb brought its inevitable troubles—notably, with the fine adjustment—to which we have fully referred under that head. But in the Ross-Zentmayer model, a later form, the body and the coarse adjustment were both carried by the fine-adjustment lever and screw.

This form could not—as it did not—long prevail. Its existence was ephemeral, and in its place was put a modification of the form devised by Zentmayer, known subsequently as the Ross-Zentmayer model. This was the Ross-Jackson instrument with a ‘swinging sub-stage.’ This instrument is illustrated in fig. 161. It will be seen that the foot is a true tripod, consisting of a triangular base with two pillars rising from a cross-piece, which carried the trunnions.

Here it may be as well to point out the differences which exist between the three great types of microscope, viz. the bar movement, the Lister limb, and the Jackson limb. In the bar movement we find a transverse bar uniting the lower end of the body to the coarse adjustment bar (figs. 157, 159). In the Lister the body is supported through a greater or less portion of its entire length, the limb being formed of one solid casting (figs. 160, 161, 162, 167). In the Jackson the dovetailed groove which carries the sub-stage slide is included in the casting, and the groove for the coarse adjustment of the body, as well as that for the sub-stage, is ploughed in one cut (fig. 165). Jackson also designed the double pillar foot (fig. 161).

We have already assessed the value of a swinging sub-stage and found that in our judgment it is at best redundant and really adverse to the accomplishment of the best scientific work.¹ No microscope is complete without a good condenser: all and much more than all that can be done by a swinging sub-stage can be done with a slotted stop at the back of the condenser. This elaborate appendage is therefore without justification. Yet in the impatience for large illuminating apertures, *which were not at that time provided by condensers*, this phase of pseudo-illumination was carried to a still greater and more elaborate development in the production of a *concentric microscope*. This was a Ross-Wenham, known as the *radial microscope*. But elaborate and costly as it was it never justified its existence, and like the whole group of ‘concentric’ and ‘radial’ microscopes, it has passed away simultaneously with the abolition of ‘oblique illumination,’ and is to-day a not very interesting curiosity in the history of the modern microscope.

A large and extremely well-finished stand is made by Messrs. Watson, known as the Van Heurck microscope in its best form: it is illustrated in fig. 162. The body has two draw tubes, one of which is actuated by rack and pinion, and the other sliding inside it so that a range of body length varying from 142 mm. to 300 mm. can be obtained. The coarse and fine adjustments have very wide bearings, and the exact relationship of the pinion to the rackwork

¹ P. 188 *et seq.*

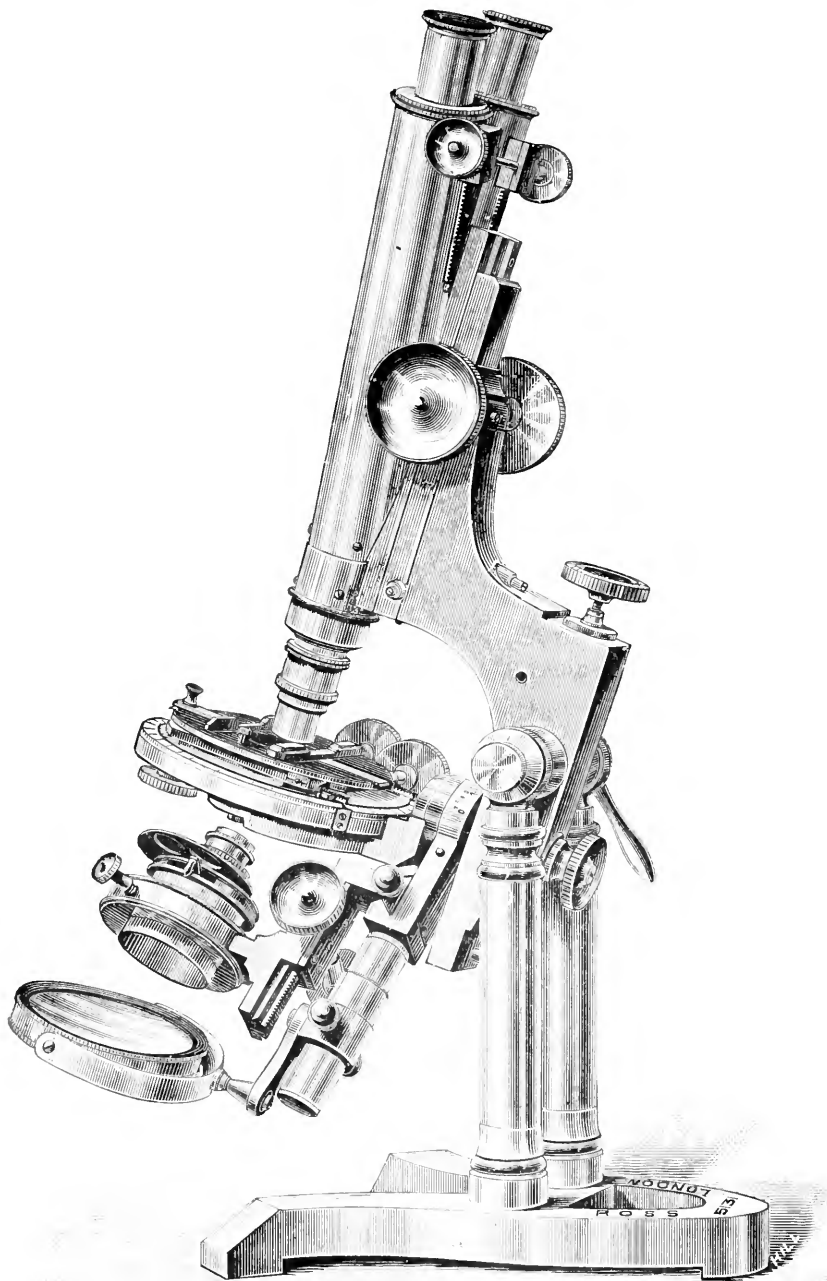

FIG. 161 (1878).

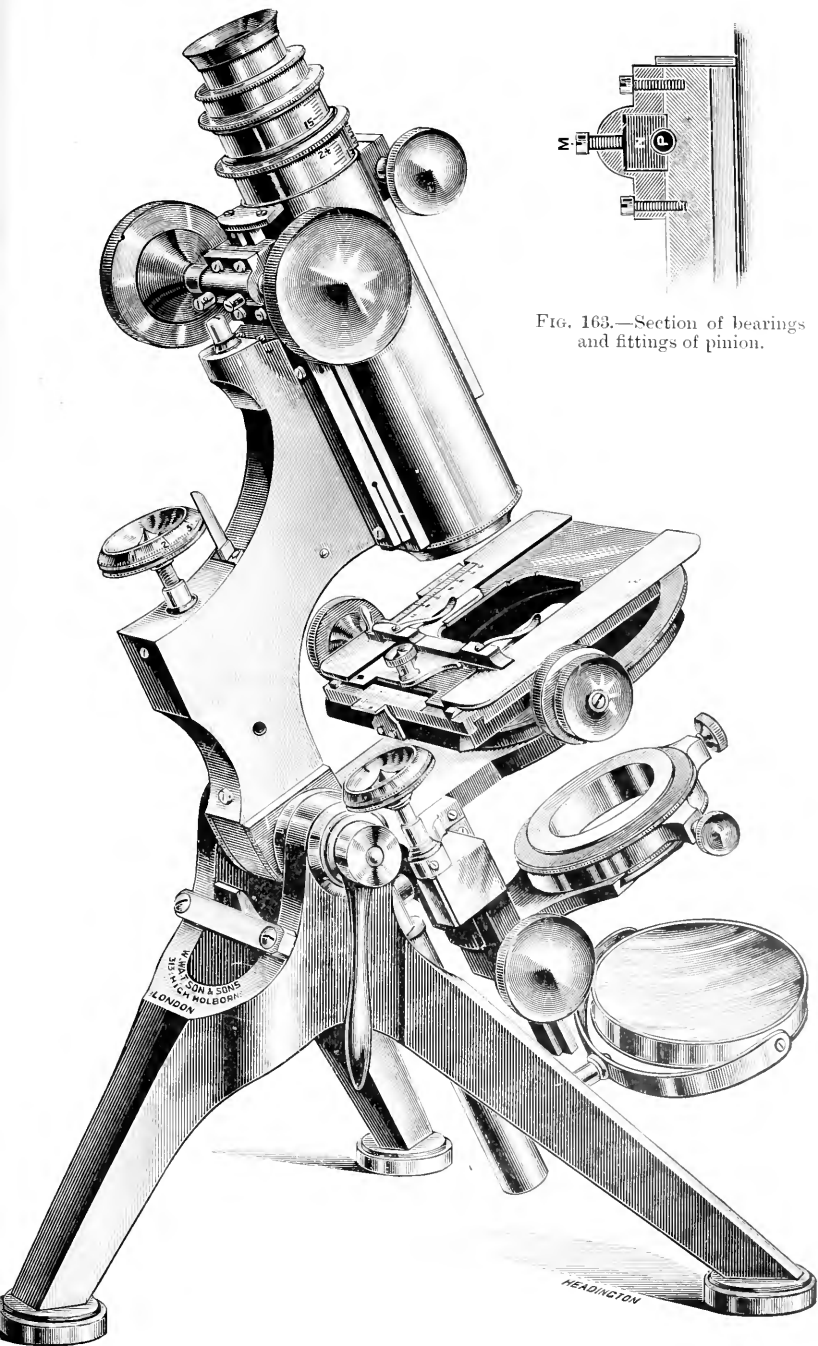

FIG. 163.—Section of bearings and fittings of pinion.

FIG. 162.—The grand model Van Heurck. Watson and Sons (1895).

is established by means of a block of metal which fits upon the pinion shaft and is pressed or released by means of the two screws provided for the purpose. This is shown in section in fig. 163, where the pinion is P, the anti-friction block X, and one of the adjusting screws M. The perspective view of the coarse adjustment showing the adjusting screws is given in fig. 164.

The stage can be completely rotated and has mechanical movements on the Turrell principle, both milled heads being on one axis. The sub-stage has a fine adjustment, and the plane mirror is carefully worked by hand, while exceptional rigidity for the whole stand is obtained by a special system of construction, and the tripod, which is shod with cork, has a spread of ten inches.

A high-class stand of distinguished merit is made by the firm of Baker of Holborn. It is illustrated in fig. 165, is made with great

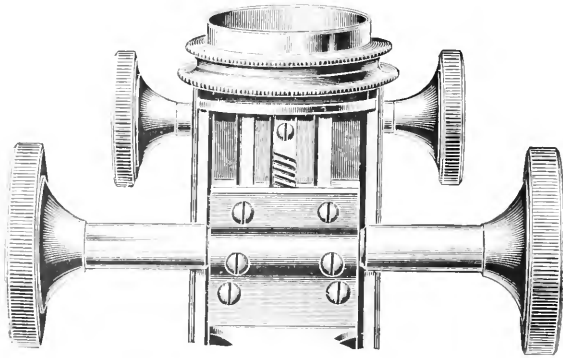

Fig. 164.—Complete view of Watson's coarse adjustment (1895).

care and is an instrument of precision. It is mounted on a solid tripod with slotted toes so that it can be firmly clamped to the baseboard of a photo-micrographic apparatus. The body is mounted on a massive limb in one piece throughout, and on to this the stage and sub-stage are mounted; in this way the chance of derangement of the optic axis is reduced to a minimum. The body has diagonal rack-and-pinion coarse adjustment actuated by very large milled heads, making a slow movement easy. The fine adjustment carries the body tube only each revolution of the graduated milled head, being equal to the $\frac{1}{2000}$ th of an inch; the Campbell differential screw being employed, and the milled head being placed at the lower end of the body. The body can be extended to 300 mm. and closed to 150 mm. The mechanical stage is worked on the Turrell method by stationary milled heads working on a common centre commanding oblique as well as rectangular movements; the rectangular movements on divided silver plates for recording positions; and complete rotation can be secured, either by hand or by rack and pinion, and can be at any point clamped.

The sub-stage has rectangular mechanical movements controlled

by fixed milled heads, and all fittings are sprung and have adjusting screws to compensate for wear, and fine adjustment by Campbell differential screw which Mr. Baker adopted for these microscopes in 1888.

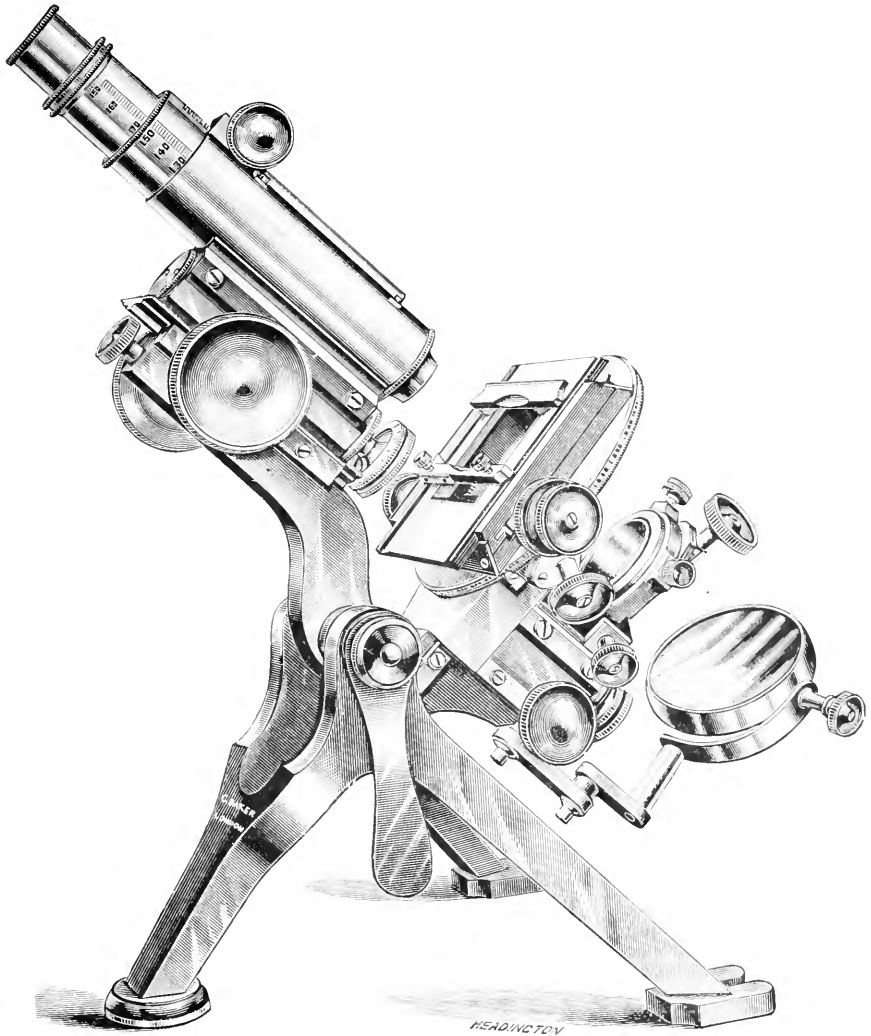

FIG. 165.— C. Baker's Model (1895).

Swift and Son formerly made two instruments of the first class, one having a bar movement similar to that of Andrew Ross, the other a Lister similar to Beck's. The principal difference was that the foot was of the 'bent claw' form. We have already seen that

by their invention of the vertical lever fine adjustment (figs. 133 and 135) Swift and Son have made possible a useful future for the Lister limb; and their model of this form is shown in fig. 166, known as the 'Best "Challenge" Microscope.' It has a beautifully made coarse adjustment, the special fine adjustment invented by this firm, a circular rotating stage moved by rack and pinion or by hand, and is provided with divided silver plates to the rectangular movement. The sub-stage is complete for centring as well as focussing, and has rotary movement for use with polariscope. The stand is a firm form of tripod, and the mirrors are well worked and mounted on a double crank.

All the movable parts of Swift's instruments are sprung on Powell and Lealand's method, and the movements are smooth and sound. Many stands had been devised by *American opticians* up to the time of the publication of our last edition of this work, but they were based upon one or other of the great English models, and the modifications, whether for good or evil, were adopted into the then modifications of the older English types, and were incidentally described. It should be remembered that Zentmayer, of Philadelphia, devised the model from which the Ross-Zentmayer was finally formed. Its principal feature was to obtain oblique illumination in one azimuth by the swinging stage which we have emphatically shown in this, as we did in the last edition, to be a pernicious adjunct for practical purposes. The fine adjustment of this instrument was most defective. Tolles, again, who wholly deserves the very high reputation he attained, made an instrument in which he mounted the stage on a disc; near the edge of this disc the sub-stage is made to travel in a groove carrying the condenser, or dry combination, in an arc round the object as a centre. This was only another elaboration of the same swinging sub-stage.

In later constructions of this form, Tolles first used the mechanical stage actuated by two pinions vertical to the *surface* of the stage, and subsequently adapted by Ross. The fine adjustment in this instrument had the fatal defects characteristic of its form.

Bulloch, another American maker of note, made some modifications in the Zentmayer model, but they were in the interests of the swinging sub-stage, and, although no doubt ingenious, must pass with this transient form of the microscope.

A modification of this stand was devised by Bulloch; it presents no special point, save the employment of a Gillett condenser with the diaphragm drum *above the lenses!*

A later development of this form of instrument by the same maker was made some years after, but the chief difference consists in the adoption of a stage in which the milled heads stand *upon* the stage, which is the reverse of an advance. Since, however, the swinging sub-stage form of instrument has been entirely superseded, American makers have adopted, with very slight modifications in form, none in principle, the Continental stand, which is made with admirable precision and conscientious care, but still retains its chief features. It may therefore be of service to consider the principal recent modifications of the Continental stand, so that they may be

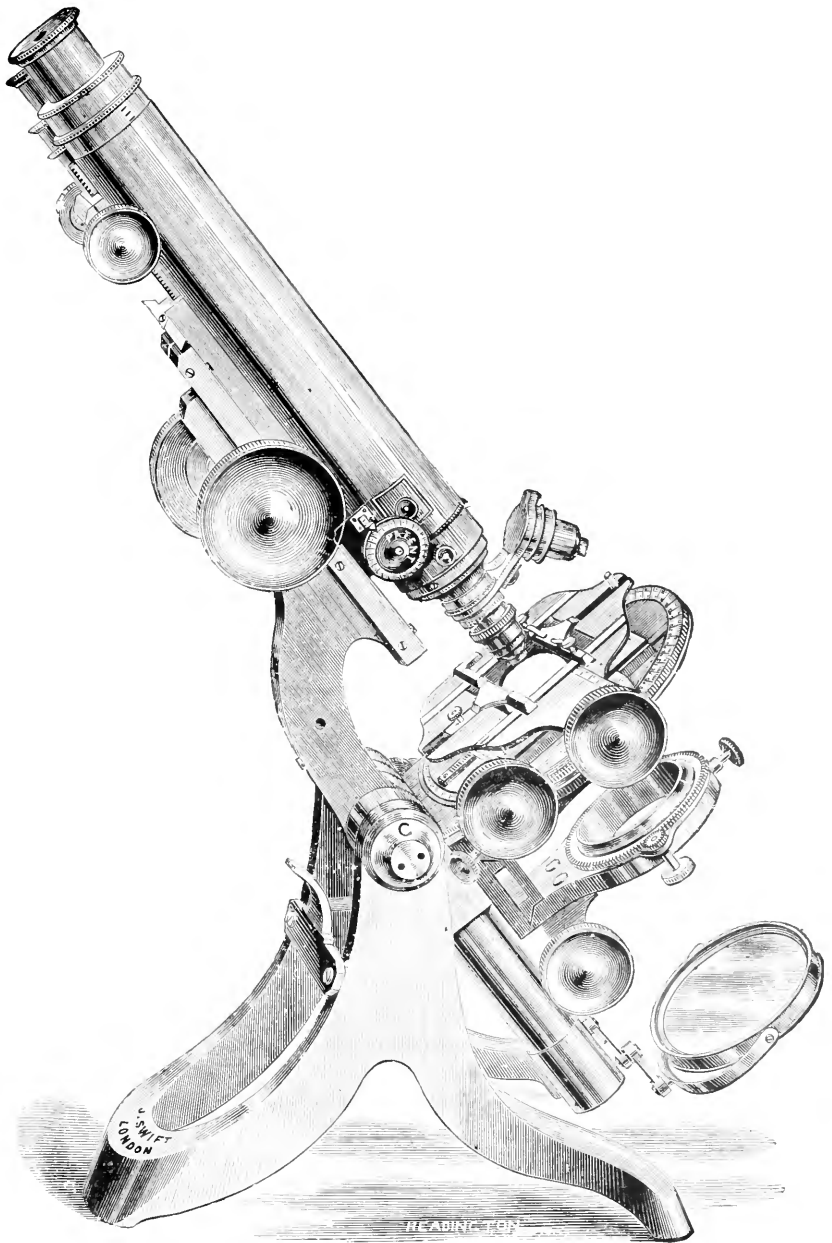

FIG. 166.—Swift's best challenge microscope (1881).

fairly compared with equally recent American adaptations of the same microscope; and then endeavour, after examining instruments of a lower class, to give a dispassionate estimate of this model as compared with that of the highest-class English type.

Amongst Continental makers the firm of Zeiss has taken a foremost position and has secured a well-deserved world-wide fame. Their largest microscope is shown in fig. 167. It is a model of fine workmanship and has been adapted with singular ingenuity to the reception of all their accessory apparatus. The upper body is inclinable from the vertical to the horizontal position. It is provided with coarse rack-and-pinion adjustment, and fine adjustment by means of a direct acting micrometer screw with divided head. The sub stage takes all the apparatus provided by this firm, and in addition it may, by means of a small lever, be swung out of its central position, 'so as to facilitate rapid transition to illumination with the cylinder-diaphragm,' while below the condenser is a movable iris diaphragm fitted with a rack-and-pinion movement to throw it out of the centre, and which can be rotated about the axis or entirely swung out.

The circular object stage rotates (not by rack and pinion), but has centring screws. The aperture in the stage has received a more oval form. The rack-and-pinion rectangular movements are $1\frac{1}{2}$ -in. vertical and 2-in. lateral; the milled heads are small but efficient and work smoothly. That for transverse movement being placed upon the top of the stage.

Reichert, of Vienna, makes a stand which in the main corresponds with that of Zeiss, and we are enabled to speak with confidence of the high quality of the workmanship; but in illustration we choose not the 1A stand but the large stand known as 11B, an illustration of which is given at fig. 168. Our object in choosing this instrument is that it combines every essential of the 1A stand, and in addition is furnished with the new lever fine adjustment, invented so recently by Reichert, and of whose value we have already given our judgment. It will be seen that on the part of the body which the fine adjustment milled head crowns there is a protrusion on the right and left hand side of the pillar. This is the only addition outwardly that the new fine adjustment makes needful.

A very high-class microscope is made by Leitz of Wetzlar, which, while it retains the principal features common to all microscopes based on the Continental model, has yet qualities peculiar to itself, and obtains by means of workmanship and ingenuity the most admirable results attainable from the model on which it is based. It is inclinable with a hinged joint and clamping lever; and the stage is provided with a revolving centring table. The mechanical stage is the 'attachable' one already described, and the adjustment of the objective is by rack and pinion coarse adjustment, and by a fine adjustment depending on a micrometer screw provided with a divided screw head. The draw tube is furnished with a millimetre scale. The sub stage is planned on the principle of the Zeiss instrument and will receive the illuminating apparatus as devised by Abbe, which is worked by rack-and-pinion adjustments, which

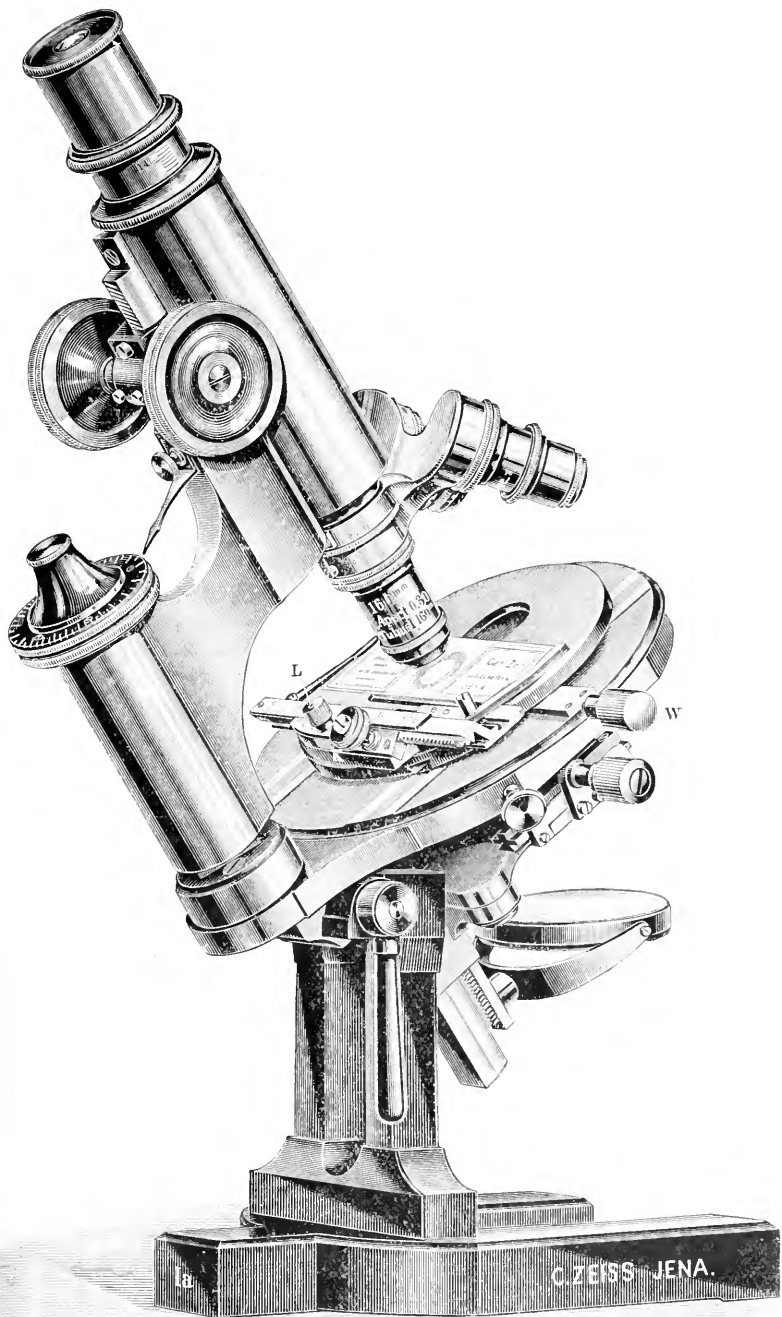

FIG. 167.—Zeiss's largest and complete stand 1895.

also raise and lower the iris diaphragm and provide it with possible oblique or eccentric movements; and it is furnished with objectives

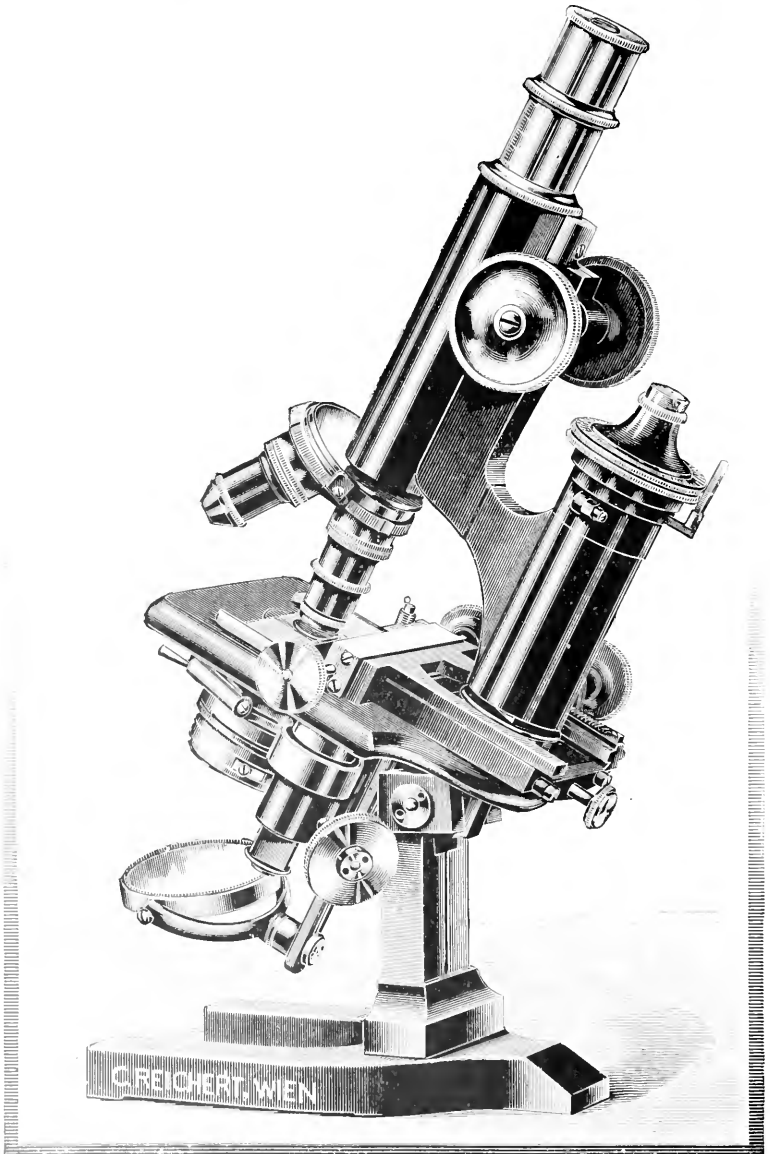

Fig. 168. One of Reichert's large stands (Hb) with new lever fine adjustment fitted (1899).

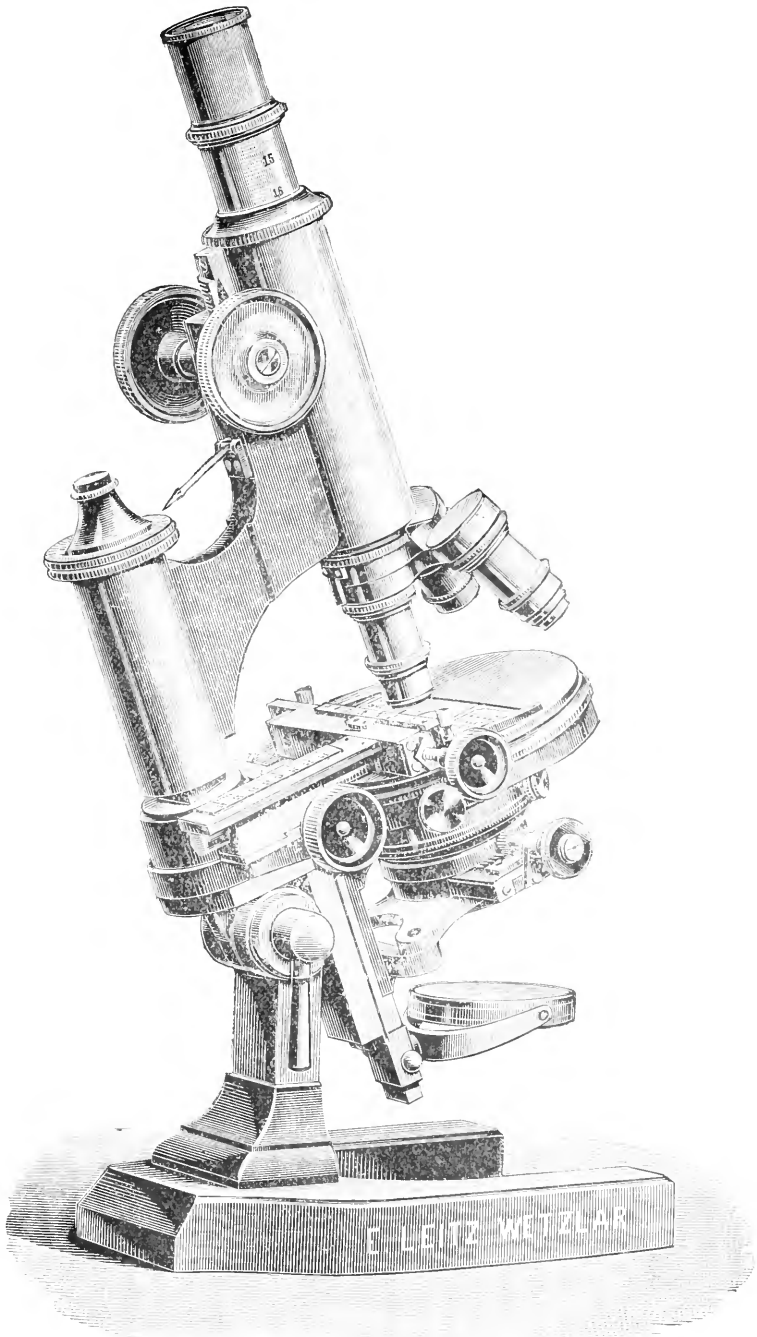

FIG. 169.—Leitz's most complete stand (1893).

and eye-pieces that give it magnifying powers ranging from 15 to 1,500 times. This instrument is shown in fig. 169, and with the two stands immediately preceding it furnishes us with a fair view of the principal and latest types of the Continental microscope fitted with the apparatus essential to the production of good work.

But another most interesting model of Reichert's has just been finished which, from its size and approximation to the English stand in some important points, we are constrained to notice as these sheets are passing through the press. The instrument is illustrated in fig. 169A. The height of the stand in the position illustrated is $16\frac{1}{2}$ in. The distance between the foot and the stage is $3\frac{1}{2}$ in. The sub-stage is provided with centring screws, and is raised and lowered by rack and pinion. The mirror can be readily moved towards or away from the sub-stage or can be entirely removed. The tube length with both tubes (A A') extended, including the nose-piece, is $10\frac{1}{2}$ in. The stage is mechanical, and the circle is divided into 360 degrees; both the horizontal and vertical motions of the stage have scales read by verniers. The object is fixed on the stage by spring fittings. The fine adjustment has two speeds of motion by two screws, the one 0.3 mm., the other 0.1 mm. per revolution, shown at M M'. The draw-tube has a divided scale and is moved by rack and pinion.

We may now with advantage consider the different *classes* of microscopes manufactured by the opticians of Europe and America. To do this without prejudice and with efficiency it is necessary to designate the characters which should distinguish each class.

Microscopes placed in Class I, possess—

1. Coarse and fine adjustments.
2. Concentric rotation of the stage
3. Mechanical stage.
4. Mechanical sub-stage.

Class II.

1. Coarse and fine adjustments.
2. Mechanical stage.
3. Mechanical sub-stage.

Class III.

1. Coarse and fine adjustments.
2. Plain stage.
3. Mechanical sub-stage.

Class IV.

1. Coarse and fine adjustments.
2. Plain stage.
3. Sub stage fitting (no sub-stage).

Class V.

1. Single adjustment (coarse or fine).
2. Plain stage.
3. With or without sub-stage fitting (no sub-stage).

This classification applies also to portable microscopes.

The recent microscopes of the best American makers are characterised by the highest quality of workmanship and abundant ingenuity, but the Continental model is confessedly made their founda-

tion. In the last edition of this work it was shown that American opticians made their first-class microscopes with swinging sub-stages, and we then pointed out that these were not only without value,

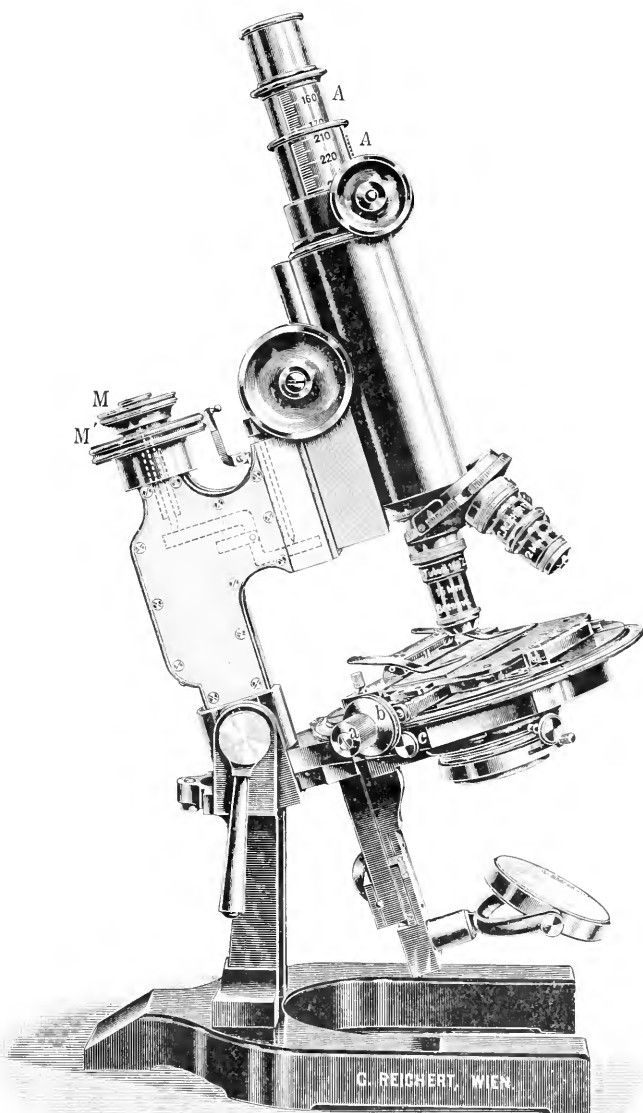
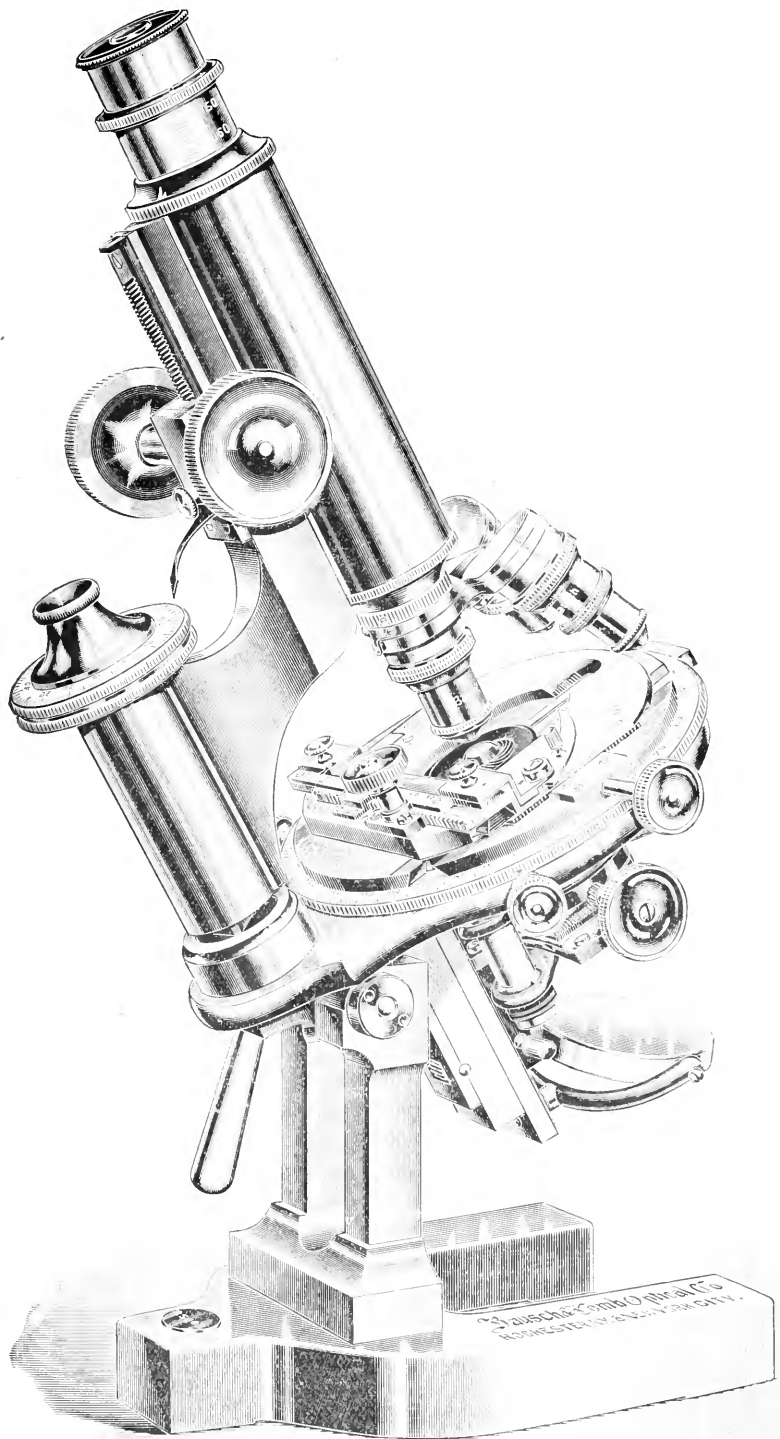

FIG. 169A (1900).

but injurious to the best work possible to a good instrument. In the interval the swinging sub-stage has been given up, even by its most ardent advocates; but at the same time in the majority of cases they have abandoned the sub-stage proper and adopted the Continental condenser fitting instead. In fact, the American opticians have chosen almost exclusively, as the basis of their stands of every class, the microscope that has been so long in vogue on the Continent of Europe.

It will suffice to take examples of the unexceptionally beautiful work of the two leading opticians of America—The Bausch and Lomb Optical Company and The Spencer Lens Company. An illustration of the best instrument, known as the 'Grand Model,' of the former of these opticians is given in fig. 170. It is designated a 'Continental Microscope,' but is not a mere copy of the best work of Germany or France. The body-tube is large, and the horseshoe base, of Continental fame, is said by the makers to be improved by the 'back claw' being prolonged 'so as to virtually form a tripod base,' and it is commended as 'extra heavy.' From the figure, however, it would appear to be the extra weight rather than a prolonged claw that imparts the steadiness. The body is supported on a pillar of two massive columns. The stage is large, and rotates with centring screws. 'The heads of the centring screws are provided with graduations and index, and with a series of lines recording the number of revolutions of the screw,' so that the position of any given object may be recorded and thus be referred to again if the microscope should have been used for other work in the interval. The mechanical stage is worked by one milled head at the side and the other at the top of the stage, the latter position (as we pointed out in the last edition of this book when referring to the Tolles mechanical stage) being one in which the efficiency of the mechanism is reduced to its lowest value. We have long advocated the adoption of Turrell milled heads as employed in Powell's No. 1 stand; they give the worker power to effect not only rectangular but diagonal movements, and, without displacing the fingers, to work the stage in all directions. We are pleased, as we have pointed out, to note that the eminent firm of Zeiss have adopted these in their best stand (fig. 139).

The sub-stage is composed of three parts, arranged one above the other. This sub-stage, with the parts separated to show their construction, is presented in fig. 171. The upper part is a ring carrying a removable iris diaphragm, so arranged as to come directly into contact with the under part of the object slide. The middle section of the sub-stage is movable vertically on the main sub-stage axis, and carries an Abbe condenser of 1.20 N.A., which can be swung laterally to the left of the instrument so as to put it out of optical use; but on the other hand it can at will be thrown back into position and placed in oil contact with the object slide without altering the position of the upper iris diaphragm. The third and lowest section of the sub-stage carries the large iris diaphragm used below the condenser. Thus it is clear that the whole can be used together, or any one of the three sections can be worked separately.



We note one admirable feature of the mechanical finish of the microscopes of this firm, which is, that they avoid sharp angles and knifelike edges to all their instruments. This looks a trifle, but the use of the microscope with saprophytic, pathogenic, or other infective material requires the utmost caution that the skin of the hands should be unbroken, and there can be but little doubt that all unconsciously the edges and corners of microscopes finished to the just pride of the mechanic do often break the skin, and are wisely

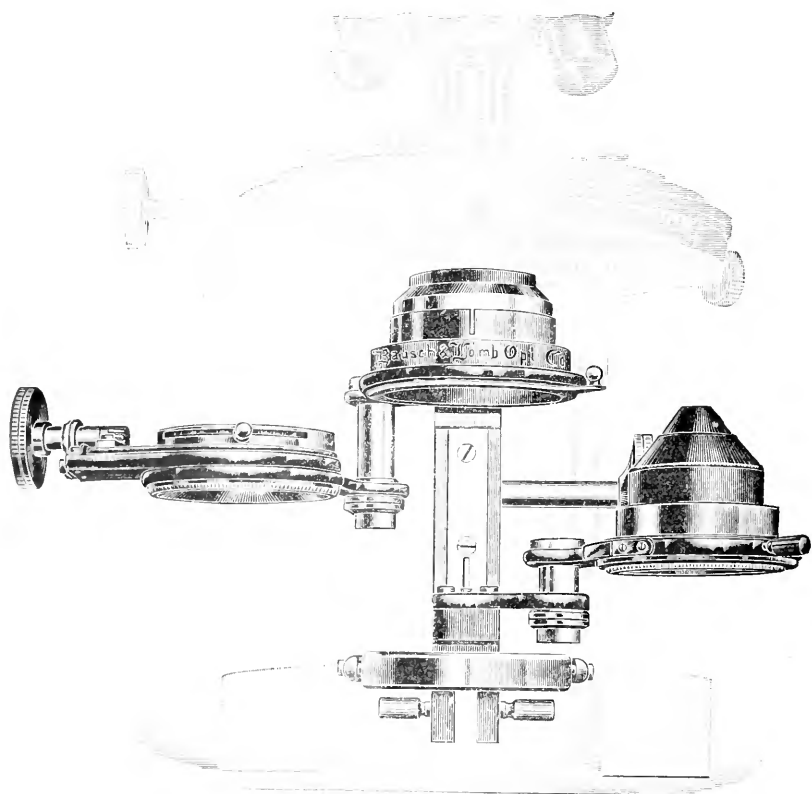
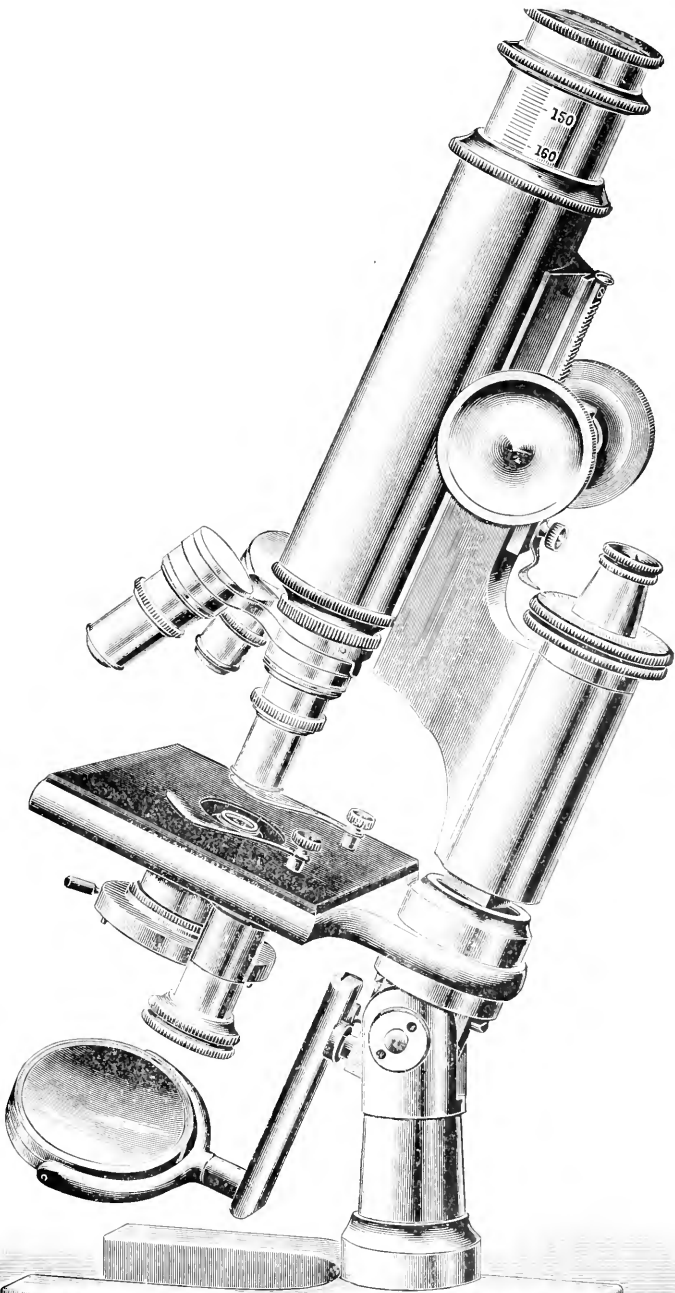

FIG. 171. —Bausch and Lomb's sub-stage, separated to show construction.

and happily worked into rounded edges in the instruments of these distinguished makers, and, we may add, without the slightest loss of that appearance of high finish which has always been correlative with the manufacture of microscopes.

If we now look at the No. 1 stand of the Spencer Lens Company, of Buffalo, N.Y., we shall find again that the model of Oberhauser is adhered to and the instrument is of the *third class*. This microscope is illustrated in fig. 172. It is beautifully made, and the horseshoe base has a still longer 'claw' than those of Bausch,



SPENCER LENS CO.
BUFFALO, N.Y. U.S.A.

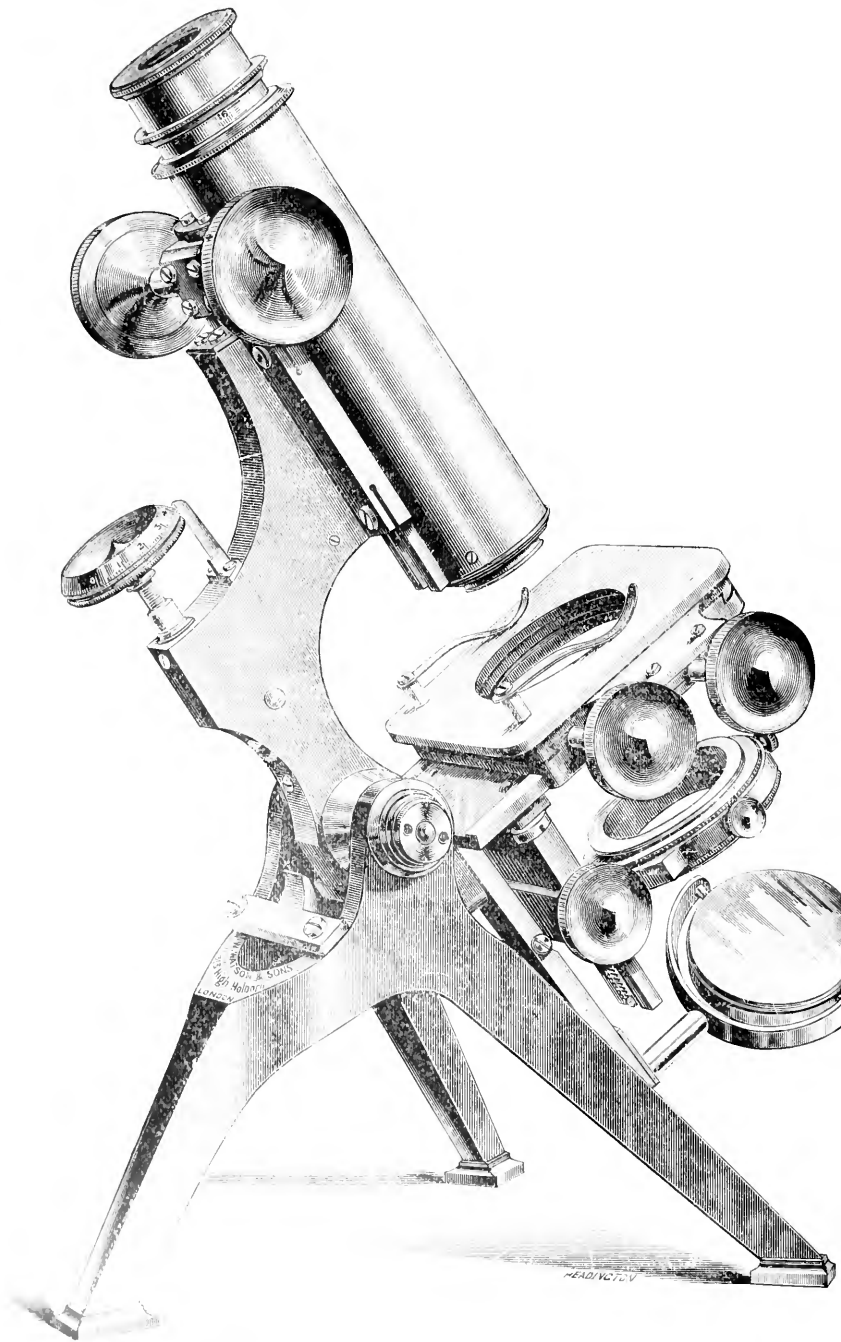

FIG. 173. WILSON'S Edinburgh Student's; stand 'H' with horseshoe foot 1889, with tripod foot 1893.

to give the stability required in utilising the hinged joint for inclination of the body, which stands on a strong unial pillar. The sub-stage is movable by a quick screw; in other features it resembles the majority of the microscopes of the type to which it belongs; it is, however, distinguished by rounded in contrast to sharp and pointed corners and edges; and, although the form presented has a plain stage with clips, it can be furnished with a circular revolving centring stage, or with an 'attachable' stage made by the Spencer Lens Company, having all the advantages of the several forms of these pieces of apparatus already described.

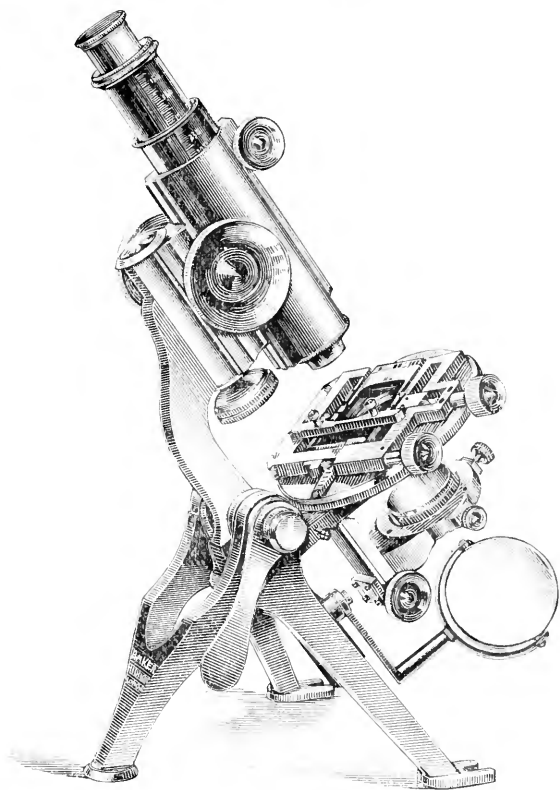

FIG. 174.—Baker's Model, No. 2 (1898).

We note with some surprise that such accomplished manufacturers and opticians have indicated, so far as we can discover, no advance in their sub-stage condenser beyond that of the now old achromatic of Abbe, and that there is no evidence before us of their employment of a sub-stage fine adjustment, both of which have been found of such great practical value in England, and which have been, as we shall shortly show, adopted for the more critical microscopical work by the Messrs. Zeiss, the leading optical firm of the Continent.

Second-class microscopes are made in great variety by English makers.

One of the finest examples of this class of microscope at present brought within the reach of the average student's means is that known as the 'Edinburgh Student's Microscope "H."' by the firm of Watson and Sons. It is the most complete of a series of similar stands varying in cost and completeness. It is illustrated in fig. 173, where it will be seen that it has the first prime requisite, a rigid foundation combined with lightness—a tripod having a spread of 7 inches—and it is also possessed of a well-constructed mechanical stage which is built with the instrument, an advantage over the best 'attachable' stage.

It is essentially a student's microscope, and although of so low a price is not only a specimen of the best workmanship, but is also extremely complete and represents an advanced type of construction capable of doing all ordinary and much experimental work.

Belonging to this class is an instrument by Baker known as his Model, No. 2. It is smaller than the 'A' stand of the same type and is simplified, but is capable of doing the most refined and critical work. It is illustrated in fig. 174. The coarse and fine adjustments are the same. The mechanical stage has rectangular movements of one inch; the Turrell arrangement is not adopted; but the whole stage can be rotated through an arc of 300° . The sub-stage has diagonal rack and pinion focussing movements with centring screws, and can be supplied with every improvement applying to the adjustment of the sub-stage. Taking this instrument as a whole—the thoroughly practical character of the model, the high quality of the workmanship, the fact that it will take all the optical apparatus of the best model, and that all fittings are sprung and possessed of adjusting screws to compensate for wear—we have in this microscope one of the very best of its class.

Powell and Lealand make an instrument of this class, having a *quality* of work not second even to their large stand. It is illustrated in fig. 175. The tube length is the same, but the stage and the foot are smaller than in the large instrument. There is no rotary movement to the sub-stage, and its centring is done by the crossing of sectors and not lines at right angles; but this is in no way a defect. All the movements and adjustments are otherwise as in No. 1.

Baker, of Holborn, makes a very admirable and useful instrument of this class known as his D.P.H. microscope, No. 1. It has a diagonal rack and pinion coarse movement, a micrometer screw and lever fine adjustment, giving a movement of $\frac{1}{2.25}$ of an inch for each revolution of the milled head; a draw-tube, every 10 mm. of which is engraved with a ring, extending to 250 mm. and closing to 150 mm., thus allowing the use of either English or Continental objectives; it possesses a mechanical stage giving a movement of 25 mm. in either direction, graduated to $\frac{1}{3}$ mm.; the milled head of the transverse motion is below the level of the top plate, and as the other is removable large culture plates can be examined, the distance from optic axis to limb ($2\frac{1}{2}$ in.) allowing of their easy manipulation; the

top plate is provided with three adjustable stops, so that the centre of a 3×1 or $3 \times 1\frac{1}{2}$ slip is identical with the optic axis when both the rectangular movements are at the centre of their travel, thus enabling any desired field to be recorded; the stage clips are

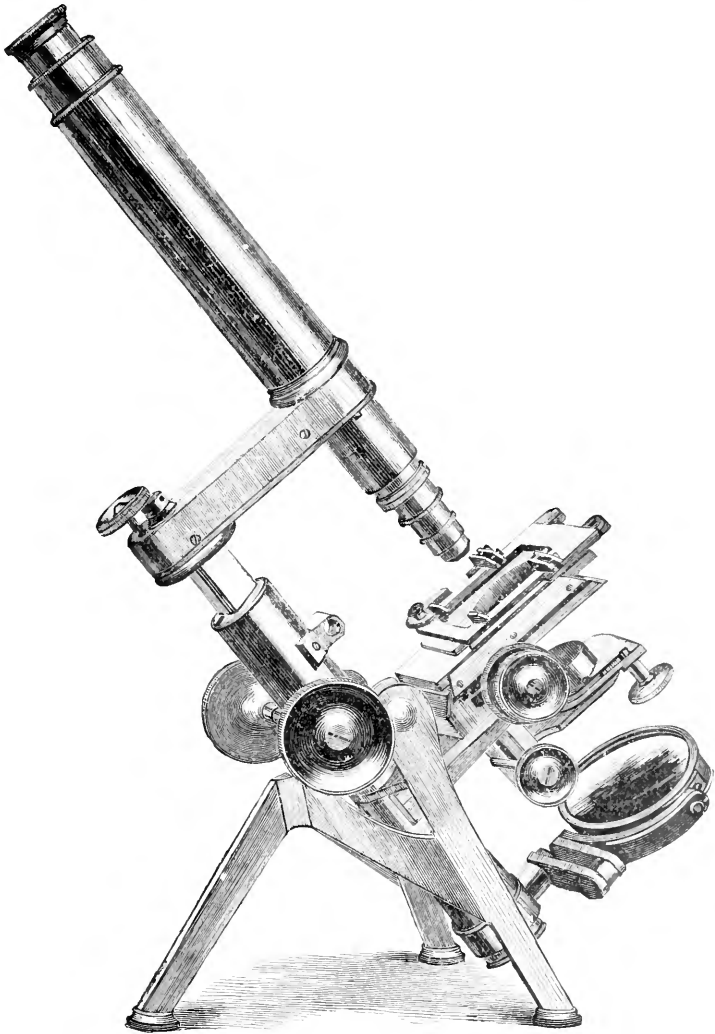

FIG. 175 (1852).

mounted on two of these stops, all of which are removable; a centring sub-stage of universal size (1.527 in.) with diagonal rack and pinion focussing adjustment, plane and concave mirrors; the whole mounted on a solid tripod stand, with a bracket to support the

instrument in a horizontal position for photo-micrographic work. The microscope is illustrated in fig. 176.

A modification of this instrument was brought out as these pages are passing through the press, which is entitled to rank as a first-class instrument. It is known as the R.M.S. 1.27 gauge microscope, and is illustrated in fig. 177. It has a diagonal rack and pinion coarse movement, and a micrometer screw and lever fine adjustment giving a movement of 0.11 mm. ($\frac{1}{90}$ in.) for each revolution of the screw, the milled head of which is divided into

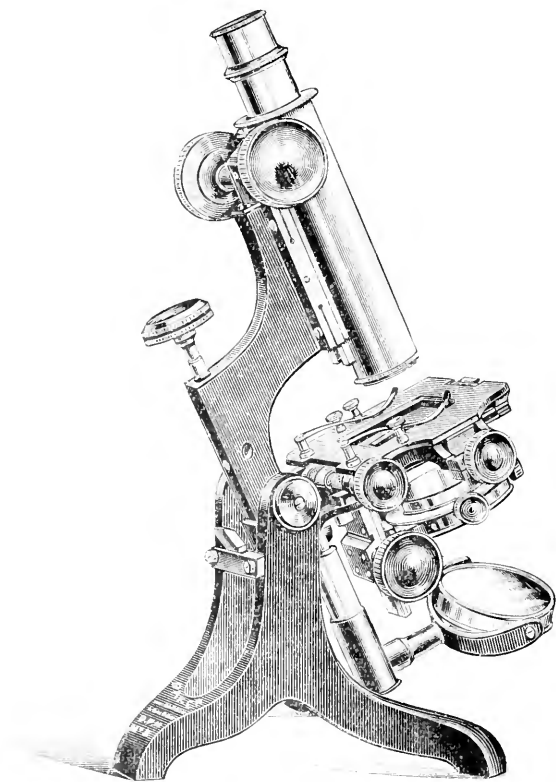

FIG. 176. Baker's D.P.H. stand No. 1 (1899).

ten parts, each division being numbered. It also possesses two draw-tubes engraved in mm., every tenth numbered, one of which is provided with rack and pinion adjustment, so that objectives may be corrected for the thickness of the cover glass, &c., by the alteration of the tube length; these draw tubes extend to 250 mm., and close to 120 mm., either English or Continental objectives can be used; this microscope has a rotating mechanical stage giving a movement of 25 mm. (1 in.) in either direction graduated to $\frac{1}{2}$ mm. ($\frac{1}{20}$ in.); the milled head of the transverse motion is below the level of the

top plate, and the other being removable a large flat stage becomes available if required; the top plate is provided with three stops, adjustable, so that the centre of a 76 mm. \times 25 mm. (3 in. \times 1 in.) or 76 mm. \times 38 mm. (3 in. \times 1½ in.) slip is identical with the optic axis when both the rectangular movements are at the centre of their travel, thus enabling any desired field to be recorded; the stage

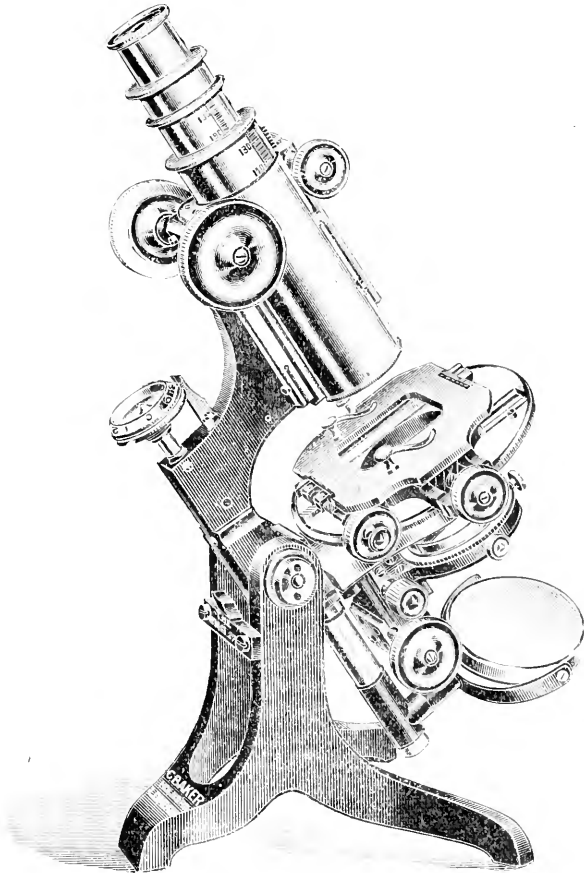

FIG. 177.—Baker's R.M.S. 1:27 gauge microscope (1900).

clips are mounted on two of these stops, all of which are removable. It has a centring sub-stage provided with diagonal rack and pinion focussing movement, and a fine adjustment, the milled head of which is so placed that both adjustments can be conveniently controlled without shifting the hand, and it is provided with plane and concave mirrors, and the microscope is mounted upon a solid tripod stand, with a bracket to support the instrument in a horizontal position for photo-micrographic work.

All the fittings are sprung and have adjusting screws to compensate for wear.

Coming now to **Third-class microscopes**, we note that the distinguished American firm, Bausch and Lomb, make a very useful instrument which must be placed in this class. It is intended as

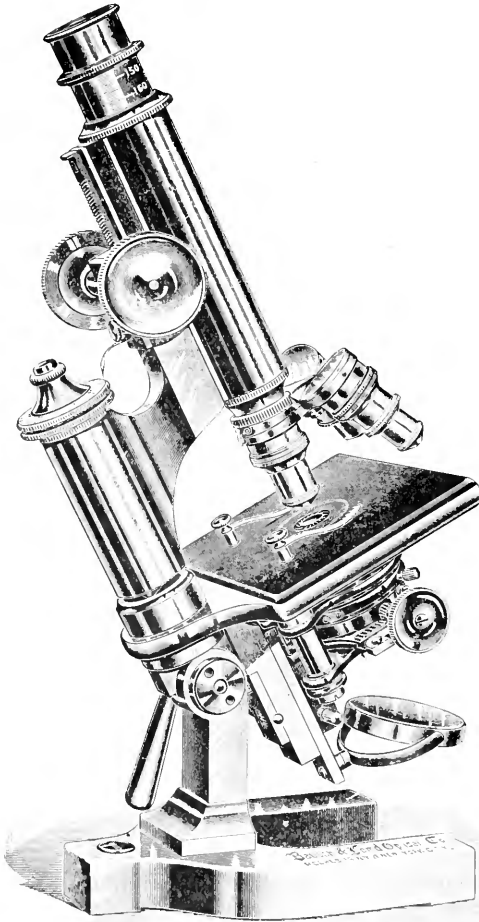

FIG. 178.—Bausch and Lomb's C.A.S. microscope (1897).

a high-class laboratory instrument for advanced work and for use in independent researches. It is designated by the firm as the C.A.S. It has a large stage, but in our judgment this would be greatly improved by being furnished with the horseshoe opening so valuable for hand focussing as a preliminary in the use of high powers and immersion lenses. Of course the mechanical stage of the

firm can be added. The sub-stage is the new and complete one of the makers, arranged for doing critical work; the fine adjustment

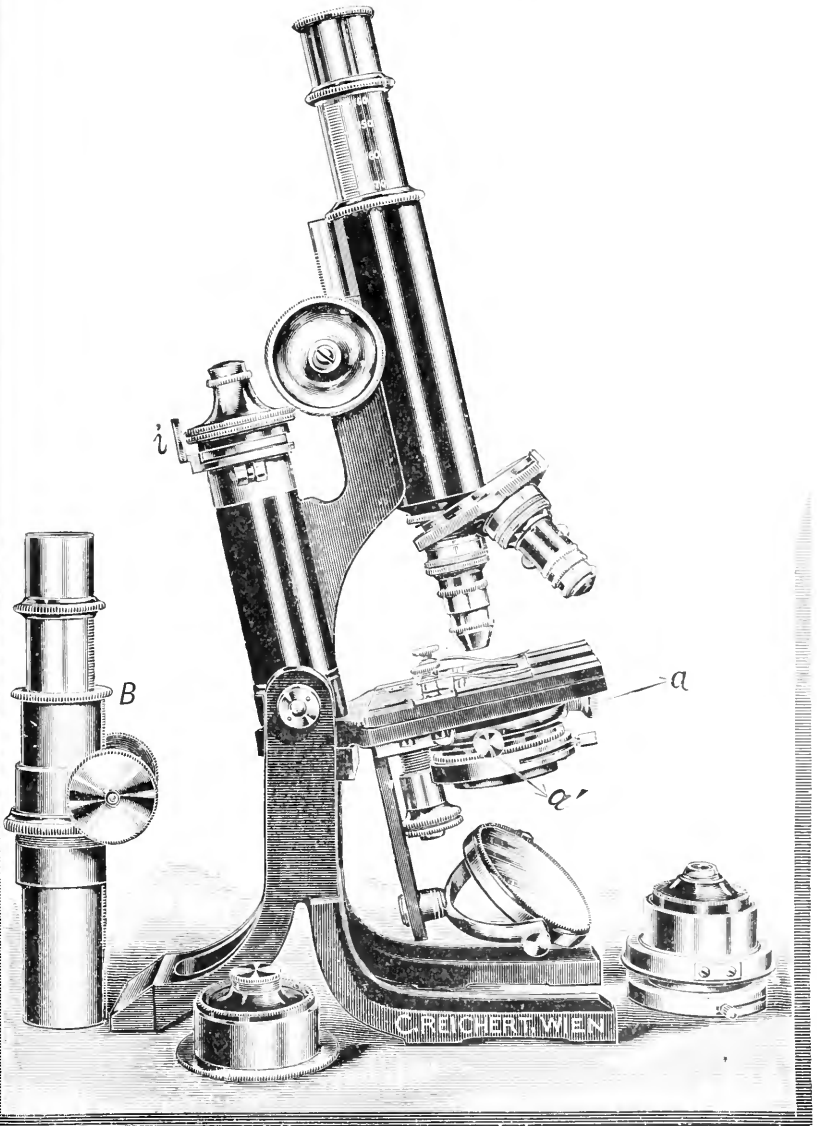

FIG. 178A.—Reichert's 'Austrian' Baugh stand 1899.

is by micrometer screw: the weight of the body is balanced, the makers tell us, by a spiral spring which, they believe, subjects the fine

micrometer screw only to the friction of the adjustment—and, of course, it is to be noted that the screw is not an extremely fine one; and the makers have evidence of the durability of the adjustment, as after five years of use they have had no single instance of its breakdown. The coarse adjustment is by diagonal rack and pinion; the draw-tube is graduated. It is beautifully made, and is by no means an expensive instrument. We illustrate it in fig. 178.

A well-made and remarkable little instrument of the class we are considering is manufactured by Reichert, of Vienna, known as the **Austrian** stand. It is illustrated in fig. 178A. It is the most modified of all the microscopes we know based on the Continental model; it certainly approximates in several points to the English type. It has a specially extended and steady horseshoe foot, and is the only strict Continental form with the axis so high up. The result is that the body is balanced when in a horizontal position. The coarse adjustment is by spiral rack and pinion with milled heads. The fine adjustment is Reichert's recent patent, giving extreme delicacy to the movement, and having a movable pointer, *i*, for reading divisions on the micrometer screw. It is provided with a double rack draw-tube shown at B, it carries the Abbe condenser in a sub-stage that focusses by a screw at the side, and centres by the screw-heads, *a*, *a'*. In its most complete form it is remarkably low-priced, and certainly will meet a demand, especially as the English method of compensation for wear and tear is adopted. This, indeed, is the case with all but the lowest-priced instruments of this maker, and we believe him to be the only Continental manufacturer who has adopted the sprung slots and screws so long used with success by English makers for compensating wear. We should have suggested slotting the edges of the stage for sliding the object-holder or ledge, but we learn from the maker that this is to be done in all future instruments; all but the smallest stands Reichert is willing to provide with English pattern sub-stages fitted with centring screws of the standard size, and condensers are mounted to suit these.

Another instrument of the same class and general designation, made by Messrs. Watson and Sons, and distinguished as 'G,' is shown in fig. 179. It is identical in build with the C model, but the stage is plain, and it has only a tube fitting for a sub-stage apparatus; the workmanship is of the same order, the movements as delicate and true, the adjustments as reliable, but the price is only one half that of the more complicated form.

Amongst the same class of instruments must be placed another by Messrs. Swift and Son. It is known as an 'Improved "Wale's" Microscope.'

Mr. George Wale, of America, devised in 1879 a plan of great merit for the stands of microscopes. The 'limb' which carries the body and the stage, instead of being swung by pivots—as ordinarily—on the two lateral supports (so that the balance of the microscope is greatly altered when it is much inclined), has a circular groove cut on either side, into which fits a circular ridge cast on the inner side of each support, as shown in fig. 180. The two supports, each

having its own fore-foot, are cast separately (in iron), so as to meet to form the hinder 'toe,' where they are held together by a strong pin; while by turning the milled head on the right support the two

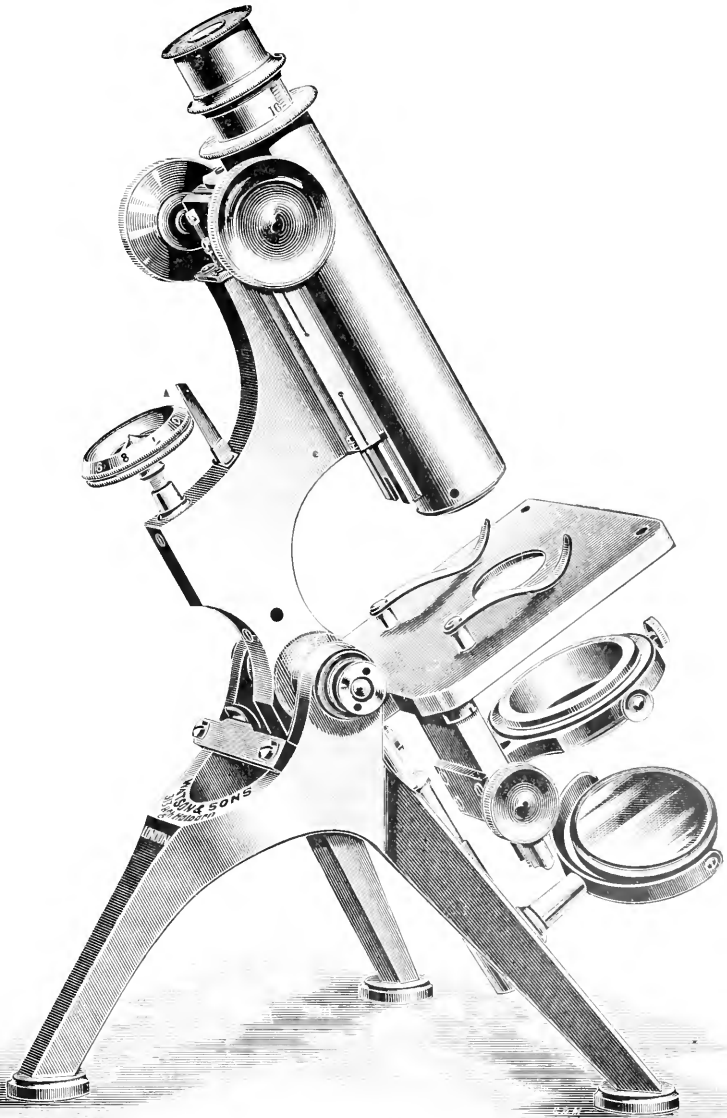

FIG. 179.—Watson's Edinburgh Student's; stand 'G' (1893).

are drawn together by a screw, which thus regulates the pressure made by the two ridges that work into the two grooves on the limb. When this pressure is moderate, nothing can be more satisfactory than either the smoothness of the inclining movement or the balancing of the instrument in all positions: while, by a slight

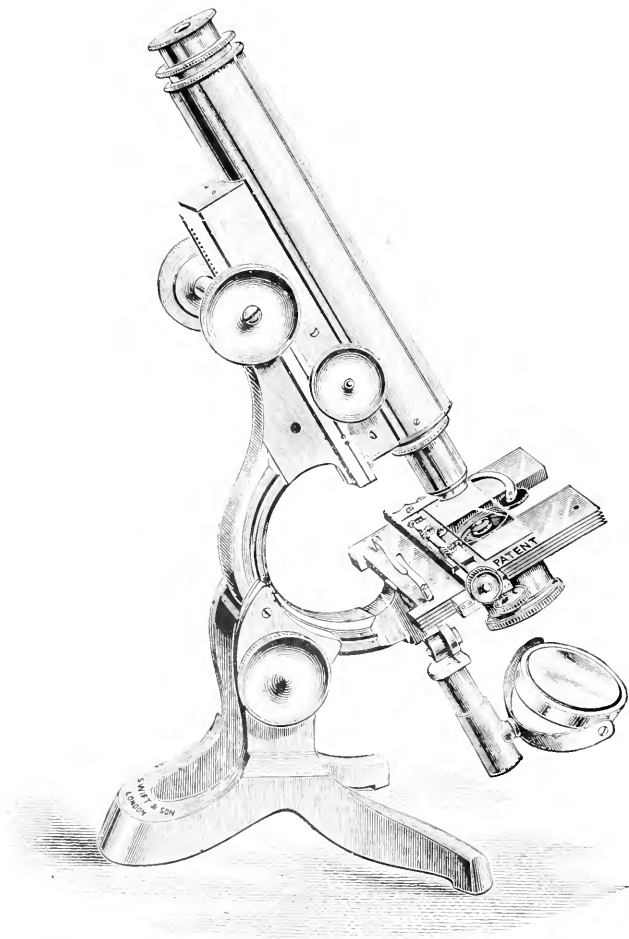

Fig. 180. Swift's improved 'Walsh's' microscope (1881 and 1883).

tightening of the screw, it can be firmly fixed either horizontally, vertically, or at any inclination. The 'coarse' adjustment is made by a smooth working rack; the fine adjustment is Swift's patent (described on p. 172 (fig. 135)), and the attachable mechanical stage of this form can be readily added (as in fig. 180), but in the best and

most complete form of the instrument a large mechanical stage is fitted, and sub-stage apparatus supplied.

Leitz, of Wetzlar, provides a very useful instrument of the same

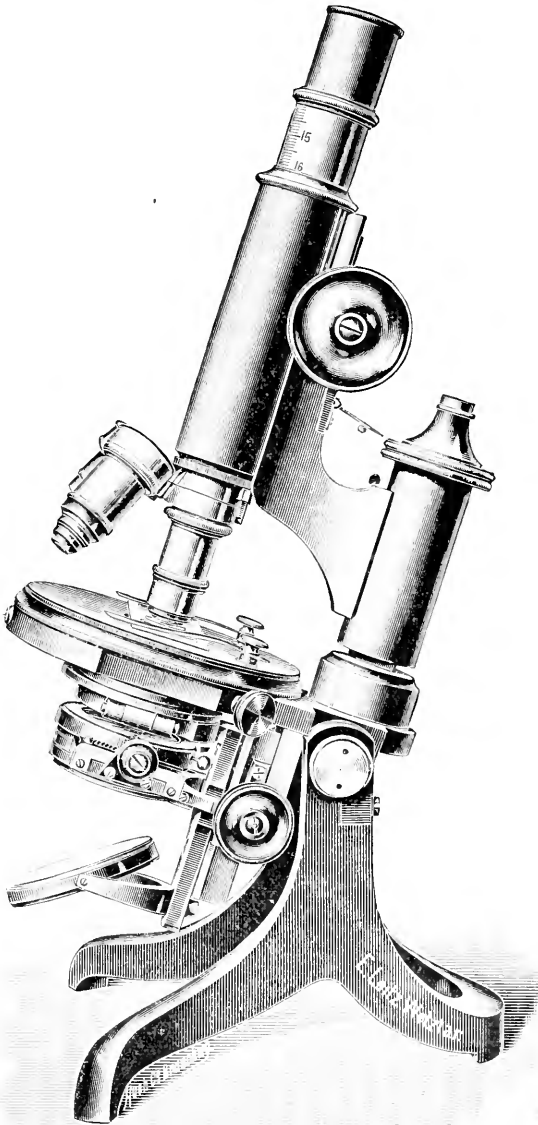

FIG. 181.—Leitz's 1A stand (1898).

class. It has a tripod base on the English model, and is a thoroughly steady instrument; it has rack and pinion movement to the coarse adjustment, and sub-stage; the draw-tube has a mm. scale, and a fine adjustment of the usual Continental type, and all the latest adaptations for sub-stage illumination. The instrument in its simplest form is remarkably low-priced, and the more important apparatus can be added to it as required. It is illustrated in fig. 181.

Beck's third-class microscope is shown in fig. 182. It has a good tripod foot with a single pillar. The Jackson model is used, but a peculiar fine adjustment is employed, the lever being placed below the stage, the position of the screw being immediately behind the pillar which supports the limb, and where it is easy of access. The body is not affected by vibration when it is touched. The lever is of the second order, and it draws down the body limb and coarse adjustment. In fact, save in its fine adjustment, this form approximates somewhat to the Continental model. The fine-adjustment lever is rather short, but it will be found to be much steadier and slower than the direct-acting screw.

The stage is plain, without mechanical movements; but it has a movable glass stage over the principal stage; to this the slip is clipped, and the whole super-stage of glass is moved with ease over a fair area. The aperture in the glass stage is not large enough; it should be cut right through to the front, which would much increase its usefulness.

This instrument also has a sub-stage with rack and centring movements.

Swift and Son's earlier third-class microscope in its most suitable form dates from about the time of the vertical lever fine adjustment patented by that firm (*q.c.*) It was first made from the designs of Mr. E. M. Nelson, and it presented three distinctive features:—

(1) The milled head of the fine adjustment was placed on the left hand side of the limb.

(2) The stage was of a horseshoe form, the aperture being entirely cut out to the front of the stage; and

(3) The body-tube, which was of standard size, viz. $8\frac{3}{4}$ inches, was made in two pieces, which not only secured portability, but also permitted the use of both long and short tubes.

This instrument is illustrated in fig. 135. It was also possessed of a cheaply made and fairly good centring sub-stage, to carry Powell and Lealand's dry-achromatic combination fitted with a turn-out rotary arm to carry stops. The sub-stage was made by adapting Swift's centring nose piece, and providing it with a rack and pinion focussing arrangement, as illustrated in fig. 183. There was also a graduated stage plate and sliding bar, a plan devised by Mr. Wright for a finder. The eye-pieces were provided with rings, like Powell and Lealand's, outside the tube to govern the depth which each should slide into the draw-tube, by which means the diaphragm is in the same place whatever the depth of the eye-piece employed, and it was constructed to do critical work with the highest powers.

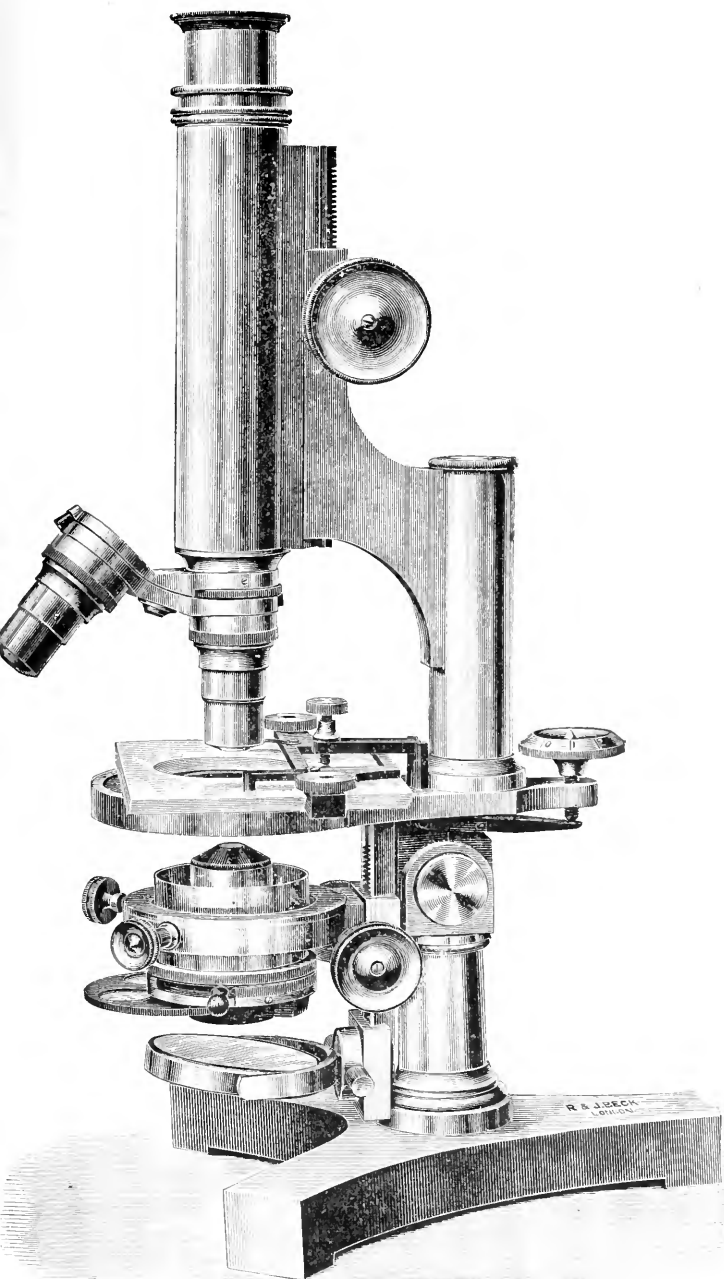

FIG. 182.—Messrs. R. and J. Beck's third-class microscope (1888).

Another form of this instrument has more recently been introduced by the firm of Chas. Baker, of Holborn, London. It arose in a suggestion by Mr. Nelson that this form should be adapted to the Campbell differential screw fine adjustment, making a good quality third-class microscope. It should be noted that the differential screw permits of slow action being obtained by means of coarse threads; it is therefore very strong. In the ordinary Continental form of direct-acting fine-adjustment screw, if the motion is slow, the thread *must* be fine. Hence in forms where the fine adjustment is made to lift the body, the differential screw is of great value.

Further, it proved on testing that the Campbell differential screw was equal to the most critical work, and could be used in photo-micrography. As a result several additions were made, such as rack and pinion focussing and rectangular movements to the sub-stage and a rack-work arrangement to the draw-tube. Subsequently a larger and heavier instrument was made, having a $\frac{1}{4}$ inch more of horizontal height. In this model the milled head of the differential screw is placed below the arm, instead of above it, which

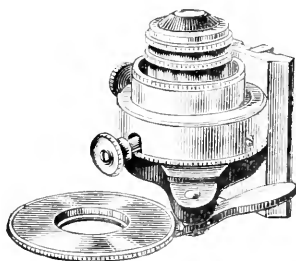

FIG. 183.—Centring nose-piece used as sub-stage (1881).

is an improvement for photo-micrographic purposes, and no special detriment in ordinary work; and, if required, a differential-screw fine adjustment can be fitted to the sub-stage. A rotary stage is also sometimes put to this instrument, but those which we have seen have not given the aperture sufficient dimensions for modern focussing.

This instrument in its complete form, as suggested by Mr. Nelson and devised by Baker, gave origin to an entirely new group of microscopes, which aimed chiefly at supplying the student with relatively inexpensive instruments, but which at the same time should possess all the qualities and be capable of receiving all the apparatus needful for an efficient use of the microscope. One of the higher forms arising in this new departure is the instrument shown at fig. 177, and, with the Campbell screw fitted behind the mirror for the fine adjustment of the condenser, is a very attractive and useful microscope, and may be safely recommended to the amateur and the student.

Two microscopes by Ross certainly deserve the attention of the student seeking a reliable instrument belonging to the class we are considering. They are both known as 'Ross's New Bacteriological Microscope.' The work of this long established firm, it is needless to say, is of the very finest quality; and these microscopes are provided with all the required adjuncts for the work they specify. The stage is of horseshoe form; the fine adjustment is sensitive and firm.

The principal difference between the two instruments is in their respective stands. The one shown in fig. 184 gives a wider spread to the tripod base than usual, securing greater stability; but this does not involve great space in packing, because the hind 'toe' of the

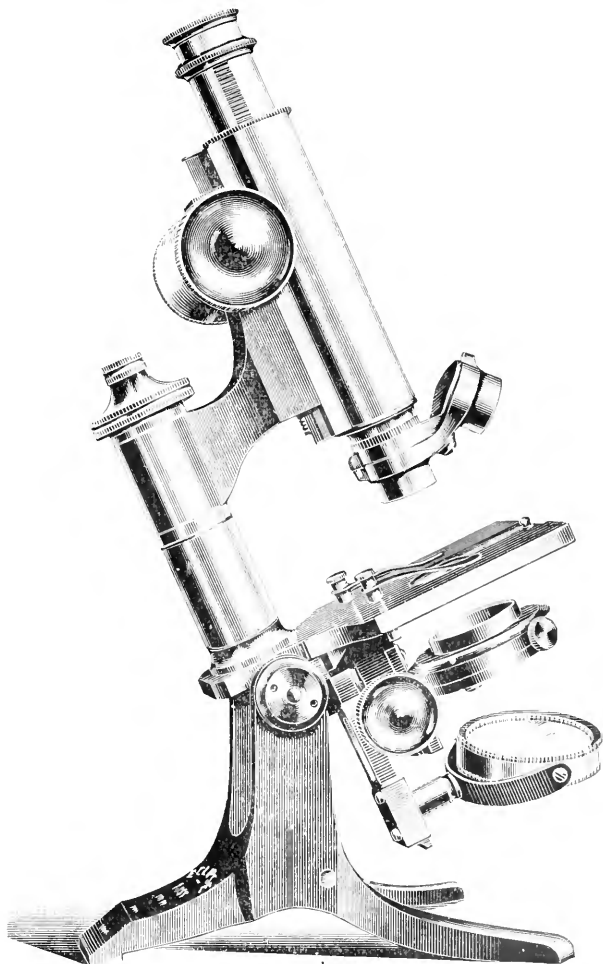

FIG. 184 — Ross's new (tripod) bacteriological microscope (1898).

tripod is made to fold forward between the two fixed front toes when not in use.

The other similar instrument is on a circular foot, to which is screwed a stout supporting pillar; the upper part is attached to this by a substantial compass-joint; but the pillar is fixed on the margin of the ring, thus bringing the whole weight centrally upon the

foot when the instrument is in an upright position. When inclined, the centre of gravity is again brought directly over the foot, as shown in fig. 185, by rotating the pillar upon a reliable fitting at its base, so that absolute steadiness is secured. This is a revival

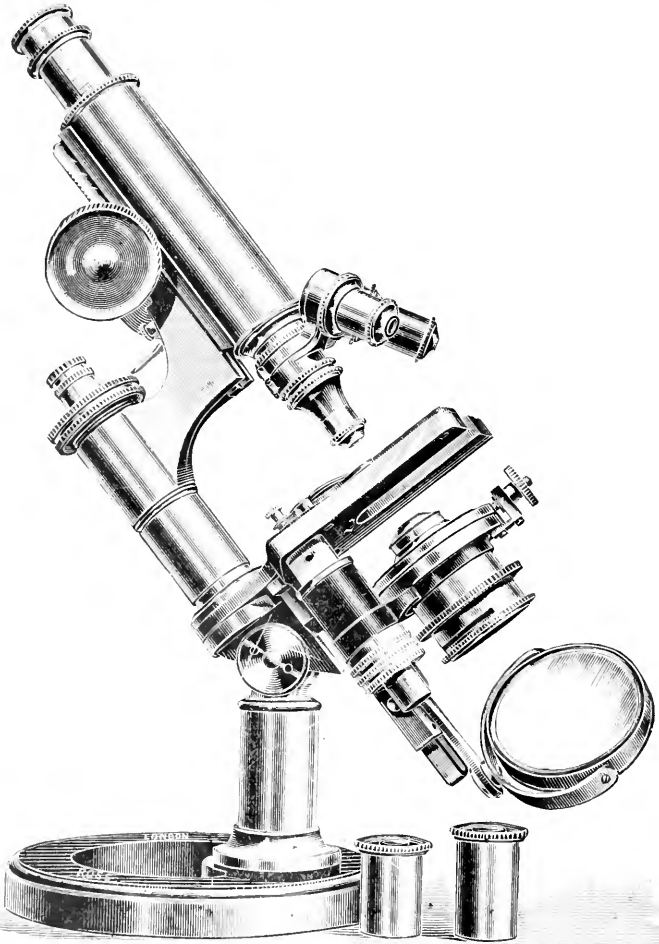

FIG. 185.—Ross's new bacteriological microscope (1894).

of an old form made in 1760 by J. Cuff, adapted by A. Ross in 1842, and now again used by the same firm (*vide* fig. 128).

Ross also manufactures an 'Educational' microscope having considerable merit, which may fairly be placed in this class. It

is presented, on a small scale, in fig. 186. It is admirably made, and provides all that is required in coarse and fine adjustments; it is also provided with admirable sub-stage arrangements, and is placed on a stand that, while it is of horseshoe pattern, has the hind 'toe' lengthened considerably, and is made so that the foot can reverse as in the illustration, and lock, thus making a perfect balance for the body, however it may be inclined. This admirably made instrument is considerably under 5*l.* in cost.

Beck's 'British Student's' microscope is of this class, as is also the 'Star' microscope by the same makers. The former has a firmly made tripod, as fig. 187, representing this instrument, shows. It has a spiral rack and pinion coarse adjustment, a fine-adjustment, a draw-tube with mm. scale, and a focussing sub-stage which swings out when not in use. The present Editor can speak highly of this instrument for elementary class work, and with good workmanship its price is exceedingly low. The 'Star' microscope is also a very remarkable instrument, sufficiently so to justify us in departing from a rule to point out that with two eye-pieces, two objectives—a $\frac{1}{2}$ -inch and a $\frac{1}{6}$ -inch—and an iris diaphragm, the whole, placed in a cabinet, is sold for 4*l.* 15*s.*

We come now to microscopes of the fourth class.

A small, compact, and thoroughly useful microscope, specially adapted for medical students and Biological Schools, is made by Swift and Son, and known as their 'New Histological and Physiological Microscope.' In its simplest form it is shown in fig. 188. The stand is a firm tripod, the optical tube slides in a cloth-lined fitting, the fine adjustment may be the differential screw actuated by a large milled head, and capable of work with at least a $\frac{1}{2}$ th-inch objective. It is beautifully swung, and is firm in any position. The stage is large, and has the horseshoe opening. There are several grades of this instrument, involving more or less complexity and apparatus; but it was designed to meet, and we believe does meet, the needs of students who want a strong, practical, and well-equipped instrument at a very moderate price.

Another instrument of this class deserving the highest commendation, and offering the student much more for the outlay involved than we could have thought possible twenty years ago, is 'The

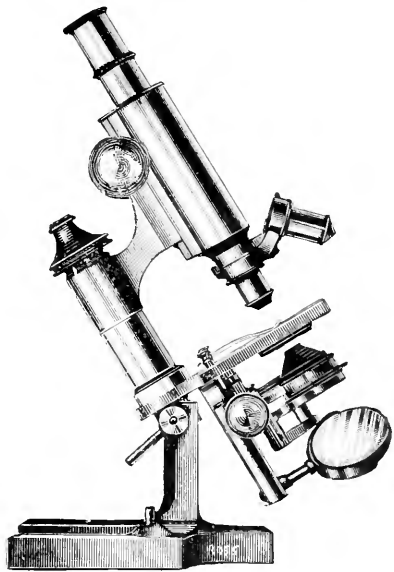

FIG. 186.—Ross's educational microscope (1898).

Fram' microscope of Messrs. Watson and Sons. We illustrate it in fig. 189. It is strong and rigid, and its workmanship is of the highest order. It has a completely steady tripod foot with a spread

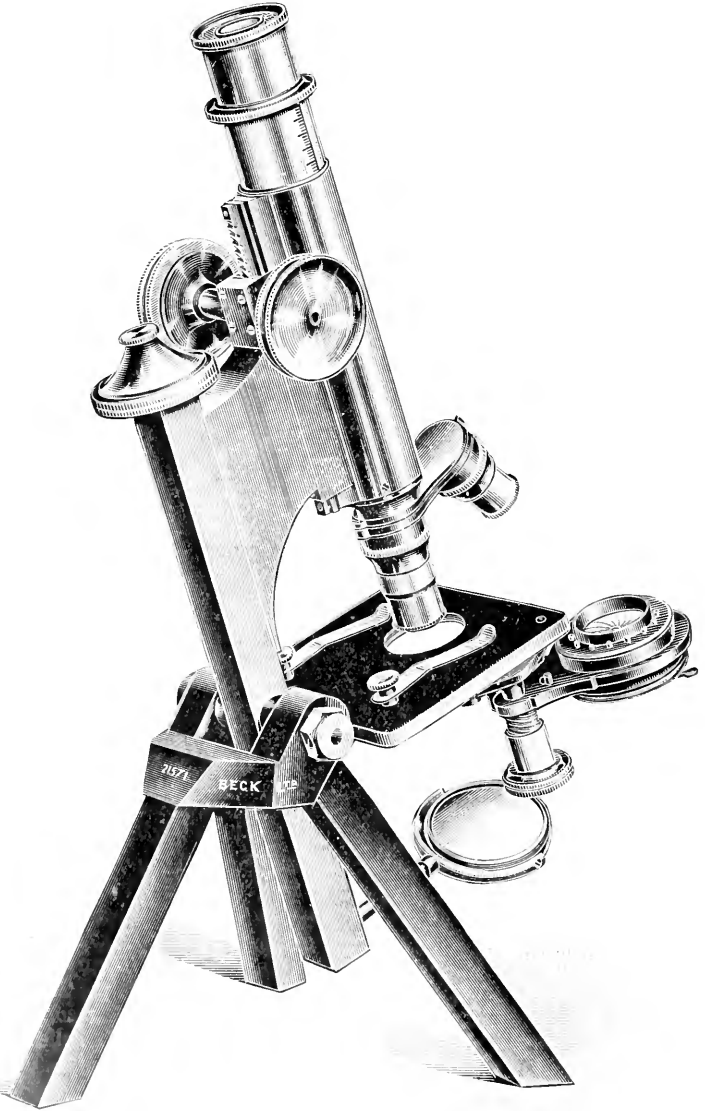

FIG. 187.—Beck's British student's microscope (1898).

of 7 inches, and its steadiness is unaffected in whatever position the body may have to be inclined. The coarse adjustment is a diagonal

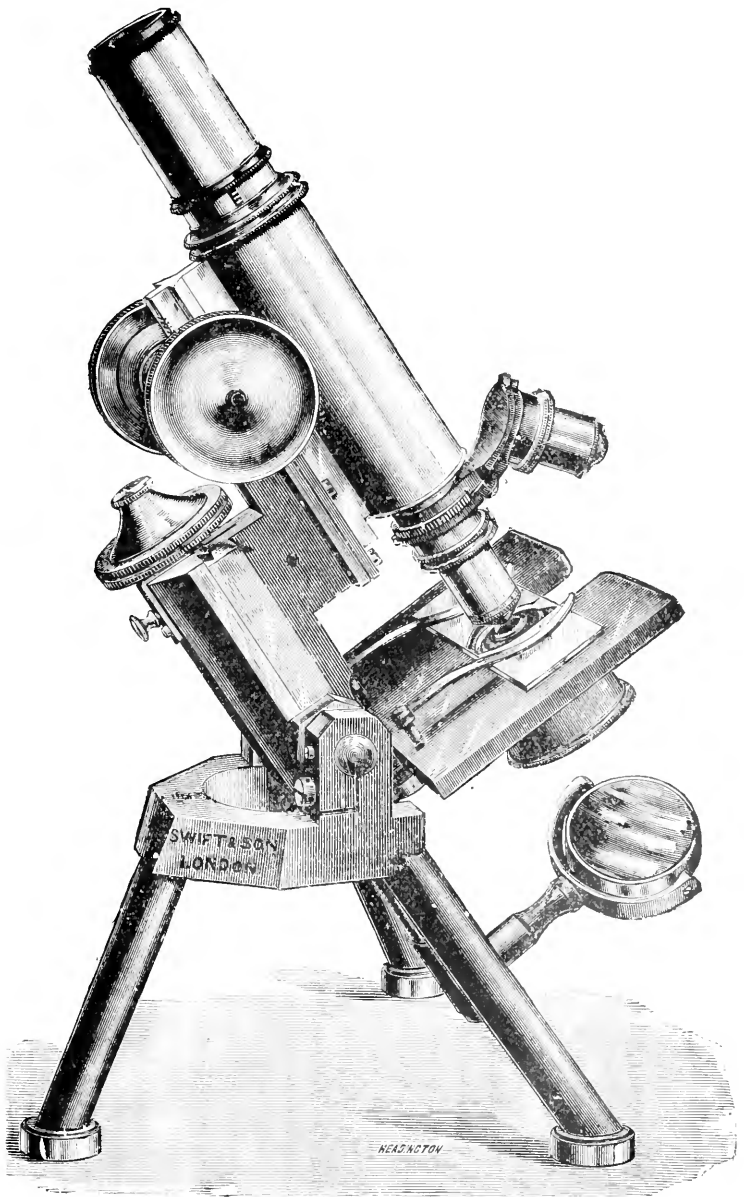

FIG. 188.—Swift's histological and physiological microscope (1894).

rack and pinion, while the fine adjustment is the now celebrated lever employed by this firm. One revolution of the milled head

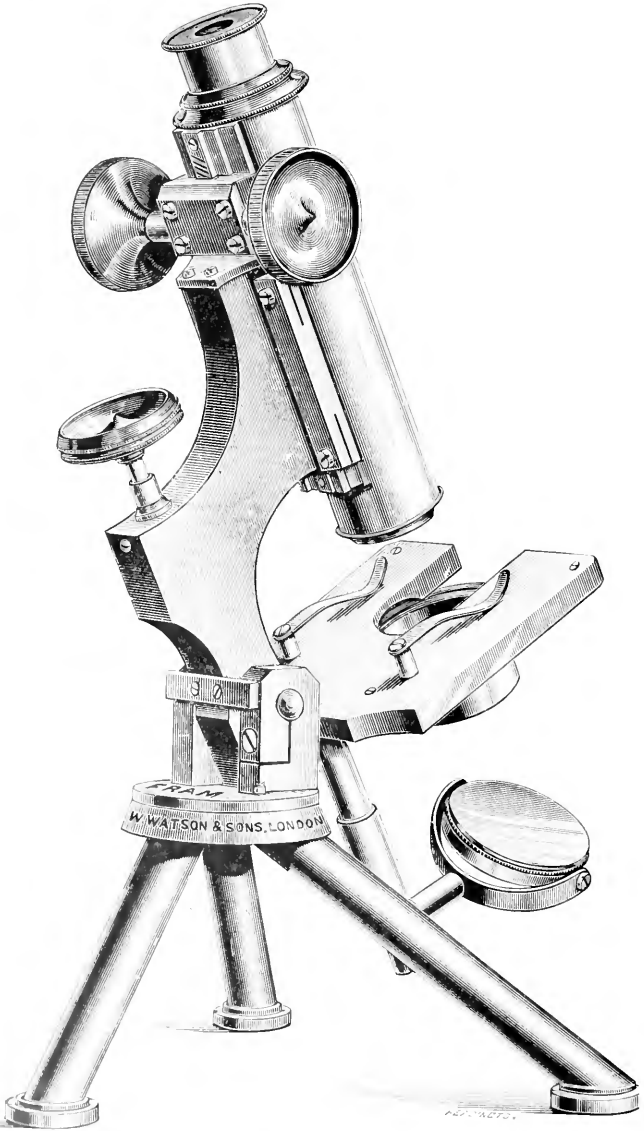

FIG. 189.—Watson's 'Fram' microscope (1898).

moves the body the $\frac{1}{3000}$ th of an inch. As we have seen (p. 170, fig. 132), this adjustment is sound in principle, and in practice all

that need be desired. The stage has the horseshoe-shaped aperture. The sub-stage fitting, as shown in the illustration, may be turned aside out of the optical axis, and a compound sub-stage may be made with the instrument if desired. Throughout, the working parts are sprung, and wear may be compensated by adjusting screws. We cannot speak too highly of the enterprise and skill shown in the design and manufacture of this instrument; and yet the student will find that, good as it is, it is one of the least costly instruments of its class.

There is a microscope manufactured by Messrs. Zeiss, known as 'Stand VI. A,' which comes to about the same cost as the above, and which we illustrate in fig. 190. It is of course a strictly Continental form, having a fixed stage $3\frac{3}{4}$ ins. square. The coarse adjustment is by rack and pinion, and the fine adjustment is the usual micrometer screw of these makers. The stand is inclinable, and it is provided with mirrors and a cylinder diaphragm which slides in a sleeve fixed below the stage capable of receiving the illuminating apparatus. It is, of course, made with the accuracy and good quality of workmanship for which this firm is noted.

Fifth and sixth classes of microscopes are made by the best makers, and it is a little notable that the best of these classes was made by the late Hugh Powell, whose maxim was that a microscope with only a *good* coarse adjustment was to be preferred to one having an indifferent fine adjustment with a sliding tube for the coarse adjustment.

This stand is of cast iron, with a flat tripod, having a single pillar to which is jointed the Jackson body. The focussing is admirable; the stage is of an excellent form, being $4\frac{1}{2} \times 3\frac{1}{2}$ inches, and is supplied with a beautifully made sliding ledge, which will move easily and firmly with pressure from one side only.

The stage is fastened to the upper side of two brackets which are cast in one piece with the limb; on the under side of these brackets there is another plate which holds the sub-stage tube.

This instrument is supplied with large plane and concave mirrors; and, considering that it constitutes a **sixth class of microscope**, has very much in its favour as a secondary instrument for the work-table. Like all these makers' instruments, the feet are plugged with cork; and we know of some of these microscopes that have been in use for forty years, and are still the trusted 'journeymen' instruments of mounters and other workers of various orders in many departments of microscopy.

Some of the modern forms of these two classes of microscope deserve, on behalf of beginners with limited means, some consideration. A thoroughly good but extremely simple microscope of the fifth class is made by Watson and Sons; it is illustrated in fig. 191. It was designed for educational purposes; the workmanship is of the finest quality, but the instrument is not provided with a fine adjustment; it relies on a very perfectly made diagonal rack and pinion coarse movement. From practical use we can speak in the highest terms of the delicacy of this focussing arrangement, with which we have with ease used powers up to $\frac{1}{2}$ inch, and often have used it with a $\frac{1}{2}$ -in. objective. The stage is large, the body has a

draw-tube, can be inclined, and it is a steady useful microscope. It can be obtained complete in a case with one eye-piece for the sum of 2*l.* 7*s.* 6*d.*

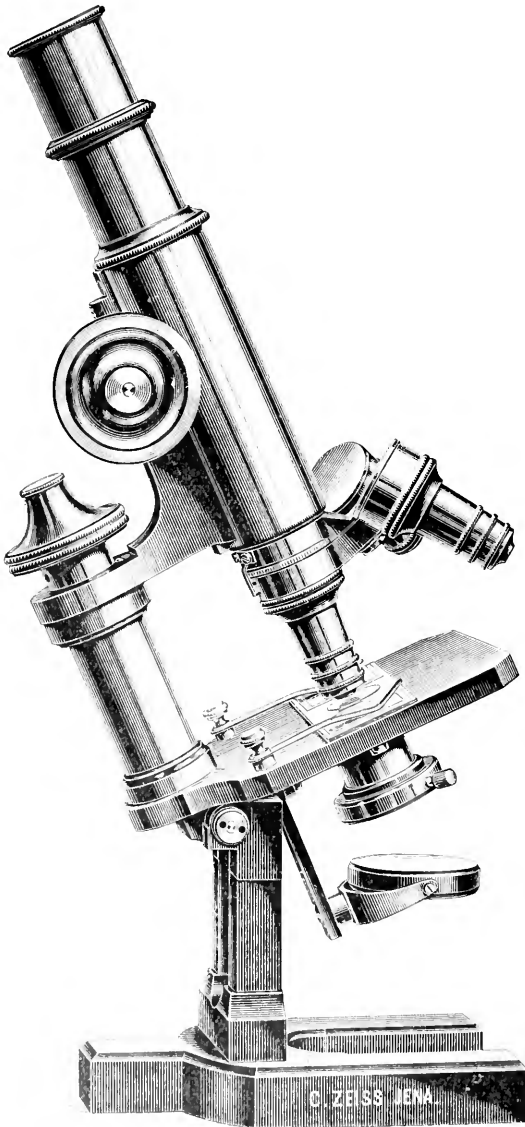

FIG. 190.—Zeiss's stand VLA (1898).

Bausch and Lomb manufacture an instrument which abandons the coarse adjustment, but provides a fine adjustment of good



FIG. 191.—Watson's school microscope (1899).

quality, and is thoroughly well made, its object being to meet the wants of schools and elementary workers. We believe, however,

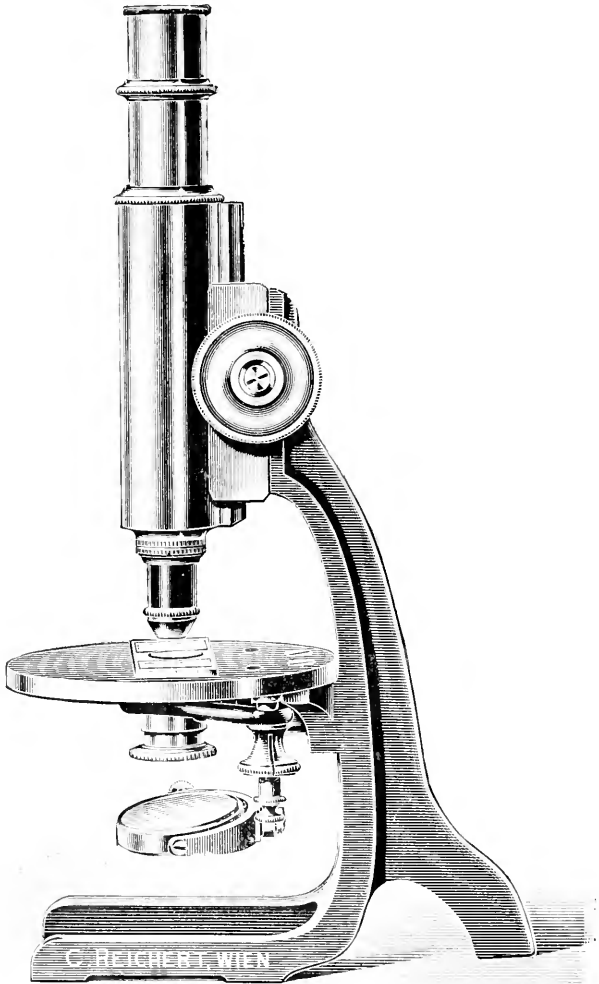

FIG. 192.—Reichert's stand No. 15 (1890).

for many reasons, that it is better to rely on an excellent rack and pinion coarse adjustment for such a purpose. This instrument is remarkable as meeting a distinct demand, for though of excellent

workmanship it is sold for twenty shillings. We illustrate it in fig. 193.

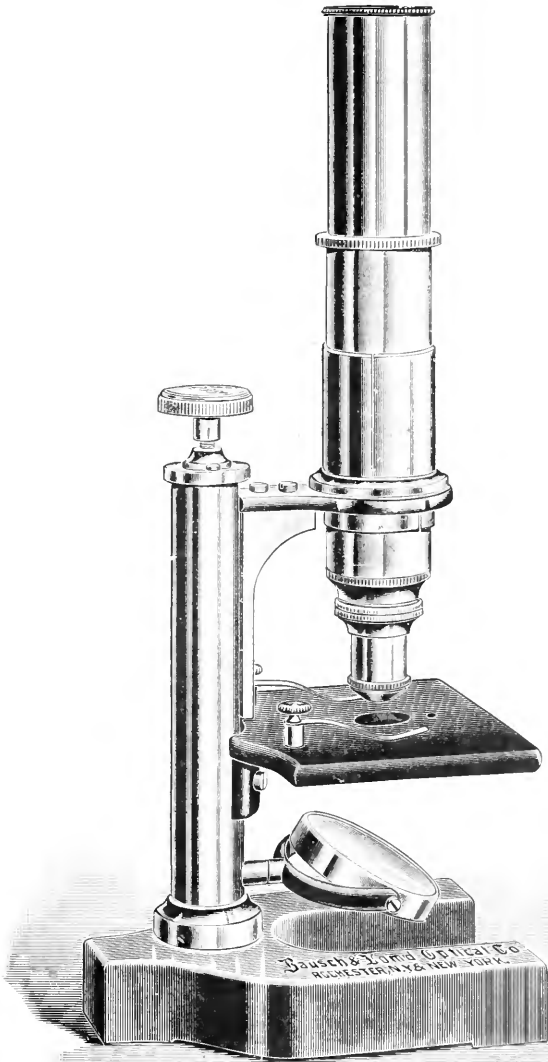

FIG. 193.—Bausch and Lomb's lowest-priced microscope (1897).

Reichert, of Vienna, manufactures an instrument of the same class with a good coarse adjustment only, built on a tripod, and of almost equally low price. But amongst the sixth class of micro-

scopes none is more remarkable for its strength, good form, and excellent finish than the one we show in fig. 194, made by Leitz. Its coarse adjustment is capable of doing very delicate work, and it is a thoroughly steady instrument, and is admirably adapted to elemen-

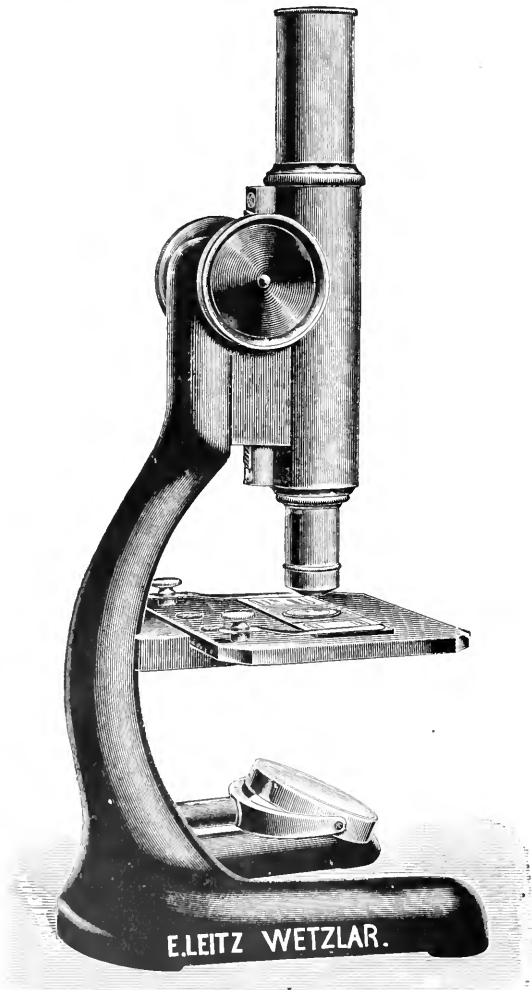

FIG. 194.—Leitz's school microscope.

tary work and school use, and, whilst its finish and work are admirable, it is sold for 17.

A really beautiful instrument of the same class is made by Reichert, designated 'Stand No. 15,' which is illustrated in fig. 192. It is admirably made, and the maker, as we think, wisely, has thrown

the best possible work into a spiral rack-and-pinion coarse adjustment which works with great accuracy and smoothness, and has dispensed with a fine adjustment. Its construction is neat, but it is

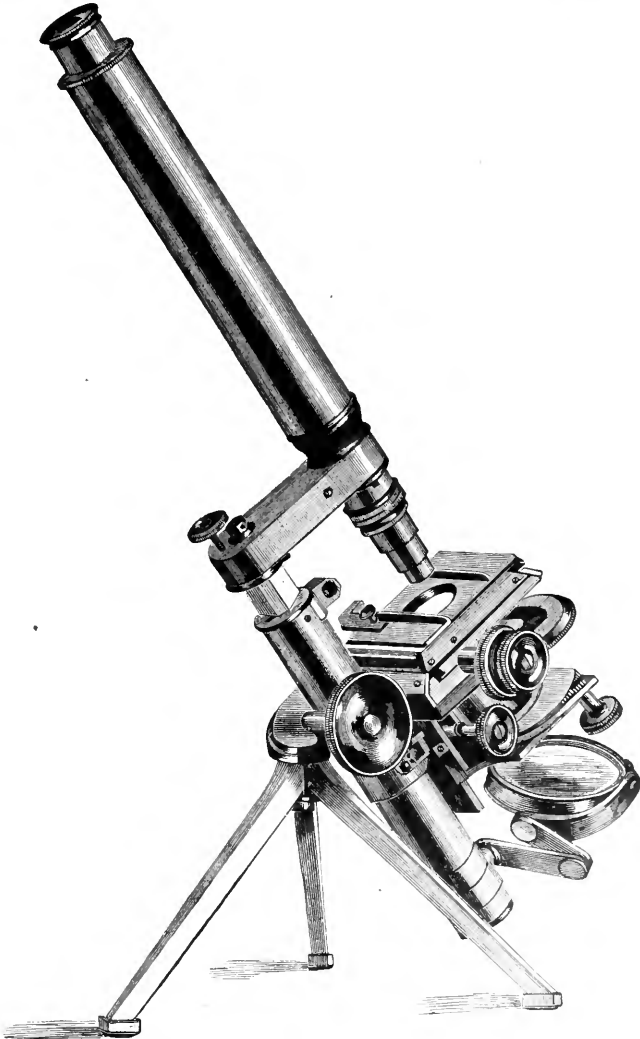

FIG. 195.—Powell and Lealand's portable microscope (1848).

one of the most rigid of this class of microscope which we have seen or used; this instrument is sold for twenty-five shillings. But the maker has adopted Mr. Nelson's plan, using a Steinheil magnifier to be mounted as a sub-stage condenser, and if a simple iris diaphragm

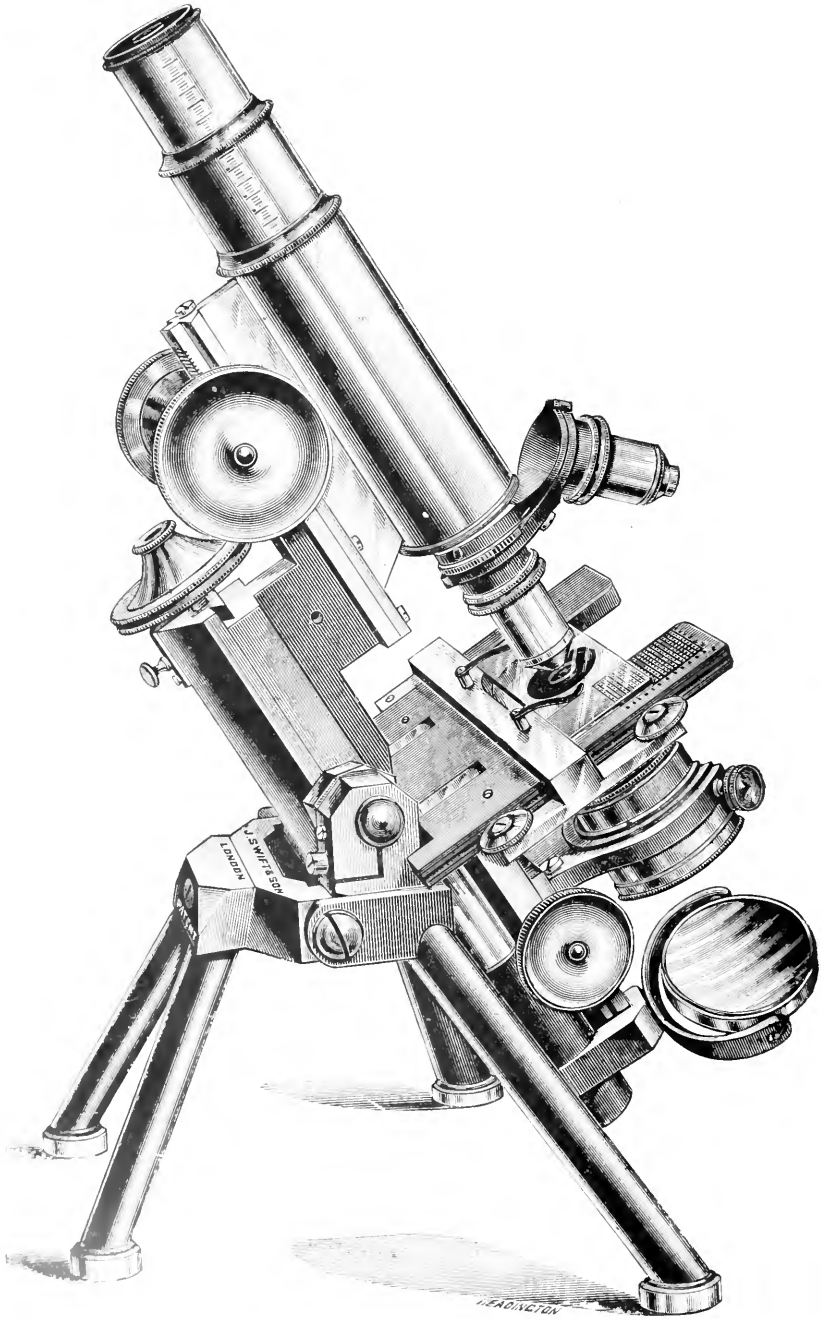

FIG. 196. —Swift's portable histological microscope (1894).

be used with this, there are very few but will be astonished at the beautiful results attainable. Certainly, since the last edition of this book was published, large and successful efforts have been made to supply to those who need them cheap but thoroughly good microscopes.

Portable Microscopes.—Microscopes that may be readily taken from place to place, and which are yet provided with the arrangements required for using the principal apparatus, are of importance in some investigations, and are desirable by the majority of those who have a living interest in microscopic work.

The earliest and still the best form of this kind of microscope was made by Powell and Lealand. As opened for use it is illustrated in fig. 195; but the tripod foot folds into what becomes practically a single bar, and is bent by means of a joint to occupy the least space. The body unscrews, and the whole lies in a very small space, giving at the same time fittings in the cabinet for lenses, condensers, and all needful apparatus. The coarse and fine adjustments to the body are as in the No. 1 stand, so are the stage movements; and the sub-stage has rack-and-pinion movements and rectangular sector centring, while all the apparatus provided with the largest instrument can be employed with it. We have used this instrument for delicate and critical work for twenty years, and there is no falling off in its quality; and, when packed with the additional apparatus required, the case is $12 \times 7 \times 3$ inches.

Swift and Son have arranged their Histological microscope (fig. 196) as a portable instrument, to which from its peculiar construction it readily lends itself, and must be placed in the third class of portable microscopes.

Mr. Rousselet has designed an admirable little instrument of portable form but of the sixth class. It is binocular. The tripod folds; the stage is plain, with a sliding ledge. The condenser focusses by means of a spiral tube, within which an inner tube slides, carrying stops, diaphragms, &c. The mirror is jointed so as to be used above the stage, and, as its focus is only $1\frac{1}{2}$ inch, can be



FIG. 197.—Baker's diagnostic travelling microscope (1896).

used as a side reflector. It is also arranged so that eye-pieces with large field-glasses may be employed. It packs in a box $10\frac{1}{2} \times 5\frac{1}{2} \times 3\frac{1}{2}$ inches, and weighs 6 pounds complete.

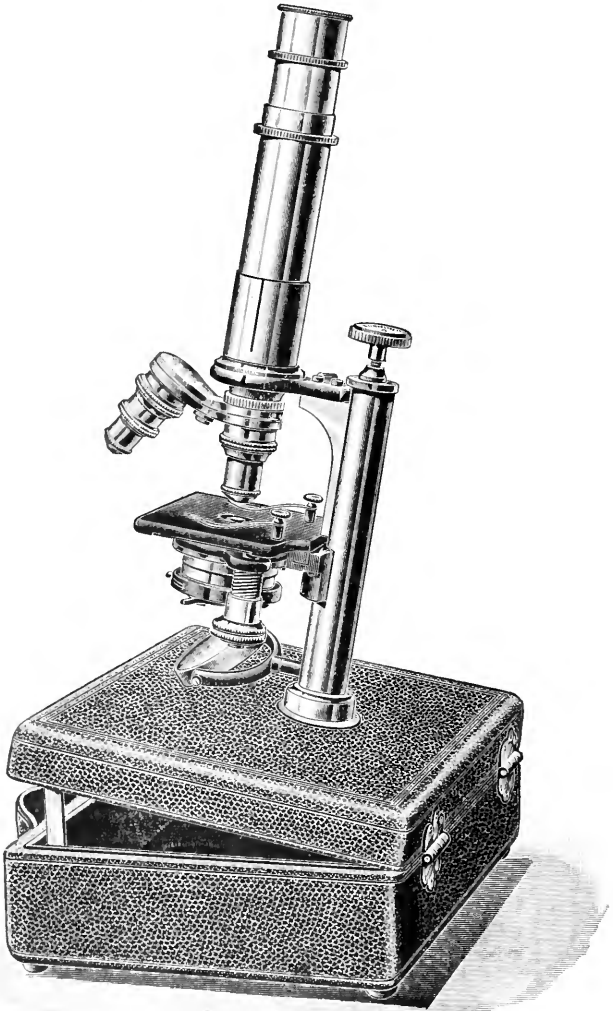

FIG. 198. — Bausch and Lomb's portable microscope (1898).

Baker now makes a small useful instrument for travelling called 'the Diagnostic' microscope, designed by Surgeon-Major Ross, medical superintendent, Indian Army Medical Department. Fig. 197 illustrates it. The tripod stand is firm, but readily

fold. It is provided with sliding tube, coarse, and micrometer screw fine adjustments, a good draw-tube and thoroughly useful stage, a tubular sub-stage with plane and concave mirrors. It is packed in a leather case with shoulder strap and loops for a military belt, or a handle, and this case, with three objectives and extra eye-piece, occupies $11 \times 3\frac{1}{2} \times 3$ inches. It can also be arranged for a sub-stage carrying a condenser and iris diaphragm, and is exceedingly compact and well made.

A very old device has been utilised by Messrs. Bausch and Lomb for a new portable stand, that, namely, of making the case or box the foot of the instrument. The microscope itself is, in every other respect save size, the same as their 'New' stand shown in fig. 193; but the addition is made of a clamping screw, to prevent the main tube from

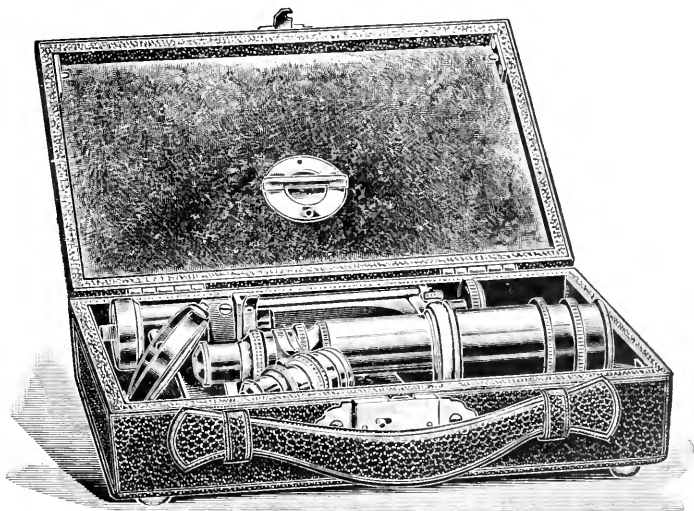

FIG. 199.—Bausch and Lomb's portable microscope packed (1898).

dropping or turning. An illustration of this microscope is given, as set up for use, in fig. 198. It will be seen that a double nose-piece may be used, and it is provided with a useful condenser, the sub-stage having a screw focussing adjustment, and an arrangement for swinging this out of the optic axis. The microscope is rigid, but can be inclined at any angle by raising the cover of the case as in the figure. It can be closed into the box with its double nose-pieces in position, and its sub-stage and condenser ready for use. The size of the case complete is $8\frac{3}{4} \times 5\frac{3}{4} \times 2\frac{1}{4}$ inches, and its weight is $3\frac{3}{4}$ pounds.

Microscopes employed for the purpose of minute dissection are of considerable importance in certain kinds of work. Many instruments specially adapted are made, although the majority are arranged for simple lenses. But an instrument of great value,

arranged for use with *compound lenses*, has been devised by employing the binocular of Mr. Stephenson. This instrument is illustrated in fig. 200. It is made by Swift and Son. The stage may be enlarged as a dissecting table, with special rests for the arms. The objective and binocular part of the body remain vertical and focus vertically by a rack-and-pinion coarse adjustment, there being no fine adjustment. The bodies above the binocular prisms are suitably inclined, mirrors being placed inside them to reflect the image. This reflection also causes the erection of the image, which is valuable to the majority engaged in insect dissection or the dissection of very delicate and minute organisms or organs.

Another type of dissecting microscope has been introduced (as we have seen on pp. 102-4) by the firm of Zeiss; it is known as Greenough's Binocular Microscope, and possesses valuable and interesting features, and has been prepared to facilitate the examination, dissection, and preparation of eggs, larvæ, and other solid objects by furnishing a true stereoscopic and erect image. Hence it is most useful for zoologists, botanists, and embryologists. To accomplish this purpose a combination of **Porro** prisms with a compound microscope of the usual optical type has been effected. We have said enough of this instrument in an earlier page, and merely recall its adaptation to dissecting purposes by the illustration furnished in fig. 201, and we would remark that it is only when two such complete microscopes, each having its own objective and eye-pieces, are simultaneously directed upon an object that the truest stereoscopic images can be obtained.

Only comparatively low powers can be used with this instrument, but this is no defect, for with such powers alone would the work it is intended to do be accomplished; but two special eye-pieces of different powers, corresponding to **Huyghenian** eye-pieces 2 and 4, are prepared for this microscope; they are known as orthomorphic. The magnifications resulting from the combination of these eye-pieces with the objective are respectively 25 and 40.

We have now to consider *the most primitive stands* adopted for simple microscopes. That in the form of a bull's-eye stand is the least complex form possible. This instrument holds an intermediate place between the hand magnifier and the complete microscope, being, in fact, nothing more than a lens supported in such a manner as to be capable of being readily fixed in a variety of positions suitable for dissecting and for other manipulations. It consists in its best form of a circular foot, wherein is screwed a short tubular pillar (fig. 202), provided with a rack-and-pinion movement, and carrying a jointed arm movable in many directions by ball-and-socket and other joints, *b, c, e*, but capable of being clamped by thumb-screws or milled heads, *a, b, e*; one end of this arm carries a joint, to which is attached a ring for holding the lenses. By lengthening or shortening the pillar, by varying the angle which the arm makes with its summit, and by using the various joints, almost any position and elevation may be given to the lens that can be required for the purposes to which it may be most usefully applied, care being taken in all instances that the ring which carries

the lens should (by means of its joint) be placed horizontally. The lenses now most suitable for such a holder are those constructed

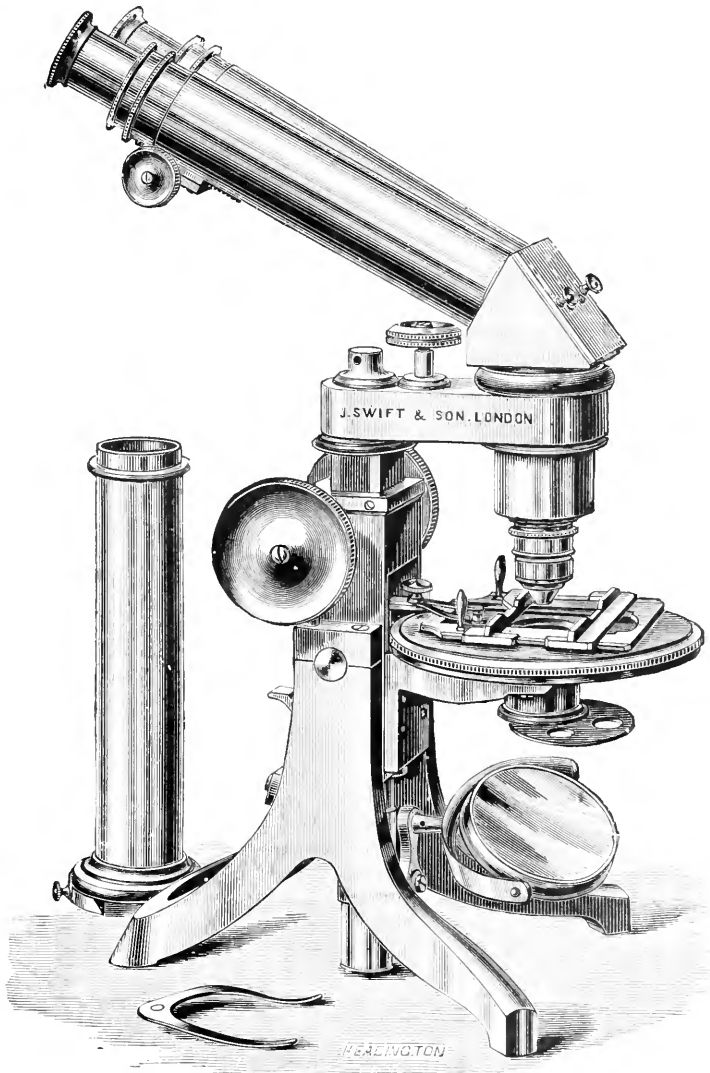

FIG. 200.—Stephenson's binocular by Swift (1887).

upon the Steinheil formula, composed of three cemented lenses forming a system which gives relatively long working distances with large flat field. As made by Zeiss they magnify 6, 12, 20, and

30 times, and, employed in such a stand as fig. 202, they are admirably adapted for picking out minute shells or for other similar manipulations, the sand or dredgings to be examined being spread upon a piece of black paper, and raised upon a book, a box, or some other support to such a height that when the lens is adjusted thereto, the eye may be applied to it continuously without unnecessary fatigue. It will be found advantageous that the foot of the microscope should not stand upon the paper over which the objects are spread, as it is desirable to shake this from time to time in order to bring a fresh portion of the matters to be examined into view ;

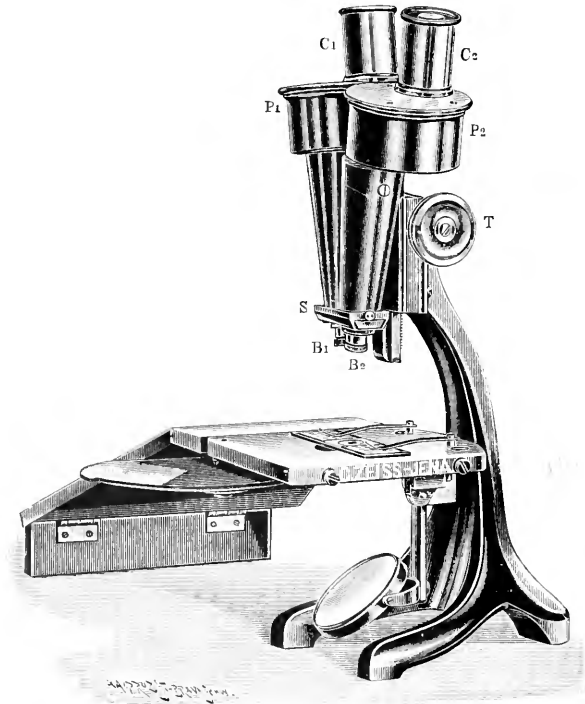

FIG. 201. — Greenough's binocular, arranged as a dissecting microscope (1897).

and, generally speaking, it will be found convenient to place it on the opposite side of the object, rather than on the same side with the observer. In a suitable position these lenses with their holder may be most conveniently set for the dissection of objects contained in a plate or trough, the sides of which, being higher than the lens, would prevent the use of any magnifier mounted on a horizontal arm. Although the uses of this little instrument are greatly limited by its want of stage, mirror, &c., yet, for the class of purposes to which it is suited, it has advantages over perhaps every other form that has been devised. Where, on the other hand,

portability may be altogether sacrificed, and the instrument is to be adapted to the making of large dissections under a low magnifying power, some such form as is represented in fig. 203 constructed by Messrs. Baker, on the basis of that devised by Professor Huxley for the use of his Practical Class at South Kensington, will be found decidedly preferable. The framework of the instrument is solidly constructed in mahogany, all its surfaces being blackened, and is so arranged as to give two uprights for the support of the stage and two oblique rests for the hands. Close to the summit of each of these uprights is a groove into which the stage-plate slides; and this may be either a square of moderately thick glass or a plate of ebonite, having a central perforation into which a disc of the same material may be fitted, so as to lie flush with its surface, one of these being readily substituted for the other, as may best suit the use to be

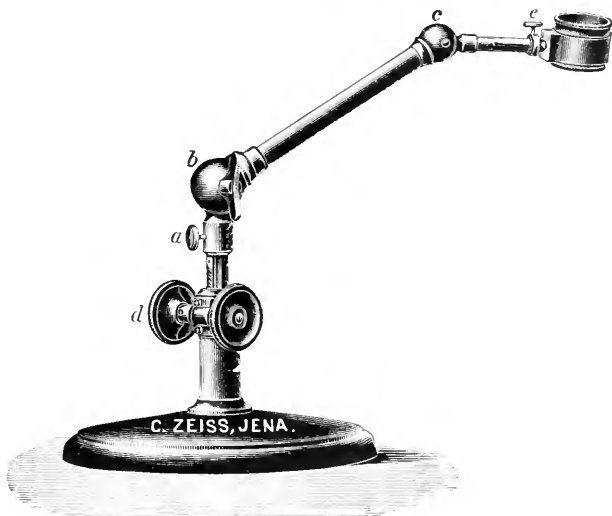

FIG. 202.—Zeiss's lens-holder.

made of it. The lens is carried on an arm working on a racked stem, which is raised or lowered by a milled-head pinion attached to a pillar at the further right-hand corner of the stage. The length of the rack is sufficient to allow the arm to be adjusted to any focal distance between 2 inches and $\frac{1}{4}$ inch. But as the height of the pillar is not sufficient to allow the use of a lens of 3 inches focus (which is very useful for large dissections), the arm carrying the lenses is made with a double bend, which, when its position is reversed, as in the dotted outline (which is readily done by unscrewing the milled head that attaches it to the top of the racked stem), gives the additional inch required. As in the Quekett microscope, a compound body may be easily fitted, if desired, to a separate arm capable of being pivoted on the same stem. The mirror frame

is fixed to the wooden basis of the instrument, and places for the lenses are made in grooves beneath the hand-supports. The advantages of this general design have now been satisfactorily demonstrated by the large use that has been made of it; but the details of its construction (such as the height and slope to be

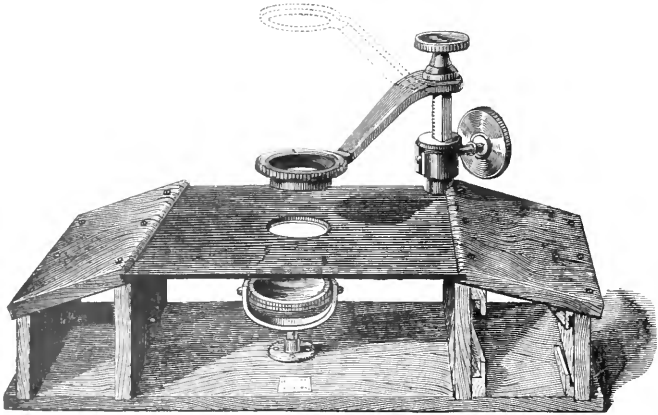

FIG. 203.—Laboratory dissecting microscope (1876).

given to the hand-rests) may be easily adapted to individual requirements.

A very simple and well-known form of dissecting microscope is made by Messrs. Bausch and Lomb. It is shown in fig. 204. Its form is self-explanatory: a plain glass stage, and a mirror at a suitable angle giving abundant light, capable of being replaced by

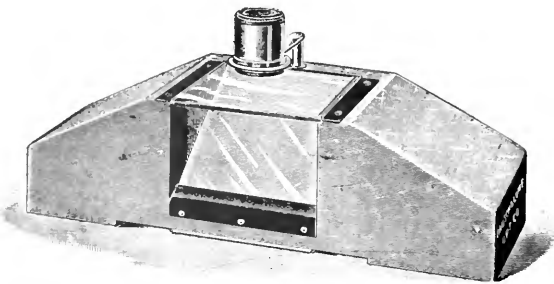

FIG. 204.—Bausch and Lomb's (Barnes) dissecting microscope (1896).

a white or black enamelled background, suitable rests for the arm, and a sliding holder for the lenses. It is these latter that are special: they are designed for the instrument. They are doublets, which undoubtedly give a large aplanatic field and fine definition.

But the very best form of dissecting microscope *for simple lenses*

which we believe to be at present constructed is made by Zeiss. We illustrate this form, fig. 205. It has a large firm stage 4 inches square and $4\frac{1}{2}$ inches from the table, to which wooden arm-rests can be attached or not, as may be desired. Only one is attached in the

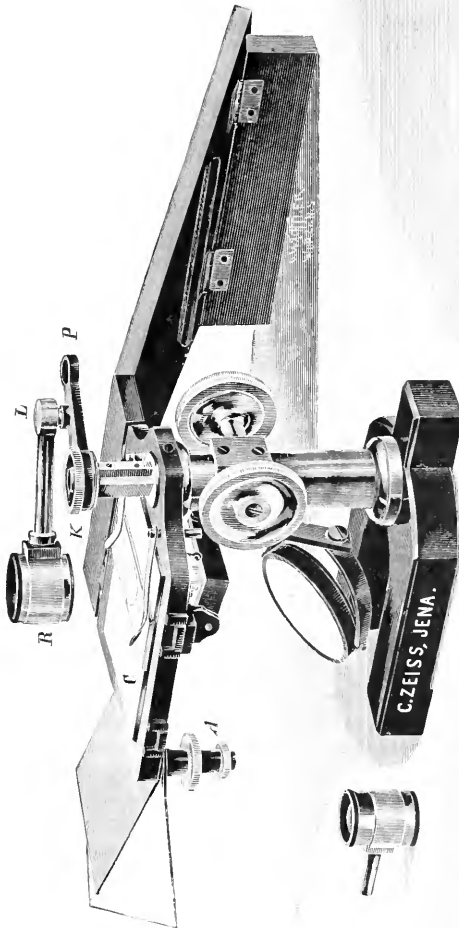

FIG. 205. — Zeiss's dissecting microscope (1886).

illustration, and the points of attachment of the other are seen. The stage has a large opening, $3 \times 3\frac{3}{8}$ inches, into which can be placed either a flat brass plate or a glass substitute, or a metal plate with a half-inch hole in it. Underneath the stage are black and white screens, which can readily be turned aside by the use of the

milled heads, A. The arm, which is focussed by an excellent spiral rack-work adjustment, carries either a Zeiss dissecting microscope, which, with and without its concave eye-lens, yields six different powers, varying from 15 to 100 diameters, or the arm will receive the very fine Zeiss-Steinheil simple magnifiers.

The instrument is provided with a large plane and concave mirror on a jointed arm. The utility of this simple microscope is very great, and we do not hesitate to pronounce it the best thing of its class we have ever seen.

The Continental Model.—Our one purpose in this treatise is to endeavour to promote what we believe to be the highest interests of the microscope as a mechanical and optical instrument, as well as to further its application to the ever-widening area of physical investigation to which, in research, it may be directed. To this end throughout the volume, and especially on the subject of the value and efficiency of apparatus and instruments, we have not hesitated to state definitely our judgment, and, where needed, the basis on which it rests. Incidentally we have expressed perhaps more than once our *disapproval*, and, with ourselves, that of many of the leading English and American microscopists, *of the form of microscope known as the Continental model*; we believe it is not needful to say that we have done this after many years of careful thought and varied practice and experience, and, so far as the human mind can analyse, without bias. It is not where a microscope is made that the scientific microscopist inquires first, but where it is made most perfectly, and we cherish strong hopes, in the interests of the science of microscopy, that so enterprising and eminent a firm as that of Zeiss, of Jena, will bring out a model that will comport more completely with the needs of modern microscopical research than even the best of the models that they now produce. It is to this house, under the cultivated guidance of Dr. Abbe and Dr. Czapski, that we are indebted for the splendid perfection to which the optical side of the microscope has been recently brought; and when we know that the 'Continental model' has, in the hands of the firm of Zeiss, passed from an instrument without inclination of the body into an instrument that does so incline, and from an instrument without sub-stage or condenser into one provided with the latter of these absolutely indispensable appendages, and finally from an instrument with a perfectly plain stage with 'clips' into what is now a stage with mechanical movements—we can but hope that these concessions to what has belonged to the best English models for over forty years may lead to an entire reconstruction of the stand—a wholly new model—intended to meet all the requirements of modern high-class work in all departments, and with a fine adjustment of the most refined class. We cannot doubt, if this were so, that the same genius which has so nobly elevated the optical requirements of the instrument would act with equal success on its construction and mechanism. We have been told in the friendliest spirit, by one deeply interested in the Continental stand, and a master in optical knowledge, that on the Continent the microscope is 'actually almost exclusively used' in a vertical position. Nevertheless we know

what elaborate arrangements have been made to enable the body to be inclined in all the better models, and surely the English stand is as capable of being used in this position as the most primitive Continental instrument; but the doubt we have is as to whether the most primitive Continental stand possesses the same primal adaptability to all the modern optical and mechanical improvements of the microscope as is possessed by the English stand. It is said that 'the Continental microscope has closely followed the wants of the microscopist, and that in its mechanical arrangements it has kept pace with the increasing improvement of the optical parts, without outrunning them, as has been the case with many English forms of construction.' With the deference and good feeling with which we receive this statement we are bound to say that it does not present itself as historical. The mechanical parts have not in reality kept pace with the optical improvements, for when apochromatic lenses of 0.95 N.A. to 1.4 N.A. are used with large illuminating cones they become so sensitive to focal adjustment that the Continental fine adjustment (the best form of which has hitherto been used by Zeiss) is not sufficiently slow to permit of accurate focussing in highly critical work. Applications have, for instance, been made to Powell, asking him to increase the slowness of his fine adjustment, which is now twice as slow as the best Continental form. But perhaps the clearest evidence is found in the fact that, while we are passing this book through the press, two striking proofs of Continental conviction that their fine adjustment should be rendered slower and more sensitive are given, first, by the beautifully simple and, as we believe, most admirable invention of Reichert, adapting a lever movement to his stands (*vide* p. 169, fig. 131), by which he makes the fine adjustment more than *three times* as slow as the best hitherto used on the Continent; while the firm of Zeiss themselves, in their newest model (p. 167, fig. 128), have by another method surpassed all other makers; and, as I learn by the courtesy of the firm, 'the micrometer screw of this new stand is adjusted for $\frac{1}{635}$ th of an inch for each revolution of the milled head' (figs. 129, 130).

We cannot but believe that this is the best evidence we can have of the validity of our contention in the last edition of this book that the Continental fine adjustment was too coarse or quick for the almost perfect objectives and eye pieces they themselves had given to the world.

We have written throughout this book too frankly of the eminent services of Messrs. Zeiss, to the furtherance of the interests and progression of the microscope as a scientific instrument, to be misunderstood in making a plain estimate of the quality of the *model* on which their elaborate and in some senses beautiful stands are built. It will be seen that we everywhere justify our judgments by plain and easily comprehended reasons, and the very eminence of the makers renders it incumbent that practical microscopists should, without a shade of bias, assess the value of a stand which is certainly not built on lines that contribute to a higher and still more efficient microscopy.

At the same time we do not blind ourselves to the fact that an English market for the 'Hartnack' model has had very much to do with the perpetuation of the errors which that form contains.

The reason of this it is not difficult to trace. *The inductive method* advanced but slowly, in practice, upon the professional activities, and even the professional training, of medical men. The country which was the home of Bacon and Newton and Harvey and Hunter theoretically accepted, but was not quick to apply, the methods of induction to the work of its medical schools. Theory and empiricism held a powerful place in both the teaching and practice of medicine in England until the earlier years of the present century. Medicine was absolutely unaffected by Bacon until the latter half of the seventeenth century. It was not until the early years of this century that the modern school of medicine began its beneficent career. But at that time *the microscope*—one of the most powerful instruments which can be thought of in the application of experimental and deductive methods to the science of medicine—was looked upon and treated by the faculty as a philosophical toy, a mere plaything for the rich *dilettante*. But in spite of this the microscope was brought gradually to a high state of perfection, and by the end of the first third of the century was remarkably advanced as a practical instrument, all its essentials being more or less completely developed. Meanwhile, on the Continent the microscope was regarded by the Faculty as a scientific instrument of great and increasing value, being used to good purpose in making important discoveries in anatomy, histology, and biology generally.

This was gradually *realised in this country*, and there arose slowly a desire to employ the same instrument in England. But, although English instruments of the most practical and relatively perfect kind, representing the large experience of many careful amateurs, were easily accessible to our medical men in their own country—because it was on the Continent that the investigations referred to had been made—it was nothing less than the *Continental microscope* that was sought after and obtained. We have been told, indeed, that 'the development of the English stands has not depended on the wants of the microscopist,' but has been the result of ingenuity and invention. To this we simply say that it may be true that their development has not depended on the *immediate* wants of the microscopist, but was in many cases the result not of ingenuity so much as of powerful insight and foresight. And how often have these anticipations been realised! Because early observations of a histological character (and therefore of a nature to lie beyond the sphere of the lay amateur) had been successfully made with a certain form of microscope on the Continent, it was practically argued that this must be the most suitable instrument for such a purpose; but this was an inference made without knowledge of or reference to the well known English models.

Let us carefully examine this instrument. The typical form was that made by Hartnack. Seen in its primitive state, we have it in the catalogues of all the Continental makers—Zeiss, Leitz,

Reichert, and the rest. It is a non-inclining instrument, with a short tube on a narrow horseshoe foot, in which steadiness is obtained by sheer weight. It has a sliding-tube as a coarse adjustment, and a direct-acting screw for the fine adjustment. The stage is small, and the aperture in it is relatively still smaller, of no service in reaching the focus of an object by touch with a high power. It is provided with spring clips, and a diaphragm immediately below the stage, and a concave mirror. Now it has been said that the fact that the Powell stand, *e.g.* of forty-five years ago, adapts itself without material change to the most modern appliances would be looked upon by the German student as being 'no commendation,' because it would mean that they were more elaborate than was necessary, but what are the facts? Let us take an Oberhauser of 1837, and compare it in *one* essential particular only with a very early Powell, designed in 1834. It was a stage-focussing instrument. As a fact the Oberhauser will not focus a low-angled $\frac{1}{2}$ -inch objective properly; the fine adjustment works in jerks, and the lateral movement causes the object to go out of the field. The Powell will *now* work an apochromatic of 1.4 N.A. oil immersion with accuracy and precision; but if an apochromatic oil immersion of 1.4 were placed on the Oberhauser it would be at great risk to the objective. Now even in early days accurate focussing was surely a vital matter, and the foresight that could anticipate what might require more delicate focussing than the objectives then in use was wise, and to the student profitable. The Powell No. 1 stand, as it is now, was in the main constructed in 1849, so far as regards tripod foot, limb, coarse adjustment, and fine adjustment with Turrell stage. The alterations that have been introduced have been the concentric rotary stage (1861), and the present form was manufactured in 1869.

A *sub-stage condenser* was rarely used, because up to a comparatively late date (1874) it was regarded by many on the Continent as a mere elegant plaything; its true value was not perceived.

On this model all the microscopes of the firm of Zeiss, of Jena, are constructed, as they are used almost exclusively on the Continent, and are regarded in many of the universities and medical schools, both here and in America, as possessing all the qualities required for the best biological research.

If we examine the finest of these instruments made up to 1885, we are impressed, as we always are, with the beauty and care of the workmanship and finish of this firm; but there is the same heavy horseshoe foot, steady enough while the instrument is *non-inclining*, only needlessly heavy, requiring common ingenuity alone to get equal steadiness with one-fourth the weight. But since this instrument has been adapted to the English form by being made to incline to any angle up to the horizontal, the foot but insecurely balances the instrument, and it is not difficult, as it is not uncommon, to topple it over. Indeed in their photo-micrographic outfit the Messrs. Zeiss practically see this, for they supply *another foot to which the microscope is clamped*. Messrs. Bausch and Lomb tell us that the foot of their 'B B' Continental microscope is '*heavily leaded* to ensure greater stability.' Sidle and Poak (1880) and McLau en (1884), and

now Ross, adopting this foot, employ the added mechanism of the revolution of the pillar on the foot (an old device) to secure stability at all inclinations (*vide* fig. 185, p. 232). Surely if the horseshoe foot were satisfactory for the inclining microscope these modifications would not have been deemed needful. Besides which we note that for the same purpose the Continental maker, whom we venture to think very alert to the true needs of modern microscopy, Reichert, prolongs the projecting 'toe' of the horseshoe, giving it almost a tripod form.

It must not be forgotten that this want of balance is with the short, not the long body.

The diameter of the tube is small, being slightly over seven-eighths of an inch. No doubt a low-power eye-piece with a large field is extremely useful as a finder, but this advantage is completely lost with the original small Continental tube. That this is seen to be a disadvantage would appear certain, because the *photographic microscope model of Zeiss has a larger body-tube*; and in their recent 'Appendix' to their latest catalogue they admit that for certain purposes other stands made by them, 'owing to the limited diameter of their tubes, cut off the field;' a significant fact for those who would narrow the English body, when it is remembered that Powell's is, and has been, suitable for all purposes without alteration, and long, short, and binocular bodies are interchangeable.

At the date of the publication of our last edition, out of eighteen models ten were made with inclining bodies, and three had sliding coarse adjustment. But in the twelve models for 1889 ten incline, while only two are rigid, and eight have rack-work, against four having sliding tubes for coarse adjustment; but in the current catalogue of Messrs. Zeiss six out of eight models have inclining bodies, two are rigid, and one has sliding coarse adjustment. This is a manifest, if slow, conformity of the primitive model to the English type, and hardly supports the affirmation 'that (during the last forty years) the Continental microscope has closely followed the wants of the microscopist.'

The *direct-acting screw*, only slightly modified, obtains universally in these models. We have already plainly said that this is not sufficiently delicate in its action for critical work with an apochromatic objective of 1.4 or 1.5 numerical aperture, especially as a micrometer screw with a necessarily delicate thread is bound to carry the combined weight of the body, limb, coarse adjustment, and the opposing spring; that it will wear loose under the stress of constant work is inevitable, and thus its utility must be wholly gone.

The 1889 model has a new form of fine adjustment, the alteration being that the micrometer screw acts on a hardened steel point. This may cause it to work smoother; but as no weight is taken off, there is difficulty in discovering any reason for its admitting of more prolonged use without injurious wear. In support of this is the fact that in the new photographic stand made by this celebrated firm, with so extremely delicate a fine adjustment (fig. 129), we have learned through their English representatives that only *one-*

fifth of the amount lifted by the micrometer screw of the 1889 model is lifted by the same screw in the new model. It should be remembered that few makers of microscopes in England, though they may be for class and school purposes, if they use a fine adjustment at all, use anything less delicate than the Campbell differential screw; although it seems on the Continent to be believed that the direct-acting micrometer screw of the Continental form is still in vogue.

It must be plain that a screw of $\frac{1}{1000}$ th inch to a revolution cannot bear for long the heavy strain of the body of a microscope. The remodelling of Zeiss fine adjustments in 1886 undoubtedly improved their construction and quality of work: but so fine a steel thread is not meant to carry weight and strain. This applies to all delicate instruments of precision.

The stage of this instrument, in common with all built on the same model, has three fundamental errors of design:—

i. The stage is so narrow that the edges of the 3×1 slips are, in some Continental stands, allowed to project over the edges. Messrs. Zeiss have profitably departed from this fault by giving to their larger stands a stage in size more like the English type.

ii. The stages have an aperture so small as to limit their usefulness in focussing with high powers.

iii. Instead of a sliding ledge they provide what still more efficiently militates against easy and rapid focussing, viz. spring clips. It is unfortunate that no stage on this model admits of the use of the finger to aid in reaching the focus. This gentle tilting up of the object, as we approach the focal point, would save hundreds of cover-glasses and objective fronts—and we have reason to know that not a few are broken with this form of stage: but we have never seen put forward, and do not know, a single reason in justification of a small aperture in the stage.

Another important point is the absence of *rotation* in the ordinary Continental stand. True rotation is a strictly English feature, which has been in use and carefully constructed for many years. And its value is great: it is an indispensable adjunct to practical work.

Messrs. Zeiss, some twenty years since, copied the Oberhäuser form of rotation for the stage: they did this by making the body and limb *solid with the stage*, so that the whole rotates together.

Practically there is only *one* point in favour of such a movement, and that is, that the object remains exactly in the same position in regard to the field. But against this arrangement there is—

1. The liability of throwing the optic axis above the stage out of centre with that below the stage, and this though the workmanship be, as it is, of the highest order.

2. The rotation of a microscope object for ordinary examination is really unimportant, as there can be no top or bottom to it. Even for oblique illumination it is not required, as it is always easier to rotate the illuminating pencil. The only instances in which rotation

of the object is important are : (a) *When the object is polarised*, and then it is a distinct disadvantage not to be able to rotate the object independently of the body which carries the analyser. In short, the stage rotating independently of the body would be preferable because, if it is required to rotate the object on a dark polarised field, the polarising and analysing prisms *can be set at the proper angles*, and then the object rotated without disturbing the relative positions of the prisms.

But this cannot be done with the arrangement of the Zeiss model, which rotates body and stage. The firm have, however, more recently introduced a rotating stage based on the English model, and we are glad to give our testimony to its admirable workmanship and perfection of centring. The contention, however, that we think in all friendliness is sustained, is that the characteristics of the English model were not superfluous, and that the Continental model has only too slowly followed the requirements discovered and used by the makers of the best English models so long ago.

(β) *For photo-micrographic purposes.*—In this case, in the Zeiss stand, the head of the fine-adjustment screw is geared to the focussing rod ; so, manifestly, rotation of the body becomes impossible.

Thus, by adopting rotation in the form chosen, the highest ends for which the microscope stage *should revolve* cannot be accomplished, and the newer form of stand must be adopted.

The sub-stage is often quite wanting in the common Continental forms. This was true of the Hartnack stands, with rare exceptions; the Nacet instruments were provided with an elementary form.

As we have seen, until quite recent times, the *condenser was regarded on the Continent as a superfluous, if not a foolish, appliance* ; but that prejudice has been killed by the light thrown on the whole question by (1) the chromatic (1873), and now (2) the achromatic condenser of Abbe, and finally (3) by the 'centring achromatic condenser,' only just made accessible by this firm. This condenser is not only focussed by the rack-and-pinion movement, but also by means of a *special fine adjustment* for bringing out its most delicate results. But even a condenser was in use in England in the year 1691 (*vide* fig. 101, p. 133), and the best work in England since the invention of achromatism has never been done without one.

In the mounting of the Abbe condenser every possible ingenuity has been displayed to make it do its work without a sub-stage ; but a permanent centring and focussing sub-stage, into which this optical arrangement could, *amongst others*, fit, might be made with half the labour, ingenuity, and cost. But rather than this, we have in the less recent forms the condenser made to slide on the tail-piece, and to be jammed with a screw.

It has therefore neither centring nor focussing gear ; but, striking as it may appear, a *diaphragm*, which cannot be used with, and is no part of, the condenser, is supplied in a stand not of the *most recent*, but of comparatively recent make, with *mechanical centring* and rack work focussing movements ! That is to say, *the delicate centre*

of an optical combination might in that instrument *take care of itself*, but a diaphragm aperture must be centred by mechanism and focussed by rack.

We know that the idea involved in a rack-work diaphragm is the graduation in the angle of the cone of illumination from the plane mirror by racking a certain-sized diaphragm up or down. But this can be better done by an iris diaphragm, or perhaps more perfectly still by a wheel of diaphragms.

Now, in reality nothing is so important as the centring and focussing of the condenser, after we are once provided with perfect objectives; and any mechanical arrangement that would enable us to perfectly centre an iris diaphragm or a wheel of diaphragms would enable us to centre the condenser. For the racking and centring of condensers there was, until very recent times, nothing in the best stands, of what is doubtless the largest and most enlightened house for the manufacture of microscopes in the world, to supply this indispensable *need* which the modern condenser involves.

We observe with pleasure advances in every direction in which we have called attention to defects. The more recent instruments are marvels of ingenuity; we present, in fig. 167, the latest and finest form of Zeiss's best microscope.

There is no fault in the workmanship; it is the best possible. *The design only is faulty*; there is nothing to command commendation in any part of the model; and, seeing that the Messrs. Zeiss have now progressed so far as to furnish their first-class stand with the English mechanical movement, and even stage rotation, and fine adjustment to their newest and best sub-stage condenser, we can but believe that the advantages of these improvements will make plain the greater advantage that would accrue from an entirely new model. To all who study carefully the history of the microscope and have used for many years every principal form, it will, we believe, be manifest that the present best stand of the best makers of the Continent is an over-burdened instrument. Its multiplex modern appliances were never meant to be carried by it. The attempt to combine a dissecting microscope with an observing microscope required to do the most critical work is not, we submit with all friendliness, compatible.

The Purchase of a Microscope.—A desire to possess a good but not costly microscope is extremely common, but as a rule the intending purchaser has little knowledge of the instrument, and does not profess to know what are the indispensable parts of such an apparatus, or what parts may, in the interests of economy and his special object, be dispensed with, leaving him still possessed of a sound and well-made instrument. We may briefly consider this matter.

The first question to be asked when a microscope is to be purchased is, 'What is the order of importance of the various parts of a microscope?' In answering this query it will be to some extent true that subjectivity of judgment will appear. But we believe that the following table of the relative order of importance of the

parts of a microscope will commend itself to all workers of large and broad experience : —

1. A coarse adjustment by rack and pinion.
2. A sub-stage.
3. A fine adjustment.
4. Mechanical movements to sub-stage, *i.e.* focussing and centring.
5. Mechanical stage.
6. Rack-work to draw-tube.
7. Finder to stage.
8. Plain rotary stage.
9. Graduation and rack-work to rotary stage.
10. Fine adjustment to sub-stage.
11. Rotary sub-stage.
12. Centring to rotary stage.

This table gives in order the relative values of the several parts ; thus a microscope with a rack-and-pinion coarse adjustment and a sub-stage is to be preferred before a microscope with a rack-and-pinion coarse adjustment, a *fine adjustment*, but *no sub-stage*. Or a microscope with a coarse adjustment by rack and pinion, a sub-stage, and a fine adjustment, is to be preferred before one with the same coarse adjustment and a mechanical stage movement, but no sub-stage or fine adjustment ; and so on. The last item is of least importance, and the importance of all the others is in the order of their numeration.

Another matter of some significance to the tyro is the relative value, from the point of view of time consumed, and therefore of prime cost, in producing the several kinds of microscopes. The No. 1 stands of half a dozen makers may be near the same cost, but may nevertheless have involved the consumption of very different quantities of the highest class of skilled labour in their production.

Manifestly the first thing to be looked at in a microscope making any pretensions to quality is the *character of the workmanship* ; and this should carry with it the question how much machine, and how much hand work and fitting there is in it. Arcs graduated on silver, for example, are very attractive, and with many are most impressive ; but they are simply machine work, and quite inexpensive.

In the two great types of models, the bar movement and the Jackson limb, the bar movement involves more than double the actual hand fitting ; while a fine adjustment with a movable nose-piece takes twice the fitting of one in which the whole body is moved by the fine adjustment screw. In the same way a *mechanical stage* which is made of machine-plated plates, sliding in a machine-ploughed groove, is much less costly in time and quality of labour than a hand-made sprung stage. So a *sub-stage* having a movable ring pressed by two screws against a spring has very far less work, and work of a lower class, than one with a true rectangular centring movement.

It will follow, then, that a Jackson-limbed microscope with no movable nose-piece, with a machine-made mechanical stage and a movable ring for sub-stage, will not have involved more, perhaps, than a third of the skilled work which must be expended on a well-

made instrument of the same size with a bar movement. But if we compare the range of prices as presented by English and American makers, we rarely find an equivalent difference in cost.

Then the tyro will be warned by this not to purchase a pretentious instrument with a bar movement and mechanical stage for, say, 5*l.*

But if a low-priced instrument is to be purchased, if, as is almost certain, it be a Jackson model, see that it has a rack-work coarse adjustment, eschew the *short-lever nose-piece*, and have a differential screw fine adjustment, a large plain stage, and an elementary centring sub-stage. Such an instrument should be obtained for 5*l.* 10*s.*

Although not frequently used, it would be doing our work imperfectly not to refer to a form of microscope devised for chemical purposes by Messrs. Bausch and Lomb. The object of Prof. E. Chanut, of the Cornell University, in inducing these opticians to make this microscope was, he says, to enable the chemist who had mastered the use of the microscope to employ the elegant and time-saving methods of micro-analysis, thus giving him ability to examine qualitatively

the most minute amounts of material with a rapidity and accuracy which are truly marvellous, not to speak of the many substances for which no other method of identification is known.

An illustration of this instrument is given in fig. 206. It will be observed that it follows the Continental model; since in all the work for which it is intended the stand is always used in an upright

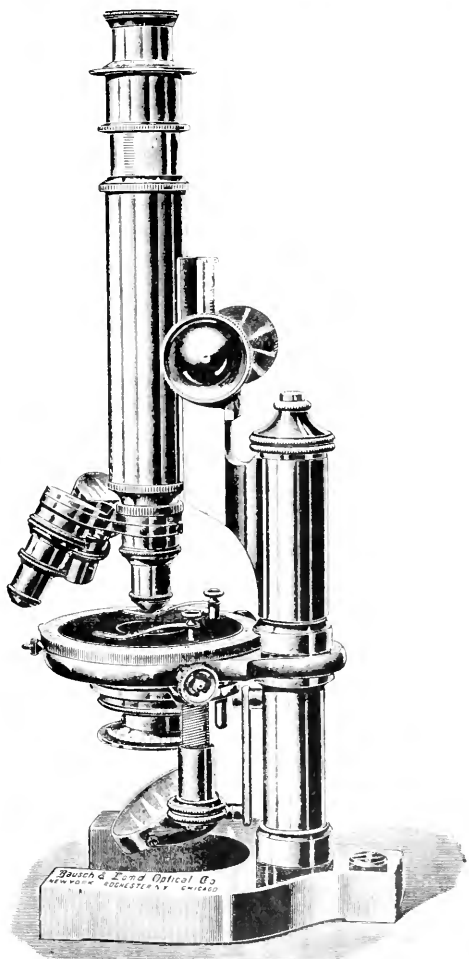

FIG. 206.—Microscope for chemical purposes (1897).

position, it is not provided with a jointed pillar to secure inclination. The coarse adjustment is by rack and pinion; the fine, by the usual micrometer screw of this firm. The stage is circular and rotates, being provided with centring screws, and its margin is graduated into degrees for measuring crystal angles. Except for this graduated circle the stage is faced with hard rubber. The sub-stage is adjustable by means of a quick-acting screw. This is fitted with polarising apparatus, consisting of a large Nicol prism so mounted that by means of a pin fitting into a slot in the sub-stage the prism can always be replaced in exactly the same position, and rotated with a circle graduated in degrees; or it can be swung aside when polarised light is not needed. The analysing Nicol prism is also provided with a graduated circle, and is so mounted that it fits over and above any eye-piece. The draw-tube of the microscope is furnished with a small projecting pin, which fits into a slot cut in the bottom of the tube-mounting of the analyser. This slot lies in the same vertical plane as the zero points of the analyser, the polariser, and the stage. The zero points of the two former are arranged as usual for the position of crossed Nicols; hence, when the polariser is in position and at zero, and the analyser is at zero and is in position by its pin and slot, the Nicols are crossed without further adjustment: this, of course, saves much time. But it is clearly a simplified petrological microscope; it is not intended for petrological or mineralogical work, it is simply an instrument made at a very low price, but stated by Prof. Charnot to be competent for all chemical work or food examinations.

An equally important special form of microscope has been made by Reichert **for the examination of metals**.¹ Fig. 207 shows this instrument made according to the instructions of Dr. A. Rejtö, of Budapest. In general appearance it resembles the ordinary horse-shoe stand, but it has no mirror, and the stage, which is made adjustable in height, may also be removed altogether.

With very low powers the specimen may be illuminated by diffused daylight or artificial light falling freely upon its surface. With higher powers an illuminator is used which fits the tube of the microscope, and is provided with an extension to receive the eye-piece. The illuminator consists of a thin plate of glass placed at an angle of 45° with regard to the axis of the tube, and of a condensing lens whose focal length is equal to the sum of distances between the lens and the plate of glass, and between the latter and the object.

The question of illumination is a very important one, to which great attention is to be devoted.

As source of light the 'Auer,' a triplex burner, adjustable in height, may be recommended;² it is placed at a distance of one metre from the illuminator. The flame is surrounded by an iron or asbestos cylinder, with only the necessary aperture for illumination of the object. The source of light should be at exactly the same level with the lens, *b*, of the illuminator. On removing the eye-

¹ *Central Zeitung für Optik und Mechanik*, No. 17, 1897.

² Supplied by Reichert.

piece and looking through $O c$, it will generally be found that the microscopical field is not evenly illuminated; the light should then be lowered or raised until perfectly uniform illumination is obtained.

The beam of light received by the lens, b , is made to converge, and

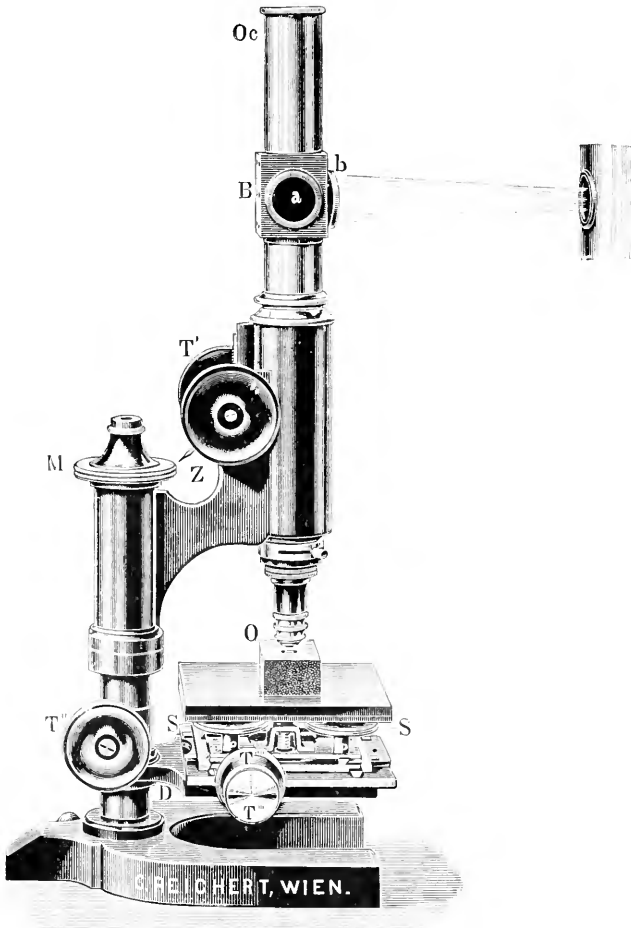

FIG. 207.—Reichert's microscope for the examination of metals (1897).

is reflected downwards, in the direction of the axis of the instrument, by the glass-plate, a . It is then condensed upon the object by the lenses of the objective itself. The illuminated object sends back a portion of the light, which passes through the objective and the plate a , reaching the eye at $O c$.

The object to be examined should have two parallel surfaces, so

that it may be placed on the stage of the microscope in a perfectly horizontal position. With a view of compensating for small deficiencies in the parallelism of the two surfaces, the stage is provided with the screws, SS, by which means it may be tilted, and the upper surface of the object made to lie in a truly horizontal plane, which of course is necessary in order to place the entire field in the focus of the instrument. The stage is a mechanical one, the milled heads, T''' and T''', imparting to it a forward and backward movement and a lateral movement respectively.

After the source of light has been placed in the most desirable position for the examination of a certain specimen, if a sample of different thickness be placed on the stage, the microscope must be lowered or raised, with the result that the light is no longer in the proper position and must again be adjusted. To avoid this troublesome manipulation, the stage of the microscope is made adjustable in height by turning the milled head T''. When the object is too thick to be placed on the stage, the latter may be turned to one side and the preparation laid on the foot of the microscope. For still larger pieces of metal, the stage may be removed altogether, the body of the instrument turned around 180°, and the metal placed on the table by the side of the stand: or the body of the microscope is connected directly with its foot, for which purpose the intermediate piece bearing the stage must be removed.

Prof. Rejtö's method for the preparation of the sample is as follows:—

The piece of metal to be examined has two of its sides planed off and made parallel. The upper surface is polished until it is free from scratches. It is then washed with absolute alcohol, and wiped with a soft clean cloth in order to remove all fatty substances. The polished surface is next surrounded with a layer of wax so as to form a rim projecting a little above the surface. Being placed horizontally, pure concentrated hydrochloric acid is poured over it to a depth of about three millimetres, and allowed to act for five minutes. It is then poured off, and the surface covered with concentrated ammonia. The wax is removed, and the surface wiped dry with a soft cloth. A little oil is next poured over it and allowed to remain for fifteen minutes.

It is then dried again and rubbed on a piece of chamois leather until it assumes a shiny appearance.

When large pieces of metal are to be examined, small portions must be polished by hand and etched as described above.

Figs. 208 and 209 are photomicrographs taken with this instrument, which are self-explanatory of the nature of the work it does.

Tank microscopes (also called aquarium microscopes) have, for certain kinds of work, a value of their own. They may be used with low powers outside the glass or above the water: or the object glass may be protected by a water-tight tube outside it, and with a disc of glass fixed (also water-tight) into that end of the tube which stands below the front lens of the objective, at a proper distance for the focus, may then be plunged into the aquarium. Indeed, the tube of the instrument may be so protected as to work

for some depth, and have some range in the water of a good-sized tank.

A beautiful instrument of this class has been devised by Mr. J. W. Stephenson for the examination of living objects in an aquarium. A brass bar is laid across the aquarium as shown in the woodcut

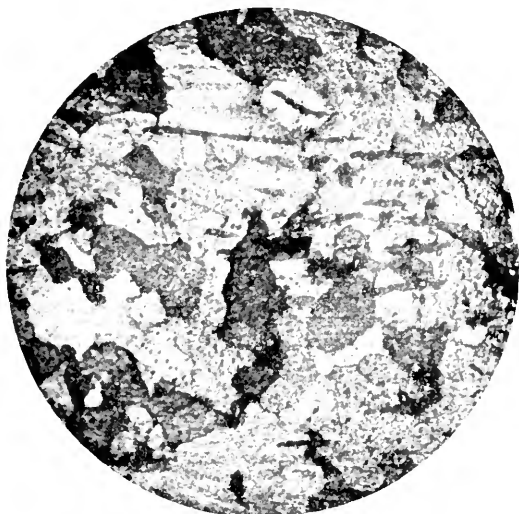

FIG. 208.—Wrought iron magnified 250 diameters.

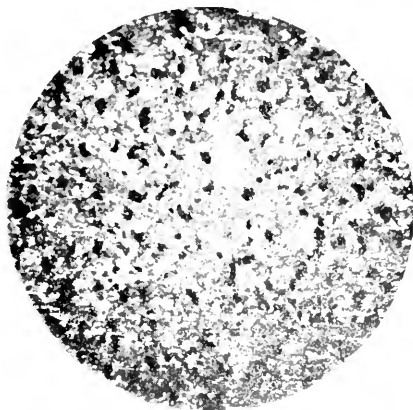

FIG. 209.—Ordinary steel magnified 250 diameters.

(fig. 210). To adjust it to aquaria of different widths the support on the left is made to slide along the bar, and it can be clamped at any given point by the upper milled head. The milled head at the side, by pressing on a loose plate, fastens the bar securely to the aquarium.

Between the ends of the bar slides an arm carrying a sprung socket, and the arm can be clamped at any given point of the bar. Through the socket is passed a glass cylinder, cemented to a brass collar at the upper end, and closed at the lower by a piece of cover-glass. Into this cylinder is screwed the body-tube of the microscope with eye-piece and objective, which are thus protected from the water of the aquarium. The microscope is focussed by rack and pinion (milled head just below the eye-piece), and in addition the objective is screwed to a draw-tube, so that its position in the cylinder may be approximately regulated.

The arm of the socket is hinged to allow of the microscope being

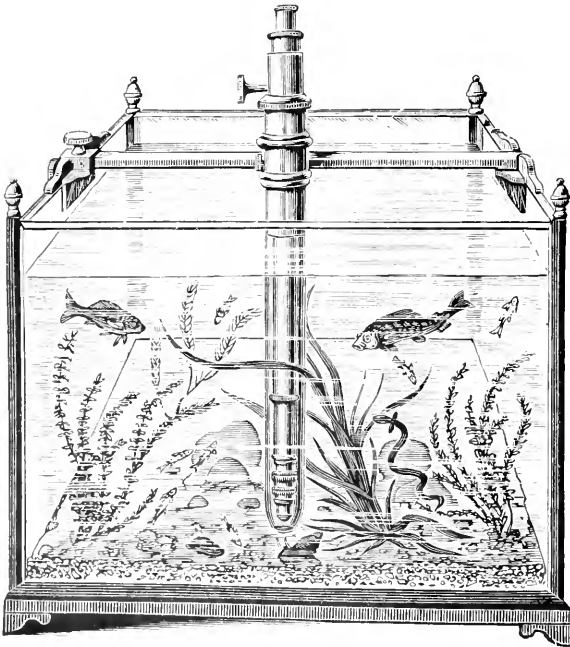

FIG. 210

inclined in a plane parallel to the sides of the aquarium. The lower milled head clamps the hinge at any desired inclination.

The socket also rotates on the arm, so that the microscope can be inclined in a plane parallel to the front of the aquarium. Thus any point of the aquarium can be reached.

As an adjunct, and admirable aid to the student of the tank and pond, as well as a simple and easy means by which specific forms of microscopic life may be found and readily taken, we call attention to the tank microscope of Mr. C. Rousselet. It is illustrated in fig. 211 and scarcely needs further description.

One of Zeiss's Steinheil aplanatic lenses, to which we have

referred, is carried on a jointed arm, which is clamped to the tank,¹ the tank being nowhere deeper than the range of focus of the lens employed. The arm moves on a plane parallel to the side of the tank, and the lens is focussed by means of a rack and pinion, arranged upon the body of the clamp, as seen upon the left-hand corner of the figure. The following points will recommend themselves to those who are in the habit of looking at their captures with the pocket lens in the ordinary way :—

When an object of interest is found, it can be followed with the greatest ease and taken up with a pipette, both hands being free for this operation.

It so frequently happens that a minute object is lost simply by removing the pocket lens for an instant to take up the pipette ; in the above apparatus the lens remains in the position in which it has been placed. By a new process glass tanks are made with melted seams ; these cannot possibly leak, and are to be preferred to those with the ordinary cemented joints.

¹ We prefer to have a stand or 'rest' for the tank, and on one side of this a firm pillar to which (and not to the side of the aquarium) the jointed arm is clamped. This enables shallower and deeper tanks to be employed without shifting the rack carrying the lens.

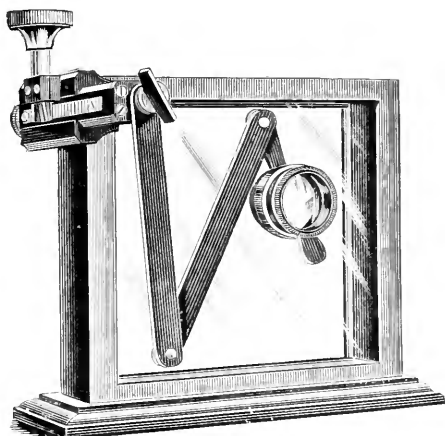

FIG. 211.—Rousselet's aquarium microscope.

CHAPTER IV

ACCESSORY APPARATUS

This chapter on apparatus accessory to the microscope might be easily made to occupy the whole of the space we propose to devote to the entire remainder of the book: the ingenuity of successive microscopists, and the variety of conditions presented by successive improvements in the microscope itself, have given origin to a variety of appliances and accessory apparatus that it would be futile in a practical handbook to attempt to figure and describe. We propose, therefore, only to describe, and to explain the mode of successfully employing, the essential and the best accessories now in use, neglecting, or only incidentally referring to, those which are either supplanted, or which present modifications either not important in themselves or accounted for by the fact of their production by different opticians.

I. Micrometers and Methods of Measuring Minute Objects.—It is of the utmost importance to be able with accuracy, and as much simplicity as possible, to measure the objects or parts of objects that are visible to us through the microscope.

The simplest mode of doing this is to project the magnified image of the object by any of the methods described under 'Camera Lucida and Drawing.' We carefully trace an outline of the image, and then, without disturbing any of the arrangements, remove the object from the stage, and replace it with a 'stage micrometer,' which is simply a slip of thin glass ruled to any desired scale, such as tenths, hundredths, thousandths of an inch and even less. Trace now the projected image of this upon the same paper, and the means are at once before us for making a comparison between the object and a *known scale*, both being magnified to the same extent. The amount of magnification in no way affects the problem. Thus, if the drawn picture of a certain object exactly fills the interval between the drawing representing the $\cdot 01$ inch, the object measures the $\cdot 01$ inch, and whether we are employing a magnifying power of a hundred or a thousand diameters is not a factor that enters into our determination of the size of the object. In fact, all drawings of microscopic objects are rendered much more practically valuable by having the magnified scale placed beneath them, so that measurements may at any time be made.

In favour of the above method of micro-measurement, it will be noted (1) that no extra apparatus is required, (2) that it is extremely simple, and (3) that it is accurate.

The most efficient piece of apparatus for micro-measurement is without doubt the SCREW-MICROMETER EYE-PIECE; it was invented by William Gascoigne in 1639 for telescopes, and if well constructed is a most valuable adjunct to the microscope. It is made by stretching across the field of an eye-piece two extremely fine parallel wires, one or both of which can be separated by the action of a micrometer screw, the circumference of the brass head of which is divided into a convenient number of parts, which successively pass by an index as the milled head is turned; it is seen in fig. 212. B. A portion of the field of view on one side is cut off at right angles to the filaments by a scale formed of a thin plate of brass having notches at its edge, whose distance corresponds to that of the threads of the screw, every fifth notch being made deeper than the rest to make the work of enumeration easier. Formerly one filament was stationary, the object being brought into such a position that one of its edges appeared to touch the fixed wire, the other wire being moved by the micrometer screw until it appeared to lie in contact

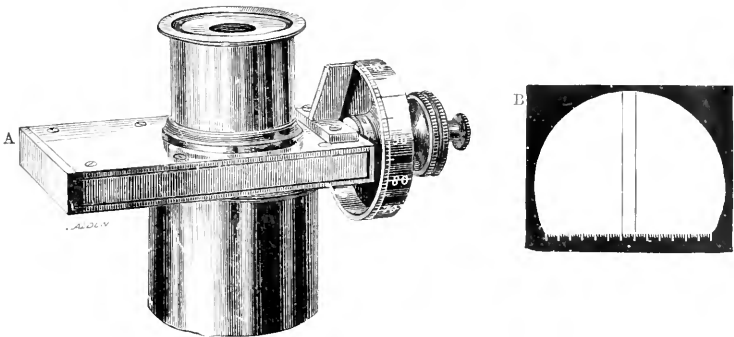

FIG. 212.—The micrometer eye-piece.

with the other edge of the object; the number of entire divisions on the scale then showed how many complete turns of the screw had been made in the separation of the wires, while the number of index-points on the edge of the milled head showed the value of the fraction of a turn that might have been made in addition. Usually a screw with 100 threads to the inch is employed, which gives to each division in the scale in the eye-piece the value of $\frac{1}{100}$ th of an inch, whilst the edge of the milled head is usually divided into 100 parts.

Both wires or filaments have since been made to move, a screw and divided head being fixed to the stationary wire. There is no advantage in this plan, and it involves needless complexity in calculation. The best method, there can be no doubt, is the one employed by Mr. Nelson, which is to have one thread fixed, but *not* in the *centre* of the eye-piece, but five notches in the scale from the centre on the side furthest from the screw-head. This not only permits of a much larger object being spanned, but also keeps the average of measurements in the middle of the field. This is not only

convenient but important, because the magnification is not uniform throughout the field. If the power employed is high, in order to effect the span of the great magnification, one wire (the fixed *central* one) will be in the middle of the field, the other at the margin, and the comparison will not be true on account of the unequal magnification of the eye-piece throughout the field, whereas if the wire be placed five notches on one side, both measurements are brought more within the centre of the field.

Messrs. Zeiss now make a Ramsden *micrometer eye-piece*. It is provided with a glass plate with crossed lines, which together with the eye-piece are carried across the image formed by the objective by means of the measuring screw, so that the adjustment always remains in the centre of the field of view.

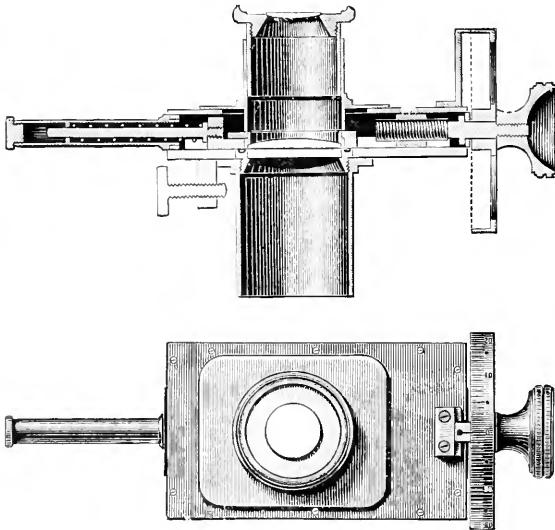

FIG. 213.

Fig. 213 illustrates this instrument, complete and in longitudinal section.

Each division on the edge of the drum corresponds to 0.002 mm. Whole turns are counted on a numbered scale seen in the visual field, and the image may be measured up to 8 mm.

A modification of this instrument, facilitating both accuracy and simplicity, was in 1890 devised by Mr. Nelson,¹ of which we think highly, and of which we give an illustration in fig. 214.

This screw micrometer eye-piece differs from those of the old form mainly in two respects: first, the optical part is compensated; secondly, the micrometer part with both webs can be made to traverse *en bloc* the field of the eye-piece by screw motion.

More particularly speaking, the instrument consists of two parts:

¹ *Journ. R. M. S.* 1890, p. 508.

one, a flat rectangular box containing the fixed and movable webs, the micrometer screw, and divided head complete; the other part may be called an 'eye-piece adapter,' with an outer case to hold the above-mentioned rectangular box.

The flat inner box has a screw attached to it which engages with a head on the exterior of the outer box. This gives about one inch of screw movement to the inner box, which causes the webs to traverse the field of the microscope. It must be remembered that this in no way affects the movement of the movable web from the fixed, which can alone be accomplished by turning the graduated micrometer head as in the old form.

The 'eye-piece adapter' portion of the instrument is, as its name implies, merely an adapter to take the optical part of positive compensating eye-pieces of various powers.

Immediately below the web is an iris diaphragm. This permits a diaphragm to be used suitable to the power of the eye-piece employed. A guiding line at right angles to the webs has been added. Care must be taken to observe that when the movable web coincides precisely with the fixed web, the indicator on the graduated head stands at zero. If this is *not* the case, the finger screw must be loosed, which will liberate the graduated head, and then it can be placed in its proper position and fixed. This is of universal application to all screw micrometers.

Four points are gained by this arrangement:—

(1) The compensating eye-piece yields far better definition when measuring with apochromatic objectives than either the Huyghenian or Ramsden forms.

(2) Different-powered eye-pieces can be employed.

(3) By means of the screw which moves the micrometer webs across the field it is possible to perform measurements with the webs equidistant from the centre of the field, and thus eliminate errors due to distortion.

(4) The preceding advantage is secured without sacrificing the benefit of a fixed zero web.

Messrs. Zeiss have since adapted the compensating eye-piece to their best screw micrometer.

To use the screw micrometer with success it should not be inserted, as the custom has been, like an ordinary eye-piece into the tube of the microscope, but *it should have a firm stand quite independently*, preventing actual contact with the body-tube.

Plate II. gives the mode of its employment, the illustration being made from a photograph by Mr. Nelson. The micrometer eye-piece, it will be seen, is fitted into a stand wholly independent of the

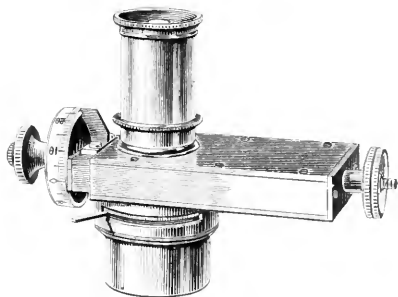

FIG. 214.—Nelson's new form of screw micrometer eye-piece.

microscope. This consists of a strong upright, fitted into a massive tripod or circular foot. The foot in either case only rests on three points; the upright is capable of telescopic extension by a clamping tube; a short tube which takes the eye-piece is fixed to this upright by a compass joint.

To use it, the object to be measured is placed in position, and the microscope inclined in the usual way. The ordinary eye-piece is removed, and the separate stand with the micrometer in its place is put in front of the microscope, the extension tube being raised or lowered until the tube at the top of it, carrying the micrometer, is made continuous with the tube of the microscope, as seen in the drawing. It is well to leave from $\frac{1}{8}$ th to $\frac{3}{16}$ ths of an inch of space between the body-tube and the micrometer tube. It will be now needful to employ corrections to compensate for the increased length of tube. If the objective be provided with a 'correction collar' the adjustment must be re-corrected; but if it is not so provided the tube of the microscope must be shortened exactly as much as the tube carrying the micrometer will have lengthened it.

By this arrangement it will be found that manipulation can be effected without the vibration of the microscopical image which is inevitably the result of the revolving of the micrometer screw head when the micrometer eye-piece is placed, as it usually has been, in the body-tube of the microscope. The consequence is that much more minute spaces can be measured, and with much greater accuracy. Mr. Nelson has repeatedly spanned the $\frac{1}{1000}$ th of an inch by means of a stage micrometer in the focus of the objective; this was replaced by a mounted specimen of *Amphipleura pellucida*, and he has counted ninety-six lines in the $\frac{1}{1000}$ th of an inch by making the movable wire pass successively over them until the fixed wire was reached. By similar means the Editor has measured single objects less than the $\frac{1}{100000}$ th of an inch.

It will have been premised by the careful reader that the stage micrometer must be used in every set of measurements; at least we would strictly emphasise this as the only accurate and scientific method. It has been advised that a record of comparisons with the various lenses in the possession of the microscopist should be made once for all. We decidedly deprecate this method, unless it be in such utterly valueless work, as is sometimes done, where lenses are uncorrected and accuracy of tube-length forgotten or ignored. The correction of an objective and the tube-length ought to vary with every object, and therefore a comparison of the stage-micrometer and the screw-micrometer should be made with every set of measurements.

Moreover, the majority of stage micrometers exhibit very considerable discrepancies in the several intervals between the lines; it is well in the interests of accuracy to take the screw value of each under a high power, find the value of the average, and then note the particular space or spaces that may be in agreement with the average and always use it. An illustration will make this clear.

Zeiss provides a stage micrometer of 1 mm. divided into .1 and

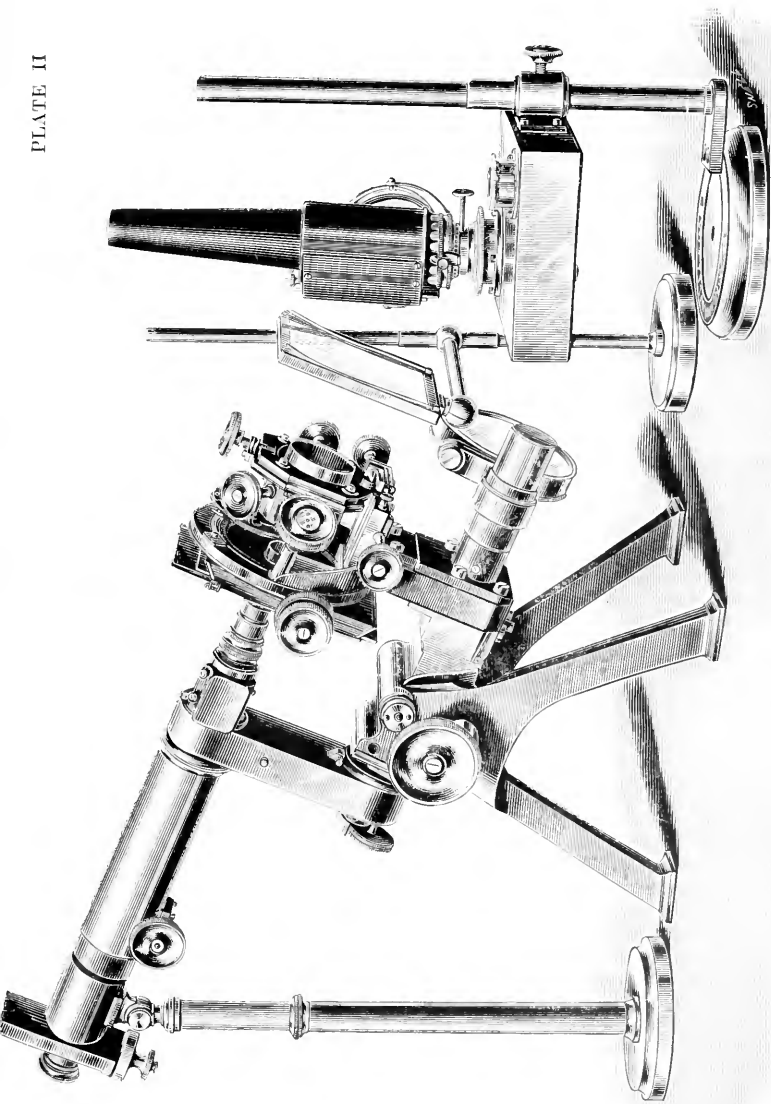

THE ARRANGEMENT OF MICROSCOPE WITH STAND FOR MICROMETER EYE-PIECE AS EMPLOYED TO SECURE STEADINESS AND ACCURACY IN MEASUREMENT

·01. The following are the actual values obtained for each of the ·05 divisions, viz. :—

8·40
8·37
8·38
8·38
8·36
8·36
8·58
8·33
8·31
8·47
8·33
8·33
8·38
8·44
8·38
8·40
8·37
8·40
8·25
8·38
20)16·760
8·38 mean value.

In this instance it will be seen that the last division, 8·38, agrees with the mean, and is the best for all future use.¹

Having thus obtained a screw-micrometer value for a certain known interval, the screw-micrometer value for any other object being known, the size of the object may be found by simple proportion: thus, viz. if 8·38 is the screw-micrometer value for ·05 mm. and 6·45 that for a certain object, the size of the object is

$$(i) \quad 8\cdot38 : 6\cdot45 :: \cdot05 : x \text{ mm.} ;$$

$$x = \frac{6\cdot45 \times \cdot05}{8\cdot38} = \cdot0385 \text{ mm.}$$

If the answer is required in fractions of an English inch, all that we need remember is that 1 inch=25·4 mm.; then

$$(ii) \quad 8\cdot38 : 6\cdot45 :: \frac{\cdot05}{25\cdot4} : x \text{ inch} ;$$

$$x = \frac{6\cdot45 \times \cdot00197}{8\cdot38} = \frac{\cdot0127}{8\cdot38} = \cdot001515 \text{ inch.}$$

If the stage-micrometer is ruled in fractions of English inches, then suppose the screw-micrometer value for $\frac{1}{1000}$ th inch=4·257, and that for the object=6·45 as before,

$$(iii) \quad 4\cdot257 : 6\cdot45 :: \cdot001 : x \text{ inch} ;$$

$$x = \frac{6\cdot45 \times \cdot001}{4\cdot257} = \cdot001515 \text{ inch.}$$

¹ In the number given for screw value the whole number stands for a complete revolution or number of revolutions of the screw head, and the decimal, the portion of a revolution read off beyond this.

If the answer is required in metrical measurement, then as 1 inch = 25.4 mm.,

$$(iv) \quad 4.257 : 6.45 :: (.001 \times 25.4) : x \text{ mm.};$$

$$x = \frac{6.45 \times .0254}{4.257} = \frac{.1638}{4.257} = .0385 \text{ mm.}$$

In this connection it will be as well to give two examples of scale comparison which are sometimes required. Thus you have a certain interval on a metrical stage micrometer which you know to be accurate, and you wish to compare an English stage micrometer with this scale in order to find out which particular interval of $\frac{1}{1000}$ inch agrees with it. Suppose .05 mm. = 8.38 screw value as above, then all that is necessary is to find the point to which the screw micrometer must be set in order that it may accurately span the $\frac{1}{1000}$ inch. Take 1 inch = 25.4 mm. as before; then .001 inch = .0254.

$$(v) \quad .05 \text{ mm.} : .0254 \text{ mm.} :: 8.38 : x \text{ screw value};$$

$$x = \frac{.0254 \times 8.38}{.05} = 4.257 \text{ screw value.}$$

Conversely, if a metrical scale is to be compared with an accurate English one where .001 inch = 4.257 screw value, then the screw value for .05 mm. may be found thus: .001 inch = .0254 mm.

$$(vi) \quad .0254 \text{ mm.} : .05 \text{ mm.} :: 4.257 : x \text{ screw value};$$

$$x = \frac{.05 \times 4.257}{.0254} = 8.38 \text{ screw value for .05 mm.}$$

A cheap substitute for the screw micrometer has been devised by Mr. G. Jackson. It consists in having a transparent arbitrary scale

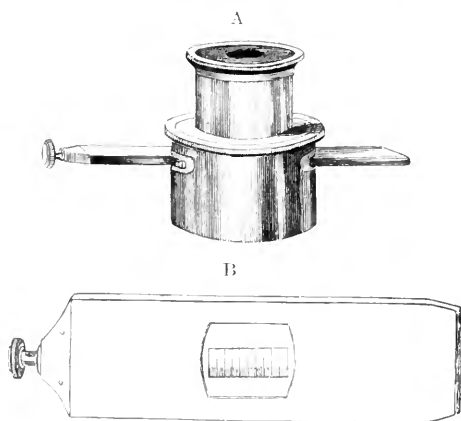

FIG. 215. Jackson's eye piece micrometer.

inserted into an ordinary Huyghenian eye-piece in the focus of the eye-lens, so that it will be in the same plane as the magnified image of the object to be measured. It is seen in fig. 215. The method of using it is precisely similar to that of the screw micrometer; the value of $\frac{1}{1000}$ inch or $\frac{1}{10}$ mm., as the case may be, is found in terms of the arbitrary scale. The value of

the object in terms of the same scale is also found, and comparison made accordingly. All that need be done is to substitute the terms of the arbitrary scale for screw values in the preceding examples, and they will meet the case.

The arbitrary scale should be capable of movement by a screw, otherwise the appliance is hardly as accurate as the first method of micrometry by simple drawing described above.

Of all the methods of micrometry the most accurate is that performed by photo-micrography. A negative of the object to be measured is taken, and then, without any alteration in tube- or camera-length, the magnified image of the stage micrometer is projected on the ground glass; this is spanned by means of a pair of spring dividers. The negative film is then scratched by these dividers. Then you are in a position to make the most accurate measurement the microscope is capable of yielding.

It is exceedingly important, when performing micrometric measurements, to remember that the precise edges of all objects in the microscope are never seen. Consequently it is impossible to ascertain from what point to what point the measurement is to be made.

This, while hardly affecting large and coarse objects, becomes supremely important with small objects.

Instead of a real edge to an object you get diffraction bands. These bands alter with focus, and also to a greater extent with the angle of the illuminating cone as well as with the aperture of the objective. Hence it ensues that the accurate micrometry of delicate objects presents one of the most difficult matters encountered in practical microscopy. At the present time opinions differ greatly as to the treatment of particular cases.

The following plan of Mr. Nelson's is the outcome of a long series of experiments:—

1. The focus and adjustment to be chosen may be termed that of the 'black dot' (see Elimination of Errors of Interpretation); in other words, if the object were a slender filament it would be represented white with black edges. These black edges are due to diffraction. If the filament is very slender and the illuminating cone small, there may be seen a white diffraction edge outside the black one, and perhaps another faint black one outside that again.

2. Reduce as far as possible the extent of these diffraction bands by (*a*) using an objective with as large an aperture as possible: (*b*) by using as large an illuminating cone as possible.

3. Measure from the inner edge of the inner diffraction band to the inner edge of the inner diffraction band on the opposite side.

4. But if the diameter of a hole be required, then the measurement must be made from the outer edge of the outer black diffraction band to the outer edge of outer diffraction band on the opposite side. It must not be forgotten, however, that these rules only apply for a particular focus and a particular adjustment.

II. The Camera Lucida and its Uses.—There are a large number of contrivances devised for the purpose of enabling the observer to see the image of an object projected on a surface upon which he may trace its outlines, but they resolve themselves practically into two kinds, viz.:—

1. Those intended for use when the microscope is in a horizontal position.

2. Those provided for it when used in a vertical position.

We shall describe what we consider the most practical forms of each.

In point of antiquity *Wollaston's camera lucida* claims the post of honour; but to use it the microscope must be placed in a horizontal position. Its general form is shown in fig. 216. The rays on leaving the eye-piece, above which it is fixed by a collar, enter a prism, and after two internal reflections pass upwards to the eye of the observer. It is easy to see a projection of the microscopic image with this instrument, but it is when we desire at the same time to see the paper and the fingers holding the pencil that the difficulty begins. The eye has to be held in such a position that the edge of the prism bisects the pupil, so that one-half of the pupil receives the microscopic image and the other half the images of the paper and the hand employed in drawing. If this bisection is not equal, too much of one image is seen at the expense of the other. This was in some sense supposed to be compensated by the use of lenses, as seen in the figure; but the difficulty of keeping the eye precisely in one position has caused this instrument to fall into disuse, several cameras being now devised free from this defect. It has nevertheless one special point in its favour—it does not invert the image, causing the

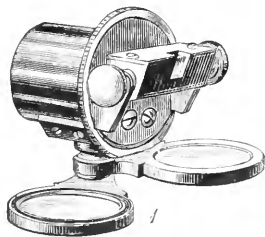

FIG. 216.

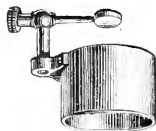

FIG. 217.—Simple camera.

right to be turned to the left, and *vice versa*. This is an advantage the value of which we shall subsequently see.

A simple camera was made by Soemmering by means of a small circular reflector, usually made of highly polished steel, which is placed in the path of the emergent pencil at an angle of 45° to the optic axis, thus reflecting rays from the image upwards. The instrument, though rarely used now, is shown in fig. 217, and slides on to the eye-piece. The reflector must be smaller than the pupil of the eye, because it is through the peripheral portion of the pupil that the rays, not stopped out by the mirror, come from the paper and pencil. Hence, as in the case of *Wollaston's camera*, the pupil of the eye must be kept perfectly centred to the small reflector. As there is but one reflection, the image is inverted, but not transposed. To see the outline of the image as it is in the microscope, the drawing must be made upon tracing paper, and inverted, looking at it as a transparency from the wrong side.

There is considerable variety in the experience of different microscopists as to the facility with which these two instruments can be used. The difference in all probability depends on the

greater normal diameter of the pupils of the eyes of some observers in comparison with that of others'.

Dr. Lionel Beale devised one of the simplest cameras, which has the advantage of being thoroughly efficient. It consists of a piece of tinted glass placed at an angle of 45° to the optic axis, in the path of the emergent pencil. The idea was first suggested by Amici, but he employed uncoloured glass; Dr. Beale made it practical by the employment of tinted glass. The first surface of the glass reflects the magnified image upwards to the eye, the paper and pencil being seen through the glass. In its simplest form it is seen in fig. 218. The glass is tinted to render the second reflection from the internal surface of the glass inoperative. The reflection of the image is identical with that of Soemmering's.



FIG. 218.
Beale's camera.

Another camera lucida of some merit is that devised by Amici, and adapted to the horizontal microscope by Chevalier. The eye looks through the microscope at the object (as in the ordinary view of it), instead of looking at its projection upon the paper, the image of the tracing point being projected upon the field—an arrangement which is in many respects more advantageous. This is effected by combining a perforated silver-on-glass mirror with a reflecting prism; and its action will be understood by the accompanying diagram (fig. 219). The ray ab proceeding from the object, after emerging from the eye-piece of the microscope, passes through the central perforation in the oblique mirror M , which is placed in front of it, and so directly onwards to the eye. On the other hand, the ray a' , proceeding upwards from the tracing point, enters the prism P , is reflected from its inclined surface to the inclined surface of the mirror M , and is by it reflected to the eye at b' , in such parallelism to the ray b proceeding from the object that the two blend into one image.

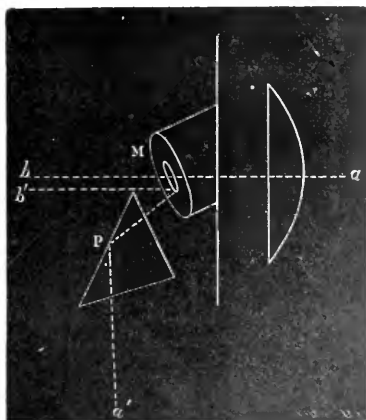

FIG. 219.

A valuable and simple little camera was devised by Mr. E. M. Nelson in 1894.¹ It takes into account the fact that while that form known as Beale's neutral tint (fig. 218) has been of great value and persistence, it is yet a defective form; the microscopic image as received at the eye-piece is inverted and transposed. Beale's camera corrects the inversion, while it leaves the transposition unaltered; therefore all the objects drawn with this camera are unlike the originals. In illustration place the letter **F** on

¹ *Journ. R. M. S.* 1895, p. 21 *et seq.*

the stage in the position as here printed; when examined by the microscope it will appear thus **3**. In order to look at this letter as the original, all that we have to do is to turn this paper round. But this object, as drawn by a Beale's camera, will appear **7**, and no turning of the paper can cause it to appear as the original; it will only become so when it is viewed as a transparency from the other side of the paper.

This is, of course, important in many matters with which the microscopic biologist is concerned.

In many forms of camera this difficulty has been overcome by reflecting the image of the paper and pencil down the tube of the microscope. The drawing there made will be inverted and transposed, but by turning the picture round we at once get a correct representation of the object itself.

The new camera devised by Mr. Nelson consists of a right-angled prism or small glass mirror fixed at an angle of 45° to an eye-piece cap. This, when the microscope is placed in a horizontal position, reflects the rays horizontally and at right angles to the optic axis; these rays then fall on a piece of neutral-tint glass placed at an angle of 45° to those rays so as to reflect them upwards to the eye.

The mirror corrects the transposition, and the neutral-tint the inversion; *an erect image is therefore seen on the table.* The neutral-tint glass is mounted on a pivot so that it may be turned round at a right angle: this adapts the instrument for use with either the right or left eye. Should the light be too strong, it must be modified by screens, not by change of focus in the condenser, assuming that the perfect image has been obtained.

On the important subject of the inversion and transposition of microscopic images brief but valuable data are given and put in the clearest light, thus:—

		3		4
		Image projected on screen or on sensitive plate.		Image seen through ground glass.
		7		F
		5		6
		Image seen through Woll- aston's camera.		Image seen through Beale's neutral tint or Soemmering's reflector.
		3		7
		7		8
		Image projected on table by 45° mirror or right- angled prism, as devised by C. W. Cooke.		Image seen through Nel- son's camera.
		F		3
1	2			
Object on the stage.	Image seen through the eye-piece.			
F	3			

The instrument referred to in (7) of the above table of inversion and transposition in microscopic images is a somewhat distinct form of camera called by Mr. Conrad W. Cooke, who devised it in 1865, a 'Micrographic Camera.' The projection of the image is dependent on a silvered mirror fixed at 45°, or a right-angled prism. By the arrangement of this instrument an image can be thrown on a sheet of paper placed in a horizontal position, so that one can readily trace

on the paper the outlines and details of the image with ease and accuracy; only it must be remembered that the mirror or prism erects the inverted image (No. 2 in the above table), but its transposition is due to the fact of its not being viewed as a transparency.

This instrument is also useful for the purpose of demonstrating where two or three persons may at the same time examine the image, and it can be used on many opaque objects, and objects presented by dark ground illumination; but to use it the external light must be carefully screened from the observer.

Coming now to the second group of cameras, there stands first on the list an instrument devised by Professor Abbe; although, like many 'new' apparatus for the microscope, the idea it embodies is not a new one, but was suggested for micrometric purposes by Mr. G. Burch in 1878 (*Journ. Quek. Micro. Club*, v. p. 47). We have used this admirable instrument with complete success.

The accompanying drawing (fig. 220) will at once show the simplicity of its action. The image of the paper and pencil coming, say, in a vertical direction (S_2 fig. 220), is reflected by a large mirror

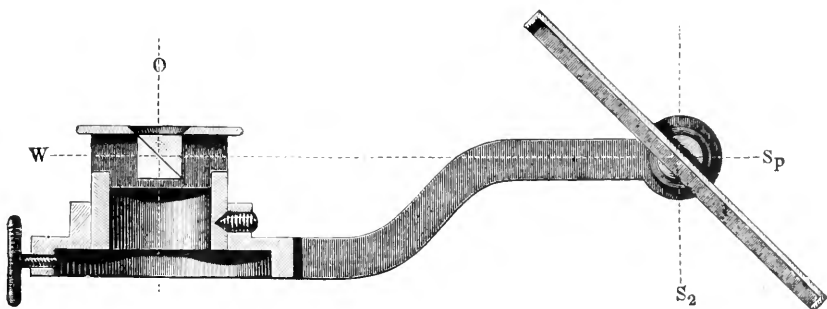

FIG. 220.—Abbe's camera lucida.

in a horizontal direction, W , to a cube of glass which has a silvered diagonal plane with a small circular hole in it in the visual point of the eye-piece. The microscopic image is seen directly through this aperture in the silvering of the prism, while the silvered plane of the prism transmits the image of the paper and the operator's fingers and pencil. By the concentricity thus obtained of the bundle of rays reaching the eye from both the microscope and the paper, the image and the pencil with which it is to be drawn are seen coincidentally without any straining of the eyes.

This instrument requires the paper to be placed in a plane parallel to that of the object; thus, if the microscope is vertical the paper must be horizontal, and *vice versa*, and it presents the image precisely as it is seen in the microscope. For the purpose of drawing simply, and where the observer has had no experience in the use of a camera lucida, we should be inclined to recommend this one as the instrument presenting to the tyro the greatest facility. But there is a use to be made of the camera lucida to which this one does not so readily lend itself, which is none the less of great importance: that is,

the determining of the magnifying power of objectives. It is manifest that the distance between the paper and the eye of the observer cannot be so readily determined in this case as in those forms of the instrument where the image of the paper and pencil is seen direct.

The same apparatus arranged so that the prism casing together with the mirror may be swung back while the clamping collar remains on the tube in its adjusted position, is shown in fig. 221. The mirror has a surface of 75×50 mm. (3×2 in.), and may be inclined at any angle between the horizontal plane and 45° , the latter position being marked by a stop. The length of the arm supporting the mirror being 10.5 cm. (4 in.), it is only with very large drawings necessary to incline or raise the drawing surface.

But the latest modification of this instrument is shown in figs. 222 and 223, where it will be observed that the camera is attached to the tube by means of the clamping-ring K, and the Abbe double

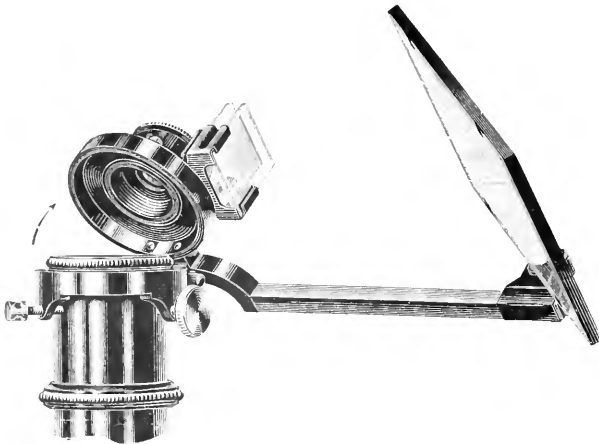

FIG. 221.—Abbe's camera, improved.

prism is centred by means of the screws L and H. The brightness of the drawing surface and the microscopic image is respectively regulated by a cap R encasing the prisms, which is provided with a clear opening and five moderating glasses of varying degrees of density, and by an eccentric disc B pivoted below the prisms, which is also provided with a clear opening and five moderating glasses.

In order to completely utilise the increased cone of emerging rays obtained with low magnifications, the usual prism, having in its silvering an aperture of 1 mm., can quickly and conveniently be exchanged for another with an aperture of 2 mm.

The prism, together with the moderating glasses, may be turned aside about the vertical pin Z into the position indicated by the dotted lines shown in fig. 222. When the prism is returned to its original position it is fixed by a catch, which is not externally visible.

In the use of a good drawing apparatus (I) the light from the

image must not to any serious extent be weakened by the light from the drawing material. (2) The image of the drawing paper must

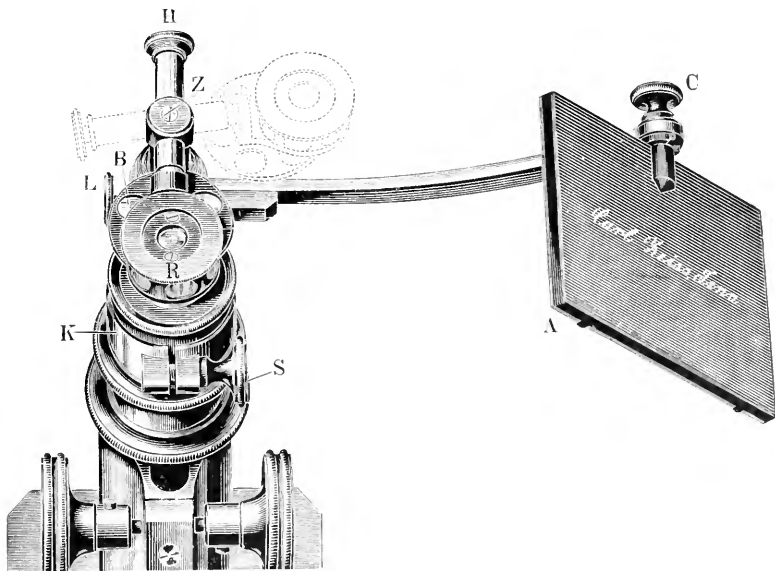

FIG. 222.—Latest modification of Abbe's camera

reach the eye with the least possible intensity and be coaxial with the microscopic image. (3) There should be an arrangement by which

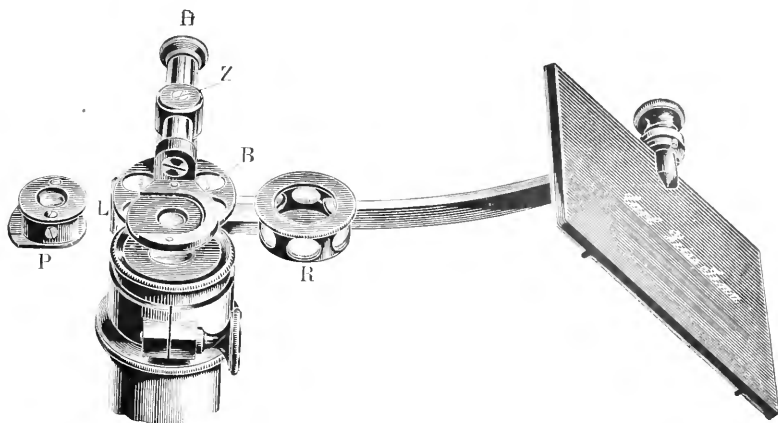

FIG. 223.

the relation of the intensities of these two images can be modified to suit each other. (4) The apparatus must be adjustable in height

and capable of being centred in its horizontal plane. (5) It should be possible to easily separate the apparatus from the eye-piece and replace it again in its former position at will. (6) The image of the plane of the drawing, and the image of the microscopic object projected on it, must be seen with the apparatus without distortion. As regards the first two conditions the arrangement of the original Abbe camera is adopted, viz. two rectangular prisms with the hypotenuses cemented together, of which one is silvered, with a small portion of the silver deposit in the centre taken away, and with these a second mirror A, fig. 222, for transmitting the image of the plane of the drawing to this prism. But since one and the same prism, with a fixed opening in its silver deposit, cannot suffice for all purposes and changes of magnification, an arrangement is added by which the prism P, fig. 223, with its fastening, can be easily taken out of the apparatus and replaced by another with an opening of different size.

With respect to the third condition securing a due relation between the intensities of the two images, an arrangement of two smoked-glass wedges was made to move over each other so as to form a plate of continuously varying thickness. This was most satisfactory but too costly, so smoked-glass plates were employed and set in the cylindrical wall of a small cap, R, figs. 222, 223, which was simply placed over the prism. Each smoked glass in turn can be interposed in the path of the rays by turning the cap on its upper edge until a small pin engages in a corresponding small hole on the lower edge of the cylinder. There are five smoked glasses of different densities of colour, while one aperture is left empty.

The adjustment in height is satisfied by the apparatus being attached to the body-tube by means of a clamping screw, while the adjustment from side to side is effected by the prism, together with the cap and smoked-glass disc, being centred from front to back by means of a screw, H, figs. 222, 223, working through a spring socket, and from right to left by means of a second screw L, against which works a counter-spring not shown in the figures.

In order to pass conveniently from observation through this apparatus to observation through the free eye-piece, the prism with its diaphragm arrangement can be rotated to one side about a vertical pin Z: the return of the prism to its central position is marked by a spring catch. To obtain drawings free from distortion, a drawing table similar to that described by Dr. Bernhard ought to be employed.¹

This useful instrument has, however, been modified and made simpler by more than one optical firm. Messrs. Swift have constructed a very handy and easily applied form, which is so arranged that the microscope may be employed with it not only in the vertical but also in an inclined position. It is illustrated in fig. 224.

This camera lucida is precisely on the same principle as the Abbe form used for the same purpose, but being manifestly less bulky it is far more convenient and easier to use, although less efficient for very careful work.

¹ *Zeitschr. f. wiss. Mikr.* xi. (1894), pp. 289-301.

When this form of camera is used, the paper upon which the object is received should be tilted to the same plane as the stage of microscope upon which the object rests, as this will prevent any marginal distortion.

Another extremely good and easily applied modification of the Abbe form is manufactured by Bausch and Lomb, and is illustrated in fig. 225. The Abbe prism is used as in the large Abbe drawing camera; the mirror is reduced in size and is fixed. The path of the light is seen to be the same as the white dotted lines and arrows show, as in the complete form of Abbe; and the camera may be swung back when not in use, as shown in the dotted outline. We can testify that the image of both object and pencil-point are clear, and this instrument can be used with most eye-pieces; but cannot for complete results be counted equal to the drawing camera of Abbe.

The Editor has used with great facility and success a camera devised by Dr. Hugo Schröder, and produced by Messrs. Ross. It is figured at 226, and consists of a combination of a right-angled prism (fig. 227) A B C, and a rhomboidal prism D E F G, so arranged that when



FIG. 224. — Swift's camera lucida on the Abbe principle.

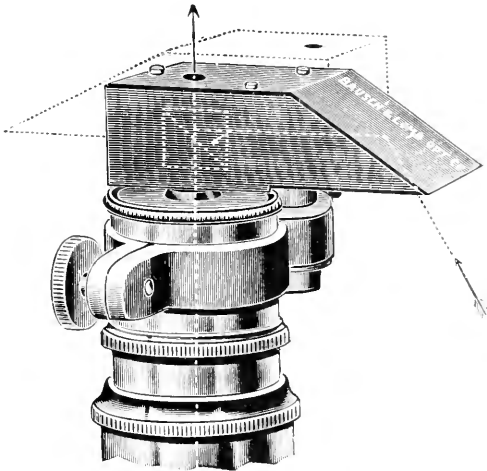

FIG. 225.—Bausch and Lomb's modification of Abbe's camera.

adjusted very nearly in contact (*i.e.* separated by only a thin stratum of air) the faces B C and D E are parallel, and consequently between D E and B E' they act together as a thick parallel plate of glass through which the drawing paper and pencil can be seen. The rhomboidal prism is so constructed that when the face G F is applied at right angles to the optic axis of the microscope, the axial ray H passes without refraction to J on the internal face E F; whence it is *totally* reflected to J in the face D G. At J a part of

the ray is reflected to the eye by *ordinary* reflection in the direction of $J K$, and a part transmitted to J' on the face $A C$ of the right-angled prism. Of the latter a portion is also reflected to K by ordinary reflection at J' . The hypotenuse face $A C$ is cut at such an angle that the reflection from J' coincides with that from J at the eye-point K , thus utilising the secondary reflection to strengthen the luminosity of the image. The angle G is arranged so that the extreme marginal ray H' from the field of the B eye-piece strikes upon $D G$ at a point just beyond the angle of total reflection, the diffraction bands at the limiting angle being faintly discernible at this edge of the field. This angle gives the greatest amount of light by *ordinary* reflection, short of *total* reflection.

In use, the microscope should be inclined at an angle of 45° , and the image focussed through the eye-piece as usual; the camera is then placed in position on the eye-piece, and pushed down until the image of the object is fully and well seen. The drawing paper must be fixed upon a table on a level with the stage immediately

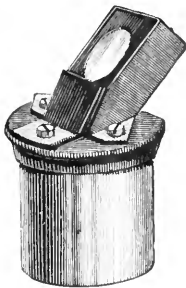

FIG. 226.—Schröder's camera lucida.

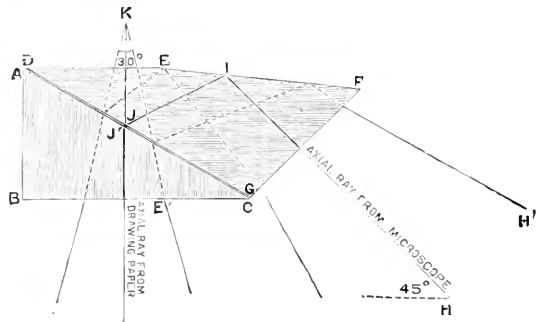
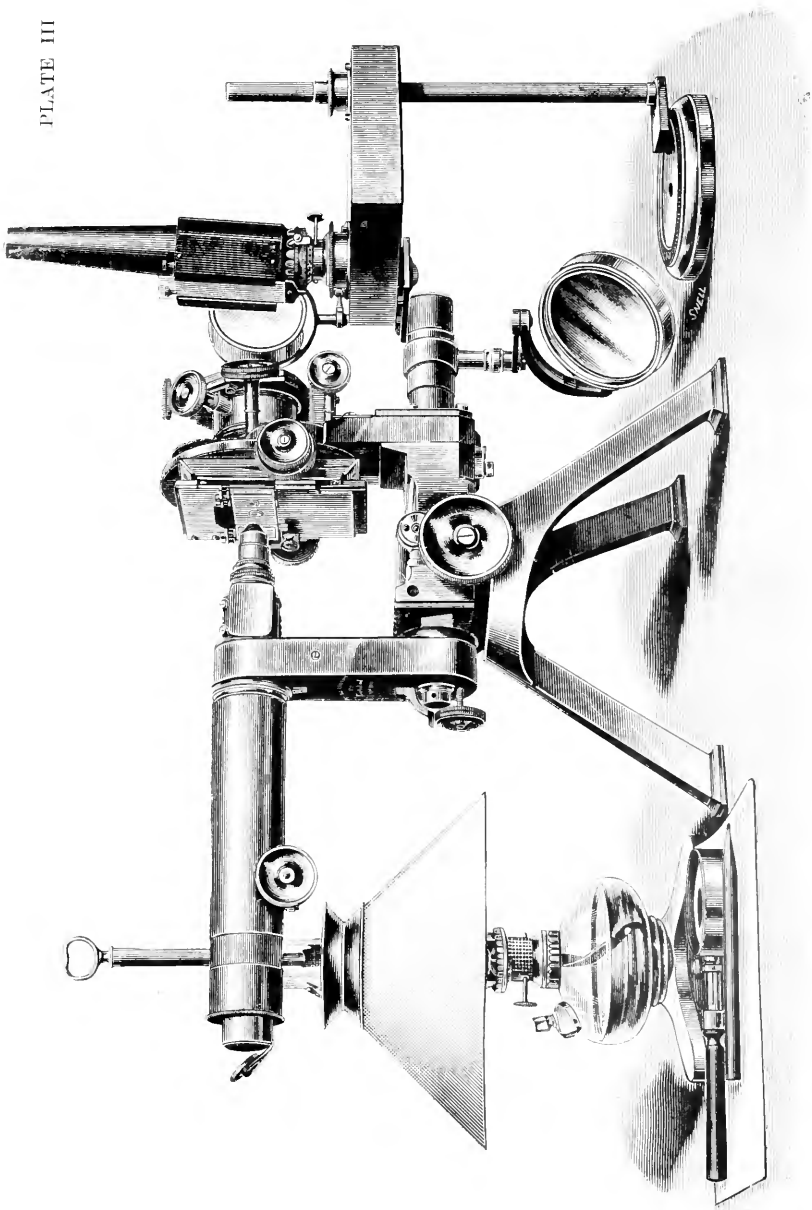

FIG. 227.—Diagram explaining Schröder's camera lucida.

under the camera. The observer will then see the microscopical image projected on the paper, and the fingers carrying the pencil point will be clearly in view, the *whole* pupil of the eye being available for both images, the diaphragm on the instrument being considerably larger than the pupil. The eye may be removed as often as required, and, if all is allowed to remain without alteration, the drawing may be left and recommenced without the slightest shifting of the image.

If a vertical position of the microscope be needful, this may be done by inclining the table and drawing paper to an angle of 45° either in front or at the side of the microscope. For accurate drawing, in all azimuths, the drawing paper should of course coincide with the plane of the optical image. When the paper is in its proper position, the limiting circle of the field of the microscope will be projected as a true circle, but if otherwise it will appear elliptical. It is recommended that a circle about the size of the field be drawn upon the paper, and its coincidence with the projected field compared.



ARRANGEMENT OF THE MICROSCOPE AND ACCESSORIES FOR THE EMPLOYMENT OF THE CAMERA LUCIDA.

This camera may be used with a hand-magnifier, or with simple lenses used for dissection and other purposes.

With one or other of the foregoing contrivances, every one may learn to draw an outline of the microscopic image; and it is extremely desirable for the sake of accuracy that every representation of an object should be based on such a delineation. Some persons will use one instrument more readily, some another, the fact being that there is a sort of 'knack' in the use of each which is commonly acquired by practice alone, so that a person accustomed to the use of any one of them does not at first work well with another. Although some persons at once acquire the power of seeing the image and the tracing point with equal distinctness, the case is more frequently otherwise; and hence no one should allow himself to be baffled by the failure of his first attempt. It will sometimes happen, especially when the Wollaston prism is employed, that the want of power to see the pencil is due to the faulty position of the eye, too large a part of it being over the prism itself. When once a good position has been obtained, the eye should be held there as steadily as possible, until the tracing shall have been completed. It is essential to keep in view that the proportion between the size of the tracing and that of the object is affected by the distance of the eye from the paper; and hence that if the microscope be placed upon a support of different height, or the eye-piece be elevated or depressed by a slight inclination given to the body, the scale will be altered. This it is, of course, peculiarly important to bear in mind when a series of tracings is being made of any set of objects which it is intended to delineate on a uniform scale.

A valuable adjunct to a camera lucida is a small paraffin lamp, seen to the left of plate III., which illustrates the correct method of using the camera lucida. This lamp is simple, and is capable of being raised or lowered, fitted with a paper shade, for a great deal of the success attendant on the use of the camera depends on the relative illumination of the microscopic image on the one side, and of the paper and fingers and pencil of the executant on the other. It is not a matter to be determined by rules; personal equation, sometimes idiosyncrasy, determines how the light shall be regulated. Many finished micro-draftsmen use a feeble light in the image and a strong light on the hand and paper, and others equally successful manipulate in the precisely reverse way. But upon the adjustment of the respective sources of light to the personal comfort of the draftsman will depend his success.

Care must be exercised in this work in the case of *critical images*. These must not be sacrificed either by racking the condenser into or out of focus, or by reducing its angle by a diaphragm. If the intensity of the light has to be reduced, it must be done by the interposition of glass screens, and this is beautifully provided in Abbe's camera. The illustration of how the various apparatus for the use of the camera lucida should be disposed, given in plate III., may be profitably studied. Both mirror and bull's-eye are turned aside, and the hand and pencil are illuminated by the shaded lamp.

The lamp illuminating the image is seen, with such a screen of

coloured glass as may be found needful, and the lamp illuminating the paper and pencil, and carefully shaded above, is also seen at the eye-piece end of the body-tube. Often, if the image is too bright, we find that bringing the lamp down to illuminate the paper more intensely suffices. If not, use screens; the illuminating cone must not be tampered with.

III. **The Determination of Magnifying Power** is an important and independent branch of this subject. For this purpose, and for the reason given above, Beale's neutral-tint camera¹ is eminently suitable—indeed, is the best. We can easily and accurately measure the path of the ray from the paper to the eye. What is necessary is to project the image of a stage micrometer on to an accurate scale placed ten inches from the eye-lens of the eye-piece. There must be complete accuracy in this matter.

We can best show how absolute magnifying power is thus determined by an example.

Suppose that the magnified image of two $\frac{1}{1000}$ ths of an inch divisions of the stage micrometer spans $\frac{8}{10}$ ths of an inch on a rule placed as required; then

$$(i) \quad .002 \text{ inch} : .8 \text{ inch} :: 1 \text{ inch} : x \text{ power};$$

$$x = \frac{.8 \times 1}{.002} = 400 \text{ diameters};$$

for it is obvious that under these conditions one inch bears the same proportion to the magnifying power that $\frac{1}{1000}$ ths of an inch bears to $\frac{8}{10}$ ths of an inch.

Suppose, now, as it sometimes happens, that the operator is provided with a metrical stage micrometer, but is without a metrical scale to compare it with, there being nothing but an ordinary foot-rule at hand.

Let it be assumed that the magnified image of two $\frac{1}{100}$ mm. when projected covers $\frac{8}{10}$ inch; then, as there are 25.4 mm. in one inch,

$$(ii) \quad .02 \text{ mm.} : (.8 \text{ inch} \times 25.4) :: 1 : x \text{ power};$$

$$x = \frac{.8 \times 25.4 \times 1}{.02} = 1016 \text{ diameters.}$$

If the reverse is the case, viz. that you have an English stage micrometer and a metrical scale, then, if the magnified image of two $\frac{1}{1000}$ ths of an inch spans 18 mm.,

$$(iii) \quad .002 \text{ inch} : \frac{18}{25.4} :: 1 : x;$$

$$x = \frac{.7087 \times 1}{.002} = 354.3 \text{ diameters.}$$

The above results indicate the combined magnifying power of the objective and eye-piece taken at a distance of ten inches. The arbitrary distance of ten inches is selected as being the accommodation distance for normal vision.

The magnifying power, however, is very different in the case of

¹ Page 279.

a myopic observer. Let us investigate the case of one whose accommodation distance is five inches.

Here he will be obliged, in order to see the object distinctly, to form the virtual image from the eye-piece at a distance of five inches. To do this he must cause the objective conjugate focus to approach the eye-lens; consequently he must shorten his anterior objective focus. In other words, he must focus his objective nearer the object. This will have the effect of causing the posterior conjugate focus to recede from the objective towards the eye-lens, and the fact of bringing the inverted objective image nearer the eye-lens brings also the virtual image of the eye-lens nearer.

Shortening the focus of the objective has the effect of increasing its power; but as this alteration is proportionately very little, the increase in power is very small; but the shortening of the eye-piece virtual from ten to five inches has the effect of nearly halving its power. Consequently the combined result of the eye-piece and objective, in the case of halving the eye-piece virtual, is to nearly halve the power of the microscope. The increase of the objective power is practically so small that it may be neglected.¹ In practice it is found by us that if the image is projected on a ground-glass screen ten inches from the eye-piece, the image is nearly the same size whether focussed by ordinary or myopic sight. This is in harmony with Abbe's demonstration that both images are seen under the same visual angle. But, on the other hand, if a myopic sight compares the image with a scale, the magnification will be less than with ordinary vision, because the observer with myopic sight must bring the scale to a shorter distance than ten inches in order to see it.

To find the precise initial power of any lens, or to find the exact multiplying power of any eye-piece, is not so easy. A laborious calculation, involving the knowledge of the distances, thickness, and refractive indices of the lenses, is required. But a very approximate determination, sufficiently accurate for all practical purposes, may be easily made, especially if one has a photo-micrographic camera at hand. The principle is as follows:—

Select a lens of medium power—a $\frac{1}{4}$ -inch is very suitable. Now, with the microscope in a horizontal position, and with a powerful illumination, project the image of the stage micrometer on to a screen distant five feet, measured from the front lens of the objective. If no photo-micrographic camera is at hand, it will be necessary to perform the experiment in a darkened room, shading the illuminating source. Divide the magnifying power thus obtained by 6: the quotient will give the initial power of the lens at ten inches to a very near approximation.

The reason why the result is not perfectly accurate is that the ten inches must be measured from the posterior principal focus of the lens, and that is a point which is not given. But in the case of a power such as a $\frac{1}{4}$, it is, in practice, found to be very near the front lens of the objective. So by taking a long distance, such as five feet,

¹ *English Mechanic*, vol. xvi. No. 1185. Article on measurements of magnifying power of microscope objectives, by E. M. Nelson.

the error introduced by a small displacement of the posterior principal focus does not materially amount to much.

There is a further error introduced by the approximation of the objective to the stage micrometer in order to focus the conjugate at such a distance, but this is small. We can see, therefore, that this error tends to slightly increase the initial magnifying power.

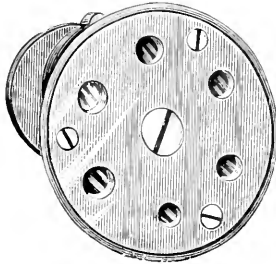

FIG. 228.—Rotating disc of objectives. Benj. Martin (circa 1776).

The initial power of the $\frac{1}{4}$ being found, and its combined magnifying power, with a given eye-piece, being known, the combined power divided by the initial power gives the multiplying power of the eye-piece. Care must be of course taken to notice the tube-length¹ when the combined power is measured. The initial power of any other lens may be found by dividing the combined power of that lens with the eye-piece, whose multiplying power has been determined, by the multiplying power of that eye-piece.²

Nose-pieces.—The term 'nose-piece' primarily means that part of a microscope into which the objective screws, but the term is also applied to various pieces of apparatus which can be fitted between the nose-piece of the microscope and the objective. There are, for instance, rotating, calotte, centring, changing, and analysing nose-pieces.

Nose-pieces, although thought to be so, are not a modern idea; our predecessors of a century ago employed similar means. Mr. Crisp has recently acquired a microscope which possesses a double arm, at the end of which is a cell for receiving different lenses. This cell fits over the end of the nose-piece, and so keeps the several objectives which may be inserted in position. It dates, in all probability, from the end of the seventeenth or the early part of the eighteenth century.

But in the early days of the microscope (rotating discs of objectives, as shown in fig. 228 (or, perhaps, older still, a long dovetailed

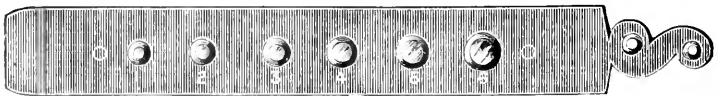

FIG. 229.—Sliding plate of objectives. Adams (1771).

slide of objectives, such as fig. 229 shows), were frequently employed.

It is continually desirable to be able to substitute one objective for another with as little expenditure of time and trouble as possible, so as to be able to examine under a higher magnifying power the details of an object of which a general view has been obtained by

¹ *English Mechanic*, vol. xxxviii, No. 981, 'Optical Tube-length,' by Frank Crisp. ² *Ibid.*, vol. xlvii, No. 1178, 'Measurement of Power,' by E. M. Nelson.

means of a lower; or to use the lower for the purpose of *finding* a minute object (such as a particular diatom in the midst of a slideful) which we wish to submit to higher amplification. This was conveniently effected by the nose-piece of Mr. C. Brooke, which, being screwed into the object end of the body of the microscope, carries two objectives, either of which may be brought into position by turning the arm on a pivot. This is shown in fig. 230.

The most generally useful of all nose-pieces now in use are the rotating forms, which enable one to carry two, three, or four objectives on the microscope at one time, and by mere rotation each is successively brought central to the optic axis, seen in figs. 231, 232, 233, as supplied by Messrs. Beck. It is almost unnecessary now to point out the disadvantage of those older and straight forms which involved the danger of knocking out the front lens of the objectives by bringing it into contact with some part of the stage while the other objective was being focussed. This objection was entirely removed by the introduction of the bent form by Messrs. Powell and Lealand, and adopted in the forms shown in figs. 231-233. There can

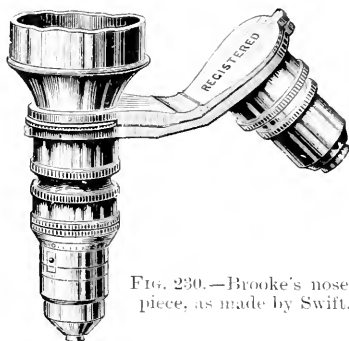

FIG. 230.—Brooke's nose-piece, as made by Swift.

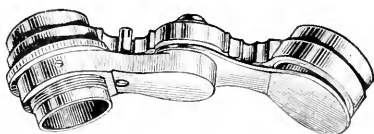

FIG. 231.

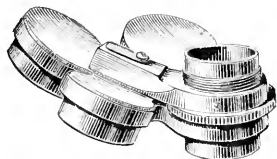

FIG. 232.

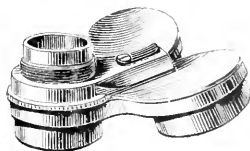

FIG. 233.

be no doubt that for ordinary dry lens work some such device is imperative. Some, however, who do a very large amount of microscopical work prefer to use two microscopes: the one a third- or fourth-class microscope, with only a coarse adjustment and a 1-inch objective and mirror, the other having a coarse and fine adjustment and a $\frac{1}{4}$ -inch objective, with a simple form of condenser and plane mirror, all fine and higher-power work being left for a special microscope.

The one drawback to the use of a rotating nose-piece is the extra weight it throws upon the fine adjustment. As this subject is fully

treated under the heading of 'Microscope,' no more will be said at present than that a double nose-piece is to be preferred to a triple, and a quadruple need not be entertained for a delicate instrument when made of ordinary metal, unless it is required to find out in how short a time a fine adjustment may be ruined; for let it be noted that a 2-inch, 1-inch, $\frac{1}{2}$ -inch, and $\frac{1}{4}$ -inch objective of English make weigh together $8\frac{1}{2}$ oz. without any nose-piece. But Messrs. Watson and Son have devised and made in aluminium a dust-proof triple nose-piece, which, where it is required to be used, reduces the objections to its employment to their minimum, and not only in greatly reduced weight, but in other ways, makes its use more feasible without strain upon the fine adjustment or danger of injury to the objectives. In many nose-pieces, if the objectives should be accidentally left so that neither of them is in the optical axis of the microscope, there is nothing to guard the back lenses of the objectives from dust and moisture. Messrs. Watson devised a dust-

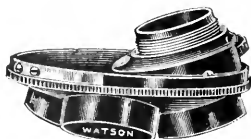

FIG. 234.—Watson's dust-proof aluminium nose-piece.

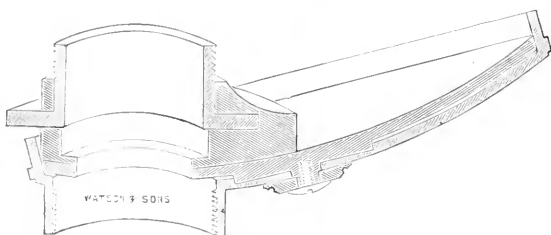

FIG. 235.—Section of the above.

proof arrangement, consisting of an upper and an under disc, having a spherical curve; to the lower disc are fitted three small screw tubes which receive the objectives. This plate rotates upon a centre pin, and as each objective is brought into the optical axis of the microscope its axial coincidence is indicated by a spring catch. The edge is covered with a metal rim, making it dust-proof. The weight of the ordinary brass nose-piece is $4\frac{3}{4}$ oz.; the weight of this one is $1\frac{3}{4}$ oz. Similar instruments are made by other makers, but the dust-proof arrangement and the extreme lightness are, so far as we know, characteristic of the instrument of Messrs. Watson. We illustrate this nose-piece complete in fig. 234, and in an enlarged section in fig. 235.

For the proper use of a rotating nose-piece the length of the objective mounts should be so arranged that when the objective is changed little focal adjustment will be necessary.

An excellent crotte nose-piece for four objectives is made by

Zeiss; this is so arranged that only the optical portion of the objective is screwed into the nose-piece. This plan much lightens it, so that the nose-piece and the four lenses weigh $3\frac{3}{4}$ oz., or only 1 oz. more than an English $\frac{1}{4}$ -inch with a screw collar, and $\frac{1}{2}$ oz. more than an English $\frac{1}{2}$ -inch of wide angle.

A *centring nose-piece* has been made with the view of placing any objective central to the axis of rotation of the stage. It is, of course, much cheaper to centre an objective by means of a nose-piece to the axis of rotation of the stage than to centre the rotary stage to the objective. This, like all other adapters, is an additional weight; but here there is very little to be gained by it, for if the rotary stage is well made any objective will be sufficiently centred for all practical purposes. Mr. Nelson, as we have seen, pointed out, at a time when the sub-stage was costly, that such a nose-piece turned upside down, with a turn-out rotating ring for stops, &c., fitted below, made a very efficient rectangular centring sub-stage at a small cost. Sub-stages are now quite common and cheap, and centring nose-pieces are seldom used for any purpose.

Next to the rotating, probably the *changing nose-piece* is the most important. We do not know from whom, and when, the idea of an arrangement by which an objective could be rapidly attached or detached originated; but certain it is that the idea is admirable, and one which is scarcely yet as fully appreciated as it should be. It will be quite impossible to go through a title of the appliances which have been invented for this purpose; it will be sufficient to lay down some principles, and mention a few in which those principles are fulfilled.

The first principle is that the objective or nose-piece, adapter, or whatever else is used, should 'face up.' This means that a flange turned true in the lathe should 'face up' to the flat side of the nose-piece, which has also been turned true. This 'facing up' should be made tight by a screw, inclined plane, or wedge, &c. Unless this is done you have no guarantee that the axis of the objective is parallel to that of the body. Therefore all those appliances which merely grip the objective, or an adapter screwed on to the objective, are simply of no value. Secondly, the appliance, whatever it is, should be light.

Nacht's changing nose-piece, which fulfils none of these conditions, cannot be called good. The nose-piece is large and heavy, even for the small objective it is intended to take, the screws of which are $\frac{7}{16}$ only in diameter, against the $\frac{1}{8}$ of that of the Society. The objectives are held by a spring clip on a small flange. Of course, screw-collar adjustment with such a device would be simply impossible. Zeiss's sliding-objective changer is most elaborate and efficient, although, as we think, much heavier than it need be. It consists of a grooved slide which screws on to the nose-piece. On each objective is screwed an adapter to slide into the grooved nose-piece. These adapters, which are wedge-shaped and 'face up,' have two novel features, the first being that they are each fitted with rectangular centring adjustments, which permit the objectives to be centred to one another; and the second is that they have

adapters to equalise the length of the objectives, so when a change of objectives is made little change of focal adjustment is required. Figs. 236, 237 show the nature of this arrangement. In Nelson's changing nose-piece a small ring with three studs is screwed on to the objective; a nose-piece is screwed on the microscope, having three slots and three inclined planes. Therefore, by placing the studs into the slots and giving the objective a quarter of a turn, the studs run up the inclined planes, thus causing the flanges to 'face up' tightly.

Mr. Nelson has pointed out a far better and simpler method which dispenses with all extra apparatus.

Three portions of the thread in the nose-piece of the microscope itself are cut away, and also three portions on the screw of the

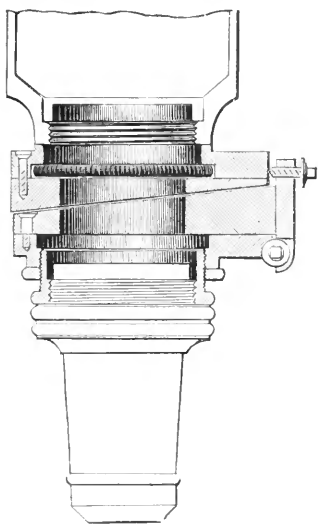

FIG. 236. — Zeiss's sliding-objective changer, with objective in position.

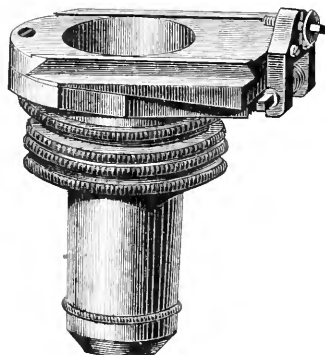

FIG. 237. — The objective detached from the body-slide.

objective. Those portions where the thread is left on the objective pass through those spaces in the nose-piece where it has been cut away. The screw engages just as if the whole screw were there, and the objective faces up in the usual manner. This plan in no way injures either the microscope or the objectives for use in the ordinary way; thus uncut objectives will screw into the nose-piece, and cut objectives will screw into an uncut nose-piece. This plan is similar to that employed in closing the breech of guns, and it was seeing one of them in 1882 which suggested to Mr. Nelson to adapt the same principle to the microscope. Subsequently it has been found that in 1869 Mr. James Vogan had proposed much the same plan, only cutting away two portions instead of three; it is curious that such an excellent idea was allowed to drop.

An *analysing* nose-piece is that which carries a Nicol's analysing

prism for polariscope purposes. In some the prism is fixed in the nose-piece, whereas it ought to be capable of rotation. Lastly we have a *revolving* nose-piece for the purpose of testing objectives. Mr. Nelson, in a paper read before the Quekett Microscopical Club, February 1885, stated that he had observed that certain objectives performed better when the object was placed in a definite azimuth. With a view to eliminate any possible alteration which might arise from the revolution of the object with regard to the light, he had designed a revolving nose-piece which enabled the objective itself to be revolved true to the optic axis when any imperfection in its performance in a particular azimuth could be immediately noted. This plan had, however, been previously in use by Professor Abbe for a similar purpose, but not, as we believe, made public.

Finders.—A finder is a very important and valuable addition to a microscope. By its means the position of any particular object or part of an object in a mount can be noted, so that it may be found again on any subsequent occasion. In working on a microscope without a finder it frequently happens that in the prosecution of special research, or in the examination of unknown objects, something is seen which it would be of the utmost value to recur to again; but the amount of time lost in transferring the object to a stand with a finder is so great that most experienced microscopists do all their search and general work on their best instruments with finders.

The usefulness of the finder has caused a large number to be devised; but, as in all cases, we consider only those which we believe embody the best practical principles.

The first, and by far the best, is the graduation of the stage plates of a mechanical stage by dividing an inch into 100 parts, both on the vertical and horizontal plates. The vertical stage-plate will then indicate the latitude, and the horizontal plate the longitude of the object, the slip being always pressed close home against a prepared stop. For many years Messrs. Powell and Lealand have supplied their No. 1 stand with this kind of finder; and its permanent position and ease in use not only give greater facility in special researches, but in reality attach a new value to every slide in the cabinet. Such a worker at critical images as Mr. Nelson has weeks of close work 'logged' on the labels of his slides. A still better plan is to 'log' in books in which the slides are numbered. The result is that the labour of days and weeks can be in a moment recalled for demonstration; and so accurate is this method that an object so small as a *Bacterium termo* or a specified minute diatom in a thickly scattered mounting may be at once, and as often as we please, replaced in the field with even high powers.

These finders of course are only suitable for the microscope on which the 'log' was taken. It is beneficial, and even needful at times, to interchange specimens or refer an object to an expert at a distance. In that case a minute dot may be placed on the cover, or a single selected diatom or other object may be fixed upon and its latitude and longitude as read on the microscope of the sender marked on the slide. If the receiver then places this on his microscope and

centres it, the differences in latitude and longitude may be noted, and will give the constants for the correction which must be added to or subtracted from the figures given by the sender.

Mr. Nelson has made some very practical suggestions touching the improvement of finders. He suggests, what we heartily accord with—

1. That the stage-stop shall be always on the left hand of the stage.

2. That the zero of the horizontal graduation shall be on the left hand of the scale.

3. That the zero of the vertical graduation shall be on the top of the scale.

4. That when the finder is placed to 0, 0, a spot marked on the bottom edge of a 3 × 1 inch brass template two inches from the stop shall be in the optic axis of the instrument. In other words, the latitude and longitude of the centre of a 3 × 1 inch glass slip shall be 50, 50.

5. That the division shall be in $\frac{1}{100}$ ths of an inch, and the scales one inch long.

If these very simple suggestions were adopted generally, an object found on one microscope could be easily found on any other. This, like the 'Society's screw' for object-glasses and a universal sub-stage fitting, deserves, in the interests of international microscopy, the consideration of opticians.

In practical 'logging' the use of a hand lens will enable the observer to read by estimation very accurately; half a division can be very approximately judged of, and this is as close as will be required with the highest powers. We have found, for very delicate work, that we could log with advantage between the divisions, thus: say 'long, 41;' but if slightly over, but not an estimated half, '41 +;' if half, '41½;' if more than this, but less than 42, it is logged '— 42.' For logging purposes the lens we recommend is one of Zeiss's 'loups,' magnifying six diameters. They are admirable instruments, and are furnished with a handle, which may be used or not at the will of the worker.

The other finder we desire to consider is called after its inventor, and is known as 'Maltwood's finder.'¹

It consists of a micro-photograph, one square inch in size, divided into 2,500 little squares, so that each is $\frac{1}{50}$ th inch square. Each square contains two numbers, one indicating the latitude and one the longitude. To log any object the slide containing the object must be removed and the slip holding the micro-photograph substituted for it; then the figure in the square which most nearly agrees with the centre of the field is noted. Of course, both the object and the Maltwood finder must be carefully made to abut against the stop.

There are two drawbacks to this finder.

1. The divisions are not fine enough, so that it is only suitable for low powers.

2. The removal of the slide, and its substitution by the Maltwood

¹ *Trans. of the Micro. Soc.*, new series, vol. vi, 1858, p. 59.

finder, render it extremely unhandy when using an immersion objective, all the more so if the condenser happens to be immersed as well.

If the Maltwood finders are made alike, they are then, of course, interchangeable.

Diaphragms.—There are three kinds of diaphragms in use. First, the commonest form is that of a rotating disc of several apertures graduated as to size. Secondly, a series of separate small discs of metal, with a single central aperture, which fits in a suitable carrier. Thirdly, there is what is known as the ‘iris’ diaphragm, which is shown in fig. 238. Upwards of 30 years ago it was applied to the microscope by Beck; it has since been brought to great perfection, some being made with as many as sixteen leaves; all makers now provide them. In whatever form the diaphragm may be which is for use with the mirror, it is important that it should not be placed too near the object, as then its position lies so near the apex of the cone of illumination that it will not cut it unless the hole be exceedingly small. A very small diaphragm aperture is objectionable, as it is liable to introduce diffractive effects. Therefore it is better to use a larger aperture further away from the stage than a pin-hole near the stage. When a diaphragm is used in connection with a condenser, it should be placed just behind the back lens, and never above the front lens. Catotte diaphragms placed close under the stage, and which have been much in use lately, both here and on the Continent, are a mistake for critical work.¹



FIG. 238.—Zeiss's iris diaphragm.

A very good way of cutting down a cone from a mirror is to have the diaphragm fitted in the sub-stage, so that it can be made to advance or recede from the object. The advantage thus gained is that one aperture is made to do the duty of several. It also permits of careful adjustment.

The iris diaphragms are so comparatively inexpensive, that they have superseded for general work and ordinary purposes all others; but whatever diaphragm is used it should *work easily*. Iris diaphragms work sometimes so stiffly that the microscope may be moved before the diaphragm. So, too, with the diaphragm wheels: some require a pair of pliers before they can be rotated. This is easily accounted for when we examine the way in which they are fixed. The usual method is to screw the wheel to the under side of the metal stage. Now, if there are neither washers nor a shoulder to the screw, it is

¹ Quekett, *Micro. Journ.* vol. iv. p. 121 *et seq.*

more than probable that when the diaphragm is rotated it will screw up and jam. The purchaser may easily observe a matter of this kind. Cylinder diaphragms, which were invented in 1832 by C. Varley, are much used on the Continent; they are also often made into iris forms. Also diaphragms with a very minute circular hole in the line of the optical axis are largely used just behind the object-slip. These are employed with the mirror only (without condenser) and with daylight alone. The object of this method of illumination being to render very translucent objects visible by increasing the size of the black diffraction bands at their edges, it is, as before stated, of no use for critical work.

Condensers for Sub-stage Illumination.¹—This condenser is an absolutely indispensable part of a complete microscope. Its value cannot be overrated, for the ability of the best lenses to do their best work, even in the most skilful hands, is determined by it. Perfection in the corrections of object-glasses is indispensable; but those who suppose and affirm that this is all that we need—that the objective is the microscope—cannot understand the nature of modern critical work. The importance of it could not have been realised in the sense in which we know it in the earlier dates of the history of the instrument; but at as early a period as 1691 we pointed out (p. 134) that a drawing of Bonanni's horizontal microscope showed the presence of a condenser. It is, in fact, of some interest to note how our modern condensers gradually arose.

The microscope that amongst the older forms (1694) appears most efficient and suited for the examination of objects by transmitted light was that of Hartsoeker (p. 134, fig. 102). It will be remembered that it was furnished not only with a condenser, but with a focussing arrangement to be used with it, which was not in any way affected by a change of focus in the object. This is a feature which, although not then important, is of the utmost importance now.

In the correction of dispersion in the lenses employed in the dioptric form of microscope so much difficulty was experienced that several efforts were made to produce catoptric forms of the instrument; the most successful of these was that of Dr. Smith, of Cambridge, in 1838; but this and all other forms of reflecting microscope had but a brief existence, and passed for ever away. To the improvement of simple lenses much of the earlier progress of microscopic investigation is attributable; and that known as 'Wollaston's doublet,' devised in 1829, was a decided improvement in all respects. It consisted of two plano-convex lenses; but this was again improved by Pritchard, who altered the lens distances and placed a diaphragm between the lenses. When the object was illuminated with a condenser this formed what was the best dioptric microscope of pre-achromatic times.

Good results, within certain limits, may be obtained by means of the best Pritchard doublets. With a $\frac{1}{10}$ th inch the surface of a strong Podium scale may be seen as a surface symmetrically scored or engraved; but the Editor has never himself been able to reveal the

¹ The word 'condenser' throughout this work is applied to optical appliances for the sub-stage; what is known as the 'bull's-eye' is not called a 'condenser.'

'exclamation' marks, and as this is the experience of the majority of efficient experts, it may be taken that no resolution of these was accomplished in pre-achromatic days; these lenses, in fact, overlapped the discovery of achromatism.

But the practical results of the use of achromatic lenses soon led experienced men, understanding their theory and practice, to perceive that if it were good for the lenses which formed the image, it was also good for the condenser. Thus Sir David Brewster in 1831 advocated an achromatic condenser in these remarkable words, viz.: 'I have no hesitation in saying that the apparatus for illumination *requires to be as perfect as the apparatus for vision*, and on this account I would recommend that the *illuminating lens should be perfectly free from chromatic and spherical aberration*, and that the greatest care be taken to exclude all extraneous light, both from the object and from the eye of the observer.' This is a judgment which every advance in the construction of the optical part of the microscope, as used by the most accomplished experts, has fully confirmed.

We have no knowledge, from an inspection of the piece of apparatus itself, of the construction of the compound sub-stage condenser of Bomanni (fig. 101); it does not appear to have attracted much attention, and of course it was quite impossible to secure a critical image by its means. It was focussed on the object merely to obtain as bright an illumination as possible, in order that the object might be seen at all.

In the condenser used by Smith in his catoptric microscope (fig. 113) we have the earliest (1738) known condenser, by means of which a distinction between a 'critical' image—that is, an image in which a sharp, clear, bright definition is given throughout, free from all 'rotteness' of outline or detail—and an 'uncritical' or imperfect image could be made. It was not, apparently, at the time it was first used, considered to be so important as we now know it to be; and it is probable that the mode of focussing the light upon the object by its means was to direct the instrument to the sky with one hand and to use the biconvex condenser with the other. In 1837 Sir D. Brewster writes of it with appreciation, saying that 'it performs wonderfully well, though both the specula have their polish considerably injured. It shows the lines on some of the test objects with very considerable sharpness.'

No advance was made on this condenser for nearly a century. In 1829 Wollaston recommends the focussing of the *image of the diaphragm* by means of a plano-convex lens of $\frac{3}{4}$ of an inch focus upon the object, and Goring in 1832 says concerning it: 'There is no modification of daylight illumination superior to that invented by Dr. Wollaston.' But Sir D. Brewster objected to this, contending that the *source of light* itself should be focussed upon the object. He preferred a Herschelien doublet placed in the optic axis of the microscope. But, whilst there is a very clear difference between these authorities, we can now see that both were right.

Goring, who was also a leader in the microscopy of his day, used diffused daylight, and as the lens he employed was a plano-convex of $\frac{3}{4}$ of an inch focus, the method of focussing the diaphragm was as

good as any other, because the diaphragm was placed at a distance from the lens of at least five times its focus, so that the difference between diaphragm focus and 'white cloud' focus, or the focussing of the image of a white cloud upon the object, was not very great. But Brewster was writing of a flame from a saucer of burning spirit and salt when he insisted on the bringing of the condenser to a focus on the object, and in this he was, beyond all cavil, right.

In 1839 Andrew Ross gave some rules for the illumination of objects in the 'Penny Cyclopaedia.' These were:—

1. That the illuminating cone should equal the aperture of the objective, and no more.
2. With daylight, a white cloud being in focus, the object was to be placed nearly at the apex of the cone. The object was seen better sometimes above, and sometimes below, the apex of the cone.
3. With lamplight a bull's-eye is to be used to parallelise the rays, so that they may be similar to those coming from a white cloud.

Of the old forms of condenser, that devised by Mr. Gillett was,

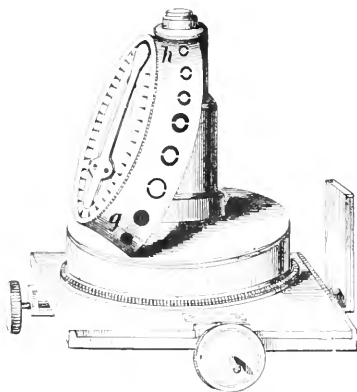

FIG. 239.—Gillett's condenser, from 'Hogg on the Microscope.'

there can be no doubt, the best. It was achromatic, and had an aperture of 80° . Fig. 239 illustrates it. It was fitted with a rotating ring of diaphragms placed close behind the lens combination. This was formed, as the figure shows, by a conical ring with apertures and stops. The large number of apertures and stops it would admit, provided they are carefully 'centred,' are of great value in practical work; and the fact that they are so placed as not to interfere with the stage, makes this arrangement of diaphragms and stops an excellent one, and it is not clear why it has fallen into disuse.

It had been the custom to recommend the use of this instrument racked *either within or without its focus*. Carpenter employed it without, and Quekett within, and one or other of these methods was general. But in the use of good achromatic condensers with high-power work it soon became manifest to practical workers that it is only when, as Sir David Brewster pointed out, *the source of light is focussed by the condenser on the object* that a really critical image is to be obtained. And Mr. Nelson readily demonstrated this fact even with the condenser Gillett had devised.

The next condenser of any moment is a most valuable one, and constitutes one of the great modern improvements of the microscope. It was an achromatic condenser of 170° devised and manufactured

by Messrs. Powell and Lealand. We have used this instrument for thirty-five years on every variety of subject, and we do not hesitate to affirm that for general and ordinary critical work it is still unsurpassed. Fig. 240 illustrates this apparatus. The optical combination is a $\frac{1}{3}$ th of an inch power, and it is therefore more suitable for objectives from a $\frac{1}{3}$ th of an inch and upwards; but by removing the front lens it may be used with objectives as low as one inch.

Having given to this condenser so high a place amongst even those of our immediate times, it may be well to specify what the requirements are which a condenser employed in critical work with high powers *should* meet. It is needful that we should be able (1) to obtain at will the largest 'solid' cone of light devoid of spherical aberration.¹ Directly spherical aberration makes itself apparent the condenser fails; that is, when, on account of under-correction, the central rays are brought to a longer focus than the marginal rays, or when, because of over-correction, the marginal rays have a longer focus than the central.

But (2) it is also an absolute essential that if a condenser is to be of practical service it must have a working distance sufficiently large to enable it to be focussed through ordinary slips. It would be an advantage if all objects mounted for critical high-power work were mounted on slips of a fixed gauge, say .06 inch, which would be 'medium,' .05 inch being accounted 'thin,' and .07 inch 'thick.'

It is plain, however, that to combine a large aperture with a great working distance the skill of the optician is fully taxed, for this can only be accomplished (a) by keeping the diameter of the lenses just large enough to transmit rays of the required angle and no more; (b) by working the convex lenses to their edge; (c) by making the flint lenses as thin as possible.

Now it is due to the eminent firm whose condenser we have been considering with such appreciation to say that the condenser referred to (d) did, when it was first devised and for many years after, transmit the largest 'solid' cone free from spherical aberration; (e) that it has the greatest working distance; (f) that its chromatic aberrations are perfectly balanced. In the possession of these three essential qualities it stood unrivalled for upwards of thirty years.

The removal of the front lens of this condenser, which may be readily unscrewed, reduces it in power and angle, and therefore makes it suitable for objectives of lower power. This, however, is rather an adaptation involving compromise than an ideal condenser

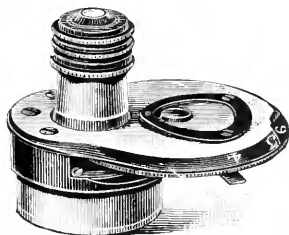

FIG. 240.—Powell and Lealand's condenser.

¹ This is one of the many expressions which are inevitable to the practical use of apparatus; it is simply convenient, and means a *full* cone of light—a cone with none of its rays stopped out.

for low powers. When the highest class of work has to be done it is *needful to have condensers suited to the power of the objective used.*

A dry apochromatic condenser of merit is made by Swift and Son; it has a N.A. of 0.95 and an aplanatic cone approximating 0.92, and works with ease through any object-slide, but is corrected to do this by thinning the front lens and setting the front and back combinations further apart than would be the case if they were used as an objective. The lower combination has a large, clear aperture. The optical part of this instrument is shown in fig. 241; we have used it, and find it a thoroughly practical and serviceable condenser.



FIG. 241.—Swift's apochromatic (1899) condenser, N.A. 0.95.

Before the introduction of the homogeneous system, and the production of such great apertures by Powell and Lealand as a 1.5 in a $\frac{1}{6}$ th, a $\frac{1}{2}$ th, and a $\frac{1}{20}$ th of an inch focus, the cone transmitted by Powell's dry achromatic condenser was as large as could be utilised. But with apertures such as these, and because of the subsequent introduction of the apochromatic system of lenses, much larger cones were required. To meet this necessity Powell and Lealand, at the urgent suggestion of English experts, made first a chromatic condenser on the homogeneous system; but this was subsequently succeeded by an achromatic instrument of great value on the same system. This combination consisted of a duplex front with two doublet backs; it is nearly of the same power as their dry achromatic condenser, but is of much greater aperture. It was brought afterwards to a very high state of perfection, having an aperture of 1.40, and will work through a mounting slip of .07, and for aperture and working distance is, like its dry predecessor, quite approached.

Messrs. Powell and Lealand have produced an entirely new condenser, strictly apochromatic, employing a fluorite lens in the combination, and presenting features in the highest degree desirable. We find its N.A. to be 0.95, its focal length long enough for a thick slip, its aplanatic aperture .9. We have found it of the utmost practical value in critical work, and this valuable apparatus has been greatly increased in efficiency by the application of a device by Mr. E. M. Nelson, providing it with a *correction collar*, which can be used with the utmost ease, no matter in what position the microscope may be. It is similar in practice to the correction collar of an ordinary objective; it has a steeper spiral slot, and only half a revolution of movement; a long arm is fixed to the collar, so that it may be conveniently reached by the finger. The whole condenser is represented in fig. 242, and the arm for moving the correction collar is seen on the right of the optical tube; it turns at the slightest touch, and the collar moves only the back lens of the combination, leaving the mount rigid.

The object of this correctional movement is primarily to increase the maximum aplanatic aperture of the condenser; this is effected by separating the lenses. If the back of a wide-angled objective be

examined when an object is illuminated by the full aperture of the condenser, the edge of the flame being in focus, it will be noticed that the illuminated portion of the back lens will be oval and pointed instead of circular. Also that when the condenser is racked up, although the exterior shape of the illuminated portion will become more circular, two dark patches will appear on either side of the centre, showing the operation of the spherical aberration of the condenser.

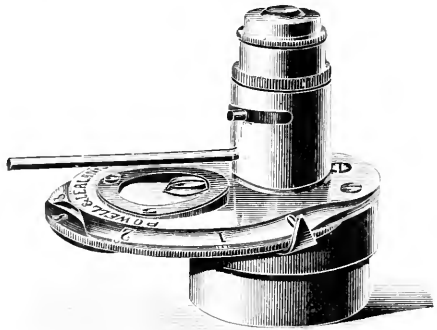

FIG. 242.—Nelson's correction collar to Powell's apochromatic condenser.

If under these circumstances *the lenses be separated by means of the collar adjustment, the black spots will be closed up, and a circular and evenly illuminated disc will appear.* This is a distinct optical gain, and will enable the observer to see more than he could have seen before. Mr. Nelson made this manifest on the examination of a well-known diatom, *Navicula major*. If examined in its 'principal view,' two vertical stripes will be seen running down the centre of the hoop (fig. 243. *a*); these can easily be resolved into striae with a $\frac{1}{4}$ -inch objective, but the probability is that these striae are not the real structure but rows of minute perforations incom-

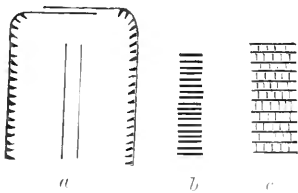

FIG. 243.

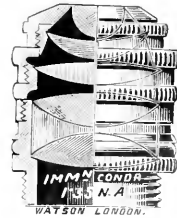

FIG. 244.—Watson's oil-immersion condenser.

pletely resolved (fig. *b*); by using the condenser with the collar correction these striae were resolved by means of the enlarged applanatic cone it produced, as shown in *c*.

Another advantage of the correction collar is that it enables the worker to determine most delicately the size of the illuminating cone, and so to record it that it can be with facility exactly resumed at any time (*Journ. R. Micro. Soc.* 1895, pt. ii, p. 231-2).

One of the most valuable condensers introduced by any maker lately is an oil-immersion one by Messrs. Watson and Sons. It has special claims upon the attention of those who work with high

powers, for we know of no similar instrument that yields so large a 'solid cone' of illumination. The construction is an unusual one, the corrections for both spherical and chromatic aberrations being effected by means of a cemented triple back lens, as is shown in the illustration of the optical system in fig. 244. The only flint glass used in it is the middle of the triple back. The total numerical aperture is 1.33, the aplanatic aperture being in excess of 1.25. The magnifying power is $\frac{1}{4}$ inch, and the clear aperture at the back of the lens is $\frac{6}{10}$ ths inch, and it works through a slip of .073 thick.

With the front lens removed it is an efficient dry condenser for medium powers, magnifying $\frac{2}{3}$ ths inch, with a total N.A. of .56, the aplanatic aperture being over .5. It is mounted like their 'Parachromatic condenser' shown in fig. 245, which is also a very useful instrument, with a total N.A. of 1.0, a power of $\frac{2}{3}$ ths inch. It is shown here principally for the mounting, which is identical with that used with fig. 244. The

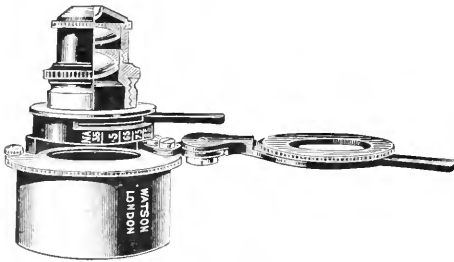

FIG. 245.—Watson's parachromatic condenser.

collar into which the optical part fits carries an iris diaphragm; on the diametrical edge of this is engraved a scale showing the N.A. at which the condenser is working when the iris diaphragm is in a given position. We have used this condenser with much pleasure and profit, and can commend it as a truly valuable instrument and yet remarkably low in price.

A condenser satisfying modern necessities has also recently been

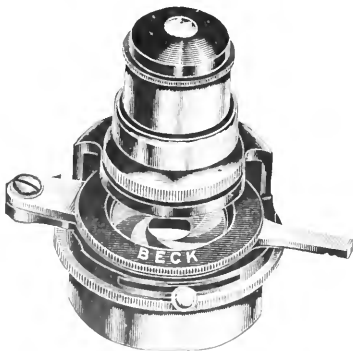

FIG. 246.—Beck's new achromatic condenser.

made by Messrs. R. and J. Beck, which we illustrate in fig. 246 in its complete condition. The optical combination consists of four systems of lenses, the front of which is a hemisphere, with three combinations behind, and the whole is constructed on the principle of an oil-immersion objective. The N.A. varies from 1.35 to 1.4, and the aplanatic cone is about 1.3 N.A., the working distance being fully .06. We can speak highly of this instrument; it is in our judgment the best condenser ever made by this firm.

Another condenser has been made recently by the same firm, with N.A. of 1.0, the maximum obtainable without immersion

contact. Its aplanatic aperture is $\cdot9$ N.A. $1\cdot0$. We illustrate this form in fig. 247.



FIG. 247.—Beck's condenser with N.A. $1\cdot0$.

It is with great pleasure that we are able to announce the production, by the firm of Zeiss, of a '*centring oil-immersion achromatic condenser*' of N.A. $1\cdot30$. This is what we have long desired to see, and we have used it with admirable results. It gives a large illuminating aplanatic cone, hence very oblique illuminating rays.

The centring arrangement is the same as that of the achromatic condenser of the same firm having $1\cdot0$ N.A. It is supplied with an iris diaphragm of the most perfect workmanship, and the condenser is focussed not only by rack-and-pinion movement, but also by means of a special fine adjustment; this is accomplished by the aid of a rotating

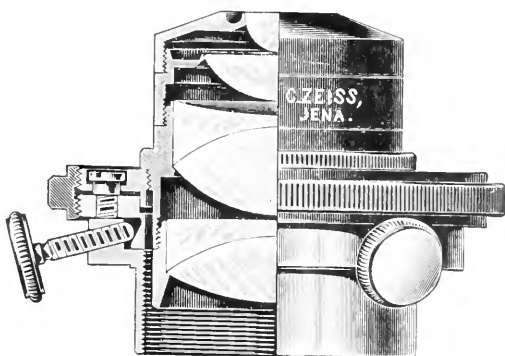

FIG. 248.—Zeiss's centring oil-immersion achromatic condenser (1899).

ring provided with a differential thread, as will be seen by examining the illustration we give in fig. 248. This allows the condenser to be easily focussed at intervals of about $0\cdot01$ mm. By means of this fine adjustment the condenser may be focussed up to about 1 mm.

Messrs. Swift and Son make a panachromatic dry condenser having a N.A. $1\cdot0$, an aplanatic cone of $0\cdot93$, and it works well when a critical image is desired. It is well corrected for colour; they also make a panaplanatic oil-immersion of N.A. $1\cdot40$, with an aplanatic cone of $1\cdot25$. The new optical glass is used throughout the system. It is mounted in an adjustable cell, if desired, for correcting the variations in the thickness of the glass slide. The

iris diaphragm supplied with this condenser is graduated to show the N.A. when greater accuracy is required, but the still more accurate method of employing fittings with separate discs with their N.A. marked on them is also supplied by the makers.

A very complete achromatic condenser is now made by Baker of Holborn. This condenser is a modification of the well-known Abbe form, in that the diameter of the component lenses is considerably smaller: this reduction in the size of the lenses, allowing, as it does, of



FIG. 249. Baker's new achromatic condenser
N.A. 1.0.

greater freedom of movement of the mechanical stage, has been effected without in any way decreasing its optical efficiency; on the contrary the applanatic aperture has been increased, thus rendering it especially suitable for use with high powers. The total aperture is N.A. 1.0, of which N.A. 0.90 is applanatic: the diameter of the back lens is 22 mm. ($\frac{1}{2}$ in.) and the power of the condenser as a whole is 10 mm. ($\frac{3}{10}$ in.) with a working distance of 2.5 mm. ($\frac{1}{10}$ in.): with the front lens removed for low-power work the power is reduced to 20 mm. ($\frac{8}{10}$ in.), and the working distance, which is calculated with the lamp flame at ten inches, is increased to 10.5 mm. ($\frac{3}{4}$ in.).

The above is mounted in the usual sub-stage fitting of universal gauge with iris diaphragm and carrier with dark-ground stops, as shown in the illustration of it in fig. 249.

It is essential for ideal illumination with transmitted light (1) that the illuminating axial cone should be approximately equal to the aperture of the objective used; (2) that the object should be placed at the apex of this cone.

If an objective breaks down with this ideal illumination, which is very probable, we must be content to sacrifice the ideal; or, as is also exceedingly probable, if the object under examination lacks contrast, the ideal method must be modified. But if we have a suitable object and a perfect objective, it is the strong conviction of some leading experts that, as we increase the cone in aperture, we increase the perfect rendering of the image, until the point is reached where the cone from the condenser is equal to the aperture of the objective. This ideal can be realised with fine apo- and semi-apochromatics up to $\cdot 3$ to $\cdot 4$ N.A. With the most perfect objectives of the present day of $\cdot 5$ N.A. and upwards we find in practice that the best results are obtained when a cone of light is used which, on the removal of the eye piece, is found to occupy three-quarters of the area of the back lens of the objective.

No condenser is sufficiently free from spherical aberration to transmit a cone equal to its *own* aperture. Condensers are all more or less under corrected, and consequently focus their central rays at

a greater distance than their marginal rays. If we rack up the condenser so that the marginal rays are focussed on the object, the focus of the rays which pass through the centre will be beyond the object.

It is well known to those practised in microscopy that, in the case of a narrow cone from a well-stopped-down condenser—that is, a condenser used with diaphragms of relatively small diameter—the illumination is at its greatest intensity when the object is at the apex of the illuminating cone, and, if the condenser is racked either up or down, the intensity of the illumination is rapidly diminished. But in the case of a condenser with great aperture, if it be racked up, the marginal rays will have their full intensity, while those which pass through the central portion of the condenser will have a diminished intensity.

The extent to which this will take place will be wholly dependent on the amount of under-correction present in the condenser. In some condensers the under-correction is so serious that to obtain a wide or even a moderate cone we so enfeeble the central cone as to reduce it almost to a mere annular illumination, which is not a desirable quality.

It will be seen, then, that the aperture of the cone of light transmitted by a condenser plays a very important part in giving critical quality to an image with different objectives. We should therefore, to use a condenser accurately, be able to determine the aperture of the cone we are using.

We may measure the total aperture of a condenser just as we do that of an objective, viz. by means of Abbe's apertometer.¹ But the *effective* aperture cannot be measured in that way; that is to say, the aperture of the largest aplanatic cone (or cone free from spherical aberration) the condenser is capable of giving, cannot be so discovered.

To do this, place the condenser in the sub-stage and an objective on the nose-piece; focus *both* upon an object. Let the edge of the lamp-flame be used, and so arrange the focus of both optical combinations that the edge of the clear image of the lamp-flame falls centrally upon the object. Now move the object just out of the



FIG. 250.

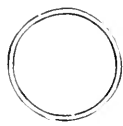

FIG. 251.

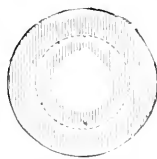

FIG. 252.



FIG. 253.

field, remove the eye-piece and examine the back of the objective, and if the aperture of the aplanatic illuminating cone is *greater* than that of the objective it will show the back lens to be full of light (fig. 250). Therefore, if the aperture of the objective is $\cdot 5$, we know that the aplanatic illuminating cone cannot be less than $\cdot 5$. If now we

¹ Chapter v.

close the diaphragm so that the image of it just appears at the back of the objective, we are able to determine the aperture of the illuminating cone with that given opening in the diaphragm; thus in fig. 251 it is a trifle less than $\cdot 5$ N.A.

In a similar manner the apertures of the other diaphragm openings can be determined.

Now let the diaphragm be opened to the full aperture, and an objective with a wider aperture, say $\cdot 95$, be used. It will perhaps be found that before we are able to fill the back of the objective with light by racking up the condenser, two black spots will be formed on either side the middle of the disc. When we reach the disc of light that is largest (fig. 252), any further racking up causes the appearance shown in fig. 253. *The last point before the appearance of the black spots indicates the largest applanatic aperture of the condenser, and is the limit of the condenser for critical work.*¹

There are many other condensers of more or less merit and usefulness than those which we have already described and illustrated; but for most recent lenses, and for the finest critical results, we have given them as full a representation as can be fairly desired. But there are still some forms that either from their own peculiar value or their historic importance deserve consideration.

A condenser known as the 'Webster' was first made in 1865, and is still a very useful one for low powers. It is the same as that made by Swift, but without the middle combination. Its angle is less, and its range is not so extensive; but its chief commendation in possessing these qualities is that, having one combination less than Swift's, it is of necessity lower in price, and on that account will be welcome to some workers.

In its present form it reverses its primary construction. It is now made with a double front and a single back, instead of a single front and a double back.

A *chromatic condenser* which has been very largely used in England and America, and which has secured a great deal of commendation, is that of Professor Abbe. The optical productions of Abbe are too well known and too valuable as a rule to make it needful to be other than perfectly frank concerning so important a piece of apparatus as this; and there can be no doubt that the wide popularity of this instrument is due, not so much to intrinsic merit as to the fact that it has been employed much by those who, previously ignorant of the value of *any* condenser, have at once perceived the enhanced value of the results yielded by its means.

To those who have made the scientific use of the microscope a careful study in England it has been a persistent source of regret that it was so long and pertinaciously taught that the 'correct' histological microscope must be of the Hartnack type, and that it should be used with narrow-angled dry lenses, perhaps a $\frac{1}{4}$ -inch focus, and no illumination but that afforded by a small concave mirror, the focal point of which is extremely doubtful or unknown.

¹ 'The Back of the Objective and the Condenser.' E. M. Nelson, *Eng. Mech.* No. 1231, 1888.

and in practice wholly disregarded. No doubt a student instructed on these lines would be astonished indeed when he exchanged such a practice for the illumination and improved image afforded by an Abbe condenser.

Usually such exchange of illuminating method presages an exchange of instrument, for the scientifically imperfect and wholly unsatisfactory 'tool' that is in the majority of cases put into the hands of the medical student will not lend itself even to an Abbe condenser.

The fact is that a large part of the admiration that has been expressed for this condenser has resulted, not from a comparison of its results *with those of other high-class achromatic condensers*, but of images obtained without any sub-stage optical arrangements at all, placed in contrast with the results obtained by using this condenser against the same objective when used without its aid. But that even these images are entirely inferior to the images obtained by the higher order of achromatic condensers we only require the practical testimony of Professor Abbe to prove: for *he has since produced an achromatic condenser of much merit*, to which we give consideration below.

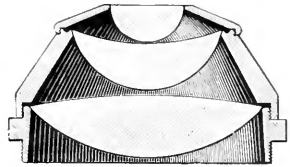

FIG. 254.—Optical arrangement of Abbe's chromatic condenser.

In its most perfect form this *chromatic* condenser of Abbe's consists of three single lenses, the front being hemispherical, and the two lower lenses form a Herschelian doublet. This combination is shown in fig. 254, and the general form of the instrument, as applied to Zeiss's own microscopes, is shown in fig. 255.

The power of this condenser is low, and its aperture is very large (1.36); hence, beyond the fact that it is not achromatised, it has enormous spherical aberration. The distance between the foci of the central portion and of a narrow annular zone whose internal diameter is $\frac{2}{3}$ th inch is $\frac{1}{10}$ th inch. Its aplanatic aperture is therefore only .5. Now, whilst it is a gain of no inconsiderable character to have an achromatised condenser, yet the point of vital importance is that it should be aplanatic; the best condenser is always that which will transmit the largest aplanatic cone. At the close of this section we furnish a table of the relative qualities of the condensers of the best construction now accessible to the microscopist, and a reference to this will show that Powell and Lealand's dry achromatic (fig. 240), with the *top removed*, is in this respect as efficient as this form of Abbe's.

This condenser can be used either dry or homogeneously; but of course with objectives of greater aperture than 1.0 the base of the slide should always be in oil contact with the condenser.

It gives the principal modifications from direct to oblique illumination with transmitted light by changing and moving a set of diaphragms placed in a movable fitting, and the diaphragm may be moved eccentrically to the optical axis of the condenser by moving the milled head. It gives dark-ground illumination with objectives

of $\cdot 5$ N.A.; for such illumination, in fact, it is perhaps the best illuminator extant, and shows objects on a dark ground with sparkling brilliancy, and may be used with polarised light.

A chromatic condenser, somewhat similar in construction to this, and of low price, is made by Messrs. Powell and Lealand; but it is of much higher power, so that the distance between the foci for the central and peripheral rays is not so great, and on this account it yields a somewhat larger aplanatic cone. This instrument with its diaphragms is shown in fig. 256. It is more convenient in form,

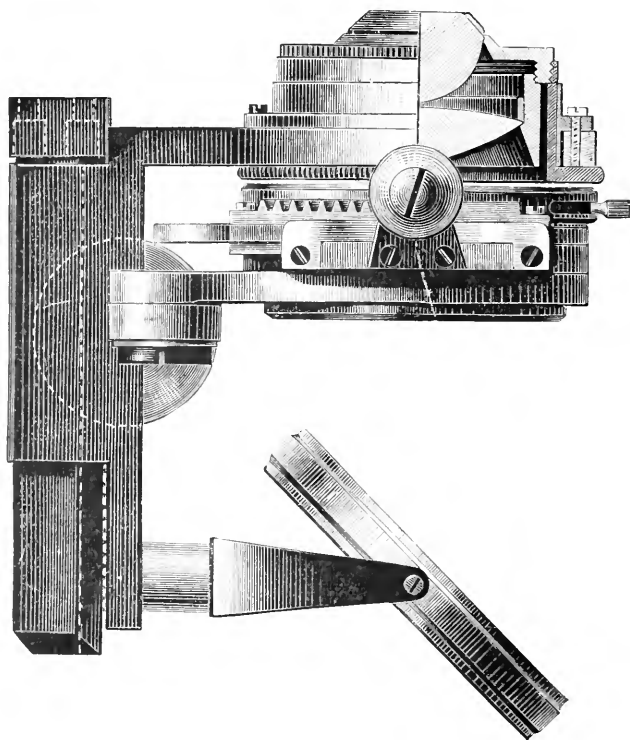

FIG. 255.—Abbe's chromatic condenser as applied to the Zeiss microscopes.

and can be handled and adjusted with greater facility, than that of Abbe. The size of their respective back lenses is significant in this regard, that of Powell's being $\frac{9}{16}$ inch, and that of Abbe's being $1\frac{1}{16}$ inch. This instrument of Powell's, if fitted in the usual way, would be now a very efficient instrument of its kind and quality. The particular quality of oblique illumination was in fact still further advanced by a modified form by the same makers known as Powell's truncated condenser, which gives great obliquity with abundance of light, but it is as a matter of course very chromatic.

The diaphragms (fig. 256, A) have a central aperture for the

purpose of centring, and the movement is made by means of an outer sliding tube *b*, with a slot at the top in which the arm *A* fits, and another arm, *B*, is placed at the lower end so as to give ready command of the rotation. This plan allows of the use of one or two oblique pencils incident 90° apart in azimuth. The condenser thus mounted is only intended as an oblique illuminator. It forms one of the best of the very cheap condensers when it is mounted in a plain tube mount with a ledge to hold the diaphragms. *D* is the optical part of the condenser placed immediately above the diaphragms and in oil-immersion contact with the base of the slide. The circular diaphragm is fixed into the inner tube attached to the sub-stage tube *C*, just below the position of the arm *A*; the other diaphragm is screwed to it by a screw in the eccentric hole, shown in each. It will be seen that when the diaphragms are placed together in this manner the movement of the arm will produce the changes in the light as above mentioned.

As we intimated above, Professor Abbe subsequently produced an *achromatic condenser*, ostensibly for use in high-power photographic work, but in fact of much more general utility. It consisted of a single front with two double backs, and it projects a sharp and perfectly achromatic image of the source of light in the plane of the object. Its power is low, being $\frac{1}{2}$ inch focus, and it has a total aperture of F.0. Its great superiority over the chromatic form is that it transmits a much larger aplanatic cone than that ; for whereas the former gave only an aplanatic cone of .5, this instrument yields a similar cone of .65. But we have already expressed our pleasure that even this form has been surpassed by the high quality condenser illustrated in fig. 257. Like its predecessor, it is large and heavy ; and, with great deference and respect to our Continental neighbours, we would suggest that this is a too general characteristic ; the back lens in this case is more than an inch in diameter, while barely $\frac{3}{4}$ of an inch is utilised when it is transmitting its largest cone. A very excellent modification in fitting it to English microscopes has been made by Mr. Charles Baker, the optician, which is shown in fig. 258, where it will be seen that the fitting for stops is conveniently placed, and an iris diaphragm can be used with great ease below this. This 'turn-out' arm carries a disc of metal to receive the diaphragms.

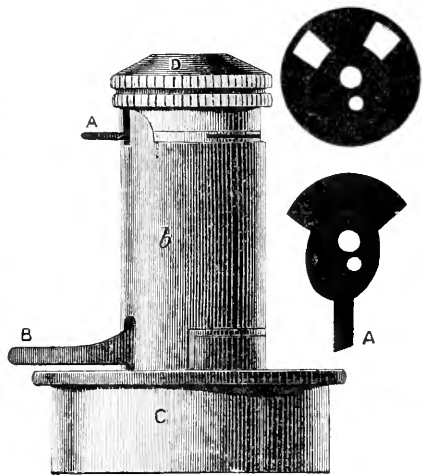

FIG. 256.—Powell and Lealand's chromatic oil condenser (1880).

‘turn-out’ arm carries a disc of metal to receive the diaphragms.

stops, &c. Over this is fitted a ring into which screw adapters, which will allow other condensers to be used on the one mechanism.

The metal disc should have a central aperture as large as the largest back lens of any of the combinations to be used with the mount. It should be thick enough to receive two stops or diaphragms at a time. This power to alter a diaphragm or stop so as to secure any required arrangement of apertures and stops without

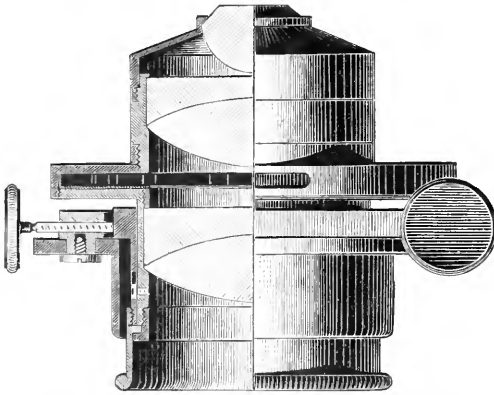

FIG. 257.—Abbe's achromatic condenser (1888).

in the least disturbing any of the adjustments of the condenser is a practical gain of a very valuable kind.

Diaphragms should be marked with the numerical aperture they yield, and stops should be marked with the numerical aperture of the cone they cut out. Empirical numbers are misleading and valueless. This special marking need not involve two sets of diaphragms with two condenser combinations, one for high and the other for low powers; the different numerical apertures for each may be marked on either side of the diaphragm or stop. Memory cannot fail if we make the *lower* side of the diaphragm indicate the apertures for the lower-power condenser, and *vice versa*.

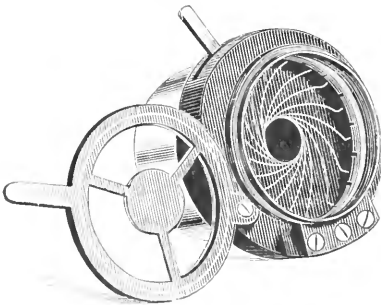

FIG. 258.—Baker's fitting for Abbe's achromatic condenser used in English microscopes.

We may note that for dark-ground work, stops should be placed close to the back lens of the condenser, and in the case of a diaphragm—which is less important—an inch of distance should not be exceeded. This condenser gives dark-ground illumination with objectives of $\cdot 5$ N.A.; for such illumination it is one of the best illuminators extant.

The iris diaphragm is for general purposes more convenient than the usual circular plate, but it has the drawback of being incapable of setting to any exact size. A delicate point in an image, caught with a certain-sized diaphragm, is not regained with ease and certainty with the iris,¹ and may involve much patience and labour; but a well-made *large* plate of graduated diaphragms will wholly remove this difficulty. Moreover, for testing object-glasses it is supremely important that a metal diaphragm be used, so that the conditions of illumination may be readily and accurately reproduced.

It may be of service to those who are unable or indisposed to spend considerable sums upon condensers to state that an excellent achromatic condenser can be made by placing a Zeiss 'aplanatische Lupen' on Steinheil's formula in the sub-stage.² This plan has been adopted in one of Reichert's stands, as we have seen. These are made in two different powers, viz. 1 inch and $1\frac{1}{2}$ inch, and we can fully testify to their being the most useful hand-lenses for ordinary work that can be employed. Great credit is due to Dr. Zeiss for bringing out such excellent achromatic lenses at so low a price, and so meeting a want long and generally felt. Excellent forms of triplet lenses answering a similar purpose are made by Bausch and Lomb after the calculations of Professor Hastings, and most leading makers, Continental and English, make similar magnifiers to those of Zeiss. An achromatic loup of this kind is almost an indispensable accompaniment of a microscopic outfit, and, if a tube to receive it be arranged in the sub-stage, these lenses make really excellent condensers for low powers. It need not have a centring sub-stage, but only a central fitting. It is not of course qualified to supplant the condenser of larger and more perfect instruments, but it is capable of raising students' and other simple microscopes to a much higher level.

Without a condenser the microscope is either (by construction) not a scientific instrument, or it is an instrument unscientifically used. It becomes a mere 'magnifying glass.' It is the adaptation for and use of a condenser—though as simple as a hemispherical lens fitted into a stage plate—that raises it to a microscope.

We have already referred to the nature of the mechanical arrangements needful for the condenser in a general way (Chapter III., pp. 185–190); we may add here that the simplest form of sub-stage being a tube fixed centrally in the optic axis of the microscope, the simplest form of condenser-mount will be a tube sliding into this. It must not screw, it must push, and there should be a little below the back lens a shoulder to hold the diaphragms, stops, glasses, &c. Centring gear is *not* necessary with students' and elementary microscopes. The slight displacements due to varying centres of

¹ It will be urged that apertures can be exactly reproduced with the iris in photographic lenses; why cannot they, therefore, in the case of the microscope? The answer is (1) that with wide-angled condensers a very slight difference in the aperture makes a very great difference in the angle; a similar difference would be inappreciable in the case of a photographic lens. (2) It is in small apertures such as are seldom used in photographic lenses where the difficulty arises in the case of the microscope. (3) It is in the small apertures that the iris fails to respond to the movement of the lever.

² *Journ. Quekett Mic. Club*, vol. iv. ser. ii. p. 77 (1889), on Zeiss's loup. E. M. Nelson.

different objectives will with such microscopes prove of no moment if the sub-stage is once for all carefully fixed centrally in the axis.

What we require to do is to centre the image of the lamp flame, as seen with a low-power lens through the condenser, so that it stands in the middle of the field. This can be done by moving the lamp or the mirror, and until this is satisfactory the best results cannot be obtained. To obviate the inconvenience of having to remove the combination in order to alter a diaphragm¹ or stop in this simple mount an internal sliding tube may be used. It will be a further advantage to have a separate cell to fit into the bottom of the sliding tube to receive coloured glasses; a spiral slot-focussing arrangement may be added with advantage to this kind of mount, acting like a pocket pencil. For students' and elementary microscopes—still so often and so unwisely without condensers—this is a most inexpensive and most convenient arrangement.

An epitome of its principal points may be of service.

1. A sub-stage tube fixed centrally to the body of the microscope.
2. A spiral slotted tube to push into (1).
3. A tube carrying the optical combination of the condenser sliding into (2), with a pin moving in the spiral slot.
4. A long tube carrying the diaphragm and slots sliding into (3).
5. A cell carrying coloured glasses sliding into the bottom of (4).

Condensers require special mounting for use with the polariscope.

Then at least two 'turn-out' rotating rings are required to hold selenites. Swift makes an ingenious *multum in parvo* mount for employing, amongst other things, the condenser with the polariscope, to which we call attention in describing the polariscope. But we know of no plan equal to that found in the best stand of Powell and Lealand. The sub-stage has a double ring, one placed concentrically within the other. The inner one revolves by a milled head and receives the usual sub-stage apparatus. The outer one receives a mount of three selenites which revolve, and are placed on 'turn-out' arms. On the upper part of this mount of selenites is a screw, which receives the optical combination of their dry achromatic condenser. When this is screwed in its place we have a condenser of the first order, with a mount of three plates of selenites taking the place of a mount of diaphragms, &c. Now from the *under* part of the sub-stage into the inner and revolving ring is fitted the polariser, and this leaves little to be desired in practice.

We would advise the microscopist to avoid condenser mounts which carry their own centring movements apart from the sub-stage. It is with regret that we find that this plan has been adopted in Abbe's new achromatic condenser. It is manifestly better to fit the rectangular movements to the sub-stage, and then they become available for all the apparatus employed with the sub-stage. A plan which requires that each piece of sub-stage apparatus which needs centring should be provided with separate fittings for this purpose can have nothing to recommend it.

¹In the technical language or usage of microscopists a diaphragm means a hole in the glass; thus a 'large diaphragm' means that the opening in the diaphragm is large, or that the hole is large. A 'stop' is an opaque disc stopping out central rays.

We give below a list presenting the most important features of the most important condensers, which we believe will be of service to the student and worker.

The aplanatic aperture given in the table means the N.A. of the greatest solid cone a condenser is capable of transmitting, the source of light being the edge of the flame placed in the axis.

The cone transmitted by any condenser is assumed, for practical purposes, to be a solid one, so long as the image seen at the back of the object-glass when the eye-piece is removed (the condenser and flame being centred to the optic axis of the objective, and the source of light focussed by the condenser on the object) presents an unbroken disc of light.

The moment, however, the disc breaks, that is, black spots appear in it, or its periphery breaks away from its centre, then, as we have shown above, spherical aberration comes into play, and the limit of aperture for which that condenser is aplanatic has been exceeded.

Condenser	Total aperture N.A.	Aplanatic aperture N.A.	Power
1. Powell and Lealand's dry achromatic (1854)	.99	.8	$\frac{1}{1\frac{1}{2}}$
2. " " " new formula (1859)	.99	.8	$\frac{1}{1\frac{1}{2}}$
3. " " " top lens removed	—	.5	$\frac{1}{3}$
4. " " " bottom lens only	—	.24	$\frac{1}{4}$
4. Swift's achromatic (1868)	.92	.5	$\frac{1}{10}$
5. " " " top lens removed	—	.22	1
6. Abbe's chromatic (3 lenses) (1873)	1.36	.5	$\frac{1}{3}$
7. " " " top lens removed	—	.3	$\frac{1}{3}$
8. Powell and Lealand's chromatic (Abbe's formula) (1880)	1.3	.7	$\frac{1}{1\frac{1}{2}}$
9. Powell and Lealand's oil achromatic (1886)	1.4	1.1	$\frac{1}{1\frac{1}{2}}$
10. " " " " " used dry	1.0	.8	$\frac{1}{1\frac{1}{2}}$
11. " " " " " top lens removed	—	.4	$\frac{1}{1\frac{1}{2}}$
12. Abbe's achromatic (1888)	.98	.65	$\frac{1}{2}$
13. " " " top lens removed	—	.28	1
14. Powell and Lealand's low-power achromatic (1889)	.83	.5	$\frac{1}{2}$
15. Powell and Lealand's apochromatic (1891)	.95	.9	$\frac{1}{1\frac{1}{4}}$
16. Zeiss's 'aplanatische lupen,' large field (Steinheil formula)	—	.32	1
17. Beck's achromatic, dry (1883)	1.0	.9	$\frac{1}{1\frac{1}{4}}$
18. " oil achromatic (1900)	1.4	1.3	$\frac{1}{1\frac{1}{4}}$
19. Swift's apochromatic, dry (1892)	.95	.92	$\frac{1}{1\frac{1}{4}}$
20. " panaplanatic, dry (1897)	1.0	.93	$\frac{1}{1\frac{1}{4}}$
21. " " oil (1898)	1.4	1.30	$\frac{1}{1\frac{1}{4}}$
22. Watson's panachromatic, dry (1898)	1.0	.95	$\frac{1}{1\frac{1}{4}}$
23. " " oil (1899)	1.33	1.25	$\frac{1}{1\frac{1}{4}}$
24. Zeiss's oil achromatic (1899)	1.30	—	—
25. Baker's semi-apochromatic dry (1900)	1.0	.95	$\frac{1}{3}$

The values of the first sixteen and of Nos. 22, 23, and 25 have been obtained from actual measurements; the others are from the estimates of the makers.

The limit given in the table is for the edge of the flame as a

source of light. When, however, a single point of light in the axis is the source, the condenser will be much more sensitive, and a lower value for the applanatic aperture than that given in the table will be obtained. But as a single point of light is seldom, if ever, practically used in microscopy, it was deemed better to place in the table a practical rather than a theoretical and probably truer result.

It has been stated that the best dark grounds are obtained when a stop is used which is of just a sufficient size to give a suitable dark field and no more.

When such a stop has been chosen, and excellent results are obtained with, say, balsam-mounted objects, if, in the place of this, living animalcules in water be examined, it will probably be found that a dark field can no longer be obtained.

For animalcules in water and 'pond life' generally a stop larger than that employed for ordinary objects will be necessary.

Other Illuminators.—In the course of the history of the microscope a large number of special pieces of apparatus have been devised for the purpose of accomplishing some real or supposed end in illumination. Many of these have proved wholly impracticable and had a mere ephemeral existence; many more never accomplished the end for which they were supposed to be constructed; and a still larger number have been superseded by high-class condensers.

The great majority of these illuminators were devised for the production of oblique light. In the sense in which it was employed a few years ago, it is rendered needless by condensers of great aperture. All the obliquity at present needed can be obtained with good condensers.

To give completeness to this part of our subject it is needful to refer to the SPOT-LENS and the PARABOLOID, although they are only serviceable for very low powers, such as 3-inch to 1½-inch objectives, and for use with higher powers they are superseded by the condenser.

A spot lens is a condenser with a permanent axial stop fixed in it to cut off the central rays for the purpose of obtaining a dark ground upon which the illuminated object lies. Its use is very beneficial in low-power work. Large insect preparations are probably better shown with this device than with any condenser, but when the moderate powers are brought into operation the condenser at once makes manifest its superior qualities.

The paraboloid, or parabolic illuminator, as devised by Mr. Wenham, and subsequently improved by Mr. Shadbolt, ingenious and beautiful instrument as it is, comes under the same category. It consists of a paraboloid of glass that reflects to its focus the rays which fall upon its internal surface. A diagrammatic section of this instrument, showing the course of the rays through it, is given in fig. 259, the shaded portion representing the paraboloid.¹ The

¹ A parabolic illuminator was first devised by Mr. Wenham, who, however, employed a silver speculum for the purpose. About the same time Mr. Shadbolt devised an auxiliary condenser of glass for the same purpose (see *Trans. Microscopical Soc. London*, 1852, pp. 85, 132). The two principles are combined in the glass illuminator.

parallel rays r r' r'' (fig. 259), entering its lower surface perpendicularly, pass on until they meet its parabolic surface, on which they fall at such an angle as to be totally reflected by it, and are all directed towards its focus, F . The top of the paraboloid being ground out into a spherical curve of which F is the centre, the rays in emerging from it undergo no refraction, since each falls perpendicularly upon the part of the surface through which it passes. A stop placed at S prevents any of the rays reflected upwards by the mirror from passing to the object, which, being placed at F , is illuminated by the rays reflected into it from all sides of the paraboloid. Those rays which pass through it diverge again at various angles; and if the least of these, $G F H$, be greater than the angle of aperture of the object-glass, none of them can enter it. The stop S is attached to a stem of wire, which passes vertically through the paraboloid

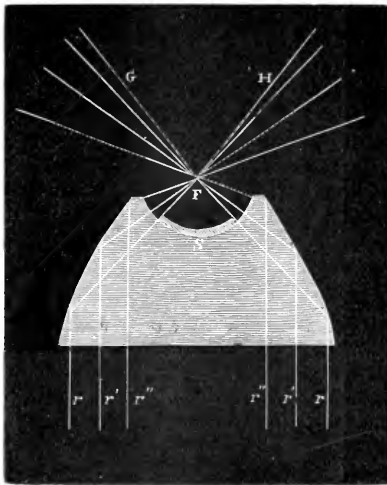

FIG. 259.

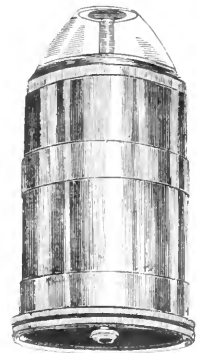

FIG. 260. —Parabolic illuminator.

and terminates in a knob beneath, as shown in fig. 260; and by means of this it may be pushed upwards so as to cut off the less divergent rays in their passage towards the object. It is claimed that this instrument has great capabilities of giving dark-ground illumination with lenses of 'wide apertures;' but that has application to the lenses contemporary with its introduction, and not to wide apertures as applied to the lenses of to-day. In comparison with what can be done with condensers it suffers greatly after we pass the $\frac{1}{2}$ -inch objective, although it does give excellent results with very low powers such as 1-inch, $1\frac{1}{2}$ -inch, 2-inch, and 3-inch objectives when employed to illuminate large objects such as whole insects, because this instrument gives more diffusion of light over the whole of a large object than a condenser does.

Polarising Apparatus.—In order to examine transparent objects by polarised light, it is necessary to employ some means of *polarising*

the rays before they pass through the object, and to apply to them, in some part of their course between the object and the eye, an *analysing* medium. These two requirements may be provided for in different modes. The *polariser* may be either a bundle of plates of thin glass, used in place of the mirror, and polarising the rays by reflexion; or it may be a 'single image' or 'Nicol' prism of Iceland spar, which is so constructed as to transmit only one of the two rays into which a beam of ordinary light is made to divaricate by passing through this substance. Of these two methods the 'Nicol' prism is the one generally preferred, the objection to the reflecting polariser being that it cannot be made to rotate. This polarising prism is usually fixed in a tube, and is shown in a simple form in A, fig. 261; it is usually employed in a sub-stage which rotates by a rack-and-pinion arrangement, so that rotation of the prism is easily effected. For the *analyser* a second 'Nicol' prism is usually employed; and this, fixed in a short tube, may be fitted into a collar interposed between the lower end of the body and the objective, as is shown in B, fig. 261. The prism in this fitting can also

be rotated by the fingers grasping and giving circular motion to the inner fitting of B, and it is always important that the polarising prism should be large, so as not to act as a diaphragm to the condenser, thus cutting off the light when it is used; for the polarising apparatus may be worked in combination either

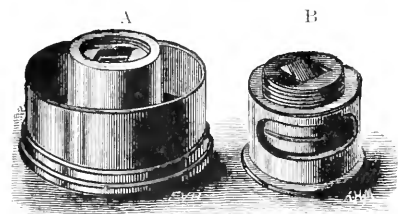

FIG. 261.—Polarising apparatus.

with the achromatic condenser, by which means it may be employed with high-power objectives, or as a 'dark-ground' illuminator, which shows many objects—such as the horny polyparies of zoöphytes—gorgeously projected in colours upon a dark field.

For bringing out certain effects of colour by the use of polarised light it is, as already stated, desirable to interpose a plate of *selenite* between the polariser and the object; and it is advantageous that this should be made to revolve. A very convenient mode of effecting this is to mount the selenite plate in a revolving collar, which fits into the upper end of the tube that receives the polarising prism. In order to obtain the greatest variety of coloration with different objects, films of selenite of different thicknesses should be employed; and this may be accomplished by substituting one for another in the revolving collar. A still greater variety may be obtained by mounting three films, which separately give three different colours, in collars revolving in a frame resembling that in which hand-magnifiers are usually mounted, this frame being fitted into the sub-stage in such a manner that either a single selenite, or any combination of two selenites, or all three together, may be brought into the optic axis above the polarising prism (fig. 262). As many as thirteen different tints may thus be obtained. When the construction of the micro-

scope does not readily admit of the connection of the selenite plate with the polarising prism, it is convenient to make use of a plate of brass (fig. 263) somewhat larger than the glass slides in which objects are ordinarily mounted, with a ledge near one edge for the slide to rest against and a large circular aperture into which a glass is fitted, having a film of selenite cemented to it; this 'selenite stage' or object-carrier being laid upon the stage of the microscope, the slide containing the object is placed upon it, and, by an ingenious modification contrived by Dr. Leeson, the ring into which the selenite plate is fitted being made movable, one plate may be substituted for another, whilst rotation may be given to the ring by means of a tangent-screw fitted into the brass plate. The variety of tints given by a selenite film under polarised light is so greatly increased by the interposition of a rotating film of mica that two selenites—*red* and *blue*—with a mica film, are found to give the entire series of colours obtainable from any number of selenite films, either separately or in combination with each other.

The compact apparatus made by Swift as a general sub-stage illuminator is useful and commendable, and is capable of adaptation to most English microscopes. It is shown in fig. 264. The special advantage of this condenser lies in its having the polarising

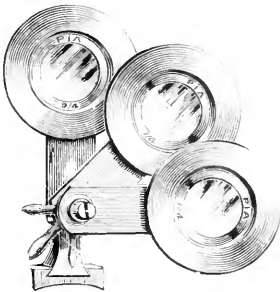

FIG. 262.



FIG. 265.

prism, the selenite and mica films, the black ground and oblique-light stops, and the moderator all brought close under the back lens of the achromatic; whilst it combines in itself all the most important appliances which the sub-stage of a good moderate microscope can require.

Rings and Brushes.—Mr. Nelson has pointed out (*Journ. R.M.S.*, 1892) that it is remarkable the microscopical text-books give no account of the method of viewing the rings and brushes which certain minerals show under polarised light. If the instrument be set up as if for viewing ordinary polariscope objects, not a ring or a brush will be seen.

The whole point lies in the fact that it is a wide-angled *telescope* that is required, and not a microscope. Once this is recognised the whole matter is simple. As the microscope has to be turned into a wide-angled polarising telescope, all that is necessary is to screw a low power on the end of the draw-tube, as in fig. 265. As the light requires to be passed through the crystal at a considerable angle, a wide-angled condenser should be employed, but it need not be achromatic.

The objective most suitable is a $\frac{4}{10}$ ths of $\cdot 65$ N.A.; but a $\frac{1}{4}$ th of $\cdot 71$ N.A., or a $\frac{1}{3}$ rd of $\cdot 65$ N.A. will do equally well, as the whole of the back lens of the objective should be visible through the analysing 'Nicol;' the back lens of the objective must not be too large, thus a $\frac{1}{2}$ inch of $\cdot 65$ N.A. would not do so well. The analysing prism may be placed either where it is in the drawing or above the eye-piece. Practically it works very well above the objective, which is the position it occupies in 'ordinary microscopical outfits.'

For the draw-tube a 2-inch objective and a B or C eye-piece will answer admirably.

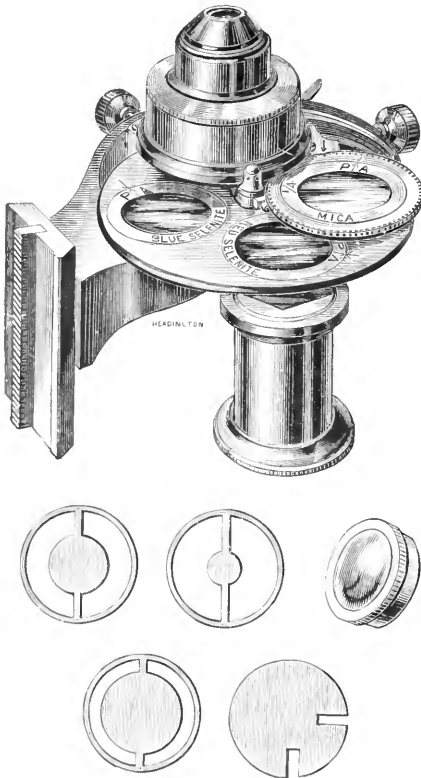

FIG. 264.—Swift's illuminating and polarising apparatus.

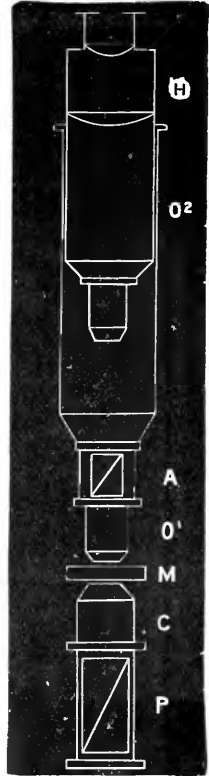

FIG. 265.—In this diagram P is the polarising prism in the sub-stage, C sub-stage condenser. On the stage M mineral. On nose-piece O¹ objective $\frac{4}{10}$ ths $\cdot 64$ N.A.; A analysing prism. In the draw-tube, O² objective 2 or 3 in. H, Huyghenian eye-piece.

For setting up the instrument it is better, before screwing the objective in the end of the draw tube, to centre the light in the usual manner, the 'Nicol's' being turned so as to give a light field. Next fix the objective in the draw-tube, open the sub-stage condenser to full aperture, and put the mineral on the stage. Rack

down the body, so that the objective on the nose-piece nearly touches the crystal; then focus with the draw-tube exclusively. The sub-stage condenser should be racked up close to the under side of the crystal.

The use of monochromatic light is frequently desirable in microscopic work, especially blue light, although of less moment than in pre-achromatic days. The usual method of obtaining coloured light is to pass sunlight through coloured glass, or through a coloured solution, such as the ammonio-sulphate of copper; but this is a most imperfect and unsatisfactory method, and does not give monochromatic light. This most valuable mode of illumination has been made possible by the use of what is now known as the Gifford

screen, from the name of its inventor, Mr. J. W. Gifford; and when artificial light is used one of these screens should be interposed between the lamp and the sub-stage condenser. It is shown in fig. 266, and consists of a glass trough, about 3 inches long by 2 inches broad and $\frac{2}{10}$ ths deep, filled with a solution of methyl green and glycerin mixed

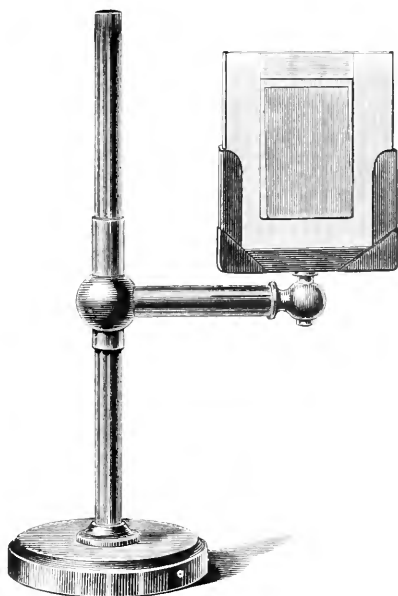

FIG. 266.—Gifford screen with an adjustable stand.



FIG. 267.—Gifford's F-line monochromatic light screen.

warm. Now this solution passes a little band of infra red, which must be cut out. To do this a piece of signal green glass just fitting the trough is placed in it.

A piece of ordinary commercial signal green would cut out too much light, and render the screen too opaque; therefore it is requisite to have this signal green glass worked down to about half its thickness, so that only the infra red passed by the methyl green is cut out, and nothing more. This screen is called an F-line screen, because the F line is in the centre of the band passed by it. The band for general microscopical purposes may usefully extend from E to G. The importance of this screen cannot be held too high by the modern microscopist. It makes semi-apochromatic

objectives equal to real apochromatics, and it sharpens the images yielded even by the latter, whilst it increases resolving power in all lenses, and ameliorates the strain often felt by workers who have not before used it.

The cell containing the solution and worked glass may either have its upper end sealed hermetically with paraffin, or be simply carefully corked; the latter plan, if the cork is carefully made, admits of the easy opening of the cell and renewal of the fluid. A diagrammatic illustration of the effect of the use of the screen is given in fig. 267, which represents the band of colour passed through the F-line screen. The green is represented by the horizontal lines, and the blue, in which the F line is situated, by the diagonal lines.

The cell itself is prepared by the Leybold's process, and is fused at the joints and never leaks; a still simpler and less expensive means of making such a filter has been devised by Dr. A. Meithe, professor of spectral analysis at Berlin. The filter consists of a trough containing

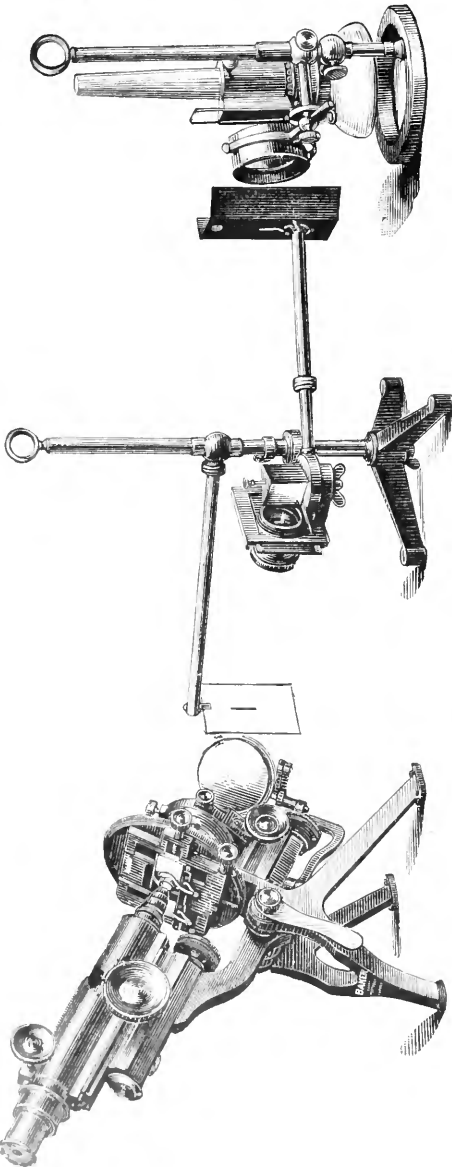

FIG. 268.—Mr. Nelson's apparatus for obtaining monochromatic light.

$\frac{1}{8}$ of an inch in thickness of saturated solution of acetate of copper filtered; a variation in the thickness of the troughs or tanks is desirable, but the results are excellent.

Equally perfect monochromatic illumination can be obtained by prismatic dispersion.

A method of approximating to monochromatic illumination has been devised by Mr. Nelson which answers admirably with an ordinary $\frac{1}{2}$ -inch wick paraffin lamp. Briefly, the rays proceeding from the radiant are passed through a slit, as in fig. 268, and dispersed by a prism of glass, and by means of a second slit any portion we wish may be selected from the spectrum to be used for the purpose required.

First an image of the edge of the flame is focussed upon the slit by means of a bull's-eye consisting of three lenses: next the slit is placed in the principal focus of a lens known as a Wray 5×4 R R, working at $\frac{f}{5.6}$ (this lens is not shown in the cut). In the parallel beam from this lens and close to it is placed an equilateral prism of dense flint set at minimum deviation. Close to the prism is placed another Wray 5×4 R R, working at $\frac{f}{5.6}$. If a cardboard screen be

held at the principal focus of this lens, there will be seen a spectrum brilliantly illuminated. A slit $\frac{1}{10}$ th inch in diameter is cut in the cardboard screen, through which the required colour is allowed to pass to the mirror of the microscope, thence to the sub-stage condenser. For visual work blue green is the best, but for photographic work blue would be chosen unless orthochromatic work required a colour lower down the spectrum.

Sorby-Browning Micro-spectroscope.¹—When the solar ray is decomposed into a coloured spectrum by a prism of sufficient dispersive power, to which the light is admitted by a narrow slit, a multitude of dark lines make their appearance. The existence of these was originally noticed by Wollaston; but as Fraunhofer first subjected them to a thorough investigation and mapped them out, they are known as *Fraunhofer lines*. The greater the dispersion given by the multiplication of prisms in the spectroscope, the more of these lines are seen; and they bear considerable magnification. They result from the interruption or absorption of certain rays in the solar atmosphere, according to the law, first stated by Angström, that 'rays which a substance absorbs are precisely those which it emits when made self-luminous.' Kirchhoff showed that while the incandescent vapours of sodium, potassium, lithium, &c. give a spectrum with characteristic *bright* lines, the same vapours intercept portions of the spectrum so as to give *dark* lines at the points where the bright ones appeared, absorbing their own special colour, but allowing rays of other colours to pass through. Again, when ordinary light is made to pass through coloured bodies (solid, liquid, or gaseous), or is reflected from their surfaces so as to affect the eye with the sensation of colour, its spectrum is commonly found to exhibit absorption *bands*, which differ from the Fraunhofer lines not only in their greater breadth, but in being more or less *nebulous* or

¹ For general information on the spectroscope and its uses the student is referred to Professor Roscoe's *Lectures on Spectrum Analysis*, or the translation of Dr. Schellen's *Spectrum Analysis*, and *How to use the Spectroscope*, by Mr. John Browning.

cloudy, so that they cannot be resolved into distinct lines by magnification, while too much dispersion thins them out to indistinctness. Now, it is by the character of these bands, and by their position in the spectrum, that the colours of different substances can be most accurately and scientifically compared, many colours whose impressions on the eye are so similar that they cannot be distinguished being readily discriminated by their spectra. The purpose of the micro-spectroscope¹ is to apply the spectroscopic test to very minute quantities of coloured substances; and it fundamentally consists of an ordinary eye-piece (which can be fitted into any microscope) with certain special modifications. As originally devised by Dr. Sorby and worked out by Mr. Browning, the micro-spectroscope is constructed as follows (fig. 269): Above its eye-glass, which is achromatic, and made capable of focal adjustment by the milled head, B, there is placed a tube, A, containing a series of five prisms, two of flint glass (fig. 270, F F) interposed between three of crown (C C C) in such a manner that the emergent rays, *r r*, which have been separated by dispersion, leave the prisms in much the same

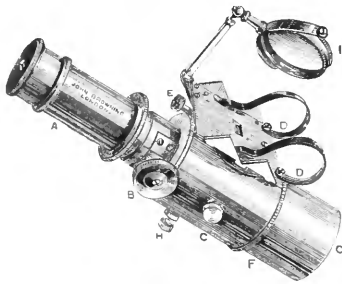

FIG. 269.—Micro-spectroscope.

direction as the immergent ray entered it. Below the eye-glass, in the place of the ordinary stop, is a diaphragm with a narrow slit which limits the admission of light (fig. 269); this can be adjusted in vertical position by the milled head, H, whilst the breadth of the slit is



FIG. 270.

regulated by C. The foregoing, with an objective of suitable power, would be all that is needed for the examination of the spectra of objects placed on the stage of the microscope, whether opaque or transparent, solid or liquid, provided that they transmit a sufficient amount of light. But as it is of great importance to make exact comparisons of such artificial spectra, alike with the ordinary or natural spectrum and with each other, provision is made for the formation of a second spectrum by the insertion of a right-angled prism that covers one half of this slit, and reflects upwards the light transmitted through an aperture seen on the right side of the eye-piece. For the production of the ordinary spectrum, it is only requisite to reflect light into this aperture from the small mirror, I, carried at the side; whilst for the production of the spectrum of any substance through which the light reflected from this mirror can be transmitted, it is only necessary to place the slide carrying the section or crystalline film, or the tube containing the solution, in

¹ We do not make the change, lest complications should arise; but we think it would be more harmonious with analogy to call this instrument the *spectro-microscope*.

the frame, D D, adapted to receive it. In either case this second spectrum is seen by the eye of the observer alongside of that produced by the object viewed through the body of the microscope, so that the two can be exactly compared.

The exact position of the absorption bands is as important as that of the Fraunhofer lines; and some of the most conspicuous of the latter afford fixed points of reference, provided the same spectro-scope be employed. The amount of dispersion determines whether the Fraunhofer lines and absorption bands are seen nearer or farther apart, their actual positions in the field of view varying according to the dispersion, while their relative positions are in constant proportion. The best contrivance for measuring the spectra of absorption bands is Browning's bright-line micrometer, shown in fig. 271. At R is a small mirror by which light from the lamp employed can be reflected through E D to the lens C, which, by means of a perforated stop, forms a bright pointed image on the surface of the upper prism, whence it is reflected to the eye of the observer. The rotation of a wheel worked by the milled head, M, carries this bright point over the spectrum, and the exact amount of motion may be read off to $\frac{1}{1,000,000}$ th inch on the graduated circle of the wheel. To use this apparatus, the Fraunhofer lines must be viewed by sending bright daylight through the spectro-scope, and the positions of the principal lines carefully measured, the reading on the micrometer-wheel being noted down. A spectrum map may then be drawn on cardboard, on a scale of equal parts, and the lines marked on it, as shown in the upper half of fig. 272. The lower half of the same figure shows an absorption spectrum, with its bands at certain distances from the Fraunhofer lines. The cardboard spectrum map, when once drawn, should be kept for reference.¹

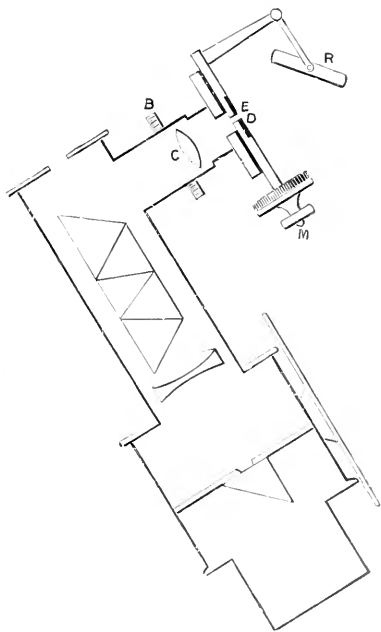

FIG. 271.—Bright-line spectro-micrometer.

A beginner with the micro-spectroscope should first hold it up to the sky on a clear day, without the intervention of the microscope.

¹ Mr. Swift has devised an improved micro-spectroscope, in which the micrometric apparatus is combined with the ordinary spectroscopic eye-piece, and two spectra can be brought into the field at once. Other improvements devised by Dr. Sorby and a new form devised by Mr. F. H. Ward have been carried into execution by Mr. Hilger. (See *Journ. of Roy. Microsc. Soc.* vol. i. 1878, p. 326, and vol. ii. 1879, p. 81.)

and note the effects of opening and closing the slit by rotating the screw, C (fig. 269); the lines can only be well seen when the slit is reduced to a narrow opening. The screw H diminishes the length of the slit, and causes the spectrum to be seen as a broad or a narrow ribbon. The screw E (or in some patterns two small sliding knobs)

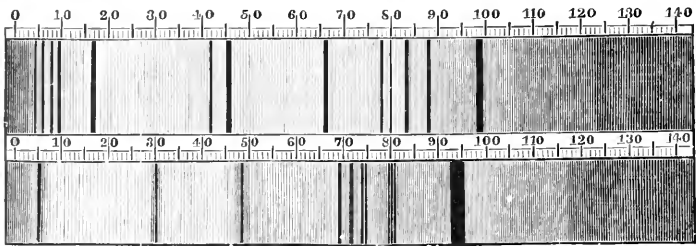

FIG. 272.—Upper half, map of solar spectrum, showing Fraunhofer lines. Lower half, absorption spectrum, showing position of bands in relation to lines.

regulates the quantity of light admitted through the square aperture seen between the points of the springs, DD. Water tinged with port wine, madder, and blood are good fluids with which to commence this study of absorption bands.¹ As each colour varies in refrangibility, the focus must be adjusted by the screw B, fig. 269,

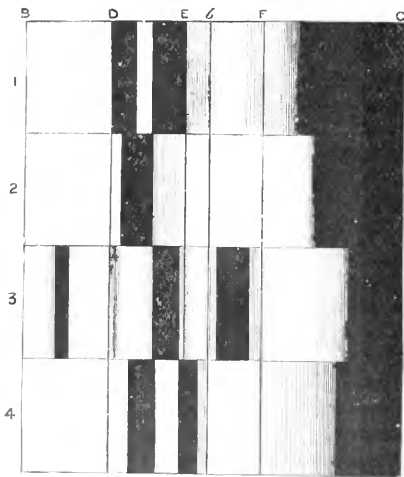

FIG. 273.

according to the part of the spectrum that is examined.

When it is desired to see the spectrum of an exceedingly minute object, or of a small portion only of a larger one, the prisms are to be removed by withdrawing the tube containing them; the slit should then be opened wide, and the object, or part of it, brought into the centre of the field; the vertical and horizontal slits can then be partly shut so as to enclose it; and if the prisms are then replaced and a suitable objective employed, the required spectrum will be seen, unaffected by adjacent objects. For ordinary observations objectives of from two

inches to $\frac{2}{3}$ -inch focus will be found most suitable; but for very minute quantities of material a higher power must be employed. Even a single red blood-corpusele may be made to show the

¹ A series of specimens, in small tubes, for the study of absorption-spectra, is kept on sale by Mr. Browning; and the directions given in his *How to work with the Micro-polycope* should be carefully attended to.

characteristic absorption bands represented (after Professor Stokes) in fig. 273.¹

For the study of coloured liquids in test-tubes or small cells, the *binocular spectrum microscope*, described by Dr. Sorby in the 'Proceedings of the Royal Society,' No. 92, 1867, p. 33, is extremely convenient.

The *spectral ocular by Zeiss* is another and a very perfect form of the *micro-spectroscope*. This is an opinion expressed by Dr. Sorby and other experts, and it is manifest in the character of the instrument. Fig. 274 represents a sectional view of the instrument. It will be seen that the lower part is an ordinary eye-piece with its two lenses, but in place of the ordinary diaphragm there is a slit adjustable in length and breadth, shown in fig. 275. By studying this figure the method of adjustment with two screws, F and H, and the projecting lever, which carries a reflecting prism, can be

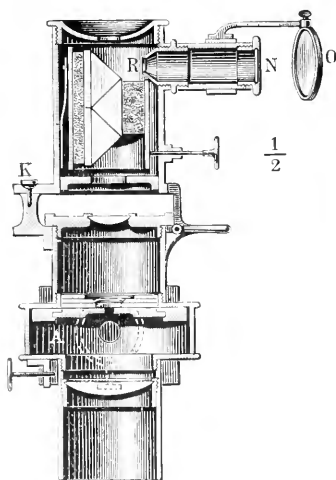

FIG. 274.

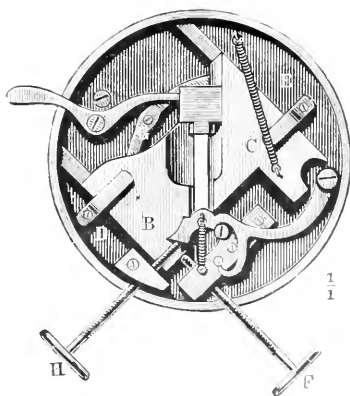

FIG. 275.

readily understood. The upper part of the instrument swings about the pivot, K, so that by opening the slit the eye-piece can be used for focussing an object, the slit being the diaphragm. The upper portion contains the prisms, and also a scale in the tube, N, which is illuminated by the mirror, O. The image of the scale is reflected from the upper surface of the last prism to the eye, and when properly adjusted gives the wave-length of the light in any part of the spectrum. There is also a supplementary stage, not shown in the figure, upon which a specimen can be placed, and its light thrown up through the slit by reflection from the prism on the lever shown in fig. 274, alongside of the light from the object on the stage of the microscope, thus enabling the spectra from the two sources to be directly compared.

¹ For further information on 'The Spectrum Method of Detecting Blood,' see an important paper by Dr. Sorby in *Monthly Microsc. Journ.* vol. vi. 1871, p. 9.

The Method of using the Micro-spectroscope.—The objects to be investigated are of two sorts, liquid and solid. Colouring substances, as chlorophyll, the colouring matter of hair, blood, &c., will frequently come under micro-spectroscopic investigation in the form of a solution. In general we need scarcely say anything concerning the preparation of the solution. In reference to the chlorophyll of the phanerogams especially, the particular part of the plant from which the preparation is to be made, as, for instance, the foliage leaves, is put for a short time in boiling water, then quickly dried by means of bibulous paper, and then immersed for a longer time in absolute alcohol, ether, or benzole in a dark place, for the purpose of extracting the chlorophyll colouring matter. The concentration of the solution thus produced, which influences the intensity of the absorption spectrum and the number and length of the absorption bands, depends naturally upon the time during which the material is in the extracting medium, as well as on the quantity of the material.

Commonly also a solution of less concentration will give the same intensity of spectrum if a sufficiently thick layer of it be used. The solution can generally be examined in an ordinary test-tube. The test-tube is filled and carefully corked, and then laid on the stage of the microscope or held before the opening of the comparison prism, as the case may be. For the latter purpose (bringing liquids before

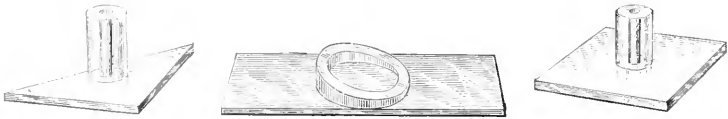

FIG. 276.

the opening of the comparison prism) a small open trough of glass, with two parallel glass plates, is very useful. For exact investigations, however, the trough-flask is preferable. It is a flask whose two sides, back and front, are parallel, furnished with a carefully fitted ground-glass stopper. It should be filled quite full of the solution and then laid with its broad side on the stage. It is especially indispensable when we wish to study the combination spectrum of two solutions. In that case two flasks are filled each with a different solution, and both laid upon the stage, one upon the other. For the purpose of examining small quantities of any liquid, a sufficient depth being obtained with very little material, vertical glass tubes attached to horizontal plates are used, as proposed by Mr. Sorby and shown in fig. 276. The narrow tubes are made of various lengths from sections of barometer tubing, in order to present different thicknesses of the contained fluid, the broad tube being higher on one side than the other, and thus constituting a wedge-shaped cell, which, when filled and closed by a thin cover-glass, will present a varying thickness of fluid for study and comparison. If the object to be investigated is not a solution, but a preparation of the kind which we commonly employ in microscopic inquiries, we must first of all bring it into the focus of the objective system. To do this we must first remove the tube bearing

the prisms, open the slit somewhat, and use the apparatus as a simple ocular. If one has to deal with a small object which does not entirely fill the slit, but allows rays of light to come in past it and disturb the spectrum, he should turn the comparison prism so as to shut up some of the slit, without, however, letting in the light upon it, and then bring the object up near to it, and from the other side push up the shortening apparatus as close as is necessary. On the other hand, should the object consist of a number of single minute grains, which would cause to be drawn across the spectrum, in the direction of its length, perpendicular to the Fraunhofer lines, a like number of dark lines, one must adjust the microscope so that the object will be a little out of focus, somewhat above or below the true focus. In this way we shall get a uniform spectrum. The spectrum can also be improved in some other cases by likewise throwing the object somewhat out of focus.

Illumination by Reflection.—Objects of almost every description will require at times to be examined and studied by what is called reflected light; the light in this case is thrown down upon the object by various devices, and is reflected upwards through the objective. This has been called 'opaque illumination,' which, however, is not a comprehensive, nor even an accurate designation. Only a small proportion of the objects examined in this way are opaque; the same diatom, for example, may often with advantage be examined with transmitted light, being transparent, and again by means of an illumination thrown upon, and reflected up from, its surface; also a condenser with a central stop, when used for a dark ground, shows objects by reflected light, but it is manifestly not 'opaque illumination.' The designation of this method of illumination is consequently more accommodating than accurate.

There are two very simple means of obtaining this superficial illumination when low powers are employed. The first is the 'bull's-eye' (which is nowhere in this work called a 'condenser;': this would, as it often has done, lead to confusion; it is enough to

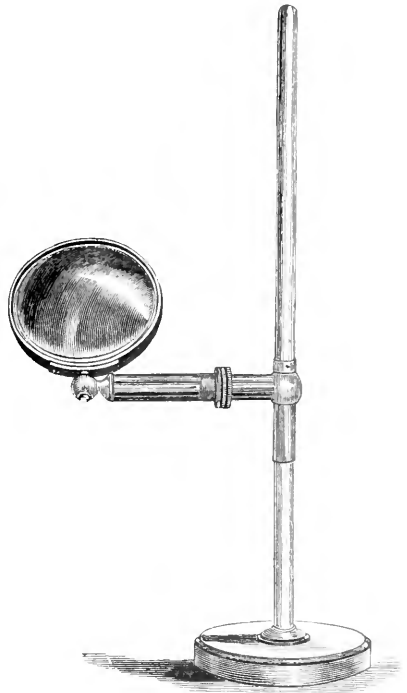

FIG. 277.—The English form of bull's-eye.

designate it as we have done). It is a plano-convex lens of short focus, two or three inches in diameter, mounted upon a separate stand in such a manner as to permit of its being placed in a great variety of positions. The mounting shown in fig. 277 is the usual adopted in England; the frame which carries the lens is borne at the bottom upon a swivel joint, which allows it to be turned in any azimuth; whilst it may be inclined at any angle to the horizon, by the revolution of the horizontal tube to which it is attached, around the other horizontal tube which projects from the stem. By the sliding of one of these tubes within the other, again, the horizontal arm may be lengthened or shortened; the lens may be secured in any position (as its weight is apt to drag it down when



FIG. 277A.

it is inclined, unless the tubes be made to work, the one into the other, more stiffly than is convenient) by means of a tightening collar milled at its edges; and finally the horizontal arm is attached to a spring socket which slides up and down upon a vertical stem.

A good form of the bull's-eye is made by Leitz, and is illustrated fig. 277A. All the required movements are provided for, but in a different way; the clamping screws are by means of usual milled heads.

The plane side of the bull's-eye should be turned towards the object. Some microscopists like to have their bull's-eye attached to some part of the microscope; but if this is done, care must be taken to attach it to a fixed part of the microscope, and not to either the

mechanical stage or to the body, as is so often done. If it is fixed to the mechanical stage, when the object is moved the light will require to be readjusted, to say nothing of the probable injury to the stage by the weight of the bull's-eye. If it is fixed to the body the light will be displaced when the focus of the objective is altered. Hence the bull's-eye should either have a weighted separate stand, or be attached to the stand or holder of the lamp or other illuminant.

The optical effect of such a bull's-eye differs according to the side of it turned towards the light and the condition of the rays which fall upon it. The position of *least* spherical aberration is when its *conceal* side is turned towards *parallel* or towards the *least diverging* rays; consequently, when used by daylight, its *plane* side should be turned towards the *object*, and the same position should be given to it when it is used for procuring converging rays from a lamp, this being placed four or five times farther off on one side than the object is on the other. But it may also be employed for the purpose of reducing the diverging rays of the lamp to parallelism, for use either with the paraboloid, or with the parabolic speculum to be presently described; and the *plane* side is then to be turned towards the lamp, which must be placed at such a distance from the bull's-eye that the rays which have passed through the latter shall form an inverted image of the lamp flame on the wall or a distant screen. For viewing minute objects under high powers, a smaller lens may be used to obtain a further concentration of the rays already brought into convergence by the bull's-eye. An ingenious and effective mode of using the bull's-eye for the illumination of very minute objects under higher-power objectives has been devised by Mr. James Smith. The microscope being in position for observation, the lamp should be placed either in the front or at the side (as most convenient), so that its flame, turned edgewise to the stage, should be at a somewhat *lower level*, and at a distance of about three inches. The bull's-eye should be placed between the stage and the lamp, with its plane surface uppermost, and with its convex surface a little *above* the stage. The light entering its convex surface near the margin turned towards the lamp falls on its plane surface at an angle so oblique as to be almost totally reflected towards the opposite margin of the convex surface, by which it is condensed on to the object on the stage, on which it should cast a sharp and brilliant wedge of light. The adjustment is best made by first placing a slip of white card on the stage, and, when this is well illuminated, substituting the object slide for it, making the final adjustment while the object is being viewed under the microscope. No difficulty is experienced in getting good results with powers of from 200 to 300 diameters, but higher powers require careful manipulation and yield but doubtful results.

The second simple method of securing this illumination is to have the concave mirror of the microscope capable of being used above the stage,¹ so that the source of light may by its means be focussed on the object. Neither of these plans will answer for other than low

¹ See *Journ. Roy. Microsc. Soc.* vol. iii. 1880, p. 398.

powers, where there is plenty of room for the light to pass between the objective and the object. The ingenious use of the bull's-eye employed by Mr. James Smith, as detailed above, increases the possibility of magnification, but it needs practice and care. With the great improvement which has been effected in objectives and condensers the need of a bull's-eye which should give the minimum of aberration has become a desideratum; and Mr. Nelson has calculated and had constructed a doublet bull's-eye which gives admirable results. There are described in most treatises on optics doublets devised by Herschel which are said to be of 'no aberration.' Mr. Nelson has shown ('*Journ. Q. M. S.*,' vol. vi. ser. ii. p. 197, 1896) that they are by no means free from spherical aberration, and that their forms are such as will not even yield a minimum amount of such aberration; also that there is a numerical error in the focal length of the high-power doublet. He has computed that the spherical aberration in the Herschel doublets amounts to $-.296 \frac{f^2}{f'}$, and he gives the following formula for a combination, the spherical aberration of which is $-.207 \frac{f^2}{f'}$; or 30 per cent. less than in either of those proposed by Sir John Herschel.

Boro-silicate glass, Jena catalogue No. 5; $\mu=1.51$.

$$\frac{\mu-1}{\mu} = 64.0.$$

1st lens crossed,	$r = + 2.359$	} diameter 2.1;
	$s = -15.078$	
2nd lens meniscus,	$r = + 1.280$	} diameter 1.8.
	$s = + 3.434$	

Distance between the lenses .05, equivalent focus 2.0, working distance or back focus 1.55, total aberration $-.1035$, clear aperture 2.0, angle 62° . The second Gauss point of the combination is close to the posterior surface of the crossed lens.

As there are some microscopists who might require a combination of this kind, but with a different focal length, and who are unable to transpose the formula, the following rule may be of use. Halve all the radii and diameters and multiply the results by the focal length that is required. *Example.*—Required a doublet on this formula with $3\frac{1}{2}$ inches of equivalent focus. Halving the data for the crossed lens in the given formula, we have $r = +1.1795$, $s = -7.539$, diameter 1.05; multiplying these results by $3\frac{1}{2}$ we obtain $r = +4.128$, $s = -26.386$, diameter 3.7. Treat the meniscus in the same way; the lens distance may with advantage be kept .05.

The following bull's-eye is not so expensive to manufacture, and may on that account be preferred to the doublet of minimum aberration just described. Its form, though of minimum aberration for two plano-convex lenses, possesses 43 per cent. more aberration than the former. It will on this account not be possible to obtain such an even and unbroken disc of light with this form of bull's-eye as with the other. The data are as follows.

Glass, boro-silicate, the same as before.

$$\left. \begin{array}{l} \text{Radii } r = +2.72 \\ s = \infty \end{array} \right\} \text{diameter } 2.1 ;$$

$$\left. \begin{array}{l} r' = +1.63 \\ s' = \infty \end{array} \right\} \text{diameter } 1.9.$$

Distance of lenses apart .05, equivalent focus 2.0, working distance 1.50, angle 60° .

It is illustrated in a mounted form in fig. 278. Combinations having different foci may be constructed in the same manner as in the example above.

An illuminator not so well known, or at least so much used, as its merits justified, is Powell and Lealand's small bull's-eye of $\frac{3}{4}$ inch focus, which slides into an adapter fixed into the sub-stage, and susceptible of its rack motion up and down. The object is placed on a super-stage, and lies considerably above, but parallel with, the ordinary stage. The bull's-eye, capable thus of being raised or lowered, and of being moved by sliding away from or close to the mounted object, has its plane side placed against the edge, and at right angles to the plane of the slip. By this means illumination of great obliquity can be obtained, and very surprising effects secured even with high powers. It was much used by the Editor and Dr. Drysdale in their earlier work on the saprophytic organisms, and, in the days before homogeneous lenses, helped us over many difficulties of detail. It was the first illuminator to actually resolve the *Amphiptera pellucida*. It could be very easily obtained with a student's microscope provided with Nelson's open stage,¹ for on this the bull's-eye could be placed against the edge of the slip without any special apparatus or fitting.



FIG. 278.—Bull's-eye of good but not the best form as devised by Mr. Nelson.

Another and popular method of 'opaque illumination' is by means of a specialised form of mirror, generally of polished silver, called a *side reflector*, and fixed, as in the case of the bull's-eye, and for the same reasons, to an immovable part of the microscope.

The manner of employing this reflector, as provided with Powell and Lealand's best stand, is seen in Plate III. The arm of the side reflector is fixed to an immovable part of the stand, and is thus unaffected by the racking up or down of the body. The lamp placed on the right of the observer is set at such a height that its beams fall full upon the reflector; this, by means of a ball-and-socket joint, can be easily manipulated until the full image of the flame is caused to fall upon the object. For the same purpose a *parabolic speculum* is commonly employed, mounted either on the objective, as in Beck's form, fig. 279, or on an adapter, as in Crouch's, shown in fig. 280, where a collar is interposed between the lower end of the body of the microscope and the objective seen at A. *This is not*

¹ Fig. 134.

a commendable plan, for it increases the distance between the objective and the Wenham binocular prism; and as the binocular is specially suited for the kind of object usually examined with this speculum, this increased distance, acting detrimentally on the behaviour of the binocular prisms, and causing the available racking distance for the focus of objectives of very low power to be shortened by the width of such collar, is to be avoided.

The best plan without doubt is to attach the speculum to a fixed

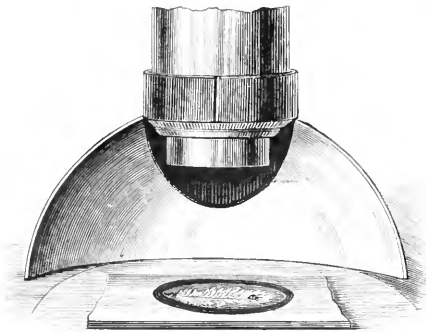

FIG. 279.

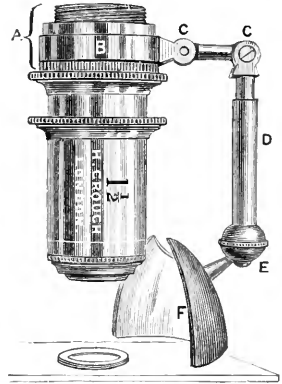

FIG. 280.

part of the stand, as is done in the Powell and Lealand, the Ross, and the Beck stands.

A modification of the parabolic reflector was devised by Dr. Sorby, and has proved to be very useful in certain investigations, such as the microscopic structure of metals. It consists of a parabolic reflector, in the centre of which, in a semi-cylindrical tube open in front, is placed a small plane reflector which covers half of the objective, and throws the light directly down upon the object and

back through the other half. It is shown in fig. 281 with the cylinder in place, and in the dotted lines with the same turned out. This arrangement allows of two kinds of illumination, oblique and direct, being readily used, as the plane reflector is attached to an arm so that it can be swung out of the

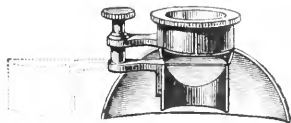

FIG. 281.—Sorby's modification of the parabolic reflector.

way when not required, as shown in the figure.

Dr. Sorby was able to get results in the examination of polished sections of steel not otherwise attainable.

No opaque illumination, however, has yet surpassed the venerable **Lieberkühn**; the best experts freely admit that the finest critical images to be obtained by this method of illumination are secured by the **Lieberkühn**. This mode of illuminating opaque objects is by means of a small concave speculum reflecting directly down upon them to a focus the light reflected up to it from the mirror; it was



formerly much in use, but is now comparatively seldom employed. This concave speculum, termed a 'Lieberkühn,' from the celebrated microscopist who invented it, is made to fit upon the end of the objective, having a perforation in its centre for the passage of the rays from the object to the lens; and in order that it may receive its light from a mirror beneath (fig. 282, A), the object must be so mounted as only to stop out the central portion of the rays that are reflected upwards. The curvature of the speculum is so adapted to the focus of the objective that, when the latter is duly adjusted, the rays reflected up to it from the mirror shall be made to converge strongly upon the part of the object that is in focus; a separate speculum is consequently required for every objective.

It has two manifest drawbacks: the first one, *that of requiring a separate Lieberkühn for each objective,* is a difficulty which in the nature of things cannot be overcome. The radius of the Lieberkühn

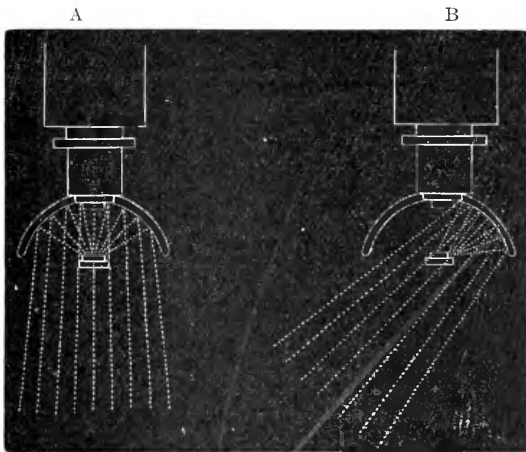

FIG. 282.

must alter with the focus of the objective employed, and each should have a certain amount of play on the objective to allow for slight alterations of focus; for if we employ parallel rays it is obvious that the Lieberkühn will focus nearer to the object than if divergent rays are used. This is met by an allowance being made to compensate it on the tube which slides the Lieberkühn on to the nose of the objective.

The second drawback has reference to the special way in which objects have to be mounted in order to be suitable for the Lieberkühn. This could be easily avoided if professional and other mounters would attend to the following simple suggestions:—

1. Slides should never be covered with paper; it is without use, and fails as an ornament; and opaque glass slips should be entirely avoided.

2. The ring of cement should not be made of greater width than is necessary for security.

3. A stop of paper or varnish should never be placed behind an object.

Let every opaque mount be also a transparent one, since it is often most useful to examine an opaque object afterwards by transmitted light. The stop should always be a separate one; this may be a disc on a pin held in the sub-stage, or, what is still simpler, a piece of moderately thick 'cover' glass, cut to the 3×1 inch size, or rather shorter, should have a small disc of Brunswick black put on it centrally on the 'turn-table,'¹ and this may be placed under the slide when the Lieberkühn is to be used. There may be two or three such slips with stops of different sizes; in this way every mount may be examined either with the Lieberkühn or by directly transmitted light, and of course by having a larger stop the same object may be examined by any kind of reflected light. Many a valuable preparation has been spoiled by placing a stop on it which cannot be removed.

4. It would be a most appreciable benefit to the cause of microscopy, as we have already hinted, if a uniform gauge of thickness of slip and diameter of cover-glass were adopted. For the thickness of the slip, the $\frac{1}{30}$ th of an inch would prove most suitable, and for the diameter of the cover-glass $\frac{3}{4}$ of an inch would be most convenient, and if the thickness of the cover-glass were uniformly from '006 to '008 the gain would be still greater. Certainly no mount ought to be finished without the thickness of the cover-glass being marked in diamond point upon it, and a narrow ring of shellac cement should be put round every cover-glass where there is even a probability that a homogeneous lens will be admissible in examining the object mounted.

Very minute cover-glasses—such as those $\frac{3}{16}$ ths of an inch in diameter—are to be wholly condemned. They do not allow the conditions required by modern microscopy, being adverse to the employment of oil-immersion lenses in anything like the most efficient way.

Lieberkühns can be used with objectives as high as $\frac{1}{4}$ of an inch focus of '77 N.A. For higher powers than this a perfectly flat speculum may replace the conical form, being illuminated by a condenser with a stop, and racked up well within its focus. The oblique annular ring of light falls on the flat speculum, and is then reflected on the object.

The light suitable for illumination by Lieberkühn may be either the flat of the lamp flame, reflected by the plane mirror, or the edge of the flame, the rays being rendered parallel by a bull's-eye, and reflected from the plane mirror to the Lieberkühn.

There is one other kind of reflected illumination employed, produced by the **vertical illuminator**, which, although it has been in use for some years, has received an accession of value from the employment of immersion lenses. The earliest device for accomplishing this was invented by Professor H. L. Smith, of Geneva, U.S.A.

The principle of this illuminator is to employ the objective as

¹ Chapter vii.

its own illuminator; which Professor Smith did by means of a speculum. A pencil of light was admitted from a lateral aperture above the objective and then reflected downwards upon the object through the lenses by means of a small silvered speculum placed on one side of its axis.

Messrs. R. and J. Beck, in place of a speculum, employ a disc of cover-glass. The cover-glass is mounted on a pin, B, fig. 284, in order that it may be rotated, and oblique light obtained by the milled head, *f*, A, fig. 284.

Powell and Lealand's method is to fix a piece of glass, *worked flat*, at an angle of 45° to the optic axis, with a rotating diaphragm in front of the aperture admitting the light.

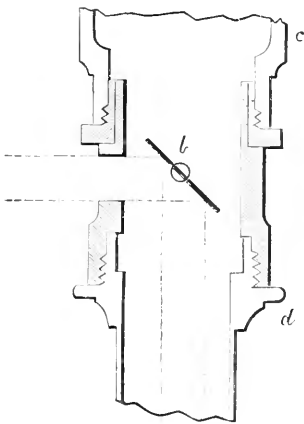

FIG. 283.

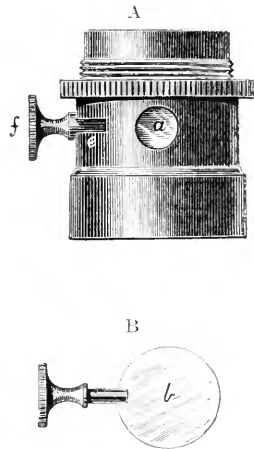

FIG. 284.

To use these instruments the edge of the lamp flame should be placed in front of the reflector, so that the rays may be reflected on to the back lens of the objective in a line parallel to the optic axis. The distance from the lamp to the reflector must exactly equal the distance from the reflector to the diaphragm of the eye-piece in a positive eye-piece, or the eye-lens of a negative eye-piece, otherwise the rays will not be focussed on the object.

This illumination is only suitable for objects mounted dry on the cover, and with immersion lenses. No good result was ever obtained until the immersion lenses were brought into use, but it is now largely used in the examination of metals. The microscope adapted to its employment is shown in fig. 207.

Of all the light which is caused to pass out of the front lens of the objective, through the oil and into the cover-glass, that which has an obliquity less than the critical angle for glass (41°) passes through the cover and object and is lost; but all the light which is of *greater* obliquity than the critical angle for glass is totally reflected

from the *under surface of the cover-glass*, and comes back through the oil and the objective to the eye-piece and the eye; they are, in fact, all optically continuous, so that the upper surface of the cover-glass has ceased to exist optically, the only reflexion being from its inner surface. It is here, therefore, that the oil-immersion system gives a new value to this illuminator, by this means enabling it to utilise a larger aperture otherwise unavailing.

When this illumination is employed, if the eye-piece be removed and the back of the objective be examined, it will be seen that all that portion of the back of the objective whose aperture exceeds 1.0 is brilliantly illuminated. This annulus represents, and is produced by, the excess of aperture beyond the equivalent air angle of 180° , of which it is also a measure. The internal dark space is of the exact diameter of that of a dry objective of the same focus, and is the maximum space which it can itself utilise on a dry object by transmitted light.

By means of this instrument carefully used, some difficult tests and lined objects have been resolved; but its principal use at the present day is for the examination of metals, and it is eminently serviceable in determining whether any dry-mounted object is in optical contact with the cover-glass or not. If it be not so it is invisible with the vertical illuminator. So also it is instructive to examine the backs of objectives of various apertures with this mode of illumination. A dry objective will be wholly without the bright annulus, while an immersion of 1.1 N.A. will have a narrow annulus, and that of 1.4 or 1.5 a broad and still broader one. In this way, by practice, a fair approximation to the aperture of an objective may be obtained.

It is not the *absolute* size of the annulus, but the relation of the size of the annulus to that of the whole back, that must be estimated. Thus $\frac{1}{8}$ th of N.A. 1.2 will have as broad an annulus as $\frac{1}{12}$ th of 1.4 N.A., but the diameter of the back of the $\frac{1}{8}$ th is, of course, much larger than that of the $\frac{1}{12}$ th, and this involves the necessity for a relative comparison.

Appliances for the Practical Study of Living and other Objects with the Microscope. — *Stage-forceps and Vice.* — For bringing under the object-glass in different positions such small opaque objects as can be conveniently held in a pair of forceps, the *stage-forceps* (fig. 285) supplied with most microscopes provide a ready means. These are mounted by means of a joint upon a pin which fits into a hole either in the corner of the stage itself or in the object-platform: the object is inserted by pressing the pin that projects from one of the blades, whereby it is separated from the other; and the blades close again by their own elasticity, so as to retain the object when the pressure is withdrawn. By sliding the wire stem which bears the forceps through its socket, and by moving that socket vertically upon its joint, and the joint horizontally upon the pin, the object may be brought into the field precisely in the position required; and it may be turned round and round, so that all sides of it may be examined, by simply giving a twisting movement to the wire stem. The other extremity of the stem often bears a small

brass box filled with cork, and perforated with holes in its side, seen in fig. 286; this affords a secure hold to common pins, to the heads of which small objects can be attached by gum, or to which discs of card, &c., may be attached, whereon objects are mounted for being viewed with the Lieberkühn. This method of mounting was formerly much in vogue, but has been less employed of late, since the Lieberkühn has unfortunately fallen into comparative disuse. The forceps in fig. 287 are also often of great practical value, and are adjusted for holding by a screw. That which is known as the *stage-vice*, for the

purpose of holding small hard bodies, such as minerals, apt to be jerked out by the angular motion of the blades of the forceps, or very delicate substances that will not bear rough compression, is very useful, and is seen in fig. 288. The stage-vice fits into a plate, as is the case with Beck's disc-holder, fig. 289, or it may simply drop into a stage fitting, as in the figure.

For the examination of objects which cannot be conveniently held in the stage-forceps, but which can be temporarily or permanently attached to discs, no means is comparable to the *disc-holder* of Mr. R. Beck (fig. 289) in regard to the facility it affords for presenting them in every variety of position. The object being attached by gum (having a small quantity of glycerine mixed with it) or by

gold size to the surface of a small blackened metallic disc, this is fitted by a short stem projecting from its under surface into a cylindrical holder; and the holder carrying the disc can be made to rotate around a vertical axis by turning the milled head on the right, which acts on it by means of a small chain that works through the horizontal tubular stem; whilst it can be made to incline to one side or to the other, until its plane becomes vertical, by turning the whole movement on the horizontal axis of its cylindrical



FIG. 285.—Stage-forceps.



FIG. 286.—Stage-forceps.



FIG. 287.

Three-pronged forceps, screw adjustment.



FIG. 288.—The stage-vice.

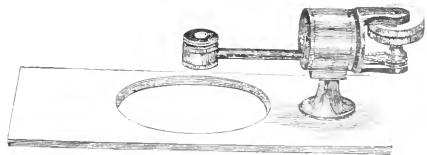

FIG. 289.—Beck's disc-holder.

socket.¹ The supporting plate being perforated by a large aperture, the object may be illuminated by the Lieberkühm if desired. The discs are inserted into the holder, or are removed from it, by a pair of forceps constructed for the purpose; and they may be safely put away by inserting their stems into a plate perforated with holes. Several such plates, with intervening guards to prevent them from coming into too close apposition, may be packed into a small box. To the value of this little piece of apparatus the Author can bear the strongest testimony from his own experience, having found his study of the *Foraminifera* greatly facilitated by it.

Glass Stage-plate.—Every microscope should be furnished with a piece of plate glass, about $3\frac{1}{2}$ in. by 2 in., to one margin of which a narrow strip of glass is cemented, so as to form a ledge. This is extremely useful, both for laying objects upon (the ledge preventing them—together with their covers, if used—from sliding down when the microscope is inclined), and for preserving the stage from injury by the spilling of sea-water or other saline or corrosive liquids when such are in use. Such a plate not only serves for the examination of transparent, but also of opaque objects: for if the condensing lens is so adjusted as to throw a side light upon an object laid upon it, either the diaphragm plate or a slip of black paper will afford a dark background; whilst objects mounted on the small black discs suitable to the Lieberkühm may conveniently rest on it, instead of being held in the stage-forceps.

Growing Slides and Stages.—A number of contrivances have been devised of late years for the purpose of watching the life histories of

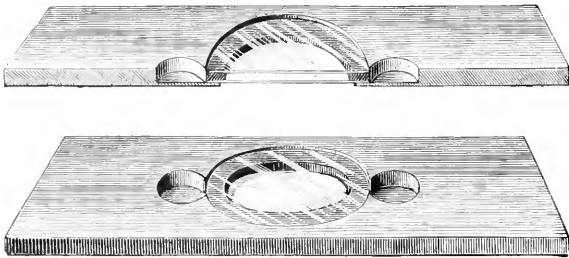

FIG. 290.

minute aquatic organisms, and of 'cultivating' such as develop and multiply themselves in particular fluids. One of the simplest and most effective, that of Mr. Botterill, represented in fig. 290, consists of a slip of ebonite, three inches by one, with a central aperture of three-fourths of an inch at its under side; this aperture is reduced by a projecting shoulder, whereon is cemented a disc of thin glass, which thus forms the bottom of a cell hollowed in the thickness of the ebonite slide. On each side of this central cell a small lateral cell communicating with it, and about a fourth of an inch in diameter, is drilled out to the same depth; this serves for the reception of a supply

¹ A small pair of forceps adapted to take up minute objects may be fitted into the cylindrical holder in place of a disc.

of water or other fluid, which is imparted, as required, to the central 'growing' cell, which is completed by placing a thin glass cover over the objects introduced into it, with the interposition of a ring of thin paper, or (if a greater thickness be required) of a ring of cardboard or vulcanite. If the fluid be introduced into one of the lateral cells, and be drawn off from the others—either by the use, from time to time, of a small glass syringe, to be hereafter described, or by threads so arranged as to produce a continuous drip *into* one and *from* the other—a constantly renewed supply is furnished to the central cell, which it enters on one side and leaves on the other, by capillary attraction.

Dr. Lewis's and Dr. Maddox's growing slides are shown in figs. 291 and 292. Two semicircles of asphaltic varnish are brushed on the slide, one being rather larger than the other, so that the ends of one half-circle may overlap the other, but not

so closely as not to permit the entrance and exit of air. When nearly dry a minute quantity of growing fluid is placed in the centre, upon which a few spores are sown, a cover-glass

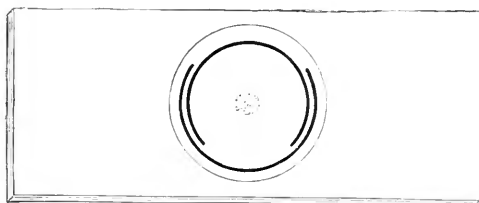

FIG. 291.

being placed over it, which adheres to the semi-dried varnish. The slide should be placed under a bell-glass, kept damp by being lined with moist blotting-paper.

Dr. Maddox's growing slide will be understood from the annexed sketch, fig. 292. The shaded parts are pieces of tinfoil fastened with shellac glue to a glass slide. The minute fungi or spores to be grown are placed on a glass cover large enough to cover the tinfoil, with a droplet of the fluid required. This, after examination to see that no extraneous matter is introduced, is placed over the tinfoil, and the edges fastened with wax softened with oil, leaving free the spaces, X X, for entrance of air. Growing slides of this description could be made cheaply with thin glass instead of tinfoil.

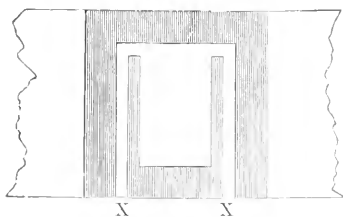

FIG. 292.--Maddox's growing stage.

Dallinger and Drysdale's Moist Stage for Continuous Observations.—It is useful in working out the life histories of minute forms to be able to keep the organisms in a normal and undisturbed condition for sometimes weeks at a time; only a small drop of fluid containing the organism can be under observation, and this, without proper provision, is constantly evaporating. To prevent this, and still to employ very high powers in prolonged study of a given organism, is the object of this device. It consists of

a plain glass stage, fig. 293, *a, a*, so fitted as to slide on in the place of the ordinary sliding stage of a Powell and Lealand or Ross stand. It is thus susceptible of the mechanical motions common to those stages. Its foundation, fig. 293, *a, a*, is plate glass, about the tenth of an inch thick, in order to give it firmness. But this is too thick to work through with a condenser and high powers, and therefore a

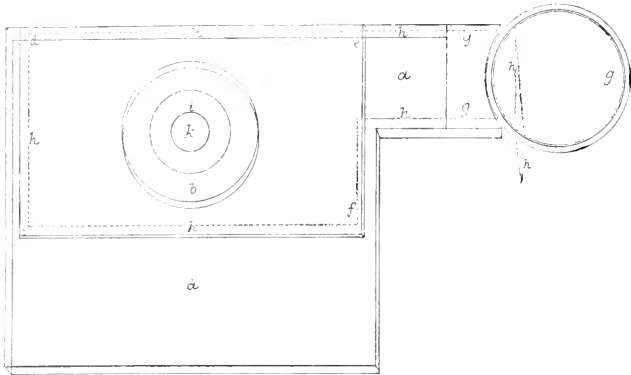

FIG. 293.—Dallinger and Drysdale's moist continuous growing stage.

circular aperture, *b*, is cut through it, and a thin piece of good glass, *c, d, e, f*, is fixed over the under surface of it with Canada balsam; this may be as thin as the condenser may require. At the end of the arm *a*, which extends some distance beyond the stage to the right of the reader, but, when the arrangement is set up on the microscope, to the left of the operator, a brass socket with a ring attached is fixed with marine glue. It is marked in the drawing *g, g, g*. The object of this ring is to hold a glass vessel, fig. 294, about $1\frac{3}{4}$ or 2 inches deep. It simply drops in, and the top, *a*, being slightly larger than the ring, *g*, fig. 293, it is prevented from slipping through.



FIG. 294.

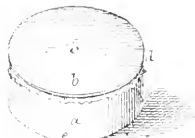

FIG. 295.

Let us suppose the stage to be in its position on the microscope, and the vessel, fig. 294, inserted in this manner into *g*, fig. 293. A piece of good new linen is now cut to the shape drawn in fig. 297, the part *a* being long enough to reach to the end of the glass stage, and then at *b* bent over, leaving the part in the vessel, fig. 294, which is inserted into *g*, fig. 293. Its position is indicated in fig. 293 by the dotted lines, *h, h, h*, &c. But before it is laid upon the stage a circular aperture, *d*, fig. 297, is cut out, which must be much larger in diameter than the covering glass which it is intended to use. We therefore employ small covers.

The glass with the flap of linen in it is now filled with water, and the linen is wetted and wrung so as not to drip, and the whole is very soon, by capillary action, constantly and evenly wet. A drop of the fluid to be examined must now be placed at *k*, fig. 293, and the covering glass, *l*, must be laid on. It will be seen that there is a broad, clear space between the covering glass and the linen. We now want to form a chamber into which the object-glass can be inserted, and which shall enclose a portion of the constantly wet linen, and be to a very large extent air-tight. The consequence will be that the evaporation within the chamber will be always greater in quantity from the linen, on account of its continual renewal, than it can be from the film of fluid.

Indeed, the moisture in the chamber is so great under favourable circumstances that it rather increases than allows a diminution of the film of fluid. The manner in which we effect this is simple. A piece of glass tubing, about $1\frac{1}{2}$ inch in diameter, is cut to about $\frac{3}{4}$ of an inch in length. At one end of this a piece of thin sheet caoutchouc is firmly stretched, and a small hole is made in its centre. Fig. 295 gives a drawing of it; *a* is the piece of glass tubing, *b* is the stretched elastic film, which is

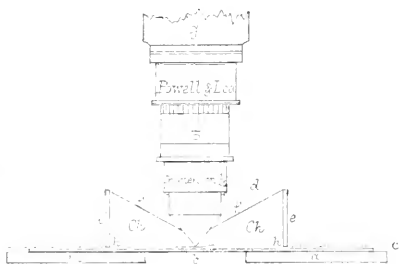

FIG. 296.

securely tied on by means of a groove in the glass at *d*, and *c* is the aperture. The bottom edge, *e*, should be carefully ground. This is laid in the position in which it is looked at in the drawing, on the linen of the stage, the aperture *c* being over the centre of the covering glass. The object-glass is now racked down *through the small hole, c* (fig. 295), and adjusted to focus. The caoutchouc should be thin enough to afford no impediment to the action of the fine adjustment, when it will be seen that it clasps the object-glass by its elasticity at the aperture; and the gentle pressure forces the under edge of the chamber upon the linen, so that little or no air is admitted, while if the under edge of the chamber be carefully ground it will suffer the stage, linen and all, to move under it when the milled heads for working the mechanical stage are in action.

A drawing of the apparatus in working order is given in perpendicular section at fig. 296. The parts *a, a* in this figure represent the glass stage corresponding to *a, a*, fig. 293; *b* in both figures stands for the round aperture in the thick glass; *b*, in fig. 296, corresponds to the thin glass which covers this aperture, marked *c, d, e, f* in fig. 293; but in the form of this device now used by the Editor the thin glass floor is cemented to the *bottom* of the plate glass, *a, a*, thus making a cell equal to the thickness of the whole stage. The linen is marked in dotted lines in both figures; *d*, fig. 296, represents the covering glass, *l*, in fig. 293; *e, e*, fig. 296, is the piece of glass tubing shown in fig. 295; *f, f*, fig. 296, is the

stretched caoutchouc seen at *b* in fig. 295, with the object-glass *g*, penetrating and tightly filling up the aperture *c* in the figure, thus forming the moist chamber; *ch, ch*, by enclosing parts *h, h*, fig. 296, of the linen, which from the glass vessel to the left of the stage is by capillarity always renewing its moisture; and with *b*, fig. 296, sunk as a cell, by the attachment of the thin glass floor to the under side of the stage, as described above, this annular flap of linen overhangs, but does not lie upon, the floor on which the drop of fluid with its living inhabitants is placed. This is a great security against accidental flooding.

It will be seen that the microscope must be vertical; but there is no inconvenience arising from this if it be placed on a sufficiently low support, and it will be found in practice that it may be worked for a long time without any other change in the arrangement than the screwing up or down of the fine adjustment. The difficulties in working are few, and can be best discovered and overcome in practice.

Dr. Dallinger's Thermo-static Stage for Continuous Observations at High Temperatures.—It frequently happens that, either for the pur-

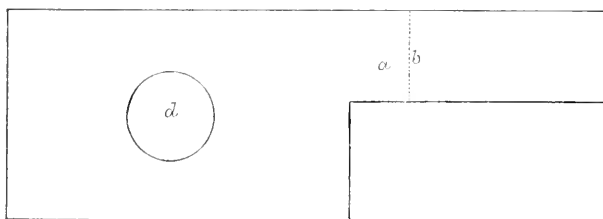

FIG. 297.

pose of experiment or the study of special organisms, the student needs a similar continuous stage to the above, but one in which varying temperatures may be obtained and kept at any point static at the will of the operator. This is very satisfactorily accomplished by the following device: The stage was made as described above, but it was made hollow and water-tight. The whole stage is seen in perspective in fig. 298. At A, *a b* are two grooved pieces of solid metal which permit the stage to slide on to the stage of an ordinary microscope, and partake of the mechanical movements effected by the milled heads; B is a vessel for water with a thermometer *a* of sufficient delicacy for indicating the temperature; *b* is a mercurial regulator, carefully made, but of the usual pattern; *c* brings the gas from the main; *d* conveys as much of the gas as is allowed to escape from between the top of the mercury and the bottom of the gas delivery tube to the burner *e*. The regulation of this apparatus so as to obtain a static temperature, as is well known, is a matter of detail depending chiefly on the careful use of the mercurial screw-plug *f* and the height and intensity of the burner *e*. A temperature quite as accurate as is needed for the purpose required can be obtained.

The stage A is placed in position on the instrument, and two openings in this hollow stage at *c d* (A) are connected with two similar openings in the water vessel, viz. *g h* (B). The whole is carefully filled with water and raised to the required temperature and regulated.

The manner in which it accomplishes the end desired is as follows : On the centre of the stage (A) will be seen a small cylinder of glass; this is ground at the end placed on the stage, and covered with a sort of drumhead of indiarubber at the upper end. By examining C with a lens it will be seen that a cell is countersunk into the upper plate of the hollow stage at *e''*, and a thin plate of glass is cemented on to this. At *e* another disc of glass is cemented water-tight, so that a film of warm water circulates between the upper and

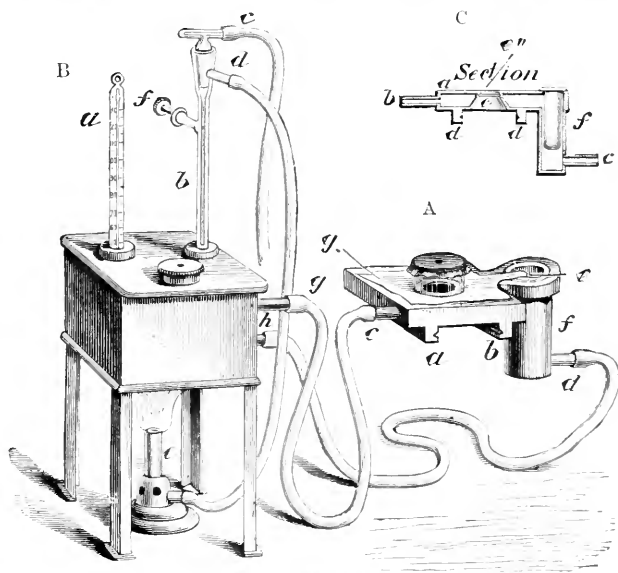

FIG. 298.

under surfaces of this glass aperture. A glass cup is placed in the jacketed receptacle *f* (A and C), and this also is filled with water. A piece of linen is now laid on the stage (A, *g*) with an aperture cut in its centre slightly less than the countersunk cell in which the glass disc *e''* is fixed, and a flap from it is allowed to fall over into the glass vessel *f* (A and C). Thus by capillarity the water is carried constantly over the entire face of the linen. But the glass cylinder seen in A is made of a much larger aperture than the cell and the opening in the linen, and consequently a large annulus of the linen is enclosed within the cylinder. The drop of fluid to be examined is placed on the small circular glass plate, and covered with the thinnest glass, the drum-head cylinder is placed in position, the point of a high-power lens is gently forced upon the top of the indiarubber through a small

aperture, thus forcing the lower ground surface of the cylinder upon the linen, and making the space within the closed cylinder practically air-tight, but still admitting of capillary action in the linen. Thus the enclosed air becomes saturated.

By complete circulation the water in the vessel *e* (A) is but slightly below that within the jacket of the stage, and thus the vapour as well as the stage is near the same thermal point.

For the admission of illumination and for allowing the use of various illuminating apparatus, a large bevelled aperture *e* (C) is made between the lower and upper plates of the stage jacket, which is found to supply all the accommodation needed.

There are many other forms of hot stage having various special purposes, and some of general application; a good account of these will be found in the 'Journal Roy. Micro. Soc.' vol. vii. ser. ii. pp. 299-316 and in subsequent volumes.

The Live-box and Compressors.—What is now so well known even to the tyro as the 'live-box' was originally devised by Tully, and it was afterwards improved by Varley, who, in the place of a level disc of glass for the floor, as well as the top of the 'box,' bevelled a piece of thick glass and burnished it into the top of the tube, where it formed the floor of this 'animalcule cage;' this prevented the draining off of the water at the edge by capillary



FIG. 299.

attraction. But in that form a condenser cannot be used successfully with it, and therefore a dark ground cannot be employed. But as it is Rotifera and Infusoria generally that constitute the *raison d'être* for this piece of apparatus, and as a dark ground gives results of high value—to say nothing of their beauty—with these forms, it lost much of its value.

Mr. Rousselet has overcome these difficulties by a device which is shown in fig. 299.

In this the glass plate bevelled for the floor is somewhat reduced in diameter, but the outer ring is enlarged sufficiently to allow any high power to focus to the very edge of this glass floor. An object lying anywhere over the floor can be reached by the condenser from below, and by both high and low powers from above, and when well made it acts admirably as a compressor. A drop of water so small that a rotifer may be unable to swim out of the field of view of a $\frac{1}{4}$ -inch objective can be readily arranged with it; and a little practice enables the operator to employ it for many useful purposes in the study of 'pond life.'

The compressor or compressorium is a more elaborate device, somewhat of the same kind, but arranged to give the operator more accurate control over the amount of pressure to which the object is subjected. Mr. Rousselet has constructed one of very

efficient form; we illustrate it in fig. 300, but on a reduced scale. The bevelled glass in this also is kept small, with respect to the size of the cover-glass, and it acts with perfectly parallel pressure between the two glasses, which in delicate work is of considerable importance.

The cover-glass is held on an arm which screws down on a vertical post against a spring; as the screw is raised the spring raises the cover-glass, and by an ingenious spring catch it is kept central with the glass-plate floor. This can nevertheless be released, and the entire cover can be turned aside to put on a fresh object, clean, and so forth. It is simple, light, and, being parallel, can be used with the highest powers.

Messrs. Beck and Co. have for many years made an admirable parallel compressor, but its weight and cost were somewhat prohibitive of its use generally; the firm have now overcome both difficulties by the introduction of a new form which is most useful and fully accomplishes its work.

This compressor was designed by Mr. H. R. Davis, and is specially intended for the examination of living objects. It consists, as shown in fig. 301, of a lower ebonite plate A, which has a circular hole in the centre, and which is recessed to receive a circular brass ring B. This ring rests loosely in the recess. On the recessed portion of this plate A is carried an oblong thin glass which is held in position by two screws, one of which appears at C. Two end plates D D slide on to the plate A, and hold the ring B loosely in position, allowing it to be revolved by means of its milled flange, which projects at E. Within the ring B is screwed a brass disc F which carries the upper thin glass which is attached by the screws



FIG. 300.—Rousselet's compressor.

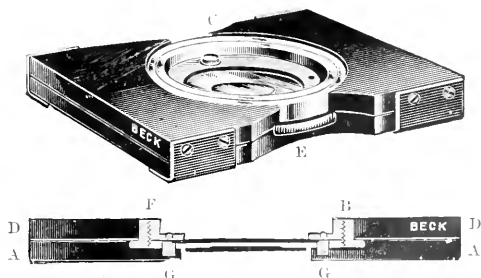

FIG. 301.—Beck's new compressor.

GG. The screws GG and C, fitting into holes in the lower plate A and the disc F respectively, prevent the disc from revolving, and when the ring E is turned, the two thin glasses are moved towards or away from one another.

The slides DD and the ring B, together with the disc F, are removed for arranging the object on the lower cover-glass, and

when replaced by revolving the ring at E, any desired amount of compression may be obtained. The object having been arranged, either side may be examined with equal facility, as the compressor is reversible.

When a very small object is to be examined a small circular cover-glass should be cemented with Canada balsam to the lower cover-glass, and the object is thus confined to the centre of the field.

The zoöphyte trough is a larger live-box differently constructed. The form that has proved one of the best up to our own day was introduced by Mr. Lister in 1834, and is well known. It is depicted in fig. 302, being formed of slips of glass, and has a loose horizontal plate of glass equal to the inside length of the trough, so that it may be moved freely within it, also a slip of glass that will lie on the bottom and fill it, with the exception of the thickness of this loose plate. To use it, the slip is put upon the bottom, the loose plate is placed in front of it with its bottom edge touching the inside of the front glass, a small ivory wedge is inserted between the front glass of the trough and the upper part of the loose vertical

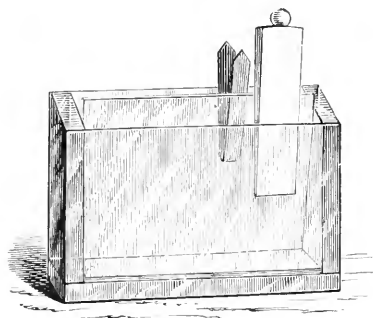

FIG. 302.

plate, which it serves to press backwards; but this pressure is kept in check by a small strip of bent whalebone,¹ which is placed between the vertical plate and the back glass of the trough. By moving the ivory wedge up and down, the amount of space left between the upper part of the vertical plate and the front glass of the trough can be precisely regulated, and as their lower margins are always in close apposition, it is evi-

dent the one will incline to the other with a constant diminution of the distance between them from above downwards. An object dropped into this space will descend until it rests between the two surfaces of glass, and it can be placed in a position of great convenience for observation.

By very little contrivance these troughs with their contents may be kept, when not under examination, in much larger aquaria, obtaining the advantage of aëration and coolness.

Mr. Botterill devised a trough which is made of two plates of vulcanite or metal which screw together, and between them are two plates of glass, of the proper size, of any desired thickness, kept apart by half a ring of vulcanised indiarubber, the whole being screwed tightly enough together by three milled heads to prevent leakage. But leakage or the fracture of glasses is not uncommon with this otherwise convenient form.

An excellent, though shallow, trough was made by Mr. C. G. Dunning, which we illustrate in fig. 303. The lower plate or trough

¹ Watch-spring or other elastic metal should not be used, on account of oxidation.

proper is made of metal, 3 inches long by $1\frac{1}{2}$ wide and about $\frac{1}{16}$ thick, with an oval or oblong perforation in the centre, and the under side is recessed, as shown in fig. 303, B. In this recess is fixed, by means of Canada balsam or shellac, a piece of stout covering glass, forming the bottom of the cell, the recess being sufficiently deep to prevent the thin glass bottom from coming into actual contact with the stage of the microscope or with the table when it is not in use. Two pieces are provided near the bottom edge of the cell: the cover (fig. 303, C) is formed of a piece of thin brass, rather shorter than the trough, but about the same width; it has an opening formed in it to correspond with that in the trough, and under this opening is cemented a piece of cover-glass. The cover-plate is notched at the two bottom corners, and at the two top corners are formed a couple of projecting ears. In order to use this apparatus it must be laid flat upon the table, and filled quite full of water. The object to be examined is then placed in the cell, and may be properly arranged therein; the cover is then lowered gently down, the two notches at the bottom edges being first placed against the pins; in this way the superfluous water will be driven out, and the whole apparatus may be wiped dry. The capillary attraction, assisted by the weight of the cover, will be found sufficient to prevent any leakage; and the pins at the

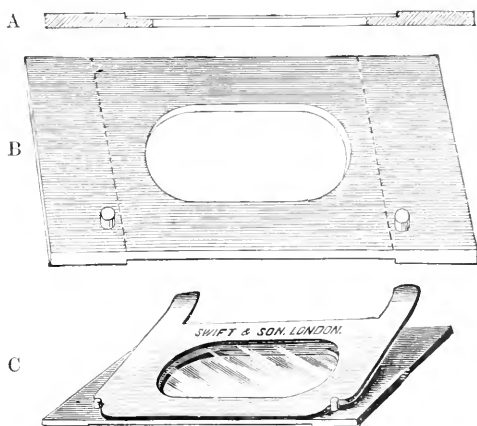

FIG. 303.

bottom prevent the cover from sliding down when the microscope is inclined. This zoöphyte trough possesses two important qualities: first, it does not leak; second, it is not readily broken without gross carelessness. The shallowness may be overcome by placing an ebonite plate with the required aperture between the two mounted glasses.

Infusoria, minute algae, &c., however, can be well seen by placing a drop of the water containing them on an ordinary slide, and laying a thin piece of covering glass on the top; and objects of somewhat greater thickness can be examined by placing a loop or ring of fine cotton thread upon an ordinary slide to keep the covering glass at a small distance from it; and the object to be examined being placed on the slide with a drop of water, the covering glass is gently pressed down till it touches the ring. Still thicker objects may be viewed in the various forms of 'cells' hereafter to be described, and as, when the cells are filled with fluid, their glass covers will adhere by capillary attraction, provided the superfluous

moisture that surrounds their edges be removed by blotting paper, they will remain in place when the microscope is inclined. An *annular cell*, that may be used either as a 'live-box' or as a 'growing slide,' has lately been devised by Mr. Weber (U.S.A.). It is a slip of plate-glass, of the usual size and ordinary thickness, out of which a circular 'cell' of $\frac{3}{4}$ inch diameter is ground, in such a manner that its bottom is *convex* instead of concave, its shallowest part being in the centre and the deepest round the margin. A small drop of the fluid to be examined being placed upon the central convexity (the highest part of which should be almost flush with the general surface of the plate), and the thin glass cover being placed upon it, the drop spreads itself out in a thin film, without finding its way into the deep furrow around it; and thus it holds-on the covering glass by capillary attraction, while the furrow serves as an air-chamber. If the cover be cemented down by a ring of gold size or dammar, so that the evaporation of the fluid is prevented, either animal or vegetable life may thus be maintained for some days, or, if the two should be balanced (as in an aquarium), for some weeks.

Dipping Tubes.—In every operation in which small quantities of liquid, or small objects contained in liquid, have to be dealt with by the microscopist, he will find it a very great convenience to be provided with a set of tubes of the forms represented in fig. 304, but of somewhat larger dimensions. These were formerly designated 'fishing tubes,' the purpose for which they were originally devised having been the fishing out of water fleas, aquatic insect larvæ, the larger animalcules, or other living objects distinguishable either by the unaided eye or by the assistance of a magnifying glass from the vessels that may contain them. But they are equally applicable, of course, to the selection of minute plants; and they may be turned to many other no less useful purposes, some of which will be specified hereafter. When it is desired to secure an object which can be seen either with the eye alone or with a magnifying glass, one of these tubes is passed down into the liquid, its upper orifice having been previously closed by the forefinger, until its lower orifice is immediately above the object; the finger being then removed, the liquid suddenly rises into the tube, probably carrying the object up with it; and if this is seen to be the case, by putting the finger again on the top of the tube, its contents remain in it when the tube is lifted out, and may be deposited on a slip of glass, or on the lower disc of the aquatic box, or, if too copious for either receptacle, may be discharged into a large glass cell. In thus fishing in jars for any but minute objects, it will be generally found convenient to employ the open-mouthed tube C; those with smaller orifices, A, B, being employed for 'fishing' for animalcules, &c., in small bottles or tubes, or for selecting minute objects from the cell into which the water taken up by the tube C has been discharged. It will be found very convenient to have the tops of these last blown into small funnels, which shall be covered with thin sheet indiarubber, or topped with indiarubber nipples, which by compression and expansion can then be regulated with the greatest nicety.

In dealing with minute aquatic objects, and in a great variety of other manipulations, a *small glass syringe* of the pattern represented in fig. 305, and of about double the dimensions, will be found extremely convenient. When this is firmly held between the fore and middle fingers, and the thumb is inserted into the ring at the summit of the piston-rod, such complete command is gained over the piston that its motion may be regulated with the greatest nicety; and thus minute quantities of fluid may be removed or added in the various operations which have to be performed in the preparation and mounting of objects: or any minute object may be selected (by the aid of the simple microscope, if necessary) from amongst a number in the same drop, and transferred to a separate slip. A set of such syringes, with points drawn to different degrees of fineness, and bent to different curvatures, will be found to be among the most useful tools that the working microscopist can have at his command. It will also be found that if a dipping tube with a glass bulb have an indiarubber hollow ball or teat attached to the top of it, it will act, for the majority of purposes, as well as a syringe.

Forceps.—Another instrument so indispensable to the microscopist as to be commonly considered an appendage to the microscope is the forceps for taking up minute objects: many forms of this have been devised, of which one of the most convenient is represented in fig. 306, of something less than the actual size. As the forceps, in marine researches, have continually to be



FIG. 304.—Dipping tubes.



FIG. 305.—Glass syringe.

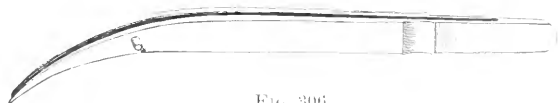

FIG. 306.

plunged into sea-water, it is better that they should be made of brass or of German silver than of steel, since the latter rusts far more readily: and as they are not intended (like dissecting forceps) to take a firm grasp of the object, but merely to hold it, they may be made very light, and their spring portion slender. As it is essential,

however, to their utility that their points should meet accurately, it is well that one of the blades should be furnished with a guide-pin passing through a hole in the other.

Most microscopists have at some time experienced the danger that is imminent to their instruments and mountings when exhibiting delicate objects with high power in mixed assemblies, arising

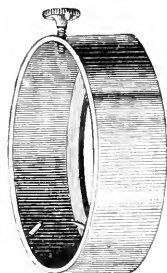

FIG. 307.—Powell and Lealand's protecting ring for coarse adjustment.

from the inadvertency or want of knowledge of some visitor, who may do terrible mischief by innocently using the coarse adjustment. Messrs. Ross made an arrangement by which the coarse adjustment could be 'locked' at a given point; but an equally useful and simpler method was long ago devised by Messrs. Powell and Lealand, who used a deep ring, as is shown in fig. 307. This ring has two pins and a screw projecting inwards. When the screw is withdrawn, the rings can be slipped over the milled heads of the coarse adjustment, and by screwing the small screw 'home' the ring cannot be withdrawn; but as they are loose upon the milled heads, the latter

cannot be brought into action; the rings simply revolve upon the heads without bringing them into play.

Other forms of the same appliance have been made by this firm; and Messrs. Beck have made these rings with slight modifications more recently. They are the most efficient means of counteracting the danger incident on public exhibition of delicate objects under high powers.

The foregoing constitute, it is believed, all the most important pieces of apparatus which can be considered in the light of accessories to the microscope. Those which have been contrived to afford facilities for the preparation and mounting of objects will be described in a future chapter (Chapter VI.).

CHAPTER V

OBJECTIVES, EYE-PIECES, THE APERTOMETER

IT is manifest that everything in the form and construction as well as in the nature of the optical and mechanical accessories of the microscope exists for, and to make more efficient, the special work of the *objective*, or image-forming lens combination, which constitutes the basis of the optical properties of this instrument.

The development of the modern objective, as we have already seen, has been very gradual; but there are definite epochs of very marked and important improvement. Our aim in the study of objectives is practical, not antiquarian, and we may avoid elaborate researches on the subject of *non-achromatic lenses* and *reflecting specula*, which have been sufficiently indicated in the third chapter of this volume. We may also pass over the earlier attempts at achromatism; *the true history of the modern objective begins from the time that its achromatism had been finally worked out.*

The first movement of a definite character towards this object was made, it has been recently shown,¹ so early as 1808 to 1811 by Bernardino Marzoli, who was Curator of the Physical Laboratory of the Lyceum of Brescia. Mr. Mayall discovered a reference to this effort to make achromatic lenses, and, through the courtesy of the President of the Athenæum of Brescia, discovered that Marzoli was an amateur optician, that he had taken deep interest in the application of achromatism to the microscope, and that a paper of his on the subject had been published in the 'Commentarij' for the year 1808, and that he had exhibited his achromatic objectives at Milan in 1811 and obtained the award of a silver medal for their merits under the authority of the Istituto Reale delle Scienze of that city. One of these objectives was found to have been 'religiously preserved,' and was generously presented in 1890 by Messrs. Franini Brothers to the Royal Microscopical Society of London. With it was forwarded the 'Processo Verbale,' or official record of the awards, notifying Marzoli's exhibits and the award of a silver medal, and the actual *diploma*, dated August 20, 1811, signed by the Italian Minister of the Interior.

Marzoli's objective was a cemented combination, having the plane side of the flint presented to the object; and if this was a part of the intended construction, of which there appears small room for doubt, Marzoli preceded Chevalier in this, as we shall subsequently see, very practical improvement.

¹ *Journ. Roy. Mic. Soc.* 1890, p. 420.

It has been, however, customary to accredit the first practicable attempts to achromatise object-glasses to M. Selligues. In 1823 he suggested to M. Chevalier to superimpose two, three, or four achromatised plano-convex 'doublets,' that is to say, pairs of lenses. These objectives had their convex surfaces presented to the object, which gave them four times as much spherical aberration as would have been the case had their positions been reversed,¹ and, as we have just seen, Marzoli reversed them. This necessitated an excessive reduction of the apertures, which, nevertheless, still too manifestly displayed an obtrusive aberration. Yet the conception of an achromatised combination had been embodied in an initial manner. In 1825 M. Chevalier perceived the exact nature of the mistake made by M. Selligues, and made the lenses of less focal length and more achromatic, and inverted them, placing the plane side of the flint towards the object.

It is somewhat important, as it is interesting, to note that the idea of the superposition of a combination of lenses did not originate from theoretical considerations of the optical principles involved. It is scarcely conceivable that where there was manifest ignorance of the position of a plano-convex lens for least spherical aberration (a principle now thoroughly understood) there could have been insight enough either to detect the presence of the two aplanatic foci or to discover a method of balancing them by inductive reasoning. Everything in the history points to happy accident as the primal step in achromatised objectives, and this, with very high probability, applies to the work of Chevalier, for Selligues' attempt was a blunder against the commonplace knowledge of his time.

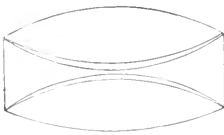

FIG. 308.—Tully's achromatic triple.

The form of three superimposed similar achromatic doublets is precisely the combination of the French 'buttons,' which have been sold in thousands until quite recently, many of them being mounted as English objectives.

At the suggestion of Dr. Goring, Mr. Tully, in this country, without any knowledge of what was being done on the Continent, made an achromatic objective in 1824. This was a single combination, being an achromatic uncemented triplet. It was, in fact, a miniature telescope object-glass, and is illustrated in fig. 308. Two lenses made on this principle by Tully, having f_{10}^4 and f_{10}^2 foci, were found in practice too thick, and in many ways imperfect; and he was induced to make another single triplet of f_{10}^9 focus and 18° aperture, and its performance was said to be nearly equal to that of the f_{10}^2 .

Subsequently a doublet was placed in front of a similar triplet of somewhat shorter focus, forming a double combination objective of 38° aperture. This was pronounced to be a great advance upon all preceding combinations, even those which had been produced upon the Continent.

A note of Lister's at this time upon the objectives of Chevalier

¹ Chapter I.

is of interest. He found them much stopped down, and in one instance he opened the stop and improved the effect. Lister says: 'The French optician knows nothing of the value of aperture, but he has shown us that fine performance is not confined to triple-objectives; and in successfully combining two achromatics he has given an important hint—probably without being himself acquainted with its worth—that I hope will lead to the acquisition of a penetrating¹ power greater than could ever be reached with one alone.'

At this time Professor Amici, of Modena, one of the leading minds who assisted in giving its form to the modern microscope, had been baffled by the difficulties presented by the problem of achromatism, and had laid it aside in favour of the reflecting microscope, but he now returned to the practical reconsideration of the production of an achromatic lens. As a result he appears to have constructed objectives of greater aperture than those of Chevalier. He visited London in 1844, and brought with him a horizontal microscope, the object-glass being composed of three doublets, which produced a most favourable impression.

Meantime, in this country, Mr. Lister brought about an important epoch in the evolution of the achromatic object-glass by the discovery of the two aplanatic foci of a combination. It had occupied his mind for several years, but in January 1830 a very important paper was read to, and published by, the Royal Society, written by him, in which he points out how the aberrations of one doublet may be neutralised by a second.

As the basis of a microscope objective, he considers it eminently desirable that the flint lens shall be plano-concave, and that it shall be joined by a permanent cement to the convex lens.

For an achromatic object-glass so constructed he made the general inference that it will have on one side of it two foci in its axis, for the rays proceeding from which the spherical aberration will be truly corrected at a moderate aperture; that for the space between these two points its spherical aberration will be over-corrected, and beyond them, either way, under-corrected.

Thus, let *a, b*, fig. 309, represent such an object-glass, and be roughly considered as a plano-convex lens, with a curve, *a c b*, running through it, at which the spherical and chromatic errors are corrected which are generated at the two outer surfaces, and let the glass be thus free from aberration for rays, *f, d, e, g*, issuing

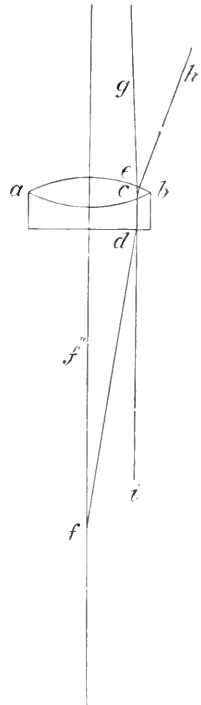

FIG. 309.—The two aplanatic foci of an optical combination.

¹ 'Penetrating' meant 'resolving' power in those days; he alludes, therefore, to increase of aperture.

from the radiant point, f , $h e$ being a normal to the convex surface, and $i d$ to the plane one—under these circumstances the angle of emergence, $g e h$, much exceeds that of incidence, $f d i$, being probably almost three times as great.

If the radiant is now made to approach the glass, so that the course of the ray, $f d e g$, shall be more divergent from the axis, as the angles of incidence and emergence become more nearly equal to each other, the spherical aberration produced by the two will be found to bear a less proportion to the opposing error of the single correcting curve $a c b$; for such a focus, therefore, the rays will be over-corrected. But if f still approaches the glass, the angle of incidence continues to increase with the increasing divergence of the ray, till it will exceed that of emergence, which has in the meanwhile been diminishing, and at length the spherical error produced by them will recover its original proportion to the opposite error of the curve of correction. When f has reached this point f'' (at which the angle of incidence does not exceed that of emergence so much as it had at first come short of it), the rays again pass the glass free from spherical aberration.

If f be carried hence towards the glass, or outwards from its original place, the angle of incidence in the former case, or of emergence in the latter, becomes disproportionately effective, and either way the aberration exceeds the correction.

How far Lister's discoveries were affected by Amici's work it is now quite impossible to say; there can be but little doubt that some influence is due to it, but it is equally clear that a profound knowledge of the optics of that time was the only foundation upon which the facts in Lister's paper could have been built. He was a man of application and an enthusiast, and it was inevitable that he should exert a powerful influence upon the early history of the optics of the microscope. This is the more certain when we remember how few were the men at that time who knew in any practical sense what a microscope was; and we find that in 1831, being unable to find any optician who cared to experiment sufficiently, Lister taught himself the art of lens-grinding, and he made an objective whose front was a meniscus pair, with a triple middle combination, and the back a plano-convex doublet. He declared this to be the best lens of its immediate time, and it had a working distance of 11.

One of the immediate consequences of the publication of Lister's paper was the rapid production by professional opticians of achromatic objectives. The data supplied by Lister proved to be of the highest value in the actual production of these, and the progress of improvement was, in consequence, and in comparison with the time immediately preceding, remarkably rapid.

Andrew Ross began their manufacture in 1831. He was followed by *Hugh Powell* in 1834, and in 1839 by *James Smith*. It is of more than ordinary interest to study in detail the work of this immediate time, and the following table giving a list of objectives, with their foci, apertures, and mode of construction, with the dates of their production, will give a fair idea of the work of *Andrew Ross* in the manufacture of early lenses. He was the earliest of the three

English makers, and undoubtedly carried the palm both here and on the Continent for the excellence of his objectives.

1 inch	14°	two doublets,	1832.	Made for Mr. R. H. Solly.
1	"	18°	single triple,	1833.
$\frac{1}{4}$	"	55°	three pairs,	1834. This belonged to Professor Quekett.
1	"	22°	} triple front and two double backs	} { 1837 to 1841 } , Lister's formula
$\frac{1}{2}$	"	63°		
$\frac{1}{2}$	"	44°		
$\frac{1}{2}$	"	63°		
$\frac{1}{8}$	"	74°		
				} 1842.

Examples of these old lenses are extant and in perfect preservation, and for correction they are comparable without detriment to any ordinary crown and flint glass achromatic of the same aperture of the present day.

An example of the construction of the $\frac{1}{4}$ -inch focus objective of 55°, consisting of three pairs of lenses arranged with their plane sides to the object, the position of least aberration, is shown in fig. 310. The foci of these three pairs are in the proportion of 1 : 2 : 3. In 1837 this maker had so completely corrected the errors of spherical and chromatic aberration that the circumstance of covering an object with a plate of the thinnest glass was found to disturb the corrections; that is to say, the corrections were so relatively perfect that if the combination were adapted to an uncovered object, covering the object with the thinnest glass introduced refractive disturbances that destroyed the high quality of the objective.¹

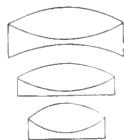

FIG. 310.—A $\frac{1}{4}$ -in. combination by Andrew Ross.

Lister's paper of 1830 gave the obvious clue to a method of neutralising this; that is to say, *by lens distance*; and Ross applied this correction by mounting the front lens of an objective in a tube which slid over another tube carrying the two other pairs. A very primitive form of this lens correction is afforded us by a $\frac{1}{8}$ -inch objective made by Andrew Ross in 1838. It belonged originally to Professor Lindley, the second President of the Royal Microscopical Society, and was presented to the society by his son, the Master of the Rolls, in 1899. An illustration of this lens is given in fig. 311. The tube carrying the front lens slides on an inner tube; it can be clamped in any position by the screws at the sides; the line in the small hole in the front indicates its position, and is the prototype of the 'covered' and 'uncovered' lines of later times.

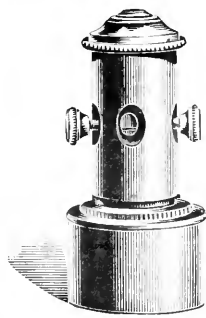

FIG. 311.—Primitive form of lens correction (1838).

The larger cylinder at the base is the lid of its box upon which it is standing.

Subsequently this arrangement was modified by the introduction

¹ Vide Chapter I.

of a screw arrangement, as in fig. 312. The front pair of lenses is fixed into a tube (A) which slides over an interior tube (B) by which the other two pairs are held; and it is drawn up or down by means of a collar (C), which works in a furrow cut in the inner tube, and upon a screw-thread cut in the outer, so that its revolution in the plane to which it is fixed by the one tube gives a vertical movement to the other. In one part of the outer tube an oblong slit is made, as seen at D, into which projects a small tongue from the inner tube; at the side of the former two horizontal lines are engraved, one pointing to the word 'uncovered,' the other to the word 'covered;' whilst the latter is crossed by a horizontal mark, which is brought to coincide with either of the two lines by the rotation of the screw-collar, whereby the outer tube is moved up or down. When the mark has been made to point to the line 'uncovered,' it indicates that the distance of the lenses

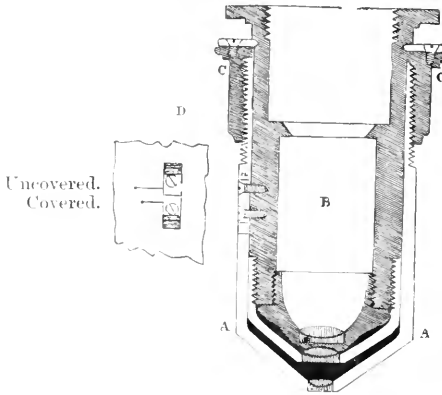

FIG. 312.—Section of adjusting object-glass.

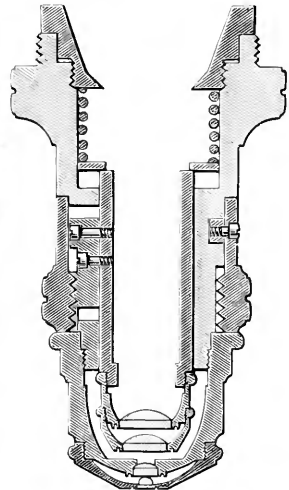

FIG. 313.—Present collar correction.

of the object-glass is such as to make it suitable for viewing an object without any interference from thin glass; when, on the other hand, the mark has been brought, by the revolution of the screw-collar, into coincidence with the line 'covered,' it indicates that the front lens has been brought into such proximity with the other two as to produce an 'under-correction' in the objective, fitted to neutralise the 'over-correction' produced by the interposition of a glass cover of extremest thickness.

This method of collar correction served the purposes of microscopy for upwards of thirty years, but when more critical investigations were undertaken and objectives had more aperture given to them it was found that the method had two great faults.

The first was that the 'covered' and 'uncovered' marks were too crude. To remedy this, the screw collar was graduated into fifty divisions, a device introduced by James Smith in 1841 so that

intervals between the points 'covered' and 'uncovered' might be recorded.

The second, a more serious defect, was the movement of the front lens while the back remained rigid with the body of the microscope. The detriment of this arrangement was that in correcting a wide-angled, close-working objective there was a danger of forcing the front lens through the cover-glass by means of the collar correction.

Now the arrangement as shown in fig. 313 enables the front lens to maintain a fixed position, while the correctional collar acts on the posterior combinations only. This device was introduced by Mr. F. H. Wenham in 1855.

On the Continent it has been the practice to graduate the correctional collar in terms of the thickness of the cover-glass in decimals of a millimetre. Thus if a cover-glass be 0.18 mm. thick, the correctional collar should be set to the division marked 0.18.

In England, on the contrary, the divisions are entirely empirical, so that the operator has to discover for himself the proper adjustment. It is not to be supposed, however, that the English method is unscientific, for when an operator becomes expert he would never for an instant think of adjusting by any other indication than that afforded by his own eye and experience. This is a very important point, because the interpretation of structure to a great extent depends on accurate adjustment of the objective, and it would be folly to suppose that an eminent observer would surrender his judgment to the predetermination of theory embodied in what must be the imperfections in even the most conscientious and thorough work which gives a practical form to such theory. In fact, it is the test of accurate manipulation that, however the collar correction be disturbed, the microscopist will, in getting a critical image of the same object, always, by the quality of the image he obtains, bring the correction to within the merest fraction of the same position, although the correction collar and its divisions are never looked at until the desired image is obtained.

The fact that the over-correction caused by the cover-glass was discovered in England, and that means were at once found for its correction, while no similar steps were taken on the Continent, is a sufficient evidence of the advanced position of this country in practical optics at that time.

This subject of under- and over-correction is one of large importance, and it may be well at this point to enable the tyro to clearly understand, by evidence, its nature, although what it is has been fully shown in Chapter I. Take a single lens—the field-lens of a Huyghenian eye-piece will serve admirably—and hold it a couple of yards from a lamp flame; the rays passing through the peripheral portion of the lens will be found by experiment with a card to be brought to a focus at a point on the axis nearer the lens than those passing through the centre. This is under-correction, vide fig. 23, p. 20. The same experiment should be repeated with the plane side and the convex side of the lens alternately turned to the flame. In the former case, when the image of the flame is at its best focus,

it will be surrounded by a coma, and even the portion of the flame which is in focus will lack brightness. But with the *convex side towards the flame* it will be found that in the image on the card the coma is greatly reduced, and the image of the flame brightened. The reason for this is, as already stated, that the spherical aberration is four times as great when the convex side of the lens is towards the card.

The practice of these simple tests will be most instructive to those unfamiliar with the optical principles on which an objective is constructed. They make plain that an *over-corrected lens is one which brings its peripheral rays to a longer focus than its central, vide fig. 24, p. 20.* But a cover-glass produces over-correction, therefore the means employed to neutralise the error is by the under-correction of the objective. If, however, the objective employed should be unprovided with such means of correction, the eye-piece must be brought nearer the objective, which will effect the same result.¹

Still confining our consideration to the year 1837, we find that a further improvement was made by Lister, who employed a triple front combination. This consisted of two crown plano-convexes with a flint plano-concave between them. The result of this was the increase of the aperture of an inch-focus objective to 22° .

An illustration of the mode of construction of these lenses is given in fig. 314, which is drawn from an early $\frac{1}{8}$ -inch objective by Andrew Ross, having bayonet-catch correction adjustment. In 1842 a $\frac{1}{2}$ -inch of 44° , a $\frac{1}{4}$ -inch of 63° , and a $\frac{3}{8}$ -inch of 74° were made upon the same lines. The method for computing these fronts is given by Mr. Nelson in the 'Journ. R. M. S.,' 1898, p. 160 *et seq.*

In 1841 the Royal Microscopical Society ordered a microscope from each of the before-mentioned leading opticians. The objectives supplied with these are still extant, representing with moral certainty the very best work of the several makers; they are consequently valuable as reliable specimens of the best work of the period.

The objectives supplied by James Smith have the peculiarity of being separating lenses.

The lowest power is about $1\frac{1}{4}$ -inch focus. When this is used alone a diaphragm is slid over the front to limit the aperture, but we are unable to say what that limit was, since the diaphragm has been lost. By placing another front where the diaphragm would have been, the new combination becomes an $\frac{1}{16}$ -inch focus, while yet another front may be substituted, making the objective a $\frac{1}{2}$ -inch focus. This latter front consists of two pairs, and it is provided with a graduated screw-collar adjustment which separates these pairs, but the arrangement is of a very primitive order.

This object-glass will divide the podura marks in a milky field with a full cone, and the field is much curved.

There is also a separating $1\frac{1}{4}$ -inch and $\frac{2}{3}$ -inch which is good while the $\frac{1}{16}$ -inch and the $\frac{1}{4}$ -inch may be considered fair.

The lenses supplied by Andrew Ross are a good 2-inch and a

¹ Under-correction is also known as 'positive aberration;' over-correction as negative aberration.

fair 1-inch, but we have seen a better than this of about the same period.

Hugh Powell supplied a 1-inch of good quality, and a $\frac{1}{2}$, $\frac{1}{4}$, $\frac{1}{8}$, $\frac{1}{16}$ -inch fairly good. The apertures of the $\frac{1}{8}$ and the $\frac{1}{16}$ -inch are of course very low.

On the whole it may be said that the corrections are well balanced in the lower lenses, and the apertures moderate; but when we come to the higher powers it is the deficiency of aperture that becomes so oppressively apparent. In 1844 Amici made a $\frac{1}{2}$ -inch objective of 112° and brought it to England. It was understood that extra dense flint was employed in the construction of this objective; but this is perishable; and Mr. Ross altered slightly the curves of Amici's construction, and with ordinary flint succeeded in extending the aperture of a $\frac{1}{8}$ -inch objective to 85° , or $\cdot 68$ N.A., and a $\frac{1}{2}$ -inch objective to 135° , or $\cdot 93$ N.A. Of this latter it was affirmed that it was 'the largest angular pencil that could be passed through a microscope object-glass.'

In 1850 object-glasses were made with a *triple back combination*; these were attributed to Lister; but it is also affirmed that they

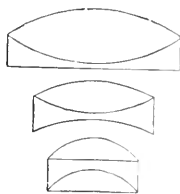

FIG. 314.—An early $\frac{1}{8}$ -in. combination by A. Ross.

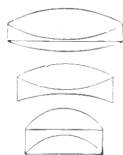

FIG. 315.—A triple-back combination by Lister (or Amici?).

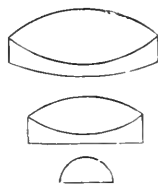

FIG. 316.—A single-front combination by Wenham.

were the previous device of Amici. It may well be a disputed point, for it is quite certain that this device brought the dry achromatic objective potentially to its highest perfection. The combination is illustrated in fig. 315, and under the conditions of its construction it may be well doubted if anything will ever surpass the results obtained by English opticians in achromatic objectives constructed with this triple front, double middle, and triple back combinations, apart from the use of the new kinds of Jena glass. For the method of computing the triple back, *vide* 'Journ. R. M. S.,' 1898, p. 160 *et seq.* It may be noticed that Tully's objective had a triple back, but it was not the result of intended construction; it was a fortunate combination the real value of which was neither understood nor appreciated, and as a consequence its existence was evanescent.

In this same year Wenham produced another modification of the achromatic objective of considerable value, but more to the manufacturer than the user of the microscope. It consisted of a *single front*; the combination is seen in fig. 316, which, it will be seen, is a simpler construction, but this did not affect in the least the price of the objectives produced. Subsequently, however, the form was

adopted on the Continent for low-priced objectives, which led to a reduction of the cost of English objectives of the same construction.

Manifestly, the single front lessened the risk of technical errors, but we have never been able yet to find a single front objective of the old achromatic dry construction which has shown any superiority over a similar one possessing a triple front.

The single front employed with two combinations at the back was the form in which the celebrated *water-immersion objectives* of Powell and Lealand were made. It was by one of these that the striae on *Amphipleura pellucida* were first resolved. Indeed, what is known as the *water-immersion system of objectives*, devised by Professor Amici, was the next advance upon the old form; it should, however, be remembered that as early as 1813 achromatic water-immersion lenses had been suggested by Sir D. Brewster, but it was an advance the optical principles of which were certainly not at the time understood.

In Paris, Prazmowski and Hartnack brought these objectives to great perfection, and were enabled to take the premier place against all competitors at the Exhibition of 1867. The next year, however, Powell and Lealand adopted the system, and in turn they distanced the Paris opticians and produced some of the finest objectives ever made. Their 'New Formula' water-immersions were made after the fine model of Tolles referred to below, and had a duplex front, a double middle, and a triple back. In 1877, when the water-immersion system touched its highest point, apertures as great as 1.23 were reached; and in America, Spencer, Tolles, and Wales produced some extremely fine lenses of large aperture.

During the year 1869 Wenham experimented with and suggested¹ the employment of a *duplex front*; that is to say, a front combination made up of two uncorrected lenses in contradistinction to an achromatised pair. An illustration of the plan suggested is given in fig. 317, which hardly appears to us as a practicable form, and which certainly was never brought to perfection or put into practice.

But in the month of August, 1873, Tolles actually made, on wholly independent lines, a duplex front formula for a $\frac{1}{2}$ glycerine immersion of 110° balsam angle, which passed into the possession of the Army Medical Museum at Washington. There can be little doubt but this objective would have produced a much deeper impression but for the fact that it was in advance of its immediate time.

Tolles, as we have hinted above, used the duplex front in the construction of some of his immersion objectives, and was followed in this by the best English makers, and, in the case of a celebrated $\frac{1}{6}$ -inch purchased by Mr. Crisp, Tolles was able to reach a balsam angle of 96° .

At the time that the water-immersion lenses were being constructed by rival opticians with increasing perfection, the great theory of Professor Abbe concerning microscopic vision, the importance of diffraction spectra, and the relation of aperture to power

¹ *Monthly Micro. Journ.*, Vol. I. p. 172.

was entirely unknown. In the absence of this knowledge wholly mistaken value was attached to *power per se* in the objective.

With a focus as short as the $\frac{1}{2}$ -inch, it was not uncommon to find apertures less than 1.2, while objectives of $\frac{1}{3.5}$, $\frac{1}{4.0}$, $\frac{1}{5.0}$, and even higher powers, were made with extremely reduced apertures. This was done in the interests of the common belief that 'power'—devoid of its suitable concurrent aperture—could do what was so keenly wanted.

This impression, however, was far from universally relied on; there were several earnest workers who, without being able to explain, as Abbe subsequently did, why it was so, still urged the opticians, in the manufacture of every new power, especially the higher ones, to produce the largest possible amount of aperture; and the evidence of this is still to be found in the objectives they then succeeded in obtaining. But there can be no doubt that a reckless desire for magnifying power, all other considerations apart, greatly obtained; and the opticians were able to encourage it, for it is far easier to construct an objective of high power and low aperture than it is to make a low power with a large aperture.

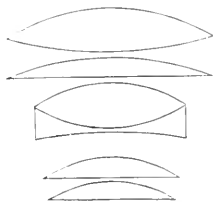

FIG. 317.—A suggested combination by Wenham, 1869.

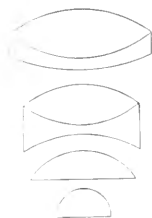

FIG. 318.—Combination for 'homogeneous' immersion by Abbe.

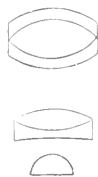

FIG. 319.—Diagram of apochromatic combination.

Thus a $\frac{1}{2}$ -inch of 0.65 N.A. will be far more expensive, and probably not as well corrected, as $\frac{1}{6}$ of 0.7 N.A. The $\frac{1}{2}$ -inch objective, even if a good one, is sure to exhibit spherical aberration, while the $\frac{1}{6}$ of low aperture will show many minute objects with considerable clearness, especially if a comparatively narrow illuminating cone be used.

This difference becomes still more conspicuous as the difference between aperture and power grows relatively greater, until we obtain ultimately an amplification more than useless from its utter inability, on account of deficiency of aperture, to grasp details.¹

Up to 1874, however, there was an entire absence of knowledge, even on the part of the leaders in microscopic theory, art, and practice, as to the real optical principles that enabled us to see a microscopic image, and consequently to understand the essential requirements to be aimed at in the best form of microscope. But in 1877 Abbe's great Diffraction Theory of Microscopic Vision appeared, which has led to changes of incomparable value in the principles of

¹ *Vide* Chapter II.

construction of objectives and eye-pieces, and, as a consequence, has to some considerable extent given a new character to the entire instrument. Its promulgation has indeed inaugurated an entirely new epoch in the construction and use of the microscope.

The general character and the details of Abbe's theory are given in the second chapter of this treatise; but its practical bearing upon the theory and application of the optical part of the instrument was soon manifest; for in 1878 the *homogeneous system of immersion objectives*¹ was introduced as a logical outcome of the diffraction theory of microscopic vision. A formula for a $\frac{1}{8}$ -inch objective on this system was prepared by Abbe, to whom, we learn from himself, it had been suggested by Mr. J. W. Stephenson, of the Royal Microscopical Society.² It has been already shown³ that the homogeneous system was so called because it employed the oil of cedar-wood to unite the front lens of the objective to the cover-glass of the object, in the same way as water had been employed in the ordinary *immersion system*; but as there was a practical identity between the refractive and dispersive indices of the oil and those of the crown glass of the front lens, the rays of light passed through what was essentially a homogeneous substance in their path across from the balsam-mounted object to the front lens, and a *homogeneous system* of objectives took the place of the previous water immersions.

This was the first great step in advance in optical construction and application following the theory of Abbe.

As often happens in matters of this kind, there had been an apparent anticipation of this system of lenses by Amici as far back as 1844; but it is very apparent that Amici employed the oil of amiseed without any clear knowledge of the principles involved in the homogeneous system, being wholly unaware of either the increase of aperture involved or the cause of it. But this cannot be said of Tolles, of New York. We have pointed out that, as early as 1873, he made a $\frac{1}{10}$ -inch, and subsequently, in the same year, a $\frac{1}{8}$ -inch objective, each with a duplex front to work in soft balsam, and with a N.A. of 1.27. These objectives were examined by the late Dr. Woodward, of the Army Medical Department, New York, and with that examination were allowed to drop. For Tolles as an original deviser of a practical homogeneous system this was unfortunate; for the actual introduction of the system in a form capable of universal application, and worked out in all its details in an entirely independent manner, we are wholly indebted to Abbe.

The principle was not, nevertheless, so readily and warmly adopted in England on its first introduction as might have been anticipated. This arose partly, however, from the fact that water immersions had been brought to so high a point of excellence by Messrs. Powell and Lealand that the early homogeneous objectives were not possessed of more aperture, and were not sensibly superior to the best immersions made in England.

The homogeneous objectives were made with duplex fronts and

¹ Chapter II. ² P. 27; also *Journ. Roy. Micro. Soc.* Vol. II. 1879, p. 257.

³ Chapter I.

two double backs. A general diagram of their mode of construction is given in fig. 318.

So long as crown glass was employed in their manufacture, and the anterior front lens was a hemisphere, it appeared that N.A. 1.25 to 1.27 was the aperture limit they could be made to reach. Messrs. Powell and Lealand, however, *by making the anterior front lens greater than a hemisphere*, increased the aperture of a $\frac{1}{2}$ -inch objective to 1.43 N.A.

This front, from being greater than a hemisphere, presented difficulty in mounting; this was at first overcome by cementing its plane surface to a thin piece of glass, which was then fixed in the metal. Eventually, however, this form of construction was changed by these makers in a very ingenious manner; so to speak, they entirely *inverted* the combination, and accomplished the end by *making the front of flint*. By this means they obtained apertures which have not as yet been equalled by any other makers, reaching in a $\frac{1}{6}$, a $\frac{1}{12}$, and a $\frac{1}{20}$ a N.A. of 1.50 out of a theoretically possible aperture of 1.52. Professor Abbe has since, it is true, made an objective with a numerical aperture of 1.63, but this requires the objects to be mounted and studied in a medium of corresponding refractive index, and consequently, in the present state of our knowledge of the subject of media, not applicable to the investigation of ordinary organic structures—certainly not of living things.

These objectives fully occupied the microscopist until 1886, when the most important epoch since the discovery and application of achromatism was inaugurated.

We have already pointed out in detail¹ that it was the great defect of the ordinary crown and flint achromatics that *two colours only could be combined* and that the other colours caused out-of-focus images, which appeared as fringes round the object. This was what was known as *the residuary secondary spectrum*.

In like manner, it has been shown that it was not possible in the flint and crown achromatic to combine two colours in all the zones of the objective, so that if two given colours are combined in the intermediate zone they will not be combined in the peripheral and the central portions of the objective.

These phenomena, it has been pointed out,¹ arise from what is known as the *irrationality of the spectrum*. To correct this we have seen that Drs. Abbe, Schott, and Zeiss directed their attention to the devising of vitreous compounds which should have their dispersive powers proportional to their refractive indices for the various parts of the spectrum. Only by these means could the outstanding errors of achromatism be corrected.

It is therefore a fact that the old flint and crown objectives, whether for the microscope, the telescope, or the photographic camera, are, strictly speaking, neither achromatic nor applanatic.

Glass whose properties far more nearly approximated the theoretical requirement than any previously attainable having been manufactured by the Jena opticians,² Abbe was able to produce objectives entirely cleansed of the *secondary spectrum*. From calcu-

¹ Chapter I.

² Chapter II.

lations of a most elaborate and exhaustive kind made by Dr. Abbe, objectives are made by Zeiss which not only combine three parts of the spectrum instead of two, as formerly, but are also aplanatic for two colours instead of for one. This higher stage of achromatism Abbe has called *apochromatic*.

A general plan of the construction of an apochromatic objective as made by Zeiss is shown in fig. 319, which, it will be understood, is diagrammatic, but sufficiently illustrates the elaborate corrections by which the perfect results given by these objectives are accomplished. But, in addition to their form of construction and the special optical glass of which they are composed, it is now known that they owe much of their high quality to the use of fluorite lenses amongst the combination. Fluorite is a mineral which has lower refractive and dispersive indices than any glass that has yet been composed, and therefore by its introduction the optician can reduce the spherical and chromatic aberrations greatly below that reached by achromatic combinations of the known type.

It is a somewhat depressing fact that fluorite is very difficult to procure in the clear condition needful for the optician, but from what we have seen the optician can do in the manufacture of glass, we may hope that an equivalent of this mineral in all optical qualities may be discovered.

The medium for mounting and immersion contact has, of course, to be of a corresponding refractive and dispersive index in all objectives of great aperture, and it is insisted by Abbe that the glass of which the mount is made, both slip and cover, must, when the limit of refraction by crown glass is passed by the objective, be of flint glass. This he presents as a *sine qua non* in the case of the new objective made a few years since by the house of Zeiss, and a specimen of which has been generously given by the firm to the Royal Microscopical Society. This glass has a numerical aperture of 1.63; in a subsequent chapter on the present state of our knowledge as to the ultimate structure of diatoms we are enabled to present the results of some of the photo-micrographs produced by its means. But it may be noted that very much will depend upon the N.A. of the illuminating cone which can be employed with it—not theoretically, but practically, and it is for practical purposes of no value to the student of minute life, because the highly refractive and dispersive medium needed to make the object mounted homogeneous is destructive of life, and even of organic tissues. Such value as it may have is therefore confined entirely to the examination of silicious and other indestructible organic or inorganic products.

Before leaving this part of our subject we note with pleasure that Mr. Nelson has computed a triplex front of minimum aberration suitable for an oil-immersion condenser. We illustrate it in fig. 320. The data for this are as follows, viz. :—

O is the object and V its virtual image; the hyperhemispherical front is aplanatic for these two points. The scale of the drawing is arranged so that the distance of the vertex A of the front lens to the object O is one inch. The three lenses are made of borosilicate glass, No. 5 in the Jena catalogue, $\mu = 1.51$; and as the reciprocal of

the dispersive power is 64.0, the chromatic aberration of the triplet is very small. Moreover the glass is hard and perfectly safe to use.

Radii : curve A = +.602
 B = ∞
 C = +3.434
 D = +1.280
 E = -15.078
 F = +2.359
 Diameters : lens FE = 2.45
 DC = 2.1
 Distance between surfaces : ED = .05
 CA = .03

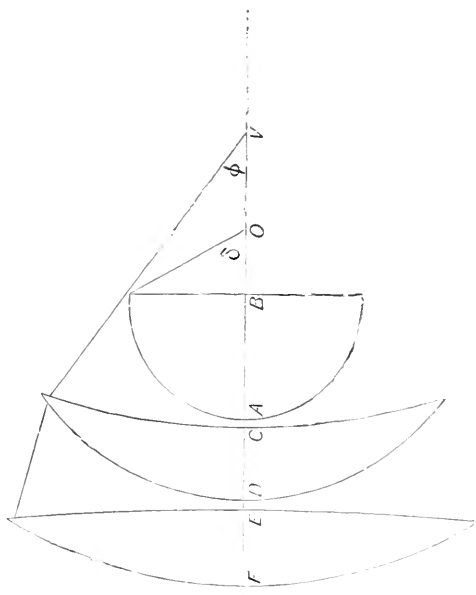

FIG. 320.—Nelson's new immersion front for a condenser.

Thickness AB = .683.

Working distance BO = .317.

Diameter of the plane surface B of front lens = 1.192. AO = 1.0, AV = 1.51.

The angle $\delta = 62^\circ$, and $\phi = 35^\circ 47'$; the numerical aperture of the combination is therefore 1.33 N.A.

The front lens AB is aplanatic; the spherical aberration of the next two DC, FE only amounts to $-.214 \frac{y^2}{F}$. The back correcting

lens, which might be a triplet, will require to have $+ \cdot 214 \frac{y^2}{F}$ of spherical aberration to render the whole combination aplanatic.

On the whole, and for the purposes of practical and prolonged biological investigation, it is to the dry apochromatics that we are most indebted, and from their use we shall derive the largest benefit.

As no subject is really of more importance than a clear understanding of the difference of action of chromatic, achromatic, and apochromatic lenses, we venture to present a diagrammatic illustration, which, while not strictly accurate, will carry with it no error, as a popular illustration of this important subject.

In fig. 321, 1, 2, 3, we have representations, as truly as they can be drawn, of *zones of equal light*; that is to say, the peripheral zone will transmit an amount of light equal to that given either by the intermediate zone or the central circle. Let them therefore be called *equiluculent zones*.

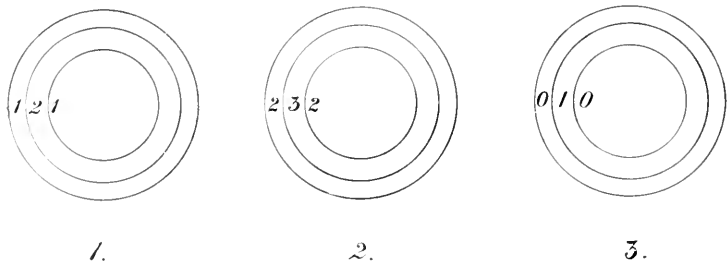

FIG. 321.

If we assign a numerical value for the visual intensity of the whole spectrum, say 100, made up of the following parts, viz. :—

Red	15
Orange-yellow	40
Yellow-green	30
Blue	15

then if in any one of the equiluculent zones the whole spectrum is brought to a focus, we shall have for that zone 100 as its effective value.

But the entire object-glass is divided, as in the diagram, into three equiluculent zones; consequently 300 will represent the value of the whole lens, provided the whole of the spectrum is brought to the same focus.

By referring to the diagrams we see that in a non-achromatic lens (fig. 321, 3) we shall get only 40, because only one part of the spectrum is brought to the focus in its intermediate zone; and as spherical aberration causes the light which passes through the other zones to be brought to *other foci*, they for all practical purposes might be stopped out.

In the achromatic lens we have (fig. 321, 1) in the intermediate zone two parts of the spectrum combined, as $40 + 30 = 70$, and one

in each of the other zones *is also brought to the same focus*, say 30 in the outer zone, and 40 in the centre circle. The result is that the whole achromatic lens gives a total of light, on the principle stated above, of $30+70+40=140$. In the apochromatic system, however (fig. 323, 2), we find in the intermediate zone three parts of the spectrum united; that is to say, $40+30+15=85$; and two in each of the others, say, $40+30=70$. Thus an apochromatic objective will give $70+85+70=225$.

Recalling the suppositions we have made for the purpose of this graphic presentation of a difficult subject, it will be seen that a non-achromatic objective would give 40, an achromatic 140, and an apochromatic 225 out of a possible total of 300.

This illustration might be exceeded in severe accuracy, but scarcely in simplicity, and it sufficiently explains from this point of view alone the vast gain of the apochromatic system.

It is interesting to note that, while the microscope in its earlier form took its powerful position by borrowing achromatism from the telescope, it has now led the way to the apochromatised state, which without doubt it will be the work of the optician, in constructing the telescope of the immediate future, to follow.

We would beg the reader to bear in mind in the purchase of objectives that, whilst the vitreous compounds with which Abbe's beautiful objectives are constructed are now accessible to all opticians, and whilst without these Abbe's objectives could never have been constructed, yet *it does not by any means follow that because an objective is MADE with the Abbe-Schott glass it is therefore apochromatic; the secondary spectrum must be removed, and the spherichromatic aberration balanced, or it is 'apochromatic' only by misnomer.* It is another feature of these objectives, which it is important to note, that they are so constructed that the upper focal points of all the objectives *lie in one plane*. Now as the lower focal points of the eye-pieces are also in one plane, it follows that, whatever eye-piece or whatever objective is used, the optical tube-length will remain the same.

Professor Abbe has found¹ that in the wide-aperture objective of high power there is an outstanding error which there is no means of removing in the objective alone, but, as we have already explained, this is left to be balanced by an over-corrected eye-piece. As this peculiarity pertains only to the higher powers, a corresponding error had to be intentionally introduced into the lower powers in order that the same over-corrected eye-pieces might be available for use with them.

It appears worthy of note in this relation that one of the best forms for the combination of three lenses is that known as Steinheil's formula, which consists of a bi-convex lens encased in two concavo-convex lenses. It will be observed by reference to the figure illustrating the apochromatic lens construction (fig. 319) that this is largely made use of. In some instances the encasing lenses possess sufficient density, with regard to the central bi-convex lens, to altogether overpower it, the result being a bi-convex triple with a negative focus.

¹ Chapter II.

It is another distinctive feature of the 3 mm. objective that it has a *triplex front*; thus Zeiss's 3 mm. ($= \frac{1}{8}$ inch focus) had the errors from three uncorrected lenses balanced by two triple backs, *i.e.* nine lenses taken together, but it has since been constructed on a different formula.

The foci of the set of apochromatic lenses now made by Zeiss are integral divisions of what may be termed a unit lens of 24 mm. : 24 he chooses as a means of avoiding the inconveniences inseparable from the use of the decimal system.¹ The unit lens is therefore a little higher than 1 inch in power. In the series of dry lenses there are two powers of the same aperture. Thus 24 mm. and 16 mm., corresponding to English 1 inch and $\frac{2}{3}$ inch, each has an aperture of $\cdot 3$; a 12 mm. and 8 mm. = English $\frac{1}{2}$ inch and $\frac{1}{3}$ inch, have each an aperture of $\cdot 65$; while a 6 mm. and a 4 mm. = $\frac{1}{4}$ inch and $\frac{1}{6}$ inch, have both an aperture of $\cdot 95$.

There are also water-immersions : a 2.5 mm. = $\frac{1}{10}$ inch, with N.A. 1.25, and two oil-immersions respectively 3 mm. and 2 mm. = $\frac{3}{8}$ inch and $\frac{1}{2}$ inch, both being made either with 1.3 or 1.4 N.A.

Apart from these, intended to be used for photographic purposes without an eye-piece, is a 70 mm. = a 3-inch, also a 35 mm. or $1\frac{1}{2}$ -inch objective.

With the exception of the 6 mm., 4 mm., and 2.5 mm. objectives, which have the screw-collar adjustment, this series have rigid mounts, correction being secured by alteration of the tube-length.

The performance of these lenses, as they are now made, is of the very highest order. They present to the most experienced eye unsurpassed images. They are corrected with a delicate perfection which only this system, coupled with technical execution of the first order, can possibly be made to produce. The optical polish, the centring, the setting, and the brasswork certainly have never been surpassed.

It is a matter also worthy of note that Zeiss's apochromatic series of objectives *are true to their designations as powers*. The $\frac{1}{2}$ -inch is such, and not a $\frac{4}{10}$ -inch designated $\frac{1}{2}$ -inch. This was equally true of the early achromatics. A. Ross produced a $\frac{1}{4}$ -inch under that name. One now before us, made fifty years ago, has an initial power of 41 ; and that of $\frac{1}{2}$ inch has an initial power of 21. But modern achromatics of fair aperture are always greatly in excess of their designated power ; $\frac{2}{3}$ are nearly $\frac{1}{2}$ -inch. A $\frac{1}{2}$ -inch of 40° has an initial power of 25, and is a $\frac{4}{10}$ -inch ; $\frac{4}{10}$ -inch objectives are in reality $\frac{1}{3}$ -inch ; and $\frac{1}{4}$ -inch objectives of 90° and upwards have initial powers of 50 instead of 40, which they should have, so that they are in reality $\frac{1}{5}$ ths ; some in fact—by no means uncommon—have an initial power of 60, and are actually $\frac{1}{6}$ th-inch objectives.

This is explicable enough from the maker's point of view : it is far easier to put *power* into an object-glass *than aperture*. It is

¹ Although the foci of the lenses are expressed in integers, with the single exception of the water-immersion 2.5 mm., there are inconvenient decimal fractions in the initial magnifying power of all the series except those of 2.5 and 2 mm. focus.

easier to make a $\frac{1}{6}$ -inch of 100° than a $\frac{1}{4}$ with 100° ; the result is that low powers with suitably wide apertures are costly.

In the Zeiss apochromatic series of objectives the 24 mm. of $\cdot 3$ N.A. and 12 mm. of $\cdot 65$ N.A. may be considered as lenses of the very highest order; the relation of their aperture to their power is such that everything which a keen and trained eye is capable of taking cognisance of *is resolved when the objective is yielding a magnification equal to twelve times its initial power*; for this purpose an objective must have $0\cdot 26$ N.A. for each hundred diameters of combined magnification. Under these conditions an object is seen in the most perfect manner possible. In this connection Mr. Nelson has suggested¹ that the term 'optical index' should be added to that of the numerical aperture. The optical index or O.I. is the ratio of the numerical aperture ($\times 1000$) to the initial magnifying power. Thus the numerical aperture of the Zeiss apochromatic 24 mm. is $\cdot 3$, and its initial power 10. Then its O.I. is $\frac{300}{10} = 30$. The O.I. of the 12 mm. apochromatic of $\cdot 65$ N.A. is $\frac{650}{21} = 31$. That of the $\frac{1}{8}$ homogeneous immersion of $1\cdot 4$ N.A. is $\frac{1400}{81} = 17$. Compare now these figures with an old water-immersion $\frac{1}{50}$ of $1\cdot 1$ N.A. $\frac{1100}{550} = 2\cdot 0$. The value of these figures will be apparent when we remember that any lens used with a 10 power eye-piece must have an O.I. of 26 to resolve all detail visible to a keen eye.

The optical index therefore tells us that the $\frac{1}{50}$ water-immersion of $1\cdot 1$ N.A. had a vast amount of empty magnifying power, while on the other hand the 24 and 12 mm. will both stand a higher eye-piece than 10; nay, even require it before the detail resolved by them is made visible to the eye. It also shows that the $\frac{1}{8}$ of $1\cdot 4$ N.A. will stand a higher eye-piece without arriving at an empty magnifying power than the $\frac{1}{12}$ of $1\cdot 4$ N.A., whose O.I. is $11\cdot 0$.

As it is more difficult to put aperture into a lens than power, the O.I. becomes also an index of the money value of a lens. Thus the $\frac{1}{4}$ mentioned above that had an initial magnifying power of 60 and N.A. of $\cdot 8$ ought to be a cheaper lens than a true $\frac{1}{4}$ with an initial magnifying power of 40 and a N.A. of $\cdot 9$, their optical indices being 13 and 22 respectively. The limit of combined power for best definition with any objective of any given aperture may be found by multiplying its N.A. by 400. Example: The limit of power for best definition with a $\frac{2}{3}$ of $\cdot 3$ N.A. is 120 diameters. The converse rule may be stated thus: The *ideal* N.A. for any objective whose *initial* power is known can be found by multiplying its power by $\cdot 025$. Example: The ideal N.A. for a $\frac{1}{2}$ of power 20 is $20 \times \cdot 025 = \cdot 5$ N.A.

It may be well for the student to prove this, which may be readily done.

Take a suitable object, such as a well-prepared proboscis of a blow-fly, and examine it under critical illumination with the 24 mm. $\cdot 3$ N.A. (= 1-inch) objective, and a 12 compensating eye-piece. Note with close attention every particular of the image: the resolution of the points of the minute hairs, the form of the edges of the cut suctorial tubes, the extent of the surface taken into the 'field,' and the relation of all the parts to the whole.

¹ *Journ. R. M. S.* 1893, p. 12.

Now change the objective for the 16 mm. $\cdot 3$ N.A. ($= \frac{2}{3}$, but with the same aperture). Nothing more is to be seen; the most dexterous manipulation cannot bring out a single fresh detail; the resolution is in no sense carried farther; the cut suctorial tubes were in fact, in our judgment, better seen with a lower power, while with it all of course a smaller extent of the object occupies the 'field.'

It can in fact be scarcely doubted that the picture presented by the $\frac{2}{3}$ is a distinct retrogression in every sense compared with that presented by the 1-inch when both are equally well made and have equal apertures, viz. $\cdot 3$. But beyond all this, *whatever may be done* by the 16 mm. $\cdot 3$ N.A. can be accomplished in an equally satisfactory manner by removing the 12 eye-piece and replacing it, with practically no other alteration, by an 18 eye-piece; and still higher results can be obtained without the slightest detriment to the image by using an eye-piece of 27.

Not less interesting and convincing will it be to examine the same object with a 12 mm. $\cdot 65$ N.A. ($= \frac{1}{2}$ -inch), and an A Zeiss achromatic of $\cdot 20$ N.A. ($= \frac{2}{3}$ rds inch), using a 12 eye-piece. Those who may still retain some conviction as to the value of 'low-angled glasses to secure penetration' can want no further evidence of its entire fallacy than such a simple experiment affords.

For those who prefer it, a true histological object may be selected. We choose a portion of a frog's bladder treated with nitrate of silver, in which are some convoluted vessels, enclosed in a muscular sheath which had contracted.

This object is presented by photo-micrograph in figs. 7 and 8 of the frontispiece. In fig. 7 the vessel in the frog's bladder is seen by a Zeiss A $\cdot 2$ N.A. magnified 140 diameters. The object of the photograph is to expose the fallacy which underlies the generally accepted statement that low-angled glasses are the most suitable for histological purposes. The assumption is founded on the fact that the penetration of a lens varies inversely as its aperture, and it is taken for granted that 'depth of focus' will be obtained, not to be secured by large apertures, and therefore it is taken for granted that we are enabled to see into the structure of tissues.

In examining the illustration (which will with advantage permit the use of a lens) it will be seen that scarcely an endothelium cell can be clearly seen. A sharp outline is nowhere manifest, because the image of one cell is confused with the outlines of others upon which it is superposed. We have seen that there is no perspective proper in a microscopic image; therefore it is better to use high apertures in objectives, and obtain a clear view of one plane at one time, and train the mind to appreciate perspective by means of focal adjustment.

It will be admitted that no clear idea of what an endothelium cell is can be obtained from fig. 7.

But fig. 8 (frontispiece) represents the same structure slightly less magnified ($\times 138$) by means of an apochromatic $\frac{1}{2}$ N.A. $\cdot 65$. Here only the upper surface of the tube is seen; but the endothelium cells can be clearly traced, and a sharp definition is given to

every cell. The circular elastic tissue is also displayed, while the whole image has an increased sharpness and perfection.

Thus, with the objective (A $\cdot 20$ N.A. = $\frac{2}{3}$ rds inch) of lower aperture, the endothelium cells *can be seen*; but when the image is compared with that of the objective of wider aperture ($\cdot 65$ N.A.), the former image is found to be dim and ill-defined. The muscular sheath is so ill-defined that it would not be noticed at all if it had not been clearly revealed by the objective of wider aperture. But, on the other hand, the objective of greater aperture not only shows the muscular sheath, but it also shows the elongated nuclei of the muscle cells; and at the same time brings out the convoluted vessels lying in the muscular sheath as plainly as if it were an object of sufficient dimensions to lie upon the table appealing to the unaided eye.

We have pointed out in the proper place,¹ that although 'penetrating power' varies inversely as the numerical aperture, it also varies inversely as the *square* of the power.

Now, from what we know of histological teaching in this country, we do not hesitate to say that a histologist would not have attempted to examine the above object with even a Zeiss A objective. He would have advised the use of 'the $\frac{1}{2}$ -inch,' of, perhaps, $\cdot 65$ aperture; but by so doing he would have secured only one-third of the penetrating power *quâ* aperture, and one-seventh of the penetrating power *quâ* power.

It is manifest, then, that pursuing this course in the histological laboratory defeats the end sought, and which it is so desirable to attain.

It is absolutely unwise to use a higher *power* than is needful. A $\frac{1}{2}$ -inch where a $\frac{1}{2}$ -inch would answer involves loss in many ways, and would never be resorted to *if the aperture of the lenses employed were as great as the power used legitimately permitted.*²

A given structure, to be seen at all, must have a given aperture; to obtain this, as objectives now made for laboratory purposes run, they are obliged to use *too high a power*. The result is that in seeking to avoid what is accounted the loss of 'penetrating power' at an inverse ratio to the aperture, it is forgotten that we are losing it inversely as the *square* of the power!

Moreover, the two apochromatic objectives we have already referred to as test lenses are equally able to show the value of apochromatism, not so much on account of the removal of the secondary spectrum as for the reduction of the aberrations dependent on the irrationality of the spectrum in ordinary achromatics.

Use the 12 mm. $\cdot 65$ N.A. objective. Place a diatom in balsam in the focus of it on a dark ground; the diatom will shine with a silvery whiteness, and the image will be wholly free from fog.

Now take one of the best achromatics obtainable of $\frac{1}{2}$ -inch focus of 80° (almost certainly a $\frac{1}{10}$ in power) and examine the same diatom in the same circumstances; it will be bathed in fog. If, however, the achromatic objective is an exceptionally good one, and we reduce its aperture to 60° , we shall get a fair picture of the

¹ Chapter I.

² Chapter II.

diatom—one indeed that was considered critical until that with the apochromatic was seen. But in comparison it is dull and yellowish. From which it follows that an exceptionally fine achromatic $\frac{1}{10}$ -inch of 60° or $\cdot 5$ N.A. will not suffer comparison of the image it yields with that of an apochromatic $\frac{1}{2}$ -inch of $\cdot 65$ N.A.

Speaking generally on the whole question, then, it would be the utmost folly for histologists or opticians to shut their eyes to the magnificent character of the series of dry apochromatics of Zeiss, ranging from 1 inch (24 mm.) to $\frac{1}{6}$ inch (4 mm. $\cdot 95$ N.A.). They are the most perfect and efficient series of objectives ever placed in the hands of the worker; and, unless English lenses on a truly apochromatic principle and equal quality are produced, it must be to the detriment of either the opticians or the workers of this country.

Nor need it be supposed that the production of objectives approximate to these must be *costly*; great steps have been taken lately in the reduction of their cost. The manufacture of the Jena glass has indeed wrought an entire change in the character of objectives now produced; and although the very finest and most costly apochromatics having fluorite used in their construction still hold an unrivalled position, yet the new glass admits of corrections so nearly perfect that some stronger word than achromatic appeared to be needed, and the word semi-apochromatic has crept in and undoubtedly designates a most valuable and far from costly set of lenses of all powers. It is Leitz, of Wetzlar, that has first and efficiently attacked this problem and provided the student whose means are limited with objectives of a very high class, and which come remarkably near to the best apochromatics. We would specially call attention (wholly in the interests of students) to No. 3 ($\frac{3}{4}$ -inch N.A. 0.28) at a cost of 15s. No. 5 is an equally valuable and admirable objective which is a $\frac{1}{4}$ -inch 0.77 N.A., the price of which is 25s., and it comes so near to an apochromatic as to require expert judgment to discover that it is not. He also makes a dry $\frac{1}{12}$ -inch N.A. 0.87 and a dry $\frac{1}{6}$ of $\cdot 82$ N.A. at a cost of 3*l.*, which is a very low price for so good a piece of optical work. Also an oil-immersion $\frac{1}{10}$ -inch N.A. 1.30 is sold for 3*l.* 15s. This glass is corrected for the long tube, and a similar $\frac{1}{12}$ th N.A. 1.30 for 5*l.* resolves secondary diatom structure well, and it is hardly distinguishable from an apochromatic lens; and we can attest, from personal investigation, the value of each of these, which are only selections from a considerable series, all of which we have found to be reliable, and, when examined in numbers, very few indeed are below the standard quality. But such work is so much needed that it is not likely that, with the glass accessible to all, it will remain the peculiarity of one maker; hence we find that Reichert follows Leitz so closely in quality and price that it is not easy to distinguish the semi-apochromats of one maker from the other. Reichert's No. 3 ($\frac{3}{4}$ -inch N.A. 0.30) is 17s., his 7*λ* (an admirable lens) $\frac{1}{4}$ inch N.A. 0.87 is 1*l.* 16s. He makes a high-class oil-immersion $\frac{1}{12}$ -inch N.A. 1.30 for 8*l.* And of apochromatic lenses he makes a $\frac{1}{3}$ -inch N.A. 0.30 and a $\frac{1}{4}$ -inch N.A. 0.95 for 4*l.* each.

which, so far as we have seen them (and we have examined many), are excellent. Reichert's semi-apochromatic $\frac{1}{3}$ -inch is also a fine and useful lens, and his $\frac{1}{2}$ -inch apochromatic N.A. 1.30 has qualities fitting it for use in any kind of research.

But we confess that it is a matter of most pleasant surprise to us to find that the great American firm of Bausch and Lomb are putting upon the English market objectives that fairly compete with the above in the lowness of their price, while their optical quality and mechanical work are of the best order. We have examined these lenses with much pleasure: they are from the computations of Professor Hastings, and, considering the fact that they, in all the higher powers especially, are so low-priced, their corrections and high quality are beyond all praise. We would specially call attention to a $\frac{2}{3}$ -inch, a $\frac{1}{6}$ -inch, and a $\frac{1}{2}$ -inch which we have examined thoroughly and with approval that needs no qualification when it is remembered that the most advanced Continental opticians have not touched a lower price.

Messrs. R. and J. Beck are making good objectives, oil-immersion and other, and one of their $\frac{1}{2}$ oil-immersions is sold at the strikingly low figure of 4*l*.

Messrs. Swift and Son are making a large number of objectives, especially apochromats and semi-apochromats, and they have long striven to supply the student with high-quality lenses at the lowest possible price. There can be no doubt that the whole secret of success in this matter is dependent on a sufficiently large series of experiments to determine on the right kind of glass, so as to produce the highest order of 'semi-apochromatism.'

Messrs. Watson and Sons have commenced the manufacture of a new series of objectives based on original computations. These promise exceedingly well. We have examined the $\frac{1}{2}$ -inch and the $\frac{1}{4}$ -inch. We find that their initial powers are 21 diameters 0.45 N.A., and 40 diameters 0.74 N.A., and they depend for aplanatic results, which are admirable, on a triple back lens. The objectives, we believe, will be valuable as a series when complete. They do not claim to be amongst the very low-priced lenses; but they claim, and we believe they will possess, some of the best qualities which should be aimed at in microscopic object-glasses.

These facts are of importance to the medical student and to opticians generally. By apochromatised and semi-apochromatised objectives of the highest order the work of present and future microscopy will be done—that is inevitable. To thoroughly understand what its very best results, theoretically and practically, must be becomes the imperative aim of the optician who would be abreast of the direct wants of his time; and to produce the nearest to these in objectives and eye-pieces at the lowest possible price is, apart from all other issues, to be a direct benefactor of true science.

The Eye-piece.—The eye-piece, sometimes called the *ocular*, is an optical combination, the purpose of which is so to refract the diverging pencils of rays which form the real object-image that they may all arrive at the pupil of the observer's eye. They have also to form

a virtual image of the real image which is presented to them as the object. For this purpose a combination is indispensable, but this may be varied. There are ordinary and special eye-pieces. Those in ordinary use separate into two divisions: (1) positive eye-pieces and (2) negative eye-pieces. These are easily distinguished; with a *positive* eye-piece we can obtain a *virtual image* of an object by using it as a simple microscope, because its focus is exterior to itself. This cannot be done with the *negative eye-piece*, because its focus is within itself.

The eye-piece in common use is negative, and is generally known as Huyghens's, and sometimes as Campani's. Monconys appears to have been the first (1665) to supply the field-lens to the eye-lens of the microscope, and Hooke in 1665 adopted his suggestion; but how far Monconys was indebted for this to the compound eye-piece attributed to Huyghens cannot now be determined.

This instrument, as commonly used in a telescope, consists of an eye-lens and a field-lens, each being plano-convex, having their convex sides towards the object, their foci being in the ratio of

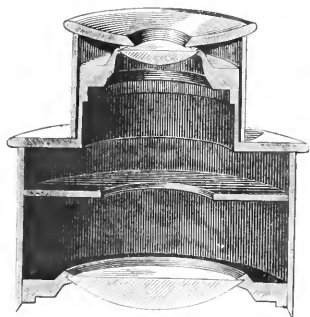

FIG. 322.—Huyghenian eye-piece.

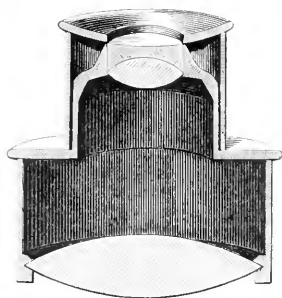

FIG. 323.—Kellner eye-piece.

3 : 1, and the distance between them being equal to half the sum of their focal lengths, a diaphragm being placed in the focus of the eye-lens. In a microscope a different ratio and lens distance is employed, the fact being that different tube lengths require different formulæ. The general form of a Huyghenian eye-piece is shown in longitudinal section in fig. 322. This makes a very convenient form of eye-piece of 5 and 10 magnifying power; but when the power much exceeds this last amount the eye-lens becomes of deep curvature and short focus, so that the eye must be placed uncomfortably near the eye-lens. This, however, is its chief defect, and it may fairly be considered the best ordinary eye-piece.

Another negative eye-piece is that known as the *Kellner*, or *orthoscopic*. This consists of a bi-convex field-glass, and an achromatic doublet meniscus (bi-convex and bi-concave) eye-lens. A vertical section of one so constructed is seen in fig. 323. These eye-pieces usually magnify ten times, and the advantage they are supposed to give consists in a large field of view; but they are not good in practice for this very reason; they take in a field of view greater than the

objective can stand, and as a rule even the centre of the field will not bear comparison in sharpness with the Huyghenian form.

Mr. Nelson has recently computed and had made a Huyghenian eye-piece on a wholly new formula¹ which has the field reduced by about 7 inches, yet we can testify that in use it gives exceedingly sharp images, and what surprises the accustomed worker is that it acts admirably in the place of 'compensated' eye-pieces, giving results that often not only equal but surpass these.

The power of this eye-piece is 12; equivalent focus, .8, corrected for the English tube ($\mu=9.5$).

Fig. 324 is enlarged twice.

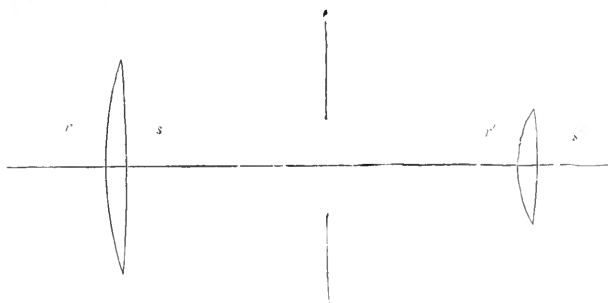

FIG. 324.—Nelson's new formula Huyghenian eye-piece.

Data: Glass, borosilicate crown. $\mu=1.51$, $r=64.0$, Jena catalogue No. 5.

Field-lens, biconvex	$r=+ .94$	} diameter .55.
	$s=-2.94$	
Eye-lens, biconvex	$r'=+ .34$	} diameter .30.
	$s'=-1.01$	

Distance of eye-lens from field-lens, measured from their surfaces, .97.

Distance of diaphragm from surface of field lens, .48.

Diameter of hole in diaphragm, .26.

Power, 12; equivalent focus, .53, corrected for the Continental tube ($\mu=6.3$).

Data: Glass, same as before.

Field-lens, biconvex	$r=+ .65$	} diameter .35.
	$s=-1.98$	
Eye-lens, biconvex	$r'=+ .22$	} diameter .20.
	$s'=-.66$	

Distance of eye-lens from field-lens, measured from their surfaces, .66.

Distance of diaphragm from surface of field-lens, .34.

Diameter of hole in diaphragm, .16.

These eye-pieces should enter the tube of the microscope as far as their diaphragms.

Positive Eye-pieces.—In the early compound microscopes the

¹ *J.R.M.S.* 1900, p. 165.

eye-pieces were all positive; that is to say, they consisted of a single bi-convex eye-lens and no field-glass. The definition with this must have been most imperfect; the addition of a field-lens, though it were a bi-convex not in the correct ratio of focus nor the theoretically best distance, must have been considered a great advance.

In this way matters rested, however, until the theoretically perfect Huyghenian form was devised. Object-glasses have been used as eye-pieces, and all forms of *loups* or simple microscopic lenses have been employed for the same purpose. Solid eye-pieces have also been used both in England and America, but with no results that surpassed a well-made Huyghenian combination; but the best form of all of the combinations which have been tried by us as positive single eye-pieces are the Steinheil *triple lous*; a section of one of these is seen in fig. 325. This combination also forms one of the best lenses for projection purposes ever constructed. But a positive eye-piece was devised by Ramsden, consisting of two plano-convex lenses of equal foci; the distance being equal to two-thirds the focal length of one. The diaphragm was of course exterior.

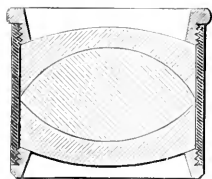

FIG. 325.

Abbe's Compensating Eye-pieces.—We have already given a general description of the nature and action, in connection with the apochromatic objectives, of this form of eye-piece.¹ In the section above on objectives we have referred to the fact that these eye-pieces are *over-corrected*; this may be easily seen by observing the colour at the edge of the diaphragm, which is an orange-yellow. If we compare this with the colour in the same position with a Huyghenian eye-piece, this will be blue, being seen through the simple uncorrected eye-lens.

There are three kinds of compensating eye-piece as designed by Abbe. These are:—

1. Searcher eye-pieces.
2. Working ,,
3. Projection ,,

1. *The searcher* forms are negatives of very low power, intended only for the purpose of finding an object; they consist of a single field lens and a doublet eye-lens.

The working forms are both positive and negative. The eye-piece for the long tube has a triplet eye-lens; but the remainder, viz. 8, 12, 18, and 27, when first introduced, were all positive. The 8 was subsequently, however, changed for a negative. Having used both, we are glad to learn that it is made now both positive and negative. It may be convenient to have the 8 a negative like the 4, but with regard to the 12, 18, 27 it is important that they should be positives.

These positive forms are on a totally new plan, being composed of a triple with a single plano-convex over it; the diaphragm is, of course, exterior to the lens (fig. 326). With these the definition is of the finest quality throughout the field, which has been reduced to about 6 inches. They present the admirable condition that with the deeper

¹ Chapter I, p. 33.

powers the proper position of the eye is further from the eye-lens than is the case with those of the Huyghenian construction: which makes it as easy to use an eye-piece of as great a power as 18 or 27 as one of 4 or 8.

The field of these eye-pieces has, as we believe, been very wisely limited to five or six inches. The attempt on the part of English opticians to give to our eye-pieces fields reaching eighteen inches is an error. A microscopic objective with the lowest aperture has the field greatly in excess of any other optical instrument; and to deal with such eccentric pencils as must be engaged by an eye-piece with a field of eighteen inches is a strain not justified by what is gained.

The powers of the working eye-pieces are also arranged in a new way. The multiplying powers for the long tube are 4, 8, 12, 18, 27; it will be seen at once, therefore, that they bear no definite ratio to one another, and if we seek to simplify the focal lengths we are, by the employment of the metrical system, confronted with decimal fractions. But without further elaboration it may be well to say that 12 is the most generally useful eye-piece, and if only one compensating eye-piece is to be selected, there can be no question, from a practical point of view, but this is the best to employ.

The 4 is too low, and the 27 is too high for general purposes, and the 8 and 18 are sufficiently near the 12 to give the latter the advantage in general work. We cannot, however, refrain from the expression of the opinion that a series of 5, 10, 20, or 6, 12, 24 powers would be in many senses more useful, and would offer facilities in application not secured by the series of Abbe now in use.

It may be well to give further emphasis to the fact that this construction of eye-piece is not only essential to the proper work of apochromatic objectives, but they greatly enhance the images given by ordinary achromatic lenses; and it may be noted that the 8, 12, and 18 eye-pieces for the short tube are identical with 12, 18, 27 for the long tube. The 4 eye-piece for the short tube makes a very suitable 6 power for the long tube.

A new series of eye-pieces has been recently introduced by W. Watson and Sons, to which they have given the trade name of 'Holosopic.' What is held to be a very simple method is employed for rendering them either over- or under-corrected, and therefore suitable for either apochromatic or the ordinary achromatic objectives.

This eye-piece is of the Huyghenian type, but unlike the ordinary pattern the eye-lens, together with the diaphragm, is mounted in a tube which slides telescopically in the body of the eye-piece, at the lower end of which the field-lens is fixed. This is shown in fig. 327. When the sliding tube is pushed home as far as it will go, the eye-

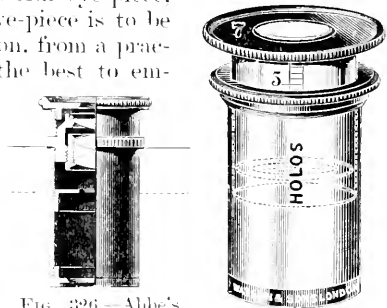

FIG. 326.—Abbe's compensating eye-piece of 12 power.

FIG. 327.—Watson's holoscopic eye-piece.

piece is an under-corrected one and suitable for use with the ordinary achromatic objectives; by drawing out the sliding tube and so increasing the distance between the eye and field lenses, the so-called over-correction, which is associated with the compensating eye-pieces, can be obtained in varying degree according to the amount of extension. A scale is provided on the sliding draw-tube for registering any desired position.

There are theoretically two distinct advantages with this eye-piece:—

(1) It obviates the necessity for being provided with both Huyghenian and compensating eye-pieces, because it performs the functions of both.

(2) It will have been observed that with some objectives the compensating eye-piece has appeared to possess too much over-correction, producing the feeling in the mind of the worker that if it were possible to vary the correction of the eye-piece a little a better image could be produced; this can theoretically be done with the new 'Holoscopic' eye-piece, but we prefer a definitely compensated, or an ordinary eye-piece.

The initial magnifying powers of this series of eye-pieces are:—

For the 160 mm. tube length 5, 7, 10, and 14 diameters.

.. .. 250 7, 10, 14, .. 20 ..

For the English tube length, where the diameter of the eye-piece fitting of the microscope permits of it, specially large field-lenses are used.

The cost is very little greater than that of the ordinary Huyghenian eye-pieces.

The **projection eye-piece** is mainly intended for photo-micrography, but it is also useful for drawing and exhibition purposes. It is a negative, with a single field-lens and a triple projection-lens. The projection-lens is fitted with a spiral focussing arrangement in order that the diaphragm which limits the field may be focussed on to the screen or paper. The field of this eye-piece is small, but its definition is exquisitely sharp.

It may not be generally known that good photo-micrographs can be obtained by projection with the ordinary compensating working eye-pieces, but this is a fact worthy of note.

It will perhaps be of practical utility if we append a table indicating the focus of the compensating eye-pieces when used with the *long* and the *short body*.

Special Eye-pieces.—The most important of these, the *micrometer eye-piece*, we have already considered, so far as its application to micrometry is concerned.¹ Its optical character may be properly considered here. If it is a negative eye-piece the micrometer is placed in the focus of the eye-lens; but if a positive combination, it is placed in the focus of the eye-piece itself. The Ramsden form described above is thoroughly

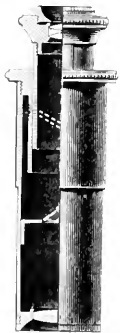

FIG. 328. Zeiss's projection eye-piece No. 2.

¹ Chapter IV.

Focus of Eye-pieces for Long Body.

Power	2	4	8	12	18	27
Focus in mm.	135	67.5	33.7	22.5	15	10
„ inches	5.3	2.6	1.33	.89	.59	.39

Focus of Eye-pieces for Short Body.

Power	2	4	4*	6	8	12	18
Focus in mm.	90	45	45	30	22.5	15	10
„ inches	3.54	1.77	1.77	1.18	.89	.59	.39

Projection Eye-pieces.—2 for short and 3 for long bodies = 90 mm. or 3.54 inches; 4 for short and 6 for long bodies = 45 mm. or 1.77 in.

suited for this purpose, but a negative form is often employed, the micrometer being placed inside the eye-piece in the diaphragm, *i.e.* the focus of the eye-lens.

In order that the micrometer may be susceptible of focus for various sights, it is necessary that the eye-lens in the case of a negative eye-piece, and the whole eye-piece in the case of a positive one, should be mounted in a sliding tube; and one with a spiral slot will be preferable, since it makes the work of focussing both facile and accurate.

If only one micrometer eye-piece is used it should be of medium power, such as $1\frac{1}{3}$ -inch focus; but it is an inexpensive and a useful plan to have an additional set of lenses to screw on to the same mount, so as to make the eye-piece, say, a $\frac{2}{3}$ -inch focus.

Spectroscopic, polarising, goniometer, and binocular eye-pieces are each treated under their respective subjects.

Quekett's index eye-piece is one which has a pointer placed at the diaphragm, so constructed that it can be turned in or out of the field, and is used to point to the position of an object.

A good plan, when the magnification is great, is to have a *diaphragm with a small aperture* to drop into the eye-piece and diminish the field of view. This not only makes the object to be pointed out more easily accessible to the eye, but—as we have by many years of observation proved—it aids in close observation upon minute objects by cutting off a large area of light without altering the intensity of what remains, and so makes close observation more easy.

Diaphragms with a square aperture are fitted into eye-pieces for the purpose of counting blood-corpuscles in a definite area. The hole in the diaphragm must be adjusted for a definite tube length and for use with a definite objective and used with no other.

As it is directly associated with the eye-piece, we shall find no better place to note the curious and hitherto unexplained fact, that when resolving striae or lines with oblique light the effect is much strengthened *by placing a Nicol's analysing prism over the eye-piece.*

Testing Object-glasses.—It will have been noted by the attentive

reader that many of the more important qualities of objectives are determined by the principles of their construction, and become in fact questions simply of the quality of the workmanship involved in producing the optical and mechanical parts of the object-glass.

The quality of the workmanship may be tested by technical means described below, and by that subtle power which comes with experience. This can only be imparted through the paths of labour and experiment, by which in every case it is reached. But, granted that an object has been illuminated in an intelligent and satisfactory manner, the first complete view of the image (which must of course be a thoroughly familiar one) will enable the expert to come to a conclusion as to the quality of a given objective. The character of the image to the expert determines at once the character of the lens. This is the more absolute if a series of eye-pieces (up to the most powerful that can be obtained) are at hand. Nothing tests the quality of an objective so uncompromisingly as a deep eye-piece. For *brilliance* of image a moderate power of eye-piece is of course best; but the capacity of the object-glass is clearly commensurate with its ability to endure high eye-pieces without loss of character, and even sharpness in the image. Unless the objective be of high quality, the sharpness of the image gradually disappears as the more powerful eye-pieces are used, until at last either all or part of the image breaks up into the 'rotten' details of a coarse lithograph.

A lens finely corrected (with large aperture) will bear the deepest eye-piecing with no detriment. The 24 mm. and the 12 mm. of Zeiss will suffer any eye-piecing accessible to the microscopist without the smallest surrender of the sharpness of the image. We have in fact tried in vain to 'break down the image' yielded by these objectives.

This mode of testing is of course to a large extent subjective, or at least is controlled by incommunicable judgments. It is most important therefore to have a mode of judgment that shall be accessible to the beginner and the interested amateur. Dr. Abbe has proposed a method which is at least accessible to all.

In ordinary practice microscope objectives, if tested at all by their possessors, are simply subjected to a comparison of performance with other lenses tried upon the same 'test-objects.'

The relative excellence of the image seen through each lens may, however, depend in a great part upon fortunate illumination, and not a little upon the experience and manipulative skill of the observer; besides which any trustworthy estimate of the performance of the lens under examination involves the consideration of a suitable test-object, as well as the magnifying power and aperture of the objective. It is knowing what is meant by a 'critical image,' and being able to discover whether or not a given objective will yield it. Clearly all tests of optical instruments, which are not capable of *numerical expression*, must be comparative. *Magnifying power* can be measured numerically; it is not comparative. In the same way *resolving power* is mathematically measurable; so is *penetrating power*. But *definition* and *brilliance of image*, and evidence of *centring*, can have no numerical expression; they are consequently comparative.

The structure of the test-object should be well known, and the value of its 'markings'—if intended to indicate microscopical dimensions—should be accurately ascertained, care being taken that the minuteness of dimensions and general delicacy and perfection of the test-object should be adapted to the power of the lens. A fairly correct estimate of the relative performance of lenses of moderate magnifying power may doubtless be thus made by a competent observer; but it is not possible from any comparisons of this kind to determine what may or ought to be the ultimate limit of optical performance, or whether any particular lens under examination has actually reached this limit.

Assuming the manipulation of the instrument and the illumination of the object to be as perfect as possible, and further that the test-object has been selected with due appreciation of the requirements of perfect optical delineation, a fair comparison can only be drawn between objectives of the same magnifying power and aperture. Which of two or more objectives gives the better image may be readily enough ascertained by such comparison, but the values thus ascertained hold good only for the particular class of objects examined. The best performance realised with a given magnifying power may possibly exceed expectation, yet still be below what might, and therefore ought to be obtained.

On the other hand, extravagant expectations may induce a belief in performances which cannot be realised. The employment of the test-objects most in use is moreover calculated to lead to an entirely one-sided estimation of the actual working power of an objective—as, for example, when 'resolving power' is estimated by its extreme limits rather than by its general efficiency, or 'defining power' by extent of amplification rather than by clearness of outline. So that an observer is tempted to affirm that he can discern through his pet lens what no eye can see or lens show. This happens chiefly with the inexperienced beginner, but not unfrequently also with the more experienced worker who advocates the use of great amplification, in whose mind separation of detail means analysis of structure, and optically void interspaces prove the non-existence of anything which he does not see.

As much time is often lost by frequent repetition of these competitive examinations (which, after all, lead to no better result than that the observer finds or fancies that one lens performs in his hands more or less satisfactorily than some other lens), it seems worth while to consider the value of a mode of testing which can be readily applied whatever its value may be. A short and easy method of testing an objective—not by comparison with others only, but by itself and on its own merits—affords not only the most direct and positive evidence of its qualities to those who are more concerned in proving these instruments than using them, but also yields to the genuine worker the satisfying conviction that his labour is not frustrated by faulty construction and performance of his instrument. It is, however, to be borne in mind that the microscopist, in any scrutiny of the quality of his lenses which he may attempt, has no other object in view than to acquire such insight into the optical

conditions of good performance as will enable him to make the best use of his instrument, and acquire confidence in his interpretation of what he sees, as well as manipulative skill in examining microscopical objects. To the constructor and expert of optical science are left the severer investigations of optical effects and causes, the difficulties of technical construction, the invention of new lens-combinations, and the numerous methods of testing their labours by delicate and exhaustive processes which require special aptitude and lie entirely outside the sphere of the microscopist's usual work.

Professor Abbe's mode of testing objectives is explained in his 'Beiträge zur Theorie des Mikroskops.'

The process, in our judgment, requires large experience and much skill to be of practical service; but it is based on the following principle:—

In any combination of lenses of which an objective is composed the geometrical delineations of the image of any object will be more or less complete and accurate according as the pencils of light coming from the object are more or less perfectly focussed on the conjugate focal plane of the objective. On this depend fine definition and exact distribution of light and shade. The accuracy of this focussing function will be best ascertained by analysing the course of isolated pencils directed upon different parts or zones of the aperture, and observing the union of the several images in the focal plane. For this purpose it is necessary to bring under view the collective action of each part of the aperture, central or peripheral, while at the same time the image which each part singly and separately forms must be distinguishable and capable of comparison with the other images.

1. The illumination must therefore be so regulated that each zone of the aperture shall be represented by an image formed in the upper focal plane of the objective (*i.e.* close behind or above its back lens), so that only one narrow track of light be allowed to pass for each zone, the tracks representing the several zones being kept as far as possible apart from each other.

Thus, supposing the working surface of the front lens of an objective to be $\frac{1}{4}$ inch in diameter, the image of the pencil of light let in should not occupy a larger space than $\frac{1}{16}$ inch. When two pencils are employed one of these should fall so as to extend from the centre of the field to $\frac{1}{16}$ inch outside of it, and the other should fall on the opposite side of the axis in the outer periphery of the field, leaving thus a space of $\frac{1}{16}$ inch clear between its own inner margin and the centre of the field. The objective images of the pencils occupy each a quarter of the diameter of the whole field.

If three pencils of light be employed, the first should fall so as to extend from the centre of the field to $\frac{1}{25}$ inch outside of it; the second should occupy a zone on the opposite side of it, between the $\frac{1}{5}$ and $\frac{1}{2}$ inch (measured from the centre); and the third the peripheral zone on the same side as the first in fig. 329.

This arrangement places the pencils of light in their most sensitive position and exposes most vividly any existing defect in correction, since the course of the rays is such that the pencils meet in

the focal plane of the image at the widest possible angle. As many distinct images will be perceived as there may be zones or portions of the front face of the objective put in operation by separate pencils of light. If the objective be perfect all these images should blend with one setting of focus into a single clear, colourless picture. Such a fusion of images into one is, however, prevented by faults of the image-forming process, which (so far as they arise from spherical aberration) do not allow this coincidence of several images from different parts of the field to take place at the same time, and (so far as they arise from dispersion of colour) produce coloured fringes on the edges bordering the dark and light lines of the test-object and the edges of each separate image, as also of the corresponding coincident images in other parts of the field.



FIG. 329.

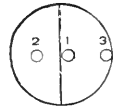

FIG. 330

It is to be borne in mind that the errors which are apparent with two or three such pencils of light must necessarily be multiplied when the whole area of an objective of faulty construction is in action. This would appear to us to be the strongest reason for utilising the whole area, because what we are seeking is the defects—the errors of the objective—and to make these as plain as possible is a *sine qua non*. Dr. Abbe proceeds, however, to consider—

2. The means by which such isolated pencils can be obtained.

As a special illuminating apparatus, the condenser of Professor Abbe is recommended, or even a hemispherical lens. But we are convinced that the illuminating apparatus should be as nearly aplanatic as it can be. This is certainly not true of Abbe's chromatic condenser or a hemispherical lens. The reason is obvious: the spherical aberration wholly prevents the rays passing through the holes in the diaphragm from being focussed on the object—the silvered plate of lines—at the same time. In the lower focal plane of the illuminating lens must be fitted diaphragms (easily made of blackened cardboard) pierced with two or three openings of such a size that the images, as formed by the objective, may occupy a fourth or sixth part of the diameter of the whole aperture (*i.e.* of the field seen when looking down the tube of the instrument, after removing the ocular, upon the objective image). The required size of these holes, which depends, first, on the focal length of the illuminating lens, and, secondly, on the aperture of the objective, may be thus found. A test-object being first sharply focussed, card diaphragms having holes of various sizes (two or three of the same size in each card) must be tried until one size is found, the image of which in the posterior focal plane of the objective shall be about a fourth to a sixth part of the diameter of the field of the objective. Holes having the dimensions thus experimentally found to give the required size of image must then be pierced in a card, in such a position as will produce images situate in the field, as shown by figs. 329 and 330; the card is then fixed in its place below the condenser. We are, however, strongly inclined to believe, partly from experiment, that better results would be obtained by putting sections of annular slits at the *back of the objective*. If the condenser be fitted so as to

revolve round the axis of the instrument, and also carry with it the ring or tube to which the card diaphragm is fixed, the pencils of light admitted through the holes will, by simply turning the condenser round, sweep the face of the lens in as many zones as there are holes. Supposing the condenser to be carried on a rotating sub-stage, no additional arrangement is required besides the diaphragm-carrier. Thus, for example, if a Collins condenser fitting in a rotating sub-stage be used, all that is required is to substitute for the diaphragm which carries the stops and apertures as arranged by the maker, a diaphragm pierced with, say, three openings of $\frac{3}{4}$ -inch diameter, in which circles of card may be dropped, the card being pierced with holes of different sizes according to the directions given above. We doubt, however, if any sub-stage will revolve with sufficient accuracy for so delicate a test.

Another plan adopted by Dr. Fripp, and found very convenient in practice, is to mount a condensing lens (Professor Abbe's in this case) upon a short piece of tube, which fits in the rotating sub-stage. On opposite sides of this tube, and at a distance from the lower lens equal to the focal distance of the combinations, slits are cut out through which a slip of stout cardboard can be passed across and

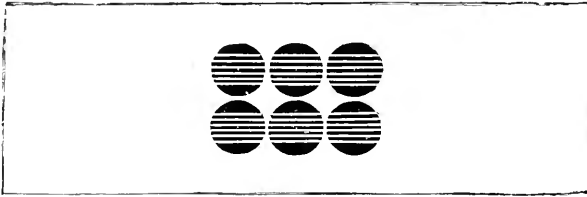

FIG 331.

below the lens. In the cardboard, holes of various sizes, and at various distances from each other, may be pierced according to pleasure. By simply passing the slip through the tube, the pencils of light admitted through the holes (which form images of these holes in the upper focal plane of the objective) are made to traverse the field of view, and by rotating the sub-stage the whole face of the lens is swept, and thus searched in any direction required. But here, again, the spherical aberration of an uncorrected condenser would, with an objective of large aperture, cause the oblique pencils under some conditions to pass under the object; and alteration of focus will not properly alter this—at least without a disturbance of the focus of the objective.

When an instrument is not provided with a rotating sub-stage, it is sufficient to mount the condenser on a piece of tubing, which may slide in the setting always provided for the diaphragm on the under side of the stage.

Card diaphragms for experiment may be placed upon the top of a thin piece of tube (open at both ends) made to slide inside that which carries the condenser, and removable at will. By rotating this inner tube the pencils of light will be made to sweep round in

the field, and thus permit each part of the central or peripheral zones to be brought into play. Against the accurate value of this, again, the spherical aberration of an uncorrected condenser would strongly operate.

Abbe's Test-plate.—This test-plate is intended for the examination of objectives with reference to their corrections for spherical and chromatic aberration, and for estimating the thickness of the cover-glass for which the spherical aberration is best corrected.

The test-plate consists of a series of cover-glasses, ranging in thickness from 0.09 mm. to 0.24 mm., silvered on the under surface and cemented side by side on a slide, the thickness of each being marked on the silver film. Groups of parallel lines are cut through the films, and these are so coarsely ruled that they are easily resolved by the lowest powers; yet from the extreme thinness of the silver they also form a very delicate test for objectives of even the highest power and widest aperture. The test-plate in its natural size is seen in fig. 331, and one of the circles enlarged is seen in fig. 332.



FIG. 332.

To examine an objective of large aperture, the discs must be focussed in succession, observing in each case the quality of the image in the centre of the field, and the variation produced by using alternately central and very oblique illumination.

When the objective is perfectly corrected for spherical aberration for the particular thickness of cover-glass under examination, the outlines of the lines in the centre of the field will be perfectly sharp by oblique illumination, and without any nebulous doubling or indistinctness of the minute irregularities of the edges. If, after exactly adjusting the objective for oblique light, central illumination is used, no alteration of the focus should be necessary to show the outlines with equal sharpness.

If an objective fulfils these conditions with any one of the discs it is free from spherical aberration when used with cover-glasses of that thickness. On the other hand, if every disc shows nebulous doubling, or an indistinct appearance of the edges of the lines with oblique illumination, or if the objective requires a different focal adjustment to get equal sharpness with central as with oblique light, then the spherical correction of the objective is more or less imperfect.

Nebulous doubling with oblique illumination indicates over-correction of the marginal zone; indistinctness of the edges without marked nebulosity indicates under-correction of this zone; an alteration of the focus for oblique and central illumination (that is, a difference of plane between the image in the peripheral and central portions of the objective) points to an absence of concurrent action of the separate zones, which may be due to either an average under- or over-correction, or to irregularity in the convergence of the rays.

The test of chromatic correction is based on the character of the colour-bands which are visible by oblique illumination. With good

correction the edges of the lines in the centre of the field should show only narrow colour-bands in the complementary colours of the secondary spectrum, namely, on one side yellow-green to apple-green, and on the other, violet to rose. The more perfect the correction of the spherical aberration, the clearer this colour-band appears.

To obtain obliquity of illumination extending to the marginal zone of the objective, and a rapid interchange from oblique to central light, Abbe's illuminating apparatus is manifestly defective on account of its spherical aberration. We want at least his achromatic condenser. For the examination of ordinary immersion objectives, the apertures of which are, as a rule, greater than 180° in arc (1.00 N.A.), and those homogeneous immersion objectives which considerably exceed this, it will be necessary to bring the under surface of the test-plate into contact with the upper lens of the illuminator by means of cedar oil, even if water-immersion objectives are used. We may add, as a matter of experience, that having once centred the light and the condenser, we hold, with deference to Dr. Abbe, that the light should on no account be touched, which, to obtain obliquity, he advises by mirror changes. We believe that this should be secured solely by the movement of the diaphragm.

For the examination of objectives of smaller aperture (less than 40° to 50°), we may obtain all the necessary data for the estimation of the spherical and chromatic collections by placing the concave mirror so far laterally that its edge is nearly in the line of the optic axis, the incident cone of rays then only filling one-half of the aperture of the objective, by which means the sharpness of the outlines and the character of the colour-bands can be easily estimated.

It is of fundamental importance, in employing the test-plate, to have brilliant illumination and to use an eye-piece of high power. With oblique illumination the light must always be thrown perpendicularly to the direction of the lines.

When from practice the eye has learnt to recognise the finer differences in the quality of the outlines of the image, this method of investigation gives very trustworthy results. Differences in the thickness of cover-glasses of 0.01 or 0.02 mm. can be recognised with objectives of 2 or 3 mm. focus. The quality of the image outside the axis is not dependent on spherical and chromatic correction in the strict sense of the term.

Indistinctness of the outlines towards the borders of the field of view arises, as a rule, from unequal magnification of the different zones of the objective; colour-bands in the peripheral portion (with good colour-correction in the middle) are always caused by unequal magnification of the different coloured images. Imperfections of this kind, improperly called 'curvature of the field,' are shown to a greater or less extent in the best objectives, when their aperture is considerable.

Testing an objective does not mean seeing the most delicate points in an object; it rather means the manner in which an object of some size is defined.

A test for low powers up to $\frac{1}{3}$ of 80° or N.A. .65 is an object on

a dark ground. Nothing is so sensitive. For the lowest powers one of the smaller and more delicate of the *Polycistina*, because it takes light well, is good. For medium powers a coarse diatom, a *Triceratium fimbriatum*, is excellent; for unless an objective is well corrected the image will be fringed and surrounded with scattered light, and the aberration produced by the cover-glass is plainly manifest, and by accurate correction can be done away.

Error of centring is one of the special defects of objectives which the Abbe method of testing does not cover. But if we place a sensitive object in a certain direction, and when the best adjustments have given the best image, rotate that object through an angle of 90° , only a well-centred objective will give an unaltered image throughout. If not well centred it will at certain parts grow fainter or sharper. The most useful image for this purpose with medium powers is a hair of *Polyxenus lagurus* mounted in balsam (frontispiece, fig. 6).

For higher powers nothing surpasses a podura scale. In this particular it has always been of great value to opticians. It should be strongly marked, and must be in optical contact with the cover-glass; this may be tested by means of an oil-immersion and the 'vertical illuminator.'

The objectives of widest aperture are now more easily tested, because homogeneous condensers with much wider aplanatic areas are now, as we have seen, made by the leading English and Continental opticians; and there is little doubt but that there is a considerable future before homogeneous condensers. The best that can be done is to take a diatom, such as a *Coscinodiscus*, in balsam with strong 'secondaries' (Plate I, figs. 3 and 4), with the largest aplanatic cone that can be obtained, which at present can be best accomplished with a semi-apochromatic oil-immersion condenser of 1.3 N.A. It must be a good objective indeed that does not show signs of breaking down under this strain. An illuminating cone of N.A. 1.0 is probably just below the point of overstrain with the best lenses at present at our disposal.

Testing lenses therefore resolves itself into the following methods, viz. :—

1. For low and medium powers: dark ground with a *Polycistina* or a diatom, according to the power.

2. *Centring* for medium powers (an ordeal not needful for very low powers) should be by means of a hair of *Polyxenus lagurus*, employing a $\frac{3}{4}$ illuminating cone.

3. *Centring* for high powers: by means of podura scale.

4. *Definition*: with wide-angled oil immersions, *Coscinodiscus asteromphalus* with wide-angled cone obtaining sharp, brilliant, and clear view of 'secondaries,' or coarse specimen of *Naricula rhomboides*, which may be mounted in a dense medium. In testing a lens it does not so much matter what the object is, because the real test lies in the ability of the lens to stand a large direct axial cone. A lens of very great excellence will stand a $\frac{2}{3}$ ths cone, an excellent lens a $\frac{3}{4}$ ths cone, an indifferent lens only a $\frac{1}{2}$ cone, while a bad lens will not even admit the use of that. A dark ground is a

very severe test, as it is of the nature of a full cone, so to speak, and only the lower powers will stand it. If a dark ground is required with the higher objectives it can be obtained by using an oil-immersion condenser, but the aperture of the objective will have to be reduced by a stop.

The apertometer, as its name implies, is an instrument for measuring the *aperture of a microscopic objective*. As correct ideas of aperture have only obtained during the past few years, it may be inferred that apertometers constructed before the definition of aperture was given and accepted were crude and practically useless.

The controversy on the 'aperture question,' which was in full operation some eighteen years since, is not an altogether satisfactory page in the history of the modern microscope, and for many reasons it is well to pass it unobservantly by. It will suffice to state that during its progress an apertometer was devised by R. B. Tolles, of America, which accurately measured the true aperture of an objective. About the same time Professor Abbe gave his attention to the subject, and with the result, as we have seen, that he has given a definite and permanent meaning to *numerical aperture*, making it, as we have seen, the equivalent of the mathematical expression $n \sin u$, n being the refractive index of the medium, and u half the angle of aperture.¹

The application of this formula to, and its general bearing upon, the diffraction theory of microscopic vision has been given in its proper place; but as the aim of this manual is thoroughly

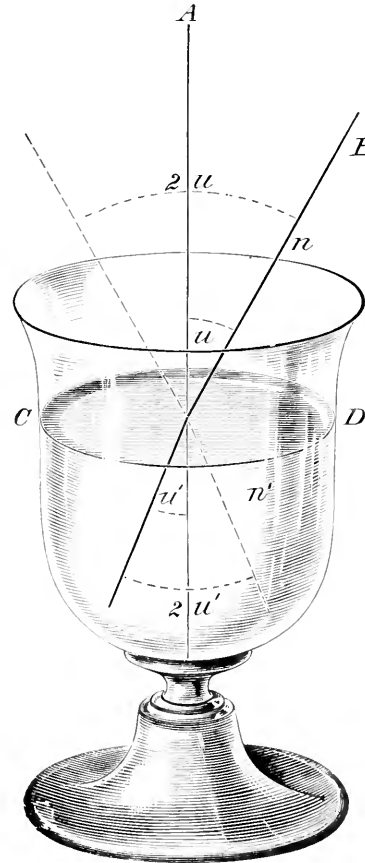

FIG. 333.

practical, we shall be pardoned for even a small measure of repetition in endeavouring to explain the use of this formula in such a manner that only a knowledge of simple arithmetic will be required

¹ A knowledge of the meaning of the trigonometrical expression 'sine' is not necessary in solving any of the following questions. As the values are all found in tables, it is only necessary to caution those who are unacquainted with the use of mathematical tables to see that they have the 'natural sine' and not the 'log sine.'

to enable the student to work out any of the problems which are likely to arise in his practical work.

We can best accomplish this by illustration.

(i) If a certain dry objective has an angular aperture of 60° , what is its N.A. (*i.e.* numerical aperture)?

All that is needful is to find the value of $n \text{ sine } u$; in this case n = the refractive index of the medium, which is air, is 1; and u , which is half of $60^\circ = 30^\circ$ opposite 30° in a table of natural sines,¹ is $\cdot 5$; sine u , therefore $= \cdot 5$, which multiplied by 1 gives $\cdot 5$ as the N.A. of a dry objective having 60° of angular aperture.

(ii) What is the N.A. of a water-immersion whose angular aperture $= 44^\circ$?

n here $= 1\cdot33$, the refractive index of water; and u , or half 44° , is 22° . Sine 22° from tables $= \cdot 375$, which multiplied by $1\cdot33 = \cdot 5$ (nearly), which is the N.A. required.

(iii) What is the N.A. of an oil-immersion objective having $38\frac{1}{2}^\circ$ of angular aperture?

n the refractive index of oil, which is equal to that of crown glass, is $1\cdot52$; $u = 19\frac{1}{4}$ and sine u from table $= \cdot 329$, which multiplied by $1\cdot52 = \cdot 5$.

Thus it is seen that a dry objective of 60° , a water-immersion of 44° , and an oil-immersion of $38\frac{1}{2}^\circ$ all have the same N.A. of $\cdot 5$.

It will be well, perhaps, to give the converse of this method.

(iv) If a dry objective is $\cdot 5$ N.A., what is its angular aperture?

Here because $n \text{ sine } u = \cdot 5$, sine $u = \frac{\cdot 5}{n}$; the objective being dry, $n = 1$, therefore sine $u = \cdot 5$. Opposite $\cdot 5$ in the table of natural sines is 30° ; hence $u = 30^\circ$. But as u is half the angular aperture of the objective, $2u$ or $60^\circ =$ the angular aperture required.

(v) What is the angular aperture of a water-immersion objective whose N.A. $= \cdot 5$?

Here $n = 1\cdot33$, $n \text{ sine } u = \cdot 5$; sine $u = \frac{\cdot 5}{n} = \frac{\cdot 5}{1\cdot33} = \cdot 376$; $u = 22^\circ$ (nearly) from tables of sines; $\therefore 2u = 44^\circ$, the angle required.

(vi) What is the angular aperture of an oil-immersion objective of $\cdot 5$ N.A.?

Here $n = 1\cdot52$, $n \text{ sine } u = \cdot 5$; sine $u = \frac{\cdot 5}{n} = \frac{\cdot 5}{1\cdot52} = \cdot 329$; $u = 19\frac{1}{4}^\circ$ (by tables of sines); and $2u = 38\frac{1}{2}^\circ$, the angle required.

We may yet further by a simple illustration explain the use of $n \text{ sine } u$.

In the accompanying diagram, fig. 333, let n' represent a vessel of glass; let the line A be perpendicular to the surface of the water CD; suppose now that a pencil of light impinges on the surface of the water at the point where the perpendicular meets it, making an angle of 30° with the perpendicular. This pencil in penetrating the water will be refracted or bent towards the perpendicular. The

¹ Vide Appendix A to this volume.

problem is to find the angle this pencil of light will make with the perpendicular in the water.

To do this we must remember that $n \sin u$ on the air side is equal to $n' \sin u'$ on the water side. Thus on the air side $n=1$, $u=30^\circ$, and by the tables of sines $\sin 30^\circ = \cdot 5$; consequently on the air side we have $n \sin u = \cdot 5$.

On the water side $n'=1.33$, and u' is to be found. But as $n' \sin u' = n \sin u$, therefore $\sin u' = \frac{n \sin u}{n'} = \frac{\cdot 5}{1.33} = \cdot 376$;

which (as the tables show) is the natural sine of an angle of 22° (nearly); consequently $u'=22^\circ$; so the pencil of light in passing out of air into water has been bent 8° from its original direction. Conversely a pencil in water, making an angle of 22° with the perpendicular, would on emerging from the water be bent in air 8° further away from the perpendicular, and so make an angle of 30° with it.

Now if we suppose that these pencils of light revolve round the perpendicular, cones would be described, and we can readily see that a solid cone of 60° in air is the exact equivalent of a solid cone of 44° in water.

If we further suppose that the water in the vessel is replaced by cedar oil, the pencil in air, remaining the same as before, will, when it enters the oil, be bent more than it was in the water, because the oil has a higher refractive index than water; n in this case is equal to 1.52.

The exact position of the pencil can be determined in the same manner as in the previous case. On the air side, as before, $n \sin u = \cdot 5$; on the oil side $n' \sin u' = n \sin u$; $\sin u' = \frac{n \sin u}{n'} = \frac{\cdot 5}{1.52} = \cdot 329$, which (by the tables) is the natural sine of $19\frac{1}{4}^\circ$. It follows that the pencil has been bent in the cedar oil $10\frac{3}{4}^\circ$ out of its original course, and a cone of 60° in air becomes a cone of $38\frac{1}{2}^\circ$ in cedar oil or crown glass.

Finally, it is instructive to note the result when an incident pencil in air makes an angle of 90° with the perpendicular: $n \sin u$ becomes unity, and n in water $48\frac{3}{4}^\circ$, in oil 41° (nearly); consequently a cone of either $97\frac{1}{2}^\circ$ in water, or $82\frac{1}{4}^\circ$ in oil or crown glass, is the exact equivalent of the whole hemispherical radiant in air. In other words, and to vary the mode in which this great truth has been before stated, the theoretical maximum aperture for a dry lens is equivalent to a water-immersion of $97\frac{1}{2}^\circ$ and an oil-immersion of $82\frac{1}{4}^\circ$ angular aperture.

The last problem that need occupy us is to find the angular aperture of an oil-immersion which shall be equivalent to a water-immersion of 180° angular aperture.

On the water side $n = 1.33$, $u = 90^\circ$, $\sin 90 = 1$, $n \sin u = 1.33$. On the oil side $n' = 1.52$ and u' has to be found.

As $n' \sin u' = n \sin u$, therefore $\sin u' = \frac{n \sin u}{n'} = \frac{1.33}{1.52} = \cdot 875$; $u' = 61^\circ$ (nearly) by the tables; $2u' = 122^\circ$ (nearly), the angle required.

It thus appears (1) that dry and immersion objectives having different angular apertures, if of the same *equivalent aperture*, are designated by the same term. Thus objectives of 60° in air, or 44° in water, or $38\frac{1}{2}^\circ$ in oil, have identically the same aperture, and are known by the same designation of $\cdot 5$ N.A.

(2) The penetrating power of any objective is proportional to $\frac{1}{\text{N.A.}}$, and its illuminating power to $(\text{N.A.})^2$. Therefore, if we double the N.A. we halve the penetrating power, and increase the illuminating power four times.

In comparing the penetrating and illuminating powers of objectives, however, care must be taken to avoid a popular error, by making them between objectives of different foci.

It cannot, for example, be said that a $\frac{1}{4}$ -inch objective of $\cdot 8$ N.A. has half the penetrating power of a $\frac{1}{2}$ -inch of $\cdot 4$ N.A. Neither can it be said that it has four times the illuminating power. What is meant is that a $\frac{1}{4}$ -inch of $\cdot 8$ N.A. has half the penetrating and four times the illuminating power of a $\frac{1}{2}$ -inch objective of $\cdot 4$ N.A.

But because penetrating and illuminating powers diminish as the square of the foci, a $\frac{1}{2}$ -inch objective of $\cdot 6$ N.A. has four times the illuminating and nearly four times the penetrating power of a $\frac{1}{4}$ -inch of $\cdot 6$ N.A.; but these conditions only hold when a full illuminating cone is employed, in other words, when the back lens of the objective, as seen when the eye-piece is removed, is full of light. Thus if a small cone of illumination is used with the $\frac{1}{2}$ -inch objective of $\cdot 6$ N.A., its illuminating power would be much diminished, while its penetrating power would be much increased.

The old nomenclature, in use before numerical aperture was so happily introduced, did not of course admit of comparisons of penetrating and illuminating powers by inspection; which, however, is a manifest advantage, contributing to accuracy and precision in important directions.

(3) It may be well, for the sake of completeness, to repeat¹ here that the resolving power of an objective is directly proportional to its numerical aperture. If we double the N.A. we also double the resolving power; and this not simply with objectives of the same foci, as in the case of penetrating and illuminating powers. Thus it is not only true that a $\frac{1}{2}$ -inch objective of $\cdot 6$ N.A. resolves twice as many lines to the inch as a $\frac{1}{2}$ -inch of $\cdot 3$ N.A., but so also does a $\frac{1}{2}$ -inch of $1\cdot 4$ N.A. resolve twice, and only twice, as many as a $\frac{1}{4}$ -inch of $\cdot 7$ N.A.

Within certain limits, then, the advantage lies with long foci of wide angle, because we thus secure the greatest resolving power with the greatest penetrating and illuminating powers.

From what has here been shown, then, it becomes evident that the employment of the microscope as an instrument of precision is largely due to Abbe's work, and that the introduction of numerical aperture, with its strictly accurate meaning, has been a practical gain of untold value. But this has been greatly enriched by his having introduced a thoroughly simple and useful *apertometer*. This

¹ Chapter I.

involves the same principle as that of Tolles, but it is carried out in a simpler manner.

Abbe's instrument is presented in fig. 334. It will be seen that it consists of a flat cylinder of glass, about three inches in diameter and half an inch thick, with a large chord cut off so that the portion left is somewhat more than a semicircle; the part where the segment is cut is bevelled from above downwards to an angle of 45° , and it will be seen that there is a small disc with an aperture in it denoting the centre of the semicircle. This instrument is used as follows:—

The microscope is placed in a vertical position, and the apertometer is placed upon the stage with its circular part to the front and the chord to the back. Diffused light, either from sun or lamp, is assumed to be in front and on both sides. Suppose the lens to be measured is a dry $\frac{1}{4}$ -inch; then with a 1-inch eye-piece having a large field, the centre disc with its aperture on the apertometer is brought into focus. The eye-piece and the draw-tube are now removed, leaving the focal arrangement undisturbed, and a lens

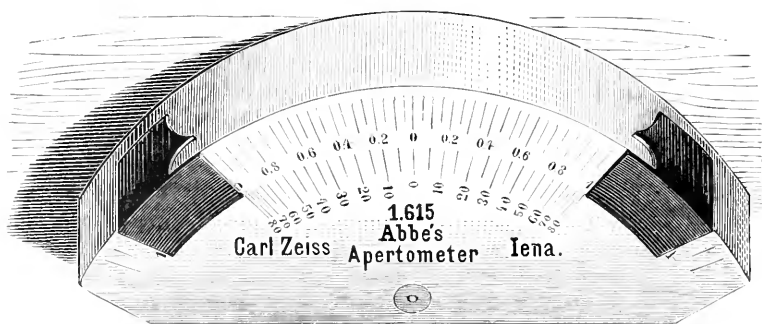

FIG. 334.—Abbe's apertometer.

supplied with the apertometer is screwed into the end of the draw-tube. This lens with the eye-piece in the draw-tube forms a low-power compound microscope. This is now inserted into the body-tube, and the back lens of the objective whose aperture we desire to measure is brought into focus. In the image of the back lens will be seen stretched across, as it were, the image of the circular part of the apertometer. It will appear as a bright band, because the light which enters normally at the surface is reflected by the bevelled part of the chord in a vertical direction, so that in reality a fan of 180° in air is formed. There are two sliding screens seen on either side of the figure of the apertometer; they slide on the vertical circular portion of the instrument. The images of these screens can be seen in the image of the bright band. *These screens should now be moved so that their edges just touch the periphery of the back lens.* They act, as it were, as a diaphragm to cut the fan and reduce it, so that its angle just equals the aperture of the objective and no more.

This angle is now determined by the arc of glass between the

screens; thus we get an angle in *glass* the exact equivalent of the aperture of the objective. As the numerical apertures of these arcs are engraved on the apertometer they can be read off by inspection. Nevertheless a difficulty is experienced, from the fact that it is not easy to determine the exact point at which the edge of the screen touches the periphery of the back lens, or, as we prefer to designate it, *the limit of aperture*, for, curious as this expression may appear, we have found at times that the back lens of an objective is *larger* than the *aperture* of the objective *requires*. In that case the edges of the screen refuse to touch the periphery.

On the whole we have found that a far better way of employing this instrument is to *use it in connection with a graduated rotary stage*, the edge of the flame of a paraffin lamp being the illuminator.

Thus: Set the lamp in a direction at right angles to the *chord* of the apertometer, and suppose that the index of the stage is at 0° . The edge of the flame will be seen in the centre of the bright band. The sliding screens being dispensed with, *rotation of the stage will cause* the image of the flame to travel towards the edge of the aperture; rotation is continued until the image of the flame is half extinguished *by the edge of the aperture*, the arc is then read, and the same thing is repeated on the other side, and the mean of the readings is taken.

If the stage rotates truly, and if the instrument is properly set up, the reading on the one side ought to be identical with that on the other.

Suppose that the sum of the readings on both sides = 60° , the mean reading is consequently 30° , which is the semi-angle of aperture of the lens in *glass*. From this datum we have to determine the N.A. of the dry $\frac{1}{4}$ -inch as well as its angular aperture in air.¹

(i) As before, $\text{N.A.} = n \sin u$, and $n \sin u = n' \sin u'$; which means that the aperture on the air side is equal to the aperture on the glass side; $n = 1$ for air; $n' = 1.615$, the refractive index of the apertometer; u' is the mean angle measured, which in this case is 30° ; and $n \sin u$ has to be found.

Now $\sin 30^\circ = .5$ (by the tables); $n' \sin u' = 1.615 \times \sin 30^\circ = 1.615 \times .5 = .8 = n \sin u =$ the N.A. required.

(ii) Again, to find the *angular aperture* or $2u$. As before, $n \sin u = n' \sin u'$ and $\sin u = \frac{n' \sin u'}{n} = \frac{1.615 \times .5}{1} = .8$; $u = 53^\circ$

nearly (by the tables); $2u = 106^\circ$, which is the angle required.

(iii) If it be a *water-immersion* we have to deal with, suppose the mean angle = $45^\circ = u'$; $\sin 45^\circ = .707$ (by the tables); $n = 1.33$; and $n' = 1.615$.

$n \sin u = n' \sin u' = 1.615 \times .707 = 1.14$, the N.A. required.

(iv) Again, $\sin u = \frac{n' \sin u'}{n} = \frac{1.615 \times .707}{1.33} = .86$; $u = 59\frac{1}{4}^\circ$ (by the tables); and $2u = 118\frac{1}{2}^\circ$, the angle required.

(v) In the case of an *oil-immersion*, suppose the mean angle

¹ Vide p. 2 et seq.

$= 60^\circ = u$; $\sin 60^\circ = \cdot 866$ (by the tables); $n = 1\cdot 52$; $n' = 1\cdot 615$; $n \sin u = n' \sin u' = 1\cdot 615 \times \cdot 866 = 1\cdot 4$, which is the N.A. required.

$$(vi) \text{ Again, } \sin u = \frac{n' \sin u'}{n} = \frac{1\cdot 615 \times \cdot 866}{1\cdot 52} = \cdot 92.$$

$u = 67^\circ$ (by the tables), $2u = 134^\circ$, the angle required.

It is manifest that if the refractive index of the apertometer equals that of the oil of cedar, the mean angle measured is the semi-angle of aperture of the objective, and its sine multiplied by that refractive index is the numerical aperture.

This will be found the more accurate and universally applicable method of measuring the apertures of objectives, as the extinction of the light shows precisely when the limit of aperture is reached.

Powell and Lealand's stands lend themselves admirably for use with the apertometer. The body being removable, the lens can be placed in the upper part of the nose-piece, and any measurement can be accurately made. We would advise every microscopist to master the use of this admirable instrument, and to demonstrate for himself the aperture capacity of his lenses, that he may know with precision their true resolving powers. It will facilitate this that Mr. Nelson has shown (*Journ. R.M.S.* 1896, p. 592) that the use of the internal lens is not required; the point of rotation of the stage when the edge of the flame is eclipsed by the limiting aperture of the objective can be readily observed by means of a low-power eye-piece.

When the apparatus is accurately set up in the manner described above, the exact point is indicated by the dark segments coming across the field of the eye-piece. One dark segment will be found to advance slowly from one side, and then when the precise point of rotation of the stage is reached the other dark segment will come in from the other side and meet it. For this purpose the glass disc with its refractive index only engraved upon it is alone required. Messrs. Zeiss supply this at a much lower cost (25s.) than the engraved disc and the supplementary lens.

Boucher's circular slide rule is a convenient adjunct to the apertometer, for the N.A. can be read off by inspection without the necessity of looking out sines or making calculations.

CHAPTER VI

PRACTICAL MICROSCOPY: MANIPULATION AND PRESERVATION
OF THE MICROSCOPE

WITHOUT attempting to occupy space with a discussion of the question of the right of 'microscopy' to be considered a science, we may venture to affirm that it will be but a recognition of practical facts if we claim as a definition of *microscopy* that it expresses, and is intended to carry with it, all that belongs to the science and art of the microscope as a scientific instrument, having regard equally to its theoretical principles and its practical working. Hence 'practical microscopy' will mean a discourse on, or discussion of, the methods of employing the microscope and all its simplest and more complex appliances in the most perfect manner, based alike and equally upon theoretical knowledge and practical experience.

On this condition a 'microscopist' means (or at least implies) one who, understanding 'microscopy,' applies his theoretical and practical knowledge either to the further improvement and perfection of the instrument, or to such branches of scientific research as he may profitably employ his 'microscopy' in prosecuting. He is, in fact, a man employing specialised theoretical knowledge and practical skill to a particular scientific end.

But a '*microscopical society*' has a noble *raison d'être*, because it is established, on the one hand, to promote—without consideration of nationality or origin—improvements in the theory and practical construction of both the optical and mechanical parts of the microscope, and to endeavour to widen its application as a scientific instrument to every department of human knowledge, recording, investigating, and discussing every refinement and extension of its application to every department of science, whether old or new.

In this sense no more practical definition of a 'microscopical society' can be given than is contained in the invaluable pages of the 'Journal of the Royal Microscopical Society' from the end of 1880 to the present day; and no better justification for the existence of such a society can be needed than is afforded by the work done directly or indirectly by it, in inciting to and promoting the theoretical and practical progression of the instrument and its ever-widening applications to the expanding areas of natural knowledge.

In this chapter we propose to discuss the best practical methods of using the instrument and its appliances, the theory concerning which has already been discussed, while the mode of applying this

knowledge to biological and other investigations is entered upon in the subsequent chapters of the book.

To begin his work with success—if his object be genuine work—the student must be provided with some room, or portion of a room, which he can hold sacred to his purpose. Unless special investigations are undertaken, it is not a large area that is required, but a space commanding, if possible, a north aspect, and which can be arranged to readily exclude the daylight and command complete darkness.

The first requirement will be a *suitable table*.

This should be thoroughly *firm*, and it should be *rectangular in shape*. A round table, if small especially, is most undesirable, as it offers no support for the arms on either side of the instrument; and with prolonged work this is not only a serious, but an absolutely fatal defect.

In a rectangular table the centre may be kept clear for microscopical work, while there are two corners at the back, one on the left and the other on the right hand. The former may be used for the locked case or glass shade for protecting the instrument when not in use; and when it is in use, it in no way interferes with the usefulness of the table. In the same way the right-hand corner may be used for the cabinet of objects which is being worked, or the apparatus needful for use.

The most important part of the table—that is, the middle, from front to back—should be kept quite clear for the purposes of manipulation, and a sufficient space should be kept clear on either side of the instrument for resting the arms, and no loose pieces of apparatus should ever be deposited within those spaces. This soon becomes a habit in practice, for experience teaches—sometimes painfully, by the unwitting destruction of a more or less valuable appliance.

The spaces to the right, beyond that left for the arm of the operator, may be used for the work immediately in hand—especially for a second and simpler microscope. An instrument with only a coarse adjustment and a 1-inch or a $\frac{2}{3}$ -inch objective will suffice, or a good dissecting-stand will answer every purpose. Those who do much practical work will find such a plan more rapid and more efficient than the cumbrous method of a rotary nose-piece, especially where critical work has to be done.

When work is being done in a darkened room there should be on the extreme right a small lamp with a paper shade. (Special shades for this purpose can be obtained from Baker, of Holborn.) This light may be kept low or used for general illumination when required; it is never obtrusive, and always at hand.

A similar space on the left hand should be reserved for a small round stand fitted with a flat cylindrical glass shade with a knob on the top. The stand should be suitably arranged to hold two eye-pieces, three objectives, one condenser, a bottle of cedar-oil (fitted with a suitable pointed dipper), and a box containing the condenser-stops. This is a most useful arrangement for such a table; and it need not have a diameter greater than nine inches.

The size for the top of such a table should be $4\frac{1}{2} \times 3$ feet, and as

no work, such as mounting or dissecting, may be supposed to be done at this table, it is well to cover the surface with morocco, that being very pleasant and suitable to work upon.

It should be remembered that for a full-sized microscope a depth of three feet is required for comfortable work. When the microscope is set up for drawing,¹ the lamp being used direct, 2 ft. 5 in. is the narrowest limit in which this can be accomplished.

Another point of much importance is the *height of the table*. Ordinary tables, being about 2 ft. 4 in. high, are too low even for large microscopes. *Two or three inches higher than this will be found to greatly facilitate all the work to be done.* It is best to have the table made completely, on thoroughly solid square legs, to the height of 2 ft. 7 in.; but we may employ the glass blocks employed underneath piano feet as an expedient. It is further important to have the table quite open underneath, and not with nests of drawers on either side, because with this particular table it will be frequently required that two persons may sit side by side, which is only possible with a clear space beneath.

The accompanying illustration (fig. 335), with the appended references, will make quite clear the character of the table which we recommend, as well as the mode of using it.

The table above described is supposed to be employed wholly for general purposes of observation or research on wholly or partially mounted objects.

But the microscopist who aims at more than this will require an arrangement for dissecting, mounting, and arranging histological and other preparations, and in some cases a special table for general purposes of microscopical biology. These are certainly not essentials, especially if the work done is a mere occasional occupation; but where anything like continuity or periodical regularity of occupation with such work is intended, these will be of great service.

A *dissecting and mounting table* is indeed of inestimable value to those who affect complete order and cleanliness in the accomplishment of such work.

We have found in practice that a table firmly made, with a height of 2 ft. 6 in., semicircular in form, and a little more than half the circle in area on the outside, with the arc of another circle cut out from it to receive the person sitting at work—much after the fashion

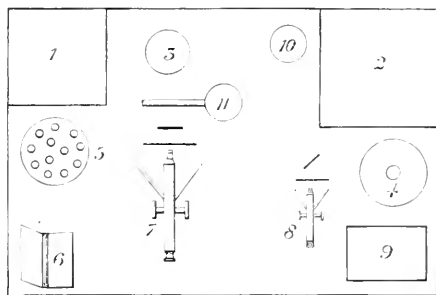

FIG. 335.—Microscopist's table.
(Scale, $\frac{1}{2}$ inch to 1 foot.)

1. Case for microscope; 2. Cabinet for objects;
3. Microscope lamp; 4. Lamp with shade;
5. Stand of apparatus; 6. Book; 7. Large microscope;
8. Second microscope; 9. Writing pad;
10. Bull's-eye stand; 11. Light-modifier.

¹ Chap. IV, p. 287.

of the jeweller's bench—serves admirably. A rough suggestion of this is given in fig. 336, which presents the plan of the top of the table. The whole area beneath should be unoccupied, but at A and B drawers may be put, not extending more than four inches below the under surface of the top of the table; on the side B a couple of shallow drawers, with everything required in the form of *scalpels, needles, scissors, forceps, pipettes, life-slides, &c.* in the upper one, and *pliers, cutting pliers, small shears, files* of various coarsenesses and finenesses, &c. in the other; on the A side a single drawer containing *slips, covers* of various thicknesses, *bone, tin, glass,* and other *cells* of all (assorted) sizes, *watch-glasses, staining cups or slabs, lifters* (if used), *saw* with fine teeth, *hones* of various shapes, *pearl plate* for grinding and polishing glass, &c., *platinum capsule, camera lucida,* three 'No. 2' sable brushes (water-colour), &c.

In this way all that is needed for dissection or mounting will be within reach without moving from the chair; and if by an arrange-

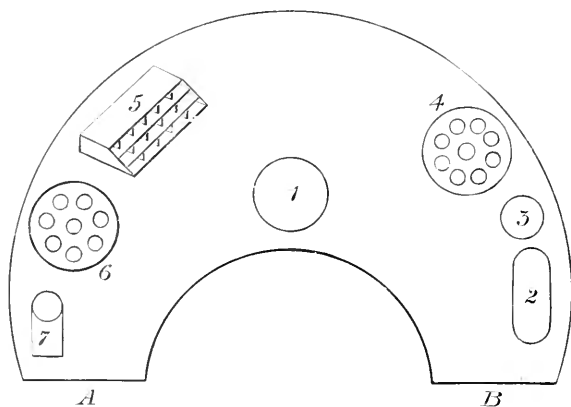

FIG. 336.—Dissecting and mounting table.

ment which most moderately ingenious manipulators could accomplish, each of the articles in the drawers has a fixed place, there will be no difficulty in finding by touch what is wanted.

The table top may be of pitch pine stained black, or, still better, some very hard wood finished smoothly, but 'grey.'

The space in the figure immediately in front of the operator may be cut out to a convenient size and thickness. A thick plate-glass slab whose edges on the right and left sides shall be slightly bevelled, so that it may slide firmly into a prepared space cut into the surface of the table, should occupy this space, the surface being exactly level with the surface of the table. This plate of glass should be made black on its under side, so as to present a *uniform black surface*. This is often of great value in certain kinds of work. Equally useful is a *purely white* unabsorbent surface, and a slab of *white porcelain* may be easily obtained of the same size and be made to fit exactly into the same place.

In using this table for dissection the arms have complete rest, and 1 in the figure would represent the position of the dissecting microscope.

2 is a suitable position for a small easily managed *microtome* for general (chiefly botanical) purposes. We find that of Ryder¹ to answer this purpose admirably.

3 is a small vessel of spirit (dilute) for use with the section knife.

4 is a stand of *mounting media*, in suitable bottles, as *Canada balsam* in paraffin, or xylol, glycerine, &c., as well as small bottles of *reagents* for botanical or zoological histology, &c.

5 is a nest of apertures in which to place partly mounted objects, to protect them from dust, while the balsam, dammar, &c. may be hardening on the cover so as to be in a suitable state for final mounting. A slide may go over the sloping front of this and wholly exclude dust.

6 is a stand of cements, varnishes, &c., such as are needful; and

7 is a turn-table.

For the work of dissection, when the subject requires reflected light, one of the desiderata is a mode of illumination at once convenient and intense. Mr. Frank R. Cheshire, F.L.S., &c., whose work on 'Bees and Bee-keeping' is a proof of knowledge and practice of minute anatomy, adopts an old plan which we have always found admirable. It is illustrated in fig. 337. Rays of light from a lamp are parallelised by a bull's-eye full upon an Abraham's prism and focussed upon the object. The prism may be mounted on a long many-jointed arm, and is of most varied usefulness. A Stephenson's binocular is, we believe, employed by this gentleman, but it will serve admirably for any form of dissecting instrument.

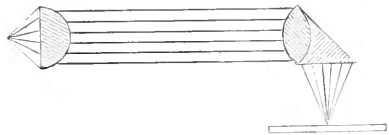

FIG. 337.—Mode of illumination for dissection.

For the more general purpose of the private laboratory a *plain, firm table* 4 feet 6 inches \times 3 feet in area, of a suitable height for the worker, should be fitted as follows, viz.: if fig. 338 represent the rough plan of the table, 1 and 2 are gas fittings attached to the main to supply *blow-pipe*, *Bunsen's burner*, &c.

4 is a small tube of metal attached to the water main, with a tap, and bent in the form of an inverted \cap , with the attached leg of the \cap the longer. This affords a pleasant stream of water for washing dissections, &c.; and if the open end be made with a screw, and have a suitably made piece of tubing fitted to screw on to it, this latter may be attached to an *indiarubber tube*, at the other end of which we may fasten *fine glass nozzles*, which will act as *wash bottles of the finest bore*, and serve with the finest dissecting work.

5 is a glass trough for waste, with a perforated aperture, 6, con-

¹ *Journ. R.M.S.* new series, 1887, p. 682.

ned with a waste-pipe, through which the waste water, &c. flows innocuously away.

3 represents the position of a Thoma microtome, and A, B are two well-framed flat slides, which may be drawn out eighteen inches, or pushed fully in. They are found at times to be of great service, where the space is somewhat confined.

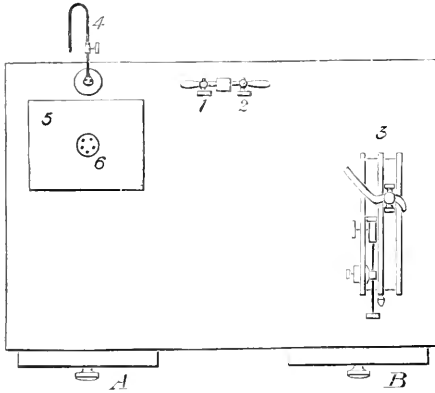

FIG. 338.—Laboratory table for microscopical work.

bottles¹ containing all the stains, reagents, and similar materials in constant use. If these be labelled with paper labels saturated in a

solution of solid paraffin in turpentine, and after the turpentine has evaporated firmly fixed on the bottle, they are very permanent, and, indeed, better than anything we have tried save where the name of the contents is enamelled or engraved on the bottle.

It has been already pointed out that there are conditions of research in which the microscope has to be in a constantly

vertical position. This was the case with the researches on the saprophytic organisms made conjointly by the present Editor and Dr. J. J. Drysdale.² It must always be the case where certain forms of continuous life stages are employed for prolonged or con-

¹ Chapter VII.

² *Monthly Micro. Journ.* vols. x. to xviii.; *Journ. R.M.S.* vol. iii. p. 1; vol. v. series ii. p. 177; vol. vi. p. 193; vol. vii. p. 185; vol. viii. p. 177.

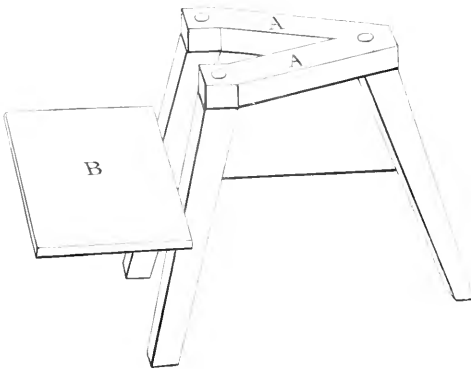

FIG. 339.—Tripod for using microscope in an upright position.

tinuous observations on the development of the minute forms of life.

In such cases the table is quite unsuitable, and special stands have to be employed that from their form give great stability to the microscope, and afford the body and head of the observer as much command and ease in using the instrument in this awkward position as can be obtained.

This is best done by means of a firmly made tripod, with a V-shaped piece at the top made to receive the feet of the microscope. Fig. 339 is an outline of the construction. The three legs of the



FIG. 340.—Using the microscope in an upright position for special investigations necessitating its use in this position.

tripod are well made and firmly braced together with metal rods. A, A is the bed for the tripod feet of Powell and Lealand's large stand. B is a table which slides to the level of A, A, or down to its present position. This is mainly to receive the lamp.

By this arrangement the body can so place itself as to command the instrument fully, and there is an arrangement at the two sides, A, A, to receive supports on which the arms may rest when any other manipulation than that involved in working the fine adjustment and the milled heads of the stage is required. The manner of

using this arrangement is seen in fig. 340. In that case, however, the whole is employed for the making of a camera lucida drawing with a $\frac{1}{20}$ -inch objective; it is not a desirable position for general work, but was absolutely needful for the kind of investigation being pursued; and the position of the basal tripod, the microscope upon it, the position of the lamp (partly seen in the immediate foreground to the left), and the relative ease with which the entire instrument is at the command of the observer, will be manifest.

In order to use the microscope successfully, we must have an

illumination the intensity of which we can fully rely on. *Daylight has certain qualities that involve advantages at times, and under special circumstances, in its employment, but this is the exception rather than the rule.* What is needed is a well-made lamp with a flat flame; this we should be able to control with great ease as to height and distance from the microscope. Nothing is equal practically to a $\frac{1}{2}$ -inch or a 1-inch paraffin lamp; this gives the whitest light artificially accessible save the higher intensities of the incandescent electric light. But there is nothing of this kind at present accessible to the student. The employment of the *edge* of the flame of a well-made paraffin lamp used with good 'oil' has no present rival. Its illuminating power should be about

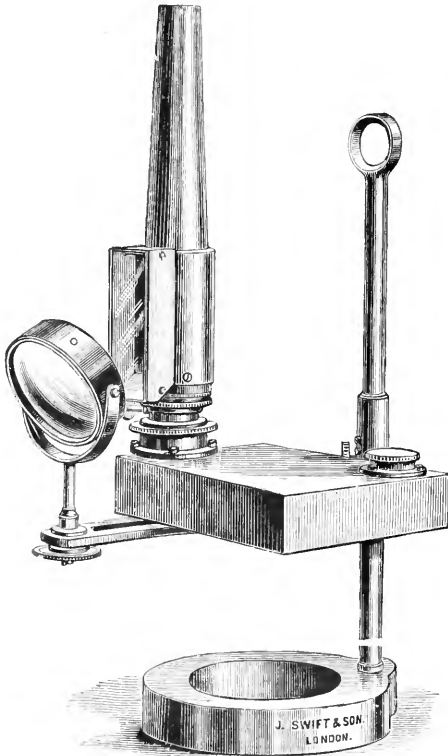

FIG. 341.—Lamp devised by Mr. E. M. Nelson.

$2\frac{1}{2}$ candles. Gas is much yellower, and not so easy in employment.

To get the best form of microscopical lamp is a matter of some importance. We call the attention of the reader to the best simple form of lamp which will accomplish every purpose. This is a model arranged by Mr. Nelson, the drawing of which is given in fig. 341. The lamp burns paraffin and has an ordinary $\frac{1}{2}$ -inch wick burner. The reservoir is rectangular and flat, $5\frac{1}{2} \times 4 \times 1\frac{1}{4}$; it serves three distinct purposes: 1st, it will hold sufficient oil to burn for a whole day; 2nd, permits the lamp to be lowered near the

table; 3rd, radiates the heat conducted by the metal chimney, and prevents the oil boiling. The burner is placed at one angle of the reservoir to enable the flame to be placed very near the stage of the microscope, which is exceedingly useful with some kinds of illumination, especially with reflected light, with the higher powers, and for Powell and Lealand's super-stage condenser.

The hole for filling the reservoir is placed at the diagonal corner for convenience. The chimney is metal, with an ordinary 3×1 glass slip in front; the diameter of the flame-chamber should not exceed $1\frac{1}{2}$ inch, and the grooves holding the glass slip should project $\frac{1}{4}$ inch from the flame-chamber; the aperture should be only $1\frac{1}{2}$ inch long; length of chimney should be 7 inches. Chimney should be dead-black inside. This chimney serves four purposes: 1st, image of flame is not distorted by striae and specks common to ordinary lamp chimneys; 2nd, prevents reflexion from inner surface of chimney, which causes a double image of flame; 3rd, prevents scattered light in room; 4th, is not readily broken; slips can be easily replaced.¹

By rotation of chimney either the edge or flat side of the flame may be used. The bull's-eye is of Herschel's form, viz. a meniscus and crossed convex; it is mounted on an arm which rotates centrally with the lamp flame. Unfortunately, as we have seen (p. 332), there are errors in Sir J. Herschel's original calculation, and with these it has been copied by many opticians; a lens, it has been demonstrated, can be made on the Herschel formula, as calculated by Mr. Nelson, having a minimum aberration. The arm is slotted so that the bull's-eye may be focussed to the flame; it can be fixed by a clamping screw. The bull's-eye may also be elevated or depressed and fixed by a clamping screw, not shown in the illustration. The bull's-eye, having once been focussed, is permanently clamped, and it is brought into or taken out of position simply by rotation of the arm. There should be a groove in the pillar with a steadying pin on the lamp to prevent rotation during elevation or depression.

The form of the clamping screw is important; it should be at the upper part of the tube, and not at the lower, as shown in the figure. This keeps the screw clean from oil, which always, to a greater or less extent, exudes over paraffin lamps. The screw should be of that form which closes a pinching ring round the rod, and not merely a screw which screws on to the rod and bruises it. This lamp, if made, as it should be, with a japanned tin reservoir and a cast-iron tripod foot, is quite inexpensive. There is no justification for a circular foot, except that it can be readily and well finished in the lathe with better apparent results and less labour than other forms.

A small lamp is made by Messrs. R. and J. Beck. We illustrate it in fig. 342.

The base, A, consists of a heavy ring, into which a square brass

¹ It is very important to remove the metal chimney after use, or at least not to leave it on when not in use, since the evaporating paraffin gathers round it and causes undesirable scent when the lamp is again lit. The thinnest slips should be used.

rod, B, is screwed. The square rod carries a socket, C, with an arm, D, to which the lamp is attached.

On each side of the burner, and attached to the arm, D, is an upright rod, G, to one of which the chimney is fixed, independent of

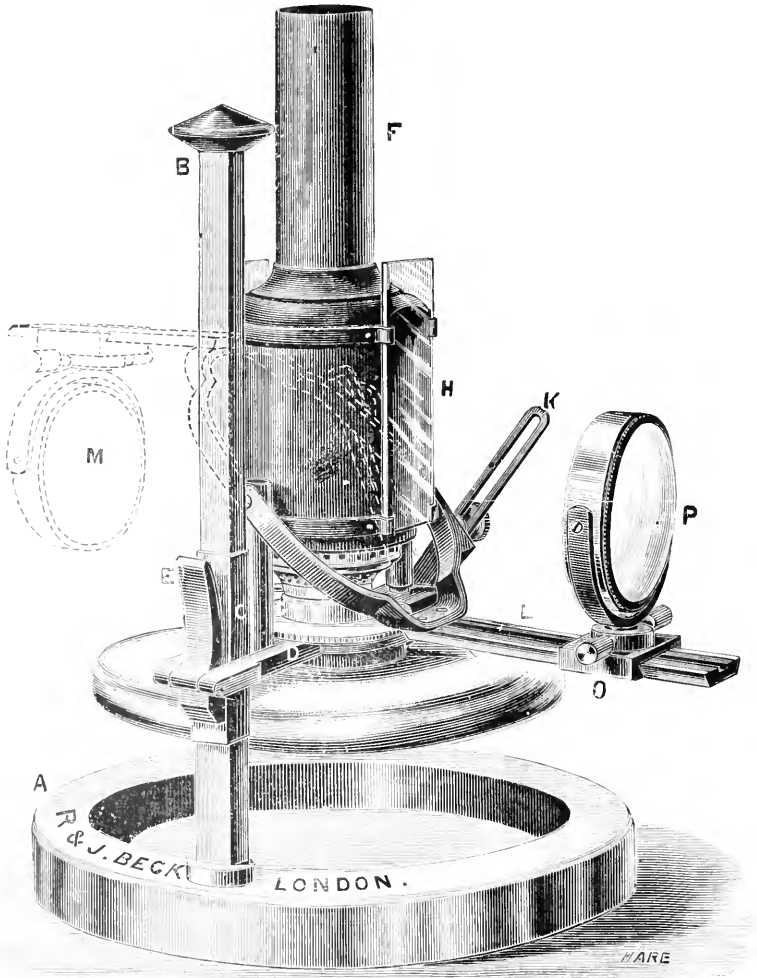

FIG. 312.

the reservoir of the lamp, thus enabling the observer to revolve the burner and reservoir, and obtain either the edge or the flat side of the flame without altering the position of the chimney. The chimney, F, is made of thin brass, with two openings opposite to each other, into which slide 3×1 glass slips of either white, blue, or

opal glass, the latter serving as a reflector; but we do not consider the reflexion here accomplished as other than an error; it causes double reflexion and confuses the condensed image.

A semicircle swings from the two uprights, G, to which it is attached by the pins, H, placed level with the middle of the flame; to this semicircle is fixed a dovetailed bar, L, carrying a sliding fitting, O, which bears a Herschel bull's-eye, P. This is complex, and therefore costly.

The bull's-eye is fixed at any inclination by a milled head working in a slotted piece of brass, K, fixed to the arm, D.

For use with the microscope in an upright position, when prolonged investigations have to take place, the lamp becomes even of more importance than under ordinary circumstances. The present Editor devised a somewhat elaborate apparatus of this kind, which he always employs in this kind of observation.¹ But the essential part of it is only an arrangement by which a milled-head movement of the entire lamp may take place to the right or the left of the observer, as well as a similar power to elevate or depress the position of the flame. When the microscope is fixed, and the rectangular prism for illumination (in place of the mirror) is fixed at right angles, the centring of the lamp flame upon the object is more readily done by means of *motion in the lamp*. A very simple form of this lamp has been made for the Editor by Mr. Charles Baker, of Holborn; it is seen in fig.

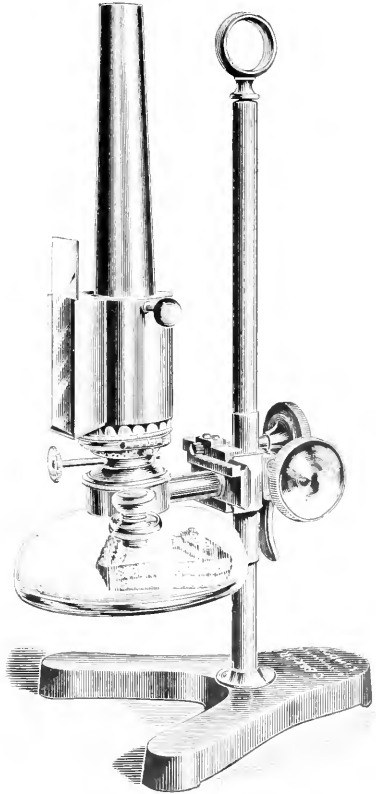

FIG. 343.

343, being an ordinary lamp, except that the milled head to the right as we face the flame racks up and down the entire lamp, and the milled head behind, and at right angles to this, works a rack and pinion (shown in the engraving) carrying the whole lamp to the right or left of the middle position. This lamp would be better, if the student did not object to the cost, to be made with a metal reservoir, or at least to have an arrangement by means of

¹ *Monthly Micro*, *Jan. n.*, vol. xv, p. 165.

which the bull's-eye (with a catch fixing its focus from the flame) were so affixed as to be carried up and down and to right and left with the lamp.

When the microscope is fixed in its upright position, and the prism is arranged to give direct and not oblique reflexion, the lamp flame, by means of a card, is arranged as nearly right for the reflexion of the image of the flame into the centre of the field as may be, and then a little movement in one or both milled heads will bring it accurately into the field.

We may arrange the microscope for ordinary transmitted light, that is, for light caused to pass through the object into the object-glass, by placing it upon the table, arranged as already directed; the instrument is then sloped to the required position, and a condenser, suitable to the power to be employed,¹ is put into the sub-stage. The lamp is now put into the right position, with a bull's-eye, on the left of the observer. The condenser is then, as described below, to be 'centred,' when the objective may be changed as desired, and the eye-piece altered to suit. But it should be carefully noted that, if apochromatic powers are being used, there must be accurate adjustment of the tube length if the best results

are to be obtained; and with any serious increase of the power of the objective a condenser of higher aperture and shorter focus must be used.

Often, however, as good or better results may be obtained without the employment of the mirror at all, the light being sent directly through the condenser from the lamp flame. The mode of arrangement for this kind of manipulation is presented in Plate V., where it will be observed that the microscope is inclined more towards the horizontal to suit the observer; the lamp is directly in front of the sub-stage, the mirror is turned aside, and a frame (fixed upon a bull's-eye stand) carrying a monochromatic screen is placed between the lamp flame and the condenser (sub-stage).

By this means the light is sent into the condenser and upon the object, and is then treated as is the case (for centring) when the mirror is used. The first step in the direction of efficiency in the use of the microscope is to understand *the principles of illumination*, and a knowledge of the various effects produced by the bull's-eye lies on the threshold of this.

Having given details as to the forms of *lamp* which are of most service, we assume that a paraffin lamp with $\frac{1}{2}$ -inch wick is used.

If we place the edge of this flame (E, fig. 344) in the centre and exact focus of the bull's-eye B, A shows the effect of doing so.

If a piece of card were held in the path of the rays proceeding from B, the picture as shown at A would not be seen—instead of it an enlarged and inverted image of the flame. The image at A is

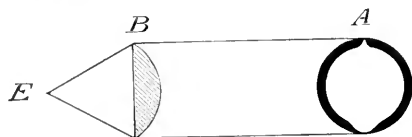

FIG. 344.—Edge of lamp flame in centre and focus of bull's-eye.

¹ Vide Chapter IV, p. 298.

obtained by placing the eye in the rays and by looking directly at the bull's-eye.

The light is so intense that it is more pleasant to take the field lens of a 2-inch eye-piece and place it in the path of the rays focusing the image of the bull's-eye on a card. It should be noticed with care that the *diameter* of the disc A depends upon the diameter of the bull's-eye B; but the intensity of the light in A depends on the focal length of B. The shorter the focus, the more intense will be the light.

We are here assuming throughout that the field lens is at a fixed distance from the bull's-eye B.

But if we *move the flame, E*—still central—*within* the focus of B, we get the result shown in D, fig. 345. But by moving *E without* the focus of B we get the picture H, while K is the picture when E is focussed *but not centred*.

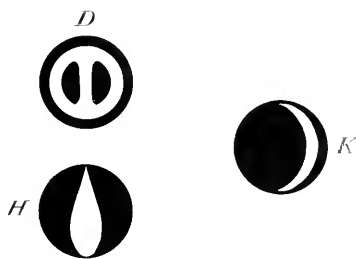

FIG. 345.—Altered relations between lamp flame and bull's-eye.

A common error, one repeatedly met with, is that of placing a concave mirror, C (fig. 346), so that the flame, E, is in its *principal focus*. The result of this is that *parallel rays* are sent to B. These rays are brought to a focus at a distance from B about equal to twice the radius of the curvature of B and then scattered, a totally different result from what is aimed at. If the concave mirror, C, is to be of any use in illumination, it must be placed so that E is *not at its principal focus*, but at its *centre of curvature*.

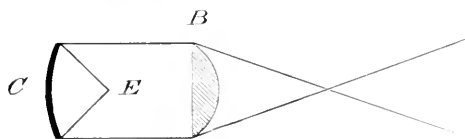

FIG. 346.—Result of placing flame in principal focus of concave mirror.

The bull's-eye gives an illustration of what is of wider application. The method of obtaining a critical image with a condenser by means of transmitted light is shown in fig. 347. E is the edge of the flame, S represents the sub-stage condenser, and F the object. F is thus the focal conjugate of E, and F and E are in the principal axis of S; that is

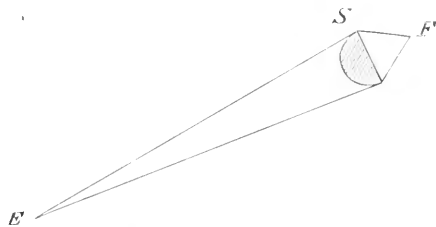

FIG. 347.—Mode of obtaining critical image.

to say, these are the relations which exist when a condenser is focussed on and centred to an object. Let this be understood as

the law, and there can be but little difficulty remaining in getting the best results from a condenser.

Fig. 348 illustrates another method of getting the same result. We may illuminate a condenser with light direct from the flame, as in fig. 347, or we may interpose the mirror as in fig. 348. *M* is the plane mirror, and, properly used, exactly the same result may be obtained as in the former case. It is, however, slightly more difficult to set up, but the method shown in fig. 347 will, on the whole, be preferable.

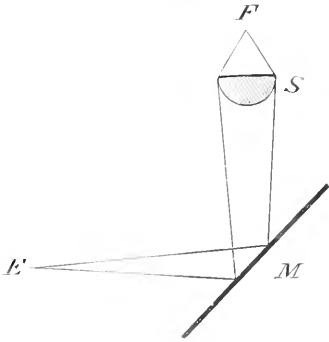

FIG. 348.—Another method of getting critical image.

Nothing can be of more moment to the beginner than to understand the practical use of the condenser. We must direct the student to what has been stated concerning it in Chapter IV. But the following should be carefully considered.

Fig. 349 shows a sub-stage condenser, *S*, and an objective, *O*, both focussed on the same point. The condenser has an aperture equal to that of the objective. Now if the eye-piece be removed, and we look at the back lens of the objective, it will be seen to be full of light, as at *R*. The same thing, but with the aperture of the condenser cut down by a stop, is seen in fig. 350. Now only a part of the back of the objective is filled with light, as at *T* in the same illustration.

Now it does not follow, because the back lens of the objective is full of light, as in fig. 349, that therefore *the field* ought to be full of light. The field only shows the *bright image of the edge of the flame*,

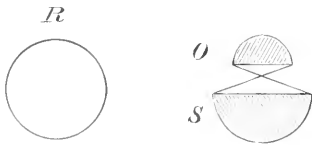

FIG. 349.—Condenser and object-glass with the same aperture.

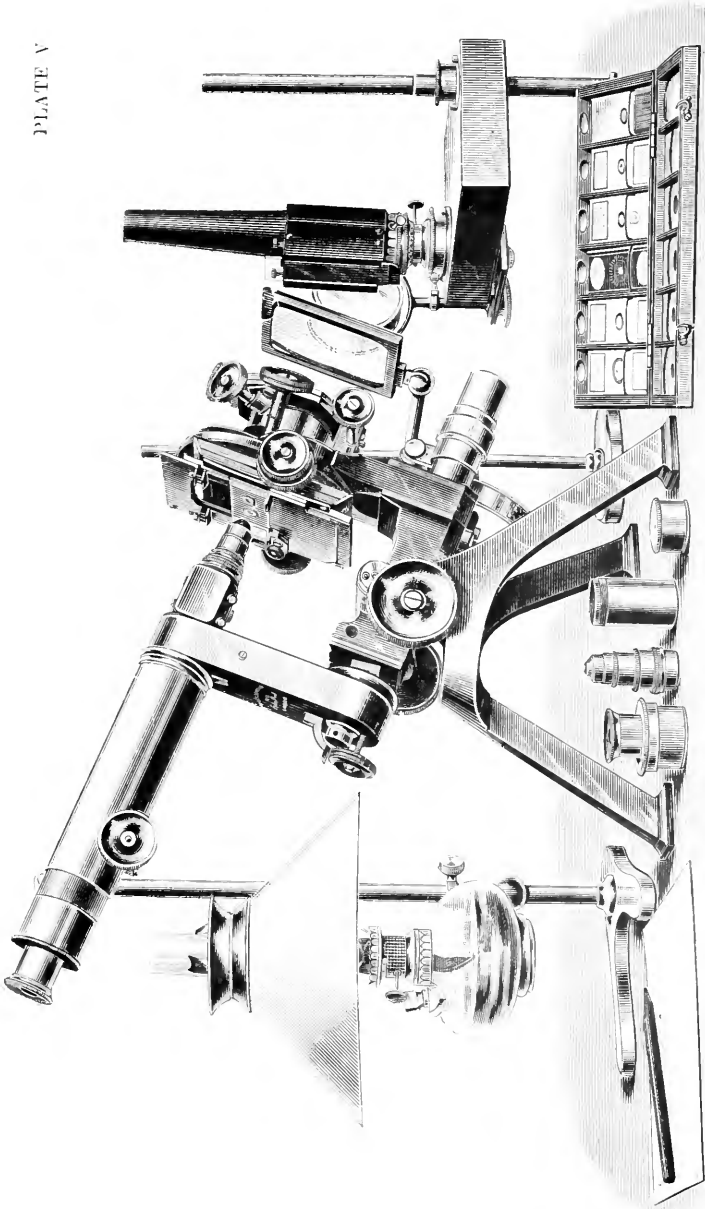

FIG. 350.—The same, with the aperture of the condenser cut down.

and it is *in that alone that a critical picture can be found*. If the condenser be racked either within or without the focus, the *whole field will become illuminated*, but at the same time a far smaller portion of the objective will be utilised. On removing the eye-piece and examining the back lens of the objective, pictures like *D*, *H*, fig. 345, will be seen—*D* when within, and *H* when without the focus.

The condition represented in fig. 349 at *R* and *O* is the severest test which can be applied to the microscopic objective; that is to say, to fill the whole objective with light and so test the *marginal and central portions at the same time*.

Even to obtain the state of illumination known as *diffused day-*



MODE OF OBTAINING TRANSMITTED LIGHT DIRECT WITHOUT THE AID OF THE MIRROR.

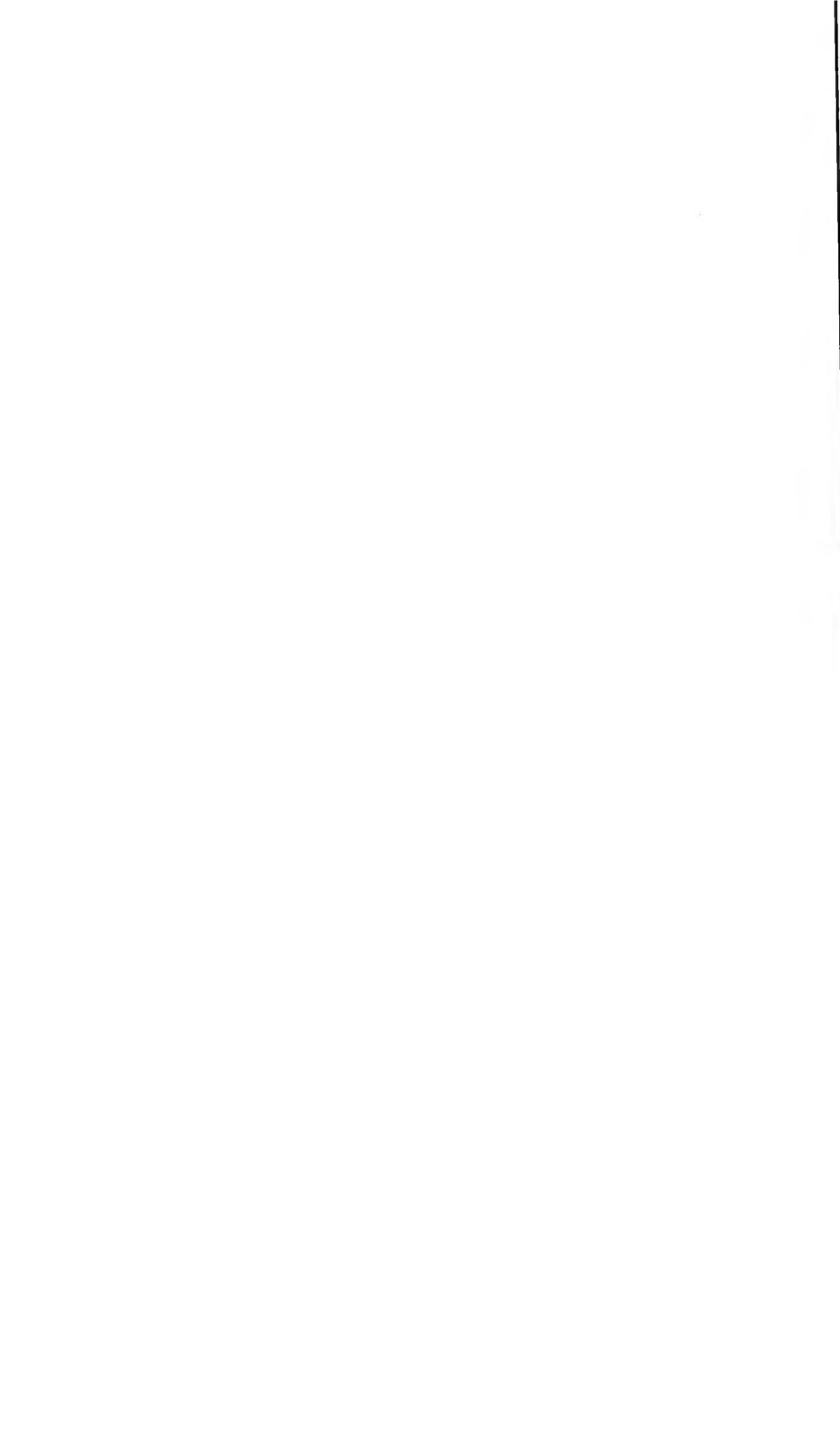

light' with the simple mirror when no condenser is used is frequently done in a most inaccurate manner. The correct method of doing this is shown in fig. 351. F is the plane of the object, C is the concave mirror, the mirror being placed at the distance of its principal focus from the object. But the manner in which it is usually done from want of thought or knowledge, or both, is shown in fig. 352.

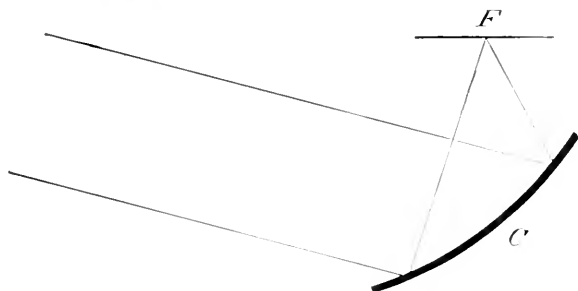

FIG. 351.—Illumination for 'diffused daylight.'

where it is manifest that there is a total disregard of the true focal point of the mirror and its incidence on the plane of the object. From the impracticability of this diagram as a representation of a working plan of illumination, we may see at once the importance of having the mirror fixed upon a *sliding tube*, so that its focal point may be adjusted.

It is also important here to note that in *daylight illumination* a

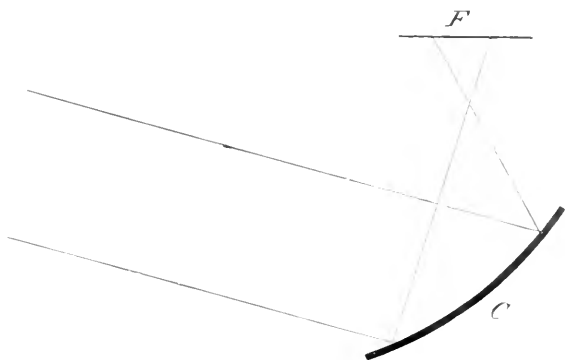

FIG. 352.—Erroneous method of arrangement for 'diffused daylight.'

plane mirror gives a *cone of illumination*, as in fig. 353, when there is ample sky-room; but a *window* acts as a *limiting diaphragm*.

In regard to the parallelism of the *direct solar rays* there is of course no question. But the parallelism of that portion of the solar light which goes to form the firmament in our own higher atmosphere is so completely broken up by refraction and reflexion amongst the subtle particles of this higher atmosphere that the rays

which constitute our daylight fall from every point of the visible heavens (though with greatly diminished intensity). That is to say, we have at disposal a light source extending over 180° , while the sun itself extends over a visual angle of but half a degree. Being thus surrounded by an illimitable and self-luminous expanse of ether undulations, the question is no longer of parallel rays only, but of light emanating from an outer circle above the earth upon every point of the earth's surface; and a mirror exposed to such a luminous atmosphere must both receive and reflect from all sides and upon all sides. If, however, it be placed under the stage of a microscope, all vertical light is intercepted, and there remains nothing but the oblique incidence as the starting-point of the theory of illumination by converging light: for it scarcely needs repetition that obliquity of incidence gives inevitable rise to obliquity of reflexion; and it

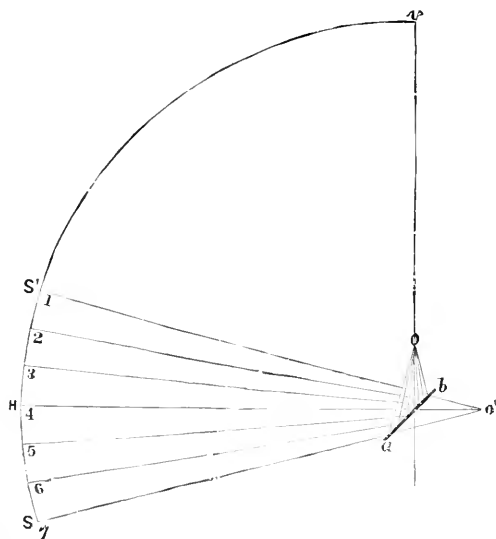

FIG. 353.—Light from the open sky falls upon the mirror in all directions.

becomes equally clear that in order to strike the object the *light must always fall obliquely on the mirror*.

Then it follows from what has been said that the light falling from the open sky upon a mirror falls in all conceivable directions. Thus fig. 353 shows the lines 1 to 7, including an angle of 30° . If nothing intervene, the light of that sky surface must fall upon the mirror, *a b*, and be reflected on *O*. The intermediate rays, 2, 3, 4, 5, 6, form the *converging illuminating pencil*, with of course an infinity of others filling up the spaces between.

In other words, every point of a mirror is a radiant of a whole hemisphere, and *this is equally true whether the mirror be plane, concave, or convex*, so long as it is exposed to a boundless sky. Therefore a plane, concave, or convex mirror will give a cone of

illumination of which the object is its apex, no matter what the inclination or distance of the mirror. The angle of the cone will be the angle the mirror subtends at the object—subject of course to its not being cut down by a stop.

As a matter of fact, the boundless sky is an abstraction which is never obtained in practice; therefore it practically does make a difference whether the plane or concave mirror is used, and whether the latter is focussed on the object or not.

The dotted lines in fig. 354 show rays falling on six different points on a plane mirror; the continuous lines show the reflexions of these rays on the object. The heavy lines from either extremity of the mirror to the object show the maximum angle of cone that mirror will give in that particular position.

The influence of a limitation (as by means of a window) should therefore be considered. The extent to which it is limiting, so far as its influence upon the illuminating cone is concerned, is shown by an examination of the back of the lens of the objective when the eye-piece is removed. Fig. 355 shows the back of the objective when the plane mirror is used, and fig. 349 R. when the concave mirror is used, as in fig. 351. The beginner should study these experiments by repeating them.

Fig. 356 illustrates the method of obtaining dark-ground illumination when the arrangement shown in fig. 347 or 348 does not give a sufficiently illuminated area even when the flat of the flame is used. Of course it will be understood that for the dark-ground result a suitable stop is inserted beneath the sub-stage condenser.

It has been shown by many illustrations on many subjects that certain results in critical work can be obtained with the bull's-eye which are not so accessible without its use. But Mr. T. F. Smith has made this clear regarding the structure of certain diatoms.

This, there can be no doubt, is due to the fact that the parallel rays, falling on the sub-stage condenser, shorten its focus and increase the angle of the cone of illumination. It will be noticed that when the bull's-eye is introduced the condenser will need racking-up. At the same time we prefer illumination as in fig. 347 or 348, except in cases where illuminating cones of maximum angles are required. Thus it will be little needed with transmitted light except when oil-immersion objectives of large aperture are used, because illuminating cones up to .9 N.A. can be obtained with good

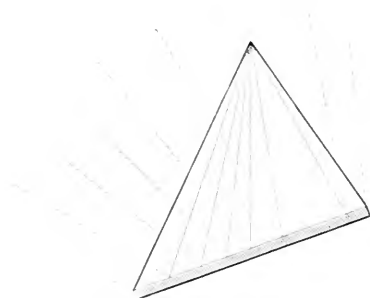

FIG. 354.—With the open sky, light is focussed at all points.



FIG. 355.—Image at the back of the objective when daylight and a plane mirror are used.

condensers by the method shown in fig. 347. But when the microscope is of necessity used upright the rectangular prism or the plane mirror must be used, fig. 348.

The arrangement at fig. 356 is sometimes useful for photomicrography when it is *otherwise impossible* to illuminate the whole field. But in ordinary cases it is better to contract the field than use a bull's-eye, as it invariably impairs the definition.

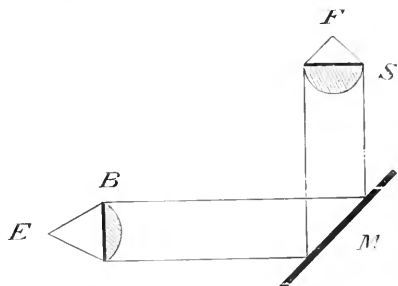

FIG. 356.—Illumination for dark ground (with stop beneath the condenser).

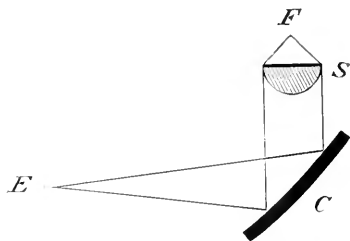

FIG. 357.—Same result with concave mirror.

In regard to this last figure it will be understood that (as before) E represents the edge of the flame, B the bull's-eye, M the mirror, S the condenser under the stage, and F the plane of the object.

The same result as the above may be obtained by the concave mirror (as shown in fig. 357) instead of the bull's-eye. But this is a very difficult arrangement, yielding the best results only with great application and care.

But the supreme folly of using a concave mirror *and* a bull's-eye

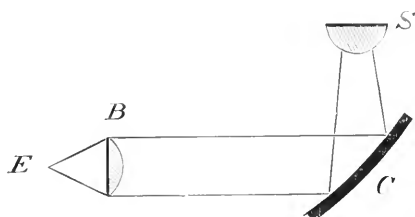

FIG. 358.—Absurdity of using a bull's-eye and a concave mirror.

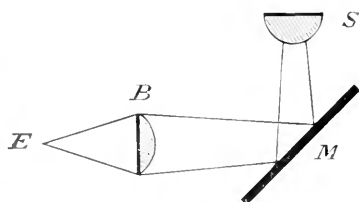

FIG. 359.—Absurdity of using a bull's-eye with the edge of the lamp flame not in its principal focus.

is shown in fig. 358, where C is the concave mirror and (as before) S the sub-stage condenser; this secures a result—as will be seen by the relation of the light to the condenser (S)—which is as far from what is sought and desirable as it can well be, while another lesson of great importance may be learnt from fig. 359, which illustrates *the error of not having the edge of the flame E in the principal focus of the bull's eye B*. The rays converge on the condenser S, so that it will become in all probability impossible to focus it on the

object. This is a lateral lesson on the value of having the bull's-eye fixed to the lamp, so that both may be moved together; and there *should* be a notch in the slot or arm which carries the bull's-eye to denote when the flame of the lamp is in its principal focus.

The above are fundamental principles of illumination, and if the student is to succeed as a manipulator he must demonstrate and redemonstrate them, and become master of their details and what they collaterally teach.

We may, however, with much advantage give them a larger and more detailed application to the practical setting up of a dark-ground illumination, as in fig. 356.

Let an object such as a *triceratium* (diatom) be taken, and suppose that the objective employed is a $\frac{2}{3}$ -inch of $\cdot 28$ N.A. We must first adjust the lamp and bull's-eye, as in fig. 344, and get the edge of the lamp flame extended to a disc as at A.

Now let a small aperture be put into the condenser and a *triceratium* on the stage and the $\frac{2}{3}$ objective on the nose-piece.

The microscope being put into position, the lamp should be placed on the left-hand side of it—a lamp with a fixed bull's-eye is

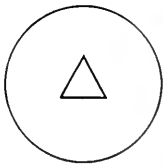

FIG. 360.



FIG. 361.

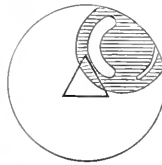

FIG. 362.



FIG. 363.

assumed—and it should now be arranged as to height, so that the rays from the bull's-eye should fall fairly on the plane mirror, this latter being inclined so as to reflect the beam on the back of the sub-stage condenser.

Now, with any kind of light, focus, and place in the centre of the field, the *triceratium*, as in fig. 360; then rack the condenser until the small aperture in its diaphragm comes into focus; centre this to the *triceratium*, as in fig. 361. Rack the condenser closer up until the bull's-eye is in focus, as in fig. 362.

Here it happens that the bull's-eye is not in the centre, and it is *not uniformly filled with light, but has instead two crescents of light.*

This is a case which frequently repeats itself, but it is of course not inevitable. The bull's-eye may be more or less filled with light, and may or may not be more nearly centred. In this case we have next to centre the image of the bull's-eye to the *triceratium* by moving the mirror, as in fig. 363.

But it will be noticed that this centring of the image of the bull's-eye *does not rectify the diffusion of the light.* This will be at once done by moving the lamp with attached bull's-eye: this motion requires to be a kind of rotation in azimuth round the wick as an axis. *The relative positions of the lamp and bull's-eye must on no*

account be altered, and it is understood that the lamp was adjusted to the picture A in fig. 344 by inspection and without the microscope. A very slight movement in azimuth, however, is enough to effect the desired end (fig. 364), and all that now remains is to open the full aperture of the condenser and put in the smallest stop; if this does not stop out all the light, a larger one must be tried; but it is of the greatest importance that the smallest stop possible be used, a very little difference in the size of the stop making a remarkable difference in the quality of the picture. Hence the need of a large and varied supply of stops with all condensers.

On account of some residual spherical aberration the condenser will probably have to be racked up slightly to obtain the greatest intensity of light.

In fig. 364 the expanded edge of the flame covers the *triceratium*. When the whole aperture of the condenser is opened the size of that disc will not be altered, its intensity only will be increased. When the stop is placed at the back of the condenser, only in that part of the field represented by the disc of light will the object be illuminated on a dark ground. If, therefore, the disc of light does not cover the object or objects, bring the lamp nearer the mirror. The size of the disc of light depends on three things:—



FIG. 364.

a. The diameter of the bull's-eye.

β . The length of the path of the rays from the bull's-eye to the sub-stage condenser.

γ . The magnifying power of the condenser.

If α and γ are constants, the only way of varying the size of the dark field is by β .

In the same way the intensity of the light in the disc depends on three things.

A. The initial intensity of the illumination.

B. The angular aperture of the bull's-eye.

C. The angular aperture of the sub-stage condenser.

If the student will thoroughly and practically understand the above series of single demonstrations, and ponder such inevitable variations as practice will bring in regard to them, the 'difficulties of illumination' will have practically passed away.

There are two kinds of microscopical work—one, the more usual and comparatively easy, is the examination of an object to see *something which is known*. The other is the examination of an object in search of the unknown. Thus some blood may be examined for the purpose of finding a white corpuscle. It matters little what is the quality of either the lens or the illumination or the microscope, or whether the room is darkened or not, because the observer knows that there is such a thing as a white corpuscle. It is quite immaterial as to whether the observer had ever seen one or not; so long as he possesses the knowledge that there is such a thing, the finding of it, even under unfavourable conditions, will be an easy task.

But if the observer has not that knowledge, he may examine

blood many times, under favourable conditions, and yet not notice the presence of a white corpuscle, and that, too, with one immediately in the centre of the field; this, moreover, is a large object.

It is only those in the habit of searching for new things who can appreciate the enormous difficulty in first recognising a new point. Therefore, when critical work is undertaken, care should be exercised to have the conditions as favourable as possible.

When working with artificial light all naked lights in the room should be avoided.

It is quite unreasonable to expect the retina to remain highly sensitive if, whenever the eye is removed from the eye-piece, it is exposed to the glare of a naked gas flame.

At the same time there should be ample light on the microscope table, as it is not at all necessary or desirable that the work should be insufficiently illuminated. All that is required is that the lamps should have shades and be placed at such a height that the direct rays do not enter the observer's eye.

If these precautions are taken, several hours' continued work may be carried on without any injurious effect.

Some observers use only the left eye, some the right, others the right or left indiscriminately.

It seems immaterial which is used, it being merely a matter of habit, as those who are accustomed to use one particular eye feel awkward with the other. In continuous work, extending over many months of long daily observation, if the eye has been accustomed to monocular vision, even with high powers, there is no difficulty experienced. The effect of years of work with optical instruments on those possessed of strong normal sight seems to be an increase in the defining perception accompanied by a decrease of the perception of brightness. Those accustomed to use one particular eye with microscopical work, and who have done much work, would, if they looked at, say, the moon with that eye, see more detail in it than if the other eye were used: at the same time it would not appear as bright.

If there is too much light, as there often is, when large-angled illuminating cones are used, it is as well to interpose between the lamp and the microscope a piece or pieces of signal green glass: this softens the light and removes the objectionable yellowness, a feature of illumination not due to the light from the edge of a paraffin lamp, which, as we have stated, is not particularly yellow. *Great yellowness* is a sign of *imperfect achromatism* in an objective. We may with precisely the same conditions find the images yielded by two objectives of the same power and aperture differ, in so much as one is yellow and dim and the other white and bright: other things being equal, the white and bright image is to be preferred. It is necessary to say 'other things being equal,' because an objective which gives a bright and a white image may nevertheless be inferior to the one giving the yellow and dim picture. Thus if the planes of the lenses of which the objective is composed are not at right angles to the optic axis there will be serious defects in the image, although it is bright and white. This fault is known in practice as

an error of centring, which also means the error of not placing the axes of the lenses in the same straight line; so both faults are described by the same term.

It should be understood that signal green glass will not yield monochromatic illumination; only the Gifford screen or the filter-screen of Prof. Miethe (*q.v.*) or the Nelson spectroscopic arrangement (*q.v.*) can be of real service.

Coloured light derived from a polariscope and a selenite is not monochromatic.

For critical work, such as testing lenses or forcing out the greatest resolution with the widest-angled oil-immersion lenses, daylight illumination is inadmissible.

When daylight illumination is used, a northern aspect, or at least one away from direct sunlight, is to be preferred.

It is a good plan, where it is possible, to arrange the table so that the window is at the observer's left hand. The microscope should be placed in a direction parallel to the window, and the light reflected by the mirror through a right angle. A screen may be placed parallel to the window which just allows the mirror of the microscope to project beyond it. This cuts off direct light from the stage and from the observer's eyes.

A concave mirror with the object in its principal focus is the best for diffused daylight illumination. The diaphragm should not be close to the stage. When delicate microscopical work is carried on, it is important to remember that the human eye can work best when the body is in a state of ease. If there is any strain on the muscles of the body, or if the observer is in a cramped position, vision will be impaired. Consequently, where permissible, a microscope should always be *inclined*, and the observer seated in such a way that the eye can be brought to the eye-piece in a perfectly natural and comfortable manner. The body should also be steadied by resting the arms on the table.

It is advisable to use the bull's-eye as little as possible; *even with dark-ground illumination* the flat of the flame is preferable, reserving the bull's-eye for those cases where the flat of the flame will *not cover* enough of the object. Generally speaking, if the whole field is required to be illuminated on a dark ground, a bull's-eye will be necessary; but for an object such as a single diatom the flat side of the lamp flame will usually be large enough.

In examining diatoms or other objects, such as the karyokinetic figures in very minute nuclei of microscopic organisms, or other obscure and undetermined parts of such forms of life, it is most important, amongst other means, to resort to the use of large solid cones; what they teach and suggest can scarcely be neglected by the searcher for the unknown. Professor Abbe does not advise their employment as in any way final; he says that 'the resulting image produced by means of a broad illuminating beam is always a mixture of a multitude of partial images which are more or less different and dissimilar from the object itself;' and he does not conceive that there is any ground for expectation 'that this mixture should come nearer to a strictly correct projection of the object . . . than the image which

is projected by a narrow axial illuminating pencil.' This is a weighty judgment, and should receive full consideration. At the same time the use of wide and solid cones is so full of suggestive results that we must employ them with all possible control by other means of the images they present. This is the more a necessity since Mr. Nelson has been able to obtain the most wonderful results with narrow cones, 'true ghosts' and 'false ghosts,' the presence of 'intercostal markings' in the image of a fly's eye (!), and many complex and false images with the coarser diatoms. But with wide cones he has proved that these false images *cannot* be produced; and that when the true image is reached by a wide cone, the image is not altered by any change of focus, but simply fades in and out of focus 'as a daisy under a 4-inch objective.'

Mr. Nelson has photographed all these results,¹ and we have seen them demonstrated. When theory and practice are thus at variance we must pause for further light.

If it is required to accentuate a known structure, *such as the perforated membrane of a diatom*, it can be done by annular illumination, which means the same arrangement as for dark ground, but with a stop insufficiently large to shut out all the light. This method is not to be recommended when a structure is unknown, as it is also liable to give false images. It must be remarked that diatom and other delicate structure, when illuminated with a *narrow-angled cone*, gives on slight focal alterations a *variety* of patterns like a kaleidoscope; with a wide-angled cone a single structure gives a single focus, *i.e.* it goes completely out of focus on focal alteration. When a large-angled and a wide-angled objective are used a change of pattern only occurs when the structure is fine. This practical observation has its value, and must not be forgotten.

To properly display objects under a microscope is to a certain extent an art, for it not only demands dexterity in the manipulation of the instrument and its appliances, but it also requires knowledge of what sort of illumination is best suited to the particular object. At this point we think it advisable, especially in the interests of beginners, to clearly point out the best method of commencing microscopic work by centring the condenser and arranging the light for the critical examination of an object.

1st. Place a power of about a $\frac{2}{3}$ on the nose-piece, and a B or No. 2 eye-piece in the tube.

2nd. Use as a source of illumination the light from a paraffin lamp with a $\frac{1}{2}$ -inch wick.

3rd. Place any suitable object on the stage, and, having focussed it with any kind of illumination, centre it to the field of the eye-piece.

4th. Place a small diaphragm beneath the sub-stage condenser, or close the iris.

5th. Rack the condenser until the hole in the diaphragm is in focus (in the plane of the object).

6th. If the hole in the diaphragm should not be central to the

¹ *Journ. R. M. S.*, 1891, p. 90, pl. II.

object on the stage, it must be centred by means of the sub-stage adjusting screws.

7th. Rack up the condenser until the image of the flame comes into focus.

8th. Centre the image of the flame to the object on the stage by moving the position of the lamp, and place the lamp so that the edge of the flame is presented. In performing this adjustment the sub-stage centring screws must on no account be moved. (If a mirror is employed, the centring of the image of the flame upon the object can be effected by moving the mirror.)

9th. The object to be examined may now be substituted for that used for centring purposes, and be placed in the image of the edge of the flame.

10th. The objective by which the object is to be examined is placed on the nose-piece and the object brought into focus.

11th. The eye-piece is removed and the back lens of the objective is examined. The diaphragm at the back of the condenser is then altered so that three-fourths of the back lens of the objective is filled with an unbroken disc of light.

12th. The eye-piece is replaced and the objective brought into adjustment either by screw collar or by altering the tube length.

13th. If it is necessary at any time to use a large field for a rough survey of an object, or to localise any particular portion of an object, all that is necessary is to rack down the condenser until the whole field becomes illuminated; but when any part requires critical examination the condenser must be racked up again and the image of the edge of the flame focussed on the object.

For learning the manipulation of the instrument no class of objects are as suitable as diatoms; they are also an excellent means of training the eye to appreciate critical images. For a general view of the larger diatoms take a spread slide in balsam; a $\frac{1}{6}$ of 80°, a good binocular, and a dark-ground illumination will give a fine effect. This is not merely a pretty object, but it is also a very instructive one, because we obtain a far clearer idea of the contour of various diatoms than can be obtained in any other way. The diatoms should be studied and worked at in this manner most carefully and for a long time. The same identical specimens should be then viewed with transmitted light. This lesson, if conscientiously learnt, will teach a student how to appreciate form by focal alteration. This is a most important lesson, and, if several days are spent in mastering it, they will be far from thrown away. Diatoms, especially the larger forms, are seen very well *when mounted dry on cover* by means of a $\frac{1}{4}$ -inch objective and a *Lieberkühn*; the bull's-eye and the plane mirror should be used. Some objects are so transparent, or become so transparent in the medium in which they are mounted, that they will not bear a large illuminating cone, the brightness of the illumination destroying the contrast. It will illustrate this when we recall that dirt on an eye-piece which is quite invisible in a strong light becomes immediately apparent in a feeble light. Thus animalcules require a small cone of illumination when they are being examined, particularly with a $\frac{1}{4}$ -inch objective; for a general view of 'pond life' a $\frac{1}{2}$ -inch

objective with a dark-ground illumination, employing a binocular, is very suitable. Stained bacteria in tissue are best seen with a *large cone*, as was pointed out by Dr. Robert Koch, and is directly supported by Dr. Abbe as suitable in his directions for the use of the Abbe condenser.¹ The brilliancy of the illumination obliterated the thin tissue which is in a medium whose refractive index is similar to itself. The bacteria, which are opaque with pigment, then stand out boldly. A bacterium not in tissue is always better seen by means of a large cone, provided that the objective is properly corrected. The very minute hairs on the lining membrane of the blow-fly's tongue, if examined by a $\frac{2}{3}$ objective and a narrow cone, appear thickened, shorter, more blunted, and often split into two parts. This is shown in figs. 2 and 3 in the frontispiece. Fig. 3 is a critical image magnified 510 diameters. A lens should be used to examine this.

It will be seen that the hairs, especially the long central one, are very fine and spinous. They have not the ring socket common to insect hairs, but grow directly from a delicate membrane.

This photograph was taken with an apochromatic $\frac{1}{2}$ of .95 N.A. and No. 3 projection eye-piece: and it was illuminated by means of a large solid cone of .65 N.A. from an achromatic condenser.

Fig. 2 is an uncritical image, with all the conditions as above, save that a cone of small angle, *i.e.* of 0.1, was used for illumination.

The first alteration which thrusts itself upon the eye is the *doubling* of the hairs which are in the least degree out of focus. But, further, it will be noted that there is a bright line with a dark edge round the hairs which are precisely in focus; this is a diffraction effect, always, in our experience, present in objects illuminated by cones of insufficient angle, and it can be easily made to disappear by widening the cone. As the illuminating cone is enlarged they become sharper and longer, and their edges become more definite. But nothing is gained, but rather a distinct loss is incurred, by making the illuminating cone much larger than three-fourths of the objective cone.

As an example of erroneous interpretation, the representation of the pygidium of a flea by some leading sources of information of a few years ago may be instanced. It was a special test of many authors, and has been carefully figured; this shows that it is not an accidental error, which it might have been if it were merely an ordinary object; it is an error depending in all probability on a faulty system of illumination. Moreover, the error cannot be attributed to the object-glasses of the time, as it is a low-power object, and the low powers of that day were quite as good as those lately in use. In the descriptions and in the drawings, often beautifully executed, the hairs proceeding from the centre of the wheel-like discs are represented as being 'stiff' and longish bristles, thick at one end and tapering off to a point. And the small hairs round are described as 'minute spines'; in the drawing they are like the spinous hairs of an insect, and have the usual socket-joint at the

¹ Directions for the Use of Abbe's Illuminating Apparatus—a leaflet issued by Carl Zeiss, 1888.

base. In reality the 'stiff and longish bristle' is an extremely long and delicate filament, totally unlike a bristle, being not tapered but of nearly uniform thickness. The 'minute spines' are in reality very curious hairs, and, as far as we at present know, unlike any others. They are delicate, lambent, bulbous hairs. What they most resemble are the tentacles of a sea-anemone, and there are two tubes discoverable which are important and comparatively large objects. There appears to be considerable probability that this interesting object upon the last ring of the body of the flea, and known as its 'pygidium,' acts as an auditory instrument.¹ In the examination of ordinary stained histological and pathological sections by transmitted light, unless some very delicate point is sought, the condenser should have a stop, so that when the back of the objective is examined the stop is seen cutting into the back of the objective by about a third. This in some instances may be increased to a half by diminishing the cone, but it is not advisable to use anything less than a half unless it is absolutely necessary. As we have pointed out above, high-class objectives will stand a $\frac{3}{4}$ cone perfectly, and very special objectives will bear even a $\frac{2}{3}$ cone; but for the ordinary run of objectives $\frac{2}{3}$ will be found as much as they are able to bear—some indeed will not stand a $\frac{1}{2}$ cone. Thus, to put it in round numbers, an illuminating cone '2 N.A. is very suitable for ordinary work with the apochromatic 1-inch and $\frac{2}{3}$ objectives, and one of '4 N.A. for the $\frac{1}{2}$ and $\frac{1}{3}$, and one of '6 N.A. for the $\frac{1}{4}$ and $\frac{1}{6}$. It is a good plan to have one or two stops cut to give special cones, the N.A. of which should be engraved on them. This subject is one of great importance, as more than nine-tenths of all microscopic objects are examined by means of transmitted light.

Let us now note the effect of large cones on the simplest object. A microscope is set up having an achromatic condenser with an iris diaphragm; let three good wide-angled objectives be chosen, say 1-inch, a $\frac{1}{2}$ -inch, and $\frac{1}{4}$ -inch dry. Let the object be the one we have already studied to some extent in this relation, viz. one of the stiff hairs on the maxillary palpus of the blow-fly's tongue; place the 1-inch on the nose-piece, open the full aperture of the condenser and get the instrument into perfect adjustment. Now close the iris. The hair will be surrounded by a luminous border, which will give it a glazy appearance, and its fine point will be blurred out. Now open the iris until the last trace of that glaziness disappears. The hair will appear as a different object, its outline being perfectly clear and sharp. If the eye-piece is removed, about two-thirds of the objective back will be full of light. Now, without disturbing any of the adjustments, replace the 1-inch by the $\frac{1}{2}$, and it will be found that the glaziness or false light will have returned. Let the iris be further opened until the last trace of it disappears; now, on examination of the back of the objective, two-thirds of it will be found full of light, and so on with the $\frac{1}{4}$. We call the attention of the student to these facts as having a direct bearing upon the question of the comparative effects of large and small illuminating cones, and

¹ *Microsc. Journ.*, April 24, 1885: 'Pygidium of Flea' (E. M. Nelson).

with no idea of offering opposing opinions to those of Professor Abbe; we have no direct judgment, but we record these facts as factors in and for the elucidation of the question. It is perhaps better to test the $\frac{1}{4}$ on some of the more minute hairs which are studded over the delicate lining membrane. The same results will be obtained. Thus it would appear to suggest itself that this glaziness depends on the *relation of the aperture of the illuminating cone to that of the objective cone*. Apochromatic objectives behave precisely as achromatic objectives in this respect. Of course, if the hair becomes pale and indistinct on the opening of the iris, it shows that there is uncorrected spherical aberration in the objective; another objective must therefore be used; that paleness has nothing whatever to do with the glaze or false light mentioned above.

In photo-micrographs of bacteria one frequently sees a white halo round them. We have never been able to demonstrate what this is: sometimes it denotes the presence of an envelope, and sometimes it is the result of the use of too small a cone of illumination. Photo-micrography with a small cone is quite easy, as great contrast can be secured. With a large cone the difficulties begin—difficulties of adjustment, difficulties of lens correction, difficulties of exposure, and difficulties of development. If, so far as our experience goes, a good photo-micrograph is required, these difficulties must be mastered.

It is hardly necessary to remind the student that in micrometry it is essential that the edges of the object should be defined; consequently a large cone *must* then be employed.

For the examination of Polycystines, Foraminifera, &c., a binocular is useful; illumination may be by a Lieberkühm if mounted dry, and by dark ground by a condenser if mounted in balsam. Parts of insects should be usually examined with dark-ground illumination; whole insects are seen best with the Lieberkühm, and the binocular should be used for both.

Some of this class of objects are best seen under *double illumination*; that is, a *dark ground with a condenser* and light *thrown from above with a silver side-reflector*, as the Lieberkühm cannot be used in conjunction with an achromatic condenser. It is a good plan with low-power Lieberkühm work to interpose between the slip and the ledge a strip of plain glass $\frac{1}{2}$ -inch wide; *this prevents the ledge stopping out light* from the Lieberkühm when it is larger in diameter than the slip. Mr. Julius Rheinberg has recently brought to a high state of perfection a system of colour illumination, and the special importance of the choice of suitable colours. It is of much interest, but cannot be condensed in the space at our disposal. The full paper will be found illustrated in 'Journ. R.M.S.' 1896, p. 373, and the 'Journ. R. M. S.' for 1899, p. 142.

Polarised light used with a condenser is very useful for insect work. For very low-power work—such as the usual botanical sections—it is a good plan to give up the cone, and place a piece of fine ground glass at the back of the condenser; and with lamplight it is as well to use a Gifford's screen with it. With objectives of greater angle than 6 N.A. it is usually difficult to get satisfactory illumina-

tion with a dark ground. The best that can be done is to use an oil-immersion condenser with a suitable stop; this will give a good dark ground up to .65 N.A., but it will fail if the object is dry on the cover. Generally speaking, the only way of accomplishing this with objectives of wider aperture is to reduce the aperture of the objective by a stop placed at the back.

When a condenser is united by a film of oil to a slip, *if the slip is thin, the oil invariably runs down when the condenser is focussed.*

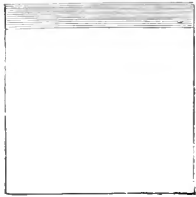

Thin slip of glass with ledge to place glass slip with oil contact, so as to vary the thickness of a slide.



Slide *in situ* on thin slip with ledge.

FIG. 365.

The following is a method by which this may be entirely prevented. A piece of thick cover-glass about .02 inch, and 1 inch square, has a strip of thicker glass, $\frac{1}{8}$ inch broad, cemented by shellac to one edge. This piece of glass is oiled to the slip, the ledge being hooked over the top of the slide; this not only prevents its slipping down, but also keeps the oil from creeping out at the bottom,

which would be the case if the two edges of the glass coincided.¹ This is illustrated in fig. 365.

In its proper place we have dealt with the suitable relation of aperture to power, and have pointed out the irresistible nature of the contentions and teachings of Abbe on the subject. Here a direct practical presentation of the matter may be of service to the student.

A normal unaided human eye can divide $\frac{1}{250}$ inch at ten inches. Consequently a microscope with a power of 200 should be capable of showing structure as fine as $\frac{1}{50,000}$ inch. Now, as this power can be made up by $\frac{1}{2}$ -inch objective and a 1-inch eye-piece, it follows that sufficient aperture ought to be given to the $\frac{1}{2}$ -inch to enable it to resolve 50,000 lines per inch. This² will be .52 N.A. The inch objective should have half this aperture, and the $\frac{1}{2}$ double, and the $\frac{1}{8}$ four times as much, if perfect vision is required; in other words, .26 N.A. for every 100 diameters.³ These ideals have (as we have before indicated) been realised, notably by the Zeiss apochromatics, the 1-inch and the $\frac{1}{2}$ -inch⁴ resolving everything capable of being appreciated by the eye when the 12 compensating eye-piece is used. The $\frac{1}{2}$ -inch is also a near approach to the ideal, as it has been very wisely kept a dry lens. The oil-immersion $\frac{1}{8}$ -in. of 1.4 N.A. with a 6 eye-piece also attains the ideal. This relation of aperture to

¹ *Q. M. C. Journal*, November 1885.

² In reality it will require more, because an axial cone is assumed to be used instead of an oblique beam.

³ *English Mechanic*, vol. xxxviii, 1883, No. 979.—E. M. Nelson.

⁴ This lens, with an 8 compensating eye-piece, will resolve a *Pleurosiqma maculatum* with an axial cone; this is the lowest power with which it has ever been done.

power is very significant, and should be carefully pondered by those who still desire low apertures as the only perfect form of objectives.

It is as well to mention that objectives may be arranged in two series—one the 2, 1, $\frac{1}{2}$, $\frac{1}{4}$, and $\frac{1}{8}$, the other $1\frac{1}{2}$, $\frac{2}{3}$, $\frac{1}{3}$, $\frac{1}{6}$, $\frac{1}{12}$. One of these series will form a complete battery, as it is unnecessary to have objectives differing from the next in the series by less than double the power.

The most usual combination is perhaps the 1 and the $\frac{1}{4}$ of one series, or the $\frac{2}{3}$ and the $\frac{1}{6}$ of the other. Of these two preference might rather be given to the latter. The only exception would be the addition of a $1\frac{1}{2}$ -inch for pond life.

Eye-pieces should also double the power thus: 5, 10, and 20 (uncompensated), or 6, 12, and 27 (compensated), the most useful of the three being the 10 (uncompensated) and the 12 (compensated). As there is no 6-power uncompensated eye-piece for the long tube, a 4 for the short tube admirably answers the purpose.

In addition to the explanations already given on the subject of testing objectives, it may be useful here to note that the qualities of an objective are seven in number:—

1. Magnifying power (initial).
2. Aperture or N.A.
3. Resolving power.
4. Penetrating power.
5. Illuminating power.
6. Flatness of field.
7. Defining power.

1. *Magnifying power*.—No test is required, as the initial magnifying power can be directly measured.

2. *Aperture* or N.A. can be directly measured: no test is therefore necessary.

3. *Resolving power*.—A lens illuminated by a large solid axial cone, when a Gifford's screen is used, should resolve a number of lines to the inch expressed by its N.A. multiplied by 80,000.¹

4. *Penetrating power* is the reciprocal of the resolving power of $\frac{1}{\text{N.A.}}$. No test needed, but penetrating power varies largely with the combined magnifying power, and also with the *magnitude of the illuminating cone* used, as already intimated.

5. *Illuminating power* is the square of the numerical aperture (N.A.)². No test is necessary, but the remarks made above in regard to penetrating power apply equally here.

6. *Flatness of field* is, in the strict meaning of the term, an optical impossibility. The best thing therefore is to contract the visible field, as is done in the compensating eye-pieces. (Tests: For low powers a micro-photograph; for medium and high powers a stage micrometer.)

7. *Defining power* depends on (a) the reduction of spherical aberration, (b) the reduction of chromatic aberration, (c) the perfect centring of the lenses—by which is meant (i.) the alignment of

¹ *J.R.M.S.* 1893, p. 15.—E. M. Nelson.

their optic axes, (ii.) the parallelism of their planes, (iii.) the setting of their planes at right angles to the optic axis.

Defining power can only be tested by a critical image. The following is a list of suitable objects of which a critical image is to be obtained, using a solid axial cone of illumination equal to at least three-fourths of the aperture of the objective.

Very low powers (3-, 2-, and $1\frac{1}{2}$ -inch).—Wing of *Agriion pulchellum* ♂ (dragon-fly).

Low powers (1 and $\frac{2}{3}$).—Proboscis of blow-fly. Large diatoms on dark ground.

Medium powers ($\frac{1}{2}$, $\frac{1}{10}$, $\frac{1}{3}$, and low-angled $\frac{1}{4}$).—Minute hairs on proboscis of blow-fly; hair of pencil-tail (*Polytenus lugurus*); diatoms on a dark ground. This last is a most sensitive test; unless the objective is good there is sure to be false light.

Medium powers (with wide aperture).—*Pleurosigma formosum*; *Navicula lyra* in balsam or styrax; *Pleurosigma angulatum* dry on cover; bacteria and micrococci stained.

High powers (wide aperture and oil-immersion $\frac{1}{8}$ and $\frac{1}{12}$).—The secondary structure of diatoms, especially the fracture through the perforations; *Navicula rhomboides* from Cherryfield in balsam or styrax; bacteria and micrococci stained.

Test with a 10 or 12 eye-piece, and take into account the general whiteness and brilliancy of the picture.

The podura scale is not mentioned as a test, as it may be very misleading in unskilled hands. One great point in testing objectives is to know your object. Care must be exercised to ascertain by means of vertical illuminator if objects such as diatoms dry on the cover are in optical contact with the cover-glass. Testing objectives is an art which can only be acquired in time and with experience gained by seeing large numbers of objectives.

In the manipulation of the microscope it is not uncommon to observe the operator *rolling* the milled head of the *fine adjustment* instead of firmly grasping it between the finger and thumb and governing, to the minutest fraction of arc, the amount of alteration he desires. It is undesirable and an entirely inexpert procedure to roll the milled head, and cannot yield the fine results which a delicate mastery of this part of the instrument necessitates and implies. To use aright the fine adjustment of a first-class microscope is not the first and easiest thing mastered by the tyro. We have already intimated that the fine adjustment should never be resorted to while the coarse adjustment can be efficiently employed. The focus should always be found, even with the highest powers, by means of the coarse adjustment. It is only a clumsy microscopist who brings his objective by means of the coarse adjustment near the cover-glass and looks at the distance he is off it either by the eye or by the aid of a hand magnifier, and then completes his work with the fine adjustment. In every case the focus ought to be found by the coarse adjustment, and the working distance should be *felt* by the finger tilting the slide gently against the front of the objective. Also the examination of objects for depth of structure with low and medium powers up to the dry $\frac{1}{4}$ - or $\frac{1}{6}$ -inch objective should be performed by

the coarse adjustment; only the very finest details, such as the podura 'exclamation' marks, require the fine adjustment.

Beyond the correct and judicious use of the microscope and all its appliances, there is the matter of the *elimination of errors of interpretation* to be carefully considered.

The correctness of the conclusions which the microscopist will draw regarding the nature of any object from the visual appearances which it presents to him when examined in the various modes now specified, will necessarily depend in a great degree upon his previous experience in microscopic observation and upon his knowledge of the class of bodies to which the particular specimen may belong. Not only are observations of *any* kind liable to certain fallacies arising out of the previous notions which the observer may entertain in regard to the constitution of the objects or the nature of the actions to which his attention is directed, but even the most practised observer is apt to take no note of such phenomena as his mind is not prepared to appreciate. Errors and imperfections of this kind can only be corrected, it is obvious, by general advance in scientific knowledge; but the history of them affords a useful warning against hasty conclusions drawn from a too cursory examination. If the history of almost *any* scientific investigation were fully made known, it would generally appear that the stability and completeness of the conclusions finally arrived at had only been attained after many modifications, or even entire alterations, of doctrine. And it is therefore of such great importance as to be almost essential to the correctness of our conclusions that they should not be finally formed and announced until they have been tested in every conceivable mode. It is due to science that it should be burdened with as few false facts and false doctrines as possible. It is due to other truth-seekers that they should not be misled, to the great waste of their time and pains, by our errors. And it is due to ourselves that we should not commit our reputation to the chance of impairment by the premature formation and publication of conclusions which may be at once reversed by other observers better informed than ourselves, or may be proved to be fallacious at some future time, perhaps even by our own more extended and careful researches. The *suspension of the judgment whenever there seems room for doubt* is a lesson inculcated by all those philosophers who have gained the highest repute for practical wisdom; and it is one which the microscopist cannot too soon learn or too constantly practise. Besides these general warnings, however, certain special cautions should be given to the young microscopist with regard to errors into which he is liable to be led even when the very best instruments are employed.

Errors of interpretation arising from the imperfection of the *focal adjustment* are not at all uncommon amongst microscopists, and some of the most serious arise from the use of small cones of illumination. With lenses of high power, and especially with those of large numerical aperture, it very seldom happens that all the parts of an object, however minute and flat it may be, can be in focus together; and hence, when the focal adjustment is exactly made for one part, everything that is not in exact focus is not only

more or less indistinct, but is often wrongly represented. The indistinctness of outline will sometimes present the appearance of a pellucid border, which, like the diffraction-band, may be mistaken for actual substance. But the most common error is that which is produced by the reversal of the lights and shadows resulting from the refractive powers of the object itself; thus, the biconcavity of the blood-discs of human (and other mammalian) blood causes their centres to appear *dark* when in the focus of the microscope, through the divergence of the rays which it occasions; but when they are brought a little within the focus by a slight approximation of the object-glass the centres appear brighter than the peripheral parts of the discs. The student should be warned against supposing that in all cases the most *positive* and *striking* appearance is the truest, for this is often not the case. Mr. Slack's *optical illusion, or silica-crack slide*,¹ illustrates an error of this description. A drop of water holding colloid silica in solution is allowed to evaporate on a glass slide, and when quite dry is covered with thin glass to keep it clean. The silica deposited in this way is curiously cracked, and the *finest* of these cracks can be made to present a very positive and deceptive appearance of being raised bodies like glass threads. It is also easy to obtain diffraction-lines at their edges, giving an appearance of duplicity to that which is really single.

A very important and very frequent source of error, which sometimes operates even on experienced microscopists, lies in the refractive influence exerted by certain peculiarities in the internal structure of objects upon the rays of light transmitted through them, this influence being of a nature to give rise to appearances in the image, which suggest to the observer an idea of their cause that may be altogether different from the reality. Of this fallacy we have a 'pregnant instance' in the misinterpretation of the nature of the *lacuna* and *canaliculi* of bone, which were long supposed to be solid corpuscles with radiating filaments of peculiar opacity, instead of being, as is now universally admitted, minute chambers with diverging passages excavated in the solid osseous substance. When Canada balsam fills up the excavations, being nearly of the same refractive power as the bone itself, it obliterates them altogether. So, again, if a person who is unaccustomed to the use of the microscope should have his attention directed to a preparation mounted in liquid or in balsam that might chance to contain *air-bubbles*, he will be almost certain to be so much more strongly impressed by the appearances of these than by that of the object, that his first remark will be upon the number of strange-looking black rings which he sees, and his first inquiry will be in regard to their meaning.

Although no experienced microscopist could now be led astray by such obvious fallacies as those alluded to, it is necessary to notice them as warnings to those who have still to go through the same education. The best method of learning to appreciate the class of appearances in question is the comparison of the aspect of globules of oil in water with that of globules of water in oil, or of

¹ *Monthly Microscopical Journal*, vol. v. 1872, p. 14.

bubbles of air in water or Canada balsam. This comparison may be very readily made by shaking up some oil with water to which a little gum has been added, so as to form an emulsion, or by simply placing a drop of oil of turpentine (coloured with magenta or carmine) and a drop of water together upon a slide, laying a thin glass cover over them, and then moving the cover backwards and forwards several times on the slide. Equally instructive are the appearances of an air-bubble in water and Canada balsam.

The figures which illustrate the appearance at various points

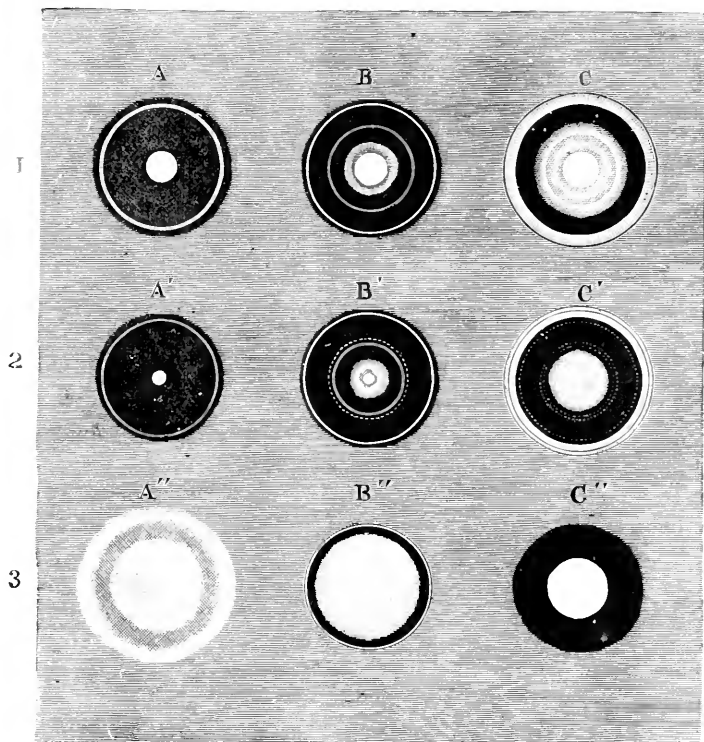

FIG. 366.—Air-bubbles in (1) water; (2) Canada balsam; (3) fat-globules in water.

of the focus of an air-bubble in water and Canada balsam, and of a fat-globule in water, may be thus illustrated, viz. a diaphragm of about $\frac{2}{3}$ of a mm. being placed at a distance of 5 mm. beneath the stage, and the concave mirror exactly centred.

Air-bubbles in water.—No. 1 (fig. 366) represents the different appearances of an air-bubble in water. On focussing the objective to the middle of the bubble (B), the centre of the image is seen to be very bright—brighter than the rest of the field. It is surrounded by a greyish zone, and a somewhat broad black ring interrupted by one

or more brighter circles. Round the black ring are again one or more concentric circles (of diffraction), brighter than the field.

On focussing to the bottom of the bubble (A) the central white circle diminishes and becomes brighter; its margin is sharper, and it is surrounded by a very broad black ring, which has on its periphery one or more diffraction circles.

When the objective is focussed to the upper surface of the bubble (C) the central circle increases in size, and is surrounded by a greater or less number of rings of various shades of grey, around which is again found a black ring, but narrower than those in the previous positions of the objective (A and B). The outer circles of diffraction are also much more numerous.

Air-bubbles in Canada balsam.—Canada balsam being of a higher refractive index than water, the limiting angle, instead of being $48^{\circ} 35'$, is 41° only, so that the rays which are incident much less obliquely on the surface of separation undergo total reflexion, and it will be only those rays which face very close to the lower pole of the bubble that will reach the eye, and the black marginal zone will therefore be much larger. This is shown in fig. 366, No. 2.

When the objective is focussed to the bottom of the bubble (A'), we have a small central circle, brighter than the rest of the field, all the rest of the bubble being black, with the exception of some peripheral diffraction rings. On focussing to the centre (B') or upper part (C') of the bubble, we have substantially the same appearances as in B and C, with the exception of the smaller size of the central circle.

Fat-globules in water (fig. 366, No. 3).—These illustrate the case of a highly refracting body in a medium of less refractive power.

When the objective is adjusted to the bottom of the globule A'', it appears as a grey disc a little darker than the field, and separated from the rest of the field by a darkish ring.

Focussing to the middle of the bubble (B''), the central disc becomes somewhat brighter, and is surrounded by a narrow black ring, bordered within and without by diffraction circles.

On further removing the objective the dark ring increases in size, and when the upper part of the bubble is in focus, we have (C'') a small white central disc, brighter than the rest of the field, and sharply limited by a broad, dark ring which is blacker towards the centre.

These appearances are the converse of those presented by the air-bubble. That, as we saw, has a black ring and a white centre, which are the sharper as the objective is approached to the lower pole of the bubble. The fat-globule has, however, a dark ring which is the broader, and a centre which is the sharper, according as the objective is brought nearer to the upper pole.

These considerations, apart from their enabling us to distinguish between air-bubbles and fat-globules, and preventing their being confounded with the histological elements, enable two general principles to be established, viz. bodies which are of greater refractive power than the surrounding medium have a white centre which is sharper and smaller, and a black ring which is larger when

the objective is withdrawn; whilst those which are of less refractive power have a centre which is whiter and smaller, and a black ring which is broader and darker when the objective is lowered.

Monochromatic light.—The same phenomena are observed by yellow monochromatic light, except that the diffraction fringes are more distinct, further apart, and in greater numbers than with ordinary light.

A fat-globule, indeed, seems to be composed of a series of concentric layers like a grain of starch. With blue light these fringes are also multiplied, but are closer together and finer, so that they are not so easily visible.

Yellow monochromatic light, therefore, constitutes a good means for determining whether the striæ seen on an object are peculiar to it or are only diffraction lines. In the former case they are not exaggerated by monochromatic light; but if, on the contrary, they are found to be doubled or quadrupled with this light, we may be certain that they are diffraction fringes.

But there is no source of fallacy, to a certain class of workers, so much to be guarded against as that arising from errors in the interpretation concerning movements as such, *and especially concerning the movement exhibited by certain very minute particles of matter in a state of suspension in fluids.* The movement was first observed in the fine granular particles which exist in great abundance in the contents of pollen grains of plants known as the *foecilla*, and which are set free by crushing the pollen. It was first supposed that they indicated some special vital movement analogous to the motion of the spermatozoa of animals. But it was discovered in 1827, by Dr. Robert Brown, that inorganic substances in a state of fine trituration would give the same result; and it is now known that all substances in a sufficiently fine state of powder are affected in the same manner, one of the most remarkable being the movement visible in the contents of the fluid cavities in quartz in the oldest rocks. These have probably retained their dancing motion for æons. A good illustration is gamboge, which can be easily rubbed from a water-colour cake upon a glass slip and covered, and will at once show the characteristic movement; so will carmine, indigo, and other similarly light bodies. But the metals which are from seven to twenty times as heavy as water require to be reduced to a state of minuteness many times greater; but, trituated finely enough, these also show the movement, for a long time known, from the name of its discoverer, as *Brownian* movement, but now more generally called *pedesis*.

The movement is chiefly of an *oscillatory* nature, but the particles also rotate backwards and forwards on their axes, and gradually (if persistently watched) *change their places* in the field of view. It is an extremely characteristic movement, and could not be mistaken for any vital motion by an observer acquainted with both; but the student must familiarise himself with this kind of motion or he will be utterly unable to distinguish certain kinds of motion in minute living forms in certain stages of their life from this movement, and will make erroneous inferences.

The movement of the smallest particles in pedesis is always the most active, while in the majority of cases particles greater than the $\frac{1}{50000}$ th of an inch are wholly inactive. A drop of common ink which has been exposed to the air for some weeks, or a drop of fine clay (such as the prepared *kaolin* used by photographers), shaken up with water, is recommended by Professor Jevons,¹ who has recently studied this subject, as showing the movement (which he designates *pedesis*) extremely well. But none of the particles he has examined is so active as those of pumice-stone that has been ground up in an agate mortar; for these are seen under the microscope to leap and swarm with an incessant quivering movement, so rapid that it is impossible to follow the course of a particle, which probably changes its direction of motion fifteen or twenty times in a second. The distance through which a particle moves at any one bound is usually less than $\frac{1}{50000}$ th of an inch. This 'Brownian movement' (as it is commonly termed) is not due to evaporation of the liquid, for it continues without the least abatement of energy in a drop of aqueous fluid that is completely surrounded by oil, and is therefore cut off from all possibility of evaporation; and it has been known to continue for many years in a small quantity of fluid enclosed between two glasses in an air-tight case; and for the same reason it can scarcely be connected with the chemical change. But the observations of Professor Jevons (*loc. cit.*) show that it is greatly affected by the admixture of various substances with water, being, for example, increased by a small admixture of gum, while it is checked by an extremely minute admixture of sulphuric acid or of various saline compounds, these (as Professor Jevons points out) being all such as increase the conducting power of water for electricity. The rate of subsidence of finely divided clays or other particles suspended in water thus greatly depends upon the activity of their 'Brownian movement,' for when this is brought to a stand the particles aggregate and sink, so that the liquid clears itself.²

Pedetic motion depends on, that is, is affected by—

1. *The size of the particles.*

2. *The specific gravity of the particles.* Metals, or particles of vermilion, of similar size to particles of silica or gamboge, move much more slowly and less frequently.

3. *The nature of the liquid.* No liquid stops pedesis, but liquids which have a chemical action on the substance do hinder it. This action may be very slow: still it tends to agglomerate the particles. For instance, barium sulphate, when precipitated from the cold solution, takes a long time to settle; whereas, when warm and in presence of hydrochloric acid, agglomeration soon occurs. Iron precipitated as hydrate in presence of salts of ammonium, and mud in salt water, are other instances. The motion does not cease, but the particles adhere together and move very slowly.

But besides the right appreciation of the nature of pedesis, there is the utmost caution required in the interpretation of the

¹ *Quarterly Journal of Micro. Science*, N.S. vol. viii. 1878, p. 172.

² See also the Rev. J. Delsaulx, 'On the Thermo-dynamic Origin of the Brownian Motions,' in *Monthly Journal of Microsc. Sci.* vol. xviii. 1877.

rapidity of movement, and kind of movement, which living and motile forms effect.

*The observation of the phenomena of motion under the microscope*¹ has led to many false views as to the nature of these movements. If, for instance, swarm-spores are seen to traverse the field of view in one second, it might be thought that they race through the water at the speed of an arrow, whereas they in reality traverse in that time only a third part of a millimetre, which is somewhat more than a metre in an hour. It must not, therefore, be forgotten that the rapidity of motion of microscopical objects is only an apparent one, and that its accurate estimation is only possible by taking as our standard the actual ratio between time and space. If we wish, for the sake of exact comparison, to estimate the magnitude of the moving bodies, we may always do so; the ascertainment of the real rapidity remains, however, with each successive motion, the principal matter.

If a screw-shaped spiral object, of slight thickness, revolves on its axis in the focal plane, at the same time moving forward, it presents the deceptive appearance of a serpentine motion. Thus it is that the horizontal projections of an object of this kind, corresponding to the successive moments of time, appear exactly as if the movement were a true serpentine one. As an example of an appearance of this nature we may mention the alleged serpentine motion of *Spirillum* and *Vibrio*.

Similar illusions are also produced by swarm-spores and spermatozoa; they appear to describe serpentine lines, while in reality they move in a spiral. It was formerly thought that a number of different appearances of motion must be distinguished, whereas modern observers have recognised most of them as consisting of a forward movement combined with rotation, where the revolution takes place sometimes round a central, and sometimes round an eccentric, axis. To this category belong, for instance, the supposed oscillations of the *oscillatorie*, whose changes of level, when thus in motion, were formerly unnoticed.

In addition to these characteristics of a spiral motion it must, of course, be ascertained whether it is right- or left-handed. To distinguish this in spherical or cylindrical bodies, which revolve round a central axis, is by no means easy, and in many cases, if the object is very small and the contents homogeneous, it is quite impossible. The slight variations from cylindrical or spherical form, as they occur in each cell, are therefore just sufficient to admit of our perceiving whether any rotation does take place. The discovery of the direction of the rotation is only possible when fixed points whose position to the axis of the spiral is known can be followed in their motion round the axis. The same holds good also, *mutatis mutandis*, of spirally wound threads, spiral vessels, &c.; we must be able to distinguish clearly which are the sides of the windings turned towards or turned away from us.

If the course of the windings is very irregular, as in fig. 367, a little practice and care are needed to distinguish a spiral line as

¹ *Das Mikroskop*, Naegeli and Schwendener, p. 258 (Eng. edit.).

such in small objects. The microscopical image might easily lead us to the conclusion that we were examining a cylindrical body composed of bells or funnels inserted one in another. The spirally thickened threads, for instance, as they originate from the epidermis cells of many seeds, were thus interpreted, although here and there by the side of the irregular spirals quite regular ones are also observed. In illustration of this a very excellent example is given in the 'Quekett Journal' for 1899 (No. 44), p. 166, where Mr.



FIG. 367.—A spiral in motion.

Nelson shows that a certain structure in the remarkable diatom *Climacosphenia moniligera*, which for a long time has been regarded as interlocking teeth, is in reality a spiral pipe.

Moreover, it must not be forgotten that in the microscopical image a spiral line always appears wound in the same manner as when seen with the naked eye, while in a mirror (the inversion being only a half one) a right-handed screw is obviously represented as left-handed, and conversely. If, therefore, the microscopical image is observed in a mirror, as in drawing with the Sommering mirror, or if the image-forming pencils are anywhere turned aside by a single reflection, a similar inversion takes place from right-handed to left-handed, and this inversion is again cancelled by a second reflexion in some microscopes. All this is, of course, well known, and to

the practised observer self-evident; nevertheless many microscopists have shown that they are still entirely in the dark about matters of this kind.

One of Professor Abbe's experiments on diffraction phenomena proves that when the diffraction spectra of the first order are stopped out, while those of the second are admitted, the appearance of the structure will be double the fineness of the actual structure which is causing the interference.¹

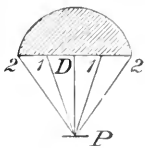

FIG. 368.

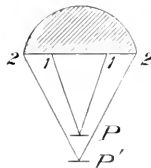

FIG. 369.

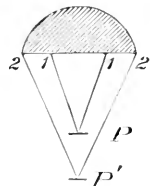

FIG. 370.

Upon this law there appears to depend a number of possible fallacies, errors which may arise from either its misapprehension or misinterpretation. At least these appear to us, from a practical point of view, to be of sufficient importance to need either caution or a fuller exposition of the great law of Abbe in regard to them.

If, for example, figs. 368, 369, and 370 may be taken to represent

¹ See Chapter II.

a square grating having 25,000 holes per linear inch at the focus of an objective at P, P D the dioptric beam, P¹ P¹ diffraction spectra of the first order, and P² P² those of the second order, then if the objective is aplanatic all those spectra will be brought to an identical focal conjugate; and the image of the grating will be a counterpart of the structure, characteristic of such a group of spectra. Let us suppose our objective to be over-corrected, as in fig. 369, then when the grating is focussed at P *the spectra of the first order only will be brought to the focal conjugate*; the image, however, will not be materially affected on that account, as the diffraction elements of the first order are alone sufficient to give a truthful representation of the 25,000 per inch grating. If, however, the objective be raised so that the grating lies at P', *the diffraction elements of the second order only are brought to the focal conjugate*; consequently by the hypothesis the image will have 50,000 holes per linear inch, or double that of the original. In other words, placing a grating at the longer focus of an over-corrected objective is apparently tantamount to cutting out the diffraction spectra of the first order by a stop at the back of the objective.

The effect of this is to give an impression that there is a strong grating with 25,000 holes per linear inch; and over it *another* grating with 50,000 holes per linear inch. The raising the focus so as to bring P to P' necessarily gives the idea of the fine structure being superimposed on the coarse. Therefore the microscopist should beware, whenever he notices a structure of double fineness over another one, lest he has a condition of things similar to fig. 369. The following is a test which may be applied to confirm the genuineness of any such structure. First measure by means of the divided head of the fine-adjustment screw, as accurately as possible, the movement required to bring P to P' in fig. 369; next by means of the draw-tube increase the distance between the eye-piece and the objective: this will have the effect of increasing the over-correction of the objective, and a state of things will be obtained as in fig. 370. Hence it will require a larger movement of the fine-adjustment screw to bring P to P'. This will make the distance between the 50,000 grating and the 25,000 grating appear greater than it was before. *If this takes place the 50,000 grating is a mere diffraction ghost.* It is well to note that we have seen a photograph by Mr. Comber of a diatom surface which is uneven. In those parts where the focus is correct the structure is single, but in the parts where the focus is withdrawn it is double.

A precisely similar condition of things exists with an under-corrected objective, only in that case the false finer grating will appear below the original coarse grating, and to increase the distance between them the draw-tube must be shortened.

It may therefore be of service to give an example of the use of the numerical aperture table as a check in the interpretation of structure.

Fig. 371 gives six illustrations of the back of an objective (the eye-piece being removed) of .83 N.A., or 112° in air. D stands for

dioptric beam; 1 for diffraction spectrum of the first order; 2 for diffraction spectrum of the second order.

When the back of an objective of .83 N.A. shows an arrangement as in

No. 1, then, although the structure will be invisible,	it cannot be coarser than	40,000 per inch.
No. 2	" "	80,000 "
No. 3, then the structure does not differ greatly from		40,000 "
No. 4	" "	80,000 "
No. 5	" "	20,000 "
No. 6	" "	40,000 "

It will be understood by the student that the *preservation of the microscope* and its apparatus is a matter that must largely depend upon his own action. The stand should be kept from dust, generally wiped with a soft chamois leather after use, and when needful a minute quantity of watchmaker's oil may be put to a joint working stiffly. There is no better way to preserve this stand than to keep

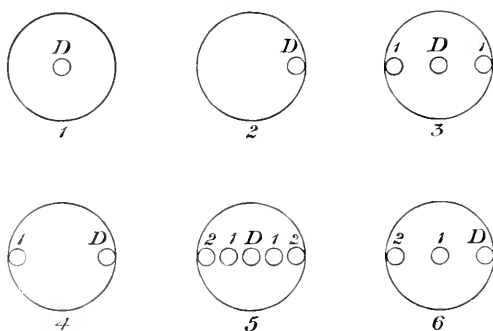

FIG. 371.

it either under a bell-glass or in a cabinet which is easily accessible.

All objectives should be examined after use, and all oils or other fluids carefully wiped away from them with old cambric which has been thoroughly washed with soda, well rinsed and not 'ironed' or finished in any way, but simply dried.

If chemical reagents are employed the cessation of their use should become the moment for wiping with care the lenses employed; and all processes involving the use of the vapours of volatile acids, or which develop sulphuretted hydrogen, chlorine, &c., must never take place in a room in which a microscope of any value is placed.

Dry elder-pith and Japanese paper are by some workers suggested for cleaning the front lenses of homogeneous objectives; but while these are excellent, especially the former, we find nothing better than the simple cambric we suggest.

Two or three good chamois leathers should be kept by the worker for specific purposes and not interchanged. Cleanliness, care, delicacy of touch, and a purpose to be accurate in all that he does or seeks to do are essentials of the successful microscopist.

It may be noted that dust on the eye-piece can be detected in a dim light, and can be discovered by closing the iris diaphragm. The lens of the eye-piece on which the dust appears may be localised by rotation; and this should be done before wiping. In reference to dust on the back of the objective, it should be observed that if the eye-piece be removed, dust sometimes appears to be upon it which comes really from the focus of the sub-stage condenser, and is, in fact, not on the back of the objective at all. To find this condition, remove the light modifier (if in use), for the dust may be on it, and rotate the condenser; else there will be needless and injurious rubbing of the back lens of the objective.

With oil-immersion objectives dust or air-bubbles in the oil must be carefully avoided.

If chamois leather be used for cleaning the lenses, it should be previously well beaten and shaken, and then kept constantly in a well-made box.

CHAPTER VII

PREPARATION, MOUNTING, AND COLLECTION OF OBJECTS

UNDER this head it is intended to give an account of those materials, instruments, and appliances of various kinds which have been found most serviceable to microscopists engaged in general biological research, and to describe the most approved methods of employing them in the preparation and mounting of objects for the display of the minute structures thus brought to our knowledge. Not only is it of the greatest advantage that the discoveries made by microscopic research should—as far as possible—be embodied (so to speak) in ‘preparations,’ which shall enable them to be studied by every one who may desire to do so, but it is now universally admitted that such ‘preparations’ often show so much more than can be seen in the fresh organism that no examination of it can be considered as complete in which the methods most suitable to each particular case have not been put in practice. It must be obvious that in a comprehensive treatise like the present such a *general* treatment of this subject is all that can be attempted, excepting in a few instances of peculiar interest; and as the histological student can find all the guidance he needs in the numerous manuals now prepared for his instruction, the Author will not feel it requisite to furnish him with the *special* directions that are readily accessible to him elsewhere.

MATERIALS, INSTRUMENTS, AND APPLIANCES.

Glass Slides.—The kind of glass best suited for mounting objects is that which is known as ‘patent plate,’ and it is now almost invariably cut, by the common consent of microscopists in this country, into slips measuring 3 in. by 1 in. For objects too large to be mounted on these the size of 3 in. by 1½ in. may be adopted. Such slips may be purchased, accurately cut to size, and ground at the edges, for so little more than the cost of the glass that few persons to whom time is an object would trouble themselves to prepare them: it being only when glass slides of some unusual dimensions are required, or when it is desired to construct ‘built-up cells,’ that a facility in cutting glass with a glazier’s diamond becomes useful. The glass slides prepared for use should be free from veins, air-bubbles, or other flaws, at least in the central part on which the object is placed: and any whose defects render them unsuitable for ordinary purposes should be selected and laid aside for uses to which the working microscopist will find no difficulty in putting them. As

the slips vary considerably in thickness, it will be advantageous to determine on a gauge for *thin*, *thick*, and *medium* glass. The first may be employed for mounting delicate objects to be viewed by the high powers with which the apochromatic and achromatic condensers are to be used, so as to allow plenty of room for the focal point of an optical combination with great aperture to be fixed readily upon the plane of the object; the second should be set aside for the attachment of objects which are to be ground down, and for which, therefore, a stronger mounting than usual is desirable; and the third are to be used for mounting ordinary objects. Great care should be taken in washing the slides, and in removing from them every trace of greasiness by the use of a little soda or potass solution. If this should not suffice they may be immersed in the solution recommended by Dr. Seiler, composed of 2 oz. of bichromate of potass, 3 fl. oz. of sulphuric acid, and 25 oz. of water, and afterwards thoroughly rinsed. (The same solution may be advantageously used for cleansing cover-glasses.) Before they are put away the slides should be wiped perfectly dry, first with an ordinary 'glass cloth,' and afterwards with an old cambric handkerchief; and before being used each slide should be washed in methylated spirit to ensure freedom from greasiness. Where slides that have been already employed for mounting preparations are again brought into use, great care should be taken in completely removing all trace of adherent varnish or cement—first by scraping (care being taken not to scratch the glass), then by using an appropriate solvent, and then by rubbing the slide with a mixture of equal parts of alcohol, benzole, and liquor sodæ, finishing with clean water.

Thin Glass.—The older microscopists were obliged to employ thin laminae of *talc* for covering objects to be viewed with lenses of short focus; but this material, which was in many respects objectionable, is entirely superseded by the thin glass manufactured by Messrs. Chance, of Birmingham, which may be obtained of various degrees of thickness, down to the $\frac{1}{500}$ th of an inch. This glass, being unannealed, is very hard and brittle, and much care and some dexterity are required in cutting it; hence covers should be purchased, as required, from the dealers, who usually keep them in several sizes and supply any others to order. Save the fact that 'cover-glass' is made by Messrs. Chance, there is no definite information as to the mode of its manufacture and the conditions upon which it is most satisfactorily produced. It would be an advantage to the microscopist to possess information on this point. The different thicknesses are usually ranked as 1, 2, and 3; the first, which should not exceed in thickness the .006 in., being used for covering objects to be viewed with *low* powers; the second, which should not exceed .005 in. in thickness, for objects to be viewed with *medium* powers; and the third, which ought never to exceed .004 in. in thickness, for objects which either require or may be capable of being used with *high* powers. It must, however, be remembered that the achromatic objectives of great power and great aperture (1.5) will require much thinner covers than even this. The thinnest glass is of course most difficult to handle safely, and is most liable to fracture from accidents of various

kinds; and hence it should only be employed for the purpose for which it is absolutely needed. The thickest pieces, again, may be most advantageously employed as covers for large cells, in which objects are mounted in fluid to be viewed by the low powers whose performance is not sensibly affected by the aberration thus produced. The working microscopist will find it desirable to provide himself with some means of measuring the thickness of his cover-glass; and this is especially needed if he is in the habit of employing objectives without adjustment, which are corrected to a particular standard. A small screw-gauge of steel, made for measuring the thickness of rolled plates of brass, and sold at the tool-shops, answers this purpose very well; but Ross's *lever of contact* (fig. 372), devised for this express purpose, is in many respects preferable. This consists of a small horizontal table of brass, mounted upon a stand, and having at one end an arc graduated into twenty divisions, each of which represents the $\frac{1}{1000}$ th of an inch, so that the entire arc measures the $\frac{1}{50}$ th of an inch; at the other end is a pivot on which moves a long and delicate lever of steel, whose extremity points to the graduated arc, whilst it has very near its pivot a sort of projecting tooth, which bears it against a vertical plate of steel that is screwed to the

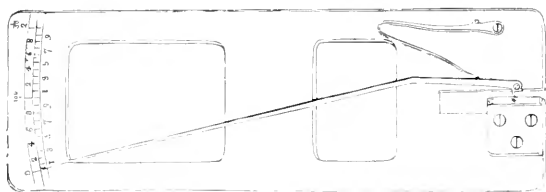

FIG. 372.—Ross's lever of contact.

horizontal table. The piece of thin glass to be measured being inserted between the vertical plate and the projecting tooth of the lever, its thickness in thousandths of an inch is given by the number on the graduated arc to which the extremity of the lever points. Thus, if the number be 8, the thickness of the glass is $\cdot008$, or the $\frac{1}{125}$ th of an inch. It will be found convenient to sort the covers according to their thicknesses, and to keep the sortings apart, so that there may be a suitable thickness of cover for each object. But it is well to remember that, with the exception of objects to which from their size or nature it is impossible to apply high powers, it is better to mount the object so that, if it be required or desirable, high powers may be used upon it.

Another simple and very efficient cover-glass tester is made by Zeiss, of Jena, and illustrated in fig. 373. It will be seen that the measurement is effected by a clip projecting from a box, between the jaws of which the cover to be measured is placed; the reading is given by an indicator moving over a divided circle on the upper face of the box. The divisions show hundredths of a millimetre, and the instrument measures to upwards of 5 mm.

One of the continuous aims of the working microscopist is to save or utilise to its utmost his time. Complicated measurements and calculations are to be avoided where possible, and a very beautiful and ingenious instrument, capable of being used as a meter for cover-glass, has been devised by Mr. J. Ciceri Smith, of 61 Hatton Garden, London. It is a perfect direct-reading micrometer, and is constructed to take measurements in thousandths of an inch, and may be used in gauging the thickness of microscopical glass, metal

and other sheets, balls for bearings, needles, wire, &c. Its advantages over the ordinary micrometer consist in the measurements being automatically and accurately recorded in clear figures on the index, thus avoiding the strain on the eyes caused by reading the fine lines on the old form of

gauge; in there being no liability to errors through miscalculations, and in its being possible to take any number of various readings with ease, accuracy, and rapidity. We illustrate this apparatus in fig. 374.

As in the ordinary decimal gauge the glass or other article to be measured is placed between the 'anvil' (or hexagonal nut) and the face of the spindle, the thimble being rotated in either direction

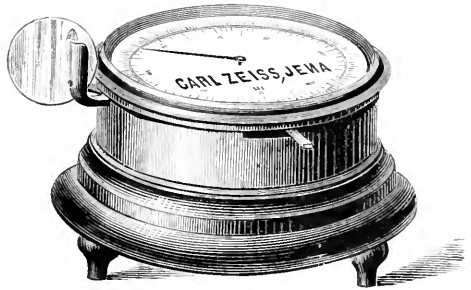

FIG. 373.—Zeiss's cover-glass tester.

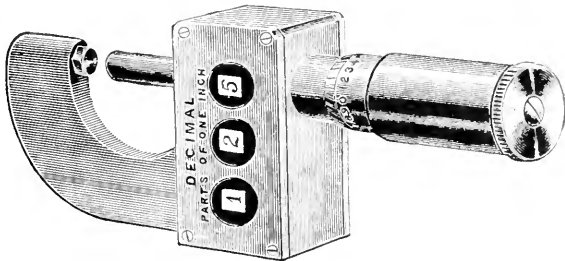

FIG. 374.—Mr. J. Ciceri Smith's direct-reading micrometer.

until the required adjustment is obtained, the exact measurement in decimal parts of an inch being at the same instant automatically and accurately recorded on the index, these readings responding in either direction with the most delicate movements of the screw.

To avoid the screw being unduly strained, the spindle is rotated by friction from the outer spring-tight thimble, the inner thimble being rigidly fixed to the spindle. Hence it is impossible to strain the screw, since as soon as the pressure becomes too great the spring

allows the outer thimble to slip. The connection of the spindle to the measuring wheels is effected by means of a stop. This takes into a slot on a sleeve, on which is mounted the thousandths wheel, which in turn drives the hundredths and tenths wheels through the intermediate pinions. These latter have a step-by-step motion, as in an ordinary counter. The cover of the cage in which the mechanism is placed is pierced to show the numbers on the dials, but these openings are covered with glass, with a view to excluding dust and dirt. It must be understood that gauges of this kind are expensive, but there is one made by G. Boley, reading to $\cdot 01$, which answers all purposes and can be purchased for five shillings at a watchmaker's tool shop.

It is well to keep assorted, measured, and cleaned cover-glasses in small separate wide-stoppered bottles of methylated spirit, each bottle being labelled with the gauge of thickness of the covers it contains. What is then required is a simple apparatus for cleaning the delicate covers with the least risk of breakage. This can be well accomplished by having two blocks of boxwood, shaped so as to be easily held one in each hand, turned with perfect trueness on the faces opposite to the respective handles, so that when the surfaces so flattened are laid upon and pressed towards each other they are everywhere in perfect contact. They should be from two to four inches in diameter, and these flattened surfaces should each have, very tightly stretched upon them, a firm, even-textured, moderately thick piece of chamois leather. If covers be slightly moistened—even breathed upon—and laid on one of these blocks and pressed down with the other, breath, or moisture applied by a small camel-hair brush to the upper surface of the cover, may be applied, and a few twists of these blocks upon each other when firmly pressed together will effectually clean without breaking the thinner covers. It will be often needful to treat both sides of the covers thus, as one side generally adheres while the other is subject to the friction.

For cleaning slips and covers by hand, finishing should be done with old fine cambric handkerchiefs. These should not be washed with soap, but with common soda and hot water, plenty of the latter being subsequently employed to get rid of every trace of the alkali. But when dry these cloths must not be 'ironed' or smoothed in any way, the 'rough-dry' surface acting admirably for wiping delicate glass.

Varnishes and Cements.—There are three very distinct purposes for which cements which possess the power of holding firmly to glass, and of resisting not merely water but other preservative liquids, are required by the microscopist, these being (1) the attachment of the glass covers to the slides or cells containing the object, (2) the formation of thin 'cells' of cement only, and (3) the attachment of the 'glass plate' or 'tube-cells' to the slides. The two former of these purposes are answered by liquid cements or *varnishes*, which may be applied without heat; the last requires a *solid cement* of greater tenacity, which can only be used in the melted state. Among the many such cements that have been recommended by different workers, two or three will be selected by the worker for general

purposes, and perhaps three or four for special purposes, and the remainder will be in practice neglected. We do not hesitate to say that the two cements on which the most complete trust may be reposed are *Japanner's gold size* and *Bell's cement*. This opinion is the result of over twenty years of special observation.

A *good varnish* may easily, in a general way, be tested: when it is thoroughly hard and old, if scraped off it comes away in shreds; unsafe varnishes break under the scraper in flakes and dust. To those who put up valuable preparations and objects of value the risk should never be run of using a new and unknown varnish or cement. Neither appearance nor facility nor cheapness in use should for one moment weigh against a varnish or cement of known and tested worth.

Japanner's gold size may be obtained from the colour shops. It may be used for closing-in mounted objects of almost any description. It takes a peculiarly firm hold of glass, and when dry it becomes extremely tough without brittleness. When new it is very liquid and 'runs' rather too freely; so that it is often advantageous to leave open for a time the bottle containing it until the varnish is somewhat thickened. By keeping it still longer, with occasional exposure to air, it is rendered much more viscid, and though such 'old' gold-size is not fit for ordinary use, yet one or two coats of it may be advantageously laid over the films of newer varnish, for securing the thicker covers of large cells. Whenever any other varnish or cement is used, either in making a cell or in closing it in, the rings of these should be covered with one or two layers of gold-size extending beyond it on either side, so as to form a continuous film extending from the marginal ring of the cover to the adjacent portion of the glass slide.

Asphalte Varnish.—This is a black varnish made by dissolving half a drachm of caoutchouc in mineral naphtha, and then adding 4 oz. of asphaltum, using heat if necessary for its solution. It is very important that the asphaltum should be genuine, and the other materials of the best quality. Some use asphalte as a substitute for gold size; but the Author's experience leads him to recommend that it should only be employed either for making shallow 'cement cells' or for finishing off preparations already secured with gold-size. For the former purpose it may advantageously be slightly thickened by evaporation.

Bell's cement is sold by J. Bell and Co., chemists, Oxford Street, London; they are the sole makers, and retain the secret of its composition. It is of great service for glycerin mounts; but the edge of the cover should be ringed with glycerin jelly before this cement is applied. It is an extremely useful and reliable varnish, which is extremely easy of manipulation. It can be readily dissolved in either ether or chloroform.

Canada balsam is the oleo-resin from *Abies balsamea* and *Pinus canadensis*; it is so brittle when hardened by time that it cannot be safely used as a cement, except for the special purpose of attaching hard specimens to glass, in order that they may be reduced by grinding, &c. Although fresh, soft balsam may be hardened by heating

it on the slide to which the object is to be attached, yet it may be preferably hardened *en masse* by exposing it in a shallow vessel to the prolonged but moderate heat of an oven, until so much of its volatile oil has been driven off that it becomes *almost* (but not quite) resinous on cooling. If, when a drop is spread out on a glass and allowed to become quite cold, it is found to be so hard as not to be readily indented by the thumb-nail, and yet not so hard as to 'chip,' it is in the best condition to be used for cementing. If too soft, it will require a little more hardening on the slide, to which it should be transferred in the liquid state, being brought to it by the heat of a water-bath: if too hard it may be dissolved in chloroform or benzole for use as a mounting 'medium'; we do not recommend its use for mounts with glycerin.

Brunswick black is a very useful cement, obtainable at the optician's as prepared for the use of microscopists. It is one of the best cements for the purpose of ringing mounts, and it may be recommended for turning cells. We have already stated that we do not, as a rule, recommend opaque or black-ground mounting; but if this is desired or needful no better 'ground' can be obtained than by putting on the centre of the slide a disc of Brunswick black the size of the outside of the cell or cover-glass, and while it is wet putting a thin cover-glass upon it. The cover-glass becomes quickly fixed, and a pleasant surface is formed to receive the object which it is intended to mount. Should it be desirable to have the floor of the opaque cell dead instead of bright, this can be quickly accomplished with a little emery-powder and water applied to the surface by a flattened block of tin fixed in boxwood.

Brunswick black is soluble in oil of turpentine, and it dries quickly.

Glue and honey mixed in equal parts is very valuable for special purposes, and softens with heat.

Shellac cement is made by keeping small pieces of picked shellac in a bottle of rectified spirit, and shaking it from time to time. It cannot be recommended as a substitute for any of the preceding, but it may be employed to put a thin film upon the edge of *all* mounts—however closed and finished—that are to be used with homogeneous lenses. It is a sure protection against the otherwise injurious action of the cedar oil. Hollis's liquid glue may also be employed with confidence for this purpose.

Sealing-wax varnish, which is made by digesting powdered sealing-wax at a gentle heat in alcohol, should never be used as a cement; it is serviceable only as a varnish, and resists cedar oil.

Venice turpentine is the liquid resinous exudation of *Abies larix*. It must be dissolved in enough alcohol to filter readily, and after filtering must be placed in an evaporating dish, and by means of a sand bath must be reduced by evaporation one-fourth.

This cement is used for closing glycerin mounts. Square covers are used, and we find it best to edge the cover with glycerin jelly. A piece of copper wire of No. 10 to No. 12 gauge is taken, and one end of it is bent just the length of one of the sides of the cover at right angles to the length of the wire. This end is now heated in a

spirit lamp, plunged into the cement, which adheres in fair quantity, and is instantly brought down upon the slide and the margin of the cover. The fluid turpentine distributes itself evenly along the cover and slide and hardens at once. We have no long experience of it, but from some of its characteristics we are inclined to believe it will prove a useful cement for this purpose.

Marine glue, which is composed of shellac, caoutchouc, and naphtha, is distinguished by its extraordinary tenacity, and by its power of resisting solvents of almost every kind. Different qualities of this substance are made for the several purposes to which it is applied, and the one most suitable to the wants of the microscopist is known in commerce as G K 4. The special value of this cement, which can only be applied hot, is in attaching to glass slides the glass or metal rings which thus form 'cells' for the reception of objects to be mounted in fluid, no other cement being comparable to it either for tenacity or for durability. The manner of so using it will be presently described.

Various *coloured* varnishes are used to give a finish to mounted preparations, or to mark on the covering glasses of large preparations the parts containing special kinds of noteworthy structure. A very good *black* varnish of this kind is made by working up very finely powdered lamp-black with gold-size. For *red*, sealing-wax varnish may be used; but it is very liable to chip and leave the glass when hardened by time. The red varnish specially prepared for microscopic purposes by Messrs. Thompson and Capper, of Liverpool, seems likely to stand better. For white, 'zinc cement' answers well, which is made of benzole, gum dammar, oxide of zinc, and turpentine. But it is inexpensive, and either in Cole's or Ziegler's formula may be obtained at the optician's. Blue or green pigments may be worked up with this if cements of those colours be desired.

For attaching labels to slides either of glass or wood, and for fixing down small objects to be mounted 'dry' (such as *foraminifera*, parts of insects, &c.), the Author has found nothing preferable to a rather thick mucilage of gum arabic, to which enough glycerin has been added to prevent it from drying hard, with a few drops of some essential oil to prevent the development of mould. The following formula has also been recommended: Dissolve 2 oz. of gum arabic in 2 oz. of water, and then add $\frac{1}{4}$ oz. of soaked gelatin (for the solution of which the action of heat will be required), 30 drops of glycerin, and a lump of camphor. The further advantage is gained by the addition of a slightly increased proportion of glycerin to either of the foregoing, that the gum can be very readily softened by water, so that covers may be easily removed (to be cleansed if necessary) and the arrangement of objects (where many are mounted together) altered.

Cells for Dry-mounting.—Where the object to be mounted 'dry' (*i.e.* not immersed either in fluid or in any 'medium') is so thin as to require that the cover should be but little raised above the slide, a 'cement cell' answers this purpose very well; and if the application of a gentle warmth be not injurious, the pressing down of the cover on the softened cement will help both to fix it and to

prevent the varnish applied round its border from running in. Where a somewhat deeper cell is required, Prof. H. L. Smith (U.S.A.) suggests the following specially for the mounting of diatoms. A sheet of thin writing-paper dipped into thick shellac varnish is hung up to dry; and rings are then cut out from it by punches of two different sizes. One of these rings being laid on a glass slide, and the cover, with the object dried upon it, laid on the ring, it is to be held in its place by the forceps or spring-clip, and the slide gently warmed so as to cause a slight adhesion of the cover to the ring, and of the ring to the slide; and this adhesion may then be rendered complete by laying another glass slide on the cover and pressing the two slides together, with the aid of a continued gentle heat. Still deeper cells may be made with rings punched out of tinfoil of various thicknesses and cemented with shellac varnish on either side. And if yet deeper cells are needed, they may be made of turned rings of vulcanite or ebonite, cemented in the same manner. There is, however, a tendency in shellac-formed cells to throw off a cloudiness inside the cell, usually called 'sweating,' which is very undesirable. It has been found that a ring of solid paraffin, to which the cover is attached, if first 'ringed' with the same material and afterwards with a finishing varnish, makes a useful and permanently clean dry shallow cell; or paper may be saturated with paraffin and treated as described for shellac.

Cement-cells.—Cells for mounting *thin* objects in any watery medium may be readily made with asphalt or Brunswick black varnish by the use of Mr. Shadbolt's 'turn-table' or one of its modifications. The glass slide being placed under its spring in such a manner that its two edges shall be equidistant from the centre (a guide to which position is afforded by the circles traced on the brass), and its four corners equally projecting beyond the circular margin of the plate, a camel's-hair pencil dipped in the varnish is held in the right hand, so that its point comes into contact with the glass over whichever of the circles may be selected as the guide to the size of the ring. The turn-table being made to rotate by the application of the left forefinger to the milled head beneath, a ring of varnish of a suitable breadth is made upon the glass; and if this be set aside in a horizontal position, it will be found, when hard, to present a very level surface. If a greater thickness be desired than a single application will conveniently make, a second layer may be afterwards laid on. It will be found convenient to make a considerable number of such cells at once, and to keep a stock of them ready prepared for use. If the surface of any ring should not be sufficiently level for a covering glass to lie flat upon it, a slight rubbing upon a piece of fine emery paper laid upon a flat table (the ring being held downwards) will make it so.

Ring-cells.—For mounting objects of greater thickness it is desirable to use cells made by cementing rings, either of glass or metal, to the glass slides, with marine glue. Glass rings of any size, diameter, thickness, and breadth are made by cutting transverse sections of thick walled tubes, the surfaces of these sections being ground flat and parallel. Not only may round cells (fig. 375, A, B) of vari-

ous sizes be made by this simple method, but, by flattening the tube (when hot) from which they are cut, the sections may be made quadrangular, or square, or oblong (C, D). For intermediate thicknesses between cement-cells and glass ring-cells, the Editor has found no kind more convenient than the rings stamped out of tin, of various thicknesses. These, after being cemented to the slides, should have their surfaces made perfectly flat by rubbing on a piece of fine grit or a corundum-file, and then smoothed on a Water-of-Ayr stone; to such surfaces the glass covers will be found to adhere with great tenacity. The ebonite and bone cells are cheap, and also easy of manipulation. They are specially useful for dry mounts.

The glass slides and cells which are to be attached to each other must first be heated on the mounting plate; and some small cuttings of marine glue are then to be placed either upon that surface of the cell which is to be attached, or upon that portion of the slide on which it is to lie, the former being perhaps preferable. When they begin to melt, they may be worked over the surface of attachment by means of a needle point; and in this manner the melted glue may be uniformly spread, care being taken to pick out any of the small gritty particles which this cement sometimes contains. When the surface of attachment is thus completely covered with liquefied glue, the cell is to be taken up with a pair of forceps, turned over, and deposited in its

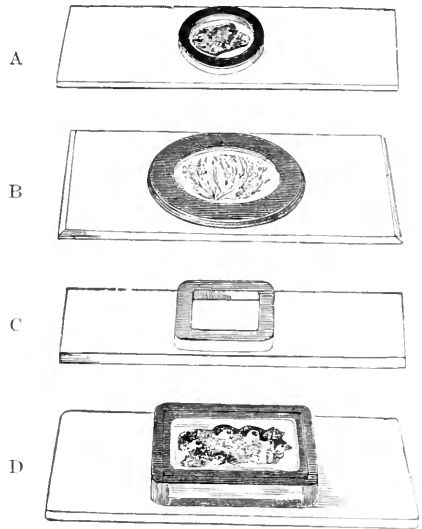

FIG. 375.—Glass ring-cells.

proper place on the slide; and it is then to be firmly pressed down with a stick (such as the handle of the needle), or with a piece of flat wood, so as to squeeze out any superfluous glue from beneath. If any air-bubbles should be seen between the cell and the slide, these should if possible be got rid of by pressure, or by slightly moving the cell from side to side; but if their presence results, as is sometimes the case, from deficiency of cement at that point, the cell must be lifted off again, and more glue applied at the required spot. Sometimes, in spite of care, the glue becomes hardened and blackened by overheating; and as it will not then stick well to the glass, it is preferable not to attempt to proceed, but to lift off the cell from the slide, to let it cool, scrape off the overheated glue, and then repeat the process. When the cementing has been satisfactorily accomplished, the slides should be allowed to cool gradually

in order to secure the firm adhesion of the glue; and this is readily accomplished, in the first instance, by pushing each, as it is finished, towards one of the extremities of the plate. If two plates are in use, the heated plate may then be readily moved away upon the ring which supports it, the other being brought down in its place; and as the heated plate will be some little time in cooling, the firm attachment of the cells will be secured. If, on the other hand, there be only a single plate, and the operator desire to proceed at once in mounting more cells, the slides already completed should be carefully removed from it, and laid upon a *wooden* surface, the slow conduction of which will prevent them from cooling too fast. Before they are quite cold, the superfluous glue should be scraped from the glass with a small chisel or awl, and the surface should then be carefully cleansed with a solution of potash, which may be rubbed upon it with a piece of rag covering a stick shaped like a chisel. The cells

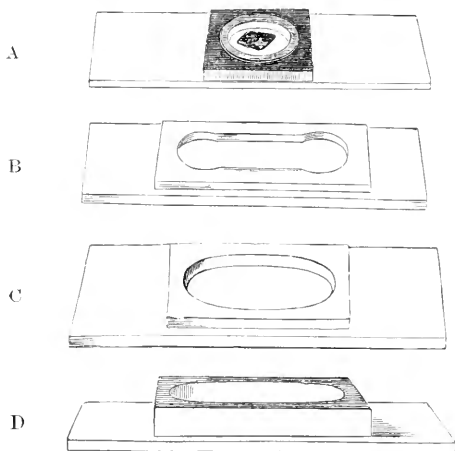

FIG. 376.—Plate-glass cells.

less, if the immediate margin of glue be left both outside and inside the cell. To those to whom *time* is of value, it is recommended that all cells which require marine glue cementing be purchased from the dealers in microscopic apparatus, and it is well 'payed,' as the nautical expression is, or well surrounded with shellac varnish or gold-size as indicated by the nature of the enclosed fluid. Many media, saline fluids especially, work their way between the cell and the slide, and at length destroy the marine glue.

Plate-glass Cells.—Where large shallow cells with flat bottoms are required (as for mounting *zoophytes*, small *medusa*, &c.), they may be made by drilling holes in pieces of plate-glass of various sizes, shapes, and thicknesses (fig. 376, A), which are then cemented to the slide with marine glue. By drilling two holes at a

should next be washed with a hard brush and soap and water, and may be finally cleansed by rubbing with a little weak spirit and a soft cloth. In cases in which *appearance* is not of much consequence, and especially in those in which the cell is to be used for mounting large opaque objects, it is decidedly preferable not to scrape off the glue too closely round the edges of attachment, as the 'hold' is much firmer, and the probability of the penetration of air or fluid much

suitable distance, and cutting out the piece between them, any required elongation of the cavity may be obtained (B, C, D).

Sunk-cells.—This name is given to round or oval hollows, excavated by grinding in the substance of glass slides, which for this purpose should be thicker than ordinary. They are shown in fig. 377, A, B, C. Such cells have the advantage not only of comparative cheapness, but also of durability, as they are not liable to injury by a sudden jar, such as sometimes causes the detachment of a cemented plate or ring. For objects whose shape adapts them to the form and depth of the cavity, such cells will be found very convenient. It naturally suggests itself as an objection to the use of such cells that the concavity of their bottom must so deflect the light-rays as to distort or obscure the image: but as the cavity is filled either with water or some other liquid of higher refractive power, the deflection is so slight as to be practically inoperative. Before mounting objects in such cells the microscopist should see that their concave surfaces are free from scratches or roughnesses.

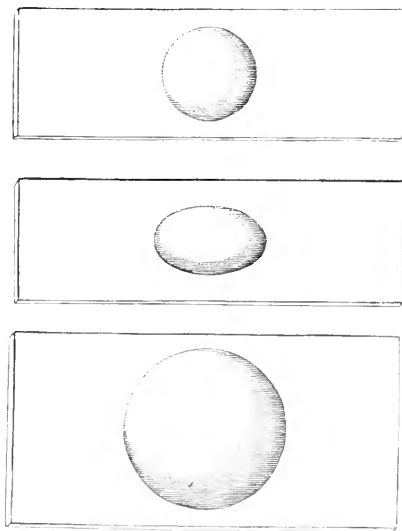

FIG. 377.—Plate-glass sunk-cells.

Before mounting objects in such cells the microscopist should see that their concave surfaces are free from scratches or roughnesses.

Built-up Cells.—When cells are required of forms or dimensions not otherwise procurable, they may be *built up* of separate pieces of glass cemented together. Large *shallow* cells, suitable for mounting zoophytes or similar flat objects, may be easily constructed after the following method: A piece of plate-glass, of a thickness that shall give the desired depth to the cell, is to be cut to the dimensions of its outside

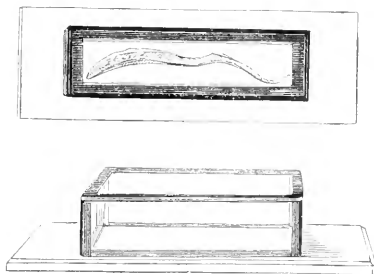

FIG. 378.—Built-up cells.

wall; and a strip is then to be cut off with the diamond from each of its edges, of such breadth as shall leave the interior piece equal in its dimensions to the cavity of the cell that is desired.

This piece being rejected, the four strips are then to be cemented upon the glass slide in their original position, so that the diamond-cuts shall fit together with the most exact precision; and the upper surface is then to be ground flat with emery upon a pewter plate and left rough. The perfect construction of large *deep* cells of this kind, as shown in fig. 378, A, B, however, requires a nicety of workmanship which few amateurs possess, and the expenditure of more time than microscopists generally have to spare; and as it is consequently preferable to obtain them ready-made, directions for making them need not be here given.

Wooden Slides for Opaque Objects.—Such ‘dry’ objects as, *foraminifera*, the capsules of *mosses*, parts of *insects*, and the like, may be conveniently mounted in a very simple form of wooden slide (first devised by the Author and now come into general use), which also serves as a protective ‘cell.’ Let a number of slips of mahogany or cedar be provided, each of the 3-inch by 1-inch size, and of any thickness that may be found convenient, with a corresponding number of slips of card of the same dimensions, and of pieces of dead-black paper rather larger than the aperture of the slide. A piece of this paper being gummed to the middle of the card, and some stiff gum having been previously spread over one side of the wooden slide (care being taken that there is no superfluity of it immediately around the aperture), this is to be laid down upon the card, and subjected to pressure.¹ An extremely neat ‘cell’ will thus be formed for the reception of the object, as we see in fig. 379, the



FIG. 379.—Slip made of wood.

depth of which will be determined by the thickness of the slide, and the diameter by the size of the perforation; and it will be found convenient to provide slides of various thicknesses, with apertures of different sizes. The cell should always be deep enough for its wall to rise above the object; but, on the other hand, it should not be too deep for its walls to interfere with the oblique incidence of the light upon any object that may be near its periphery. The object, if flat or small, may be attached by gum-mucilage; if, however, it be large, and the part of it to be attached have an irregular surface, it is desirable to form a ‘bed’ to this by gum thickened with starch. If, on the other hand, it should be desired to mount the object edgewise (as when the *mouth* of a *foraminifer* is to be brought into view), the *side* of the object may be attached with a little gum to the *wall* of the cell. The complete protection thus given to the object is the great recommendation of this method. But this is by no means its only convenience. It allows the slides not only to range in the ordinary cabinets, but also to be laid one against or over another, and to be packed closely in cases, or secured by elastic

¹ It will be found a very convenient plan to prepare a large number of such slides at once, and this may be done in a marvellously short time if the slips of card have been previously cut to the exact size in a bookbinder’s press. The slides, when put together, should be placed in pairs, back to back, and every pair should have each of its ends embraced by a spring-press (fig. 385) until dry.

bands; which plan is extremely convenient not merely for the saving of space, but also for preserving the objects from dust. Should any more special protection be required, a thin glass cover may be laid over the top of the cell, and secured there either by a rim of gum or by a perforated paper cover attached to the slide; and if it should be desired to pack these covered slides together, it is only necessary to interpose *guards* of card somewhat thicker than the glass covers.

Turn-table.—This simple instrument (fig. 380), devised by Mr. Shadbolt, is almost indispensable to the microscopist who desires

to preserve preparations that are mounted in any 'medium' beneath circular covers; since it not only serves for the making of those 'cement-cells' in which thin trans-

parent objects can be best mounted in any kind of 'medium,' but also enables him to apply his varnish for the securing of circular cover-glasses not only with greater neatness and quickness, but also with greater certainty than he can by the hand alone. The only special precaution to be observed in the use of this instrument is that the cover-glass, not the slide, should be 'centred;' which can be readily done, if several concentric circles have been turned on the rotating-table, by making the cover-glass correspond with the one having its own diameter. A number of ingenious modifications have been devised in this simple instrument with a view to securing exact centring. The most practicable and inexpensive of these is an application of Mr. E. H. Griffith's device shown in its improved form in fig. 381.

The centre of the table marked with circles has a straight spring attached to it beneath. The slide, being placed between the two pins A and B in this centre, is partially rotated against the spring and pushed forward, when the spring keeps it between the two pins and a third fixed pin, D, at the upper side of the slide, centring it perfectly for width. The fourth pin, E, at the left end, $1\frac{1}{2}$ in. from the centre, is for length, and allows the slide to be always placed in the same relative position. The recent improvements add much to the value of the table. One of them is a countersunk decentering wheel and pin, C, which may be seen at the upper right-hand side of the slide. The axle of the wheel passes through the table and is furnished underneath with a

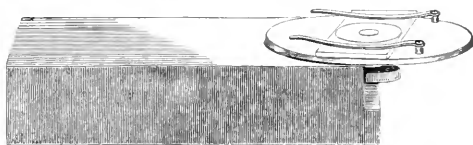

FIG. 380.—Shadbolt's turn-table.

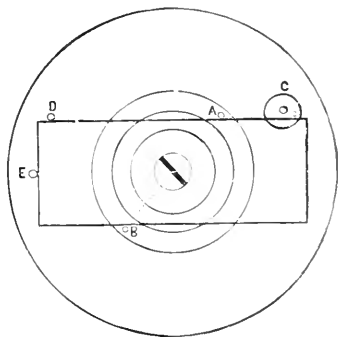

FIG. 381.—Griffith's turn-table.

short bar with which the decentring wheel may be turned, forcing the pin against the slide, pushing it as far out of centre as may be desired. Another improvement is in making the end-pin a screw, which may be turned down out of the way if desired.

Mounting Plate and Water-Bath.—Whenever heat has to be applied either in the cementing of cells or in the mounting of objects, it is desirable that the slide should not be exposed direct to the flame, but that it should be laid upon a surface of regulated temperature. As cementing with marine glue or hardened Canada balsam requires a heat above that of boiling water, it must be

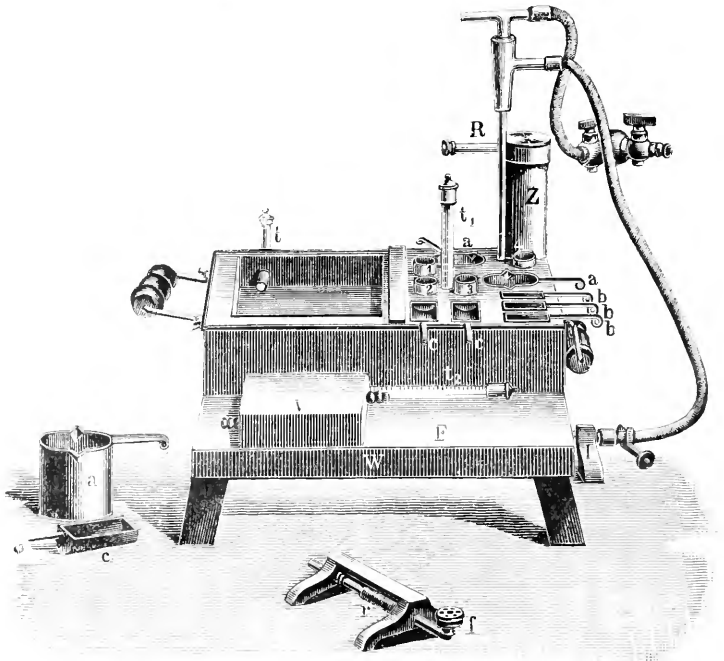

FIG. 382.—Apparatus for preparing mounting media, paraffin, &c., for imbedding by heat.

supplied by a plate of metal; and the Author's experience leads him to recommend that this should be a piece of iron not less than six inches square and half an inch thick, and that it should be supported, not on legs of its own, but on the ring of a retort-stand, so that by raising or lowering the ring any desired amount of heat may be imparted to it by the lamp or gas-flame beneath. The advantage of a plate of this size and thickness consists in the *gradual* temperature which its different parts afford, and in the slowness of its cooling when removed from the lamp. When many cells are being cemented at once, it is convenient to have two such plates, that one may be cooling while the other is being heated.

It is also needful to have a smaller plate, much thinner, of brass, having a groove cut in it into which the ordinary 3×1 in. mounting slip can easily slide, but so grooved as to leave a space between a ledge on each side on which the slip rests, and the main surface of the brass under the slip. In this way there is always a film of heated air between the main surface of the heated brass and that of the glass, giving more facility for rapid and delicate heating. This may be either a separate 'table' or a plate fitted to a retort-stand.

Beyond this, however, heat of various kinds, dry and moist, of variable but determinate temperatures, will be required for various purposes, especially for melting the various mounting media, such as gelatin, agar-agar, &c., and also, as we shall shortly see, for the preparation of imbedding masses for section cutting and a variety of other purposes. One of the many pieces of apparatus which have been devised to combine as large a number of the requirements of the mounter in one construction as can be conveniently done was devised by Dr. P. Mayer and his colleagues. It is illustrated in fig. 382.

W is the bath; Z the tube by which it is filled with water; 1, 2, 3, 4 are glass tubes; *a* is a pot for melting and clarifying the paraffin, and this may be replaced by others for other needful purposes; *b* and *c* are half-cylinders with handles for imbedding; *t* is a thermometer bent at a right angle; the horizontal leg ends in the air-bath, and can be closed with a glass plate, which is of service for biological as well as mounting purposes. The temperature in the air-bath will be always about 10° less than that in the water-bath. It serves well for evaporating chloroform, &c.; t_1 is the thermometer for the water-bath; R is a Reichert's thermo-regulator. The variation in temperature is less than 1° C.; *r* is the tube in which the gas and air mix, and *f* a mica chimney. There is a small independent and removable water-bath, *v*, filled with water by means of rubber tubes attached to lateral openings. It is supplied with a thermometer, t_2 , is warmed on the platform, F, and is intended chiefly for fixing objects which are small in the right position in the imbedding mass, usually known as 'orienting' objects, under a simple lens or dissecting microscope.

Slide-forceps, Spring-clip, and Spring-press.—For holding slides to which heat is being applied, especially while cementing objects to be ground down into thin sections, the wooden *slide-forceps*, seen in fig. 383, will be found extremely convenient. This, by its elasticity, affords a secure grasp to a slide of any ordinary thickness, the wooden blades being separated by pressure upon the brass studs; while the lower stud, with the bent piece of brass at the junction of the blades, affords a level support to the forceps, which thus, while resting upon the table, keeps the heated glass from contact with its surface. For holding down cover-glasses whilst the balsam or other medium is cooling, if the elasticity of the object should tend to make them spring up, the wire spring-clip (fig. 384), sold at a cheap rate by dealers in microscopic apparatus, will be found extremely convenient. Or if a stronger pressure be required, recourse may be had to a simple spring-press made by a slight

alteration of the 'American clothes-peg,' which is now in general use in this country for a variety of purposes, all that is necessary being to rub down the opposed surfaces of the 'clip' with a flat file, so that they shall be parallel to each other when an ordinary slide with its cover is interposed between them (fig. 385). One of these

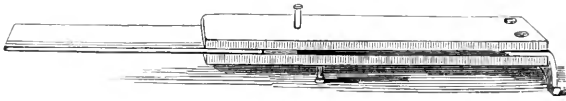

FIG. 383.—Slide-forceps.

convenient little implements may also be easily made to serve the purpose of a slide-forceps by cutting back the upper edge of the clip, and filing the lower to such a plane that when it rests on its flat side it shall hold the slide parallel to the surface of the table, as in fig. 383.

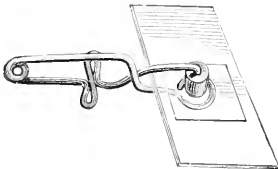

FIG. 384.—Spring-clip.

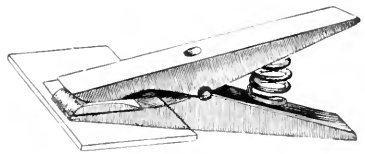

FIG. 385.—Spring-press.

Mounting Instrument.—A simple mode of applying graduated pressure concurrently with the heat of a lamp, which will be found very convenient in the mounting of certain classes of objects, is afforded by the mounting instrument devised by Mr. James Smith. This consists of a plate of brass turned up at its edges, of the proper size to allow the ordinary glass slide to lie loosely in the bed thus formed; this plate has a large perforation in its centre, in order to allow heat to be directly applied to the slide from beneath; and it

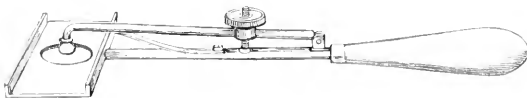

FIG. 386.—Smith's mounting instrument.

is attached by a stout wire to a handle shown in fig. 386. Close to this handle there is attached by a joint an upper wire, which lies nearly parallel to the first, but makes a downward turn just above the centre of the slide-plate, and is terminated by an ivory knob; this wire is pressed upwards by a spring beneath it, whilst, on the other hand, it is made to approximate the lower by a milled head turning on a screw, so as to bring its ivory knob to bear with greater or less force on the covering-glass. The special use of this arrangement will be explained hereafter.

Dissecting Apparatus.—The mode of making a dissection for microscopic purposes must be determined by the size and character of the object. Generally speaking, it will be found advantageous to carry on the dissection under water, with which alcohol should be mingled where the substance has been long immersed in spirit. The size and depth of the vessel should be proportioned to the dimensions of the object to be dissected; since, for the ready access of the hands and dissecting instruments, it is convenient that the object should



FIG. 387.—Swift's Stephenson binocular dissecting microscope.

neither be far from its walls nor lie under any great depth of water. Where there is no occasion that the bottom of the vessel should be transparent, no kind of dissecting trough is more convenient than that which every one may readily make for himself, of any dimension he may desire, by taking a piece of sheet gutta-percha of adequate size and stoutness, warming it sufficiently to render it flexible, and then turning up its four sides, drawing out one corner into a sort of spout, which serves to pour away its contents when it needs emptying. The dark colour of this substance enables it to furnish a back-

ground, which assists the observer in distinguishing delicate membranes, fibres, &c., especially when magnifying lenses are employed; and it is hard enough (without being too hard) to allow of pins being fixed into it, both for securing the object and for keeping apart such portions as it is useful to put on the stretch. When glass or earthenware troughs are employed, a piece of sheet-cork loaded with lead must be provided to answer the same purposes. In carrying on dissections in such a trough, it is frequently desirable to concentrate additional light upon the part which is being operated on by means of the smaller condensing lens; and when a low magnifying power is wanted it may be supplied either by a single lens, mounted after the manner of Ross's simple microscope, or by a pair of spectacles mounted with the 'semi-lenses' ordinarily used for stereoscopes.¹ Portions of the body under dissection, being floated off when detached, may be conveniently taken up from the trough by placing a slip of glass beneath them (which is often the only mode in which delicate membranes can be satisfactorily spread out), and may be then placed under the microscope for minute examination, being first covered with thin glass, beneath the edges of which is to be introduced a little of the liquid wherein the dissection is being carried on. Where the body under dissection is so transparent that more advantage is gained by transmitting light through it than by looking at it as an opaque object, the trough should have a glass bottom: and for this purpose, unless the body be of unusual size, some of the glass cells already described (figs. 376–377) will usually answer very well. The finest dissections may often be best made upon ordinary slips of glass, care being taken to keep the object sufficiently surrounded by fluid. For work of this kind no instrument is more generally serviceable than the erecting binocular form of stand as recently modified for dissecting purposes by Swift. It is an instrument which combines conveniences and supplies wants which only a worker at dissection could have known. It is illustrated in fig. 387, and will be thoroughly suitable for all the work in which it will be required, from diatom mounting to the most delicate dissections. The supports for the hands on either side of the stage have an extremely suitable curve, and the instrument lends itself admirably to the work.

The *instruments* used in microscopic dissection are for the most part of the same kind as those which are needed in ordinary minute anatomical research, such as scalpels, scissors, forceps, &c.; the fine instruments used in operations upon the eye, however, will commonly be found most suitable. A pair of delicate scissors, curved to one side, is extremely convenient for cutting open tubular parts: these should have their points blunted, but other scissors should have fine points. A pair of very fine-pointed scissors (fig. 388), one leg of which is fixed in a light handle, and the other kept

¹ These may be recommended as useful in a great variety of manipulations which are best performed under a low magnifying power, with the conjoint use of both eyes. Where a high power is needed, recourse may be advantageously had to Messrs. Beck's 3-inch achromatic binocular magnifier, which is constructed on the same principle, allowing the object to be brought very near the eyes, without requiring any uncomfortable convergence of their axes.

apart from it by a spring, so as to close by the pressure of the finger and to open of itself, will be found (if the blades be well sharpened) much superior to any kind of knives for cutting through delicate tissues with as little disturbance of them as possible. A pair of small straight forceps with fine points, and another pair of curved forceps, will be found useful in addition to the ordinary dissecting forceps.

Of all the instruments contrived for delicate dissections, however, few are more serviceable than those which the microscopist may make for himself out of ordinary *needles*. These should be fixed in light wooden handles (the cedar sticks used for camel-hair pencils, or the handles of steel pen-holders, or small porcupine quills will answer



FIG. 388.—Spring scissors.

extremely well) in such a manner that their points should not project far, since they will otherwise have too much 'spring;' much may be done by their mere *tearing* action; but if it be desired to use them as *cutting* instruments, all that is necessary is to harden and temper them, and then give them an edge upon a hone. It will sometimes be desirable to give a finer point to such needles than they originally possess; this also may be done upon a hone. A needle with its point bent to a right angle, or nearly so, is often useful; and this may be shaped by simply heating the point in a lamp or candle, giving to it the required turn with a pair of pliers, and then hardening the point again by re-heating it and plunging it into cold water or tallow.

Analysis of Methods of Preparation and Mounting which follow:—

1. Descriptions of microtomes, and *knife-holders* and *knife-position*.

2. Mounting objects in general.

3. Preparation of *soft* tissues, under the following subtitles:—

Fixation.

Dehydration.

Clearing.

Staining.

This last is further subdivided as follows:—

Stains for living objects.

Stains for fresh tissues.

Stains for fixed and preserved entire objects.

Nuclear stains for sections.

Plasmatic stains.

Imbedding methods under the following subtitles:—

Imbedding methods in general.

The paraffin method.

This last is further subdivided as follows:—

1. Saturation with a solvent.

2. Saturation with paraffin.

3. Arranging for cutting.
4. Cutting.
5. Flattening sections and mounting, with description of the best *serial section methods*.

The *celloidin* method, further subdivided as follows :—

- Celloidin imbedding in general.
 - Hardening the mass.
 - Fixing to microtome and cutting.
 - Staining and mounting, with description of *appropriate serial section methods*.
4. Preparation of *hard* tissues, under the following titles :—
 - Grinding and polishing sections, with descriptions of lathes.
 - Decalcification.
 - Desilicification.
 5. Sections dealing with
 - (a) Vegetable tissues.
 - (b) Staining bacteria.
 - (c) Staining flagella.
 - (d) Chemical testing.
 - (e) Preservative media.
 - (f) Cleanliness, and labelling.

Microtomes are machines devised for the purpose of obtaining extremely thin and uniform slices, or 'sections' as they are technically called, of animal or vegetable tissues, hard or soft. Some of the purposes to which these are adapted will be found to be answered by a very simple and inexpensive little instrument, which may either be held in the hand, or (as is preferable) may be firmly attached by means of a T-shaped piece of wood (fig. 389) to the end of a table or work-bench, or may be provided with a clamp for firm attachment to the work-table, as in fig. 390. This instrument essentially consists of an upright hollow cylinder of brass, with a kind of piston which is pushed from below upwards by a fine-threaded or 'micrometer' screw turned by a large milled head; at the upper end the cylinder terminates in a brass table, which is planed to a flat surface, or (which is preferable) has a piece of plate-glass cemented to it, to form its cutting bed. At one side is seen a small milled head, which acts upon a 'binding screw,' whose extremity projects into the cavity of the cylinder, and serves to compress and steady anything that it holds. For this is now generally substituted a pair of screws, working through the side of the cylinder, instead of one as in fig. 390. A cylindrical stem of wood, a piece of horn, whalebone, cartilage, &c., is to be fitted to the interior of the cylinder, so as to project a little above its top, and is to be steadied by the 'binding screw'; it is then to be cut to a level by means of a sharp knife or razor laid flat upon the table. The large milled head is next to be moved through such a portion of a turn as may very slightly elevate the substance to be cut, so as to make it project in an almost insensible degree above the table, and this projecting part is to be sliced off with a knife previously dipped

in water or, preferably, methylated spirit and water in equal parts. An ordinary razor will answer for cutting. The motion given to its edge should be a combination of *drawing* and *pressing*. (It will be generally found that better sections are made by working the knife *from* the operator than *towards* him.) When one slice has been thus taken off, it should be removed from the blade by dipping it into spirit and water, or by the use of a camel-hair brush; the milled head should be again advanced, and another section taken, and so on. It is advantageous to have the large milled head graduated, and furnished with a fixed index, so that this amount having been

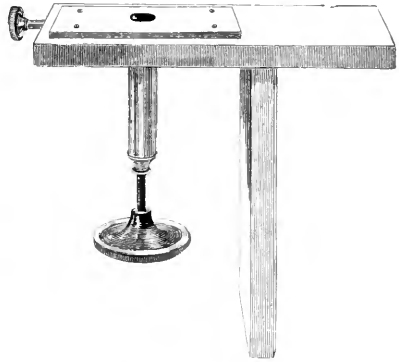

FIG. 389.—Simple microtome.

once determined, the screw shall be so turned as to always produce the exact elevation required. Where the substance of which it is desired to obtain sections by this instrument is of too small a size or of too soft a texture to be held firmly in the manner just described, it may be placed between the two vertical halves of a piece of carrot of suitable size to be pressed into the cylinder, and the carrot with the object it grasps is then to be sliced in the manner already described, the small section of the latter being carefully taken off the knife, or floated away from it, on each occasion, to prevent it from being lost among the lamellæ of carrot which are removed at the same time. Vertical sections of many leaves may be successfully made in this way, and if their texture be so soft as to be injured by the pressure of the carrot,

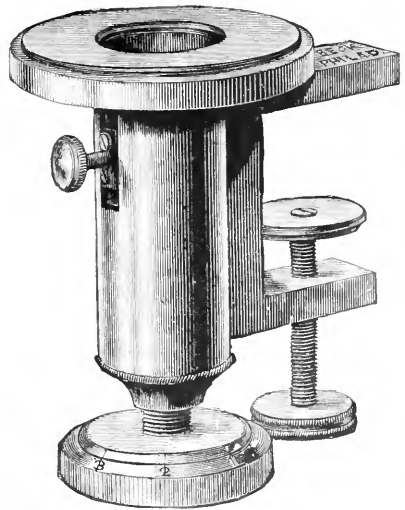

FIG. 390.—Microtome.

they may be placed between two half-cylinders of elder-pith, or be imbedded in any of the ways employed with the more elaborate microtomes about to be described.

The modern art of section-cutting, as practised by the most

accomplished experts, with the most complete of the many almost perfect recent microtomes, is one of the most refined and beautiful with which the scientific mind can concern itself. The combined cutting, staining, and mounting of the most delicate organic tissues in almost every conceivable state has thrown a light upon histological and pathological matters, the present and prospective value of which we can scarcely estimate too highly; while some of the profoundest and most interesting questions of biology are opening themselves to renewed research by its means.

Throughout this chapter we only seek to give the possessor of a good microscope a fair outline of the principal methods employed, and clues to the finest processes in detail, for histological, pathological, and embryological work. For full details we may refer him to the more or less exhaustive handbooks which the several subjects have called forth, the fullest account of the subject being that given in Mr. A. Bolles Lee's 'The Microtome's Vade-Mecum.' But we are at the same time convinced that if the student be but rightly directed as to instruments and the best way of employing them, and at the same time have the best general processes concisely indicated to him, he will soon discover what to him will be the most facile and satisfactory method of obtaining the best results. In the hands of an original worker prescriptions are only satisfactory starting-points to better methods. We shall therefore describe one microtome which we believe, on the whole, to be the best, and sufficiently indicate the character and peculiarities of two or three others, to enable the student, as we believe, to judge for himself in consideration of his future purpose as to which will best serve him in the object he has in view.

It will be as well, however, to note that extremely *thin* sections are not the supreme purpose of microtomes. Good sections, treated with success from beginning to end, are the first consideration. The tenuity of a section must be proportional to the character of the tissue.

Manifestly a tissue with injected arteries or veins must be thick enough to contain some of these vessels with their branches entire. If we require to study the hepatic cells or the renal tubules we must give depth enough in the sections to include these. But it will be found that the hardening and imbedding agents contract greatly, without distorting, the anatomical elements, and sections much thinner than would be normally required to completely disclose what is sought may be often successfully made in tissues so prepared.

It is none the less true that a mere race for extreme attenuation in sections is in every sense undesirable; and for *extremely* thin sections—say the $\frac{1}{8000}$ th of an inch in thickness, or less—only small sections should be attempted.

Here it may be advisable to state that the standard unit in microscopy, as accepted by the Council of the Royal Microscopical Society,¹ is the $\frac{1}{1000}$ th of a millimetre, which is indicated by the sign μ , being known as a *micron*.

¹ *Journ. Roy. Micro. Soc.*, ser. ii, vol. vii, pp. 502, 526; *Nat.*, xxxviii, p. 221.

The choice of microtomes, English, Continental, and American, is very large, and high merit is characteristic of many. But one of these, devised by Thoma and made by Jung of Heidelberg, entered the field early, having from the first been based on thoroughly sound practical principles; and as a result it has been susceptible of, and has lent itself to, every improvement suggested by the advancing refinements of this beautiful art of microtomy. In its latest form we describe and illustrate it, satisfied that it will in an almost perfect manner meet the general wants of the biologist's laboratory.

This (the Thoma) microtome is based upon the model of Ricet: but that has been immensely expanded in detail. The body of the instrument consists of three plates, the middle plate, *M*, and the side plates, *S* and *O*, fig. 391. These are fastened to the bottom plate by screws. *S* supports the knife-carriage, *MS*, which rests at

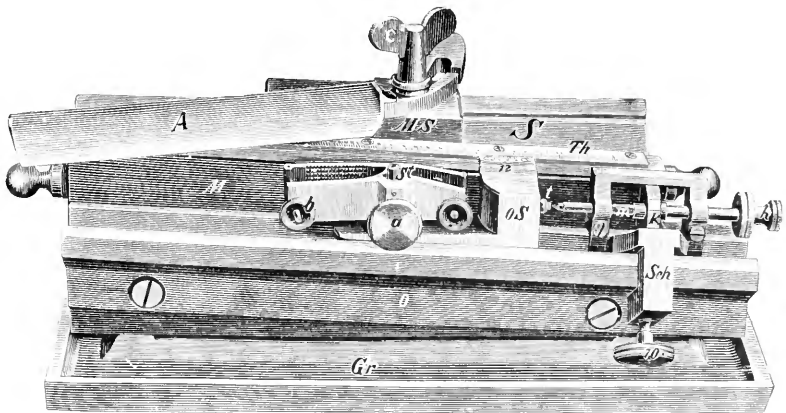

FIG. 391.—Jung's Thoma microtome.

three points on a planed and polished track; whilst on the side of the knife-carriage two other points slide upon the middle plate. Thus in the angle in which the block carrying the knife slides there are five points of contact on polished surfaces, the block itself having weight enough to keep the whole steady, so that at a touch it glides to and fro with a firmness and precision that could scarcely be attained in any other way.

The plate *O* is an inclined plane, its highest point being in the direction of *M*. The inclination of the angle is 1 : 20; it supports the object-holder, *OS*, which rests in its place exactly as does the knife-carriage, *MS*.

This plate also bears the scale *Th*, which, by means of a vernier on the object-holder, enables the thickness of the section to be read off.

The bottom plate is at once a base and a receiver for the dripping spirit, oil, &c.

For fastening the knife a thumb-screw, C, fig. 391, serves; but in the modified form of the instrument designed by the Zoological Station, Naples, this is replaced by a single head-screw, C, fig. 392, which is provided with holes and tightened by means of a lever; and to give greater freedom to the use of the knife there are several holes drilled and tapped into which this screw fits.

The knives of the form A, fig. 391, are generally screwed directly to the knife-carriage, and are used for cutting very large sections, the oblique position shown in the figure being the one that is generally indicated for the cutting of very large objects. This knife is now seldom used except in pathological observations and in studies on the central nervous system.

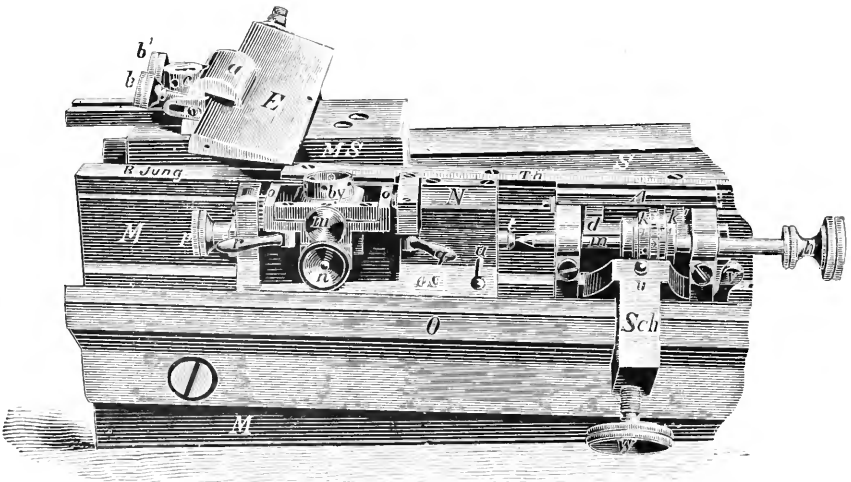

FIG. 392.—The Thoma microtome with the usual zoologist's knife.

The knife, however, is also made upon another model, E, fig. 392; it then has a special holder *a*, in which it is secured in a conical slit by the screws *b*, *b'*, and firmly held.

For deep objects requiring considerable length to cut from, there are plates provided for elevating the knives and the knife-holders.

The knife-holder shown in fig. 392 can be rotated round the axis formed by the screw *c*. This allows of any degree of slant or obliquity of direction being given to the knife, from the strictly transversal position shown in fig. 392 up to and beyond the slanting position shown in fig. 391. But it provides no means of altering the *tilt* of the blade, that is, of elevating or depressing the back of the blade relatively to its edge—a point of considerable importance, to which we shall return later on. To meet this difficulty, the maker (R. Jung, 12 Landhausstrasse, Heidelberg; his instruments, as well as price lists, may be obtained from Mr. C. Baker, 244 High Holborn, London) supplies wedges to be inserted under the knife-

holder. These (Neumayer's) wedges are horseshoe-shaped, so that they may be slipped round the central screw. They are made in pairs, one member of each pair having the opening of the horseshoe at the thin end, the other having it at the thick end. The wedge with the opening at the thin end is slipped *under* the knife-holder (*thin* end towards the operator), and operates to tilt up the back of the knife.

The sister wedge is then placed *over* the slotted stem or handle of the carrier, *thick end* towards the operator, in order that the binding-screw may have a horizontal surface to bear on. The wedges are sold in sets of three pairs, of different degrees of bevel.

This simple device is quite sufficient so long as the utmost precision of section-cutting is not required. For more elaborate work it is convenient to employ a special knife-holder, which provides a means of elevating or depressing the back of the blade by rotating the blade round its axis. Similar contrivances have been described by Dr. Hesse (in the 'Zeitschrift für wissenschaftliche Mikroskopie,' xiv. 1, 1897, p. 13; see 'Journal of the Royal Microscopical Soc.' 1897, p. 441), and by Prof. Apáthy ('Zeitschr.' xiv. 2, p. 15, and 'Journal,' 1897, p. 582). This last is rather complicated to work with, and consequently the Naples Zoological Station has worked out a new device, made by Jung, which it is hoped will meet all requirements. This is the 'Model L' of his price-list, and is figured in the 'Journal,' 1899, p. 546. That of Hesse is very simple, and ought to be quite sufficient where no considerable change of tilt is likely to be required. It is made by Jung.

Before leaving this part of the subject it appears advisable to consider briefly the question of *knife-position* in general—a matter on which success or failure in section-cutting may often entirely depend.

The position of the knife should be varied according to circumstances, both according as to its *slant* or obliquity in relation to the line of section, and as to its *tilt*, or the elevation of its back relatively to its edge.

As regards *slant*—the slanting position, fig. 391, is adapted for cutting soft and watery objects, not imbedded, and tissues imbedded in celloidin, or the like; for these cannot be cut with the knife placed transversely. It is also frequently indicated for paraffin objects; but on this head no general rule can be laid down. The transverse position, fig. 392, is indicated for cutting paraffin sections by the ribbon method (see below, Imbedding Methods, Paraffin), and also frequently for cutting loose sections by the paraffin method.

As regards *tilt*: (1) The knife must *always* be tilted enough to lift the under facet of the edge clear of the tissue as it passes over it, for if not the tissues will be crushed by it as it passes over them. (2) It must not be too much tilted, or it will not bite, but will act as a scraper. Prof. Apáthy, who has investigated the subject in an instructive paper in the 'Sitzber. d. med.-naturw. Section d. Siebenburgischen Museenvereins, Kolozsvár,' xix. 1897, H. 7, concludes as follows: (1) The knife should always be tilted somewhat more than enough to bring the under cutting-facet of the

edge clear of the object. (2) It should in general be less tilted for hard and brittle objects than for soft ones, therefore, *ceteris paribus*, less for paraffin than for celloidin. (3) The extent of useful tilt varies (according to the angle to which the knife is ground, amongst other factors) between 0° and 16° . (Jung's ordinary knife-holders have mostly a tilt of about 9° , which is only enough, with the usual plane-concave knives, for cutting ribbons of sections with hard paraffin.) (4) Excessive tilt causes paraffin sections to roll, and may produce longitudinal rifts in them. It may also set up vibrations in the blade, which are heard as a humming tone, and which give an undulatory surface to the sections. Excessive tilt may often be recognised by the knife giving out a short metallic note just as it leaves the object. For knives with plane under-surfaces it is seldom advisable to give less than 10° tilt; whilst knives with concave under-surfaces on the contrary may require to be placed almost horizontal. A knife with too little tilt will cut a second section, or a portion of one, without the object having been raised; showing

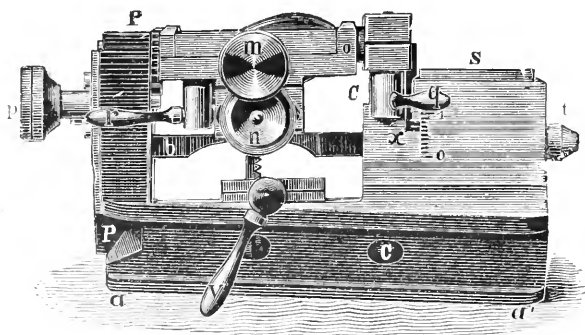

FIG. 393.—Object-holder with jaws.

that during the first cut the object was pressed down by the knife and recovered itself afterwards. This fault is denoted by the ringing tone given out by the knife on passing *back* over the object before it is raised. Ribbon-cutting requires a relatively hard paraffin and less tilt. With celloidin it is very important to avoid insufficient tilt, as the elastic celloidin, with too little tilt, yields before the knife and is not cut.

The exigencies of section-cutting have given rise to a *great variety of object-holders* in this instrument. The simplest is seen in OS, fig. 391, which is a pair of jaws clamped by screws and fixed upon the pivot *St* by the milled head *a*. At *a* is the vernier, which indicates the position on the mm. scale, *Tz*, and *t* is an agate highly polished, upon which the micrometer screw *m* works to drive forward the object-carrier, OS.

The *Zoological Station at Naples* employs a holder specially designed for use with paraffin; the object is soldered with paraffin on to the cylinder, *b g*, fig. 392. This is supported on gimbals and may

be shifted vertically and horizontally by means of the small screw *a*, and is fastened by means of the milled head, *m*. By the pinion *n* it may be displaced over 90° , and as great an inclination can be taken in a plane perpendicular to this by the supporting metal frames by means of the pinion *p*. In this way every desired inclination of the object to the knife can be readily secured.

Fig. 393 presents the same object-holder, but instead of the cylinder a simple pair of jaws with the screw *m* to secure objects of every variety. A cylinder-holder as in fig. 393 can be placed in these jaws from which the benefits of the Neapolitan holder can be secured. But fig. 396 shows a still greater improvement which can be applied to both object-holders, viz. a perpendicular displacement by means of a cog and pinion governing the height of the mass from which the sections are to be cut.

The elevator in fig. 393 is supported on one side by the prism *P*, and on the other by the rod *C*; these are joined by the bridge *b*,

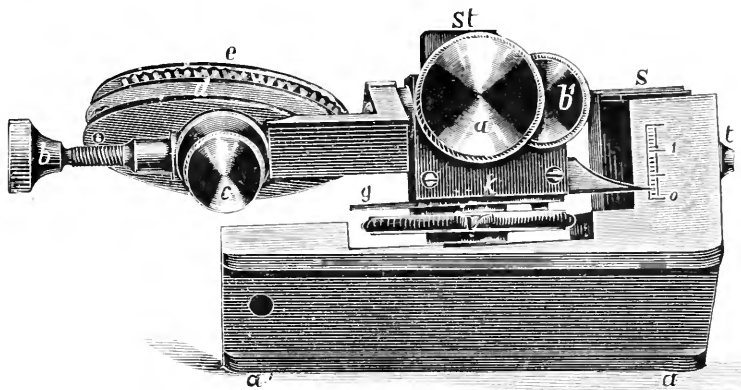

FIG. 394.—Object-holder movable about two horizontal axes at right angles to each other.

to which a cogged bar is fastened, into which a pinion catches, which is moved by the lever *V*, allowing a perpendicular displacement of the object of 12 mm. At *O* is the millimetre scale on which the perpendicular displacement can be read off by means of the index *o*.

An object-holder movable about two horizontal axes situated perpendicularly to each other is seen in fig. 394. These positions are fixed by the milled heads *b'*, *b*; *e* shows the jaws for holding the object, into which, however, cylinders like fig. 396 may be introduced. This object-holder has a perpendicular displacement controlled by a screw. The part, *K*, which supports the chief axis of the jaws, is fitted on to the triangular prism *St*, the lower part of which is furnished with hinges; on the hinge the screw *V* moves, which at its upper end lies close to *K*, and is sustained in this position by the steel plate *g*, so that *K* is carried up and down with it, and this movement is read off by a scale under *S*.

Fig. 395 presents an *object-holder intended to analyse by diversified section* objects which are wedged or fan-shaped in form on a fixed axis, but may be applied to other purposes.

B is a prism-shaped, semicircularly bent bar, moving in the slot FF¹; at *b* and *b'* the jaws occupy the position common to those of the ordinary form.

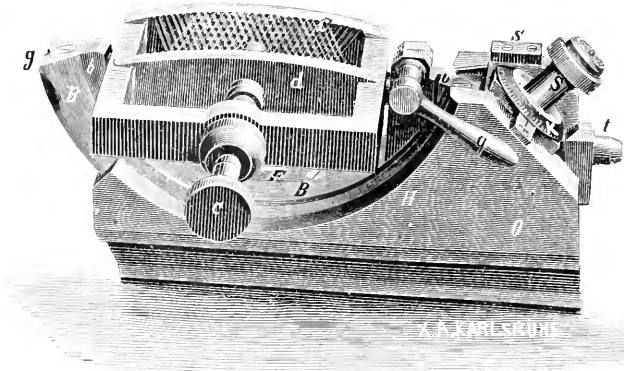

FIG. 395.—Object-holder for analysis by diversified section.

On the circumference of B a spiral is cut, which becomes slightly visible at *g*; into this spiral a screw passes at H, which is turned by the milled head S, which can alter the position of the arc to the horizontal to the extent of 1 mm.; and the amount of the change of position can be read off on the graduated circle K.

In a fixed position the middle of this section-holder is the plane of action of the knife. If an object be fixed in the jaws so that the

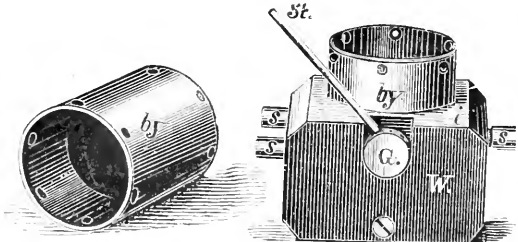

FIG. 396.—Cylinder for use with jaws.

fixed axis of it lies in this plane, it will only be required that the screw S be brought into action to obtain wedge-shaped sections of whatever thickness is required, which will all be made in this axis.

The set of cylinders which may be used with these and other jaws is represented in fig. 396; *by* is the cylinder, G the compressing screw for it, the block W being held in the jaws.

The object slide with its vernier may be slidden up the incline by

hand; but it is much more accurate to control its movement with the micrometer-screw. The point of this screw in fig. 392, *t*, works on the polished plane of an agate cone. The clamp on which the screw is mounted is held firmly in its place by the milled head *W* in *Sch*. It may stretch up as far as *O*, being refastened by *W*.

The screw *m* is so cut that a single rotation moves the slide on the $\frac{3.000}{10000}$ mm., which in the inclination of the plane of 1 : 20 gives an elevation of the object of $\frac{1.500}{10000}$ mm. The barrel or drum, *K*, situated on the axis of the screw, is divided into fifteen parts; consequently the interval of each division corresponds to an elevation of $\frac{1}{10000}$ mm.

There is also an action by means of a spring which gives the ear as well as the eye cognisance of the amount of elevation which has taken place, which greatly relieves the eye. This, however, can be brought into action or not at the option of the operator.

Besides these object-holders a freezing apparatus can be added which is simply placed on the object-slide as shown in fig. 397.

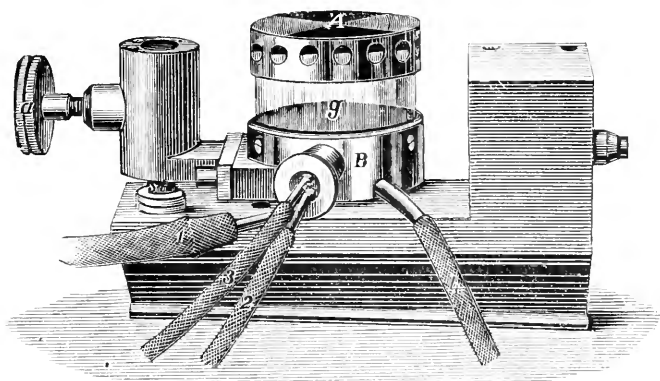

FIG. 397.—Freezing apparatus for the Thoma microtome.

The freezing is effected by ether-spray. A specially favourable effect is obtained if the cylinder *g* is mica and not glass. A layer of water freezes in from thirty to thirty-five seconds.

An arrangement of the Thoma for cutting *large* objects has also been devised which is illustrated in fig. 398.

The knife is to be placed considerably higher in front than behind, in order to lessen the pressure on the objects. In order to satisfy all demands, the knife-rest is adjustable.

The knife is so arranged that the whole length of blade can be used, and then the screw *e* is fairly tightly screwed down. As strong knives, even of a length of 36 cm., easily give, a knife-support has been constructed; this is fastened by the screw *e'* to the carrier. The support is arranged parallel with the back of the knife *M*: if the extremity *u* be slightly pressed backwards, so that it touches the

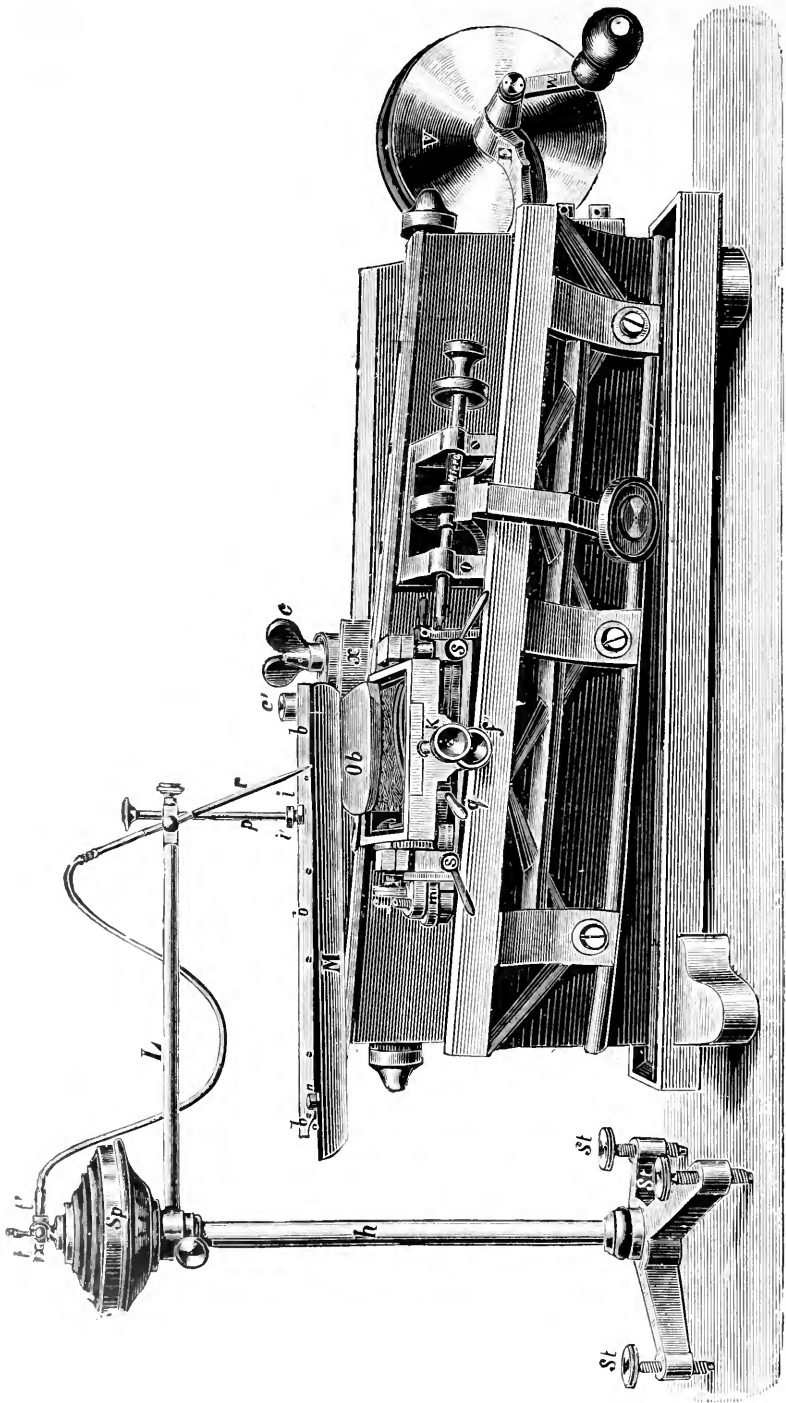

FIG. 398.—Jung's sliding microtome for very large objects.

knife, it is then fixed in this position by the screw *o* (scarcely evident in the illustration).

This done, the spirit-vessel *Sp* can be arranged in a position which will not interfere with the free movement of the knife. In order that a stream of spirit may follow the knife over the object, the following arrangement is adopted. The spirit-vessel *Sp* turns round an axis on the column *b*; to it is joined the arm *L*, which carries in front the fine tube *r* (connected with *tt'*), and also the rod *p*; the latter is movable perpendicularly, and to its lower end a bridge or grip with two small rollers *i* and *i'* is fastened. The rod *p* is so placed that on each side of the metal strip *b*, screwed on to the knife-support, there is one of the rollers. By the adjusting screws *St*, the whole apparatus is so arranged that, when the knife-carrier is in motion, no other friction occurs than that of the rollers on the strip *b b b*.

The vessel is filled by screwing off the head *Z*. As the tube *r* acts as a siphon, it is necessary, when the cock is turned on, to blow down the tube. The stream of spirit should be directed at a right angle to the knife, and about the middle of the object. This done, the object *Ob*, by means of the screw *K*, is firmly grasped in the fangs of the object-carrier; the correct direction for the position of the knife is given to its surface by the screws at *f* and *f'*, and then the axes of the fangs are tightened up by the levers *q* and *q'*. If the height of the object is not quite correct, adjustment is made by the screw *m*. By turning the screws *S, S* the holder is fixed.

V is a wheel with cranked axle *Eor*, and this by means of a cat-gut band moves the knife.

For the *rapid* production of *ribbons of sections*, however, the instrument *par excellence* is the Cambridge rocking microtome. It is illustrated in fig. 399.

The principle is the employment of a rotary instead of a sliding movement of the parts. Two uprights are cast on the base-plate, and are provided with slots at the top, into which the razor is placed and clamped by two screws with milled heads. The inner face of the slot is so made as to give the razor that inclination which has in practice been found most advantageous. The razor is thus clamped between a flat surface and a screw acting in the middle of the blade, and the edge of the razor is consequently in no way injured.

The imbedded object is cemented with paraffin into a brass tube which fits tightly on to the end of a cast-iron lever. This tube can be made to slide backwards or forwards, so as to bring the imbedded object near to the razor ready for adjusting. It is now furnished with a mechanical arrangement for accurately adjusting the position of the object. The cast-iron lever is pivoted at about 3 in. from the end of the tube. To the other end of this lever is attached a cord by which the motion is given, and the object to be cut brought across the edge of the razor. The bearings of the pivot are V-shaped grooves, which themselves form part of another pivoted system.

Immediately under the first pair of V's is another pair of inverted V's, which rest on a rod fixed to two uprights cast on the base-plate.

A horizontal arm projects at right angles to the plane of the two sets of V's, the whole being parts of the same casting. On the end of the horizontal arm is a boss with a hole in it, through which a

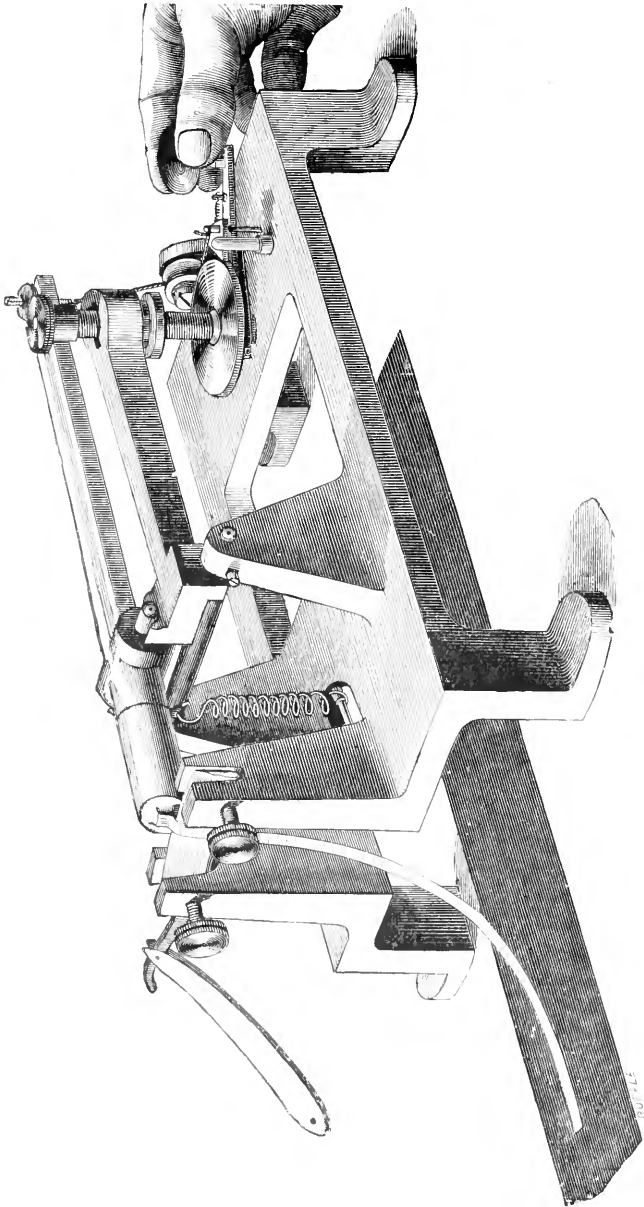

FIG. 339.—The Cambridge rocking microtome.

screw passes freely. The bottom of the boss is turned out spherically, and into it fits a spherical nut working on the screw. The nut is prevented from turning by a pin passing loosely through a slot in the boss. The bottom of the screw rests on a pin fixed in the base-plate.

It will be seen that the effect of turning the screw is to raise or lower the end of the horizontal arm, and therefore to move backwards or forwards the upper pair of V's, and with them the lever and object to be cut. The top of the screw is provided with a milled head, which may be used to adjust the object to the cutting distance. The distance between the centres of the two pivoted systems is 1 in., and the distance of the screw from the fixed rod is $6\frac{1}{4}$ in. The thread of the screw is 25 to the inch; thus, if the screw is turned once round, the object to be cut will be moved forward $\frac{1}{25}$ of $\frac{1}{6\frac{1}{4}}$ or $\frac{1}{156}$ in.

The turning of the screw is effected automatically as follows: A wheel with a milling on the edge is fixed to the bottom of the screw; an arm to which a pawl is attached rotates about the pin which supports the screw. This arm is moved backwards and forwards by hand or by a cord attached to any convenient motor. When the arm is moved forward the pawl engages in the milling and turns the wheel; when the arm is moved back the pawl slips over the milling without turning the wheel. A stop acting against the pawl itself prevents any possibility of the wheel turning, by its own momentum, more than the required amount. The arm is always moved backwards and forwards, between two stops, a definite amount, but the amount the wheel is turned is varied by an adjustable sector, which engages a pin fixed to the pawl and prevents the pawl from engaging the milling of the wheel. By adjusting the position of this sector, the feed can be varied from nothing to about $\frac{5}{32}$ of a turn; and hence, since the screw has 25 threads to the inch, the thickness of the sections cut can be varied from a minimum, depending on the perfection with which the razor is sharpened, to a maximum of $\frac{5}{32}$ of $\frac{1}{25}$ of $\frac{1}{6\frac{1}{4}}$, or $\frac{1}{1000}$ of a turn. The practical minimum thickness obtainable with a good razor is approximately $\frac{1}{400000}$ inch. The values of the teeth on the milled wheel are as follows:—

1 tooth of the milled wheel	= $\frac{1}{400000}$ in. = '000625 mm.
2 teeth " "	= $\frac{1}{200000}$ in. = '001250 mm.
4 " " "	= $\frac{1}{100000}$ in. = '0025 mm.
16 " " "	= $\frac{1}{25000}$ in. = '01 mm.

The movement of the lever which carries the imbedded object is effected by a string attached to one end of the lever. This string passes under a pulley and is fastened to the arm carrying the pawl. Attached to the other end of the lever is a spring pulling downwards. When the arm is moved forward the feed takes place, the string is pulled, the imbedded object is raised past the razor, and the spring is stretched. When the arm is allowed to move back, the spring draws the imbedded object across the edge of the razor, and the section is cut. The string is attached to the lever by a screw which

allows the position of the imbedded object to be adjusted, so that at the end of the forward stroke it is only just past the edge of the razor. This is an important adjustment, as it causes the razor to commence the cut when the object is travelling slowly, and produces the most favourable conditions for the sections to adhere to each other.

The following are perhaps the most prominent advantages of this instrument: (1) The price is low. (2) Manipulation is simple. (3) The work is rapid, and extremely accurate. (4) There are no delicate working parts which can get out of order, and the whole instrument is easily taken apart for packing, and is very portable.

The above description refers to the original form of the instrument. Later, the Cambridge Scientific Instrument Company have brought out an improved form, at a higher price. For most purposes the original form will suffice. The instrument is said by the makers to cut celloidin objects; but for this purpose a sliding microtome will certainly be found preferable.

The Minot microtome, of which a description may be found in the 'Journal of the Royal Microscopical Society,' 1889, p. 143, is a neat instrument designed, like the Cambridge rocker, for cutting ribbons of paraffin-imbedded objects. It is worked on the sewing-machine principle, and cuts very rapidly. But its work is not so fine as that of the Cambridge instrument, possibly on account of insufficient compensation in the working parts. This defect is said to have been satisfactorily overcome in the beautiful instrument, constructed on the same principle, of Reinhold, a description of which may be found in the journal above quoted, 1893, p. 706. The work afforded by this instrument is certainly of the highest order, but the price is against it, as it costs about 20*l*. Both of these instruments are said to be able to cut celloidin sections; but it is self-evident that they are not so well adapted for that purpose as the sliding microtome.

It is unnecessary here to do more than allude to the large and cumbersome instruments specially designed for cutting sections of brain. Such is the microtome of Strasser, of which a description may be found in the 'Journal of the Royal Microscopical Society,' 1892, p. 703, and that of Gudden and others. They are only required for certain very special neurological researches, and are not at all adapted to the wants of the zoologist or histologist in general. For these, we may here repeat, the all-round instrument *par excellence* is Jung's medium-sized Thoma microtome, No. IV., to which, if lengthy series of paraffin sections be frequently required, a Cambridge rocker may conveniently be added.

But it is needful also to describe one or more of the best instruments designed specially for cutting sections by *congelation* or *freezing* of the imbedding mass. Dr. R. A. Hayes designed an ether freezing microtome with the object of affording to those who have occasional need to cut sections of tissues for pathological investigations, &c., the means of doing so quickly, conveniently, and accurately. It is illustrated in fig. 400. It is very compact, solidly constructed, and simple in plan. It freezes rapidly, and permits sections of large

surface to be made with precision, sections 1 in. \times $\frac{1}{8}$ in. having been cut by it without difficulty.

It consists of a solid cast-iron base, A, 10 in. \times $4\frac{1}{2}$ in., which rests upon a mahogany block. Extending the whole length of the upper surface of the base is a V-shaped gutter, on the planed sides of which slides a heavy metal block, B, on the flat top of which the razor is secured (any ordinary razor can be used), the tang being grasped between two flat pieces of iron, which are pressed together by a winged nut, C. The razor by this arrangement can be secured at any desired angle to the direction of its motion to and fro.

The freezing-chamber is formed by a short vulcanite cylinder, D, its lower end being screwed into a brass base, E. To its upper end is fastened by two bayonet-catches a brass plate, F, on which the tissue to be cut is placed. Inside the cylinder, D, and rising from the base, E, is an ordinary spray, the air and ether being supplied through tubes, *g* and H, passing outside through the base. There

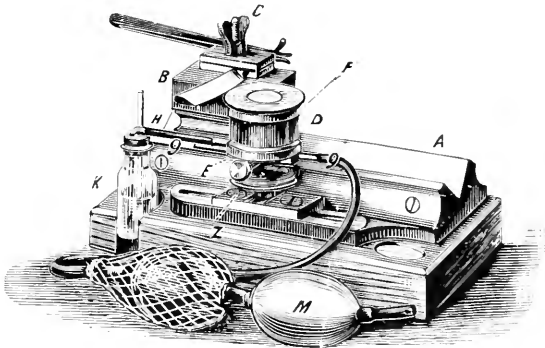

FIG. 400.—Dr. Hayes's ether freezing microtome.

is also an opening in the floor of the chamber communicating with the tube, to allow the overflow of ether in case of any accumulation inside the cylinder: any such overflow may be returned by the tube to the ether supply bottle, K. The freezing-chamber is secured to the top of the micrometer-screw arrangement, Z, which is of the simplest form, but has a perfectly smooth and regular motion. The nut is divided to indicate a section 0.01 mm. in thickness, but half this thickness can be cut without difficulty.

The method of using the microtome is very simple. The slide and block, D, having been carefully rubbed clean and well oiled, the razor is clamped at any desired angle, the bottle, K, is filled with ether (good dry methylated ether answers perfectly), and the piece of tissue to be cut, having been previously saturated with thick gum solution, is placed upon the plate F, and the spray which plays upon the under surface of the plate, F, set working by the hand-pump, M; in a short time the tissue will be frozen quite through, and if a number of sections are required, an occasional stroke or two of the

pump will keep the gum in proper condition for cutting. The sections are easily cut, as in other microtomes of this class, by alternate movements of the screw, Z, and strokes of the razor.

The instrument may also be used for cutting tissue imbedded in paraffin or other mass, the object to be cut being secured in position either by being gently heated at its under surface and pressed on the plate, F, to which it firmly adheres on cooling, or by a simple clamping arrangement, which can be substituted for the freezing-chamber. When used in this way large numbers of sections may be cut in series by attaching to the razor a light support to receive the sections as they are cut.

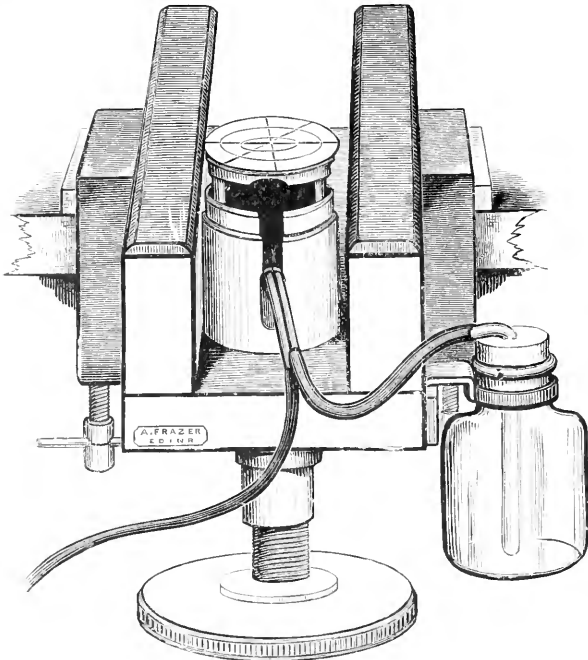

FIG. 401.—Catheart's freezing microtome.

Another most serviceable and admirable, because inexpensive and efficient, microtome, especially for freezing purposes, was devised by Mr. Catheart; and it is now presented in a simplified and improved condition. The instrument is illustrated in fig. 401.

In this form the clamping arrangements are much more perfect than in the old form; the principal screw and its milled head are larger and more convenient; the freezing-plate is circular, and is provided with an arrangement for preventing the ether, with which the freezing is effected, from reaching the upper side of the plate; and the instrument is now so modified that it can be used for ordinary imbedding as well as freezing.

The increased size of the screw gives a more steady movement than was possessed by the older and smaller microtome, while the greater circumference of the screw-head enables an operator to impart a finer movement to the screw. The relation between the pitch of the screw and the circumference of its head is such that if the edge be moved forward a quarter of an inch, an object will be raised one-thousandth of an inch; and if it be moved an eighth of an inch, the object will be raised a two-thousandth of an inch.

In the original instrument the plate was supported on two pillars, in order that as little heat as possible might be conveyed to the freezing-plate from the body of the instrument. In the new instrument the size of the three supporting pillars and screws is so much reduced that the conducting surface is not greater than in the old microtome. The arrangement for cutting imbedded sections consists of a tube which fits the principal well of the microtome, and within which fits a hinged part similar to an ordinary vice. With the instrument are provided the means of preparing paraffin blocks for imbedding sections.

When it is intended to use the microtome for imbedding, the

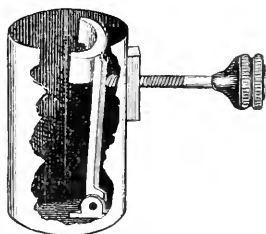

FIG. 402.—Holder for Cathcart's microtome.



FIG. 403.—Dropping-bottle.

ether spray, spray-bellows, and ether-bottle should be removed, and the freezing-tube, having been raised as far as possible by means of the principal screw, should then be withdrawn from the well. The imbedding tube, fig. 402, is now placed in the well, and, having been pushed down until it rests upon the point of the large screw, it may be lowered to a convenient height by working the large screw backwards.

Mr. Cathcart recommends in freezing with this instrument that a few drops of mucilage (1 part gum to 3 parts water) be placed on the zinc plate, and that a piece of the tissue be cut, of about a quarter of an inch in thickness, and pressed into the gum; the ether-bottle, filled with anhydrous methylated ether, is taken and the spray points pushed into their socket. All spirit must of course have been previously removed by soaking for a night in water. The tissue should afterwards be soaked in gum for a like time before being cut. The operator must now work the spray-bellows briskly until the gum begins to freeze; after this, work more gently. Raise the tissue by turning the milled head, and cut by sliding the knife along the glass plates.

Mounting.—By the term ‘mounting’ is meant the arranging of specimens on slides in such media and in such a manner as are most favourable for the demonstration of their minute structure by the microscope. In the case of the most numerous and important class of objects that it is the function of the microscope to scrutinise, namely, those derived from the substance of animal or vegetable organisms, it is found that no methods of mounting will avail to reveal their minute structure unless the specimens have first been submitted to the frequently very elaborate processes of previous preparation to be hereafter described under the heads of *Fixing*, *Imbedding*, *Section-cutting*, *Staining*, and the like. But still there are many objects of interest and beauty that can be satisfactorily mounted without the aid of these elaborate processes of previous preparation. And as also the manipulations of mounting *sensu stricto* are in principle the same in both cases, it appears advisable to make the description of the processes of mounting precede that of the processes of previous preparation; merely warning the beginner that in the case of the majority of specimens intended to illustrate the minute structure of the tissues of either animals or plants, such previous preparation is a *sine qua non*.

The manipulations of mounting will alone be described here, the most useful *mounting media* being described later on (‘Preservative and Mounting Media’).

In dealing with the small quantities of fluid media required in mounting microscopic objects, it is essential for the operator to be provided with the means of transferring very small quantities from the vessels containing them to the slide, as well as of taking up from the slide what may be lying superfluous upon it. Where some one fluid, such as glycerin, is in continual use, it will be found very convenient to keep it in the small dropping-bottle represented in fig. 403. The stopper is perforated, and is elongated below into a fine tube, whilst it expands above into a bulbous funnel, the mouth of which is covered with a piece of thin vulcanised indiarubber tied firmly round its lip. If pressure be made on this cover with the point of the finger, and the end of the tube be immersed in the liquid in the bottle, this will rise into it on the removal of the finger; if, then, the funnel be inverted, and the pressure be reapplied, some of the residual air will be forced out, so that by again immersing the end of the tube, and removing the pressure, more fluid will enter. This operation may be repeated as often as may be necessary, until the bulb is entirely filled; and when it is thus charged with fluid, as much or as little as may be needed is then readily expelled from it by the pressure of the finger on the cover, the bulb being always refilled if care be taken to immerse the lower end of the tube before the pressure is withdrawn. We speak from large experience of the value of this little implement, which is very clean, simple, and useful. But the small pipettes now used so commonly for filling the stylographic pens, fitted into the centre of a cork and placed in any wide-mouthed bottle, will be found to be, though less elegant, equally useful and much less costly.

Solutions of Canada balsam and gum-dammar in volatile fluids

are best kept in wide-mouthed *capped* jars, the liquid being taken out on a pointed glass rod, cut to such a length as will enable it to stand in the jar when its cap is in place. Great care should be taken to keep the inside of the cap and the part of the neck of the jar on which it fits *quite clean*, so as to prevent the fixation of the neck by the adhesion between these two surfaces. Should such adhesion take place, the cautious application of the heat of a spirit-lamp will usually make the cap removable. In taking out the liquid care should be taken not to drop it prematurely from the rod—a mischance which may be avoided by not taking up more than it will properly carry, and by holding it in a horizontal position, after drawing it out of the bottle, until its point is just over the slip or cover on which the liquid is to be deposited.

A bottle for use with reagents, enabling the operator to pour out only the quantity he desires, is invaluable. Small capped and stoppered bottles, the stoppers of which are *tubes*, and the well-fitting caps of which prevent evaporation, are very valuable for aqueous and thin fluids. We illustrate this bottle in fig. 404. All that is needful is to take the bottle, with the cap off, in the warm hand, and by slight expansion a drop or more as required is exuded. These bottles are easily procurable.

But we like still better the small German bottles, shown in fig. 405, containing about 30 grammes, in

which two deep grooves are cut on opposite sides of the stopper, so arranged that by giving the stopper half a turn one groove is connected with a hole in the neck of the bottle: this will be seen at *a* in fig. 405; the air travels down this groove, and by inverting the bottle the fluid enters the other groove of the stopper and finds its way to a third groove cut in the inside of the neck and extending to the lip. The figure shows the bottle complete.

Mounting Thin Sections.—It is customary to recommend the use of 'section lifters' in order to raise delicate sections out of the fluid in which they finally are placed into the position in which they are to be mounted. For very large sections they are probably essential; but from personal experience, supported by the most accomplished histological mounters of our time, we believe them to be adverse to, rather than promotive of, good section-mounting. One of the many patterns recommended is shown in fig. 406, where it will be seen that one end of the 'lifter' is perforated, for the purpose of drainage, and the other is plain.

The present writer cannot endorse the recommendation of this

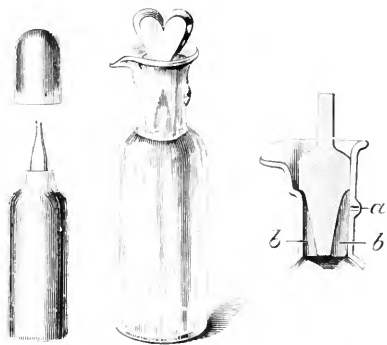

FIG. 404.
Expansion drop-
bottle.

FIG. 405.
German drop-bottle.

instrument, but prefers a smooth glass rod or tube; the section in fluid can easily be made to wrap itself round the rod, from which it may be rolled off into a drop of liquid placed on the slide. It must be manifest that the *less* we have to manipulate such delicate sections as we are now considering, the better; to get a section on and off the 'lifter' is a needless process. We should, as stated above, *mount on the cover-glass*, and this cover should be the only lifter employed.

The cover must be carefully cleaned, and properly selected as to size and tenuity. By means of a needle or the handle of an ivory dissecting-knife the clearing fluid in which the section is resting prior to mounting is gently disturbed, in a good-sized vessel or saucer, until the section desired is in its proper position on the cover. Now lay the cover, section upwards, on fresh blotting-paper, to take off the superfluous liquid from the free side of the cover, and then hold the edge of the slip at an angle, more or less acute, with the section towards the blotting-paper, but never suffering the former to touch the latter; when this has removed the superfluous

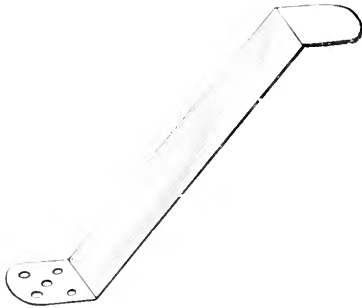

FIG. 406.

liquid from the section, lay the cover, section upwards, on a glass slip, put on (say) the benzol balsam until it stands in an evenly diffused mound covering the section, and lay it aside absolutely protected from dust for twenty-four hours in order that the benzol may evaporate.

Now take it out, place upon the centre of the section one small drop of fresh benzol balsam, and turn the cover over on to a warm slip, being careful to have guides to the position on

the slip on which it should be fixed; and in an hour or so we may clean off superfluous balsam and finish the slide.

To those who mount much this will prove the quicker plan, as, for fine results, it is undoubtedly the better.

The above considerations refer only to *loose sections in fluid*, or thin membranes, or other thin and isolated objects. It is one of the advantages of the paraffin process that with paraffin sections no lifter is required, as these are cut dry, and being stiffened by the paraffin may be lifted by means of a flat camel's-hair brush, or a scalpel or forceps. The manipulations of mounting *series of sections* on one slide are described under 'Imbedding Methods.'

When the preparation has been previously immersed in *aqueous liquids*, and is to be mounted in glycerin, glycerin jelly, or Farrant's medium, the best mode of placing it on the slide is to float it in a saucer or shallow capsule of water, to place the slide or cover beneath it, and, when the object lies in a suitable position above it, to raise the slide or cover cautiously, holding the object in place by a needle, until it is entirely out of the water; and the small quantity

of liquid still surrounding the object is to be carefully drawn off by blotting-paper, care being taken not to touch the object with it (as its fibres are apt to adhere) or to leave any loose fibres on the slide. Before the object is covered, it should be looked at under a dissecting or mounting microscope, for the purpose of improving (if desirable) its disposition on the slide, and of removing any foreign particles that may be accidentally present. A drop of the medium (liquefied, if necessary, by a gentle warmth) is then to be placed upon it, and another drop placed on the slip or cover and allowed to spread out. The cover being then taken up with a pair of forceps must be inverted over the slide, and brought to touch it at one part of its margin, the slide being itself inclined in the direction of the place of contact, so that the medium accumulates there in a little pool. By gently letting down the cover, a little wave of the medium is pressed before it, and, if enough of the medium has been deposited, the whole space beneath the cover will be filled, and the object completely saturated. If air-bubbles should unfortunately show themselves, the cover must be raised at one margin, and a further quantity of the medium deposited.

If, again, there are no air-bubbles, but the medium does not extend itself to the edge of the cover, the cover need not be raised, but a little may be deposited at its edge, whence it will soon be drawn in by capillary attraction, especially if a gentle warmth be applied to the slide. It will then be advantageous again to examine the preparation under the dissecting microscope; for it will often happen that an opportunity may thus be found of spreading it better by the application of gentle pressure to one part or another of the covering-glass, which may be done without injurious effect either with a stiff needle or by a pointed stick; a method whose peculiar value, when viscid media are employed, was first pointed out by Dr. Beale. The slide should then be set aside for a few days, after which its mounting may be completed. Any excess of the medium must first be removed. If glycerin has been employed, much of it may be drawn off by blotting-paper (taking care not to touch the edge of the cover, as it will be very easily displaced); and the remainder may be washed away with a camel's-hair brush dipped in water, which may be thus carried to the edge of the cover. The water having been drawn off, a narrow ring of liquefied glycerin jelly may be made *around—not on*—the margin of the cover (according to the suggestion of Dr. S. Marsh) for the purpose of fixing it before the cement is applied; and when this has set, the slide may be placed on the turntable, and the preparation 'sealed' by a ring either of gold-size or of Bell's cement, which should be carried a little *over* the edge of the cover, and outside the margin of the ring of glycerin jelly. This 'ringing' should be repeated two or three times; and if the preparation is to be viewed with 'oil-immersion' lenses, it should be finished off with a coat of Hollis's glue or Bell's cement, which are not attacked by cedar oil. Until the cover has been perfectly secured, a slide carrying a glycerin preparation should never be placed in an inclined position, as its cover will be almost sure to slide by its own weight. If glycerin jelly or Farrants' medium has been employed,

less caution need be used, as the cover-glass, after a few days' setting, will adhere with sufficient firmness to resist displacement. The superfluous medium having been removed by the cautious use of a knife, the slide and the margin of the cover may be completely cleansed by a camel's-hair brush dipped in warm water; and, when quite dried, the slide, placed on the turn-table, may be sealed with gold-size—any other cement being afterwards added, either for additional security or for 'appearance.'

It is well in mounting in glycerin jelly to soak the object previously in dilute glycerin, and we prefer to 'ring' with benzole and balsam, which should harden. Then coat the ring with shellac varnish two or three times and permanently finish with thin coats of gold-size.

When, on the other hand, the section or other preparation is to be mounted in a *resinous medium*, it must have been previously prepared for this in the modes described further on, which will present it to the mounter either in some essential oil, or in xylol or benzol or the like, or in alcohol. From either of these it may be transferred to the cover or slide in the manner already described.

The thin sections cut by the microtome, or membranes obtained by dissection, do not require to be placed in cells when mounted in any *resin* medium: since its tenacity will serve to keep off injurious pressure by the cover-glass.

Mounting Objects in 'Natural' Balsam.—Although it is preferable for histological purposes to employ a solution of hardened balsam, as directed under 'Mounting Media,' yet as there are many objects for mounting for which the use of the 'natural' balsam is preferable, it will be well to give some directions for its use. When sections of hard substances have been ground down on the slides to which they have been cemented, it is much better that they should be mounted without being detached, unless they have become clogged with the abraded particles, and require to be cleansed out—as is sometimes the case with sections of the shells, spines, &c., of echinoderms, when the balsam by which they have been cemented is too soft. If the detachment of a specimen be desirable, it may be loosened by heat, and lifted off with a camel's-hair brush dipped in oil of turpentine. But, where time is not an object, it is far better to place the slide to steep in ether or chloroform in a capped jar until the object falls off of itself by the solution of its cement. It may then be thoroughly cleansed by boiling it in methylated spirit, and afterwards laid upon a piece of blotting-paper to dry, after which it may be mounted in fresh balsam on a slide, just as if it had remained attached. The slide having been warmed on the water-bath lid, a sufficient quantity of balsam should be dropped on the object, and care should be taken that this, if previously loosened, should be thoroughly penetrated by it. If any air-bubbles arise, they should be broken with the needle-point. The cover having been similarly warmed, a drop of balsam should be placed on it, and made to spread over its surface; and the cover should then be turned over and let down on the object in the manner already described. If this operation be performed over the water-bath, instead

of over the spirit-lamp, there will be little risk of the formation of air-bubbles. However large the section may be, care should be taken that the balsam is well spread both over its surface and that of its cover; and by attending to the precaution of making it accumulate on one side by sloping the slide, and letting down the cover so as to drive a wave before it to the opposite side, very large sections may thus be mounted without a single air-bubble. (The Author has thus mounted sections of *Eozoon* three inches square.) In mounting minute balsam objects, such as *diatoms*, *polycystinæ*, *sponge-spicules*, and the beautiful minute spines of *ophiurida*, no better plan can be adopted than to arrange these objects carefully upon the cover, either by 'scattering' or 'arrangement,' and then to drop on to the whole cover and its arranged objects as much balsam as the cover will receive without overflow; this should stand free from dust for some hours, after which the partly hardened balsam may receive a small drop of fresh balsam, and being placed upon the slip in proper position, may by the use of gentle heat be pressed finally into position. When the chitinous textures of insects are to be thus mounted, they must be first softened by steeping in oil of turpentine: and a large drop of balsam being placed on a warmed slide, the object taken up in the forceps is to be plunged in it, and the cover (balsamed as before) let down upon it. It is with objects of this class that the *spring-clip* and the *spring-press* prove most useful in holding down the cover until the balsam has hardened sufficiently to prevent its being lifted by the elasticity of the object. Various objects (such as the palates of gasteropods) which have been prepared by dissection in water or weak spirit may be advantageously mounted in balsam: for which purpose they must be first dehydrated, and then transferred from rectified spirit into turpentine or one of the other 'clearing agents' mentioned below. Sections of horns, hoofs, &c., which afford most beautiful objects for the polariscope, are best mounted in natural balsam, which has a remarkable power of increasing their transparency. It is better to set aside in a warm place the slides which have been thus mounted before attempting to clean off the superfluous balsam in order that the covers may be fixed by the gradual hardening of what lies beneath them.

Mounting Objects in Aqueous Liquids.—By far the greater number of preparations which are to be preserved in liquid, however, should be mounted in a cell of some kind, which forms a *well* of suitable depth, wherein the preservative liquid may be retained. This is *absolutely necessary* in the case of all objects whose thickness is such as to prevent the glass cover from coming into close approximation with the slide; and it is *desirable* whenever that approximation is not such as to cause the cover to be drawn to the glass slide by capillary attraction, or whenever the cover is *sensibly* kept apart from the slide by the thickness of any portion of the object. Hence it is only in the case of objects of the most extreme tenuity that the cell can be advantageously dispensed with; the danger of *not* employing it, in many cases in which there is no difficulty in mounting the object without it, being that after a time the cement is apt to run in beneath the cover, which process is pretty sure to

continue when it may have once commenced. When cement-cells are employed for this purpose, care must be taken that the surface of the ring is perfectly flat, so that when the cover-glass is laid on no tilting is produced by pressure on any part of its margin. As a general rule, it is desirable that the object to be mounted should be steeped for a little time previously in the preservative fluid employed. A sufficient quantity of this fluid being deposited to overflow the cell, the object is to be introduced into it either with the forceps or the dipping tube; and the slide should then be examined on the dissecting microscope that its entire freedom from foreign particles and from air-bubbles may be assured, and that its disposition may be corrected if necessary. The cover should then be laid on very cautiously, so as not to displace the object: which in this case is best done by keeping the drop highest in the centre, and keeping the cover parallel to the slide whilst it is being lowered, so as to expel the superfluous fluid *all round*. This being taken up by the syringe, the cement ring and the margin of the cover are to be dried with blotting-paper, especial care being taken to avoid drawing off too much liquid, which will cause the gold-size to run in. It is generally best to apply the first coat of gold-size *thin*, with a very small and flexible brush worked with the hand: this will dry sufficiently in an hour or two to hold the cover whilst being 'ringed' on the turn-table. And it is safer to apply a third coat a day or two afterwards; *old* gold-size, which lies thickly, being then applied so as to raise the ring to the level of the surface of the cover. As experience shows that preparations thus mounted, which have remained in perfectly good order for several years, may be afterwards spoiled by leakage, the Author strongly recommends that to prevent the loss of valuable specimens an additional coating of gold-size be laid on from time to time. But a device of much greater value in all fluid mounting is that adopted by Mr. Enock,¹ who puts a metallic ring of angular section round the outside of the cell, slightly overlapping the cover-glass and enclosing the rim made good with cement; this proves perfect.

Mounting of Objects in Deep Cells.—The objects which require deep cells are, as a rule, such as are to be viewed by reflected light, and are usually of sufficient size and substance to allow of air being entangled in their tissues. This is especially liable to occur where they have undergone the process of decalcification, which will very probably leave behind it bubbles of carbonic acid. For the extraction of such bubbles the use of an air-pump is commonly recommended; but the Editor has seldom found this answer the purpose satisfactorily, and is much disposed to place confidence in a method lately recommended—steeping the specimen in a stoppered jar filled with freshly *boiled water*, which has great power of drawing into itself either air or carbonic acid. Where the structure is one which is not injured by alcohol, prolonged steeping in this will often have the same effect. The next point of importance is to select a cover of a size exactly suitable to that of the ring, of whose breadth it should cover about two-thirds, leaving an adequate margin uncovered for the attachment

¹ *Quekett Journ.* second series, vol. i. p. 40.

of the cement. And the perfect flatness of that ring should then be carefully tested, since on this mainly depends the security of the mounting. It is to secure this that we prefer rings of tin or bone, to those of glass, for cells of moderate depth; for their surface can be easily made perfectly flat by grinding with water, first on a piece of grit, and then on a Water-of-Ayr stone, these stones having been previously reduced to a plane surface, or still better with a good flat file. If glass rings are not found to be 'true,' they must be ground down with fine emery on a plate of lead. When the cell has been thus finished off, it must be carefully cleaned out by dropping into it some of the mounting fluid; and should be then examined under the dissecting microscope for minute air-bubbles, which often cling to the bottom or sides. These having been got rid of by the needle, the cell should be finally filled with the preservative liquid, and the object immersed in it, care being taken that no air-bubbles are carried down beneath it. The cell being completely filled so that the liquid is running over its side, the cover may then be lowered down upon it as in the preceding case; or, if the cell be quadrangular, the cover may be sloped so as to rest one margin on its wall, and fresh liquid may be thrown in by the syringe, while the other edge is lowered. When the cover is in place, and the liquid expelled from it has been taken up by the syringe, it should again be examined under a lens for air-bubbles; and if any of these troublesome intruders should present themselves beneath the cover, the slide should be inclined, so as to cause them to rise towards the highest part of its circumference, and the cover slipped away from that part, so as to admit of the introduction of a little additional fluid by the pipette or syringe; and when this has taken the place of the air-bubbles the cover may be slipped back into its place. The surface of the ring and the edge of the cover must then be thoroughly dried with blotting-paper, care being taken that the fluid be not drawn away from between the cover and the edge of the cell on which it rests. These minutiae having been attended to, the closure of the cell may be at once effected by carrying a thin layer of gold-size or dammar around and upon the edge of the glass cover, taking care that it touches every point of it, and fills the angular channel which is left along its margin. The Author has found it advantageous, however, to delay closing the cell for some little time after the superfluous fluid has been drawn off; for as soon as evaporation from beneath the edge of the cover begins to diminish the quantity of fluid in the cell, air-bubbles often begin to make their appearance which were previously hidden in the recesses of the object; and in the course of half an hour a considerable number are often collected. The cover should then be slipped aside, fresh fluid introduced, the air-bubbles removed, and the cover put on again; and this operation should be repeated until it fails to draw forth any more air-bubbles. It will of course be observed that if the evaporation of fluid should proceed far air-bubbles will *enter* beneath the cover; but these will show themselves on the *surface* of the fluid, whereas those which arise from the object itself are found in the deeper parts of the cell. When all these

have been successfully disposed of, the cell may be 'sealed' and 'ringed' in the manner already described.

Preparation of Soft Tissues.—It is impossible in the limited space at disposal here to do more than give a sketch of the very elaborate art of histological preparation. The reader who desires to pursue the subject further will find all necessary information in Mr. A. Bolles Lee's 'The Microtommist's Vade-mecum' (London: J. & A. Churchill), from which work the information here given is for the most part abridged (the passages in quotation marks in the following pages are taken therefrom verbatim).

Fixation.—'The first thing to be done with any structure is to *fix* its histological elements. Two things are implied by the word 'fixing': first, the rapid *killing* of the element, so that it may not have time to change the form it had during life, but is fixed in death in the attitude it normally had during life; and second, the *hardening* of it to such a degree as may enable it to resist without further change of form the action of the reagents with which it may subsequently be treated.' For instance, if you were to take a living rotifer and throw it into one of the usual staining fluids or preservative liquids, it would at once contract into a shapeless mass, the elements of its tissues would be neither properly stained nor properly preserved, and the result would be an unrecognisable caricature of the living organism. But if it be first properly killed and slightly hardened in the proper manner, it may be permanently mounted in such a way as to show, uninjured and undistorted, even the most delicate details of its structure.

Fixation is generally performed by immersing the object to be fixed in an appropriate liquid, and leaving it therein until the desired degree of hardening has been obtained. After that the object is well washed to remove all excess of the fixing liquid. The object may then be further prepared by the wet method, in which all subsequent operations are performed by means of aqueous media. It may be mounted at once in an aqueous mounting medium, or it may be *stained* (see below), or it may be put away till wanted, without mounting, in some preservative medium.

Or 'the object may be further prepared by the *dehydration method*' (see below), 'which consists in treatment with successive alcohols of gradually increasing strength, final *dehydration* with absolute alcohol, *clearing*' (see below) 'with an essential oil or other clearing agent, and lastly either mounting in balsam or imbedding in paraffin for the purpose of making sections.'

Corrosive sublimate is the fixing agent that is most to be recommended for general work. A good formula consists of a saturated solution in water containing 1 per cent. of acetic acid. The present writer adds a little nitric acid, say 1 per cent., which helps to make the solution keep without precipitating. Another good solution is a saturated solution in alcohol of 50 per cent., or even 70 per cent., also with addition of 1 per cent. of acetic acid.

Whatever solution is taken, the objects should be removed from it soon after they have become thoroughly penetrated by it. For sublimate hardens very rapidly, and makes tissues brittle if they are

allowed to remain too long in it. The objects should be well washed out, after fixing, with alcohol, beginning with alcohol of 50 per cent. or 70 per cent., and passing gradually to stronger alcohols. In order to facilitate the removal of the sublimate from the tissues, the alcohol should have added to it enough tincture of iodine to make it of a good port-wine colour, and the objects should remain in it till they themselves have acquired the same colour. They may then be washed with pure alcohol, and further treated as desired.

Solutions of sublimate, or the objects in them, must never be touched with steel implements, as these produce at once precipitates that may injure the preparations. To manipulate the objects, wood or glass implements may be employed; for dissecting them, hedgehog spines, or quill pens, or cactus needles.

Tissues become of an opaque whiteness on fixation with sublimate, which in the case of small transparent objects is a good guide for controlling the duration of the fixing bath. The fixing action is extremely rapid.

Picric acid is a reagent that gives very fair results for general work, and is especially to be recommended where great power of penetration is required, as is the case in work with chitinous organisms. A saturated solution in water with the addition of 1 per cent. of acetic acid may be taken, or the micro-nitric acid of Mayer. This consists of water 100 parts, nitric acid of 25 per cent. N_2O_5 , 5 parts, and picric acid to saturation.

Objects should remain in these liquids much longer than in sublimate liquids; for though the penetration is extremely rapid the hardening power is slight. They may remain for twenty-four hours without hurt, but in many cases three or four hours will suffice. After fixation the objects should be brought into alcohol of 70 per cent. (never water), in which they should remain for a few hours, and then be transferred to alcohol of 90 per cent., in which they should remain, the alcohol being frequently changed for fresh, until the yellow tint of the picric acid has disappeared or at least become greatly attenuated. Objects prepared in this way are best stained in alcoholic staining solutions.

Mixtures of picric acid solution with sublimate in various proportions have lately been much used, with good results.

Osmic acid is a useful reagent for fixing small objects. It preserves the forms of cells admirably, and at the same time imparts to tissues a grey stain that is frequently of the greatest value in bringing out delicate structures. This substance is sold in the solid state, in sealed tubes containing from $\frac{1}{10}$ gram. to 1 gram. It is extremely volatile. Care should be taken to avoid exposure to the vapours given off from it, as they are exceedingly irritating to mucous membranes and may easily give rise to serious catarrh, conjunctivitis, &c.

Its solution in pure water keeps very badly, as the slightest contamination with any organic dust will cause it to reduce and precipitate. It is recommended, therefore, that only a small quantity be kept in stock in the shape of aqueous solution, whilst another quantity may be preserved in the shape of a 2 per cent. solution in chromic acid of 1 per cent., or, better, in platinum chloride of the

same strength. These solutions do not precipitate so readily, and may be used for fixation by the vapours.

For it is one of the advantages of osmic acid that it may be employed for fixation in the form of vapour, and its employment in this form is indicated in most of the cases in which it is possible to expose the tissues to be fixed directly to the action of the vapour. For fixation in this way 'the tissues are pinned out on a cork which must fit well into a wide-mouthed bottle in which is contained a little solid osmic acid (or a small quantity of 1 per cent. solution will do). Very small objects, such as isolated cells, are simply placed on a slide, which is inverted over the mouth of the bottle. They remain there until they begin to turn brown (isolated cells will generally be found to be sufficiently fixed in thirty seconds, whilst in order to fix the deeper layers of relatively thick objects, such as retina, an exposure of several hours may be desirable). It is well to wash the objects with water before staining, but a very slight washing will suffice. For staining, methyl-green may be recommended for objects destined for study in an aqueous medium, and, for permanent preparations, alum-carminé, picro-carminé, or hæmatoxylin.'

'The reasons for preferring the process of fixation by vapour of osmium, where practicable, are that osmium is more highly penetrating when employed in this shape than when employed in solution, and produces a more *equal* fixation, and that the arduous washing out required by the solutions is here done away with. In many cases delicate structures are better preserved, all possibility of deformation through osmosis being here eliminated.' (From Mr. Lee's 'The Microtome's Vade-mecum.')

For fixation by solutions, strengths of from $\frac{1}{10}$ to $\frac{1}{2}$ per cent. may be taken, which may in general with advantage be acidified with about 1 per cent. of acetic acid. Small crustacea, such as the copepods and the larvæ of decapods, may be very well prepared in this way. After fixation, the osmic acid should be very thoroughly washed out with water.

If it be desired to intensify the grey stain of the osmium, this may be easily done by putting the objects into a weak solution of pyrogallie acid or tannin, which will turn them of a fine black.

Osmic acid stains most fatty substances of an intense black.

Osmic acid is now not so much used in the form of a pure aqueous solution as in that of the mixture known as *liquid of Fleming*. This consists of 25 parts of 1 per cent. solution of chromic acid, 10 parts of 1 per cent. osmic acid, 10 parts of 1 per cent. acetic acid, and 55 of water. This mixture blackens tissues much less than the pure aqueous solution.¹

¹ **Bleaching.**—Tissues that have been blackened or browned by osmic or chromic acid or the like may often with advantage be *bleached* by Mayer's chlorine method, and will then be found to stain much more readily.—Put into a glass tube a few crystals of chlorate of potash, add two or three drops of hydrochloric acid, and as soon as the green colour of the evolving chlorine has begun to show itself, add a few cubic centimetres of alcohol of 50 to 70 per cent. Now put the objects (which must have previously been soaked in alcohol of 70 to 90 per cent.) into the tube. They float at first, but eventually sink. They will be found bleached in from a quarter of an hour to one or two days, without the tissues having suffered. Only in obstinate cases should the liquid be warmed or more acid taken.

For the very numerous other fixing reagents and mixtures now in use, and the manner of their employment, the reader must be referred to Mr. Lee's 'The Microtometist's Vade-mecum.'

After due fixation and washing, objects may be stained and mounted in an aqueous medium in the manner directed above (p. 481), if it be desired to prepare them in the wet way. But if they are destined to be preserved in balsam, they must first, after staining if required, be *dehydrated* and *cleared*.

Dehydration is performed as follows:—The objects are brought into weak alcohol, and are then passed through successive alcohols of gradually increased strength, remaining in each the time necessary for complete saturation, and the last bath consisting of absolute or at least very strong alcohol. For instance, alcohol first of 30 per cent. or 50 per cent., then 70 per cent., then 95 per cent., or, if the objects be very delicate, 80 per cent., before the 95 per cent., the last to be changed at least once.

Clearing.—The water having been thus sufficiently removed, the alcohol is in its turn removed from the tissues, and its place taken by some anhydrous substance, generally an essential oil, which is miscible with the material used for imbedding. This operation is known as *clearing*. It is very important that the passage from the last alcohol to the clearing agent be made gradual. This is effected by placing the clearing medium *under* the alcohol. A sufficient quantity of alcohol is placed in a tube (a watch-glass will do, but tubes are generally better), and then with a pipette a sufficient quantity of clearing medium is introduced *at the bottom of the alcohol*. Or you may first put the clearing medium into the tube, and then carefully pour the alcohol on to the top of it. The two fluids mingle but slowly. The objects to be cleared, being now quietly put into the supernatant alcohol, float at the surface of separation of the two fluids, the exchange of fluids takes place gradually, and the objects slowly sink down into the lower layer. When they have sunk to the bottom (and the wavy refraction-lines at first visible round them have disappeared) the alcohol may be drawn off with a pipette, and the objects will be found to be completely penetrated by the clearing medium. (It may be noted here that this method of making the passage from one fluid to another applies to all cases in which objects have to be transferred from a lighter to a denser fluid—for instance, from alcohol or from water to glycerine.) From 'The Microtometist's Vade-mecum.'

Another method of passing the objects from the alcohol to the clearing agent consists in giving them baths of mixtures of the alcohol and the clearer, made gradually to contain a higher proportion of the latter.

All clearing agents are liquids of high refraction, having indices of refraction not greatly inferior to that of the elements of tissues

Sections on slides may be bleached in this way. Instead of hydrochloric acid, nitric acid may be taken; in which case the active agent is evolved oxygen instead of chlorine. This method serves also for *removing natural pigments*, such as those of the skin, or of the eyes of Arthropods. For bleaching chitin of insects, not alcohol but water should be added to the chlorate and acid. (From 'The Microtometist's Vade-mecum.')

in the fixed state. Hence, by penetrating amongst these highly refractive elements, they render the tissues transparent and clear, which is the reason of their being called 'clearing agents.'

The best clearing agent for general use is *oil of cedar wood*. *Oil of cloves* is a very good one; it should be known that it makes objects brittle, which is sometimes to be desired, sometimes the reverse. *Oil of bergamot* is useful; it will clear from alcohol of no more than 90 per cent. strength.

It should be noted that the proper stage for *performing minute dissections* in is the one at which the objects have now arrived, a drop of clearing agent being a most helpful medium for carrying out such dissections in. Oil of cedar is very good for this purpose. But oil of cloves is sometimes to be preferred, not only on account of its property of making tissues brittle, which is often very helpful, but also on account of the property it has of forming very convex drops on the slide.

Staining.—Good histological stains can in general only be obtained with properly fixed tissues. But it is possible to obtain with unfixed and even with living tissues a stain which though imperfect and not 'fast' may be of considerable utility in research, either as a means of controlling the results obtained by the examination of fixed and prepared specimens, or as a means of revealing delicate traits of structure that may be masked or destroyed by the action of fixing and preserving reagents, and only visible in the living or perfectly fresh object.

It goes without saying that staining is performed by immersing the tissues in the colouring solution employed. After the tissue has become duly stained, all superfluous colour is removed from it by 'washing out' with an appropriate liquid.

Stains for Living Objects (*Intra Vitam* Stains).—The most widely used of these stains is *methylene-blue* (to be obtained from Grübler and Holborn,¹ and not to be confounded with methyl-blue, which is a totally different dye). Small aquatic organisms (such as rotifers, infusoria, small annelids, tadpoles) are stained by adding a small quantity of the dye (best previously dissolved in distilled water) to the water in which they are kept, and leaving them till the stain has taken effect. Enough of the dye should be added to make the water of a good blue, the proportion required varying roughly between 1 part of the dye to 10,000 of the water, and 1 part to 100,000. Most aquatic organisms will live in the coloured water for many hours, some for days or weeks. They should be examined as soon as the required intensity of stain has been attained. For if they are allowed to remain longer the elements that have taken up the dye will begin to yield it up again to the water, and the objects may become quite pale again even though they have not been removed from the coloured water. The stain is an imperfect one, being mostly confined to certain granules of the protoplasm of cells, and taking effect capriciously now on one tissue and now on another. It is difficult to preserve the stain in a

¹ 63 Bayerische Strasse, Leipzig; or through Mr. C. Baker, 243 High Holborn.

satisfactory manner, as it will not bear mounting in the usual media without deterioration.

Weak solutions of *Bismarck brown*, *quinolein-blue*, *anilin-black*, *Congo red*, and *neutral red* (*Neutralroth*) may be used in the same way.

Methylen-blue, used as an *intra vitam* stain, is an important reagent for the study of nerve-endings. For the details of this very difficult branch of technique, as well as for the methods for preserving the stain obtained with entire living organisms, the reader must be referred to Mr. A. Bolles Lee's 'The Microtommist's Vade-mecum,' in which an entire chapter is devoted to the subject.

Stains for Fresh (Unfixed) Tissues or Organisms.—The stains to be mentioned under this heading resemble the *intra vitam* stains described in the last paragraph in that they may be applied to living tissues or organisms. But they differ from them in that they do not take effect on the objects without impairing their vitality; on the contrary they first kill them, then stain them.

The most important of this class of stains is *methyl-green*. A strong solution in water acidified with from $\frac{1}{2}$ to 1 per cent. of acetic acid is employed. The objects are soaked in the solution until they are penetrated by it, then washed with pure water, or, better, acidified water, and either studied therein or mounted. They may be permanently preserved in any of the usual aqueous mounting media, provided that the medium be acid or at most strictly neutral, and that it contain a little of the dye in solution. Liquid of Ripart and Petit, or Brun's glucose medium may be recommended for mounting. It is difficult to mount the stained objects in balsam, on account of the great solubility of the dye in alcohol.

The stain is an extremely rapid one: tissues are stained almost as soon as they are penetrated by it. It is, generally speaking, a nuclear stain, nuclei being stained more rapidly than cytoplasm, though some kinds of cytoplasm and formed material are stained by it. It preserves the forms of cells well. It does not overstain, and requires little washing out. This, if required, is best done with water acidified with acetic acid.

Bismarck brown is also a useful stain for fresh tissues. It may be used in solution in acidified water, as directed for methyl-green. But as the dye is not very soluble in water it is not easy to get a good solution in this way, and the solutions when made keep very badly. Some persons dissolve the dye in dilute glycerin (glycerin diluted with one or two volumes of water). This makes a good solution, but on account of the shrinking action of the glycerin should only be employed with objects that have been previously well fixed. *Bismarck brown* stains quickly, and does not overstain. The stain is permanent both in aqueous mounting media and in balsam. It is a nuclear stain in so far as nuclei are stained by it more than protoplasm.

The once celebrated mixture known as *Ranvier's picro-carmin*e is irrational in composition, and inconstant and frequently injurious in its effects, and is now generally abandoned.

Stains for Fixed and Preserved Entire Objects or Material to be Stained in Bulk.—These fall naturally into the two classes of *aqueous stains* and *alcoholic stains*. The aqueous stains are generally the more precise, and are generally preferable for small and permeable objects, but the alcoholic stains are absolutely necessary where great penetration is required, as for instance in the case of organs or organisms enclosed in thick chitinous investments, as is so generally the case amongst the Arthropoda.

The most precise and the safest of the stains of this class are the *alum-carmines*—a general term including the divers formulæ that have been recommended under the names of *alum-carmine*, *carmalum*, *alum-cochineal*. One of these will suffice.

Partsch's alum-cochineal.—'Powdered cochineal is boiled for some time in a 5 per cent. solution of alum, the decoction filtered, and a little salicylic acid added to preserve it from mould.'

An extremely precise nuclear stain, and one with which it is hardly possible to overstain. It is permanent in balsam and, it is believed, in aqueous media if not acid. Objects may be left in it for several hours. They should not be very large, as the stain has no great power of penetration. Objects containing calcareous elements that it is desired to preserve must not be treated with this stain, nor with any other stain containing alum.

Mayer's carmalum is made with carminic acid 1 grm., alum 10 grm., and distilled water 200 c.c. It has the advantage of being much more penetrating than the other stains of this class.

All the alum-carmine solutions are rather weak stains. If a more powerful stain be desired, take the following:—

Mayer's hamalum.—This is made with hamatein, the essential colouring principle of hamatoxylin (obtainable from Grübler and Hollborn). One grm. of hamatein is either dissolved with heat in 50 c.c. of 90 per cent. alcohol, or rubbed up in a mortar with a little glycerin, and added to a solution of 50 grm. of alum in a litre of water. This liquid may be used for staining either concentrated or diluted. Concentrated it stains almost instantaneously. For ordinary purposes it may be diluted with from ten to twenty volumes of distilled water, and will then stain through small objects in an hour or so. Large objects will require an hour or more. The solution is admirable for staining in bulk. Objects should be well washed out (for as long a time as they have taken to stain) either with distilled water or tap water. One per cent. alum solution is also a good medium to wash out in. Overstains may be corrected by washing-out with 0.1 to 0.5 per cent. of hydrochloric acid. In this case the acid should be neutralised afterwards by treatment with 0.1 per cent. solution of bicarbonate of soda (or other weak alkali).

Passing now to the *alcoholic solutions*, *Greunacher's alcoholic borax-carmine* may be recommended as affording a convenient, safe, and brilliant stain. Dissolve 2 or 3 per cent. of carmine in a 4 per cent. solution of borax in water; boil the solution for half an hour; dilute it with an equal volume of 70 per cent. alcohol, allow it to stand for twenty-four hours, and filter.

Objects are put into this solution and allowed to remain in it

until they are thoroughly penetrated (for days if necessary). They are then put into alcohol of 70 per cent. acidified with from four to six drops of hydrochloric acid for every 100 c.c. of the alcohol. The acid alcohol at once begins to remove the excess of colour from the objects, which may be seen to give it off in rosy clouds. They remain in it until the colour no longer comes away freely and they have exchanged their primitive opaque red coloration for a brilliant transparent coloration. This may require days (the acid alcohol should be changed frequently).

The staining is now complete, and the objects are washed in pure neutral alcohol, cleared and mounted in balsam or any other desired medium. The result is a brilliant nuclear stain, quite permanent. The process must not be used for objects containing calcareous elements that it is desired to preserve.

For delicate objects, and for very impermeable objects, it may be well to increase the proportion of 70 per cent. alcohol in the solution; the proportion of alcohol may be brought up to about 50 per cent., but should not exceed 60 per cent. in any case.

This process is an example of what is known as *regressive* or indirect staining; the objects are first *overstained* in the carmine solution, and the excess of stain is then removed to the required degree in the acid alcohol.

If, as is frequently the case, especially in studies on the Arthropoda, a still more highly alcoholised stain be desired, *Mayer's alcoholic cochineal* may be tried. Cochineal in coarse powder is macerated for several days in 70 per cent. alcohol. For each gramme of the cochineal there is required 8 to 10 c.c. of alcohol. Stir frequently. Filter, and the solution is ready for staining.

The objects to be stained must previously be well imbibed with 70 per cent. alcohol. They may remain for almost any length of time in the staining bath. After staining they are washed in 70 per cent. alcohol, which is frequently changed until it takes up no more colour from the objects. Overstaining seldom happens: it may be corrected by means of 70 per cent. alcohol containing 1 per cent. of acetic acid or $\frac{1}{10}$ per cent. of hydrochloric acid.

Small objects or thin sections are stained in a few minutes: large objects require hours or days: a nuclear stain, either red or blue, according to the chemical composition of the tissues stained. It does not succeed with all objects. The best stains are obtained with objects that have been prepared with chromic or picric acid combinations, or with absolute alcohol. Osmic acid preparations stain very weakly unless they have been previously *bleached*. All acids should be carefully washed out of the objects before staining. The stain is permanent in oil of cloves and balsam.

Kleinenberg's Alcoholic Hamatoxylin, once very much used, is highly irrational and very inconstant in its composition and its effects, and is now with reason generally abandoned.

Nuclear Stains for Sections.—Any of the foregoing stains may of course be used for sections if desired. But in many cases other stains are indicated, as being more powerful, or more precise, or of a richer selectivity.

The solution known as *Kernschwarz* may be confidently recommended as a powerful, precise, and very safe stain. It is a black liquid imported from Russia by Grübler and Hollborn, and consists of an iron base united to some gallic acid. Sections may be stained in it, either concentrated or diluted to the required intensity. Overstaining seldom occurs. If it should occur it may be corrected by means of any weak acid (solution of *liquor ferri sulfurici oxydati*, diluted twentyfold—see the iron-hæmatoxylin of Benda, below—is a very fitting decolorant).

The result is a nuclear stain, sometimes, though by no means always, also taking effect on protoplasm, of a brownish grey or black, powerful and precise, and well adapted for photography. It is permanent in balsam, presumably also in aqueous mounting media. Being a progressive stain, it is possible that it might give good results for staining in bulk.

The present writer obtains a very similar stain by 'mordanting' for a few hours in Benda's *liquor ferri*, and then bringing the sections directly for some hours into a 2 per cent. solution of pyrogallol in water. Similar results are also obtained by mordanting in 2 per cent. solution of tincture of perchloride of iron in 70 per cent. alcohol, and then treating with 2 per cent. solution of pyrogallol in spirit: a process which is applicable to staining in bulk.

Benda's iron hæmatoxylin is a still more powerful and precise stain. Sections of material that has been fixed in any way may be employed. They are 'mordanted' by soaking for half an hour or for some hours (as much as twenty-four, if a very strong stain be required) in *liquor ferri sulfurici oxydati*, P.C., diluted with one or two volumes of water.¹ They are then well washed, first with distilled water, then with tap water, and are brought into a 1 per cent. solution of hæmatoxylin in water, in which they remain till they have become thoroughly black. They are now overstained, and must be 'differentiated.' To this end they are washed and put either into some of the sulphate solution strongly diluted with water (say twenty or thirty fold), or into 30 per cent. acetic acid, the progress of the decoloration being followed in either case under the microscope. They are then mounted in the usual way.

This gives an extremely powerful blue-black stain, purely nuclear if the differentiation has been pushed far enough, or nuclear and at the same time plasmatic if the differentiation is stopped before the protoplasm has become decoloured. The stain is absolutely permanent in balsam.

The results obtained by this process are practically identical with those obtained by the *iron hæmatoxylin process of Heidenhain*, with this advantage, that Benda's iron solution is easily made and keeps indefinitely, whereas Heidenhain's process involves the employment

¹ This preparation consists of sulphate of iron 80 parts, water 40, sulphuric acid 15, and nitric acid 18. The ingredients should be mixed, and give at first a black liquid which gradually acquires a red colour. The operation should be performed out of doors, or in a chemical laboratory, as during the process of solution voluminous nitrous vapours are given off, which would be hurtful to lenses and delicate instruments.

of ferric alum, which can only be obtained from large chemical works, and does not keep well either in substance or in solution.

Owing to the precision and depth of the stain, preparations made by this process will bear study with higher microscopic powers than those made by any other means; that is to say, it is certainly found in practice that they will bear notably higher eye-piecing.

It will be observed that, as with borax-carminé, this is a 'regressive' stain. The progress of decoloration, being slow, may be controlled under the microscope, and a little practice with this process may serve as an introduction to the art of regressive staining with safranin and other tar-colours, with which the progress of decoloration is so rapid that it cannot be controlled under the microscope.

Safranin is perhaps the most beautiful stain of this class. The first requisite to success in staining with this colour is to obtain a good sample of the dye. This is absolutely essential. There are at least a score of brands of safranin on the market, many of which cannot be made to afford a good stain by any means whatever. The brand 'Safranin O' supplied by Grüber and Hollborn is an excellent one.

The dye is employed in the form of a saturated or at least very concentrated solution in water or alcohol. Perhaps the best plan in general is to make a saturated solution in water, and another saturated solution in strong alcohol, and then mix the two in equal parts. Sections are soaked in the solution until thoroughly over-stained—the longer the better. Good stains can often be obtained after half an hour in the staining bath, but for many objects it is necessary, in order to ensure good results, to stain for twenty-four hours, or even for many days.

After the staining comes the 'differentiation' of the stain. The sections are just rinsed with water and brought into strong alcohol, either in a watch-glass, if they be loose sections, or in a flat-bottomed tube if they be affixed to a slide. The sections in the watch-glass are seen to give up their colour to the alcohol in clouds, which are at first very rapidly formed, afterwards more slowly. The sections on the slide are seen, if the slide be gently lifted above the surface of the alcohol, to be giving off their colour in the shape of rivers running down the glass. In a short time the formation of the clouds or of the rivers is seen to be *on the point of ceasing*; the sections have become *pale* and somewhat *transparent*, and (in the case of some objects) have *changed colour*, owing to the coming into view of the general ground-colour of the tissues, from which the stain has now been removed. At this point the differentiation is complete, and the extraction of the colour *must be stopped instantly*.

This may be done if desired by simply putting the sections into water; but the more usual practice is to proceed at once to mount them in balsam. To this end they may be cleared by being put into clove oil (or by pouring the oil over them on the slide). This will extract slowly a little more colour, and may thus serve to complete the differentiation in a frequently very desirable manner. Or you

may clear or remove the alcohol with an agent that does not remove any more colour, such as cedar oil, or bergamot oil, or xylol, toluol, or benzol. This being done, nothing more remains but to add a drop of xylol-balsam or dammar, and a cover (chloroform is best avoided, either as a clearer or as a menstruum for the mounting medium).

The result is a pure nuclear stain, of exceeding brilliancy, and perfectly permanent in balsam.

The process is not available for staining in bulk, but besides sections such material as is thin enough to behave like a section—portions of thin membranes, for instance—may be stained in this way. The process of differentiation takes about a couple of minutes with most thin sections, but in some cases considerably more is required.

Besides safranin, many others of the coal-tar dyes may be used in the same way: for instance, *basic fuchsin* (*magenta*), also a red stain, or *gentian violet* or *thionin*, both these being blue. Thionin is peculiarly resistant to alcohol, which is an important quality in some cases.

Plasma Stains, or Plasmatic Stains.—All the stains we have hitherto considered (with the exception of the *intra vitam* stains) have been nuclear stains—that is, such as stain nuclei either exclusively, or at least more energetically than protoplasm or formed material. In very many cases they perform all that the histologist requires in the way of rendering structure visible. But still there are other cases in which it is desirable to obtain a separate stain of extra-nuclear parts. For this purpose the so-called plasma stains are employed.

Picric acid is a useful one, especially when employed after a carmine or hæmatoxylin nuclear stain. The *modus operandi* is as simple as possible: it consists merely in adding picric acid to the alcohol employed for dehydrating the objects, and leaving them therein until the desired intensity of stain is obtained. It has the great quality, shared by very few plasma stains, that it can be used for staining *entire objects*. And as it is extremely penetrating, it is very much indicated for the preparation of such objects as small arthropods or nematodes, mounted whole.

Lyons blue (*Bleu de Lyon*) is a good plasma stain that will work well after carmine (borax-carmine for instance). It may be used for staining in bulk, in a very dilute alcoholic solution; or for staining sections, in a strong aqueous solution. The objects must not remain too long in alcohol after staining.

The dye known as *Wasserblau* (*water-blue*) gives with sections a similar but perhaps more delicate stain. It is a good stain to use in conjunction with safranin, using the *Wasserblau* first. The process is, first, to stain rather strongly in a concentrated aqueous solution of the blue, and then for from half an hour to four or five hours in the safranin, as described above.

Either of these stains will probably be found safer than *indigo-carminæ*, which was once much employed for similar purposes.

A still more precise and delicate plasma stain is *Säurefuchsin* (also known under the synonyms, or names of brands, of *acid fuchsin*, *Säurerubin*, *Fuchsin S*, *Rubin S*, and others). It is

important not to confound it with basic fuchsin, as appears to have been done by some writers. For staining sections a $\frac{1}{2}$ per cent. solution in water may be employed, and allowed to act on sections for from one to five minutes. A red stain, very resistant to alcohol and acids, and permanent in balsam. It is an excellent stain for use after a blue nuclear stain, such as hæmatoxylin, thionin, gentian violet, or the like.

The celebrated mixture known as the *Ehrlich-Biondi-Heidenhain* stain involves such complicated and delicate manipulations as to be totally unsuitable for ordinary histological work.

Imbedding Methods.—‘The beautiful processes known as imbedding methods are employed for a threefold end. Firstly, they enable us to surround an object, too small or too delicate to be firmly held by the fingers or by any instrument, with some plastic substance that will support it on all sides with firmness but without injurious pressure, so that by cutting sections through the composite body thus formed, the included object may be cut into sufficiently thin slices without distortion. Secondly, they enable us to fill out with the imbedding mass the natural cavities of the object, so that their lining membranes or other structures contained in them may be duly cut *in situ*. And, thirdly, they enable us not only to surround with the supporting mass each individual organ or part of any organ that may be present in the interior of the object, but also to impregnate with it each separate cell or other anatomical element, thus giving to the tissues a consistency they could not otherwise possess, and ensuring that in the thin slices cut from the mass all the details of structure will precisely retain their natural relations of position.’

‘These ends are usually attained in one of two ways. Either the object to be imbedded is saturated by soaking with some material that is liquid while warm and solid when cold, which is the principle of the paraffin process; or the object is saturated with some substance which whilst in solution is sufficiently fluid to penetrate the object to be imbedded, whilst at the same time, after the evaporation or removal by other means of its solvent, it acquires and imparts to the imbedded object sufficient firmness for the purpose of cutting,’ which is the principle of the collodion process. (From Mr. Lee’s ‘*Microtomist’s Vade-mecum*.’)

Any substance used for imbedding is technically termed an ‘imbedding mass.’

The older workers were not aware of the importance of thoroughly *saturating* the objects to be cut with the imbedding mass, a point which is very important in order to the production of thin and undistorted sections. They were content with simply *surrounding* the objects to be cut with the mass. This primitive procedure is now rightly abandoned, except in cases in which, on account of the large size or other peculiarities of the object, it is impossible to procure due saturation.

Among the numerous methods of imbedding that have been advocated, only two are in general use at the present day. These are the *paraffin method*, and the *collodion or collodion method*. And

of these, it is the paraffin method that is by far the most usually employed. It is the most convenient for ordinary work, the collodion method only presenting points of superiority in special cases, such as the sectioning of extremely large objects, or very brittle tissues, and other special circumstances.

The Paraffin Method.—The first step in the paraffin method consists in saturating the objects with a solvent of paraffin. The second consists in saturating them with molten paraffin, which gradually takes the place of the solvent. The third consists in causing the paraffin to solidify, and arranging the solidified mass in a suitable form for cutting sections. The fourth consists in cutting the sections and freeing them from the solid paraffin with which they are saturated, and if desired affixing them in serial order to a slide for the purpose of mounting.

1. *Saturation with a solvent.*—The solvents employed are either chloroform, or one of the volatile hydrocarbons, such as benzol, toluol, or naphtha, or an essential oil, such as oil of cedar or oil of cloves. None of these are miscible with water, but all of them are miscible with alcohol. Therefore the objects to be imbedded are in the first place thoroughly dehydrated with alcohol, according to the principles set forth above, p. 487. The alcohol is then removed from the objects, and the solvent is made to take its place gradually by one of the substitution methods described above, p. 487, under ‘Clearing.’ Cedar oil is one of the most convenient solvents; and as it is at the same time one of the best of clearing agents, it follows that any object that has been cleared in it is at once ready for saturation with paraffin. Other essential oils, such as clove oil, may also be employed. But the two best saturation agents are certainly oil of cedar and chloroform. It will be noticed that the best way to saturate objects with chloroform is to place the chloroform *under* the alcohol, and allow the substitution of liquids to take place just as in clearing with a non-volatile clearing agent, as directed above, under ‘Clearing.’

2. *Saturation with paraffin.*—If cedar oil, or other non-volatile medium, has been employed, proceed as follows:—Melt some paraffin in a suitable vessel—a watch-glass will do for small objects—and keep it as nearly as possible at melting-point on a water-bath or in a stove, taking care to keep it protected from vapour of water. Remove the object from the oil, and put it into the paraffin, and leave it there till thoroughly saturated. The length of time required for this must be found by experience. A piece of soft tissue of $\frac{1}{8}$ inch thickness is generally well saturated in an hour. If the objects be at all large, the paraffin should be changed for fresh once or twice, so that none of the oil may remain to contaminate it and render it soft after cooling.

Some persons prefer to bring the objects *gradually* from the oil into the paraffin by passing them through graduated mixtures of oil and paraffin; but with cedar oil, at all events, that is not necessary.

If chloroform, or other volatile medium, has been employed, the procedure may be modified in the following manner, which is very advantageous for delicate objects:—

'The chloroform and the objects in it are gradually warmed up to the melting-point of the paraffin employed, and during the warming small pieces of paraffin are by degrees added to the chloroform. So soon as it is seen that no more bubbles are given off from the objects, the addition of paraffin may cease, for that is a sign that the paraffin has entirely displaced the chloroform in the objects. This displacement having been a *gradual* one, the risk of shrinkage of the tissues is reduced to a minimum.' After this, however, the whole must be kept warm on the water-bath, at the temperature of the melting-point of the pure paraffin employed, until *all* the chloroform has been driven off from it, as, if even a trace of chloroform remain in the paraffin, it will render it soft after cooling. As this is a very long process (it may take days for large objects), it is frequently better to simply transfer the objects from the paraffin solution to a bath of pure paraffin.

3. *Arranging for cutting.*—After the objects have been duly saturated, they are arranged in a suitable position for cutting, and the paraffin is *caused to solidify as quickly as possible*. *It must not be allowed to cool slowly*, as slow cooling allows the paraffin to crystallise, and gives a mass less homogeneous and of a consistency less favourable for cutting than after rapid cooling.

Very small objects may be taken out of the paraffin with a needle or small spatula, and put to cool on a block of glass, then imbedded in position for cutting on a cone of paraffin already soldered to the object-carrier of the microtome, or to a cork or cylinder of wood fitted into it. This is done as follows:—

A piece of stout wire, or a mounted needle, is heated in the flame of a spirit-lamp, and with it a hole is melted in the end of the cone of paraffin; the specimen is pushed into the melted paraffin, and placed in any desired position. In the use of the needle or wire it should be noted that it is important *to melt as little paraffin as possible at one time*, in order that that which is melted may cool again as rapidly as possible. The advantages of the method lie in the quickness and certainty with which it can be performed.

If the paraffin bath has been given in a watch-glass, float the watch-glass with the paraffin and objects on to cold water. Do not let it sink till all the paraffin has solidified. When cool, warm the bottom slightly and cut out blocks containing the objects; do this with a *slightly* warmed scalpel. Then fix the blocks to the object-carrier by means of a heated needle as above described.

For many objects, other methods of arrangement are preferable. These consist chiefly in causing the paraffin to solidify in a *mould* of any desired shape. *Paper trays* are often used as moulds.

To make **paper trays**, proceed as follows. Take a piece of stout paper or thin cardboard, of the shape of the annexed figure (fig. 407); thin (foreign) post-cards do very well indeed. Fold it along the lines *a a'* and *b b'*, then along *c c'* and *d d'*, taking care to fold always the same way. Then make the folds *A A'*, *B B'*, *C C'*, *D D'*, still folding the same way. To do this you apply *A c* against *A a*, and pinch out the line *A A'*, and so on for the remaining angles. This done, you have an imperfect tray with dogs' ears at the angles.

To finish it, turn the dogs' ears round against the ends of the box, turn down outside the projecting flaps that remain, and pinch them down. A well-made post-card tray will last through several im-

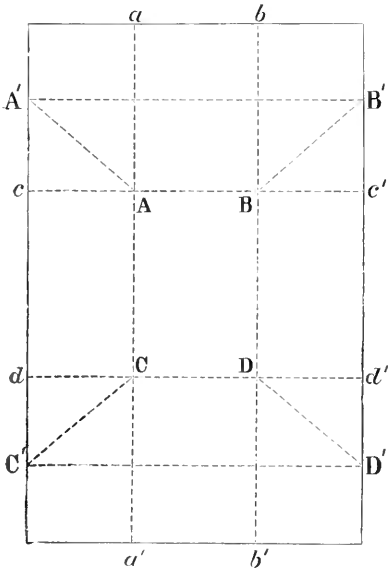

FIG. 407.

beddings, and will generally work better after having been used than when new. (From Mr. Lee's 'Microtomist's Vade-mecum'.)

To imbed in such a tray, or similar receptacle, some melted paraffin (or other 'mass') is poured into it; at the moment when the mass has cooled so far as to have a consistency that will not allow the object to sink to the bottom, the object is placed on its surface, and more melted mass poured on until the object is covered by it. Or, the paper tray being placed on cork, the object may be fixed in position in it whilst empty by means of pins, and the tray filled with melted mass at one pour. (The pins can be removed from the mass when cold.)

In either case, when the mass is cold the paper is removed from it before cutting.

As soon as the tray is filled, and the object in position, cool it on water, holding it above the surface with only the bottom immersed until all the paraffin has solidified, as if you let it go to the bottom at once you will probably get cavities filled with water formed in your paraffin. Or you may put it to cool on a block of cold metal or stone.

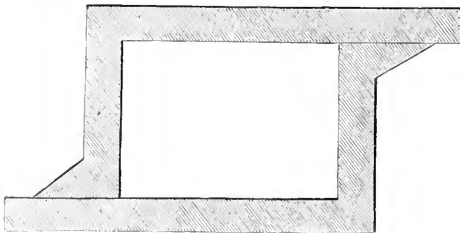

FIG. 408. - Type-metal case for imbedding.

A better plan is to employ sets of two pieces of type-metal, cast in rectangular form of various heights and capable of being placed together as in fig. 408; in this way a suitable box is formed, and, the end of the shorter arm

being triangularly enlarged outwards, it is closed sufficiently to retain the mass. Placed in this way, with the short arms nearer to or farther from each other as a less or greater imbedding mass is required, they are set

on a plate of glass which has been wetted with glycerin and gently warmed. The melted paraffin is now poured into this mould and the object is imbedded in it as described for the paper tray.

Still another plan is to take a common flat medicine-bottle, as in fig. 409, fitted with a cork through which two tubes pass, or, if the mouth is small, one tube may be fastened into a hole drilled into the bottle. One of these tubes, A, is connected with hot and cold water: the other, B, is a discharge-pipe for the water entering the bottle by A, and raising or lowering its temperature as warm or cold water is allowed to flow in. On the smooth, flat side of the bottle four pieces of glass rods or strips are cemented fast, so as to inclose a rectangular space, C, which forms a receptacle for the melted paraffin.

As long as the warm water circulates through the bottle the paraffin remains fluid, and objects in it may be arranged under the microscope by light from above or below, and can be oriented with reference to the sides of the paraffin receptacle or with reference to lines drawn upon the surface of the bottle. When the cold water is allowed to enter in place of the warm, the paraffin congeals rapidly, and may be easily removed as one piece. The discharge-pipe should open near the upper surface of the bottle, to draw off any air which may accumulate there.

In using any form of microtome where the object is held in jaws, the imbedding mass must either be cast a suitable shape, and placed directly in the jaws, or be cemented to pieces of soft wood which may be placed in the jaws.

The mould obtained by either of these processes is then fixed to the carrier of the microtome, and finally pared into a convenient shape, and oriented for cutting.

4. *Cutting.*—Paraffin sections *are always cut dry*—that is, the knife is not wetted with either alcohol or any other liquid.

If the knife be set square—that is, with its axis at right angles to the line of motion (of the knife for sliding microtomes, and of the object-carrier for rocking microtomes)—and if the paraffin block be cut into a rectangle, and also set square—that is, with one edge parallel to the edge of the knife—sections may be cut in “ribbons.” The sections not being removed from the knife one by one as they are cut, but allowed to lie undisturbed on the blade, adhere to one another by the edges so as to form a chain or ribbon, which may be taken up and transferred to a slide without breaking up, thus greatly lightening the labour of mounting a series.

Difficult objects are in general better cut in isolated sections with an oblique knife. In this case it is best to cut the paraffin into the shape of a three-sided prism, and arrange it so that the knife-



FIG. 409.—Arrangement for the orientation of objects in paraffin.

edge enters it at one angle and leaves it at another angle (in fig. 410, the knife enters at *a* and leaves at *c*). The prism should be so cut as to leave the imbedded object near to the side which is furthest from the angle *a* which is first touched by the knife. Then if the section should roll, at all events the section of the object will come to lie in the most open spire of the coil, and can thus be more easily unrolled.

The *rolling* of sections above referred to is an annoying phenomenon of very frequent occurrence. Its most usual cause is over-hardness of the paraffin, but it is favoured by excessive obliquity of the knife, and other circumstances. With large sections it is not difficult to catch them by the edge as they begin to roll, and hold them down with a camel's-hair brush. Or a section-stretcher may be used.¹

If the paraffin be too soft, the sections will not roll, but will become *creased*.

Either of these defects may be diminished, sometimes even totally cured, by simple means. Firstly, due attention must be paid to the position of the knife; not only to its obliquity, but also to its tilt, as explained above.

Secondly, if the paraffin should be too hard, it may be softened by setting up a lamp near it, or even by closing the window, if this should happen to be open, or by carrying the microtome to a warmer place, or by any device that will have the effect of exposing the paraffin block to an increase of temperature. An incredibly slight increase will sometimes suffice.

Thirdly, if it should be too soft, an opposite treatment must be tried. The microtome is removed to a cooler place, or the window is opened, or the like.

If none of these manoeuvres suffice to obtain sufficiently good sections, the object must be re-imbedded in a harder or softer paraffin. But it will generally be possible to save the sections by flattening them out by the water method, to be presently described.

The paraffin employed for imbedding must be of a hardness determined by the temperature of the workroom: hard paraffin for a warm room, soft paraffin for a cold room. For the Thoma microtome, a paraffin melting at 45° C. (or 113° F.) gives good results so long as

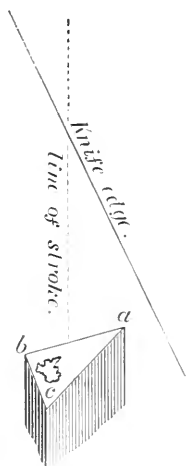

FIG. 410.

¹ Section-stretchers are instruments consisting essentially of a little metallic roller suspended over the object to be cut in such a way as to rest on its free surface with a pressure that can be delicately regulated so as to be sufficient to keep the section flat without in any way hindering the knife from gliding beneath it. They are made in various forms, the most convenient being that of Mayer, Andres and Giesbrecht, of which a description and figure may be found in the *Journal of the Roy. Microscopical Soc.*, 1883, p. 216. Now that the water flattening process (see below, *Flattening*) has been perfected, section-stretchers are not so necessary as they were formerly, and for most work may be dispensed with.

the temperature of the laboratory lies between 15° and 17° C. (59° and 62° F.); though many workers prefer, even with this instrument, a much harder mass. For microtomes *with fixed knives*, such as the Cambridge rocker, harder paraffins may be used than with sliding microtomes, paraffins of from 55° to 60° C. (131° to 140° F.) being used by many workers. For cutting ribbons with these hard masses it is frequently necessary to coat the face of the block nearest to the knife with a softer paraffin, in order that the sections may cohere.

Masses of intermediate consistency may be made by mixing a hard and a soft paraffin. Two parts of paraffin of 50° C. (122° F.) with one of 36° C. (97° F.) melting-point, give a mass melting at 48° C. (119° F.).

Mixtures of paraffin with vaseline and with various fatty and other substances have been recommended. They are now generally abandoned.

5. *Flattening the sections, and mounting.*—If the sections have come off either rolled or creased, they must be flattened before the paraffin is removed.

If they are large sections, float them on to warm water in a suitable dish. They will flatten out perfectly in a few seconds, and they may then be lifted out on a slide or cover-glass slid under them. The *water must not be warm enough to melt the paraffin*, which must only be warmed, not melted, till the sections have been securely fixed to the slide or cover. A temperature of about 40° C. (104° F.) is about right.

Or take a clean slide, free from grease, spread on it with a brush enough water to float the sections, lay the sections on it, and warm, either on the water-bath, or on a hot plate, or over a small flame, *taking care not to melt the paraffin*.

If the sections are *numerous* and small, take a perfectly clean slide, so clean that water will readily spread on it. Breathe on it, and smear on it with a brush a streak of water as wide as the sections and of the length of the first intended row. Lay the first row of sections on this streak. Breathe on the slide again, and draw on it another streak of water under the first one. Lay a second row of sections on this: and so on until the slide is full. Then warm as before.

The chief difficulty connected with this process lies in the difficulty of getting the water to spread evenly on the slide. The slide should be well freed from grease, by means of xylol or some good solvent of fats, and then cleaned with alcohol. The test for sufficient freedom from grease is, that on breathing on the slide the moisture of the breath should condense on it evenly, and evaporate evenly. The slide should also be well rubbed with a clean cloth wetted, or rather moistened, with water, before the water is definitely spread on it with the brush. Some sorts of slides cannot be got to spread the water evenly by any means.

The following is said by De Groot (*Zeitschrift f. wiss. Mikroskopie*, xv, 1, p. 62) to be infallible. Wrap the corner of a clean cloth round two fingers and rub it with a piece of chalk. Moisten

it with a drop of water and rub the slide with the chalked part, then finish with pure water and a clean part of the cloth.

6. The flattening having been accomplished by either of these processes, the sections must now be *fixed to the slide or cover* before the paraffin is removed.

The most elegant method of accomplishing this is by what is known as the *water method*. It consists simply in drying the sections on the slide (or cover). After they have been got on the slide and flattened out by water and warming as above described, the superfluous water is drained off, and the slide put away to dry. As soon as the water has entirely evaporated off, the sections will be found to be so firmly affixed to the glass that they will bear the melting of the paraffin, treatment with solvents, with alcohol or stains, &c., without moving. A convenient plan is to dry the slides on the top of the stove or water-bath at a temperature somewhat under the melting-point of the paraffin. This will take from half an hour to three or four hours. When dry the sections will have assumed a certain horny transparent look. *The paraffin must not be allowed to melt before the sections are perfectly dry.* If they are left to dry at the temperature of the room, they should be left overnight.

As soon as the sections are quite dry, the paraffin may be melted by holding the slide for a few seconds over a small flame, after which it is plunged at once into a tube of xylol or benzol or chloroform or the like, which in a few seconds or minutes dissolves out all the paraffin from the sections.

The water method is very safe for sections that present a sufficient uninterrupted surface capable of affording adhesion at all points to the slide. But sections of hollow organs, offering only a relatively small surface for attachment, adhere very badly. Sections of such things as tubular chitinous organs, for instance, will generally not allow of mounting at all in this way.

In such cases, *Mayer's albumen fixative* should be employed. Take 50 c.c. of white of egg, 50 c.c. of glycerin, and 1 gm. of salicylate of soda, shake them up well together, and filter into a clean bottle. The filtering may take days. A little, *very* little of this is now painted on to the part of the slide destined to receive the sections, and the layer smoothed by drawing the edge of a slide over it (some persons rub off the excess with the ball of a finger). Place a drop of water on the prepared surface, lay the sections on it and flatten by warming, drain and evaporate as in the water process, with this difference, however, that the evaporation need not be carried to the point of perfect drying. The slides will be sufficiently evaporated at a temperature of 40° C. in ten minutes or a quarter of an hour. And if the evaporation be conducted by waving the slide to and fro over a flame, from three to five minutes may suffice. The paraffin is then melted and removed by xylol or other solvent, as before. This process has the advantage over the water process of greater safety and greater rapidity, but has the disadvantage that the layer of albumen stains obstinately in some plasma stains, thus producing an inelegant mount.

If the sections be neither rolled nor creased, it is not necessary

to flatten them on water. They may be laid down on Mayer's albumen, without water, gently pressed down with a brush, and the paraffin melted and dissolved at once, the whole process taking only a few seconds. But for delicate histological work it is well to employ the water method in any case, as the flattening on water serves to somewhat expand the sections, which, unless cut from extremely hard paraffin, are generally somewhat compressed by the impact of the knife.

As soon as the paraffin has been removed, all that is necessary, in the pure water process, is to add a drop of balsam and a cover, if the material has been already stained. If not, the solvent of the paraffin is removed by alcohol, and the sections are stained in any manner that may be desired.

But if Mayer's albumen has been employed the sections must be thoroughly washed with alcohol before the definitive clearing and mounting. This is necessary in order to remove the glycerin, which would otherwise cause turbidity in the mount.

Tubes for Handling Serial Sections.—The most convenient vessels for performing the various operations of washing, dehydrating, clearing, staining, &c., with sections fixed to the slide, are flat bottomed corked tubes. They should have an internal diameter slightly over 1 inch, so as to be able to take two slides placed back to back; and they should be nearly 4 inches high, so as not only to take the slides in an upright position, but to allow room for the cork. A stand is easily made for them by taking a piece of inch deal board, and boring in it with a centrebit holes about $\frac{1}{2}$ inch deep, large enough to take the bottoms of the tubes, and about 1 inch apart. A board with three rows of seven holes each does not take up too much room on the work-table.

The Collodion or Celloidin Imbedding Method.—Celloidin is a patent collodion, sent out in semi-dry tablets. It may be obtained through Grüber and Hollborn. To prepare it for use for imbedding it may either be dissolved at once in a mixture of equal parts of ether and absolute alcohol, or, which is held by some workers to be preferable, it may be cut up into thin shavings, which are allowed to dry in the air until they have assumed a horny consistency, and are then dissolved in the ether and alcohol. It is held that by thus drying the celloidin all water is removed from it, and a more favourable imbedding mass obtained. Either celloidin or common collodion may be used for imbedding, celloidin having merely the advantage stated.

A thin celloidin solution is made by dissolving from 4 to 6 per cent. of the dried shavings in the alcohol and ether mixture; a thick one by dissolving from 10 to 12 per cent. of them. Thicker solutions than this are not necessary. If common collodion be taken, a thin solution should be prepared by diluting it with ether.

The objects to be imbedded must first be thoroughly dehydrated with absolute alcohol. They are then soaked, till thoroughly penetrated, in ether, or, which is better, in a mixture of ether and absolute alcohol. They are then brought into the collodion.

They should be soaked first in a *thin* solution, until thoroughly impregnated with it, for days, even for small objects; weeks or months for large ones. When well saturated with this they should be brought into a *thick* solution, and soaked in it for a long time, the longer the better.

When it is deemed that they are saturated, they may be imbedded. In many cases this may be efficiently done by simply gumming the object by means of a drop of thick collodion to a cork, or, better, a piece of soft wood, adapted to be afterwards fitted to the microtome. But for the purpose of accurate orientation it is preferable to imbed in a mould. This is done in the manner described for paraffin. A convenient mould for celluloid is made by taking a cork, and winding a strip of paper several times round one end of it, so as to form a projecting collar, which is fixed with a pin. Before using this, or any paper tray, it should be dressed by having the inside painted with collodion, which is allowed to dry before the imbedding mass is poured into it. The object of this is to prevent bubbles of air coming in through the bottom or sides of the mould. Watch-glasses, deep water-colour moulds, and the like, also make convenient imbedding receptacles. Care should be taken to have them perfectly dry.

If bubbles should appear after the mass has been poured in, they should be got rid of before proceeding further by exposing the whole to the vapour of ether for an hour or two in a closed vessel.

The next step consists in the *hardening* of the mass. One of the best ways of doing this is as follows:—

Put the preparation into a desiccator or other suitable closed vessel, on the bottom of which a teaspoonful of chloroform has been poured. As soon as the mass has attained sufficient superficial hardness, it is, of course, well to turn it out of its recipient and turn it over from time to time, in order that it may be equally exposed on all sides to the action of the vapour. Small objects may be sufficiently hardened in from one hour to overnight. When fairly hard (it is not necessary to wait till the mass has attained all the hardness of which it is susceptible), throw it into a mixture of one part of chloroform with one or two parts of cedar oil. From time to time more cedar oil should be added, so as to bring the mixture up gradually to nearly pure cedar oil. As soon as the object is cleared throughout, the mass may be exposed to the air, and the rest of the chloroform will evaporate gradually. The block may now be mounted on the holder of the microtome with a drop of thick collodion (which may be allowed to dry, or may be hardened by putting back into chloroform vapour), and may either be cut at once, or may be preserved indefinitely without change in a stoppered bottle. *Cut with a dry knife*, the cut surface will not dry injuriously under several hours. The cutting quality of the mass is often improved by allowing it to evaporate in the air for some hours.

The hardening may be done at once in the chloroform and cedar-wood mixture, instead of the chloroform vapour, but the latter process is preferable as giving a better hardening. And clearing may be done in pure cedar oil instead of the mixture, but then it will be

very slow, whereas in the mixture it is extremely rapid.' (From Mr. Lee's 'Microtometist's Vade-mecum.')

Instead of cedar oil, white oil of thyme may be employed; and some workers use glycerin.

The above process is recommended as giving good results with small objects. For large ones the alcohol process is more generally employed.

In this the mass is first subjected to a *preliminary* hardening. The mass, with the imbedded object, is set under a glass shade or put into a loosely closed vessel, so as to allow of just enough communication with the air to set up a *slow* evaporation. It is sometimes a good plan to set it under a bell-jar with a dish containing alcohol, so that the evaporation is gone through in an atmosphere of alcohol. As soon as the mass (of which only enough to just cover the object should have been taken) has so far sunk down that the object begins to lie dry, fresh thick solution is added, and the whole is left as before. The process is repeated every few hours for, if need be, two or three days.

When the mass has attained a consistency such that the ball of a finger (*not* the nail) no longer leaves an impress on it, it should be scooped out of the dish or mould, or have the paper removed if it has been imbedded in paper, and be submitted to the next stage of the hardening process.

This, *the definitive hardening*, consists in putting the preparation into alcohol, and leaving it till it has attained the right consistency (one day to several weeks). The strength of alcohol used by different workers varies between 70 per cent. and 85 per cent., the latter strength being probably the best. The vessel containing the alcohol *ought not to be tightly closed, but should be left at least slightly open*.

To fix the hardened preparation to the microtome, proceed as follows. Take a piece of soft wood, or, for very small objects, pith, of a size and shape adapted to fit the holder of the microtome. Cover it with a layer of collodion, which you allow to dry. Take the block of collodion, or the impregnated and hardened but not imbedded object; cut a slice off the bottom, so as to get a clean surface; wet this surface first with absolute alcohol, then with ether (or allow it to dry), place one drop of *very thick* collodion on the prepared wood or pith, and press down *tightly* on to it the wetted or dried surface of the block of collodion. Then throw the whole into weak (70 per cent.) alcohol for a few hours (or even less), or into chloroform, or vapour of chloroform, for a few minutes, in order that the joint may harden. (From Mr. Lee's 'Microtometist's Vade-mecum.')

Sections of material prepared in this way are cut with a knife kept abundantly wetted with alcohol (of 50 to 85 or even 95 per cent.). Some kind of drip arrangement may be found very useful here. The knife is set in as oblique a position as possible. These two points are illustrated in fig. 398.

Another method of definitive hardening and cutting is the *freezing method*. After preliminary hardening by alcohol the mass

is soaked for a few hours in water in order to get rid of the greater part of the alcohol (the alcohol should not be removed entirely, or the mass may freeze too hard). It is then dipped for a few moments into gum mucilage in order to make it adhere to the freezing plate, and is frozen. The sections are brought into warm water. If the mass have frozen too hard, cut with a knife warmed with warm water.¹

Staining and mounting.—The sections are brought into alcohol of not more than 95 per cent. as fast as they are cut, and may now either be stained or mounted at once. It is *not* in general necessary nor even desirable to remove the mass from the sections before staining or mounting. It is no hindrance to staining, and on being mounted in glycerin or balsam it becomes perfectly invisible.

To mount in glycerin, nothing more is necessary than to add a drop of glycerin and a cover.

To mount in balsam, dehydrate in alcohol of *not more than 95 per cent.*, and clear with an oil that does not dissolve collodion, such as oil of origanum, bergamot oil, cedar oil, or with chloroform or xylol.

The foregoing relates to single sections. If it be desired to mount a series of small sections under one cover, arrange them on the slide and expose it for a few minutes to the vapours of a mixture of ether and alcohol in a closed tube. Then treat with 95 per cent. alcohol, clear and mount.

If the sections are to be stained on the slide, care should be taken when arranging them to let the celloidin of each section overlap that of its neighbour at the edges, so that the ether vapour may fuse them all into a continuous sheet. Then on passing the slide into any aqueous liquid the sheet will be detached, and may then be treated as a single section.

If the sections should come off the knife creased, they may be flattened by floating them on to oil of bergamot, after which they may be got on to the slide and gently pressed on to it with a cigarette paper or a piece of glossed tissue paper, after which they may be exposed to the vapour of ether and alcohol as before.

Series may also be affixed to the slide by means of Mayer's albumen, as described above for paraffin sections.

For the complicated manipulations involved in the methods of Weigert, Obregia, and others, which are only necessary in very special cases, the reader must be referred to Mr. A. Bolles Lee's 'The Microtommist's Vade-mecum.'

Grinding and Polishing Sections of Hard Substances.—Substances which are too hard to be sliced in a microtome—such as bones, teeth, shells, corals, fossils of all kinds, and even some dense vegetable tissues—can only be reduced to the requisite thinness for microscopical examination by grinding down thick sections until they become so thin as to be transparent. General directions for making such preparations will be here given:¹ but those special

¹ The following directions do not apply to *siliceous* substances, as sections of these can only be prepared by those who possess a regular lapidary's apparatus, and have been specially instructed in the use of it.

details of management which particular substances may require will be given when these are respectively described. The first thing to be done will usually be to procure a *section* of the substance, as thin as it can be safely cut. Most substances not siliceous may be divided by the fine saws used by artisans for cutting brass; and these may be best worked either by a mechanical arrangement such as that devised by Dr. Matthews,¹ or, if by hand, between 'guides,' such as are attached for this purpose to Hailes's and some other microtomes. But there are some bodies (such as the enamel of teeth, and porcelainous shells) which, though merely calcareous, are so hard as to make it very difficult and tedious to divide them in this mode; and it is much the quicker operation to *slit* them with a disc of soft iron (resembling that used by the lapidary) charged at its edge with diamond dust, which disc may be driven in an ordinary lathe. Where waste of material is of no account, a very expeditious method of obtaining pieces fit to grind down is to detach them from the mass with a strong pair of 'cutting pincers,' or, if they be of small dimensions, with 'cutting pliers;' and a flat surface must then be given to it, either by holding them to the side of an ordinary grindstone, or by rubbing on a plate of lead (cast or planed to a perfect level) charged with emery, or by a strong-toothed file, the former being the most suitable for the *hardest* substances, the latter for the *toughest*. There are certain substances, especially calcareous fossils of wood, bone, and teeth, in which the greatest care is required in the performance of these preliminary operations, on account of their extreme friability—the vibration produced by the working of the saw or the file, or by grinding on a rough surface, being sufficient to disintegrate even a thick mass so that it falls to pieces under the hand; such specimens, therefore, it is requisite to treat with great caution, dividing them by the smooth action of the wheel, and then rubbing them down upon nothing rougher than a very fine 'grit,' or on the 'corundum files' now sold in the tool shops, which are made by imbedding corundum of various degrees of fineness in a hard, resinous substance. Where (as often happens) such specimens are sufficiently porous to admit of the penetration of Canada balsam, it will be desirable, after soaking them in turpentine for a while, to lay some liquid balsam upon the parts through which the section is to pass, and then to place the specimen before the fire or in an oven for some little time, so as first to cause the balsam to run in, and then to harden it; by this means the specimen will be rendered much more fit for the processes it has afterwards to undergo. It not unfrequently happens that the small size, awkward shape, or extreme hardness of the body occasions a difficulty in holding it either for cutting or grinding; in such a case it is much better to attach it to the glass in the first instance by any side that happens to be flattest, and then to rub it down, by means of the 'hold' of the glass upon it, until the projecting portion has been brought to a plane, and has been prepared for permanent attachment to the glass. This is the method which it is generally most convenient to pursue with regard to small bodies; and there are many which can scarcely

¹ *Journ. Quekett Microsc. Club*, vol. vi. 1880, p. 83.

be treated in any other way than by attaching a number of them to the glass at once in such a manner as to make them mutually support one another.¹

The mode in which the operation is then to be proceeded with depends upon whether the section is to be ultimately set up in Canada balsam, or is to be mounted 'dry,' or in fluid. In the former case the following is the plan to be pursued :—The flattened surface is to be polished by rubbing it with water on a 'Water-of-Ayr' stone, or on a hone or 'Turkey' stone, or on an 'Arkansas' stone: the first of the three is the best for all ordinary purposes, but the two latter, being much harder, may be employed for substances which resist it.² When this has been sufficiently accomplished, the section is to be attached with hard Canada balsam to a slip of thick, well-annealed glass; and as the success of the final result will often depend upon the completeness of its adhesion to this, the means of most effectually securing that adhesion will now be described in detail. The slide having been placed on the cover of the water-bath, and the previously hardened balsam having been softened by the immersion of the jar containing it in the bath itself, a sufficient quantity of this should be laid on the slide to form, when spread out by liquefaction, a thick drop, somewhat larger than the surface of the object to be attached. The slide should then be allowed to cool in order that the hardness of the balsam should be tested. If too soft, as indicated by its ready yielding to the thumbnail, it should be heated a little more, care being taken not to make it boil so as to form bubbles; if too hard, which will be shown by its chipping, it should be remelted and diluted with more fluid balsam, and then set aside to cool as before. When it is found to be of the right consistence, the section should be laid upon its surface with the polished side downwards: the slip of glass is next to be gradually warmed until the balsam is softened, special care being taken to avoid the formation of bubbles: and the section is then to be gently pressed down upon the liquefied balsam, the pressure being at first applied rather on one side than over its whole area, so as to drive the superfluous balsam in a sort of wave towards the other side, and an equable pressure being finally

¹ Thus, in making horizontal and vertical sections of Foraminifera, as it would be impossible to slice them through, they must be laid close together in a bed of hardened Canada balsam on a slip of glass, in such positions that when rubbed down the plane of section shall traverse them in the desired directions; and one flat surface having been thus obtained for each, this must be turned downwards, and the other side ground away. The following ingenious plan was suggested by Dr. Wallich (*Ann. of Nat. Hist.* July 1861, p. 58) for turning a number of minute objects together, and thus avoiding the tediousness and difficulty of turning each one separately:—The specimens are cemented with Canada balsam, in the first instance, to a thin film of mica, which is then attached to a glass slide by the same means: when they have been ground down as far as may be desired, the slide is gradually heated just sufficiently to allow of the detachment of the mica film and the specimens it carries; and a clean slide with a thin layer of hardened balsam having been prepared, the mica film is transferred to it with the ground surface downwards. When its adhesion is complete, the grinding may be proceeded with; and as the mica film will yield to the stone without the least difficulty, the specimens, now reversed in position, may be reduced to requisite thinness.

² As the *flatness* of the polished surface is a matter of the first importance, that of the stones themselves should be tested from time to time; and whenever they are found to have been rubbed down on any one part more than on another, they should be flattened on a paving-stone with fine sand, or on the lead-plate with emery.

made over the whole. If this be carefully done, even a very large section may be attached to glass without the intervention of any air-bubbles. If, however, they should present themselves, and they cannot be expelled by increasing the pressure over the part beneath which they are, or by slightly shifting the section from side to side, it is better to take the section entirely off, to melt a little fresh balsam upon the glass, and then to lay the section upon it as before.

When the section has been thus secured to the glass, and the attached part thoroughly saturated (if it be porous) with hard Canada balsam, it may be readily reduced in thickness, either by grinding or filing, as before, or, if the thickness be excessive, by taking off the chief part of it at once by the slitting wheel. So soon, however, as it approaches the thinness of a piece of ordinary card, it should be rubbed down with water on one of the smooth stones previously named, the glass slip being held beneath the fingers with its face downwards, and the pressure being applied with such equality that the thickness of the section shall be (as nearly as can be discerned) equal over its entire surface. As soon as it begins to be translucent, it should be placed under the microscope (particular regard being had to the method of illumination so as not to flood the object with light), and note taken of any inequality; and then when it is again laid upon the stone, such inequality may be brought down by making special pressure with the forefinger upon the part of the slide above it. When the thinness of the section is such as to cause the water to spread around it between the glass and the stone, an excess of thickness on either side may often be detected by noticing the smaller distance to which the liquid extends. In proportion as the substance attached to the glass is ground away, the superfluous balsam which may have exuded around it will be brought into contact with the stone; and this should be removed with a knife, care being taken, however, that a margin be still left round the edge of the section. As the section approaches the degree of thinness which is most suitable for the display of its organisation, great care must be taken that the grinding process be not carried too far; and frequent recourse should be had to the microscope, which it is convenient to have always at hand when work of this kind is being carried on. There are many substances whose intimate structure can only be displayed in its highest perfection when a very little more reduction would destroy the section altogether; and every microscopist who has occupied himself in making such preparations can tell of the number which he has sacrificed in order to attain this perfection. Hence, if the amount of material be limited, it is advisable to stop short as soon as a *good* section has been made, and to lay it aside—letting well alone—whilst the attempt is being made to procure a *better* one; if this should fail, another attempt may be made, and so on, until either success has been attained or the whole of the material has been consumed; the *first* section, however, still remaining, whereas, if the first, like every subsequent section, be sacrificed in the attempt to obtain perfection, no trace will be left to show what once has been. In judging of the

appearance of a section in this stage under the microscope, it is to be remembered that its transparence will subsequently be considerably increased by mounting in Canada balsam: this is particularly the case with fossils to which a deep hue has been given by the infiltration of some colouring matter, and with any substances whose particles have a molecular aggregation that is rather amorphous than crystalline. When a sufficient thinness has been attained the section may generally be mounted in Canada balsam; and the mode in which this must be managed will be detailed hereafter.

By a slight variation in the foregoing process, sections may be made of structures in which (as in corals) *hard and soft parts are combined*, so as to show both to advantage. Small pieces of the substance are first to be stained thoroughly and are then to be 'dehydrated' by alcohol. A thin solution of copal in chloroform is to be prepared, in which the pieces are to be immersed; and this solution is to be concentrated by slow evaporation, until it can be drawn out in threads which become brittle on cooling. The pieces are then to be taken out, and laid aside to harden; and when the copal has become so firm that the edge of the finger-nail makes no impression, they are to be cut into slices and ground down attached to glass in the manner already described, the sections being finally mounted in Canada balsam. The sections (attached to glass) may be partially or completely decalcified, the soft parts remaining *in situ*, by first dissolving out the copal with chloroform; when, after being well washed in water, they should be again stained, and mounted either in weak spirit or (after having been dehydrated) in Canada balsam.¹

A different mode of procedure, however, must be adopted when it is desired to obtain sections of bone, tooth, or other finely tubular structures, *unpenetrated* by Canada balsam. If tolerably thin sections of them can be cut in the first instance, or if they are of a size and shape to be held in the hand whilst they are being roughly ground down, there will be no occasion to attach them to glass at all; it is frequently convenient to do this at first, however, for the purpose of obtaining a 'hold' upon the specimen; but the surface which has been thus attached must afterwards be completely rubbed away in order to bring into view a stratum which the Canada balsam shall not have penetrated. As none but substances possessing considerable toughness, such as bones and teeth, can be treated in this manner, and as these are the substances which are most quickly reduced by a coarse file, and are least liable to be injured by its action, it will be generally found possible to reduce the sections nearly to the required thinness by laying them upon a piece of cork or soft wood held in a vice, and operating upon them first with a coarser and then with a finer file. When this cannot safely be carried farther, the section must be rubbed down upon that one of the fine stones already mentioned which is found best to suit it; as long as the section is tolerably thick, the finger may be used to press and move it; but as

¹ See Koch in *Zoologischer Anzeiger*, Bd. i, p. 36. The Author, having seen (by the kindness of Mr. H. N. Moseley) some sections of corals prepared by this process, can testify to its complete success.

soon as the finger itself begins to come into contact with the stone, it must be guarded by a flat slice of cork, or by a piece of gutta-percha a little larger than the object. Under either of these, the section may be rubbed down to the desired thinness; but even the most careful working on the finest-grained stone will leave its surface covered with scratches, which not only detract from its appearance, but prevent the details of its internal structure from being as readily made out as they can be in a polished section. This polish may be imparted by rubbing the section with putty-powder (peroxide of tin) and water upon a leather strap made by covering the surface of a board with buff leather, having three or four thicknesses of cloth, flannel, or soft leather beneath it; this operation must be performed on both sides of the section, until all the marks of the scratches left by the stone shall have been rubbed out, when the specimen will be fit for mounting 'dry,' after having been carefully cleansed from any adhering particles of putty-powder.

Greater facility in the grinding of hard sections, as well as superiority of result, is attainable by simple mechanical means.

A cutting machine will greatly facilitate the process of preparing

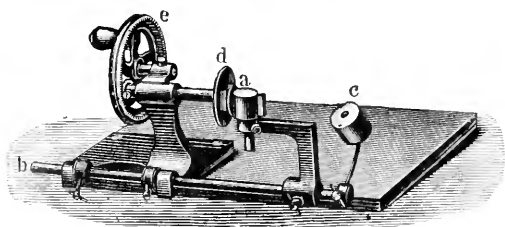

FIG. 411.—Hand machine for cutting hard sections.

rock slices. The thickness of each slice must be mainly regulated by the nature of the rock, the rule being to make it as thin as can be conveniently cut, so as to save labour in grinding down afterwards. Perhaps the thickness of a shilling may be taken as a fair average. This thickness may be still further reduced by cutting and polishing a face of the specimen, cementing that on glass, and then cutting as close as possible to the cemented surface. The thin slice thus left on the glass can then be ground down with comparative ease.

The first (fig. 411) is a hand machine. The specimen is cemented to the carrier, *a*, which is movable on the axis, *b*, and can also be rotated in two directions. The object is pressed by the weight, *c*, against the steel disc, *d*, which is revolved by the wheel, *e*, acting on a smaller-toothed wheel on the axis of *d*.

The second (fig. 412) is intended to be worked by the foot. The parts *a*, *b*, *c*, and *d* are the same as before. The wheel and treadle at *f* and *g* work the pulley, *e*, by which the steel disc, *d*, is revolved; *h* is part of the cover for the disc, to prevent the emery flying about. A box beneath also catches the powder that falls.

(This arrangement is also supplied with fig. 411, though not shown in the woodcut.) A second wheel at *i*, with a cord passing over *k*,

actuates a vertical spindle, *l*, which rotates a horizontal cast-iron plate at *m* for polishing.

Decalcification.—When it is desired to examine the structure of the organic matrix in which the calcareous salts are deposited that give hardness to many animal and to a few vegetable structures (such as the true corallines), these salts must be dissolved away by the action of some acid, such as nitric or hydrochloric. This should be employed in a very dilute state, in order that it may make as little change as possible in the soft tissue it leaves behind. When the

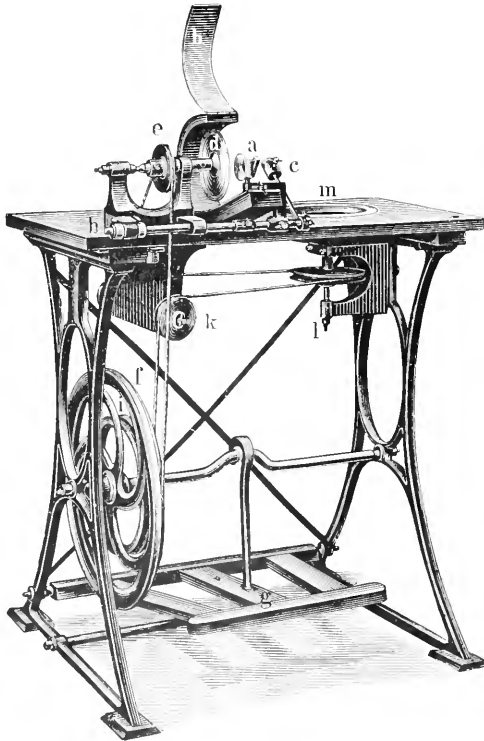

FIG. 412.—Treadle machine for cutting hard sections.

lime is in the state of carbonate (as, for example, in the skeletons of *echinoderms*), the body to be decalcified should be placed in a glass jar or wide-mouthed bottle holding from 4 to 6 oz. of water, and the acid should be added drop by drop, until the disengagement of air-bubbles shows that it is taking effect; and the solvent process should be allowed to take place very gradually, more acid being added as required. When, on the other hand, much of the lime is in the state of phosphate, as in bones and teeth, the strength of the acid solvent must be increased; and for the hardening of the softer parts of the organic matrix it is desirable that chromic acid should be

used. In the case of small bones, or delicate portions of large (such as the cochlea of the ear), a $\frac{1}{2}$ per cent. solution of chromic acid will itself serve as the solvent; but larger masses require either nitric or hydrochloric acid in addition, to the extent of 2 per cent. of the former or 5 per cent. of the latter. By some the chromic and the nitric or hydrochloric acid are mixed-in in the first instance, while by others it is recommended that the bone should lie first in the chromic acid solution for a week or ten days, and that the second acid should be then added. If the softening be not completed in a month, more acid must be added. When thoroughly decalcified, the bone should be transferred to rectified spirit; and it may then be either sliced in the microtome or torn into shreds for the demonstration of its lamellæ. Acid solvents may also be employed in removing the outer parts of calcareous skeletons, for the display of their internal cavities (a plan which the Author has often found very useful in the study of *Foraminifera*), or for getting rid of them entirely, so as to bring into complete view any 'internal cast' which may have been formed by the silicification of its originally soft contents. It has been in this mode, even more than by the cutting of thin sections, that the structure of *Eozoön canadense* has been elucidated by Professor Dawson and the Author. For the first of these purposes strong acid should be applied (under the dissecting microscope) with a fine camel's-hair pencil; and another such pencil charged with water should be at hand, to enable the observer to stop the solvent action whenever he thinks it has been carried far enough. For the second it is better that the acid should only be strong enough for the *slow* solution of the shelly substance, as the too rapid disengagement of bubbles often produces displacement of delicate parts of the substituted mineral; whilst, if the acid be too strong, the 'internal cast' may be altogether dissolved away.

Busch suggests nitric acid as the best of all agents for decalcification, insomuch as it does not cause 'swelling up,' nor injuriously attack the tissue elements.

One volume of chemically pure nitric acid of specific gravity 1.25 diluted with ten volumes of water may be employed for large and tough bones; but it may be diluted to 1 per cent. for young bones.

The method given is that fresh bones should be laid in alcohol of 95 per cent. for three days; they must then be placed in the nitric acid, which must be changed daily for eight days. They must not remain after the decalcification is complete, or they will become yellow. On removal the bones must be washed for a couple of hours in running water and placed again in 95 per cent. alcohol, and in a few days placed again in fresh alcohol.

Desilicification.—It is desirable to be able to remove siliceous as well as calcareous elements from objects. To do this a glass vessel should be carefully coated with paraffin internally, to prevent the action of the acid used taking place on the sides of the vessel. The subject to be cleared of its silica is placed in alcohol in the coated vessel, and hydrofluoric acid is added drop by drop. As the mucous membranes are fiercely attacked by this acid, great care must be exercised in its use; but small sponges and other similar siliceous

objects by remaining a few hours or a day in this are wholly deprived of their silica, while the tissues do not suffer.

Preparation of Vegetable Substances.—Little preparation is required, beyond steeping for a short time in distilled water to get rid of saline or other impurities, for mounting in preservative media specimens of the minuter forms of vegetable life, or portions of the larger kinds of *algæ*, *fungi*, or other succulent cryptogams. But the woody structures of *phanerogams* are often so consolidated by gummy, resinous, or other deposits that sections of them should not be cut until they have been *softened* by being partially or wholly freed from these. Accordingly, pieces of stems or roots should be soaked for some days in water, with the aid of a gentle heat if they are very dense, and should then be steeped for some days in methylated spirit, after which they should again be transferred to water. The same treatment may be applied to hard-coated seeds, the ‘stones’ of fruit, ‘vegetable ivory,’ and other like substances. Some vegetable substances, on the other hand, are too soft to be cut sufficiently thin without previous *hardening*, either by allowing them to lose some of their moisture by evaporation, or by drawing it out by steeping them in spirit. Either treatment answers very well with such substances as that which forms the tuber of the potato, sections of which display the starch-grains *in situ*. Where, on the other hand, it is desired to preserve colour, spirit must not be used; and recourse may be had to gum-embedding, which is particularly serviceable where the substance is penetrated by air-cavities, as is the case with the stem of the *rush*, the thick leaves of the *water-lily*, &c. The tissue is well soaked in a syrupy solution of gum arabic, and this is then hardened, either by allowing it to slowly evaporate, or by throwing it into strong alcohol, or by freezing it. But where *staining* processes are to be employed, the substance should be previously bleached by the action of chlorine (preferably by Labarraque’s chlorinated soda), and then treated with alcohol for a few hours.

For the rest, the minute structure of the higher plants is studied by means of the methods of fixing, staining, and section-cutting above described for the tissues of animals. For plants, absolute alcohol is much used as a fixing agent, the other reagents employed in their preparation being in general the same as those used in animal histology.

Staining Bacteria.—It is needful to employ somewhat specialised methods for staining the saprophytic, pathogenic, and other schizomycetes. Some of these stain admirably, but others, especially the somewhat larger forms, are much altered, and unless observations are controlled with accurate and constant observations on the organisms in a living condition the most egregious errors may arise.

(1) Take half a dozen cases of putrescence in which solid tissues are decomposing, but which are in different states of decomposition. From each take out with a pipette a small quantity, and transfer to a carefully prepared and well-filtered decoction of veal in a small glass vessel, at the temperature of the respective putrefactions; leave this for half an hour. Then with a fine pipette take out a minute drop from each vessel and diffuse each drop upon a cover-glass; let

evaporation go on in a warm room for twenty minutes, then fix the film of saprophytes by means of fairly strong osmic acid vapour; float the cover with the surface of bacteria downwards on a vessel of solution of violet of methyl-anilin for an hour or less, drain the edge of the cover-glasses on blotting-paper, and mount in glycerin.

(2) Now take drops of the fluid from the several vessels and in a moist growing cell examine the living forms, and compare these with your dried and stained preparations.

(3) By another method, which will apply also to the bacillus of tuberculosis, a layer of sputum or of putrefactive fluid may be spread as before upon a cover-glass, dried in an air-oven at about 100° F., and then passed three times, moderately slowly, through the flame of a spirit-lamp, so as to thoroughly 'fix' the preparation by coagulating its albumen. Mix 1 c.c. of concentrated solution of methylen-blue in alcohol, 0.2 c.c. of 10 per cent. solution of potash, and 200 c.c. of distilled water. On to this float the cover with its surface of bacteria downwards and leave for twenty-four hours; the film will be coloured blue; place a few drops of a solution of vesuvium all over the film, which drives out the methylen-blue from all but the bacteria. Finish with alcohol and oil of cloves, and mount in balsam.

For the same purpose Professor Heneage Gibbes gives a method which has proved of great value. Take of rosanilin hydrochloride 2 grms., methylen-blue 1 gm.; rub them up in a glass mortar. Then dissolve anilin oil, 3 c.c., in rectified spirit, 15 c.c.; add the spirit slowly to the stains until all is dissolved, then slowly add distilled water, 15 c.c. Keep in a stoppered bottle.

In the usual way dry the sputum, &c., on a cover-glass and fix in a flame as a few drops of the stain are poured into a test-tube and warmed. As soon as steam rises pour into a watch-glass and float the cover-glass on the warm stain; allow it to remain four or five minutes; or if we do not heat the stain but use it cold, let it remain for at least half an hour. Wash in methylated spirit until no colour comes off; drain, and then dry in an air-oven, and mount in balsam.

Staining Bacteria in Tissues (Löffler's solution).—To 100 parts of solution of caustic potash of 1 : 10,000 add 30 parts of saturated alcoholic solution of methylen-blue. Filter. Stain section for one or two hours, wash out with acetic acid of $\frac{1}{2}$ per cent., followed by water. Dehydrate with absolute alcohol, clear with cedar oil, and mount in balsam.

A process of *differential staining* of bacillus tuberculosis which was devised by MM. Pittion and Roux was presented recently (1889) to the Société de Médecine de Lyon, and has met with high commendation. It requires three solutions:—

A. Ten parts of fuchsin dissolved in 100 parts of absolute alcohol.

B. Three parts of liquid ammonia dissolved in 100 parts of distilled water.

C. Alcohol 50 parts, water 30 parts, nitric acid 20 parts, anilin-green to saturation. In preparing this solution dissolve the green in the alcohol, add the water, and lastly the acid.

It is used thus, viz. to 10 parts of solution B add one part of solution A, and heat until vapour shows itself, then immerse the whole cover-glass prepared as in the ordinary way for staining. One minute suffices to stain the bacilli. Wash with plenty of water, and after rinsing with distilled water drop on the film side of the cover-glass a small quantity of solution C, which is not to remain more than forty seconds. Wash off with plenty of water, dry, and mount in xylol balsam.

The bacilli will be found to be stained a fine rose-red upon a pale-green ground.

Staining Flagella.—The following is the latest form of the celebrated method of Löffler. A mordant is made as follows: To 10 c.c. of a 20 per cent. aqueous solution of tannin are added 5 c.c. of cold saturated solution of ferrous sulphate and 1 c.c. of (either aqueous or alcoholic) solution of fuchsin, methyl-violet, or 'Wollschwarz.' Cover-glass preparations are made and fixed in a flame in the manner described above, special care being taken not to over-heat. Whilst still warm the preparation is treated with the above described mordant, and is heated in contact with it for half a minute, until the liquid begins to vaporise, after which it is washed in distilled water and then in alcohol. It is then treated in a similar manner with the stain, which consists of a saturated solution of fuchsin in anilin water (water in which a little anilin oil has been shaken up and filtered), the solution being preferably neutralised to the point of precipitation by cautious addition of 0.1 per cent. soda solution. For some further details concerning this process, the 'Journal of the Royal Microscopical Society' for 1890, p. 678, may be consulted.

Chemical Testing.—It is often requisite, alike in biological and in mineralogical investigations, to apply chemical tests in minute quantity to objects under microscopic examination. Various contrivances have been devised for this purpose; but the Author would recommend, from his own experience, the small glass syringe already described, or preferably the drop bottle, pp. 475–477, with a fine-pointed nozzle, as the most convenient instrument. One of its advantages is the very precise regulation of the quantity of the test to be deposited which can be obtained by the dexterous use of it; whilst another consists in the power of withdrawing any excess. Care must be taken in using it to avoid the contact of the test-liquid with the packing of the piston. Whatever method is employed, great care should be taken to avoid carrying away from the slide to which the test-liquid is applied any loose particles which may lie upon it, and which may be thus transferred to some other object, to the great perplexity of the microscopist. For testing inorganic substances the ordinary chemical reagents are of course to be employed; but certain special tests are required in biological investigation, the following being those most frequently required:—

a. Solution of *iodine* in water (1 gr. of iodine, 3 grs. of iodide of potassium, 1 oz. of distilled water) turns *starch* blue and *cellulose* brown: it also gives an intense brown to *albuminous* substances.

β. *Chlor-iodide of zinc* (Schultze's solution) is perhaps best made

as follows:—Evaporate 100 c.c. of liquor zinci chloridi (B.P.) to 70 c.c.; dissolve in it 10 grms. of iodide of potassium; then add 0.2 gm. iodine; shake at intervals till saturated.

This is extremely useful for the detection of pure cellulose. The zinc chloride converts cellulose into amyloid, which is then turned blue by free iodine. Wood-cells, cork-cells, the extine of pollen grains, and all lignified or corky membranes, are coloured yellow. Starch colours blue, but is rapidly disorganised.

A very weak solution will instantly detect tannin, the cell contents in which it forms a part becoming reddish or violet.

γ. Solution of *caustic potass or soda* (the latter being generally preferable) has a remarkable solvent effect upon many organic substances, both animal and vegetable, and is extremely useful in rendering some structures transparent, whilst others are brought into view, its special action being upon *horny* textures, whose component cells are thus rendered more clearly distinguishable.

δ. Dilute *sulphuric acid* (one of acid to two or three parts of water) gives to *cellulose* that has been previously dyed with iodine a blue or purple hue; also, when mixed with a solution of sugar, it gives a rose-red hue, more or less deep, with *nitrogenous* substances and with bile (Pettenkofer's test).

Sulphuric acid causes starch grains to swell and similarly affects cellulose.

ε. Concentrated *nitric acid* gives to *albuminous* substances an intense yellow.

ζ. *Acid nitrate of mercury* (Millon's test) (ten parts of mercury, ten of fuming nitric acid, and twenty of water) colours albuminous substances red.

η. *Acetic acid*, which should be kept both concentrated and diluted with from three to five parts of water, is very useful to the animal histologist from its power of dissolving, or at least of reducing to such a stage of transparency that they can no longer be distinguished, certain kinds of membranous and fibrous tissues, so that other parts (especially *nuclei*) are brought more strongly into view.

θ. *Ether* dissolves resins, fats, and oils; but it will not act on these through membranes penetrated with watery fluid. For the same purpose chloroform, benzol, oil of turpentine, and carbon bisulphide are used.

ι. *Alcohol* dissolves resins and some volatile oils, but it does not act on ordinary oils and fats. It coagulates albuminous matters, and consequently renders more opaque such textures as contain them.

κ. Osmic acid is a test for fatty matters, which it stains black in varying degrees; and in like manner for gallic and tannic acids.

Preservative and Mounting Media.—We have now to consider the various modes of preserving the preparations that have been made by the several methods indicated above, and shall first treat of such as are applicable to those minute animal and vegetable organisms, and to those sections or dissections of large structures, which are suitable for being mounted as *transparent* objects. A broad distinction may be in the first place laid down between *resinous* and *aqueous* preservative media; to the former belong

Canada balsam and dammar, while the latter include all the mixtures of which water is a component; while partly dehydrating media, such as glycerin and alcohol, occupy an intermediate position. The choice between the three kinds of media will partly depend upon the nature of the processes to which the object may have been previously subjected and partly upon the degree of transparence which may be advantageously imparted to it. Sections of substances which have been not only imbedded in but penetrated by paraffin, and have been stained (if desired) previously to cutting, are, as a rule, most conveniently mounted in Canada balsam or dammar; since they can be at once transferred to either of these from the menstruum by which the imbedding material has been dissolved out. The durability of this method of mounting makes it preferable in all cases to which it is suitable, the exception being where it renders a very thin section *too* transparent. In such cases sections or other objects may sometimes be more advantageously mounted in some of those aqueous preparations of glycerin which approach the resinous media in transparence and permanence. When Canada balsam was first employed for mounting preparations it was employed in its natural semi-fluid state, in which it consists of a solution of resin in volatile oil of turpentine; and unless a large proportion of the latter constituent was driven off by heat in the process of mounting (bubbles being thus formed of which it was often difficult to get rid), or the mounted slide was afterwards subjected to a more moderate heat of long continuance, the balsam would remain soft, and the cover liable to displacement. This is avoided by the method now generally adopted of previously getting rid of the turpentine by protracted exposure of the balsam to a heat not sufficient to boil it, and dissolving the resin thus obtained either in xylo, benzol, or chloroform, but far preferably the former, the solution being made of such viscosity as will allow it to 'run' freely. Either of these solvents evaporates so much more quickly than turpentine that the balsam left behind hardens in a comparatively short time. *Xylobalsam* is now preferred by most mounters. It is made of equal volumes of xylo and balsam. The *natural* balsam, however, may be preferably used (with care to avoid the liberation of bubbles by over-heating) in mounting sections already cemented to the slides by hardened balsam, and also for mounting the glutinous textures of insects, which it has a peculiar power of rendering transparent, and which seem to be penetrated by it more thoroughly than they are by the artificially prepared solution. The solution of dammar in xylo is very convenient to work with, and hardens quickly.

The following are the principal *aqueous* media whose value has been best tested by general and protracted experience:—

a. Fresh specimens of minute protophytes can often be very well preserved in *distilled water* saturated with camphor, the complete exclusion of air serving both to check their living actions and to prevent decomposing changes. When the preservation of colour is not a special object a tenth part of alcohol may be added, and this will be found a suitable medium for the preservation of many delicate animal textures.

β. *Salt solution*, 0.75 per cent. sodium chloride in water. Useful as a medium for temporary examination, but not for permanent preservation.

γ. *White of an egg*.—Simply filter.

δ. *Syrup* in which is dissolved 1 to 5 per cent. of chloral hydrate, or 1 per cent. of carbolic acid.

ε. *Liquid of Ripart and Petit*.—Camphor water (not saturated), 75 grms.; distilled water, 75 grms.; glacial acetic acid, 1 gm.; acetate of copper, 0.30 gm.; chloride of copper, 0.30 gm. May be added to preparations stained with methyl-green, which it does not precipitate, and may be used for preserving either vegetal or animal tissues.

ζ. *Fabre-Domergue's Glucose Medium*.—Glucose syrup of specific gravity 1.1968, 1,000 parts; methyl alcohol (wood spirit), 200; glycerin, 100; camphor to saturation. The glucose to be dissolved in warm water and the other ingredients added, and the mixture, which is always acid, neutralised with a little potash or soda.

η. *Chloral Hydrate*.—A 5 per cent. solution in water, or 12 grains chloral hydrate to 1 fluid ounce of camphor water. (Mount in strong glycerin jelly.)

θ. *Brun's Glucose Medium*.—Distilled water, 140 parts; camphorated spirit, 10 parts; glucose, 40; glycerin, 10. Mix the water, glucose, and glycerin, then add the spirit, and filter to remove the excess of camphor which is precipitated. This medium preserves the colour of preparations stained with anilin dyes, *methyl-green* included.

ι. *Gum and Syrup*.—Gum-mucilage (B.P.) five parts, syrup three parts. Add 5 grains of pure carbolic acid to each ounce of the medium.

B.P. gum-mucilage is made by putting 4 oz. of picked gum acacia in 6 oz. of distilled water until dissolved.

Syrup is made by dissolving a pound of loaf sugar in a pint of distilled water and boiling.

κ. *The glycerin jelly* prepared after the manner of Mr. Lawrence may be strongly recommended as suitable for a great variety of objects, animal as well as vegetable, subject to the cautions already given:—Take any quantity of Nelson's gelatin, and let it soak for two or three hours in cold water, pour off the superfluous water, and heat the soaked gelatin until melted. To each fluid ounce of the gelatin add one drachm of alcohol and mix well; then add a fluid drachm of the white of an egg. Mix well while the gelatin is fluid, but cool. Now boil until the albumen coagulates, and the gelatin is quite clear. Filter through fine flannel, and to each fluid ounce of the clarified gelatin add six fluid drachms of Price's pure glycerin, and mix well. For the six fluid drachms of glycerin a mixture of two parts of glycerin to four of camphor-water may be substituted. The objects intended to be mounted in this medium are best prepared by being immersed for some time in a mixture of one part of glycerin with one part of diluted alcohol (one of alcohol to six of water).¹ A small quantity of absolute phenol may be added to it with advantage.

¹ A very pure glycerin jelly, of which the Author has made considerable use, is prepared by Mr. Rimmington, chemist, Bradford, Yorkshire.

When used, the jelly must be liquefied by gentle warmth, and it is useful to warm both the slide and the cover-glass previously to mounting. This takes the place of what was formerly known as Dean's medium, in which honey was used to prevent the hardening of the gelatin.

λ. For objects which would be injured by the small amount of heat required to liquefy the last-mentioned medium, the *glycerin and gum* medium of Mr. Farrants will be found very useful. This is made by dissolving four parts (by weight) of picked gum arabic in four parts of cold distilled water, and then adding two parts of glycerin. The solution must be made without the aid of heat, the mixture being occasionally stirred, but not shaken, whilst it is proceeding; after it has been completed the liquid should be strained (if not perfectly free from impurity) through fine cambric previously well washed out by a current of clean cold water; and it should be kept in a bottle, closed with a glass stopper or cap (not with cork), containing a small piece of camphor. The great advantage of this medium is that it can be used cold, and yet soon viscifies without cracking; it is well suited to preserve delicate animal as well as vegetable tissues, and in most cases increases their transparence.

Of late years *glycerin* has been largely used as a preservative, either alone, according to the method of Dr. Beale, or diluted with water, or mixed with gelatinous substances. It is much more favourable to the preservation of colour than most other media, and is therefore specially useful as a constituent of fluids used for mounting vegetable objects in their natural aspects. It has also the property of increasing the transparence of animal structures, though in a less degree than resinous substances, and may thus be advantageously employed as a component of media for mounting objects that are rendered too transparent by balsam or dammar. Two cautions should be given in regard to the employment of glycerin: *first*, that, as it has a solvent power for carbonate of lime, it should not be used for mounting any object having a calcareous skeleton; and *second*, that, in proportion as it increases the transparence of organic substances, it diminishes the reflecting power of their surfaces, and should never be employed, therefore, in the mounting of objects to be viewed by *reflected* light, although many objects mounted in the media to be presently specified are beautifully shown by 'dark-ground' illumination.

1. A mixture of one part of glycerin and two parts of camphor-water may be used for the preservation of many vegetable structures.

2. For preserving soft and delicate marine animals which are shrivelled up, so to speak, by stronger agents, the Author has found a mixture of one part of glycerin and one of spirit with eight or ten parts of sea-water the most suitable preservative.

3. For preserving minute vegetable preparations the following method, devised by Häntsch, is said to be peculiarly efficient: A mixture is made of three parts of pure alcohol, two parts of distilled water, and one part of glycerin; and the object, laid in a cement-cell, is to be covered with a drop of this liquid, and then put aside under a bell-

glass. The alcohol and water soon evaporate, so that the glycerin alone is left; and another drop of the liquid is then to be added, and a second evaporation permitted, the process being repeated, if necessary, until enough glycerin is left to fill the cell, which is then to be covered and closed in the usual mode.¹

Canada balsam is one of the most universally employed mounting media; very old hard balsam should be dissolved in enough pure xylol or chloroform to make a thin solution, which should be carefully filtered.

Dammar.—Dissolve gum-dammar with heat in a mixture of equal parts of benzole and turpentine, and evaporate to a syrupy consistency. This is pleasant to use, but treacherous. Dammar dissolved in pure xylol in the cold gives a beautiful solution, but on the score of permanency is not so trustworthy as balsam.

Gum Styrax.—This is a resin which must be dissolved in benzole, chloroform, or ether. It should have the consistency of olive oil; all the benzole must be evaporated before putting the cover on the slip; its refractive index is said to be then 1.583. Its value is in the mounting of diatoms, where a marked difference between the refractive index of the siliceous frustules and the medium in which they are mounted facilitates the discovery of obscure details. There is a marked increase of visibility in proportion as the mounting medium has a refractive index higher than the object (diatom) mounted.

Now the refractive index of the siliceous diatoms is 1.43. But Canada balsam is 1.52; hence the 'index of visibility' in obscure markings is 9, while styrax by comparison is 15.

Monobromide of naphthalin is another of the media which may be used with a high refractive index. It is colourless and oil-like, soluble in alcohol and ether. It has a refractive index of 1.658, and therefore a splendid index of visibility above balsam or styrax; but after a lapse of many months some change takes place which leaves the preparation as apparently perfect as before, but having lost all the benefit of great refractive index.

The cover-glass should be run round with a ring of wax, then with a ring of Heller's porcelain cement, and be finally closed with shellac.

But with the exception of some media of very high refractive index not by any means easy to use, devised by Professor H. L. Smith, there is no medium of such high value as that suggested and very successfully employed by Mr. J. W. Stephenson, viz.

Phosphorus.—Its refractive index is 2.1, and its consequent increase of visibility is of immense value in some objects.

Phosphorus, it need hardly be said, is difficult and somewhat dangerous to handle on account of its spontaneous combustion in air, and the severe nature of the burns it inflicts. But it is with slight practice by no means an unmanageable medium.

To prepare it, take a 2-draclm bottle with no contraction for the

¹ See the Rev. W. W. Spicer's *Handy-book to the Collection and Preparation of Freshwater and Marine Algae*, &c., pp. 57-59. 'Nothing,' says Mr. Spicer, 'can exceed the beauty of the preparations of *Desmidiaceae* prepared after Herr Häntsch's method, the form of the plant and the colouring of the endochrome having undergone no change whatever.'

neck. Make a cylinder of wood that will just fit the inside of the neck. Fold some filter paper down and around this cylinder so that it will just fit tightly into the neck of the bottle, to the bottom of which it is forced, and the cylinder of wood withdrawn, leaving the filter in its place. Now moisten the filter carefully with a few drops of bisulphide of carbon, and a piece of stick phosphorus from a quarter to three-eighths of an inch long should be placed in the filter, and the bottle corked. The vapour of the bisulphide instantly acts on the phosphorus, and in about half an hour it will be in a fluid state remaining in the filter. By releasing the cork and taking hold of the filter tube with a pair of pliers and slowly drawing it upwards a partial vacuum is formed beneath it, and the pressure of the air on the surface of the fluid phosphorus forces it through the filter, leaving the now brilliant fluid in the bottle.

With care, rapidity, and firmness withdraw the filter and plunge *instantly* into a vessel of water close at hand.

In mounting we assume that the best course as advised above has been adopted, and that the diatoms to be mounted are either arranged or diffused upon the cover-glass.

Make a ring upon the slip of glue and honey cement used warm and allowed to cool. It is now a stiff jelly. Lay the cover in its place, with the diatoms downwards, touching the ring at one side, but raised by a fine wire on the side next the operator. A pipette may also be used made of glass tubing an eighth of an inch in external diameter, drawn to a fine point at one end, and somewhat enlarged at the other, and to which an indiarubber cap or nipple is fastened airtight. This pipette must be passed through the centre of a cork fitting the bottle of phosphorus solution, and the fine end should plunge into the fluid and nearly touch the bottom of the bottle. By squeezing the rubber cap before the insertion of the pipette and releasing it after the point is well down, a small quantity of phosphorus rises in the pipette. It is withdrawn and inserted rapidly beneath the tilted end of the cover; the slightest pressure on the cap ejects enough phosphorus to fill the space between the cover and the slide; gently and firmly press it down and ring it with warm glue and honey.

In half an hour points of superfluous phosphorus may have exuded. With a pair of tweezers wet a piece of blotting-paper with bisulphide and absorb these away, plunging the paper at once into water. The slides should now be put aside for a day or two, then they may receive two or three ring-coatings of gold-size, and finally be finished with sealing-wax or shellac varnish.

It often is quite impossible to predicate beforehand what preservative medium will answer best for a particular kind of preparation; and it is consequently desirable, where there is no lack of material, to mount similar objects in two or three different ways, marking on each slide the method employed, and comparing the specimens from time to time, so as to judge the condition of each.

Importance of Cleanliness.—The success of the result of any of the foregoing operations is greatly detracted from if, in consequence of the adhesion of foreign substances to the glasses whereon the

objects are mounted, or to the implements used in the manipulations, any extraneous particles are brought into view with the object itself. Some such will occasionally present themselves, even under careful management; especially fibres of silk, wool, cotton, or linen, from the handkerchiefs, &c., with which the glass slides may have been wiped; fibres of the blotting-paper employed to absorb superfluous fluid; and grains of starch, which often remain obstinately adherent to the thin glass covers kept in it. But a careless and uncleanly manipulator will allow his objects to contract many other impurities than these; and especially to be contaminated by particles of dust floating through the air, the access of which may be readily prevented by proper precautions. It is desirable to have at hand a well-closed cupboard furnished with shelves, or a cabinet of well-fitted drawers, or a number of bell-glasses upon a flat table, for the purpose of securing glasses, objects, &c., from this contamination in the intervals of the work of preparation: and the more readily accessible these receptacles are, the more use will the microscopist be likely to make of them. Great care ought, of course, to be taken that the media employed for mounting should be freed by effectual filtration from all floating particles, and that they should be kept in well-closed bottles.

Labelling and Keeping Mounted Objects.—The object of labels on mounted objects is of course to give clear and instant indication of the nature of the mount. But we must, if our cabinets have anything like scientific pretensions, not only know what the object may be, but some (perhaps many) other particulars about it. In fact, a thoroughly scientific cabinet must not rely on the labels on the mounts for all the information which it is desirable and even essential to have concerning them. One of the desiderata of every label should be the presence of a *number*, and this number should be at once placed in a book, arranged in columns to suit the requirements of the student, and most of the details should be placed in this book in association with the number.

For this to be of permanent service, however, the label on which the number is placed should be as permanent and immovable as the slip itself. We know of cabinets in which *only* numbers are marked on slides, and all details are recorded in 'the book.' We do not advise this; but all who keep cabinets know how in the course of years paper labels become displaced and lost, and in many instances the value of slides is greatly diminished.

What is wanted is a *permanently fixed* label, capable of receiving the chief points of character as well as the name and number of an object.

The present Editor has found the following plan to be hitherto, after twenty-three years' trial, quite faultless.

Let the slips which are to be used for mounting have the two ends of the upper surface finely ground: at one end the ground surface may be three quarters of an inch, and at the other end half an inch. On the ground surface we can write with a hard pencil as clearly and sharply as with a fine pen on cardboard.

On the broader ground surface let the principal facts as to the nature of the object be written and the number of the slide with a

Faber pencil marked H H H H. On the narrower and opposite ground surface should be written what the object is mounted in, how stained, or whence obtained, the date of mounting, &c.

Now when all this is written take *thin* covers, cut respectively $1 \times \frac{3}{4}$ inch and $1 \times \frac{1}{2}$ inch, and by means of benzol balsam, applied with or without heat, the ground surfaces should have these thin glasses put on over the writing and the entire ground surfaces; the result of course will be that the transparency of what was a ground and opaque surface will be wholly restored, and the writing will be clear and ineffaceable. If the bottom of the trays of the cabinets be whitened it will render still more easy the instant reading of the contents of the label.

The grinding of the slips is by no means difficult, and could not be costly if there arose a demand for them.

It is easy, however, to do all that is required. A block of wood to receive the slide in an excavation of its own shape and size, and a piece of wood half an inch thick, of the exact length ($1\frac{3}{4}$ inch) of the space between the labels, enables a lead 'buff' to be freely used with fine emery and the work is speedily done. Of course the finer the emery the finer the surface; and the finer the surface the more delicate the writing may be made. The label may in fact be as ornate and elegant as we please. Nor need we be confined to an oblong shape. Oval or round spaces could be ground on the slips and thin covers of corresponding size could be accordingly used. This method gives a little more trouble and is slightly more expensive, but in elegance and above all in durability we believe it has no equal.

For the preservation of objects, the pasteboard boxes now made at a very reasonable cost, with wooden racks, to contain six, twelve, or twenty-four slides, will be found extremely useful. For the management of a large collection the following has proved itself to be thoroughly practical, and can be universally employed. The species, genus, and character of the slides may be disregarded. Place the slides in the cabinet just as they come, numbering each consecutively. The exterior of *cabinets* should show from what number to what number the cabinet contains: thus, 527 to 842. The porcelain slab on the *drawer* may indicate from what number to what number the drawer contains: thus, 527 to 539. Now a number of notebooks should be procured, so that there may be a separate notebook for each subject; the size of the notebook must be regulated to the importance of the special department the collector has taken up. Thus a diatomist would have probably a thick ledger for his diatom collection, whereas an entomologist would have a thin notebook for his diatoms and a thick ledger for his insects, and so on. The notebooks might be distinguished from one another by a letter of the alphabet.

In the event of a second notebook being required for the same subject or class of objects, it might be identified by doubling the letter: thus, D D. Now a large *index notebook* will be required in which one line is given to each slide. This notebook contains

merely the number of the slide and the letter and page of the special notebook wherein all about the slide will be found. Thus :—
‘649, F 127.’

This means that in notebook F on page 127 we shall find an account of slide No. 649.

On turning to notebook F we find (say) that the subject is geology. The following will be a facsimile of the page :—

Slide No. 649

127

Section of porphyry from Peterhead, Aug. 1886.—The quartz crystals in this section have minute cavities containing a liquid, CO_2 . In each cavity there is a bubble; some of these bubbles are extremely minute, and exhibit rapid Brownian movement. A good example of which is—

No. 2 (referring to a second microscope when used), 46–51.

A large bubble with no Brownian movement.

No. 2 (microscope), 44–47.

Section too thick for oil immersion.

Best seen dry $\frac{1}{4}$.95 N.A. deep eye-piece; condenser aperture .6 N.A.

At the back of each notebook there is an alphabetical index. In this instance if we look up ‘Porphyry’ we shall find 127, and if we look up ‘Quartz (cavities in)’ we shall find 127, and if we look up ‘Carbonic acid (in quartz)’ we shall find 127, and if we look up ‘Bubbles (in quartz)’ we shall find 127.

By this means the collector can find a slide if he know the subject, and also the subject if he have the slide.

This is the only scientific method we know of dealing with a microscopical collection; it is one of the greatest practical mistakes to make the cabinet its own index. It always ends in supreme confusion. But for the purposes of the man of science a large cabinet made with a view to the reception of his own slides is far preferable. The majority of slides are 3×1 inches; but all are not—some geological and mineralogical sections, sections of coal, &c., are often much larger. Many objects, again, are in deeper cells than the ordinary cabinet drawer or slide-box will admit of; all this may be provided for, and if money be not a special object, a design with two or three special and smaller cabinets may be made for the reception of special series of mounts.¹

COLLECTION OF OBJECTS.

A large proportion of the objects with which the microscopist is concerned is derived from the minute parts of those larger organisms, whether vegetable or animal, the collection of which does not require any other methods than those pursued by the ordinary naturalist. With regard to such, therefore, no special directions are required. But there are several most interesting and important groups, both of plants and animals, which are themselves, on account

¹ It will be understood that there are many forms of cabinet which space prevents our describing; they are made suitable for the pocket, for postal transmission, &c., and may be readily seen at the opticians’.

of their minuteness, essentially *microscopic*; and the collection of these requires peculiar methods and implements, which are, however, very simple, the chief element of success lying in the knowledge *where* to look and *what* to look for. In the present place, *general* directions only will be given; the particular details relating to the several groups being reserved for the account to be hereafter given of each.

Of the microscopic organisms in question, those which inhabit fresh water must be sought for in pools, ditches, or streams, through which some of them freely move, whilst others attach themselves to the stems and leaves of aquatic plants, or even to pieces of stick or decaying leaves, &c., that may be floating on the surface or submerged beneath it; while others, again, are to be sought for in the muddy sediments at the bottom. Of those which have the power of free motion, some keep near the surface, whilst others swim in the deeper waters; but the situation of many depends entirely upon the light, since they rise to the surface in sunshine, and subside again afterwards. The collector will therefore require a means of obtaining samples of water at different depths, and of drawing to himself portions of the larger bodies to which the microscopic organisms may be attached. For these purposes nothing is so convenient as the *pound-stick*, which is made in two lengths, one of them sliding within the other, so as when closed to serve as a walking-stick. Into the extremity of this may be fitted, by means of a screw socket, (1) a cutting-hook or curved knife, for bringing up portions of larger plants in order to obtain the minute forms of vegetable or animal life that may be parasitic upon them; (2) a broad collar, with a screw in its interior, into which is fitted one of the screw-topped bottles made by the York Glass Company; (3) a ring or hoop for a muslin ring-net. When the bottle is used for collecting at the surface, it should be moved sideways with its mouth partly below the water; but if it be desired to bring up a sample of the liquid from below, or to draw into the bottle any bodies that may be loosely attached to the submerged plants, the bottle is to be plunged into the water with its mouth downwards, carried into the situation in which it is desired that it should be filled, and then suddenly turned with its mouth upwards. By unscrewing the bottle from the collar, and screwing on its cover, the contents may be securely preserved. The net should be a bag of fine muslin, which may be simply sewn to a ring of stout wire. But it is desirable for many purposes that the muslin should be made removable; and this may be provided for by the substitution of a wooden hoop, grooved on its outside, for the wire ring; the muslin being strained upon it by a ring of vulcanised indiarubber, which lies in the groove, and which may be readily slipped off and on, so as to allow a fresh piece of muslin to be put in the place of that which has been last used. At the end of the muslin bag is tied a small rimmed tube-bottle of thin clear glass three inches long by one inch in diameter. In this, objects can be fairly seen. The collector should also be furnished with a number of bottles, into which he may transfer the samples thus obtained, and none are so convenient as the screw-topped bottles made in all sizes by the York Glass Company. It is well that the bottles should

be fitted into cases, to avoid the risk of breakage. When animalcules are being collected, the bottles should not be above two-thirds filled, so that adequate air-space may be left. Whilst engaged in the search for microscopic objects, it is desirable for the collector to possess a means of at once recognising the forms which he may gather, where this is possible, in order that he may decide whether the 'gathering' is or is not worth preserving; and for this purpose we know of nothing better, unless a small travelling microscope be required, than a couple of Steinheil loupes, magnifying six and ten diameters.

Mr. J. D. Hardy suggests what we have found of great use, viz. a *flat bottle*, as a very valuable piece of apparatus for collecting.¹ It is made by cutting a U-shaped piece out of a flat and solid piece of india-rubber, about 6 inches long by $2\frac{3}{4}$ inches broad, and $\frac{3}{4}$ inch thick: against each side is cemented (by means of Miller's caoutchouc cement) a piece of good thin plate-glass, and the bottle is complete. A small portion cut from the inner piece makes a naturally fitting cork. One or two more, and smaller, bottles can be made with the remaining india-rubber. It is essential that the material should be at least $\frac{3}{4}$ inch thick in order to make a wide bottle, and allow pond-weeds to be put inside without difficulty and pressure. A flat bottle is made by Mr. Stanley, London Bridge, which we have good reason to write favourably of. It is ground on its outer surfaces, and internal irregularities almost wholly disappear when filled with water: an objective from 3 inches to $1\frac{1}{2}$ inch may be well employed with it.

Even with the best ordinary round-dipping bottles it is very difficult to see minute animals clearly, whilst with this flat bottle one can see at a glance almost everything the dip contains, and every object can be examined with the pocket lens with ease.

For collecting purposes the objects sought in pond or stream are divisible into free-swimming, and attached or fixed to water-plants, &c.

The free-swimming are to be secured with the net, the bottle attached to which should be examined after each sweep of the net; and the flat bottle may be also filled for examination. The mud at the bottom of the pond must not be stirred by the net, since of course it obscures the objects.

The infusoria, rotifera, &c., are best found with the flat bottle. Collect a lot of the 'weeds' growing in pond or stream, and place these in the bottle; then, Mr. Rousselet says: 'The tree-like colonies of Vorticelle; Epistylis, Zoöthamnium, and Carchesium, the trumpet-shaped Stentors, the crown Rotifer Stephanoceros, the tubes of Melicerta, Lymnias, the various Polyzoa, also Hydra, and many more, can at once be seen with the naked eye, when present, and in this way the good branches can be selected. Some creatures, however, such as the beautiful floscules, cannot be seen easily, even with the lens, not so much on account of their small size, as of the perfect transparency of their bodies. Experience will soon teach one how to see which branches are likely to prove prolific. As a general rule, old-looking but still sound and green branches will be the best. The Water Milfoil (*Myriophyllum*) is decidedly the best of water plants to examine and collect, on account

¹ *Q.M. Journ.*, ser. ii. vol. ii. p. 55.

of the ease with which its leaves can subsequently be placed under the microscope. Anacharis is much more difficult of manipulation, and I mostly only take it now to aerate my aquaria.

‘In placing a weed in the flat bottle, do not put in more than one branch at a time, otherwise the branches will only obscure each other and render examination more difficult.

‘When searching for Polyzoa, such as Lophopus, Plumatella, Fredericella, it is advisable to examine the rootlets of trees growing at the edge of the water, and also to drag up weeds from the middle of the pond or canal by means of a loaded hook and line.

‘A good collection thus made is transferred to small aquaria 6 to 8 inches high, 5 to 6 inches long, and 1 to 1½ inch wide; these we have used for at least ten years and can attest their great value in making the best possible use of a good day’s collecting, and studying in the most intelligent way the objects collected.

‘Rotifers can generally be kept a week or a fortnight, some species much longer; their lives, as well as those of Polyzoa, can be prolonged by feeding them about twice daily with a green soup made by crushing some anacharis, or other green weed, in a small mortar in a little water, which is then filtered through muslin. They can be seen to feed on this under the microscope, their tiny stomachs soon becoming filled with little balls of chlorophyll.

‘Under favourable conditions Melicerta, Stephanoceros, the Floscules, and also Asplanchna, and other forms, breed and multiply in the aquarium, and can then be preserved for a considerable time. A little mud taken from a pond in winter or early spring, and put in a tank at home, will often produce an unexpected number and variety of rotifers and infusoria, which are hatched from winter eggs and dormant germs.’¹

There must of course be a balance in every tank between the animal and vegetable life, or aeration must be artificially maintained. So also food must be obtainable by the organisms, however small. But experience alone is the perfect teacher in this matter.

The same general method is to be followed in the collection of such *marine* forms of vegetable and animal life as inhabit the neighbourhood of the shore, and can be reached by the pond-stick. But there are many which need to be brought up from the bottom by means of the *dredge*, and many others which swim freely through the waters of the ocean, and are only to be captured by the *tow-net*. As the former is part of the ordinary equipment of every marine naturalist, whether he concern himself with the microscope or not, the mode of using it need not be here described; but the use of the latter for the purposes of the microscopist requires special management. The net should be of fine muslin, firmly sewn to a ring of strong wire about ten or twelve inches in diameter. This may be either fastened by a pair of strings to the stern of a boat, so as to tow *behind* it, or it may be fixed to a stick so held in the hand as to project from the *side* of the boat. In either case the net should be taken in from time to time, and held up to allow the

¹ ‘On some Methods of Collecting and Keeping Pond Life for the Microscope,’ from the *Trans. Middlesex Nat. Hist. Soc.*

water it contains to drain through it; and should then be turned inside out and moved about in a bucket of water carried in the boat, so that any minute organisms adhering to it may be washed off before it is again immersed. It is by this simple method that marine *animalcules*, the living forms of *Radiolaria*, the smaller *Medusoids* (with their allies *Beroe* and *Cydlippe*), *Noctiluca*, the free-swimming larvæ of *Echinodermata*, some of the most curious of the *Tunicata*, the larvæ of *Mollusca*, *Turbellaria*, and *Annelida*, some curious adult forms of these classes, *Entomostraca*, and the larvæ of higher *Crustacea*, are obtained by the naturalist; and the great increase in our knowledge of these forms which has been gained within recent years is mainly due to the assiduous use which has been made of it by qualified observers. It is important to bear in mind that, for the collection of all the more delicate of the organisms just named (such, for instance, as *echinoderm larvæ*), it is essential that the boat should be rowed so slowly that the net may move *gently* through the water, so as to avoid crushing its soft contents against its sides. Those of firmer structure (such as the *Entomostraca*), on the other hand, may be obtained by the use of a tow-net attached to the stern of a sailing-vessel, or even of a steamer, in much more rapid motion.¹ When this method is employed, it will be found advantageous to make the net of conical form, and to attach to its deepest part a wide-mouthed bottle, which may be prevented from sinking too deeply by suspending it from a cork float; into this bottle many of the minute animals caught by the net will be carried by the current produced by the motion of the vessel through the water, and they will be thus removed from liability to injury. It will also be useful to attach to the ring an inner net, the cone of which, more obtuse than that of the outer, is cut off at some little distance from the apex; this serves as a kind of valve, to prevent objects once caught from being washed out again. The net is to be drawn in from time to time, and the bottle to be thrust up through the hole in the inner cone; and its contents being transferred to a screw-capped bottle for examination, the net may be again immersed. This form of net, however, is less suitable for the most delicate objects than the simple *stick-net* used in the manner just described. The microscopist on a visit to the seaside, who prefers a quiet row in tranquil waters to the trouble (and occasional *malaise*) of dredging, will find in the collection of floating animals by the careful use of the stick-net or tow-net a never-ending source of interesting occupation.

¹ In the *Challenger* Expedition tow-nets were almost constantly kept in use, not only at the surface, but at various depths beneath it, being attached to a line which was made to hang vertically in the water by the attachment of heavy weights at its extremity. The collections thus made showed the enormous amount of minute animal life pervading the upper waters of the ocean.

CHAPTER VIII

MICROSCOPIC FORMS OF VEGETABLE LIFE—THALLOPHYTES

THOSE who desire to make themselves familiar with microscopic appearances, and to acquire dexterity in microscopic manipulation, cannot do better than educate themselves for more difficult inquiries by the study of those humblest types of vegetation which present organic structure under its most elementary aspect. And such a desire to search out the nature and conditions of living action will find in the study of its simplest manifestations the best clue to the analysis of those intricate and diversified combinations under which it presents itself in the highest animal organisms. For it has now been put beyond question that the fundamental phenomena of life are identical in plants and in animals, and that the living substance which exhibits them is of a nature essentially the same throughout both kingdoms. The determination of this general fact, which forms the basis of the science of BIOLOGY, is the most important result of modern microscopic inquiry; and the illustration of it will be kept constantly in view in the exposition now to be given of the chief applications of the microscope to the study of those minute *proto-phytes* (or simplest forms of plant-life) with whose form and structure, and with whose very existence in many cases, we can only acquaint ourselves by its aid.

It was formerly supposed that *living action* could only be exhibited by *organised structure*. But we now know that all the essential functions of life may be carried on by minute 'jelly-specks,' in whose apparently homogeneous semi-fluid substance nothing like 'organisation' can be detected; and, further, that even in the very highest organisms, which present us with the greatest variety of 'differentiated' structures, the essential part of the life-work is done by the same material—these structures merely furnishing the mechanism (so to speak) through which its wonderful properties exert themselves. Hence this substance,¹ known in vegetable physiology as *protoplasm*, but often referred to by zoologists as

¹ Attention was drawn in 1835 by Dujardin (the French zoologist to whom we owe the transfer of the *Foraminifera* from the highest to the lowest place among invertebrate animals) to the fact that the bodies of some of the lowest members of the animal kingdom consist of a structureless, semi-fluid, contractile substance, to which he gave the name *sarcodæ* (rudimentary flesh). In 1851 the eminent botanist Von Mohl showed that a similar substance forms the essential constituent of the cells of plants, and termed it *protoplasm* (primitive plastic or organisable material). And in 1863 it was pointed out by Prof. Max Schultze, who had made a special study of the rhizopod group, that the 'sarcodæ' of animals and the 'protoplasm' of plants are *identical*. See his memoir *Ueber das Protoplasma der Rhizopoden und Pflanzenzellen*.

sarcode, has been appropriately designated by Professor Huxley 'the physical basis of life.' In its typical state (such as it presents among *rhizopods*) it is a semi-fluid, tenacious, glairy substance, resembling—alike in aspect and in composition—the *albumen* (or uncoagulated 'white') of an unboiled egg. But it is fundamentally distinguished from that or any other form of dead matter by two attributes, which (as being peculiar to living substances) are designated *vital*: (1) its power of increase, by *assimilating* (that is, converting into the likeness of itself, and endowing with its own properties) nutrient material obtained from without: (2) its power of *spontaneous movement*, which shows itself in an extraordinary variety of actions, sometimes slow and progressive, sometimes rapid, sometimes wave-like and continuous, and sometimes rhythmical with regular intervals of rest. When examined under a sufficiently high magnifying power, multitudes of minute granules are usually seen to be diffused through it, which have been termed 'microsomes.' Protoplasm, whether living or dead, has a great power of absorbing water; but the distinction between these two states is singularly marked by its behaviour in regard to any colouring matter which the water may contain. Thus, if living protoplasm be treated with a solution of carmine, it will remain unstained so long as it retains its vitality. But if the protoplasm be dead, the carmine will at once pervade its whole substance, and stain it throughout with a colour even more intense than that of the solution; thus furnishing (as was first pointed out by Dr. Beale) a ready means of distinguishing the 'germinal matter,' or protoplasmic component of the tissues of higher animals, from the 'formed material' which is the most conspicuous part of their structure.

All those minute and simple forms of life with which the microscope brings us into acquaintance consist essentially of particles of protoplasm, each kind having usually a tolerably definite size and shape, and showing (at least in some stage of its existence) something distinctive in its habit of life. And it is rather according to the manner in which they respectively live, grow, and multiply, than on account of any structural peculiarities, that they are assigned to the vegetable or to the animal kingdom respectively. It is impossible, in the present state of our knowledge, to lay down any definite line of demarcation between the two kingdoms; since there is no single character by which the animal or vegetable nature of any organism can be tested. Probably the one which is most generally applicable among those that most closely approximate to one another is not, as formerly supposed, the presence or absence of spontaneous motion, but, on the one hand, the dependence of the organism for nutriment upon *organic compounds already formed* which it takes (in some way or other) into the interior of its body, or, on the other, its possession of the power of *producing the organic compounds* which it applies to the increase of its fabric, at the expense of the *inorganic elements* with which it is supplied by air and water. The former, though perhaps not an *absolute*, is a *general* characteristic of the *animal* kingdom; the latter, but for the existence of which animal life would be impossible, is certainly the

prominent attribute of the *vegetable*. We shall find that the *protozoa* (or simplest animals) are supported as exclusively either upon other *protozoa* or upon *protophytes*, as are the highest animals upon the flesh of other animals or upon the products of the vegetable kingdom; whilst many *protophytes*, in common with the highest plants, draw *their* nourishment from the atmosphere or the water in which they live, and, like them, are distinguished by their power of decomposing carbonic acid (CO_2) under the influence of light—setting free its oxygen, and combining its carbon with the elements of water to form the carbohydrates (starch, cellulose, &c.), and with those of atmospheric ammonia to form nitrogenous (albuminoid) compounds. And we shall find, moreover, that even such *protozoa* as have neither stomach nor mouth receive their alimentary matter direct into the very substance of their bodies, in which it undergoes a kind of digestion; whilst *protophytes* absorb through their external surface only, and take in no solid particles of any description. With regard to *motion*, which was formerly considered the distinctive attribute of animality, we now know, not merely that many *protophytes* (perhaps all, at some period or other of their lives) possess a power of spontaneous movement, but also that the instruments of motion (when these can be discovered) are of the very same character in the plant as in the animal, being little hair-like filaments, termed *cilia* (from the Latin word *cilium*, an eyelash), or longer whip-like *flagella*, by whose rhythmical vibrations the body of which they form part is propelled in definite directions. The peculiar contractility of these organs seems to be an intensification of that of the general protoplasmic substance, of which they are special extensions.

There are certain plants, however, which resemble animals in their dependence upon organic compounds prepared by other organisms, being themselves unable to effect that fixation of carbon by the decomposition of the CO_2 of the atmosphere, which is the first stage in their production. Such is the case, among *phanerogams* (flowering plants), with the leafless 'parasites' which draw their support from the tissues of their 'hosts.' And it is the case also, among the lower *cryptogams*, with the entire group of FUNGI; which, however, in a large number of cases, depend rather for their nutritive materials upon organic matter in a state of decomposition, many of them having the power of promoting that process by their *zymotic* (fermentative) action. Among animals, again, there are several in whose tissues are found organic compounds, such as chlorophyll, starch, and cellulose, which are characteristically vegetable; but it has not yet been proved that they *generate* these compounds for themselves by the decomposition of CO_2 .

The plan of organisation recognisable throughout the vegetable kingdom presents this remarkable feature of uniformity, that the fabric, alike in the highest and most complicated plants and in the lowest and simplest forms of vegetation, consists of nothing else than an aggregation of the bodies termed *cells*, every one of which (save in the forms that lie near the border-ground between animal and vegetable life) has its little particle of protoplasm enclosed by a

easing of the substance termed *cellulose*—a non-nitrogenous substance identical in chemical composition with starch. The entire mass of cells of which any vegetable organism is composed has been generated from one ancestral cell by processes of multiplication to be presently described; and the difference between the fabrics of the lowest and of the highest plants essentially consists in this, that whilst the cells produced by the repeated multiplication of the ancestral cell of the protophyte are all mere repetitions of it and of one another each living *by* and *for* itself, those produced by the like multiplication of the ancestral cell in the oak or palm not only remain in mutual connection, but go through a progressive ‘differentiation,’ the ordinary type of the cell undergoing various modifications to be described in their proper place. A composite structure is thus developed, which is made up of a number of distinct ‘organs’ (stem, leaves, roots, flowers, &c.), each of them characterised by specialities not merely of external form, but of internal structure; and each performing actions peculiar to itself, which contribute to the life of the plant *as a whole*. Hence, as was first definitely stated by Schleiden, it is in the *life-history of the individual cell* that we find the true basis of the study of vegetable life in general.

We have now to consider in more detail the structure and life-history of the typical plant-cell, and shall begin by treating of the *cell-wall*. This cell-wall is composed, as long as the cell is in a living state, chiefly of the substance known as *cellulose*, one of the group of compounds called ‘carbohydrates,’ and bearing the definite chemical composition $C_6H_{10}O_5$. From a physical point of view it consists of particles or *micelle* of cellulose surrounded by water. In addition to cellulose, recent observations have shown that *pectic* substances enter largely into the composition of the wall of the living cell, especially in its early stages. In fungi it is doubtful whether there is any true cellulose in the cell-walls. With regard to the mode of growth of the cell-wall, two hypotheses have been proposed: one, that it is formed by *apposition*, that is, by the constant addition of fresh layers to the inner surface of the cell-wall; the other that it increases by *intussusception*, or the intercalation of fresh particles of cellulose between those already in existence. The results of modern researches tend in the direction of the former being the more usual process; but it is probable that the two co-operate in producing the total growth of the cell-wall.

The *contents* of the plant-cell, which may be collectively termed the *endoplasm* (answering to the ‘endosarc’ of rhizopods), or, when strongly coloured throughout (as in many *algæ*), the *entochrome*, consist in the first place of an outer layer of protoplasmic substance called the *ectoplasm*, *primordial utricle*, or *parietal utricle*. This is an extremely thin and delicate layer, so that it escapes attention so long as it remains in contact with the cell-wall; and it is only brought into view when separated from this, either by developmental changes (fig. 415), or by the influence of reagents which cause it to contract by drawing forth part of its contents (fig. 413, C). It is not sharply defined on its internal face, but passes gradually into the inner mass of protoplasm, from which it is chiefly distinguishable by

the absence of granules; and it is shown by the effects of reagents to have the *albuminous* composition of protoplasm. It may thus be regarded as the slightly condensed external film of the protoplasmic layer with which the inner surface of the cell-wall is in contact; and it essentially corresponds to the 'ectosarc' of *Amoeba* or any other rhizopod. The 'ectoplasm' and 'cellulose wall' can be readily distinguished from each other by chemical tests, and also by the action of carmine, which stains the protoplasmic substance (when dead) without affecting the cellulose wall. The further contents of the cell consist of a watery fluid called *cell sap*, which holds in solution sugar, vegetable acids, saline matters, &c.; the peculiar body termed the *nucleus*; and chlorophyll corpuscles (enclosing starch granules), oil particles, &c. In the young state of the cell the whole cavity is occupied by the protoplasmic substance, which is, however, viscid and granular near the cell-wall, but more watery towards the interior. With the enlargement of the cell and the imbibition of water, clear spaces termed *vacuoles*, filled with watery cell-sap, are seen in the protoplasmic substance; and these progressively increase in size and number, until they come to occupy a considerable portion of the cavity, the protoplasm stretching across it as an irregular network of bands. Each of the vacuoles is enclosed in a very delicate contractile membrane, the *tonoplast*. When, as usually happens, the nucleus lies imbedded in the outer protoplasmic layer, these bands are gradually withdrawn into it, so that the separate vacuoles unite into one large general vacuole which is filled with watery cell-sap. But where the nucleus is situated nearer to the centre of the cell, part of the protoplasm collects around it, and bands or threads of protoplasm stretch thence to various parts of the parietal layer. It is by the contractility of the protoplasmic layer that the curious 'cyclosis' hereafter to be described is carried on within the plant-cell, which is the most interesting to the microscopist of all its manifestations of vital activity. The *nucleus* is a small body, usually of lenticular or subglobose form (fig. 413, A. a), and of albuminous composition, that lies imbedded in protoplasmic substance, either close to the cell-wall or nearer the centre of the cavity. Cells containing a number of nuclei, or '*multinucleated cells*,' are not uncommon. They occur, for example, in many algae, in the 'suspensor' and 'embryo-sac' of the ovule of phanerogams, and in the 'laticiferous' tubes. Within the nucleus are often seen one or more small distinct particles termed *nucleoli* (fig. 413, A. b), which can be best distinguished by the strong coloration they receive from a twenty-four hours' immersion in carmine, and subsequent washing in water slightly acidulated with acetic acid. Though in some points the precise function of the nucleus is still unknown, there can be no doubt of its essential relation to the vital activity of the cell, at least in all the higher plants, although in the cells of some of the lower cryptogams it has not at present been distinguished with certainty at any stage of their existence. In the nucleated cells which exhibit 'cyclosis,' it may be observed that if the nucleus remains attached to the cell-wall, it constitutes a centre from which the protoplasmic streams diverge, and to which they return; whilst if

it retains its freedom to wander about, the course of the streams alters in conformity with its position. But it is in the multiplication of cells by binary subdivision, which will be presently described, that the speciality of the nucleus as *the centre of the vital activity of the cell* is most strongly manifested. The *chlorophyll corpuscles*, which are limited to the cells of the parts of plants acted on by light, are specialised particles of protoplasm through which a green colouring matter is diffused; and it is by them that the work of decomposing CO_2 , and of 'fixing' its carbon by union with the oxygen and hydrogen of water into *starch*, is effected. The characteristic green of chlorophyll often gives place to other colours, which seem to be produced from it by chemical action. *Starch grains* are always formed in the first instance in the interior of the chlorophyll corpuscles and gradually increase in size until they take the places of the corpuscles that produced them. So long as they continue to grow, they are always imbedded in the protoplasm of the cell; and it is only when fully formed that they lie free within its cavity.

But although these component parts may be made out without any difficulty in a large proportion of vegetable cells, yet they cannot be distinguished in some of those humble organisms which are nearest to the border-line between the two kingdoms. For in them we find the 'cell-wall' very imperfectly differentiated from the 'cell-contents;' the former not having by any means the firmness of a perfect membrane, and the latter not possessing the liquidity which elsewhere characterises them. And in some instances the cell is represented only by a mass of endoplasm, so viscid as to retain its external form without any limiting membrane, though the superficial layer seems to have a firmer consistence than the interior substances; and this may or may not be surrounded by a gelatinous-looking envelope, which is equally far from possessing a membranous firmness, and yet is the only representative of the cellulose wall. This viscid endoplasm consists, as elsewhere, of a colourless protoplasm, through which minute colouring particles may be diffused, sometimes uniformly, sometimes in local aggregations, leaving parts of the protoplasm uncoloured. The superficial layer in particular is frequently destitute of colour; and the partial solidification of its surface gives it the character of an 'ectoplasm.' Such individualised masses of protoplasm, destitute of a true cell-wall, have sometimes been termed 'primordial cells.' It is an extremely curious feature in the cell-life of certain protophytes that they not only move like animalcules by cilia or flagella, but that they exhibit the rhythmically contracting vacuoles which are specially characteristic of *protozoic* organisms.

So far as we yet know, every vegetable cell derives its existence from a pre-existing cell; and this derivation may take place (in the ordinary process of growth and extension, as distinguished from 'sexual multiplication') in one of two modes: either (1) *binary subdivision* of the parent-cell, or (2) *free-cell formation* within the parent-cell. The first stage of the former process consists in the elongation and transverse constriction of the nucleus; and this constriction becomes deeper and deeper, until the nucleus divides itself

into two halves (fig. 413, B, *a*, *a'*). These then separating from each other, the endoplasm of the parent-cell collects round the two new centres, so as to divide itself into two distinct masses (C, *a*, *a'*): and by the investment of these two secondary 'endoplasms' with cellulose-walls a complete pair of new cells (D, *a*, *a'*) is formed within the cavity of the parent-cell. The process of *free-cell formation* is always connected, directly or indirectly, with a process of reproduction rather than of growth, and takes two different forms, the one occurring in the production of the 'zoospores' or 'swarm-spores' of algae, the other in the formation of pollen-grains, or of

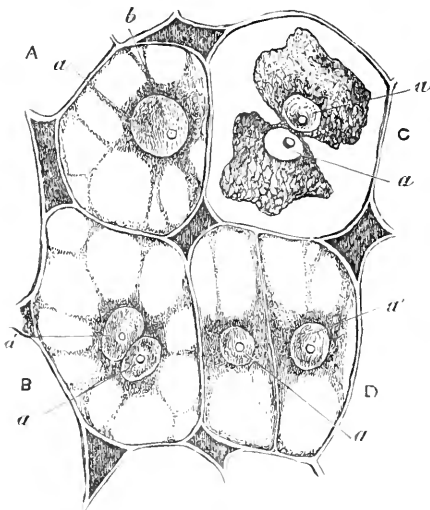

FIG. 413.—Binary subdivision of cells in endosperm of seed of scarlet-runner: A, ordinary cell, with nucleus *a*, and nucleolus *b*, imbedded in its protoplasm; B, cell showing subdivision of nucleus into two halves, *a* and *a'*; C, cell in same stage, showing contraction of endoplasm (produced by addition of water) into two separate masses round the two segments of original nucleus; D, two complete cells within mother-cell, divided by a partition.

the 'endosperm' within the embryo-sac of flowering plants. In the former case, the endosperm, instead of dividing itself into two halves, usually breaks up into numerous segments corresponding with one another in size and form, each of which, escaping from the parent-cavity, becomes an independent cell, without any investing cell-wall of cellulose, hence a 'primordial cell,' endowed with a power of rapid motion by means of cilia or flagella. In the second case the endoplasm groups itself, more or less completely, round several centres, each of which has its own nucleus, formed by subdivision of the parent-cell: and these secondary cells, in various stages of development, lie free within the cavity of the parent-cell, imbedded in its residual

endoplasm, each proceeding to complete itself as a cell by the formation of a limiting wall of cellulose (fig. 414). As a 'new generation' in any *phanerogamic* plant has its origin in the fertilisation of a highly specialised 'germ-cell' (contained within the ovule) by the contents of a 'sperm-cell' (the pollen-grain), so do we find, among all save the lowest *cryptogams*, a provision for the union of the contents of two highly specialised cells, the 'germ-cells' being fertilised by the access of motile protoplasmic bodies (antherozoids), set free from the cavities of the 'sperm-cells' within which they were developed. But although the sexual process can be traced downwards under this form into

the group of thallophytes, we find among the lower types of that group a yet simpler mode of bringing it about; for there is strong reason to regard the act of 'conjugation' which takes place in the Conjugata and in some fungi in the same light, and to look upon the 'zygospore,'¹ which is its immediate product, as the originator (like the fertilised embryo-cell of the phanerogamic seed) of a 'new generation.'

Great attention has recently been paid by Strasburger and others to the constitution of the endoplasm and to the processes connected with cell-division. On both these subjects it is impossible here to give more than the barest outlines. Strasburger distinguishes between the following differentiated parts of the protoplasm of the living cell:—The protoplasm outside the nucleus he terms the

cytoplasm; the portion which constitutes the nucleus is the *nucleoplasm*; that which enters into the composition of the chlorophyll corpuscles and other allied substances is the *chromatoplasm*. Each of these three portions of protoplasm is composed of a hyaline matrix or *hyaloplasm* and of imbedded granular structures or *microsomes*. A distinct substance, known as *nuclein*, absent from the cytoplasm, appears to enter into the composition of the nucleus. The various substances imbedded in the cytoplasm are known under the general name of *plastids*. If colourless, they are *leucoplasts*, and

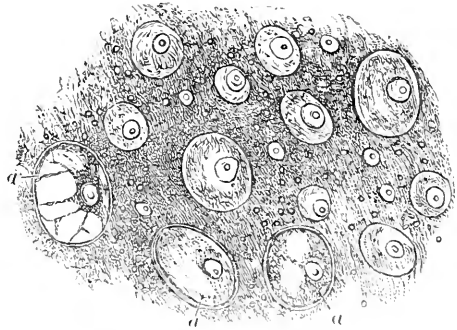

FIG. 414.—Successive stages of free-cell formation in embryo-sac of seed of scarlet-runner; a, a, a, completed cells, each having its proper cell-wall, nucleus, and endoplasm, lying in a protoplasmic mass, through which are dispersed nuclei and cells in various stages of development.

¹ The term 'spore' has been long used by cryptogamists to designate the minute reproductive particles (such as those set free from the 'fructification' of ferns, mosses, &c.) which were supposed—in the absence of all knowledge of their sexual relations—to be the equivalents of the seeds of flowering plants. But it is now known that such 'spores' have (so to speak) very different values in different cases, being, in by far the larger proportion of cryptogams, but the remote descendants of the fertilised cell which is the immediate product of the sexual act under any of its forms. This cell, which will be distinguished throughout the present treatise as the *oosphere*, is the real representative of the 'germinal cell' of the 'embryo' developed within the seed of the flowering plant. On the other hand, the various kinds of *non-sexual* spores emitted by cryptogams, which have received a great variety of designations, are all to be regarded (as will be presently explained) as equivalents of the *leaf-buds* of flowering plants.

[The different interpretations placed upon the term 'spore' and its derivatives by different writers on cryptogamic botany present a great difficulty to the student. A different terminology for the one followed here is now employed by some of the best authorities; but, in order to avoid the great alteration in the use of terms which would otherwise be necessary, it has been thought best, in the present edition, to retain Dr. Carpenter's terminology, at all events until a greater agreement has been arrived at than is at present the case. —ED.]

these are the special seat of the formation of the starch grains. If coloured they are *chromoplasts* or *chromatophores*, the origin of the various colouring matters of the cell; those which give birth to the chlorophyll corpuscles being distinguished by the special term *chloroplasts*. Minute bodies termed *physodes*, endowed with an amœboid motion, have been observed within the protoplasm filaments. In some of the lower plants, at present exclusively in the green algae, there are found within the chlorophyll corpuscles homogeneous proteid substances known as *pyrenoids*; they are often surrounded by starch grains.

The division of the nucleus may take place either directly, when the process is known as *fragmentation*, or indirectly, when it is known as *mitosis* or *karyokinesis* (see fig. 415). In the process of indirect division, the protoplasm of which the nucleus is composed undergoes a great variety of changes, in the course of which it assumes the beautiful appearance known as the *nuclear spindle*, consisting of an equatorial disc, the *nuclear plate*, and delicate *spindle fibres* which converge towards the two poles of the spindle. Apparently connected with the process of cell-division are the peculiar bodies known as *centrospheres*, *directing spheres*, or *attracting spheres*, corresponding to similar bodies found in animal cells, but at present detected only in the lower forms of vegetable life. They form two small homogeneous spheres lying near the nucleus, one on each side of it, and imbedded in the cytoplasm. Each centrosphere has in its centre a body termed the *centrosome*, composed of one or more small granules. To follow out all the processes of karyokinesis requires very high magnifying powers of the microscope, great skill in manipulation, and the use of very delicate staining reagents.

The older conception of the vegetable cell regarded it as a completely closed vesicle, the endoplasm of which is entirely shut off from contact with that of the adjacent cells. Recent observations require the modification of this conception. It has been shown that in many cases the cell-wall is perforated by very minute orifices, through which excessively fine strings of protoplasm pass from one cell-cavity to another (fig. 416). This *continuity of protoplasm* has been observed in some seaweeds and other algae, in the endosperm of the ovule, in the pulvinus or motile organ of the leaves of the sensitive plant, and in many other instances, and is regarded by some authorities as probably a universal phenomenon in living cells. In the case of the sensitive plant it is undoubtedly connected with the remarkable phenomenon of sensitiveness or irritability displayed by the leaves.

In the lowest forms of vegetation every single cell is not only capable of living in a state of isolation from the rest, but even normally does so; and thus the plant may be said to be *unicellular*, every cell having an independent 'individuality.' There are others, again, in which amorphous masses are made up by the aggregation of cells, which, though quite capable of living independently, remain attached to each other by the mutual fusion (so to speak) of their gelatinous investments; and there are others, moreover, in which a definite adhesion exists between the cells, and in which regular

plant-like structures are thus formed, notwithstanding that every cell is but a repetition of every other, and is capable of living independently if detached, so as still to answer to the designation of a 'unicellular' or single-celled plant. These different conditions we shall find to arise out of the mode in which each particular species multiplies by binary subdivision; for where the cells of the new pair that is produced by division of the previous cell undergo a *complete* separation from one another, they will henceforth live indepen-

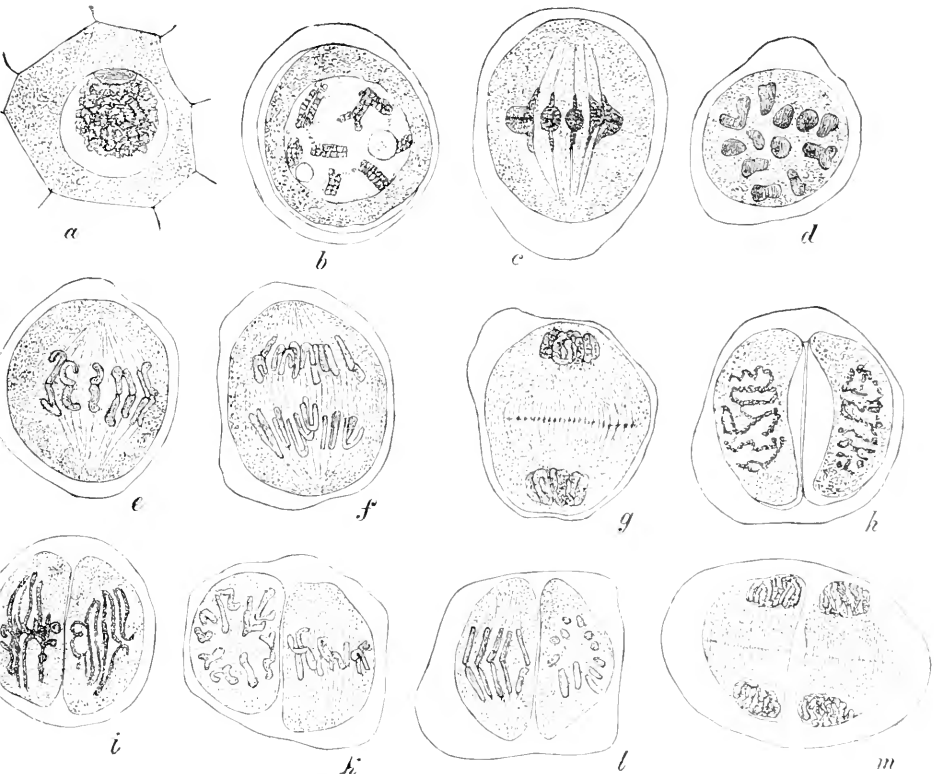

FIG. 415.—Division of the pollen-mother-cells of *Fritillaria persica*. (From Strasburger and Hillhouse's 'Practical Botany,' published by Sommenschein.)

dently; but if, instead of undergoing this complete fission, they are held together by the intervening gelatinous envelope, a shapeless mass results from repeated subdivisions not taking place on any determinate plan; and if, moreover, the binary subdivision always takes place in one direction only, a long, narrow filament (fig. 424. D), or if in two directions only, a broad, flat, leaf-like expansion (G), may be generated. To such extended fabrics the term 'unicellular' plants can scarcely be applied with propriety; since they may be built up of many thousands or millions of distinct cells, which have

no disposition to separate from each other spontaneously. Still they correspond with those which are strictly unicellular, as to the *absence of differentiation*, either in structure or in function, between their component cells, each one of these being a repetition of the rest, and no relation of mutual dependence existing among them; and all such simple organisms, therefore, may still be included under the general term of **Thallophytes**.

Excluding *lichens*, for the reasons to be stated hereafter, botanists now rank these thallophytes under two series:—*algæ*, which form chlorophyll, and can support themselves upon air, water, and mineral matters; and *fungi*, which, not forming chlorophyll for themselves, depend for their nutriment upon materials drawn from other organisms. Each series contains a very large variety of forms, which, when traced from below upwards, present gradually increasing com-

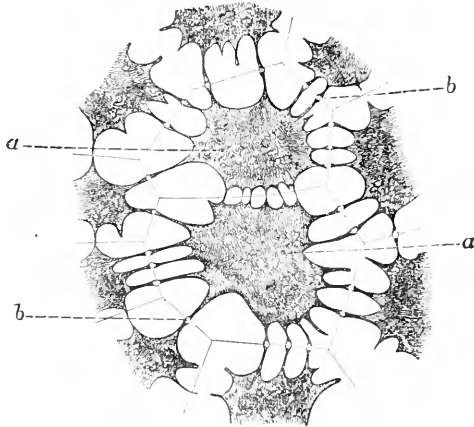

FIG. 416.—Continuity of protoplasm. (From Vines's 'Physiology of Plants.' Cambridge University Press.)

plexities of structure: and these gradations show themselves especially in the provisions made for the generative process. Thus, in some forms, a 'zygospore' is produced by the fusion of the contents of two cells, which neither present any apparent sexual difference the one from the other, nor can be distinguished in any way from the rest. In the next highest forms, while the 'conjugating' cells are still apparently undifferentiated from

the rest of the structure, a sexual difference shows itself between them; the contents of one cell (male) passing over into the cavity of the other (female), within which the 'zygospore' is formed. The next stage in the ascent is the resolution of the contents of the male cell into motile bodies ('antherozoids'), which, escaping from it, move freely through the water, and find their way to the female cell, whose contents, fertilised by coalescence with the material they bring, form an 'oospore.' In the lower forms of this stage, again, the generative cells are not distinguishable from the rest until the contents begin to show their characteristically sexual aspect; but in the higher they are developed in special organs, constituting a true 'fructification.' This must, however, be distinguished from organs which, though commonly spoken of as the 'fructification,' have no real analogy with the generative apparatus of flowering plants, their function being merely to give origin to

*gonidial*¹ cells or groups of cells, which simply *multiply* the parent stock, in the same manner that many flowering plants (such as the potato) can be propagated by the artificial separation of their leaf-buds. It frequently happens among cryptogams that this *gonidial* fructification is by far the more conspicuous, the *sexual* fructification being often so obscure that it cannot be detected without great difficulty; and we shall presently see that there are some thallophytes in which the production of *gonids* seems to go on indefinitely, no form of sexual generation having been detected in them. These general statements will now be illustrated by sketches of the life-history of some of those humble thallophytes which present the phenomena of cell-division, conjugation, and

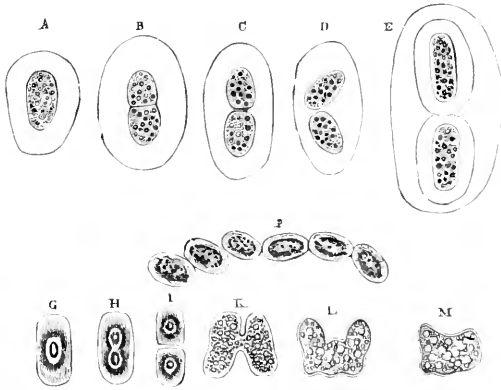

FIG. 417.—Development of *Palmoglaea macrococca*.

gonidial multiplication, under their simplest and most instructive aspect.

The first of these lowly forms of life to which we call the attention of the reader is *Palmoglaea macrococca*, Ktz.,² one of those humble kinds of vegetation which spread themselves as green slime over damp stones, walls, &c. When this slime is examined with the microscope, it is found to consist of a multitude of green cells (fig. 417. A), each surrounded by a gelatinous envelope; the cell, which does not seem to have any distinct membranous wall, is filled with a granular 'endochrome,' consisting of green particles diffused through colourless protoplasm; and in the midst of this a nucleus

¹ The term *gonids*, originally applied to certain green cells in the lichen-crusts that are capable, when detached, of reproducing the vegetable portion of the plant, is used by some writers as a designation of the *non-sexual spores* of cryptogams generally, which it is very important to discriminate from the genitive 'oospheres.' If possessed of *motile* powers, they are spoken of as 'zoospores,' or sometimes (on account of the appearance they present when a number are set free at once) as 'swarm-spores.' In contradistinction to 'motile' gonids or 'zoospores,' those which show no movement are often termed *resting spores*, or *lypsospores*; but such may be either sexual *oospheres* or non-sexual *gonids*, the latter, like the former, often 'encysting' themselves in a firm envelope, and then remaining dormant for long periods of time.

² [Most of the species of Kützing's genus *Palmoglaea* are now regarded as belonging to the *Desmidiaceæ*, and are included under the genus *Mesotenum*.—Ed.]

may sometimes be distinguished, and can always be brought into view by tincture of iodine, which turns the 'endochrome' to a brownish hue, and makes the nucleus (G) dark brown. Other cells are seen (B), which are considerably elongated, some of them beginning to present a sort of hour glass contraction across the middle; and when cells in this condition are treated with tincture of iodine, the nucleus is seen to be undergoing the like elongation and constriction (H). A more advanced state of the process of subdivision is seen at C, in which the constriction has proceeded to the extent of completely cutting off the two halves of the cell, as well as of the nucleus (I), from each other, though they still remain in mutual contact; in a yet later stage they are found detached from each other (D), though still included within the same gelatinous envelope. Each new cell then begins to secrete its own gelatinous envelope, so that by its intervention the two are usually soon separated from each other (E). Sometimes, however, this is not the case, the process of subdivision being quickly repeated before there is time for the production of the gelatinous envelope, so that a series of cells (F) hanging on one to another is produced. There appears to be no definite limit to this kind of multiplication, and extensive areas may be quickly covered, in circumstances favourable to the growth of the plant, by the products of the binary subdivision of one original cell. This, as already shown, is really an act of *growth*, which continues indefinitely so long as moisture is abundant and the temperature low. But under the influence of heat and dryness the process of cell-multiplication gives place to that of 'conjugation,' in which two cells, apparently similar in all respects, fuse together for the production of a 'zygospore,' which (like the seed of a flowering plant) can endure being reduced to a quiescent state for an unlimited time, and may be so completely dried up as to seem like a particle of dust, yet resumes its vegetative activity whenever placed in the conditions favourable to it. The conjugating process commences by the putting forth of protrusions from the boundaries of two adjacent cells, which meet, fuse together (thereby showing the want of firmness of their 'ectoplasm'), and form a connecting bridge between their cavities (K). The fusion extends before long through a large part of the contiguous sides of the two cells (L); and at last becomes so complete that the combined mass (M) shows no trace of its double origin. It soon forms for itself a firm cellulose envelope, which bursts when the 'zygospore' is wetted; and the contained cell begins life as a *new generation*, speedily multiplying, like the former ones, by binary subdivision. It is curious to observe that during this conjugating process a production of oil particles takes place in the cells: these are at first small and distant, but gradually become larger and approximate more closely to each other, and at last coalesce so as to form oil-drops of various sizes, the green granular matter disappearing; and the colour of the conjugated body changes, with the advance of this process, from green to a light yellowish brown. When the zygospore begins to vegetate, on the other hand, a converse change occurs: the oil-globules disappear, and green granular matter takes their place.

If this (as seems probable) constitutes the entire life-cycle of *Palmoglaea*, it affords no example of that curious 'motile' stage which is exhibited by most algal protophytes in some stage of their existence, and which constitutes a large part of the life-history of the minute unicellular organism now to be described, **Protococcus pluvialis**, Ktz. (*Chlamydococcus pluvialis*, A. Br.) (fig. 418), which is not uncommon in collections of rain-water. Not only has this protophyte, in its motile condition, been very commonly regarded as an animalcule, but its different states have been described under several different names. In the first place, the colour of its cells varies considerably; since, although they are usually green at the period of their most active life, they are sometimes red; and their red form has received the distinguishing appellation of *Hemato-*

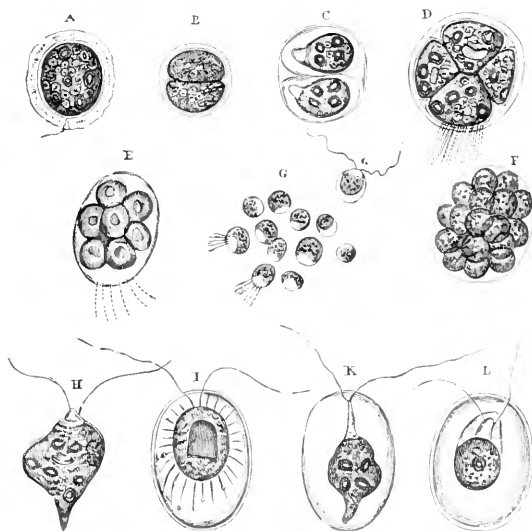

FIG. 418.—Development of *Protococcus pluvialis*.

coccus. Very commonly the red colouring matter forms only a central mass of greater or less size, having the appearance of a nucleus (as shown at E, fig. 418); and sometimes it is reduced to a single granular point, which has been described by Professor Ehrenberg as the *eye-spot* of these so-called animalcules. It is quite certain that the red colouring substance is very nearly related in its chemical character to the green, and that the one may be converted into the other, though the conditions under which this conversion takes place are not precisely known. In the 'still' form of the cell, with which we may commence the history of its life, the endoplasm consists of a colourless protoplasm, through which red or green coloured granules are more or less uniformly diffused; and the surface of the colourless protoplasm is condensed into an ectoplasm, which is surrounded by a tolerably firm cell-wall, consisting of cellulose

or of some modification of it. Outside this (as shown at A), when the 'still' cell is formed by a change in the condition of a cell that has been previously 'motile,' we find another envelope, which seems to be of the same nature, but which is separated by the interposition of aqueous fluid; this, however, may be altogether wanting. The multiplication of the 'still' cells by subdivision takes place as in *Palmoglea*, the endoplasm first undergoing separation into two halves (as seen at B), and each of these halves subsequently developing a cellulose envelope around itself, and undergoing the same division in its turn. Thus two, four, eight, or sixteen new cells are successively produced; and these are sometimes set free by the complete dissolution of the envelope of the original cell: but they are more commonly held together by its transformation into a gelatinous investment, in which they remain imbedded. Sometimes the endoplasm subdivides at once into four segments (as at D), of which every one forthwith acquires the character of an independent cell; but this, although an ordinary method of multiplication among the 'motile' cells, is comparatively rare in the 'still' condition. Sometimes, again, the endoplasm of the 'still' form subdivides at once into eight portions, which, being of small size, and endowed with motile power, may be considered as *zoöspores*. As far as the complete life-history of *Protooccus* is at present known, some of these zoöspores retain their motile powers, and develop themselves into the ordinary 'motile' cells; others produce a firm cellulose envelope and become 'still' cells; and others (perhaps the majority) perish without any further change.

When the ordinary division of the 'still' cells into two segments has been repeated four times, so as to produce sixteen cells—and sometimes at an earlier period—the new cells thus produced assume the 'motile' condition, being liberated before the development of the cellulose envelope, and becoming furnished with two long vibratile flagella which seem to be extensions of the colourless protoplasm layer that accumulates at their base so as to form a sort of transparent beak (H). In this condition it seems obvious that the colourless protoplasm is more developed relatively to the colouring matter than it is in the 'still' cells: and it usually contains 'vacuoles' occupied only by clear aqueous fluid, which are sometimes so numerous as to take in a large part of the cavity of the cell, so that the coloured contents seem only like a deposit on its walls. Before long this 'motile' cell acquires a peculiar saccular investment, which seems to correspond with the cellulose envelope of the 'still' cells, but is not so firm in its consistence (I, K, L); and between this and the surface of the ectoplasm a considerable space intervenes, traversed by thread-like extensions of the latter, which are rendered more distinct by iodine, and can be made to retract by means of reagents. The flagella pass through the cellulose envelope, which invests their base with a sort of sheath, and in the portion that is within this sheath no movement is seen. During the active life of the 'motile' cell the vibration of these flagella is so rapid that they can be recognised only by the currents they produce in the water through which the cells are quickly propelled: but when the motion

becomes slacker the flagella themselves are readily distinguishable, and they may be made more obvious by the addition of iodine, which, however, it should be noted, always kills the plant.

The multiplication of these 'motile' cells may take place in various modes, giving rise to a great variety of appearances. Sometimes they undergo a regular binary subdivision (B), whereby a pair of motile cells is produced (C), each resembling its single predecessor in possessing the cellulose investment, the transparent beak, and the vibratile flagella, before the dissolution of the original investment. Sometimes, again, the contents of the original cell undergo a segmentation in the first instance into four divisions (D); which may either become isolated by the dissolution of their envelope, and may separate from each other in the condition of 'free primordial cells' (H), developing their cellulose investments at a future time, or may acquire their cellulose investments (as in the preceding case) before the solution of that of the original cell; while sometimes, even after the disappearance of this, and the formation of their own independent investments, they remain attached to each other at their beaked extremities, the primordial cells being connected with each other by peduncular prolongations, and the whole compound body having the form of a +. This quaternary segmentation appears to be a more frequent mode of multiplication among the 'motile' cells than the subdivision into two, although, as we have seen, it is less common in the 'still' condition. So also a primary segmentation of the entire endochrome of the 'motile' cells into eight, sixteen, or even thirty-two parts, may take place (E, F), thus giving rise to as many minute gonidial cells. These, when set free, and possessing active powers of movement, are true zoospores (G); they may either develop a loose cellulose investment or cyst, so as to attain the full dimensions of the ordinary motile cells (I, K), or they may become clothed with a dense envelope and lose their flagella, thus passing into the 'still' condition (A); and this last transformation may even take place before they are set free from the envelope within which they were produced, so that they constitute a mulberry-like mass, which fills the whole cavity of the original cell, and is kept in motion by its flagella.

To what extent *Protococcus* is an autonomous organism is still doubtful, but it appears to be more or less closely connected with many forms of life which have been described, not merely as distinct *species*, but as distinct *genera* of animalcules or of protophytes, such as *Chlamydomonas*, *Euglena*, *Trachelomonas*, *Gyges*, *Gonium*, *Pandorina*, *Botryocystis*, *Urella*, *Synergypta*, *Monas*, *Astasia*, *Bodo*, and many others. Certain forms, such as the 'motile' cells I, K, L, appear in a given infusion, at first exclusively and then principally; they gradually diminish, become more and more rare, and finally disappear altogether, being replaced by the 'still' form. After some time the number of the 'motile' cells again increases, and reaches, as before, an extraordinary amount; and this alternation may be repeated several times in the course of a few weeks. The process of segmentation is often accomplished with great rapidity. If a number of 'motile' cells be transferred from a larger glass into a

smaller, it will be found, after the lapse of a few hours, that most of them have subsided to the bottom : in the course of the day they will all be observed to be upon the point of subdivision ; on the following morning the divisional brood will have become quite free ; and on the next the bottom of the vessel will be found covered with a new brood of dividing cells, which again proceed to the formation of a new brood, and so on. The activity of motion and the activity of multiplication seem to stand, in some degree, in a relation of reciprocity to each other ; for the dividing process takes place with greater rapidity in the 'still' cells than it does in the 'motile.'

What are the precise *conditions which determine the transition between the 'still' and the 'motile' states* cannot yet be precisely defined, but the influences of certain agencies can be predicted with tolerable certainty. Thus it is only necessary to pour the water containing these organisms from a smaller and deeper into a larger and shallower vessel in order at once to determine segmentation in numerous cells—a phenomenon which is observable also in many other protophytes. The 'motile' cells seem to be favourably affected by light, for they collect themselves at the surface of the water and at the edges of the vessel, but when they are about to undergo segmentation or to pass into the 'still' condition, they sink to the bottom of the vessel, or retreat to that part of it in which they are least subjected to light. When kept in the dark the 'motile' cells undergo a great diminution of their chlorophyll, which becomes very pale, and is diffused, instead of forming definite granules ; they continue their movement, however, uninterruptedly without either sinking to the bottom, or passing into the 'still' form, or undergoing segmentation. A moderate warmth, particularly that of the vernal sun, is favourable to the development of the 'motile' cells ; but a temperature of excessive elevation prevents it. Rapid evaporation of the water in which the 'motile' forms may be contained kills them at once ; but a more gradual loss, such as takes place in deep glasses, causes them merely to pass into the 'still' form ; and in this condition—especially when they have assumed a red hue—they may be completely dried up, and may remain in a state of dormant vitality for many years. It is in this state that they are wafted about in atmospheric currents, and that, being brought down by rain into pools, cisterns, &c., they may present themselves where none had been previously known to exist ; and there under favourable circumstances they may undergo a very rapid multiplication, and may maintain themselves until the water is dried up, or some other change occurs which is incompatible with the continuance of their vital activity. They then very commonly become red throughout, the red colouring substance extending itself from the centre towards the circumference, and assuming an appearance like that of oil-drops ; and these red cells, acquiring thick cell-walls and a mucous envelope, float in flocculent aggregations on the surface of the water. This state seems to correspond with the 'resting-spores' of other protophytes ; and it may continue until warmth, air, and moisture cause the development of the red cells into the ordinary 'still' cells, green matter being gradually produced, until the red substance forms

only the central part of the endochrome. After this the cycle of changes occurs which has been already described; and the plant may pass through a long series of these before it returns to the state of the red thick-walled cell, in which it may again remain dormant for an unlimited period. Even this cycle, however, cannot be regarded as completing the history of *Protococcus*, since it does not include the performance of any true generative act. There can be little doubt that, in some stage of its existence, a 'conjugation' of two cells occurs, as in *Palmogloia*; and the attention of observers should be directed to its discovery, as well as to the detection of other varieties in the condition of this interesting little plant, which will probably be found to present themselves before and after the performance of that act.¹

The **Cyanophyceæ** or **Phycchromaceæ** constitute another group of lowly forms of vegetable life, distinguished by their blue-green colour, differing from the Protococcaceæ in not containing true chlorophyll grains, the cell-sap being, on the other hand, coloured by a soluble blue-green pigment known as 'phycocyanin.' They live either isolated, or a number congregated together and enclosed in a more or less dense colourless jelly. They multiply by binary division, and do not in any case produce zoospores. To the lowest family of this group, which strongly resemble the Protococcaceæ, except in the colour of the cells, the *Chroococcaceæ*, belong the genera *Chroococcus*, *Glaucocapsa*, *Aphanocapsa*, *Merismopedia*, and many others, the life-history of which is but very imperfectly known.

The *Oscillatoriaceæ* constitute a family of Cyanophyceæ of great interest to the microscopist, on account both of the extreme simplicity of their structure and of the peculiar animal-like movements which they exhibit. They consist of fine, usually microscopic threads, containing a blue-green endochrome, sometimes replaced by a red or violet, and occur singly or in thick strata in fresh running or more abundantly in stagnant water. The threads are unbranched and usually straight, and either each separate thread or a number together are, in most of the genera, enclosed in a gelatinous sheath. Some illustrations of these are seen on Plate VII. The contents of the sheaths are imperfectly divided into cells by transverse division; small pieces of the threads, consisting of a few cells, occasionally break off, round themselves off at both ends, move about with a slow undulating motion, and finally develop into new threads; these portions are known as *hormogones*. The most abundant genus, *Oscillatoria*, has been so named from the peculiar oscillating or waving motion with which the threads are endowed. This consists of a creeping motion in the direction of the length of the thread, now backwards, now forwards, accompanied by a curvature of the thread and rotation round its own axis. The cause of this motion is still a matter of

¹ In the above sketch the Author has presented the facts described by Dr. Cohn under the relation which they seemed to him naturally to bear, but which differs from that in which they will be found in the original memoir; and he is glad to be able to state, from personal communication with its able author, that Dr. Cohn's later observations led him to adopt a view of the relationship of the 'still' and 'motile' forms which is in essential accordance with his own.

controversy. Professor Cohn¹ observed that the oscillating movements take place only when the thread is in contact with a solid substratum. Zukal² compares the motion of *Spirulina* to that of a growing tendril, and asserts that it is intimately connected with the growth of the filament. Hansgüing,³ on the other hand, considers the twisting and nodding movements to be due, not to the growth of the thread, but to osmotic changes in the cell-contents. He regards them as being of the same nature as the movements of the sarcode in the pseudopodia of rhizopods and other protozoa. Schmetzler⁴ describes the movements in *Oscillatoria* as of six different kinds: (1) rotation of the thread or of its segments round its axis; (2) creeping or gliding over a solid substratum; (3) a free-swimming movement in the water; (4) rotation or flexion of the entire thread; (5) sharp tremblings or concussions; and (6) a radiating arrangement of the entangled threads. The movements are greatly influenced by temperature and light, being much more active in warmth and sunshine than in cold and shade. There are no zoospores produced, nor is any sexual mode of generation known. The *Rivulariaceae* and *Scytonemaceae* (Pls. VII and VIII) are exceedingly common organisms in stagnant water, resembling the *Oscillatoriaceae* in their blue-green colour, and in their reproduction by means of 'homogones.'

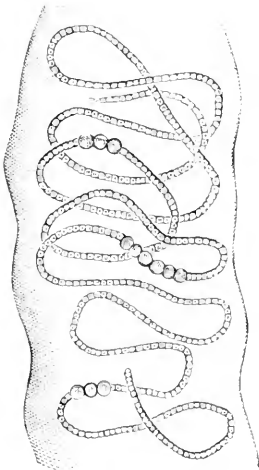

FIG. 419.—Portion of gelatinous frond of *Nostoc*.

Nearly allied to the preceding is the family of *Nostocaceae*, consisting of distinctly beaded filaments, which, in the most familiar genus, *Nostoc*, lie in firmly gelatinous envelopes of definite outline (fig. 419). The filaments are usually simple, though sometimes densely interwoven, and are almost always curved or twisted, often taking a spiral direction. The masses of jelly in which they are imbedded are sometimes globular or nearly so, and sometimes extend in more or less regular branches; they frequently attain a very considerable size; and as they occasionally present themselves quite suddenly (especially in the latter part of autumn on damp garden-walks), they have received the name of 'fallen stars.' They are not always so suddenly produced, however, as they appear to be; for they shrink up into mere films in dry weather and expand again with the first shower. Other species are not unfrequent among wet moss or on the surface of damp rocks. Species of *Anabaena* and *Aphanizomenon*, genera of *Nostocaceae*, constitute a large portion of

¹ *Arch. Mikrosk. Anatomie*, 1867, p. 48.

² *Oesterreichische Bot. Zeitschr.*, 1880, p. 11.

³ See *Bot. Centralblatt*, vol. xii. 1882, p. 361.

⁴ *Arch. Sci. Phys. et Nat.* 1885, p. 164.

the bluish-green scum which floats on the surface of stagnant water. Colonies of species of *Nostoc* and *Anabæna* are frequently endophytic within the cells of *Marchantia* and other Hepaticæ, the prothallia of ferns, or other aquatic or moisture-loving plants. *Nostoc* multiplies, like the Oscillatoriaceæ, by the subdivision of its filaments, portions of which escape from the gelatinous mass wherein they were imbedded, and move slowly through the water in the direction of their length. These are 'homogones,' similar to those of the Oscillatoriaceæ. After a time they cease to move, and a new gelatinous envelope is formed around each piece, which then begins to increase in length by the transverse subdivision of its segments. By the repetition of this process a mass of new filaments is produced, the parts of which are at first confused, but afterwards become more distinctly separated by the interposition of the gelatinous substance developed between them. Besides the ordinary cells of the beaded filaments, two other kinds are known, both larger than the ordinary cells, and called respectively *heterocysts* and *resting-spores*. The function of the former is unknown: the latter develop directly into new individuals by division in the transverse direction only, without any sexual process.

Resembling the Protococcaceæ in the independence of their individual cells are the two groups *Desmidiaceæ* and *Diatomaceæ*, forms of such special interest to the microscopist as to require separate treatment, and a detailed description of which will be found later on. The *Desmidiaceæ* constitute a group of the family **Conjugatæ**, so called from their mode of reproduction by *conjugation*, a process best exemplified in the higher group, the *Zygnemaceæ*, in which the cells produced by binary subdivision remain attached to each other, end to end, so as to form long unbranched filaments (fig. 420), whose length is continually being increased by a repetition of the same process, which may take place in any part of the filaments, and not at their ends alone. The plants of this group are not found so much in running streams as in waters that are perfectly still, such as those of ponds, of reservoirs, ditches, bogs, or marshy grounds: and they are for the most part unattached, floating freely at or near the surface, especially when buoyed up by the bubbles of gas which are liberated from the midst of them under the influence of solar light and heat. In the early stage of their growth, whilst as yet the cells are undergoing multiplication by division, the endochrome is frequently diffused pretty uniformly through their cavities (fig. 420, A); but as they advance towards the stage of conjugation, it ordinarily arranges itself into regular spirals (B, *Spirogyra*), a couple of star-like discs in each cell (*Zygnema*), or a single plate running through it in an axile direction (*Mesocarpus*). The act of conjugation usually occurs between the cells of two distinct filaments that happen to lie in proximity to each other, and all the cells of each filament generally take part in it at once. The adjacent cells put forth little protuberances, which come into contact with each other, and then coalesce by the breaking down of the intervening partitions, so as to establish a free passage between the cavities of the conjugating cells. In some genera of this family (such as *Mesocarpus*) the conjugating

cells pour their endochromes into a dilatation of the passage that has been established between them; and it is there that they commingle so as to form the zygospore. But in the various species of *Spirogyra* (fig. 420, B), which are among the commonest and best known of Conjugatae, the endochrome of one cell passes over entirely into the cavity of the other; and it is within the latter that the zygospore is formed (C), the two endochromes coalescing into a simple mass, around which a firm envelope gradually makes its appearance. Further, it may be generally observed that *all* the cells of one filament thus empty themselves, whilst *all* the cells of the other filament become the recipients. Here, therefore, we seem to have a foreshadowing of the sexual distinction of the generative cells into 'sperm-cells' and 'germ-cells,' which we shall presently see in the filamentous *Conferveae*. Conjugation between two adjacent cells of the same individual also occurs in some species.

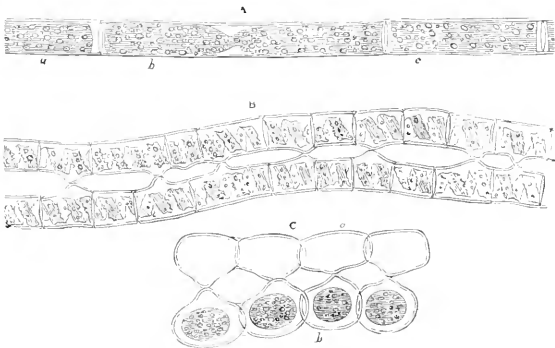
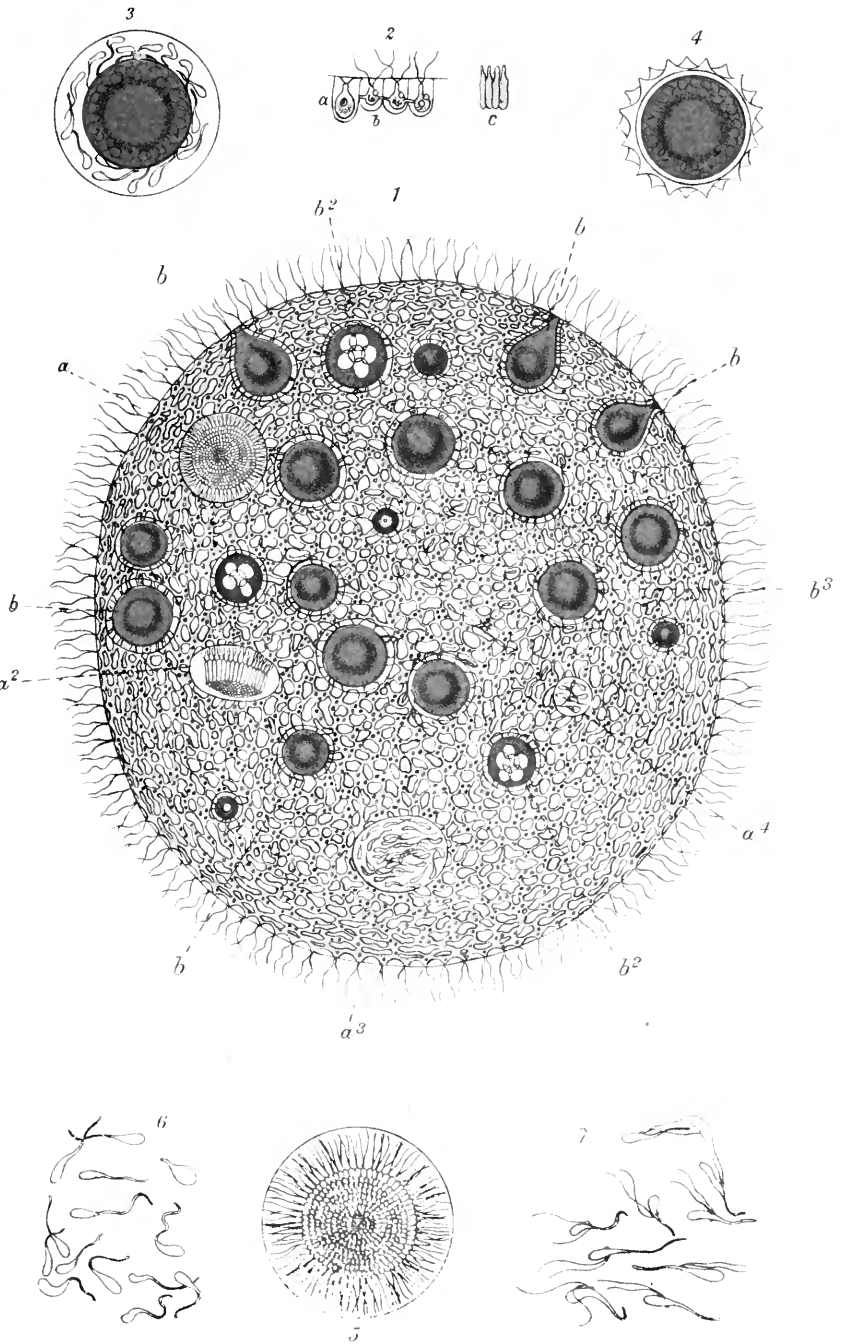

FIG. 420. —Various stages of the history of a *Spirogyra*: A, three cells, *a*, *b*, *c*, of a young filament, of which *b* is undergoing division; B, two filaments in the first stage of conjugation, showing the spiral disposition of their endochromes and the protuberances from the conjugating cells; C, completion of the act of conjugation, the endochromes of the cells of the filament *a* having entirely passed over to those of filament *b*, in which the zygospores are formed.

Although the two conjugating filaments are nearly or quite *morphologically* alike, there must clearly be a *physiological* differentiation, since the conjugation takes place in one direction only. Where conjugation occurs between cells in the same filament, this sexual differentiation must be ascribed to the individual cells. Multiplication by zoöspores does not take place among the Conjugatae.

From the composite motile forms of *Protococcus* the transition is easy to the group of **Volvocineæ**, an assemblage of minute plants of the greatest interest to the microscopist, on account both of the animalcule-like activity of their movements and of the great beauty and regularity of their forms. The most remarkable example of this group is the well-known *Volvox globator* (Plate VI), which is not uncommon in fresh-water pools, and which, attaining a diameter of about $\frac{1}{50}$ or even $\frac{1}{30}$ of an inch, may be seen with the naked eye when the drop containing it is held up to the light, swimming through



West, Newman chromo

Volvox globator.

the water which it inhabits. Its onward motion is usually of a rolling kind; but it sometimes glides smoothly along, without turning on its axis; whilst sometimes, again, it rotates like a top, without changing its position. When examined with a sufficient magnifying power the *Volvox* is seen to consist of a hollow sphere, composed of a very pellucid material, which is studded at regular intervals with minute green spots, and which is often (but not constantly) traversed by green threads connecting these spots. From each of the spots proceed two long flagella, so that the entire surface is beset with these lashing filaments, to whose combined action its movements are due. Within the external sphere may generally be seen from two to twenty other globes, of a darker colour, and of varying sizes; the smaller of these are attached to the inner surface of the investing sphere, and project into its cavity; but the larger lie freely within the cavity, and may often be observed to revolve by the agency of their own flagella. After a time the original sphere bursts, and the contained spherules swim forth and speedily develop themselves into the likeness of that within which they have been evolved, their coloured particles, which are at first closely aggregated together, being separated from each other by the interposition of the transparent pellicle. It was long supposed that *Volvox* is a *single* animal; and it was first shown to be a *composite* fabric, made up of a repetition of organisms in all respects similar to each other, by Professor Ehrenberg, who, however, considered these organisms as *monads*, and described them as each possessing a mouth, several stomachs, and an eye! Our present knowledge of their nature, however, leaves little doubt of their vegetable character;¹ and the peculiarity of their history renders it desirable to describe it in some detail.

Each of the so-called 'monads' (fig. 421, Nos. 9, 11) is a somewhat flask-shaped plant-cell, about $\frac{1}{30000}$ th of an inch in diameter, consisting, as in the previous instances, of green chlorophyll granules diffused through a colourless protoplasm, constituting an endochrome (which commonly includes also a red spot — 'eye-spot' — of altered chlorophyll), and bounded by an ectoplasm formed of the condensed and colourless surface-layer of the protoplasmic mass. It is prolonged outwardly (or towards the circumference of the sphere) into a sort of colourless beak or proboscis, from which proceed two flagella (fig. 421, No. 11); and it is invested by a pellucid or hyaline envelope (No. 9, *d*) of considerable thickness, the borders of which are flattened against those of other similar envelopes (No. 5, *c, c*), but which does not appear to have the tenacity of a true membrane. It is impossible not to recognise the close similarity between the structure of this body and that of the motile encysted cell of *Protococcus plurialis* (fig. 418, K). There is not, in fact, any perceptible difference between them, save that which arises from the regular aggregation, in *Volvox*,

¹ Professor Stein, however, in his great work on the Infusoria (*Organismus der Infusionsthierc*, Abtheilung III., Leipzig, 1878), still ranks the *Volvocineæ* among the flagellate animalcules, to which they undoubtedly show a remarkable parallelism in *structure*, the chief evidence of their vegetable nature lying in their *physiological* conformity to undoubted thallophytes.

of the cells which normally detach themselves from one another in *Protococcus*. The presence of cellulose in the hyaline substance is not indicated, in the ordinary condition of *Volvox globator*, by the iodine and sulphuric acid test, though the use of 'Schultz's solution' gives to it a faint blue tinge; there can be no doubt of its existence, however, in the hyaline envelope of *Volvox aureus*. The flagella and endoplasm, as in the motile forms of *Protococcus*, are tinged a deep brown by iodine, with the exception of one or two starch particles in each cell, which are turned blue; and when the contents of the cell are liberated, bluish flocculi, apparently indicative of the presence of cellulose, are brought into view by the action of sulphuric acid and iodine. All these reactions are characteristically *vegetable* in their nature. When the cell is approaching maturity, its endoplasm always exhibits one or more vacuoles (fig. 421, No. 9, *a, a*) of a spherical form, and usually about one-third of its own diameter; and these vacuoles (which are the so-called 'stomachs' of Ehrenberg) have been observed to undergo a very curious rhythmical contraction and dilatation at intervals of about forty seconds; the contraction (which seems to amount to complete obliteration of the cavity of the vacuole) taking place rapidly or suddenly, whilst the dilatation is slow and gradual. This curious action ceases, however, as the cell arrives at its full maturity;¹ a condition which seems to be marked by the greater consolidation of the ectoplasm, by the removal or transformation of some of the chlorophyll, and by the formation of the red spot (*b*), which obviously consists, as in *Protococcus*, of a peculiar modification of chlorophyll.

Each cell normally communicates with the cells in nearest proximity with it by extensions of its own endochrome, which are sometimes single and sometimes double (fig. 421, No. 5, *b, b*); and these connecting processes necessarily cross the lines of division between their respective hyaline investments. The thickness of these processes varies very considerably: for sometimes they are broad bands, and in other cases mere threads; whilst they are occasionally wanting altogether. This difference seems partly to depend upon the age of the individual, and partly upon the abundance of nutriment which it obtains: for, as we shall presently see, the connection is most intimate at an early period, before the hyaline investments of the cells have increased so much as to separate the masses of endochrome to a distance from one another (fig. 421, Nos. 2, 3, 4); whilst in a mature individual, in which the separation has taken place to its full extent and the nutritive processes have become less active, the masses of endochrome very commonly assume an angular form, and the connecting processes are drawn out into threads (as seen in No. 5), or they retain their globular form, and the connecting processes altogether disappear. The influence of reagents, or the infiltration of water into the interior of the hyaline investment, will sometimes cause the connecting processes (as in *Protococcus*) to be drawn back

¹ The existence of rhythmically contracting vacuoles in *Volvox* (though confirmed by the observations of Prof. Stein) is denied by Mr. Saville Kent (*Manual of the Infusoria*, p. 47); but it may be fairly presumed that he has not looked for them at the stage of development at which their action was witnessed by Mr. Busk.

PLATE VII.

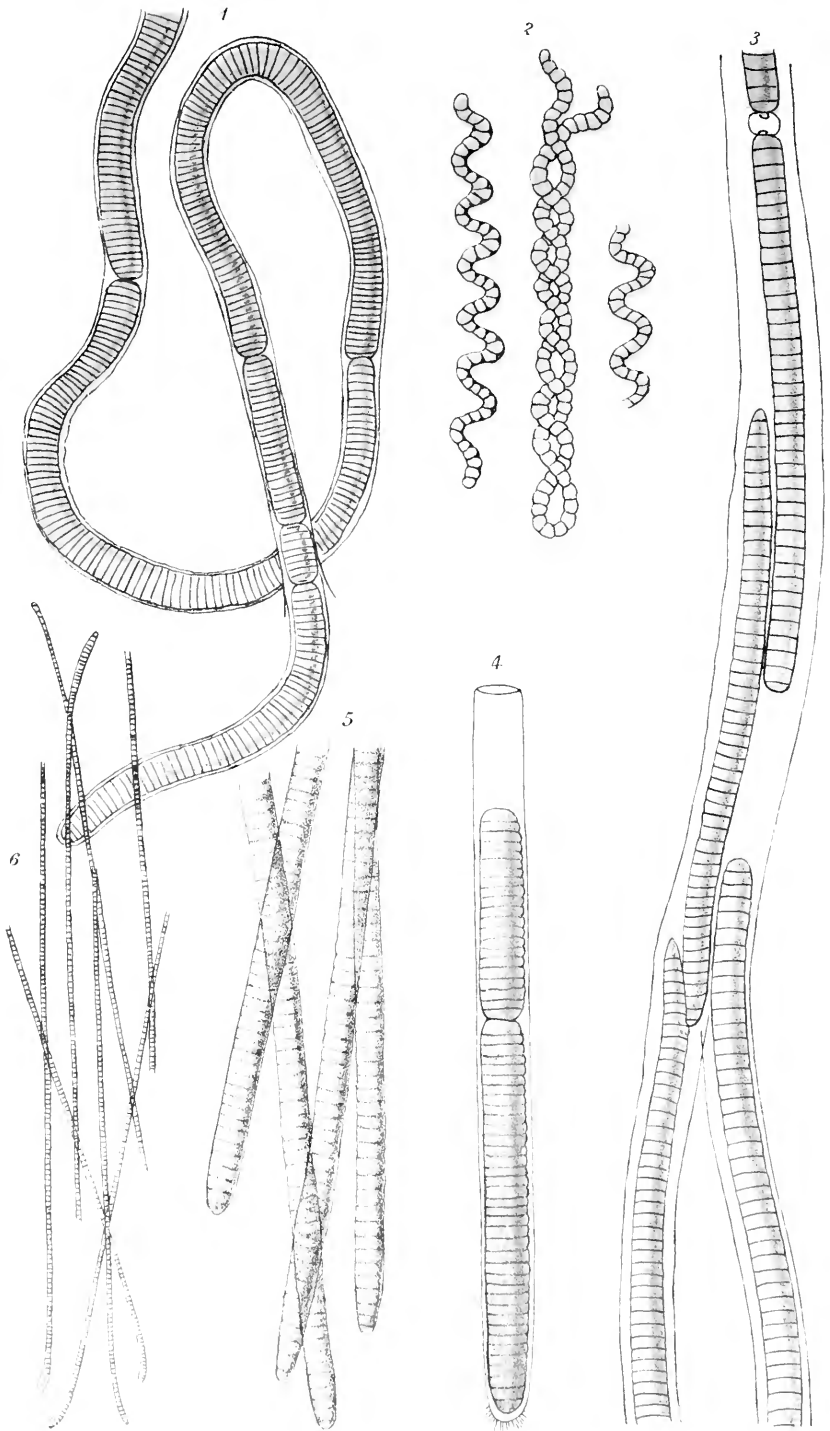

into the central mass of endochrome; and they will also retreat on the mere rupture of the hyaline investment. From these circumstances it may be inferred that they are not enclosed in any definite membrane. On the other hand, the connecting threads are sometimes seen as double lines, which seem like tubular prolongations of a consistent membrane, without any protoplasmic granules in their

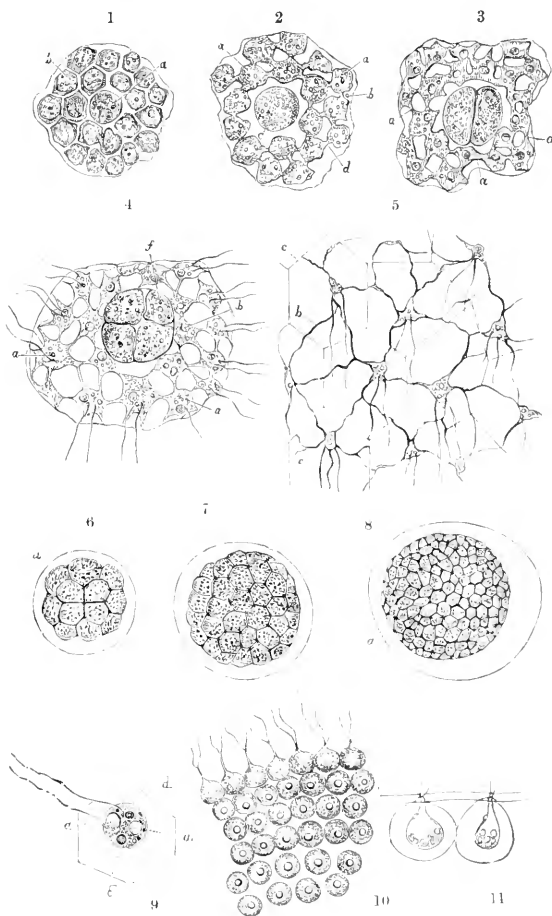
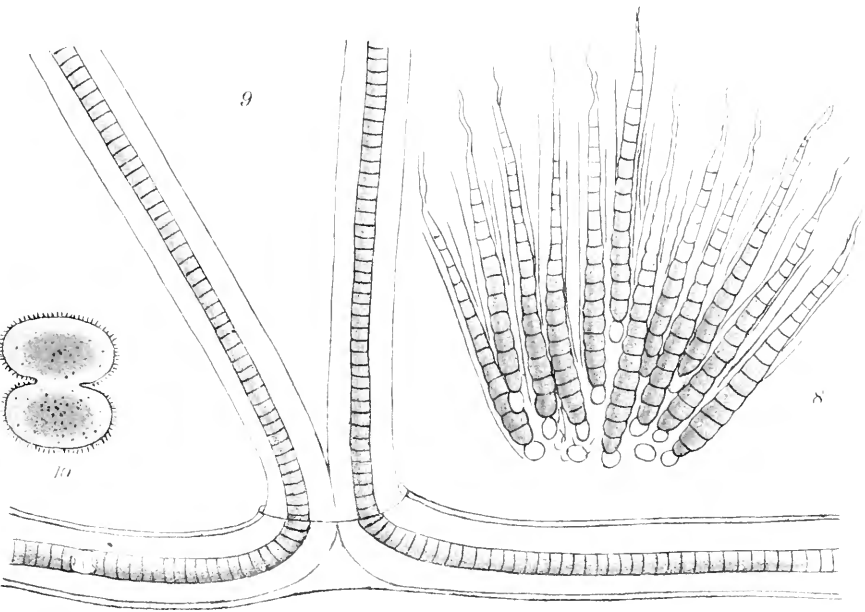
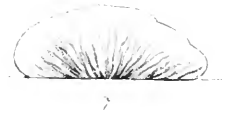
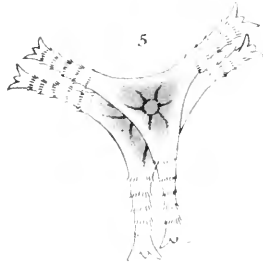
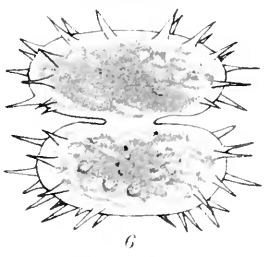
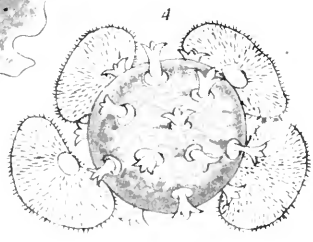
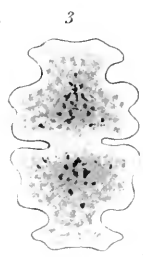
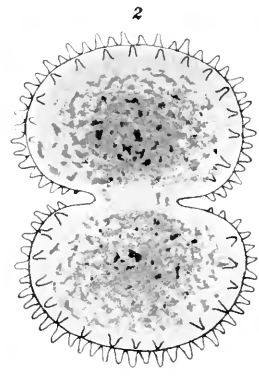
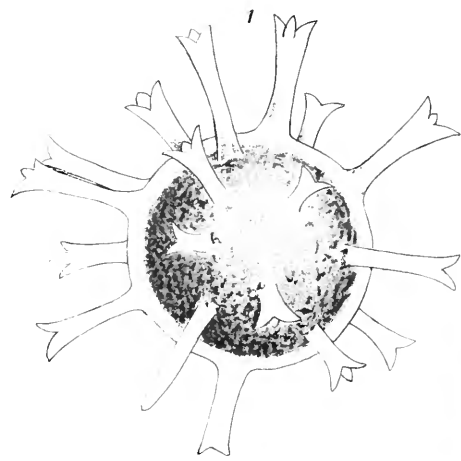

FIG. 421.—Structure of *Volvox globator*.

interior. It is obvious, then, that an examination of a considerable number of specimens, exhibiting various phases of conformation, is necessary to demonstrate the nature of these communications; but this may be best made out by attending to the history of their development, which we shall now describe.

The spherical body of the young *Volvox* (fig. 421, No. 1) is

composed of an aggregation of somewhat angular masses of endochrome (*b*), separated by the interposition of hyaline substance; and the whole seems to be enclosed in a distinctly membranous envelope, which is probably the distended hyaline investment of the original cell, within which, as will presently appear, the entire aggregation originated. In the midst of the polygonal masses of endochrome, one mass (*a*), rather larger than the rest, is seen to present a circular form; and this, as will presently appear, is the originating cell of what is hereafter to become a new sphere. The growing *Volvox* at first increases in size not only by the interposition of new hyaline substance between its component masses of endochrome, but also by an increase in these masses themselves (No. 2, *a*), which come into continuous connection with each other by the coalescence of processes (*b*) which they severally put forth; at the same time an increase is observed in the size of the globular cell (*c*), which is preliminary to its binary subdivision. A more advanced stage of the same developmental process is seen in No. 3, in which the connecting processes (*a, a*) have so much increased in size as to establish a most intimate union between the masses of endochrome, although the increase of the intervening hyaline substance carries these masses apart from one another; whilst the endochrome of the central globular cell has undergone segmentation into two halves. In the stage represented in No. 4 the masses of endochrome have been still more widely separated by the interposition of hyaline substance; each has become furnished with its pair of flagella, and the globular cell has undergone a second segmentation. Finally, in No. 5, which represents a portion of the spherical wall of a mature *Volvox*, the endochrome masses are observed to present a more scattered aspect, partly on account of their own reduction in size, and partly through the interposition of a greatly increased amount of hyaline substance, which is secreted from the surface of each mass; and that portion which belongs to each cell, standing to the endochrome mass in the relation of the cellulose coat of an ordinary cell to its ectoplasm, is frequently seen to be marked out from the rest by delicate lines of hexagonal areolation (*c, c*), which indicate the boundaries of each. Of these it is often difficult to obtain a sight, a nice management of the light being usually requisite with fresh specimens; but the prolonged action of water (especially when it contains a trace of iodine) or of glycerin will often bring them into clear view. The prolonged action of glycerin, moreover, will often show that the boundary-lines are double, being formed by the coalescence of two contiguous cell-walls; and they sometimes retreat from each other so far that the hexagonal areolæ become rounded. As the primary sphere approaches maturity, the large secondary germ-mass, or *zoösporangie*, whose origin has been traced from the beginning, also advances in development, its contents undergoing multiplication by successive segmentations, so that we find it to consist of eight, sixteen, thirty-two, sixty-four, or still more numerous divisions, as shown in fig. 421, Nos. 6, 7, 8. Up to this stage, at which the sphere first appears to become hollow, it is retained within the hyaline envelope of the cell within which it has





been produced; a similar envelope can be easily distinguished, as shown in No. 10, just when the segmentation has been completed, and at that stage the flagella pass into it, but do not extend beyond it; and even in the mature *Volvox* it continues to form an investment around the hyaline envelopes of the separate cells, as shown in the same figure at No. 11. It seems to be by the adhesion of the hyaline investment of the new sphere to that of the old that the secondary sphere remains for a time attached to the interior wall of the primary; at what exact period, or in what precise manner, the separation between the two takes place has not yet been determined. At the time of the separation the developmental process has generally advanced as far as the stage represented in No. 1, the foundation of one or more tertiary spheres being usually distinguishable in the enlargement of certain of its cells.

The development and setting-free of these composite zoösporangies, which is essentially a process of cell-subdivision or *gemmiparous extension*, is the ordinary mode of multiplication in *Volvox*, taking place at all times of the year, except when the *sexual generation* (now to be described) is in progress. The mode in which this process is here performed (for our knowledge of which we are indebted to the persevering investigations of Professor Cohn) shows a great advance upon the simple conjugation of two similar cells, and closely resembles that which prevails not only among the higher alge, but (under some form or other) through a large part of the cryptogamic series. As autumn advances the *Volvox* spheres usually cease to multiply themselves by the formation of zoösporangies, and certain of their ordinary cells begin to undergo changes by which they are converted, some into male or 'sperm-cells,' others into female or 'germ-cells,' the greater number, however, remaining sterile. Each sphere of *Volvox globator* (Plate VI, fig. 1) contains both kinds of sexual cells, so that this species ranks as *monocious*; but *V. aureus* is *diocious*, the sperm-cells and germ-cells occurring in separate spheres. Both kinds of sexual cells are at first distinguishable from the ordinary sterile cells by their larger size (fig. 2, *a*), in this respect resembling zoösporangies in an early stage; but their subsequent history is altogether different. The *sperm-cells* begin to undergo subdivision when they attain about three times the size of the sterile cells; this, however, takes place, not on the binary plan, but in such a manner that the endochrome of the primary cell resolves itself into a cluster of very peculiar secondary cells (fig. 1, *a*, *a*², fig. 5), each consisting of an elongated 'body' containing an orange-coloured endochrome with a red corpuscle, and of a long, colourless beak from the base of which proceeds a pair of long flagella (figs. 6, 7), as in the antherozoids of the higher cryptogams. As the sperm-cells approach maturity, the aggregate clusters may be seen to move within them, at first slowly, and afterwards more rapidly; the bundles then separate into their component *antherozoids*, which show an active, independent movement whilst still within the cavity of the primary cell (fig. 1, *a*³), and finally escape by the giving-way of its wall (*a*⁴), diffusing themselves through the cavity of the *Volvox* sphere. The

germ-cells (fig. 1, *b*, *b*), on the other hand, continue to increase in size without undergoing subdivision; at first showing large vacuoles in their protoplasm (*b*², *b*²), but subsequently becoming filled with dark-green endochrome. The form of the germ-cell gradually changes from its original flask-shape to the globular (*b*³); and it projects into the cavity of the *Volvox* sphere, at the same time acquiring a gelatinous envelope. Over this the swarming antherozoids diffuse themselves (fig. 3), penetrating its substance, so as to find their way to the interior; and in this situation they seem to dissolve away, so as to become incorporated with the *oösphere*. The product of this fusion (which is only conjugation under another form) is a reproductive cell or *oöspore*, which speedily becomes enveloped by an internal smooth membrane, and with a thicker external coat, which is usually beset with conical pointed processes (fig. 4); and the contained chlorophyll gives place, as in *Palmoglaea*, to starch and a red or orange coloured oil. As many as forty of such oöspores have been seen by Colm in a single sphere of *Volvox*, which thus acquires the peculiar appearance that has been distinguished by Ehrenberg by a different specific name, *Volvox stellatus*. Soon after the oöspores reach maturity, the parent sphere breaks up, and the oöspores fall to the bottom, where they remain during the winter. Their further history has since been traced out by Kirchner, who found that their germination commenced in February with the liberation of the spherical endospore from its envelope, and with its division into four cells by the formation of two partitions at right angles to each other. These partially separate, holding together only at one end, which becomes one pole of the globular cluster subsequently formed by cell-multiplication, the other pole only closing in when a large number of cells have been formed. The cells are then carried apart from one another by the hyaline investment formed by each, and the characteristic *Volvox* sphere is thus completed.¹

Another phenomenon of a very remarkable nature, namely, the conversion of the contents of an ordinary vegetable cell into a free moving mass of protoplasm that bears a strong resemblance to the animal *Amaba*, has been affirmed by Dr. Hicks² to take place in *Volvox*, under circumstances that leave no reasonable ground for that doubt of its reality which has been raised in regard to the accounts of similar phenomena occurring elsewhere. The endochrome-mass of one of the ordinary cells increases to nearly double its usual size; but, instead of undergoing binary subdivision so as to produce a zoösporangium, it loses its colour and its regularity of form, and

¹ The doctrine of the vegetable nature of *Volvox*, which had been suggested by Siebold, Braun, and other German naturalists, was first distinctly enunciated by Prof. Williamson, on the basis of the history of its development, in the *Transactions of the Philosophical Society of Manchester*, vol. ix.

[The most recent and detailed accounts of the development of the various forms of *Volvox* are by Klein (*Pringsheim's Jahrbücher für wissenschaftliche Botanik* vol. xx, 1889, p. 133) and Overton (*Botanisches Centralblatt*, vol. xxxix, 1889), which do not differ in any material point from the description given in the text. See also Bennett and Murray's *Handbook of Cryptogamic Botany*, p. 292.—Ed.]

² *Trans. of Microsc. Society*, n.s. vol. viii, 1860, p. 99; and *Quart. Journ. of Microsc. Science*, n.s. vol. ii, 1862, p. 96.

becomes an irregular mass of colourless protoplasm, containing a number of brown or reddish-brown granules, and capable of altering its form by protruding or retracting any portion of its membranous wall, exactly like a true *Amœba*. By this self-moving power, each of these bodies (of which twenty may sometimes be counted within a single *Volvox*) glides independently over the inner surface of the sphere among its unchanged green cells, bending itself round any one of these with which it may come into contact, precisely after the manner of an *Amœba*. After the 'amœboid' has begun to travel, it is always noticed that for every such moving body in the *Volvox* there is the empty space of a missing cell; and this confirms the belief—founded on observation of the gradational transition from the one condition to the other, and on the difficulty of supposing that any such bodies could have entered the sphere parasitically from without—that the 'amœboid' is really the product of the metamorphosis of a mass of vegetable protoplasm. This metamorphosis may take place, according to Dr. Hicks, even after the process of binary subdivision has commenced. What is the subsequent destination of these amœboid bodies has not yet been ascertained.¹

In other organisms allied to *Volvox*, and included in the family *Volvocineæ*, we find a very interesting and instructive transition between the various modes of multiplication already described. In *Eudorina*, a common organism in still water, a sexual process similar to that in *Volvox* has been observed. In *Pandorina morum* the generative process is performed, according to the observations of Pringsheim, in a manner curiously intermediate between the lower and the higher types referred to above. For within each cell of the original sixteen of which its mulberry-like mass is composed, a brood of sixteen secondary cells is formed by ordinary binary subdivision; and these, when set free by the dissolution of their containing cell-wall, swim forth as 'swarm-spores,' each being furnished with a pair of flagella. Among the crowd of these swarm-spores may be observed some which approach in pairs, as if seeking one another; when they meet, their points at first come together, but gradually their whole bodies coalesce, and a globular zygospore is thus formed which germinates after a period of rest, reproducing by binary subdivision the original sixteen-celled, mulberry-like *Pandorina*. We have here, therefore, a true process of conjugation between motile protoplasm masses, each of which is in itself indistinguishable from a zoospore. A similar process takes place also in *Conferva*, *Ulothrix*, *Hydrodictyon*, and a number of fresh-water algae (fig. 422).

Included by many writers under the general term **Palmellaceæ** are a number of minute organisms of very simple structure, the relationship of which to the *Protococcaceæ* is not yet fully known. They all grow either on damp surfaces or in fresh water; and they may either form (1) a mere powdery layer, of which the component

¹ A similar production of 'amœboids' has been observed by Mr. Archer in *Staphanosphæra pluvialis*, and is scarcely now to be considered an exceptional phenomenon.

particles have little or no adhesion to each other; or they may present themselves (2) in the condition of an indefinite slimy film, or (3) in that of a tolerably firm and definitely bounded membranous 'frond.' The first of these states we have seen to be characteristic of *Palmoglaea* and *Protococcus*; the new cells which are originated by the process of binary subdivision usually separating from each other after a short time, and, even where they remain in cohesion, not forming a 'frond' or membranous expansion. The 'red snow,' which sometimes colours extensive tracts in Arctic or Alpine regions, penetrating even to the depth of several feet, and vegetating actively at a temperature which reduces most plants to a state of torpor, is generally considered to be a species of *Protococcus*; but as its cells are connected by a tolerably firm gelatinous investment, it would rather seem to be a *Palmella*. The second is the condition of *Palmella* proper, of which one species, *P. cruenta*, usually known under the name of 'gory dew,' is common on damp walls and in shady

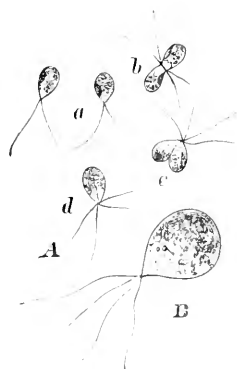

FIG. 422.—A, conjugating microzoospores of *Ulothrix*; B, megazoospore of *Ulothrix*, from Vines's 'Physiology of Plants.'

places, sometimes extending itself over a considerable area as a tough gelatinous mass, of the colour and general appearance of coagulated blood. A characteristic illustration of it is also afforded by the *Harmatococcus sanguineus* (fig. 423), which chiefly differs from *Palmella* in the partial persistence of the walls of the parent-cells, so that the whole mass is subdivided by partitions, which enclose a larger or smaller number of cells originating in the subdivision of their contents. Besides increasing in the ordinary mode of binary multiplication, the *Palmella* cells seem occasionally to rupture and diffuse their granular contents through the gelatinous stratum, and thus to give origin to a whole cluster at once, as seen at *e*, after the manner of other simple plants to be presently described, save that these minute segments of the endochrome, having no power of spontaneous motion, cannot be ranked as zoospores. The gelatinous masses of the *Palmella* are frequently found to contain parasitic growths formed by the extension of other plants through their substance; but numerous branched filaments sometimes present themselves, which, being traceable into absolute continuity with the cells, must be considered as properly appertaining to them. Sometimes these filaments radiate in various directions from a single central cell, and must at first be considered as mere extensions of this: their extremities dilate, however, into new cells; and, when these are fully formed, the tubular connections close up, and the cells become detached from each other.¹ Of the third condition we

¹ This fact, first made public by Mr. Thwaites (*Ann. of Nat. Hist.* 2nd series, vol. ii. 1848, p. 313), is one of fundamental importance in the determination of the real character of this group.

have an example in the curious *Palmodietyon* described by Kützing, the frond of which appears to the naked eye like a delicate network, consisting of anastomosing branches, each composed of a single or double row of large vesicles, within every one of which is produced a pair of elliptical cellules that ultimately escape as zoöspores. The alternation between the motile form and the still or resting form, which has been described as occurring in *Protococcus*, has been observed in several other forms of this group; and it seems obviously intended, like the production of zoöspores, to secure the dispersion of the plant and to prevent it from choking itself by overgrowth in any one locality. It is very commonly by plants of this group that the algal portions of lichens are formed.¹

Notwithstanding the very definite form and large size attained by the fronds or leafy expansions of the **Ulvaceæ**, to which group

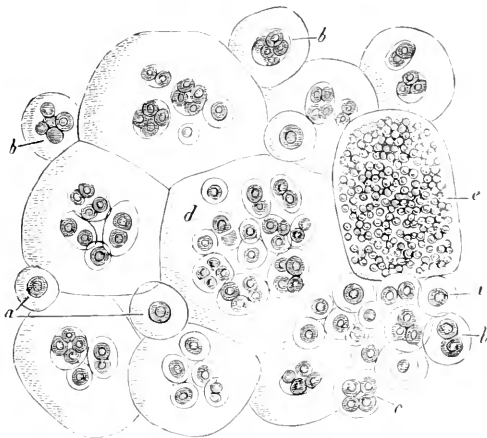

FIG. 423.—*Hamatococcus sanguineus*, in various stages of development; *a*, single cells, enclosed in their mucous envelope; *b*, *c*, cluster formed by subdivision of the parent-cell; *d*, more numerous cluster, its component cells in various stages of division; *e*, large mass of young cells, formed by the subdivision of the parent endochrome, and enclosed within a common mucous envelope.

belong some of the most common grass-green seaweeds ('laver') found on every coast, yet their essential structure differs but very little from that of the preceding group; and the principal advance is shown in this, that the cells, when multiplied by binary subdivision, not only remain in firm connection with each other, but possess a very regular arrangement (in virtue of the determinate plan on which the subdivision takes place), and form a definite membranous expansion. The mode in which this frond is produced may be best understood by studying the history of its development, some of the principal phases of which are seen in fig. 424. The isolated cells A, in which it originates, resembling in all points those of a

¹ [The *Palmellaceæ* are not now regarded by the best authorities as a distinct family from the *Protococcaceæ*, and the genus *Hamatococcus* is sunk in *Protococcus*.—ED.]

Protococcus, give rise, by their successive subdivisions in determinate directions, to such regular clusters as those seen at B and C, or to such confervoid filaments as that shown at D. A continuation of the same regular mode of subdivision, taking place alternately in two directions, may at once extend the clusters B and C into leaf-like expansions; or, if the filamentous stage be passed through (different species presenting variations in the history of their development), the filament increases in breadth as well as in length (as seen at E), and finally becomes such a 'frond' as is shown at F, G. In the simple membranous expansion or *thallus* thus formed, there is



FIG. 424.—Successive stages of development of *Ulea*.

but little approach to a differentiation of parts in the formation of root, stem, and leaf, such as the higher algae present; every portion is the exact counterpart of every other, and every portion seems to take an equal share in the operations of growth and reproduction. Each cell is very commonly found to exhibit an imperfect partitioning into four parts preparatory to multiplication by double bipartition, and the entire frond usually shows the groups of cells arranged in clusters containing some multiple of four.

Besides this continuous increase of the individual frond, however, we find, in most species of *Ulea*, a provision for extending the plant by the dispersion of zoöspores. The endochrome (fig. 425, *a*) subdivides into numerous segments (as at *b* and *c*), which at first are seen to lie in close contact within the cell that contains them, then begin to exhibit a kind of restless motion, and at last escape by the bursting of the cell-wall, and swim freely through the water as zoöspores (*d*) by means of their flagella, each zoöspore having become endowed with either two or four flagella during its formation within its mother-cell. At last, however, they come to rest, attach themselves to some fixed point, and begin to grow into clusters or filaments (*e*) in the manner already described. The walls of the cells which have thus discharged their endochrome remain as colourless spots on the frond; sometimes these are intermingled with

the portions still vegetating in the usual mode; but sometimes the whole endochrome of one portion of the frond may thus escape in the form of zoöspores, leaving behind it nothing but a white flaccid membrane. If the microscopist who meets with a frond of an *Ulva* in this condition examines the line of separation between its green and its coloured portions, he may not improbably meet with cells in the very act of discharging their zoöspores, which 'swarm' around their points of exit very much in the manner that animalcules are often seen to do around particular spots of the field of view, and which might easily be taken for true Infusoria; but on carrying his observations further, he would see that similar bodies are moving *within* cells a little more remote from the dividing line, and that a

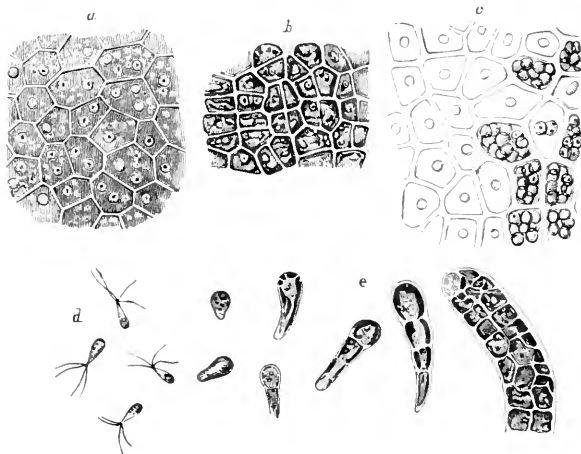

FIG. 425.—Formation of zoöspores in *Ulva latissima*: *a*, portion of the ordinary frond; *b*, cells in which the endochrome is beginning to break up into segments; *c*, cells from the boundary between the coloured and colourless portions, some of them containing zoöspores, others being empty; *d*, flagellate zoöspores, as in active motion; *e*, subsequent development of the zoöspores.

little farther still they are obviously but masses of endochrome in the act of subdivision.¹

More recent observation has brought out the interesting fact that in *Ulva* and its allies there are two kinds of swarm-spore, a larger kind, 'megazoöspores,' with four, and a smaller kind, 'microzoöspores,' with two cilia each (see fig. 422). Of these the megazoöspores germinate directly, as above described, while the microzoöspores or 'zoögametes' have been observed to conjugate in pairs, producing zygospores, by the germination of which a new generation is produced. The two kinds of zoöspore may be produced on the same or on different individuals.

¹ Such an observation the Author had the good fortune to make in the year 1842, when the emission of zoöspores from the *Ulveæ*, although it had been described by the Swedish algologist Agardh, had not been seen (he believes) by any British naturalist.

Although many of the plants belonging to the family *Siphonaceæ* attain a considerable size, and resemble the higher seaweeds in their general mode of growth, yet they retain a simplicity of structure so extreme as to require them to be ranked among the simpler thallophytes.

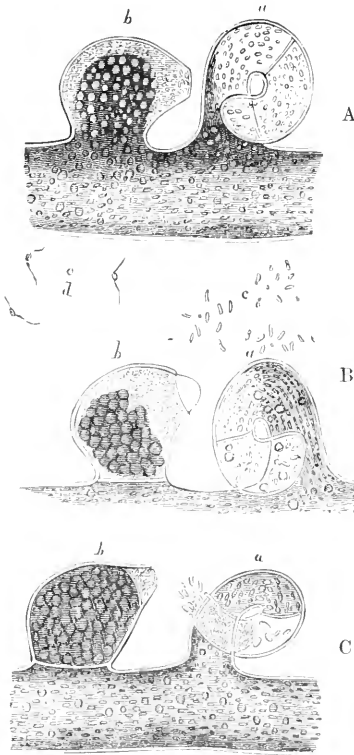

FIG. 426.—Successive phases of generative process in *Vaucheria sessilis*: at A are seen one of the 'horns' or antherids (a) and one of the oogones (b), as yet unopened; at B the antherid is seen in the act of emitting the antherozoids (c), of which many enter the opening at the apex of the oogone, whilst others (d) which do not enter it display their cilia until they become motionless; at C the orifice of the oogone is closed again by the formation of a cellulose coat around the oosphere, thus constituting an oöspore.

They are inhabitants both of fresh water and of the sea, and consist of very large tubular cells, which often extend themselves into branches, so as to form an arborescent frond. These branches, however, are not separated from the stem by any intervening partition, except those parts where the generative organs are produced; but the whole frond is composed of a simple continuous tube, the entire contents of which may be readily pressed out through an orifice made by wounding any part of the wall. The genus *Vaucheria* may be selected as a particularly good illustration of this family, its history having been pretty completely made out. Most of its species are inhabitants of fresh water, but some are marine; and they commonly present themselves in the form of cushion-like masses, composed of irregularly branching filaments, which, although they remain distinct, are densely tufted together and variously interwoven. Some

species form dense green mats on damp soil in flower-pots, &c. The formation of motile gonids or zoöspores may be readily observed in these plants, the whole process usually occupying but a very short time. The extremity of one of the filaments usually swells up in the form of a club, and the endochrome accumulates in it so as to give it a darker hue than the rest; a separation of this part from the remainder of the filament, by the interposition of a transparent space, is next seen; a new envelope is then formed around the mass thus cut off; and at last the membranous wall of the investing tube gives way, and the zoö-

spore escapes, not, however, until it has undergone marked changes of form, and exhibited curious movements. Its motions continue for some time after its escape, and are then plainly seen to be due to the action of the cilia, which form a complete fringe round it. If it be placed in water in which some carmine or indigo has been rubbed, the coloured granules are seen to be driven in such a manner as to show that a powerful current is produced by their propulsive action, and a long track is left behind it. When it meets with an obstacle, the ciliary action not being arrested, the zoöspore is flattened against the object: and it may thus be compressed, even to the extent of causing its endochrome to be discharged. The cilia are best seen when their movements have been retarded or entirely arrested by means of opium, iodine, or other chemical reagents. The motion of the spore continues for about two hours; but after the lapse of that time it soon comes to an end, and the spore begins to develop itself into a new plant. It has been observed by Unger that the escape of the zoöspores generally takes place towards 8 A.M.: to watch this phenomenon, therefore, the plant should be gathered the day before, and its tufts examined early in the morning. The same filament may give off two or three zoöspores successively.

In addition to this mode, there exists also in this humble plant a true process of sexual generation. The branching filaments are often seen to bear at their sides peculiar globular or oval capsular protuberances, sometimes separated by the interposition of a stalk, which are filled with dark endochrome; and from these, after a time, new plants arise. In the neighbourhood of these bodies are found, in most species, certain other projections, which, from being usually pointed and somewhat curved, have been named 'horns' (fig. 426. A. *a*): and these have been shown by Pringsheim to be *antherids*, which produce *antherozoids* in their interior; whilst the capsule-like bodies (A. *b*) are *oögones* or *archegones*, each containing a mass of endochrome which constitutes an *oösphere* that is destined to become, when fertilised, the original cell of a new generation. The antherozoids (B. *c*, *d*), when set free from the antherid *a*, swarm about the oögone *b*, and, attracted by a drop of mucilage formed at the mouth of the oögone, enter it, one or more antherozoids becoming absorbed into the substance of the oösphere. This hitherto naked mass of protoplasm now becomes invested by an envelope of cellulose (C. *b*), which increases in thickness and strength, until it has acquired such a density as enables it to afford a firm protection to its contents. While in *Faucheria* the separate filaments are so slender as to be scarcely discernible to the naked eye, the frond of other genera of Siphonaceæ, mostly natives of shallow seas in the warmer parts of the globe, attains very large dimensions. Thus in *Codium* it is a spongy spherical or cylindrical floating mass, as much as a foot in length; in *Caulerpa* it has the appearance of a branched leaf springing from a stem, which puts out roots from its under side; in *Acetabularia* it takes a mushroom-like form with a cap or 'pileus,' a quarter of an inch in diameter, divided into regular chambers, at the summit of a cylindrical stalk,

1½ to 3 inches in height. Munier-Charles¹ believes that many fossils generally regarded as *Foraminifera* are in reality the calcareous skeleton of algae belonging or nearly allied to the Siphonaceae.

The microscopist who wishes to study the development of zoöspores, as well as several other phenomena of this low type of vegetation, may advantageously have recourse to the little plant termed *Achlya prolifera*,² which grows parasitically upon the bodies of dead flies lying in water. Its tufts are distinguishable by the naked eye as clusters of minute colourless filaments; and these are found,

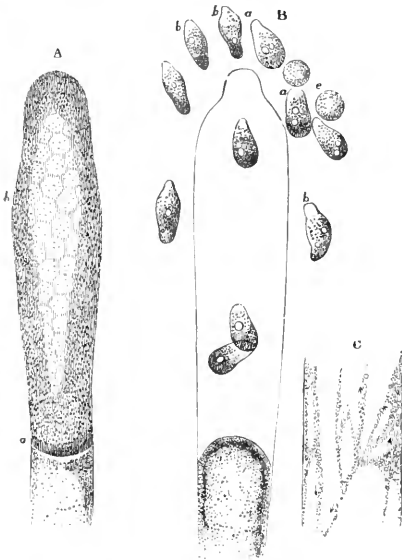

FIG. 427.—Development of *Achlya prolifera*: A, dilated extremity of a filament *b*, separated from the rest by a partition *a*, and containing zoöspores in progress of formation; B, end of filament after the cell-wall has burst, and setting free zoöspores, *a*, *b*, *c*; C, portion of filament, showing the course of the circulation of granular protoplasm.

when examined by the microscope, to be long tubes, devoid of all partitions, extending themselves in various directions. The tubes contain a colourless slightly granular protoplasm, the particles of which are seen to move slowly in streams along the walls, as in *Chara*, the currents occasionally anastomosing with each other (fig. 427, C). Within about thirty-six hours after the first appearance of the parasite on any body, the protoplasm begins to accumulate in the dilated ends of the filaments, each of which is then cut off from the remainder by the formation of a partition; and within this dilated cell the movement of the protoplasm continues for a time to be distinguishable. Very speedily, however, its endoplasm shows

the appearance of being broken up into a large number of distinct masses, which are at first in close contact with each other and with the walls of the cell (fig. 427, A), but which gradually become more isolated, each seeming to acquire a proper cell-wall: they then begin to move about within the parent-cell; and, when

¹ *Comptes Rendus*, vol. lxxx. 1877, p. 814.

² [This plant, though, as an inhabitant of water, formerly ranked among *Alga*, is now generally regarded as belonging to the group of *Fungi*, on account of its incapacity for the production of chlorophyll, and its parasitism on the bodies of animals, from whose juices its cells seem to draw their nourishment. It is very closely allied to *Saprolegnia* (see p. 640), a fungus parasitic on the bodies of living fish, and causing the very destructive disease to which salmon are liable.—Ed.]

quite mature, they are set free by the rupture of its wall (B), and, after swarming about for a time, develop into tubiform cells resembling those from which they sprang. Each of these zoöspores is possessed of two flagella; their movements are not so powerful as those of the zoöspores of *Vaucheria*, and come to an end sooner. The generative process in this type is performed in a manner that may be regarded as an advance upon ordinary conjugation. The end of one of the long tubiform cells enlarges into a globular dilatation, the cavity of which becomes shut off by a transverse partition. Its contained endoplasm divides into two, three, or four segments, each of which takes a globular form, and is then fertilised by the penetration of an antheridial tube which comes off from the filament a little below the partition. The oöspores thus produced, escaping from the globular cavities, acquire firm envelopes, and may remain unchanged for a long time even in water, when no appropriate *nidus* exists for them; but will quickly germinate if a dead insect or other suitable object be thrown in.

One of the most curious forms of the lower algæ is the 'water-net,' **Hydrodictyon reticulatum**, which is found in fresh-water pools in the midland and southern counties of England. Its frond consists of a green open network of filaments, acquiring, when full grown, a length of from four to six inches, and composed of a vast number of cylindrical tubular cells, which attain the length of four lines or more, and adhere to each other by their rounded extremities, the points of junction corresponding to the knots or intersections of the network. Each of these cells may form within itself an enormous multitude (from 7,000 to 20,000) of zoöspores, which at a certain stage of their development are observed in active motion in its interior, but come to rest in the course of about half an hour, and then arrange themselves in such a way that by their elongation they again form a net of the original kind, which is set free by the dissolution of the wall of the mother-cell, and attains in the course of three or four weeks the size of the mother-colony. Besides these bodies, however, certain cells produce from 30,000 to 100,000 'microzoöspores' of longer shape, each furnished with four long flagella and a red 'eye-spot'; these escape from the cell in a swarm, and move freely in the water for some time. Conjugation between these smaller zoöspores has been observed to take place sometimes even with the mother-cell. The resulting body or 'zygospore' retains its green colour, but becomes invested with a firm cell-wall of cellulose. In this condition these bodies may remain dormant for a considerable time, and are described as 'hypnospores' or 'resting-spores'; and in this state they are able to endure being completely dried up without the loss of their vitality, provided that they are secluded from the action of light, which causes them to wither and die. In this state they bear a strong resemblance to the cells of *Protococcus*. The first change that manifests itself in them, when they begin to germinate, is a simple enlargement; next the endochrome divides itself successively into distinct masses, usually two or four in number; and these, when set free by the giving way of the enveloping membrane, present the characters of ordinary

zoöspores, each of them possessing two flagella at its anterior semi-transparent extremity. Their motile condition, however, does not last long, often giving place to the motionless stage before they have quite freed themselves from the parent-cell; they then project long angular processes, so as to assume the form of irregular polyhedra, at the same time augmenting in size; and the endochrome contained within each of these breaks up into a multitude of zoöspores, which are at first quite independent and move actively within the cell-cavity, but soon unite into a network that becomes invested with a gelatinous envelope, and speedily increases so much in size as to rupture the containing cell-wall, on escaping from which it presents all the essential characters of a young *Hydrodictyon*. The rapidity of the growth of this curious organism is not one of the least remarkable parts of its history. The individual cells of which the net is composed, at the time of their emission as zoöspores, measure

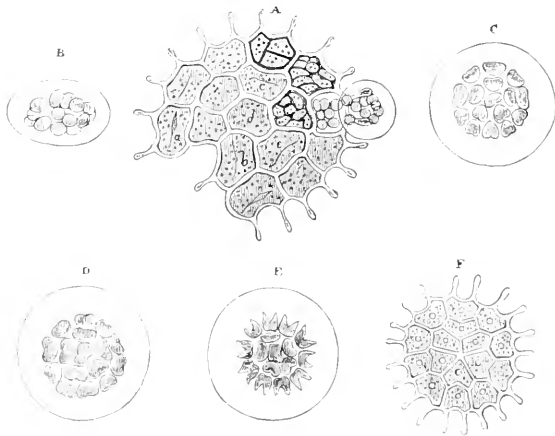

FIG. 428. —Various phases of development of *Pedicestum granulatum*.

no more than $\frac{1}{2500}$ th of an inch in length; but in the course of a few hours they grow to a length of from $\frac{1}{2}$ th to $\frac{1}{3}$ rd of an inch.

The members of the family **Pediciestreeæ** were formerly included in the *Desmidiaceæ*; but, though doubtless related to them in certain particulars, they present too many points of difference to be properly associated with them. Their chief point of resemblance consists in the firmness of the outer covering, and in the frequent interruption of its margin either by the protrusion of ‘horns’ (fig. 428, A), or by a notching more or less deep (fig. 429, B); but they differ in these two important particulars—that the cells are not made up of two symmetrical halves, and that they are always found in aggregation, which is not, except in such genera as *Scenedesmus* which connect this group with the Desmids, in linear series, but in the form of discoidal fronds. In this tribe we meet with a form of multiplication by motile ‘megazoöspores’ which reminds us of the formation of the motile spheres of *Volvox*, and which takes place in

such a manner that the resultant product may vary greatly in the number of its cells, and consequently both in size and in form. Thus in *Pediastrum granulatum* (fig. 428) the zoöspores formed by the subdivision of the endochrome of one cell, which may be four, eight, sixteen, thirty-two, or sixty-four in number, escape from the parent frond still enclosed in the inner layer of the cell-wall; and it is within this that they develop themselves into a cluster resembling that in which they originated, so that the frond may be composed of either of the just-mentioned multiples or sub-multiples of 16. At A is seen an old disc, of irregular shape, nearly emptied by the emission of its zoöspores, which had been seen to take place within a few hours previously from the cells *a, b, c, d, e*; most of the empty cells exhibit the cross slit through which their contents had been discharged; and where this does not present itself on the side next the observer, it is found on the other. Three of the cells still possess their coloured contents, but in different conditions. One of them exhibits an early stage of the subdivision of the endochrome—namely, into two halves, one of which already appears halved again. Two others are filled by sixteen very closely crowded zoöspores, only half of which are visible, as they form a double layer. Besides these, one cell is in the very act of discharging its zoöspores, nine of which have passed forth from its cavity, though still enveloped in a vesicle formed by the extension of its innermost membrane; whilst seven yet remain in its interior. The new-born family, as it appears immediately on its complete emission, is shown at B; the zoöspores are actively moving within the vesicle, and they do not as yet show any indication either of symmetrical arrangement or of the peculiar form which they are subsequently to assume. Within a quarter of an hour, however, the zoöspores are observed to settle down into one plane, and to assume some kind of regular arrangement, most commonly that seen at C, in which there is a single central body surrounded by a circle of five, and this again by a circle of ten; they do not, however, as yet adhere firmly together. The zoöspores now begin to develop themselves into new cells, increase in size, and come into closer approximation (D); and the edge of each, especially in the marginal row, presents a notch which foreshadows the production of its characteristic ‘horns.’ Within about four or five hours after the escape of the zoöspores, the cluster has come to assume much more of the distinctive aspect of the species, the marginal cells having grown out into horns (E); still, however, they are not very closely connected with each other, and between the cells of the inner row considerable spaces yet intervene. It is in the course of the second day that the cells become closely applied to each other, and that the growth of the horns is completed, so as to constitute a perfect disc like that seen at F, in which, however, the arrangement of the interior cells does not follow the typical plan.¹ The formation of ‘microzoöspores’ has also been observed, which have been seen to conjugate.

¹ See Prof. Braun on *The Phenomenon of Rejuvenescence in Nature*, published by the Ray Society in 1853; and its subsequent memoir, *Algarum Unicellularum Genera nova aut minus cognitæ*, 1855.

The varieties which present themselves, indeed, both as to the number of cells in each cluster and the plan on which they are disposed, are such as to baffle all attempts to base specific distinctions on such grounds; and the more attentively the life-history of any one of these plants is studied, the more evident does it appear that many reputed 'species' have no real existence. Some of these, indeed, are nothing else than mere transitory forms; thus it can be scarcely doubted that the specimen represented in fig. 429, D, under the name of *Pediastrum pertusum*, is in reality nothing else than a young frond of *P. granulatum* in the stage represented in fig. 428, E, but consisting of thirty-two cells. On the other hand, in fig. 429, E, we see an emptied frond of *P. granulatum*, exhibiting the peculiar surface-marking from which the name of the species is derived, but composed of no more than eight cells. And instances every now and then occur in which the frond consists of only four cells, each of

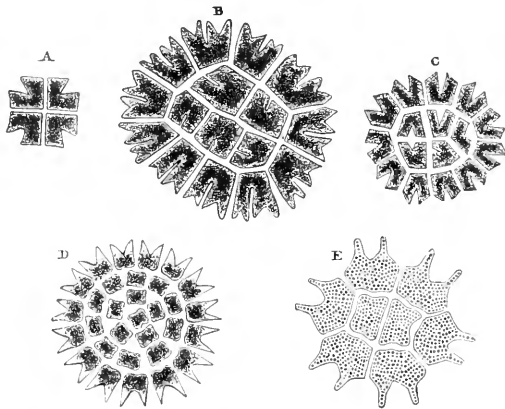

FIG. 429.—Various species (?) of *Pediastrum*: A, *P. tetras*; B, C, *P. Ehrenbergii*; D, *P. pertusum*; E, emptied frond of *P. granulatum*.

them presenting the two-horned shape. So, again, in fig. 429, B and C, are shown two varieties of *Pediastrum Ehrenbergii*, whose frond is normally composed of sixteen cells; whilst at A is figured a form which is designated as *P. tetras*, but which may be strongly suspected to be merely a four-celled variety of B and C. Many similar cases might be cited; and the Author would strongly urge those microscopists who have the requisite time and opportunities, to apply themselves to the determination of the *real species* of these groups by studying the entire life-history of whatever forms may happen to lie within their reach, and noting all the varieties which present themselves among the offsets from any one stock. The characters of such varieties are diffused by the process of binary subdivision amongst vast multitudes of so-called individuals. Thus it happens that, as Mr. Ralfs has remarked, 'one pool may abound with individuals of *Staurastrum dejectum* or *Arthrodesmus incus* having the micro-

curved outwards; in a neighbouring pool every specimen may have it curved inwards; and in another it may be straight. The cause of the similarity in each pool no doubt is that all its plants are off-sets from a few primary fronds.' Hence the universality of any particular character in all the specimens of one gathering is by no means sufficient to entitle these to take rank as a distinct species; since they are, properly speaking, but repetitions of the same variety by a process of simple multiplication, really representing in their entire aggregate the one plant or tree that grows from a single seed.

Almost every pond and ditch contains some members of the family **Confervaceæ**; but they are especially abundant in moving water, and they constitute the greater

part of those green threads which are to be seen attached to stones, with their free ends floating in the direction of the current, in every running stream, and upon almost every part of the sea-shore, and which are commonly known under the name of 'silk-weeds,' or 'crow-silk.' Their form is usually very regular, each thread being a long cylinder made up by the union of a single filament of short cylindrical cells united to each other by their flattened extremities; sometimes these threads give off lateral branches, which have the same structure. The endochrome, though usually green, is occasionally of a brown or purple hue, and is usually distributed uniformly throughout the cell (as in fig. 430). The plants of this family are extremely favourable subjects for the study of the method of cell-multiplication by *binary subdivision*. This process usually, but not always, takes place only in the *terminal* cell; and it may be almost always observed there in some one of its stages.

The first step is seen to be the subdivision of the endochrome, and the inflexion of the ectoplasm around it (fig. 430 A, *a*); and thus there is gradually formed a sort of hour-glass contraction across the cavity of the parent-cell, by which it is divided into two equal halves (B). The two surfaces of the infolded utricule produce a double layer of cellulose membrane between them. Sometimes, however, as in *Cladophora glomerata* (a common species), new cells may originate as branches from any part of the surface by a process of budding, which, notwithstanding its difference of mode, agrees with that just described in its essential character, being the result of the sub-

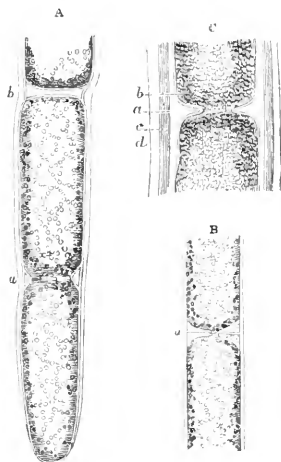

FIG. 430.—Process of cell-multiplication in *Cladophora glomerata*: A, portion of filament with incomplete separation at *a*, and complete partition at *b*; B, the separation completed, a new cellulose partition being formed at *a*; C, formation of additional layers of cellulose wall, *c*, beneath the mucous investment, *d*, and around the ectoplasm, *a*, which encloses the endochrome, *b*.

division of the original cell. A certain portion of the ectoplasm seems to undergo increased nutrition, for it is seen to project, carrying the cellulose envelope before it, so as to form a little protuberance, and this sometimes attains a considerable length before any separation of its cavity from that of the cell which gave origin to it begins to take place. This separation is gradually effected, however, by the infolding of the ectoplasm, just as in the preceding case; and thus the endochrome of the branch cell becomes completely severed from that of the stock. The branch then begins to elongate itself by the subdivision of its first-formed cell; and this process may be repeated for a time in all the cells of the filament, though it usually comes to be restricted at last to the terminal cell. The very elongated cells of some species of Confervaceæ are characterised by the possession of a large number of nuclei. They are multiplied by zoöspores, produced apparently indifferently from any cell of a filament, by free-cell formation. These zoöspores are of two kinds, larger or smaller; the larger kind have either two or four cilia, and germinate directly; the smaller are biciliated, and conjugation between them has been observed.

Nearly allied to the Confervaceæ is a very interesting plant in which a true sexual mode of reproduction has been observed. **Sphæroplea annulina**, the development and generation of which have been specially studied by Dr. F. Cohn.¹ The oöspore, which is the product of the sexual process to be presently described, is filled when mature with a red oil, and is enveloped by two membranes, of which the outer one is furnished with stellate prolongations (fig. 431, No. 1). When it begins to vegetate, its endochrome breaks up—first into two halves (No. 2), and then, by successive subdivisions, into numerous segments (Nos. 3, 4), at the same time becoming green towards its margin. These segments, set free by the rupture of their containing envelope, escape in the form of motile zoöspores, which are at first rounded or oval, each having a semi-transparent beak whence proceed two cilia; but they gradually elongate so as to become fusiform (No. 5), at the same time changing their colour from red to green. These move actively for a time, and then, losing their motile power, begin to develop themselves into filaments. The first stage in this development consists in the elongation of the cell, and the separation of the endochrome of its two halves by the interposition of a vacuole (No. 6), and in more advanced stages (Nos. 7, 8) a repetition of the like interposition gives to the endochrome that annular arrangement from which the plant derives its specific name. This is seen at No. 9, *a*, as it presents itself in the filaments of the adult plant; whilst at *b*, in the same figure, we see a sort of frothy appearance which the endochrome comes to possess through the multiplication of the vacuoles. The next stage in the development of the filaments that are to produce the oöspheres consists in the aggregation of the endochrome into definite masses (as seen at No. 10, *a*), which soon become star-shaped (as seen at *b*), each one being contained within a distinct compartment of the cell. In a somewhat more advanced stage (as seen at No. 11, *a*), the masses of endochrome begin to draw

¹ *Ann. des Sci. Nat.*, 4ème sér., Bot., tom. v. 1856, p. 187.

themselves together again; and they soon assume a globular or ovoidal shape (*b*), whilst at the same time definite openings (*c*) are formed in their containing cell-wall. Through these openings the antherozoids developed within other cells gain admission, as shown at No. 12, *d*; and they become absorbed into the before-men-

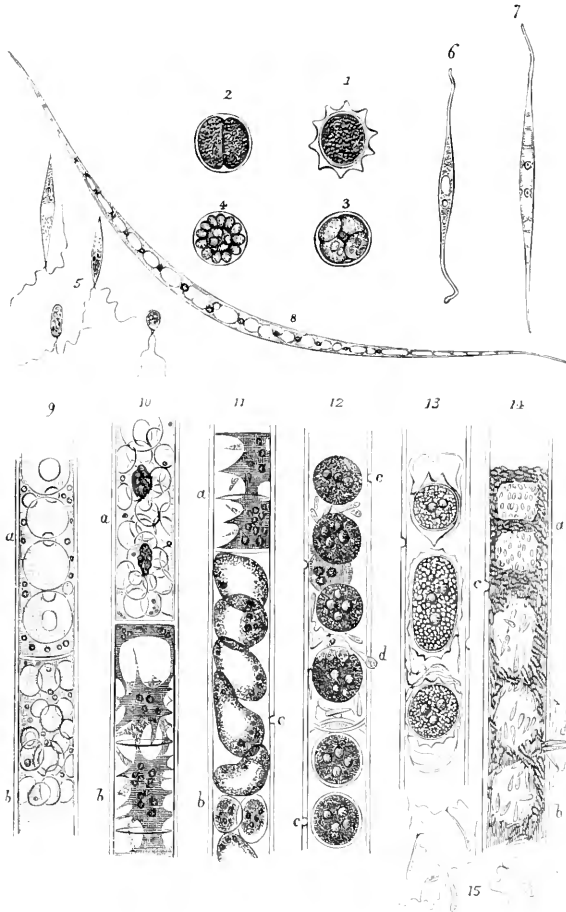

FIG. 431.—Development and reproduction of *Spiræroplea*.

tioned masses, which soon afterwards become invested with a firm membranous envelope, as shown in the lower part of No. 12. These undergo further changes whilst still contained within their tubular parent-cells, their colour passing from green to red; and a second investment is formed within the first, which extends itself into stellate prolongations, as seen in No. 13; so that when set free

they precisely resemble the mature oöspores which we have taken as the starting-point in this curious history. Certain of the cells (as in No. 14), instead of giving origin to oöspores, have their annular collections of endochrome converted into antherozoids, which, as soon as they have disengaged themselves from the mucilaginous sheath that envelopes them, move about rapidly in the cavity of their containing cell (*a*, *b*) around the large vacuoles which occupy its interior, and then make their escape through apertures (*c*, *d*) which form themselves in its wall, to find their way through similar apertures into the interior of the oögones, as already described. These antherozoids are shown in No. 15, as they appear when swimming actively through the water by means of the two cilia which each possesses. The peculiar interest of this history consists in the entire absence of any special organs for the generative process, the ordinary filamentous cell developing oöspheres on the one hand and antherozoids on the other, and in the simplicity of the means by which the fecundating process is accomplished.

The *Ædogoniaceæ* resemble *Confervaceæ* in general aspect and habit of life, but differ from them in some curious particulars. As the component cells of the filaments extend themselves longitudinally, new rings of cellulose are formed successively, and are intercalated into the cell-wall at its upper end, giving it a ringed appearance. Only a single large zoöspore is set free from each cell; and its liberation is accomplished by the almost complete fission of the wall of the cell through one of these rings, a small part only remaining unleft, which serves as a kind of hinge whereby the two parts of the filament are prevented from being altogether separated. Sometimes the zoöspore does not completely extricate itself from the parent-cell: and it may begin to grow in this situation, the root-like processes which it puts forth being extended into the cavity. The zoöspores are the largest known in any class of algae: each has a nucleus, a red 'eye-spot,' and an anterior hyaline spot to which is attached a tuft of cilia visible even before its escape from its mother-cell.

In their generative process, also, the *Ædogoniaceæ* show a curious departure from the ordinary type; for whilst the oöspheres are formed within certain dilated cells of the ordinary filament (fig. 432, A, No. 1), which may be termed oögones, and are fertilised by the penetration of antherozoids (No. 2), these antherozoids are not, in all the species, the immediate product of the sperm-cells of the same or of another filament, but are developed within a body termed an *androspore* (No. 5), which is set free from within a special cell (No. 4), and which, being furnished with a terminal tuft of cilia, and having motile powers, very strongly resembles an ordinary zoöspore. This androspore, after its period of activity has come to an end, attaches itself to the outer surface of an oögone, or of a cell in close proximity to an oögone, as shown at No. 1, *b*; it then develops into a very small male plant, known as a *dwarf male*, consisting of two or three cells; the terminal of these cells is an antherid, from the apex of which a sort of lid drops, as seen in the upper part of No. 1, by which its contained antherozoids (No. 2) are set free; and at the

same time an aperture is formed in the wall of the oögone by which the antherozoid enters its cavity and fertilises its oösphere by becoming absorbed into it. This mass then becomes an oöspore (No. 3), invested with a thick wall of its own, but still retains more or less of the envelope derived from the cell within which it was developed. The offices of these different classes of reproductive bodies are only now beginning to be understood, and the inquiry is one so fraught with physiological interest, and, from the facility of growing these plants in aquaria, can be so easily pursued, that it may be hoped



FIG. 432.—A, Sexual generation of *Edogonium ciliatum*: 1, filament with two oögones in process of formation, the lower one having two androspores attached to its exterior, the contents of the upper oögone in the act of being fertilised by the entrance of an antherozoid set free from the interior of its androspore; 2, free antherozoids; 3, mature oöspore, still invested with the cell-membrane of the parent-filament; 4, portions of a filament bearing special cells, from one of which an androspore is being set free; 5, liberated androspore. B, Branches of *Chætophora elegans*, in the act of discharging ciliated zoöspores, which are seen as in motion on the right.

that the zeal of microscopists will not long leave any part of it in obscurity.

The **Chætophoraceæ** constitute a beautiful and interesting little group of confervoid plants, of which some species inhabit the sea, whilst others are found in fresh and pure water—rather in that of gently moving streams, however, than in strongly flowing currents. Generally speaking, their filaments put forth lateral branches, and extend themselves into arborescent fronds; one of the distinctive characters of the group is afforded by the fact that the extremities of these branches are usually prolonged into bristle-

shaped processes (fig. 432, B). As in many preceding cases, these plants multiply themselves by the conversion of the endochrome of certain of their cells into zoöspores, and these, when set free, are seen to be furnished with either two or four cilia. 'Resting-spores' have also been seen in many species. One of the most beautiful objects under the microscope is *Draparnaldia glomerata*, not uncommon in still water. It consists of an axis composed of a single row of large transparent cells containing but a small quantity of chlorophyll. From this proceed at regular intervals whorls of slender branches, the endochrome of which is deep green, and every branch ends in a delicate hyaline hair of extraordinary length. The mode of reproduction of the *Chatophoraceæ* closely resembles that of the *Confervaceæ*.

The **Batrachospermeæ**, whose name is indicative of the strong resemblance which their beaded filaments bear to frog-spawn, are now ranked as humble fresh-water forms of a far higher, chiefly marine, group of algæ, the *Rhodosperrmeæ*, or red sea-weeds. But they deserve special notice here on account of the simplicity of their structure, and the extreme beauty of the objects they afford to the microscopist (fig. 433). They are chiefly found in water which is pure and gently flowing. 'They are so extremely flexible,' says Dr. Hassall, 'that they obey the slightest motion of the fluid which surrounds them; and nothing can surpass the ease and grace of their movements. When removed from the water they lose all form, and appear like pieces of jelly, without trace of organisation; on immersion, however, the branches quickly resume their former disposition.' Their colour is for the most part of a brownish green, but sometimes they are of a reddish or bluish purple. The central axis of each plant is at first composed of a single filament of large cylindrical cells laid end to end; but this is subsequently invested by other cells, in the manner to be presently described. It bears at pretty regular intervals whorls of short radiating branches, each of which is composed of rounded cells, arranged in a bead-like row, and sometimes subdividing again into two, or themselves giving off lateral branches. Each of the primary branches originates in a little protuberance from the primitive cell of the central axis, precisely after the manner of the lateral cells of *Cladophora glomerata*; as this protuberance increases in size, its cavity is cut off by a septum, so as to render it an independent cell; and by the continual repetition of the process of binary subdivision this single cell becomes converted into a beaded filament. Certain of these branches, however, instead of radiating from the main axis, grow downwards upon it, so as to form a closely fitting investment that seems properly to belong to it. Some of the radiating branches grow out into long transparent bristles, like those of the *Chatophoraceæ*; and within those are produced antherozoids, which, though not endowed with the power of spontaneous movement, find their way to the oöspores contained in other parts of the filaments; and by the fertilisation of the contents of these are produced the somewhat complicated fructifications known as *cystocarps*, placed in the axils of the branches (fig. 433).

A very singular relationship, called by some writers an 'alternation of generations,' exists between *Batrachospermum* and *Chantransia*, a genus of fresh-water algæ previously placed in a totally different section. This relationship was first described by Sirodot,¹ and his observations have since been confirmed by others. The germinating spores of *Batrachospermum* put out, under certain conditions, a kind of filament, known as a *protoneme*, which develops into a *Chantransia*, a non-sexual form of *Batrachospermum*, which can reproduce itself from generation to generation by simple budding, or by means of non-sexual spores, without producing sexual organs. *Chantransia* is especially found in water where very little light reaches it. When more exposed to light it undergoes metamorphosis, and then a branch springs up from the protoneme which is in every respect a *Batrachospermum*, bearing true sexual organs, as above described. This may then go on reproducing itself, or revert to the *Chantransia* form.

The **Coleochætaceæ** are a small order of fresh-water Algae, chiefly represented by the genus *Coleochæte*, which forms minute discs or cushions attached to submerged plants, from $\frac{1}{10}$ to $\frac{1}{4}$ inch in diameter, consisting, in the simplest forms, of a single layer of cells, often arranged in rays proceeding from a common centre. Reproduction takes place non-sexually, by means of zoöspores, or sexually, by the fertilisation of an oögone by motile antherozoids, through the agency of a peculiar tube known as a *trichogyne*, a forecast of the more complicated process which we shall presently meet with in the Floridææ or Rhodosperrmeæ, the highest class of Algae.

Among the highest of the Algae in regard to the complexity of their generative apparatus, which contrasts strongly with the general simplicity of their structure, is the family of **Characeæ**,² some members of which have received a large amount of attention from microscopists on account of the interesting phenomena they exhibit. These plants are for the most part inhabitants of fresh waters, and are found rather in such as are still than in those which are in motion: a few species, however, may be met with in ditches whose waters are rendered salt by communication with the sea. They may be easily grown for the purposes of observation in

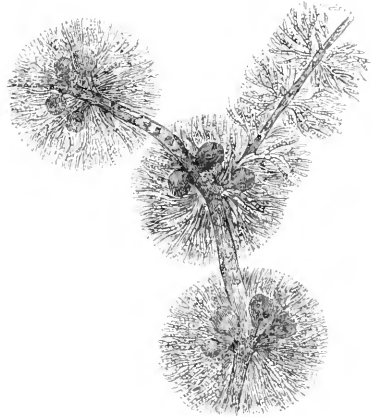

FIG. 433.
Batrachospermum moniliforme.

¹ Sirodot, *Les Batrachospermées*, fo. 1884.

² [Many of the best authorities regard the *Characeæ*, in consequence of their mode of reproduction, as a group of primary character, of equal rank with the Algae, and superior to them in organisation.—ED.]

large glass jars exposed to the light, all that is necessary being to pour off the water occasionally from the upper part of the vessel (thus carrying away a film that is apt to form on its surface), and to replace this by fresh water. Each plant is composed of an assemblage of long tubiform cells placed end to end, with a distinct central axis, around which the branches are disposed at intervals with great regularity (fig. 434, A). In *Nitella* the stem and branches are composed of simple cells, which sometimes attain the length of several inches; whilst in most species of *Chara* each central tube is surrounded by an envelope of smaller ones, which is formed as in *Batrachospermum*, save that the investing cells grow upwards as well as downwards from each node, and meet each other on the stem halfway between the nodes, their ends dovetailing into one another. These investing tubes constitute what is termed the 'cortex' of *Chara*. They are of smaller diameter than the central tube, and are arranged spirally round it, giving the stem a twisted appearance. Each 'node,' or zone from which the branches spring, consists of a single plate or layer of small cells, which, in *Chara*, are a continuation of the cortical layer of the 'internode.' The branches are altogether similar in structure to the primary axis, and terminate in a large elongated pointed cell, which is not covered by the cortex. From the lower part of the stem 'rhizoids' or rooting filaments are put out, which attach the plant to the soil. Some species have the power of secreting carbonate of lime from the water in which they grow, if this be at all impregnated with calcareous matter; and by the deposition of it beneath their tegument they have gained their popular name of 'stoneworts.' The long tubiform cells of *Nitella*, and the terminal uncorticated cells of the branches of *Chara*, afford a very beautiful and instructive display of the phenomenon of *cyclosis*, or rotation of protoplasm in their interior. Each cell, in the healthy state, is lined by a layer of chlorophyll grains, which cover every part, except two longitudinal lines that remain nearly colourless (fig. 434, B); and a constant stream of semi-fluid protoplasm, containing starch grains and chlorophyll granules, is seen to flow over the green layer, the current passing up one side, changing its direction at the extremity, and flowing down the other side, the ascending and descending spaces being bounded by the transparent lines just mentioned. In the young cells the rotation may be seen before this granular lining is formed. The rate of the movement is affected by anything that influences the vital activity of the plant; thus it is accelerated by moderate warmth, whilst it is retarded by cold; and it may be at once checked by a slight electric discharge through the plant. Carried along by the protoplasmic stream are a number of solid particles, which consist of starchy matter, and are of various sizes, being sometimes very small and of definite figure, whilst in other instances they are seen as large irregular masses, which appear to be formed by the aggregation of the smaller particles. The production of new cells for the extension of the stem or branches, or for the origination of new whorls, is not here accomplished by the subdivision of the parent-cell, but takes place by the method of out-

growth (fig. 434, B, *e, f, g, h*), which, as already shown, is nothing but a modification of the usual process of cell-multiplication: in this manner the extension of the individual plant is effected with considerable rapidity. When these plants are well supplied with nutriment, and are actively vegetating under the influence of light, warmth, &c., they not unfrequently develop 'bulbils,' which are little clusters of cells, filled with starch, that sprout from the sides of the central axis, and then, falling off, evolve the long tubiform cells characteristic of the plant from which they were produced. There are also several other non-sexual ways in which these plants

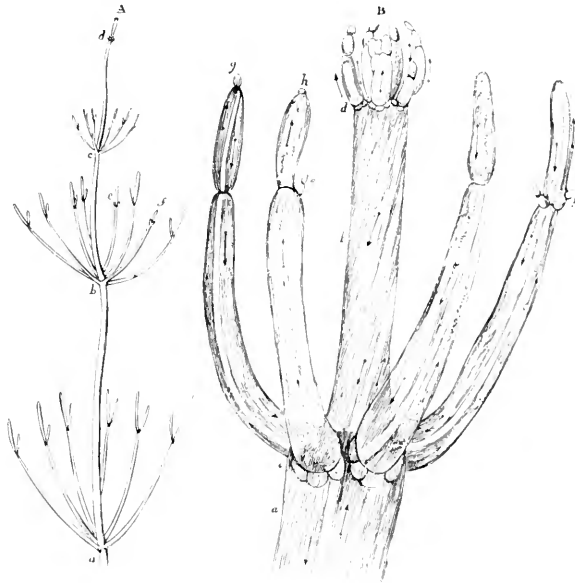

FIG. 434.—*Nitella flexilis*: A, Stem and branches of the natural size: *a, b, c, d*, whorls of branches issuing from the stem; *e, f*, subdivision of the branches. B, Portion of the stem and branches enlarged: *a, b*, joints of stem; *c, d*, whorls; *e, f*, new cells, sprouting from the sides of the branches; *g, h*, new cells sprouting at the extremities of the branches.

are reproduced, but they are peculiar among cryptogams in not producing true spores, either stationary or motile. The *Characeæ* may be multiplied by artificial subdivision, the separated parts continuing to grow under favourable circumstances, and gradually developing themselves into the typical form.

The generative apparatus of *Characeæ* consists of two sets of bodies, both of which grow at the bases of the branches (fig. 435, A, B), either on the same or on different individuals: one set, formerly known as 'globules,' are really *antherids*; whilst the other, known as 'nucules,' contain the *oöspères*, and are true oögones or *archegones*. The globules, which are nearly spherical,

and often of a bright red colour, have an envelope made up of eight triangular plates or 'shields' (B, C), often curiously marked, which encloses a central portion of a light reddish colour; this central portion is principally composed of a mass of filaments rolled up compactly together. From the centre of the inner face of each shield a cylindrical cell termed a *manubrium* projects inwards nearly to the centre of the sphere. The antherid is supported on a short

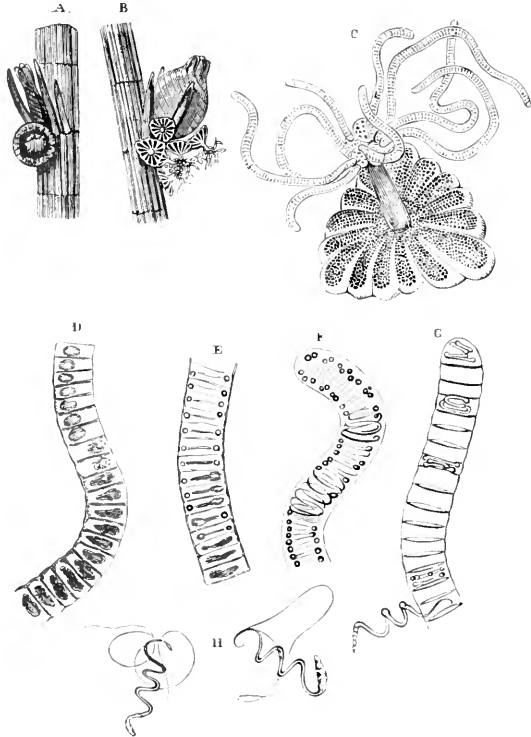

FIG. 435. Generative organs of *Chara fragilis*: A, antherid or globule developed at the base of archegone or nucule; B, nucule enlarged, and globule laid open by the separation of its valves; C, one of the valves, with its group of antheridial filaments each composed of a linear series of cells, within every one of which an antherozoid is formed; in D, E, and F the successive stages of this formation are seen; and at G is shown the escape of the mature antherozoids, H.

flask-shaped pedicel, which also projects into the interior. At the apex of each of the eight manubria is a roundish hyaline cell, called a *capitulum*, and at the apex of each capitulum six smaller cells or 'secondary capitula.' From the centre of each of these secondary capitula grow four long whip-shaped filaments (C), constituting the mass already referred to. The number of these filaments in each antherid is about 200, and each of these filaments divides by

transverse septa into from 100 to 200 small disc-shaped cells, which number, therefore, from 20,000 to 40,000 in each antherid. In every one of these cells there is formed, by a gradual change in its contents (the successive stages of which are seen at D, E, F), an antherozoid, a spiral thread of protoplasm consisting of two or three coils, which, at first motionless, after a time begins to move and revolve within the cell, and at last the cell-wall gives way, and the spiral thread makes its escape (G), partially straightens itself, and moves actively through the water for some time (H) in a tolerably determinate direction, by the lashing action of two long and very delicate cilia with which it is furnished. The exterior of the nucule (A, B) is formed by five or ten spirally twisted tubes that give it a very peculiar aspect: and these enclose a central sac containing protoplasm, oil, and starch grains. Each of these tubes consists, in its lower part, of a very long unsegmented cell: while at its upper part two small cells are segmented off; and these small cells of all the tubes form together the 'crown' of the nucule. When ready for fertilisation the branches of the crown part slightly, forming an open passage or 'neck' down to the central germ-cell or oösphere; and through this canal the antherozoids make their way down to perform the act of fertilisation by becoming absorbed into the substance of the oösphere. Ultimately the nucule, which has now become a hard black body, falls off, and the fertilised germ-cell, or oöspore, gives origin to a new plant after the nucule has remained dormant through the winter.¹

Among those simple Algae whose generative process consists in the 'conjugation' of two similar cells, there are two groups of such peculiar interest to the microscopist as to need a special notice; these are the *Desmidiaceæ* and the *Diatomaceæ*. Both of them were ranked by Ehrenberg and some other naturalists as animalcules; but the fuller knowledge of their life-history and the more extended acquaintance with the parallel histories of other simple forms of vegetation which have been gained during the last twenty years, are now generally accepted as decisive of their vegetable nature.

The *Desmidiaceæ*² are minute plants of a bright green colour growing in fresh water: generally speaking, the cells are independent of each other (figs. 436-439): but sometimes those which

¹ A full account of the *Characeæ* will be found in Prof. Sachs's *Text-Book of Botany*, 2nd English edition, p. 292. Various observers have asserted that particles of the protoplasmic contents of the cells of the *Characeæ*, when set free by the rupture of their cells, may continue to live, move, and grow as independent rhizopods. But the writer is disposed to think that the phenomena thus represented are rather to be regarded as cases of parasitism, the decaying cells of *Nitella* having been found by Cienkowski (*Beiträge zur Kenntniss der Monaden*, in *Arch. f. Mikr. Anat.* Bd. i. 1865, p. 203) to be inhabited by minute, spindle-shaped, ciliated bodies, which seem to correspond with the 'spores' of the *Myxomycetes*, going through an amoeboid stage, and then producing a *plasmode* which, after undergoing a sort of encysting process, finally breaks up into spindle-shaped particles resembling those found in the *Nitella* cells.

² Our first accurate knowledge of this group dates from the publication of Mr. Ralfs's admirable monograph of the British Desmids in 1848. Later information in regard to it will be found in the section contributed by Mr. W. Archer to the fourth edition of Pritchard's *Infusoria*, and in Cooke's *British Desmids*, 1887.

have been produced by binary subdivision from a single parent-cell remain adherent one to another in linear series, so as to form a filament (fig. 440; Plate IX, fig. 3). They are distinguished by two peculiar features, one of these being the semblance of a division of each cell into two symmetrical halves by a 'sutural line,' which is sometimes so decided as to have led to the belief that the cell is really double (Plate VIII, figs. 2, 6), though in other cases it is merely indicated by a slight notch; the other feature is the frequency of projections from the surface, which are sometimes short and inconspicuous, but are often elongated into spines (Plate VIII, fig. 6), presenting a very symmetrical arrangement. These projections are generally formed by the cellulose envelope alone, which possesses an almost horny consistence, so as to retain its form after the discharge of its contents (fig. 436, B, D); while, in other instances, they are formed by a notching of the margin of the cell (Plate IX, fig. 1), which may affect only the outer casing, or may extend into the cell-cavity. The outer coat is surrounded by a very transparent sheet of gelatinous substance, which is sometimes very distinct (as shown in fig. 440; Plate IX, fig. 6); but in other cases its existence is only indicated by its preventing the contact of the cells. Klebs states¹ that in Desmids, as in the other *Conjugatae*, this mucilaginous sheath is composed of two portions—a homogeneous substance which is but slightly refringent, and a portion which consists of minute rods at right angles to the cell-wall. He regards the sheath as entirely independent of the substance of the cell-wall, and as derived from the protoplasmic contents of the cell by diffusion through the cell-wall. The true cell-wall encloses a parietal utricle, which is not always closely adherent to it; and this immediately surrounds the endochrome, which occupies nearly the whole interior of the cell, and in certain stages of its growth is found to contain starch granules. The endochrome and starch grains are arranged symmetrically in the two halves of the cell, often in very beautiful patterns, such as bands or stars.

Many species of desmids have a power of slow movement in the water, the cause of which is not obvious, these organisms being entirely destitute of vibratile cilia. Klebs² describes this movement as being of four kinds, viz.:—(1) a forward movement on the surface, one end of the cell touching the bottom, while the other end is more or less elevated, and oscillates backwards and forwards; (2) an elevation in a direction vertical to the substratum, the free end making wide circular movements; (3) a circular motion, followed by an alternate sinking of the free end and elevation of the other end; and (4) an oblique elevation so that both ends touch the bottom, lateral movements in this position, then an elevation and circular motion of one end, and a sinking again to an oblique or horizontal position. Klebs regards all these movements as due to an exudation of mucilage, and the first two to the formation during the motions of a filament of mucilage by which the desmid is temporarily attached to the bottom, and which gradually

¹ *Untersuchungen aus dem Bot. Inst. Tübingen*, 1886, p. 333.

² *Biologisches Centralblatt*, 1885, p. 353.

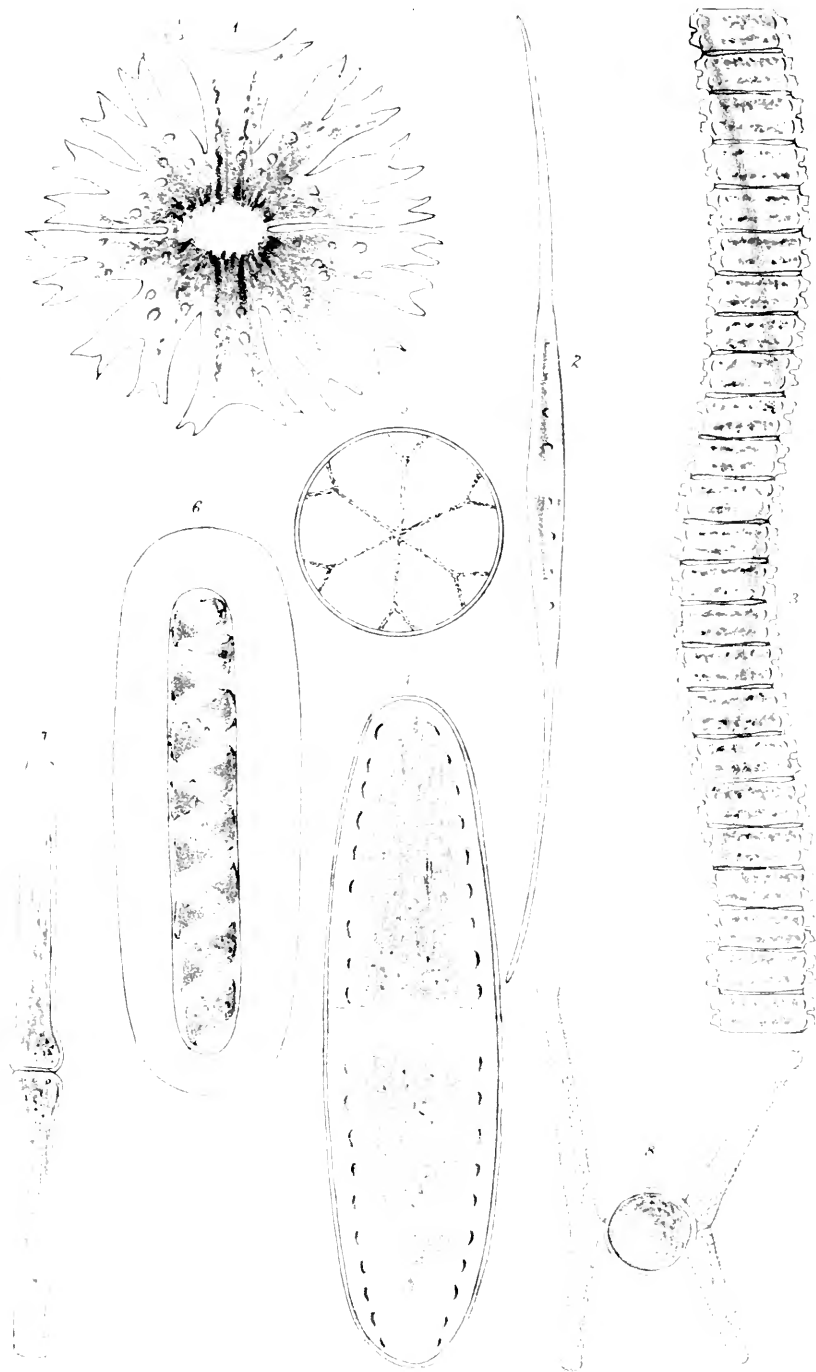

lengthens. The movements of desmids are especially active when they are in the process of dividing. Stahl found that, like the movements of zoöspores, they are affected by light, and always move towards the light.

A 'cyclosis' may be readily observed in many *Desmidiaceæ*, and is particularly obvious along the convex and concave edges of the cell of any vigorous specimen of *Closterium*, with a magnifying power of 250 or 300 diameters (fig. 436, A, B). By careful focusing the flow may be seen in broad streams over the whole surface of the endochrome; and these streams detach and carry with them, from time to time, little oval or globular bodies (A, *b*) which are put forth from it, and are carried by the course of the flow to the transparent spaces at the extremities, where they join a crowd of similar bodies. In each of these spaces (B) a protoplasmic flow proceeds from the somewhat abrupt termination of the endochrome towards the obtuse end of the cell (as indicated by the interior arrows).

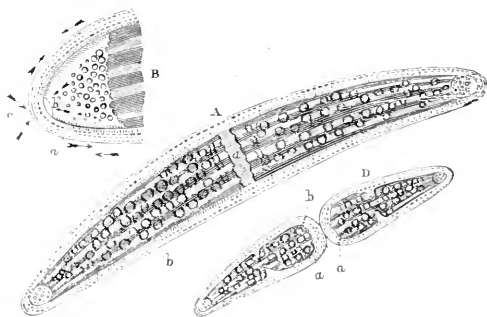

FIG. 436.—Cyclosis in *Closterium laevula*: A, cell showing central separation at *a*, in which the large particles, *b*, are not seen; B, one extremity enlarged, showing the movement of particles in the colourless space; D, cell in a state of division.

and the globules it contains are kept in a sort of twisting movement on the *inner* side (*a*) of the parietal utricle. Other currents are seen apparently external to it, which form three or four distinct courses of particles, passing towards and away from *c* (as indicated by the outer arrows). Another curious movement is often to be witnessed in the interior of the cells of members of this family, which has been described as 'the swarming of the granules,' from the extraordinary resemblance which the mass of particles in active vibratory motion bears to a swarm of bees. It is especially observable in the hyaline terminal portions of the cells of species of *Closterium*, as shown in fig. 436. B. This motion continues for some time after the particles have been expelled by pressure from the interior of the cell; and it appears to be an active form of the molecular movement common to other minute particles freely suspended in fluid. This movement of minute particles affords an instance of the phenomenon known as 'Brownian movement,' and is probably of a purely mechanical nature.

When the single cell has come to its full maturity it commonly multiplies itself by *binary subdivision*; but the plan on which this takes place is often peculiarly modified, so as to maintain the symmetry characteristic of the tribe. In a cell of the simple cylindrical form of those of *Desmidiium* (fig. 440), little more is necessary than the separation of the two halves at the sutural line, and the formation of a partition between them by the infolding of the primordial utricle; in this manner, out of the lowest cell of the filament A, a double cell, B, is produced. But it will be observed that each of the simple cells has a bifid wart-like projection of the cellulose wall on either side, and that the half of this projection, which has been appropriated by each of the two new cells, is itself becoming bifid, though not symmetrically; in process of time, however, the increased development of the sides of the cells which remain in contiguity with each other brings up the smaller projections to the dimensions of the larger, and the symmetry of the cells is restored. In *Closterium* (fig. 436; Plate IX, fig. 2) the two halves of the endochrome first retreat from one another at the sutural line, and a constriction takes place round the cellulose wall; this constriction deepens until it becomes an hourglass-like contraction, which proceeds until the cellulose wall entirely closes round the primordial utricle of the two segments; in this state one half commonly remains passive, whilst the other has a motion from side to side, which gradually becomes more active; and at last one segment quits the other with a sort of jerk. At this time a constriction is seen across the middle of the primordial utricle of each segment, indicating the formation of the sutural band; but there is no division of the cell-cavity, which is that belonging to one of the halves of the original entire cell. The cyclosis, for some hours previously to subdivision, and for a few hours afterwards, runs quite round the obtuse end, *a*, of the endochrome; but gradually a transparent space is formed, like that at the opposite extremity, by the retreat of the coloured layer; whilst at the same time its obtuse form becomes changed to a more elongated and contracted shape. Thus, in five or six hours after the separation, the aspect of each extremity becomes the same, and each half resembles the cell by the division of which it originated.

The process is seen to be performed after nearly the same method in *Staurastrum*, the division taking place across the central constriction, and each half gradually acquiring the symmetry of the original. In such forms as *Cosmarium*, however, in which the cell consists of two lobes united together by a narrow isthmus, the division takes place after a different method; for when the two halves of the outer wall separate at the sutural line, a semi-globular protrusion of the endochrome is put forth from each half; these protrusions are separated from each other and from the two halves of the original cell (which their interposition carries apart) by a narrow neck; and they progressively increase until they assume the appearance of the half-segments of the original cell. In this state, therefore, the plant consists of a row of four segments lying end to end, the two old ones forming the extremes, and the two new ones (which

do not usually acquire the full size or the characteristic markings of the original before the division occurs) occupying the intermediate place. At last the central fission becomes complete, and two bipartite fronds are formed, each having one old and one young segment; the young segment, however, soon acquires the full size and characteristic aspect of the old one; and the same process, the whole of which may take place within twenty-four hours, is repeated ere long. The same general plan is followed in *Microsterias*: but as the small hyaline hemisphere, put forth in the first instance from each half-cell (fig. 437, A), enlarges with the flowing in of the endo-

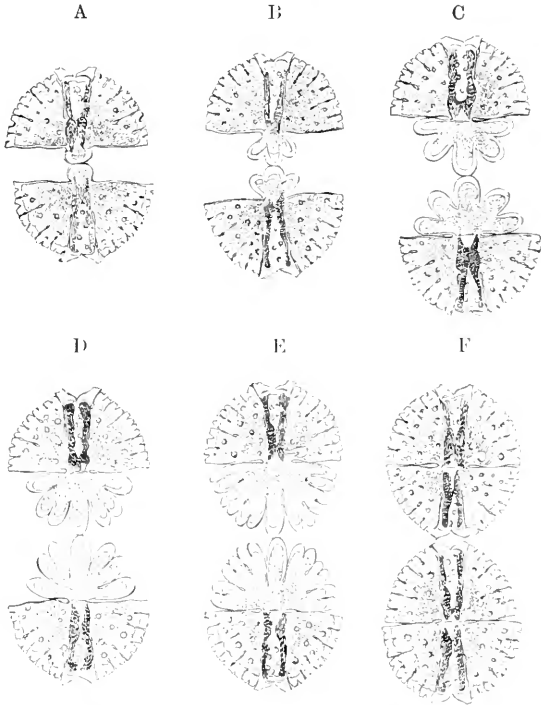

FIG. 437.—Successive stages of binary subdivision of *Microsterias denticulata*.

chrome, it undergoes progressive subdivision at its edges, first into three lobes (B), then into five (C), then into seven (D), then into thirteen (E), and finally at the time of its separation (F) acquires the characteristic notched outline of its type, being only distinguishable from the older half by its smaller size. The whole of this process may take place within three hours and a half. In *Spharozosma* the cells thus produced remain connected in rows within a gelatinous sheath, like those of *Desmidium* (fig. 440); and different stages of the process may commonly be observed in the different parts of any one of the filaments thus formed. In any

such filament it is obvious that the two oldest segments are found at its opposite extremities, and that each subdivision of the intermediate cells must carry them farther and farther from each other. This is a very different mode of increase from that of the *Conferraceae*, in which commonly the terminal cell alone undergoes subdivision, and is consequently the one last formed.

The sexual generative process in the *Desmidiaceae*, which occurs but rarely compared with that of binary division, always consists of an act of 'conjugation.' It commences with the dehiscence of the firm external envelope of each of the conjugating cells, so as to separate it into two valves (fig. 438, C, D; fig. 439, C). The contents of each cell thus set free without any distinct investment blend with those of the other; and a *zygospore* is formed by their union, which soon acquires a truly cellulose envelope.¹ This envelope

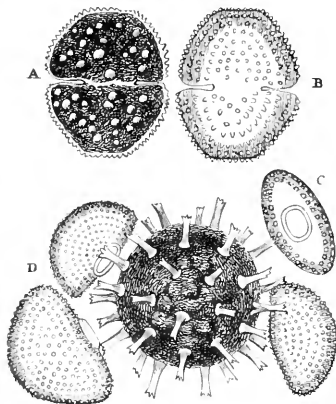

FIG. 438.—Conjugation of *Cosmarium botrytis*: A, mature cell; B, empty cell-envelope; C, transverse view; D, zygospore with empty cell envelopes.

is at first very delicate, and is filled with green and granular contents; by degrees the envelope acquires increased thickness, and its contents become brown or red. Ultimately the envelope becomes differentiated into three layers, of which the innermost and outermost are colourless, while the middle one is firmer and brown. The outer surface is sometimes smooth, as in *Closterium* and its allies (fig. 439; Plate IX, fig. 8); but in *Cosmarium* it becomes granular, tuberculated, or spinous (fig. 438, D; Plate VIII, figs. 1, 4), the spines being sometimes simple and sometimes forked at their extremities. The mode in which conjugation takes place in the filamentous species constituting the *Desmidiæ* proper is, how-

ever, in many respects different. The filaments first separate into their component joints, and when two cells approach in conjugation, the outer cell-wall of each splits or gapes at that part which adjoins the other cell, and a new growth takes place which forms a sort of connecting-tube that unites the cavities of the two cells (fig. 440, D, E). Through this tube the entire endochrome of one cell passes over into the cavity of the other (D); and the two are commingled so as to form a single mass (E), as is the case in many of the *Conjugatae*. The joint which contains the zygospore can scarcely be distinguished at first (after the separation of the empty cell), save by the greater density of its contents; but the proper coats of the zygospore gradually become more distinct, and the enveloping cell-wall disappears.

¹ In certain species of *Closterium*, as in many of the *Diatomacæ*, the act of conjugation gives origin to *two* zygospores.

The subsequent history of the zygospore has been followed out in the case of *Cosmarium botrytis*. After remaining at rest for a considerable time, it germinates by the bursting of the two outer coats, the protoplasmic contents escaping while still enclosed in the innermost coat. In this body the protoplasm and endochrome are already divided into two halves, which contract somewhat, and the whole becomes enveloped in a new cell-wall. A constriction has, in the meantime, made its appearance between the two halves, which are of somewhat unequal size, and thus the new desmid is formed.

The subdivision of this family into genera, according to the method of Mr. Ralfs ('British Desmidiæ'), as modified by Mr. Archer (Pritchard's 'Infusoria'), is based in the first instance upon the connection or disconnection of the individual cells, two groups being thus formed, of which one includes all the genera whose cells, when multiplied by binary division, remain united into an elongated filament: whilst the other and much larger one comprehends all those in which the cells become separated by the completion of the fission. The further division of the filamentous group, in which the zygospores are always globular and smooth (Plate IX, fig. 8), is based on the fact that in one set of genera the joints are many times longer than they are broad, and that they are neither constricted nor furnished with lateral teeth or projections: whilst in the other set

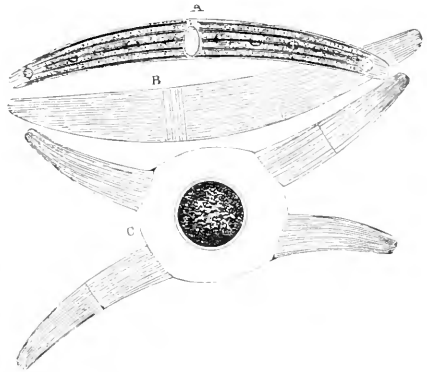

FIG. 439.—Conjugation of *Closterium striolatum*: A, ordinary cell; B, empty cell; C, two cells in conjugation, with zygospore.

(fig. 440; Plate IX, fig. 3) the length and breadth of each joint are nearly equal, and the joints are more or less constricted, or have lateral teeth or projecting angles, or some other figure; and it is for the most part upon the variations in these last particulars that the generic characters are based. The solitary group presents a similar basis for primary division in the marked difference in the proportions of its cells, such elongated forms as *Closterium* (figs. 436, 439; Plate IX, fig. 2), in which the length is many times the breadth, being thus separated from those in which, as in *Micrasterias* (fig. 437; Plate IX, fig. 1), *Cosmarium* (fig. 438; Plate VIII, fig. 2), and *Staurastrum* (Plate VIII: figs. 5, 6, 10), the breadth more nearly equals the length. In the former the zygospores are smooth, whilst in the latter they are very commonly spinous (Plate VIII, figs. 1, 4) and are sometimes quadrate. In this group the chief secondary characters are derived from the degree of

constriction between the two halves of the cell, the division of its margin into segments by incisions more or less deep, and its extension into teeth or spines.

The *Desmidiaceae* are not found in running streams, unless the motion of the water be very slow, but are to be looked for chiefly in standing waters. Small shallow pools that do not dry up in summer, especially in open, exposed situations, such as boggy moors, are most productive. The larger and heavier species commonly lie at the bottom of the pools, either spread out as a

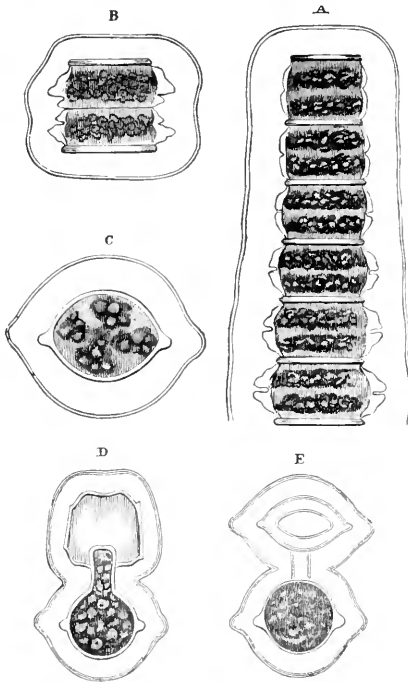

FIG. 440.—Binary subdivision and conjugation of *Desmidium cylindricum*: A, portion of filament, surrounded by gelatinous envelope: B, dividing cell; C, single cell viewed transversely; D, two cells in conjugation; E, formation of zygospore.

thin gelatinous stratum, or collected into finger-like tufts. By gently passing the fingers beneath these they may be caused to rise towards the surface of the water, and may then be lifted out by a tin box or scoop. Other species form a slimy stratum floating on the surface of bog-pools, or a greenish or dirty cloud upon the stems and leaves of other aquatic plants; and these also are best detached by passing the hand beneath them, and 'stripping' the plant between the fingers, so as to carry off upon them what adhered to it. If, on the other hand, the bodies of which we are in search should be much diffused through the water, there is no other course than to take it up in large quantities by the box or scoop and to separate them by straining through a piece of linen. At first, nothing appears on the linen but

a mere stain or a little dirt; but by the straining of repeated quantities a considerable accumulation may be gradually made. This should then be scraped off with a knife, and transferred into bottles with fresh water. If what has been brought up by hand be richly charged with these forms, it should be at once deposited in a bottle; this at first seems only to contain foul water; but by allowing it to remain undisturbed for a little time, the desmids will sink to the bottom, and most of the water may then be poured off, to be replaced by a fresh

supply. If the bottles be freely exposed to solar light, these little plants will flourish, apparently as well as in their native pools; and their various phases of multiplication and reproduction may be observed during successive months or even years. If the pools be too deep for the use of the hand and the scoop, a collecting-bottle attached to a stick may be employed in its stead. The ring-net may also be advantageously employed, especially if it be so constructed as to allow of the ready substitution of one piece of muslin for another. For, by using several pieces of previously wetted muslin in succession, a large number of these minute organisms may be separated from the water; the pieces of muslin may be brought home folded up in wide-mouthed bottles, either separately or several in one, according as the organisms are obtained from one or from several waters; and they are then to be opened out in jars of filtered river water and exposed to the light, when the desmids will detach themselves.

The **Diatomaceæ** or **Bacillariaceæ**, like the Desmidiaceæ, are *simple cells*, having a firm external coating, within which is included an endochrome whose superficial layer constitutes a 'parietal utricle,' but their external coat is consolidated by *silex*, the presence of which is one of the most distinctive characters of the group, and gives rise to the peculiar surface-markings of its members. It has been thought by some that the solidifying mineral forms a distinct layer exuded from the exterior of the cellulose wall; but there seems good reason for regarding that wall as itself interpenetrated by the silex, since a membrane bearing the characteristic surface-markings is found to remain after its removal by hydrofluoric acid. The endochrome of diatoms consists, as in other plants, of a viscid protoplasm, in which float the granules of colouring matter. In the ordinary condition of the cell these granules are diffused through it with tolerable uniformity, except in the central spot, which is occupied by a *nucleus*; round this nucleus they commonly form a ring, from which radiating lines of granules may be seen to diverge into the cell-cavity. Instead of being bright green, however, the endochrome is a yellowish brown. The principal colouring substance appears to be a modification of ordinary chlorophyll; it takes a green or greenish-blue tint with sulphuric acid, and often assumes this hue in drying; but with it is combined in greater or less proportion a yellow colouring matter termed *diatomin*, which is very unstable in the light and fades in drying. At certain times, oil-globules are observable in the protoplasm; these seem to represent the starch-granules of the *Desmidiaceæ* and the oil-globules of other protophytes. A distinct movement of the granular particles of the endochrome, closely resembling the cyclosis of the *Desmidiaceæ*, has been noticed by Professor W. Smith in some of the larger species of *Diatomaceæ*, such as *Sarirella biseriata*, *Nitzschia scalaris*, and *Campylodiscus spiralis*, and by Professor Max Schultze in *Coscinodiscus*, *Biddulphia*, and *Rhizosolenia*; but this movement has not the regularity so remarkable in the preceding group.

The name of the class is derived from the ease with which the

parts separate from each other. This is well seen in the genus *Diatoma*, formed of rectangular individual *frustules*, where the arrangement resulting from the principle of lateral union causes them to develop into filaments or zigzag chains, the frustules remaining perfectly distinct, and united only by a small isthmus or cushion at the angles. A similar cohesion at the angles is seen in the allied genus *Grammatophora* (fig. 452), in *Isthmia* (fig. 457), and in many other diatoms; in *Biddulphia* (fig. 445) there even seems to be a special organ of attachment at these points. In some diatoms, however, the frustules produced by successive acts of binary subdivision habitually remain coherent one to another, and thus are produced filaments or clusters of various shapes. Thus it is obvious that when each frustule is a short cylinder, an aggregation of such cylinders, end to end, must form a rounded filament, as in *Melosira* (fig. 444); and, whatever may be the form of the sides of the frustules, if they be parallel one to the other a *straight* filament will be produced, as in *Achnanthes* (fig. 461). But if, instead of being parallel, the sides be somewhat inclined towards each other, a *curved* band will be the result; this may not continue entire, but may so divide itself as to form fan-shaped expansions, as those of *Licmophora flabellata* (fig. 450); or the cohesion may be sufficient to occasion the band to wind itself (as it were) round a central axis, and thus to form, not merely a complete circle, but a spiral of several turns, as in *Meridion circulare* (fig. 448). Many diatoms, again, possess a *stipe*, or stalk-like appendage, by which aggregations of frustules are attached to other plants, or to stones, pieces of wood, &c.; and this may be a simple foot-like appendage, as in *Achnanthes longipes* (fig. 461), or it may be a composite plant-like structure, as in *Licmophora* (fig. 450), *Gomphonema* (fig. 462), and *Mastogloia* (fig. 465). Little is known respecting the nature of this stipe; it is, however, quite flexible, and may be conceived to be an extension of the cellulose coat, unconsolidated by silex, analogous to the prolongations which have been seen in the *Desmidiaceæ*, and to the filaments which sometimes connect the cells of the *Palmellaceæ*. Some diatoms, again, have a mucous or gelatinous investment, which may even be so substantial that their frustules lie—as it were—in a bed of it, as in *Mastogloia* (figs. 465 B, 466), or may form a sort of tubular sheath to them, as in *Schizonema* (fig. 464). In a large proportion of the group, however, the frustules are always met with entirely *free*, neither remaining in the least degree coherent one to another after the process of binary subdivision has once been completed, nor being in any way connected, either by a stipe, or by a gelatinous investment. This is the case, for example, with *Triceratium* (fig. 442), *Pleurosigma* (Plate I, figs. 1, 2), *Actinocyclus*, *Actinoptychus* (fig. 467), *Arachnoidiscus* (Plate XI), *Campylodiscus* (fig. 454), *Sarirella* (fig. 453), *Coscinodiscus* (Plate I, figs. 3, 4, fig. 455), *Heliopelta*, and many others. The solitary discoidal forms, however, when obtained in their living state, are commonly found cohering to the surface of aquatic plants.

We have now to examine more minutely into the curious structure of the silicified casing which encloses every diatom-cell or

frustule and the presence of which imparts a peculiar interest to the group; not merely on account of the elaborately marked pattern which it often exhibits, but also through the perpetuation of the minutest details of that pattern in the specimens obtained from fossilised deposits. This silicified casing is usually formed of two perfectly symmetrical valves united to one another by means of two embracing rings which constitute the connecting zone or *girdle*, and thus exactly represent a minute box which serves for the reproduction of the species. This process is known as the encystment, and is not uncommon, especially amongst the *Naviculeæ*, frustules being frequently found amongst them open from the separation of the two valves, showing the two rings covering each other, as the lid of a box may cover a portion of the box itself.

The following definitions of terms used in describing the siliceous envelope of diatoms have been proposed by the late eminent diatomologist, Mr. J. Deby. The radiating lines (called by some 'costæ' or 'canaliculi') starting from the outer margin of the valve, and converging towards the interior of the disc, are *rays* or marginal rays. They may be simple, which is most usual; or moniliform, *i.e.* composed of a single or double row of 'beads;' or infundibuliform, having the outline of a funnel with a long outlet; the upper broad portion is the 'funnel,' the slender part the 'stem.' The central portion of the valve inside the internal termination of the rays is the *area*; it may be smooth and hyaline, or it may be striate, or simply punctate or dotted, the dots forming regular lines or else being irregularly scattered. If this area becomes reduced to a median linear blank space, or to a simple elongated line, it is known as the *raphe* or *pseudo-raphe*.

Dr. O. Müller proposes the term *epitheca* for the overlapping half-cell of the diatom, the underlapping half-cell being the *hypotheca*; for the girdle-bands he proposes the term *pleura*.

In describing diatoms, the aspect in which the girdle is turned towards the observer is known as the 'front' or 'girdle' view; that in which the surface of the valve is turned towards the observer is the 'side' or 'valve' view.

It is not correct to designate the line shown in the front view of the outer ring as the line of 'suture,' since the *suture* is the line of meeting bounding two surfaces placed on the same plane. The form resulting, however, varies widely in different diatoms; for sometimes each valve is hemispherical, so that the cavity is globular; sometimes it is a smaller segment of a sphere resembling a watch-glass, so that the cavity is lenticular; sometimes the central portion is completely flattened and the sides abruptly turned up, so that the valve resembles the cover of a pill-box, in which case the cavity will be cylindrical; and these and other varieties may co-exist with any modifications of the contour of the valves, which may be square, triangular (fig. 442), heart-shaped (fig. 454, A), boat-shaped (fig. 453, A), or very much elongated (fig. 449), and may be furnished (though this is rare among diatoms) with projecting outgrowths (figs. 458, 459). Hence the shape presented by the frustule differs completely with the aspect under which it is seen. In all instances, the

frustule is considered to present its 'front' view when its line of meeting is turned towards the eye, as in fig. 453, B, C; whilst its 'side' view is seen when the centre of either valve is directly beneath the eye (A). Although the two valves meet along the line of junction in those newly formed frustules which have been just produced by binary subdivision (as shown in fig. 445, A, e), yet, as soon as they begin to undergo any increase, the valves separate from one another; and by the silicification of the cell-membrane thus left exposed a pair of *hoops* is formed, each of which is attached by one edge to the adjacent valve, while the other edge is free.¹ As will be presently explained, one of the valves is always older than the other; and the hoop of the older valve partly encloses that of the younger, just as the cover of a pill-box surrounds the upper part of the box itself.² As the newly formed cell increases in length, separating the valves from one another, both hoops increase in breadth by additions to their free edges, and the outer hoop slides off the inner one, until there is often but a very small 'overlap.' As growth and binary division are continually going on when the frustules are in a healthy vigorous condition, it is rare to find a specimen in which the valves are not in some degree separated by the interposition of the hoops.

The impermeability of the silicified casing seems to render necessary the existence of special apertures through which the surrounding water may come into communication with the contents of the cell. Some have believed that they have seen such apertures along the so-called 'line of suture' of the disc-shaped diatoms, and at the extremities only of the elongated forms. Ehrenberg, followed by Kützing, has interpreted as apertures or ostioles the central and terminal nodules of the *Nariculea*, *Cymbellea*, and similar forms; but this view is more generally regarded as incorrect. We have, in fact, no positive demonstration of the existence of special apertures communicating between the outside and the inside of the cell; and we are compelled to have recourse, on this point, to hypothesis. It is, however, certain that the diatom-cell is always composed of at least two valves, between which the possibility of such a communication must necessarily be admitted, or at least the existence of endosmotic and exosmotic currents in the liquids. In the encysted forms we have ascertained also the existence of an interval between the two rings, although it may be very minute; while *Naricula* has been sometimes seen with the valves actually separated.

¹ This refers to those diatoms in which the process of binary subdivision is possible; but this, as will be seen presently, is not the case in many genera. [Ed.]

² This was long since pointed out by Dr. Wallich in his important memoir on the 'Development and Structure of the Diatom-valve' (*Transact. of Microsc. Soc.* n.s. vol. viii. 1860, p. 129); but his observation seems not to have attracted the notice of diatomists, until in 1877 he called attention to it in a more explicit manner (*Monthly Microsc. Journ.* vol. xvii. p. 61). The correctness of his statement has been confirmed by the distinguished American diatomist, Prof. W. Hamilton Smith; but as it has been called in question by Mr. J. D. Cox (*American Journal of Microscopy*, vol. iii. 1878, p. 100), who asserts that in *Isthmia* there are three hoops—two attached to the two valves, and the third overlapping them both at their line of junction—the Author has himself made a very careful examination of a large series of specimens of *Isthmia* and *Biddulphia*, the result of which has fully satisfied him of the correctness of Dr. Wallich's original description.

The nature of the delicate markings with which almost every diatom frustule is beset has been one of the most interesting inquiries of the students of these forms since the introduction of the homogeneous, and especially the apochromatic, objectives; and it cannot be doubted that certain peculiarities of structure have been demonstrated which were never before seen. In the present state of the theory and practice of microscopy it would be extremely unwise to give absolute adhesion to any present interpretation of what is now held by some students of diatom structure of no mean repute and of unrivalled manipulative skill to be the absolute structure of some of the larger forms.

Thus, concerning the group *Coscinodisceæ*, representing the most beautiful of the discoid forms of the whole group of *Diatomaceæ*, we represent in Plate I, fig. 3, a photo-micrographic image of *Coscinodiscus asteromphalus* magnified 110 diameters. But in fig. 441 the *areolæ* of this diatom are seen under great magnification with recent powers. It is contended that the diatom, although consisting of a single siliceous membrane, has a double structure, viz. coarse and fine areolations, the latter within the former; and there appears little reason to doubt this. The coarse areolations are for the most part circular in outline, and the intervening silix is thick. Inside these areolations is an extremely delicate perforated membrane, the outer row of whose perforations are larger than the rest. From the very delicacy of this membrane, and its consequent easy fracture, it is often wanting. In Plate I, fig. 4, we present a photo-micrograph of the same object magnified 2,000 diameters.

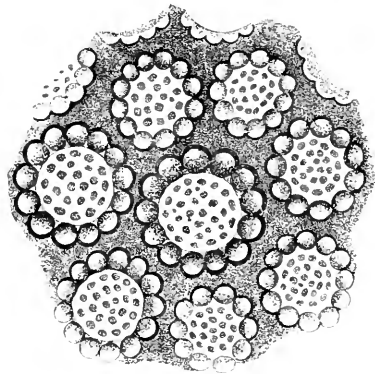

FIG. 441. — Magnification of 'ultimate structure' of *Coscinodiscus asteromphalus*, from a drawing by Messrs. Nelson and Karop (*Journ. Quækett Club*, vol. ii. ser. ii. p. 269).

In *Isthmia nerrosa*, a side and front view of which are seen in fig. 457, a similar construction is discoverable. In this diatom the coarse areolations are very large and the silix correspondingly thick; but the inner membrane is excessively thin and delicate. The perforations are large and irregular in shape around the margin, but small and circular in the centre. In fig. 443 the form of areolations is shown, and a broken membrane seen, with the fracture passing through the perforations.¹

Not less interesting is the beautiful form *Aulacodiscus Kittonii*; a photo-micrograph of this magnified 270 diameters is seen in Plate I, fig. 5; while a small portion of the centre of a kindred form,

¹ Note on the finer structure of certain diatoms, E. M. Nelson and G. C. Karop, *Journ. Quækett Club*, vol. ii. ser. ii. p. 269.

A. Sturtii, magnified 2,000 times, is shown in fig. 6 in the same plate.

The 'beaded' appearance of diatom-valves is so universal in all those which have been examined, that it must be regarded as common to all diatoms, although this is not yet absolutely proved. But, while it is admitted that the beading of the valves may be common to all diatoms, it cannot be regarded as proved that the siliceous envelope is composed of globular particles of silicex arranged

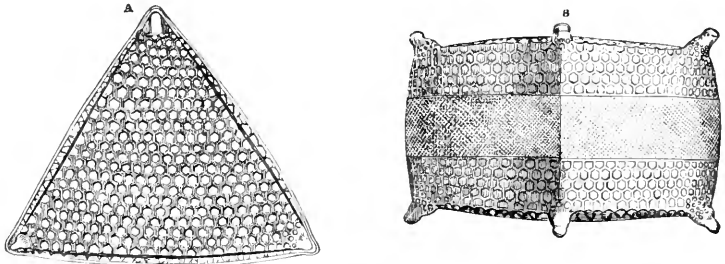

FIG. 442. —*Triceratium furus*: A, side view; B, front view.

in regular rows; while the variety in the size and arrangement of these particles shows that they are correlated with the vital processes of the organisms, and afford characters for the discrimination of the species. The nature of these granules, their size, and the mode in which they are arranged have from the earlier days of microscopy rendered diatoms of special value as 'test-objects.' This appearance has led to the use, in speaking of diatoms, of the incorrect terms 'transverse,' 'longitudinal,' or 'oblique striae,' these being in truth simply the intervals which separate the boundaries of the 'beads,' apertures, or their equivalents, whatever they may ultimately prove to be; and this is clearly seen when they are observed with objectives of sufficient numerical aperture and proportional power.

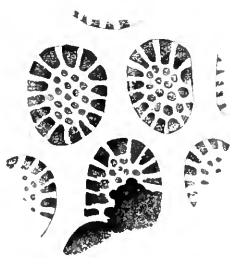
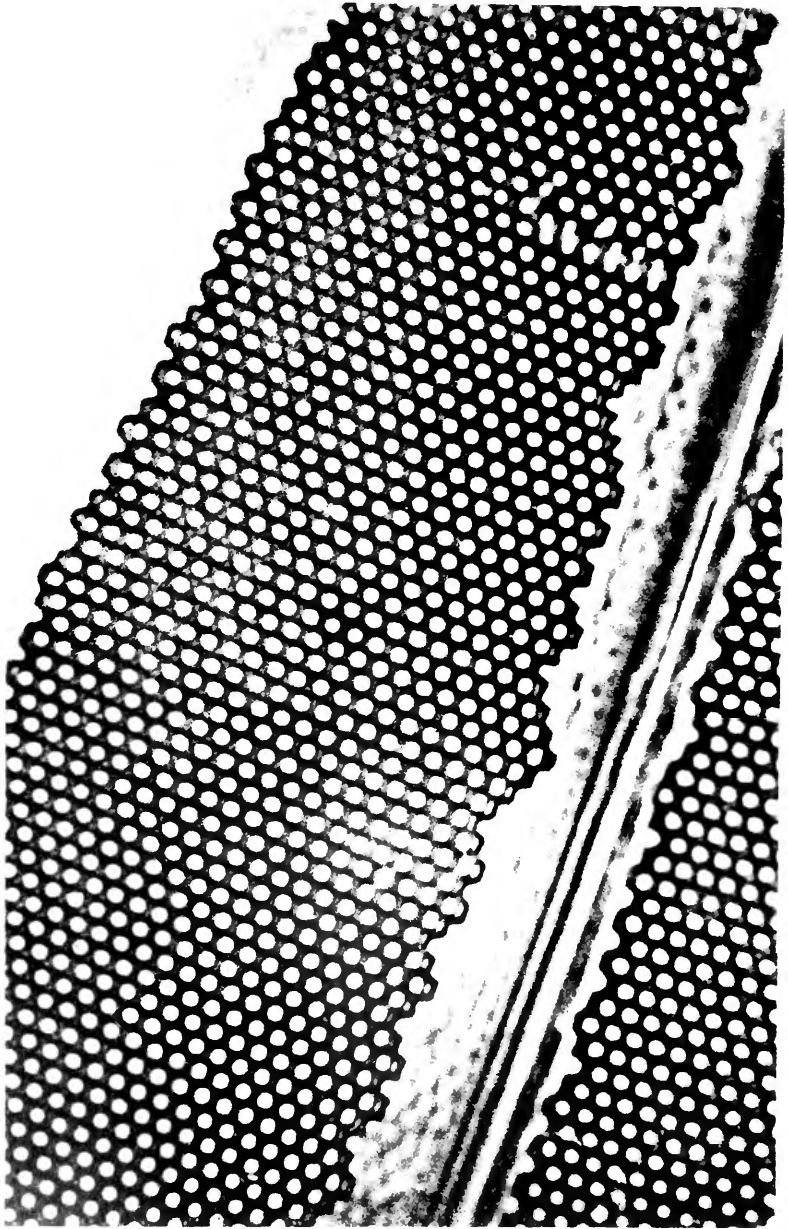

FIG. 443.—Arcolations in *Isthmia verrucosa*.

Pleurosigma angulatum is one of the most commonly employed test-objects, and at the same time one of the most reliable, its remarkable constancy rendering it especially valuable for this purpose; while, on the contrary, *Amphipleura pellucida* is extremely variable, and is, as it were, the torment of microscope-makers and rival diatom-resolvers, who do not take into account the variability of this type, forgetting, in fact, that one *A. pellucida* may be extremely fine, and another, being in truth a varietal form, may be nearly as coarse as *Naricula rhomboides*. The new apochromatic objectives, and the compensating eye-pieces, both for the eye and for projection, constructed by Zeiss, of Jena, have brought about such progress in micrography that the image of *P. angulatum* appears to some minds



PLEUROSIGMA ANGULATUM.

Magnified 4900 diams.

11. m. c Photo Micrograph by Dr. R. Zeiss taken with the 2 m m. Apochromatic Objective N. A. 1.30 and projection eyepiece 4.

to leave no doubt as to the details of its structure. If we closely examine the photographic image of a portion of *P. angulatum*, produced under a magnification of 4,300 diameters, and shown in Plate X, taken from a photograph by Dr. Zeiss, it will, in the majority of cases, leave perhaps little doubt that the valves are covered by the beads or apertures in a decussate arrangement. We have, in the judgment of Comte Castracane, to do here with 'beads' and not with 'cavities.' But, from the recent advances of our knowledge, this by no means follows; they may with high probability be considered perforations in the siliceous wall of the frustule. This is, indeed, placed almost in the form of a demonstration by the interesting fact that Mr. C. Haughton Gill succeeded in *filling up* the 'dots' or 'pearls' of the *Navicula* and the secondary markings of the discoid and other forms, so as to give evidence that the filling must be deposited in cavities. It is done by soaking clean diatoms in a solution of subnitrate of mercury until their markings are filled with it; then they are immersed in sulphide of ammonium; a double decomposition takes place, by which black insoluble sulphide of mercury is produced, and left in the minute cavities in which it certainly appears to be formed. By observing the lines of fracture, which always follow the interval between two rows of 'beads,' there will be much suggestion given to the observer on this subject. Comte Castracane, referring to Plate X, asked, 'Would it have been possible to have seen these pearl-like objects isolated, if, instead of beads, we had had apertures or depressions?' We can only reply that misinterpretation on such a subject is so possible that it is only by employing all the aids to interpretation which ingenuity can place within our reach, that we can ever be certain as to our visual interpretation of these minute phenomena. On the other hand, the areolated valves of *Triceratium fucus* (fig. 442) present a line of fracture which traverses indifferently the hexagonal areola and the lines in relief which connect them.

Dr. Van Heurck has been able to employ the new lens made by Abbe, having a numerical aperture of 1.63, upon his special subject, the *Diatomacea*. He concludes that diatom valves consist of two membranes or thin films and of an intermediate layer, the *latter being pierced with openings*. The outer membrane is delicate, and may be easily destroyed by acids, friction, and the several processes of 'cleaning.' When the openings or apertures of this interior portion are arranged in alternate rows they assume the hexagonal form; when in straight rows then the openings are square or oblong.

It is, however, due to Mr. T. F. Smith, who worked at this subject for years, to say that he long maintained this view, and has presented skilful photo-micrographs in support of his contention. In Plate I, fig. 1, we have a photograph of his, showing the *inside* of a valve of *P. angulatum* magnified 1,750 diameters, and exhibiting the 'postage-stamp' fracture; while in fig. 2, in the same plate, we have the *outside* of *P. angulatum*, showing a different structure; and Mr. Smith has abundant evidence of the existence of what he has so long maintained.

By using the new lens of the great aperture of 1.63, Dr. Van Heurck has produced some remarkable photo-micrographs, which

rather confirm these general inferences than present any new data of knowledge concerning the diatoms. By his great courtesy we have been favoured with a phototype plate prepared by Dr. Van Heurck from his own photo-micrographs, and the reader will be enabled to study these in Plate XI, of which a full description is given in the earlier part of this treatise, giving descriptions of the plates. He has further enhanced the plate by giving in fig. 7 a photo-micrograph of Nobeit's nineteenth band.

Diatoms, like other organisms already described, are reproduced by conjugation, and multiply by autofission or division. Reproduction is necessary to every organism, while multiplication by fission belongs only to certain organic types. In the early days of the study of diatoms, it would appear that even that distinguished observer William Smith had at least not a clear idea of the encyst-

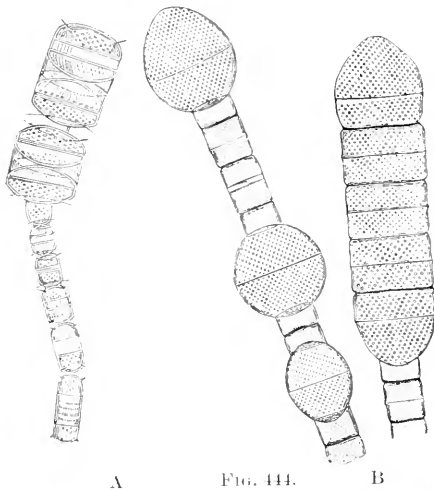

A
Melosira subflexilis.

FIG. 444.

B
Melosira varians.

ing of the *frustule* or individual diatom, which implies the existence of the two valves and of the double girdle or zone or connecting ring projecting from each valve in a direction at right angles to its plane. Hence, instead of finding, as a result of fission, a progressive diminution of the diameter of the frustules, Mr. Smith speaks of their increase, of which he is unable to offer any explanation. The fact that in *Melosira subflexilis* (fig. 444, A) and *M. varians* (fig. 444, B) large and small frustules are seen united

in rows, ought to be sufficient to show that they are dependent not only on binary subdivision, but also on the special conditions of evolution of the new frustule, by which it is able to increase materially in size. This power of diatoms to expand their siliceous coatings has therefore been denied by some, who are induced to maintain this necessary consequence of the division of encysted frustules, viz. the progressive decrease in size of the young frustules, which would thus reach the smallest possible dimensions. This has led Pfitzer¹ to imagine that when diatoms have reached their smallest possible dimensions by repeated binary division, the process of conjugation takes place between them, resulting in the formation of an *auospore*, capable of reproducing two sporangial frustules of considerably larger size, which would again give rise, by fission, to a new series of diminishing frustules.

¹ *Untersuchungen über Bau u. Entwicklung der Bacillarien*, 8vo, Bonn, 1871.

Fig. 1.

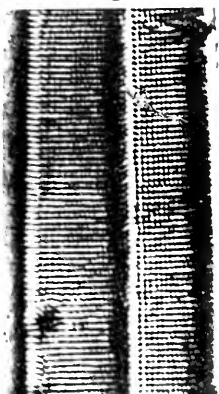

Fig. 2.

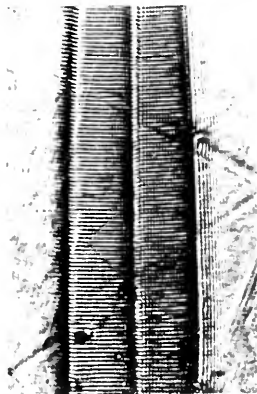

Fig. 3.

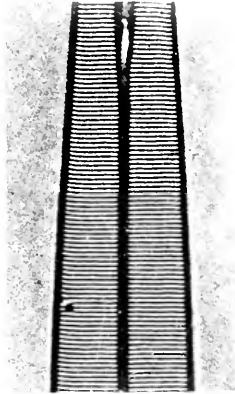

Fig. 4.

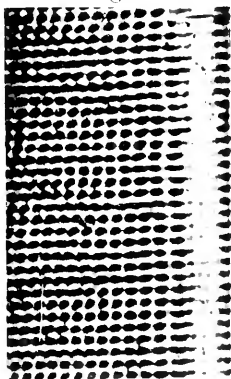

Fig. 5.

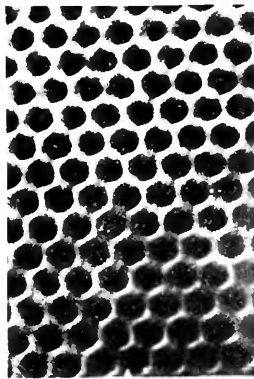

Fig. 6.

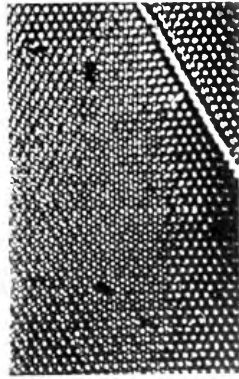

Fig. 7.

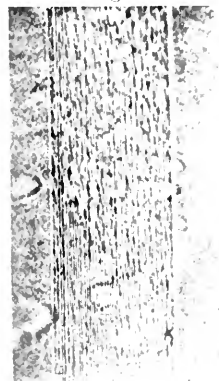

Fig. 8.

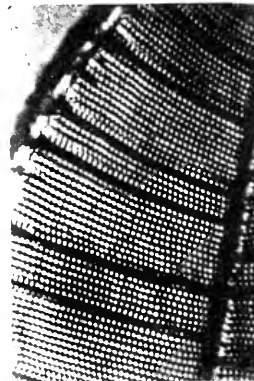
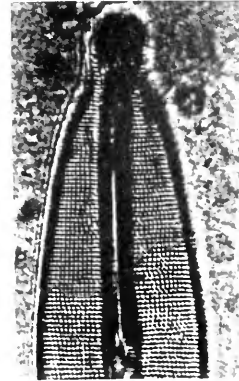

Fig. 9.



Dr. H. Van Heurck, phot.

Collotype Ptg. Co., 282 High Holborn, W.C

TEST OBJECTS FOR THE MICROSCOPE.

Objective by C. Zeiss, N.A. 1.60; Eyepiece 12. Monochromatic illumination by sunlight.

until these again reach their minimum size. This theory has, in the judgment of Count Castracane, deceived many botanists, from the idea that it was founded on actual observation, and has at the same time been in harmony with the natural tendency to generalisation, in attributing to the whole family of diatoms that faculty of division which has been regarded as the universal property of the vegetable cell. The 'auxospore' theory rests on the supposed inability of the siliceous walls of diatoms to expand; and implies, secondly, the idea that all diatoms are capable of binary subdivision; and thirdly, that there is no mode of reproduction except by auxospores. That the siliceous walls of diatoms are capable of distension seems to result from the examples already given of *Melosira subflexilis* and *M. varians*, as also from some other species in which there may often be observed a sudden variation in diameter in frustules united together in a row. But the power of increase in size of the siliceous diatom-cell is evidently proved by the sporangial frustules of *Orthosira Dickiei*,¹ where, in the chain of cylindrical frustules of the same diameter, the sporangial frustule is dilated in its equatorial axis, but much more so in its polar axis, pushing back the base of the next cell and forcing it up so as to occupy the whole cell-cavity, and sometimes even that of the next frustule. The exactness and fidelity of the figure given in Smith's 'Synopsis,' besides being guaranteed by the authority of the distinguished author and by the signature of the celebrated artist Tuffen West, Count Castracane was able to confirm by a magnificent preparation of these diatoms in which are a number of sporangial frustules. The auxospore theory supposes the fact that all diatoms are capable of binary subdivision, since the auxospore is understood, according to Pfitzer, to provide for the progressive decrease in size of the frustules, with the production of larger sporangial frustules, destined to commence a new descending series. But binary subdivision cannot take place in genera with unequal valves, as it is universally acknowledged that the two new valves which are formed in the process of binary subdivision must stereotype themselves on the old valves; and for this reason the process cannot take place in those genera in which the axes cross one another, like *Campylodiscus*, or in those in which the two valves, although equal, yet constantly unite in such a way that the similar parts alternate with one another, as may be seen in *Asterolampra*. That it is impossible for binary subdivision to take place in these three classes of forms, is confirmed by the fact that, notwithstanding that there are recorded not less than seventy-five observations of the process of division in them, not one affords an exception to the rule given above.

Where multiplication by binary subdivision occurs among the *Diatomaceæ*, it takes place on the same general plan as in the *Desmidiaceæ*, but with some modifications incident to peculiarities of the structure of the former group. The first stage consists in the elongation of the cell, and the formation of a 'loop' adherent to

¹ See Castracane, 'The Theory of the Reproduction of Diatoms,' *Atti dell' Accad. Pontif. dei Nuovi Lincei*, May 31, 1874; and 'New Arguments to prove that Diatoms are reproduced by means of Germs,' *ibid.* March 19, 1876.

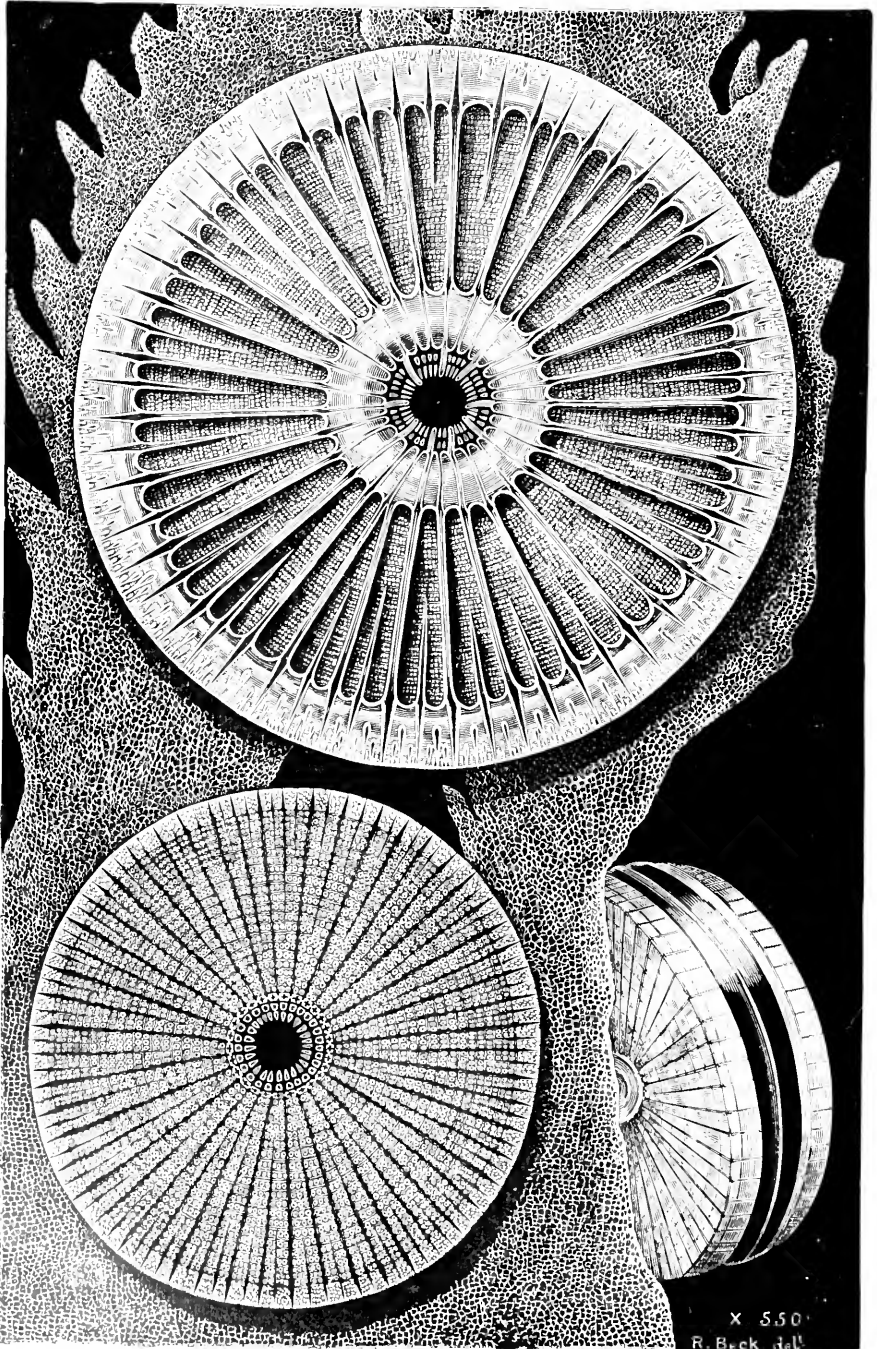

ALCHINOSITES JAPONICUS.

continued connection of the two frustules by its means gives rise to an appearance of two complete frustules having been developed within the original (fig. 445, A, C); subsequently, however, the two new frustules slip out of the hoop, which then becomes completely detached. The same thing happens with many other diatoms, so that the hoops are to be found in large numbers in the settlings of water in which these plants have long been growing.

But in some other cases all trace of the hoop is lost, so that it may be questioned whether it has ever been properly silicified, and whether it does not become fused (as it were) into the gelatinous envelope. During the healthy life of the diatom¹ the process of binary division is continually being repeated; and a very rapid multiplication of frustules thus takes place, all of which must be considered to be repetitions of one and the same individual form. Hence it may happen that myriads of frustules may be found in one locality, uniformly distinguished by some peculiarity of form, size, or marking, which may yet have had the same remote origin as another collection of frustules found in some different locality, and alike distinguished by some peculiarity of its own. For there is strong reason to believe that such differences spring up among the progeny of any true generative act, and that when that progeny is dispersed by currents into different localities, each will continue to multiply its own special type so long as the process of binary division goes on.

We have seen that division is of the nature of multiplication, and not of reproduction; and that, where it does take place, it must be regarded as the exception, and not as the rule. As respects reproduction, Count Castracane, who was an observer during thirty years devoted to the study of diatoms, had the opportunity of noting in what way the process differs in particular cases. He contended that he had been able to see in a *Podlophenia* the emission of gonids or sporules or embryonal forms, in the same way in which Rabenhorst saw it in *Melosira carians*, and O'Meara in *Pleurosigma Spenceii*; and in another case there were seen a number of oval cysts of a species of *Navicula* easily recognisable. The greater number of these were in a quiescent state; but some few were seen in motion by means of two flagelliform cilia: so that these larger or smaller cysts represented zygospores, and some of them were shown to be zoözygospores. Castracane had the good fortune to meet with a number of large and small oval cysts imbedded in a gelatinous mass, all of them having in the centre two similar corpuscles. From the condition of two greenish oblong indistinct forms, these went on, by an easy transition, to manifest themselves as naviculoid types, and at length developed into full-grown frustules of *Mastogloia*. All this proved, in his judgment, how reproduction in diatoms may present itself in different forms and with different peculiarities; for which reason one ought to avoid arguing from special cases to general laws. The only thing which can be asserted of all cases of reproduction, is that it must be preceded by conjugation, which results in the fertilisation of the

¹ This refers to those diatoms in which binary subdivision can take place.

sporules or gonids, which, after a period of repose or of incubation inclosed within a cyst, or within a membranous frond, or within a frustule, attain a condition for living an independent life and reproducing in every respect the adult type of the mother-cell; thus the cyst, the membranous frond, or the frustule, performs the function of a sporange. Castracane was of opinion that these gonids or embryonal forms could have no traces of silex in their cell-walls, scarcely yet formed, until a few years ago,¹ among the diatoms of a marine deposit of the Miocene period, he met with a perfect frustule of *Coscinodiscus punctatus*, which, between the two planes of the valves, and therefore within the cell, exhibited some round marks which admitted of no other interpretation except that of impressions or traces of the embryonal forms surprised by death while still attached to the mother-cell. More recently he met with other cases identical in character, so that he has no longer any doubt as to the presence of silex in the cell-walls of diatoms which have not yet emerged to the light.

The formation of 'endocysts' within the frustule of diatoms has also been observed by Comber, Murray, and others.

No one appears at present to have given attention to a circumstance described by Castracane² in relation to a specimen of *Striatella unipunctata*, which has passed thousands of times under the eyes of all, without its significance being recognised. The diatoms which we have most frequently under our observation do not always exhibit the same arrangement of their endochrome. The attempt has, indeed, been made to found the classification of diatoms on the arrangement of the endochrome, according as it is present in the form of plates or of granules; thus distinguishing the *placochromatic* and the *cocochromatic* forms; but a difficulty is presented in the way of this classification by certain types which sometimes belong to the one, sometimes to the other class. And this cannot be the result of accident. Such variations might occur in some diatoms as the result of special biological conditions of the individual. There may frequently be seen, for example, a specimen of *Melosira carians* with its cell-cavity filled with endochrome, not in a condition of unequal amorphous masses, but of uniform rounded corpuscles; and this demands particular attention, or at least gives good ground for special research. A diligent examination instituted in these cases has demonstrated the existence in them of a special organisation; and the determination of a narrow and well-defined limit of outline seems to prove that these were perfectly distinct and independent of one another. From the perfect resemblance of these to the gonids and embryonal forms seen to escape from the mother-cell by Rabenhorst, O'Meara, and Castracane, he concludes that this special arrangement of the endochrome must be interpreted as a prelude to the process of reproduction.

These observations may possibly attract the attention of some

¹ See 'Observations on a Fossil Diatom in relation to the Process of Reproduction,' *Atti dell' Accad. Pontif. dei Nuovi Lincei*, May 17, 1885.

² See 'The Diatoms of the Coasts of Istria and Dalmatia,' *Atti dell' Accad. Pontif. dei Nuovi Lincei*, April 27 and May 25, 1873.

who are applying themselves to the study of diatoms to so important an argument, on which may depend the possibility of establishing a really good classification of diatoms which will at length satisfy diatomists. At present preference is generally accorded to the classification proposed by H. L. Smith, which establishes the class of *Raphideæ* from the presence of a raphe in the plane of the valves. If there is, on the valves, in place of the raphe, a simple line of division, the forms thus characterised are termed *Pseudoraphideæ*; while those in which the valves have neither raphe nor its equivalent are called *Cryptoraphideæ*, or, better, *Anaraphideæ*. While, therefore, in the present state of our knowledge of diatoms, any classification can only be regarded as provisional, we do not propose any innovation on this point, although we are disposed to accord our preference to that suggested by H. L. Smith.

Conjugation, so far as is at present known, takes place among the ordinary *Diatomaceæ* almost exactly as among the *Desmidiaceæ*, except that it sometimes results in the production of two 'zygospores' instead of a single one. Thus in *Surirella* (fig. 453), the valves of two free and adjacent frustules separate from each other, and the two endochromes (probably included in their parietal utricles) are discharged; these coalesce to form a single mass, which becomes enclosed in a gelatinous envelope, and in due time this zygospore shapes itself into a frustule resembling that of its parent, but of larger size. But in *Epithemia* (fig. 446, A, B), the first diatom in which the conjugating process was observed by Mr. Thwaites,¹ the endochrome of each of the conjugating frustules (C, D) appears to divide at the time of its discharge into two halves; each half coalesces with half of the other endochrome; and thus two zygospores (E, F) are formed, which, as in the preceding case, become invested with a gelatinous envelope, and gradually assume the form and markings of the parent frustules, but grow to a very much larger size, the sporangial masses having obviously a power of self-increase up to the time when their envelopes are consolidated. It seems to be in this way that the normal size is recovered, after the progressive diminution which is incident to repeated binary multiplication. Of the subsequent history of the zygospores much remains to be learnt; and it may not be the same in all cases. Appearances have been seen which make it almost certain that the contents of each zygospore break up into a brood of *gonids*, and that it is from these that the new generation originates. These gonids, if each be surrounded (as in many other cases) by a distinct cyst, may remain undeveloped for a considerable period; and they must augment considerably in size before they obtain the dimensions of the parent frustule. It is in this stage of the process that the modifying influence of external agencies is most likely to exert its effects; and it may be easily conceived that (as in higher plants and animals) this influence may give rise to various diversities among the respective individuals of the same brood; which diversities, as we have seen, will be transmitted to all the repetitions of each

¹ See *Annals of Natural History*, vol. xx. ser. i. 1847, pp. 9, 343 and vol. i. ser. ii. 1848, p. 161.

that are produced by the process of binary division. Hence a very considerable latitude is to be allowed to the limits of species, when the different forms of *Diatomaceæ* are compared; and here, as in many other cases, a most important question arises as to what *are* those limits—a question which can only be answered by such a careful study of the entire life-history of every single type as may advantageously occupy the attention of many a microscopist who is at present devoting himself to the resolution of the markings on diatom-valves, and to the multiplication of reputed species by the detection of minute differences.¹

This formation of what are termed *auvospores*—as serving to

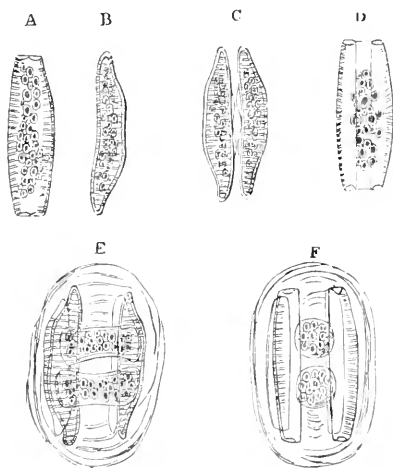

FIG. 446.—Conjugation of *Epithemia turgida*: A, front view of single frustule; B, side view of the same; C, two frustules with their concave surfaces in close apposition; D, front view of one of the frustules, showing the separation of its valves; E, F, side and front views after the formation of the zygospores.

augment the size of the cells which are to give origin to a new generation—takes place on a very different plan in some of those filamentous types, such as *Melosira* (fig. 444, A, B), in which a strange inequality presents itself in the diameters of the different cells of the same filament, the larger ones being usually in various stages of binary subdivision, by which they multiply themselves longitudinally. According to the observations of Mr. Thwaites (*loc. cit.*), these also are the products of a kind of conjugation between the adjacent cells of the ordinary diameter, taking place before the completion of their separation. He describes the endochrome of particular frustules, after separating as if for the formation of a pair of new cells, as moving back from the extremities towards the centre, rapidly increasing in quantity and aggregating into a zygospore (fig. 447, No. 2, *a, b, c*): around this a new envelope is developed, which may or may not resemble that of the ordinary frustules, but which remains in continuity with them; and this zygospore soon undergoes binary

¹ See on this subject a valuable paper by Prof. W. Smith 'On the Determination of Species in the *Diatomaceæ*,' in the *Quart. Journ. of Microsc. Science*, vol. iii. 1855, p. 130; a memoir by Prof. W. Gregory 'On Shape of Outline as a Specific Character of *Diatomaceæ*,' in *Trans. of Microsc. Soc.* 2nd series, vol. iii. 1855, p. 10; and the Author's Presidential Address, in the same volume, pp. 44-50; 'On *Navicula crassinervis*, *Frustulia saronica*, and *N. rhomboides*, as Test-objects,' by W. H. Dallinger, *Monthly Micro. Journ.* 1876, vol. xvii. p. 1; also an *Additional note on the identity of these*, by the same Author, *ibid.* p. 173.

subdivision (No. 3, *a, b, c*), the cells of the new series thus developed presenting the character of those of the original filament (1), but greatly exceeding them in size. From what has been already stated, it seems probable that a gradual reversion to the smaller form takes place in subsequent subdivisions, a further reduction being checked by a new formation of zygospores. The various modes of formation of auxospores in the Diatomaceæ are classified by Klebahn under five different heads, viz.:—(1) Rejuvenescence of a single cell, accompanied by an increase in size; this is the simplest type, and one of the most common. (2) Two daughter-cells are produced from the protoplasm of a mother-cell, and from these arise two auxospores (*Achnanthes longipes*, *Rhabdonema arcuatum*). (3) Two cells lying side by side cast off their old valves, and each grows into an auxospore, without any previous fusion, or any visible interchange of contents; this is the commonest type of all. (4) A true conjugation takes place; the protoplasmic contents of the two cells fuse

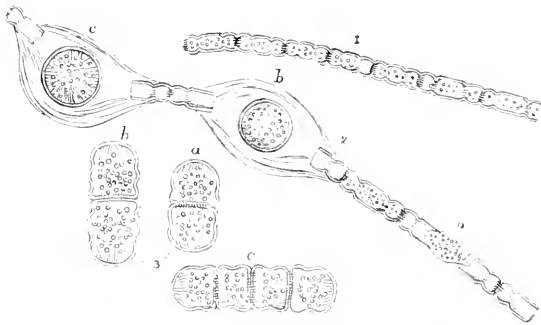

FIG. 447. —Self-conjugation (?) of *Melosira italica* (*Aulacosira crenulata* Thwaites): 1, simple filament; 2, filament developing auxospores; *a, b, c*, successive stages in the formation of auxospores; auxospore-frustules in successive stages, *a, b, c*, of multiplication.

together into one, and this mass grows into an auxospore. (5) Before conjugation, the protoplasm of each of the two cells divides beforehand into two daughter-cells, and two auxospores are formed by the fusion of a daughter-cell from each mother-cell with the daughter-cell of the other one lying opposite to it: this is the most complicated process (*Amphora ovalis*, *Epithemia Argus*, *Rhopalodia gibba*, &c.).

The most curious phenomenon presented by diatoms is undoubtedly their power of movement, which induced Ehrenberg and the other early observers of these organisms to place them erroneously in the animal kingdom, although it affords no evidence of consciousness. This power of movement, if not common to all diatoms, is very evident in those species which are normally or accidentally free, and most conspicuously in oblong forms, such as the species of *Navicula*. In those also which are stalked it has been noticed that if, from any cause, a frustule becomes detached, it is

endowed with a motion similar to that of the species which are normally free. This circumstance has caused the abandonment of Mr. W. Smith's proposal to assign a generic value to the condition in which the frustule is possessed of this property without regard to its form. Hence those genera are not now generally recognised which differ only in being enclosed in a membranous frond, or in being stalked, especially since frustules contained in a sheath, for example in *Schizonema*,¹ have been seen to escape from it, and to be prevented from returning again to it in company with the sister *Navicula*. Hence the genera *Schizonema*, *Berkeleya*, and *Dickiea* must be reunited to *Navicula*; *Cocconema*, *Endonema*, and *Colletonema* to *Cymbella*; and *Homeocladia* to *Nitzschia*. The singular phenomenon of movement which may be observed in many genera of diatoms—among which the most singular is that presented by *Bacillaria paradoxa* (fig. 449), in which the rod-like frustules are seen to be continually gliding one along another, in a retrograde direction, before they become detached—is found to be in general a movement backwards and forwards in a straight line so far as they meet with no impediment, while the intervention of obstacles determines a passive change of direction. The backward and forward movements of the *Navicula* have been already described; in *Surirella* (fig. 453) and *Campylodiscus* (fig. 454) the motion never proceeds further than a languid roll from one side to the other; and in *Gomphonema* (fig. 463), in which a foramen fulfilling the nutritive office is found at the larger extremity only, the movement (which is only seen when the frustule is separated from its stipe) is a hardly perceptible advance in intermitted jerks in the direction of the narrow end. The cause of this movement is uncertain. It has been referred by different authors to the action of endosmose and exosmose; to cilia; to the projection of pseudopode-like masses of protoplasm through orifices in the raphe, or of a single elongated protoplasmic thread; but the most probable interpretation attributes it to the action of the changes resulting from the nutrition of the cell, which must necessarily absorb food in a liquid condition. Taking account, therefore, of the relatively considerable quantity of silicic acid necessary to the organisation of the diatom cell in proportion to its minute dimensions, and bearing in mind, at the same time, the incalculably small traces of silicic acid in solution in the water, it may be understood how active must be the exchange from the exterior to the interior of the cell, and *vice versa*, and hence how such an exchange must determine a continual change of position backwards and forwards, through the reaction exercised on the delicate floating frustules.

The principles upon which this interesting group should be classified cannot be properly determined until the history of the generative process—of which nothing whatever is yet known in a large proportion of diatoms, and but little in any of them—shall have been thoroughly followed out. The observations of Focke² render it

¹ See Castracane, 'Observations on the Genera *Homeocladia* and *Schizonema*,' in *Atti dell' Accad. Pontif. dei Nuovi Lincei*, May 23, 1880.

² According to this observer (*Ann. of Nat. Hist.* 2nd series, vol. xv. 1855, p. 237) *Navicula bifrons* forms, by the spontaneous fission of its internal substance, spherical bodies, which, like gemmules, give rise to *Surirella microcora*. These by conjuga-

highly probable that many of the forms at present considered as distinct from each other would prove to be but different states of the same if their *whole* history were ascertained. On the other hand, it is by no means impossible that some which appear to be nearly related in the structure of their frustules and in their mode of growth may prove to have quite different modes of reproduction. At present, therefore, *any* classification must be merely provisional; and in the notice now to be taken of some of the most interesting forms of the *Diatomaceæ*, the method of Professor Kützing, which is based upon the characters of the individual frustules, is followed, in preference to that of Mr. W. Smith, which was founded on the degree of connection remaining between the several frustules after binary division.¹ In each family the frustules may exist under four conditions:—(a) free, the binary division being entire, so that the frustules separate as soon as the process has been completed; (b) stipitate, the frustules being implanted upon a common stem (fig.

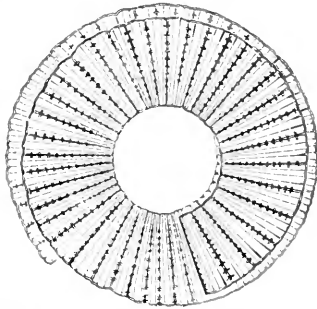

FIG. 448.

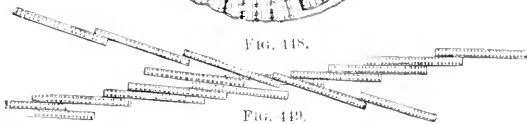

FIG. 449.

FIG. 448.—*Meridion circulare*.FIG. 449.—*Bacillaria paradoxa*.

450), which keeps them in mutual connection after they have themselves undergone a complete binary division; (c) united in a filament, which will be continuous (fig. 445, A, B) if the cohesion extend to the entire surfaces of the sides of the frustules, but may be a mere zigzag chain (fig. 451) if the cohesion be limited to their angles; (d) aggregated into a frond (fig. 464), which consists of numerous frustules more or less regularly enclosed in a gelatinous investment. Commencing with the last-named division (A), the first family

produce *N. splendida*, which gives rise to *N. bifrons* by the same process. He is only able to speak positively, however, as to the production of *N. bifrons* from *N. splendida*; that of *Sarivella microcora* from *N. bifrons*, and that of *N. splendida* from *Sarivella microcora*, being matters of inference from the phenomena witnessed by him.

¹ The method of Kützing was the one followed, with some modification, by Mr. Ralfs in his revision of the group for the fourth edition of Pritchard's *Infusoria*; and to his systematic arrangement the Author would refer such as desire more detailed information.

is that of *Eunoticeæ*, of which we have already seen a characteristic example in *Epithemia turgida* (fig. 446). The essential characters of this family consist in the more or less lunate form of the frustules in the lateral view (fig. 446, B), and in the striae being continuous across the valves without any interruption by a longitudinal line. In the genus *Eunotia* the frustules are free; in *Epithemia* they are very commonly adherent by the flat or concave surface of the connecting zone; and in *Himantidium* they are usually united into ribbon-like filaments. In the family *Meridieæ* we find a similar union of the transversely striated individual frustules; but these are narrower at one end than at the other, so as to have a cuneate or wedge-like form, and are regularly disposed with their corresponding extremities always pointing in the same direction, so that the fila-

ment is curved instead of straight, as in the beautiful *Meridion circulare* (fig. 448). Although this plant, when gathered and placed under the microscope, presents the appearance of circles overlying one another, it really grows in a helicoid (screw like) form, making several continuous turns. This diatom abounds in many localities in this country; but there is none in which it presents itself in such rich luxuriance as in the mountain-brooks about West Point in the United States, the bottoms of which, according to Professor Bailey, are literally covered in the first warm days of spring with a ferruginous-coloured mucous matter, about a quarter of

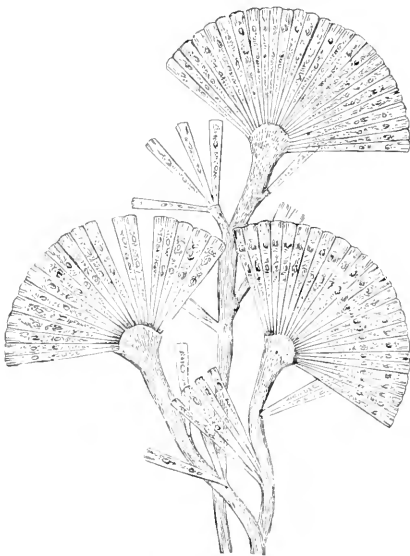

FIG. 450.—*Licmophora flabellata*.

an inch thick, which, on examination by the microscope, proves to be filled with millions and millions of these exquisitely beautiful siliceous bodies. Every submerged stone, twig, and spear of grass is enveloped by them, and the waving plume-like appearance of a filamentous body covered in this way is often very elegant. The frustules of *Meridion* are attached when young to a gelatinous cushion; but this disappears with the advance of age. In the family *Licmophoreæ* also the frustules are wedge-shaped; in some genera they have transverse markings, whilst in others these are deficient; but in most instances there are to be observed two longitudinal suture-like lines on each valve (which have received the special designation of *cittæ*) connecting their two extremities. The newly formed part of the stipe in the genus *Licmophora*, instead of itself becoming double

with each act of binary division of the frustule, increases in breadth, while the frustules themselves remain coherent, so that a beautiful fan-like arrangement is produced (fig. 450). A splitting away of a few frustules seems occasionally to take place, from one side or the other, before the elongation of the stipe: so that the entire plant presents us with a more or less complete *flabella* or fan upon the summit of the branches, with imperfect flabelle or single frustules irregularly scattered throughout the entire length of the footstalk. This beautiful plant is marine, and is attached to seaweeds and zoöphytes.

In the next family, that of *Fragilaria*, the frustules are of the same breadth at each end, so that if they unite into a filament they form a straight band. In

some genera they are smooth, in others transversely striated, with a central nodule: when striae are present, they run across the valves without interruption. To this family belongs the genus *Diatoma*, which gives its name to the entire group, that name (which means cutting through) being suggested by the curious habit of the genus, in which the frustules, after division, separate from each other along their lines of junction, but remain connected at their angles, so as to form zigzag chains (fig. 451). The valves of *Diatoma*, when turned sideways (*a*), are seen to be strongly marked by transverse striae, which extend into the front view. The proportion between the length and the breadth of

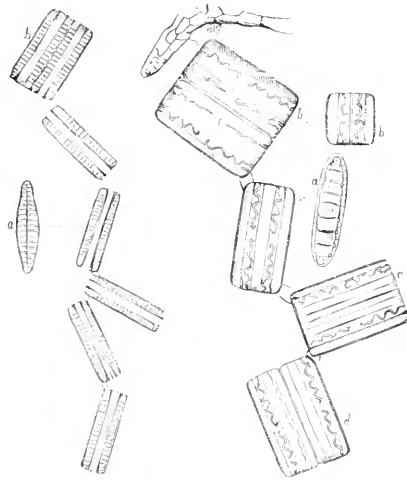

FIG. 451.

FIG. 452.

FIG. 451.—*Diatoma vulgare*: *a*, side view of frustule; *b*, frustule undergoing division.

FIG. 452.—*Grammatophora serpentina*: *a*, front and side views of single frustule; *b, b*, front and end views of divided frustule; *c*, frustule about to undergo division; *d*, frustule completely divided.

each valve is found to vary so considerably that, if the extreme forms only were compared, there would seem adequate ground for regarding them as belonging to different species. The genus inhabits fresh water, preferring gently running streams, in which it is sometimes very abundant. The genus *Fragilaria* is nearly allied to *Diatoma*, the difference between them consisting chiefly in the mode of adhesion of the frustules, which in *Fragilaria* form long, straight filaments with parallel sides; the filaments, however, as the name of the genus implies, very readily break up into their component frustules, often separating at the slightest touch. Its various species are very common in pools and ditches. This family is connected with the

next by the genus *Nitzschia*, which is a somewhat aberrant form, distinguished by the presence of a prominent keel on each valve, dividing it into two portions which are usually unequal, while the entire valve is sometimes curved, as in *N. sigmoidea*, which has been used as a test-object, but is not suitable for that purpose on account of the extreme variability of its striation. Nearly allied to this is the genus *Bacillaria*, so named from the elongated staff-like form of its frustules; its valves have a longitudinal punctated keel, and their transverse striae are interrupted in the median line. The principal species of this genus is the *B. paradoxa*, whose remarkable movement has been already described. Owing to this displacement of the frustules, its filaments seldom present themselves with straight parallel sides, but nearly always in forms more or less oblique, such as those represented in fig. 449. This curious object is an inhabitant of salt or of brackish water. Many of the species formerly ranked under this genus are now referred to the genus *Diatoma*. The genera *Nitzschia* and *Bacillaria* have been associated by Mr. Ralfs

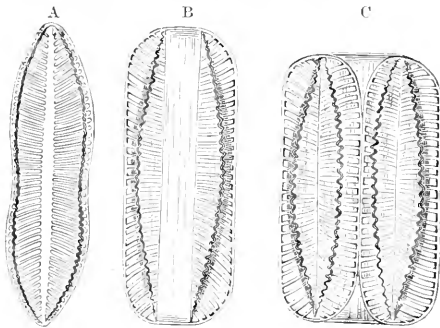

FIG. 453.—*Surirella constricta*: A, side view; B, front view; C, binary subdivision.

with some other genera which agree with them in the bacillar or staff-like form of the frustules and in the presence of a longitudinal keel, in the sub-family *Nitzschieae*, which ranks as a section of the *Surirellae*. Another sub-family, *Synedrae*, consists of the genus *Synedra* and its allies, in which the bacillar form is retained, but the keel is wanting, and the valves are

but little broader than the front of the frustule.

In the *Surirellae* proper the frustules are no longer bacillar, and the breadth of the valves is usually (though not always) greater than the front view. The distinctive character of the genus *Surirella*, in addition to the presence of the supposed 'canaliculi,' is derived from the longitudinal line down the centre of each valve (fig. 453, A) and the prolongation of the margins into 'ala.' Numerous species are known, which are mostly of a somewhat ovate form, some being broader and others narrower than *S. constricta*; the greater part of them are inhabitants of fresh or brackish water, though some few are marine; and several occur in those infusorial earths which seem to have been deposited at the bottoms of lakes, such as that of the Mourne Mountains in Ireland (fig. 468. *b, c, k*). In the genus *Campylodiscus* (fig. 454) the valves are so greatly increased in breadth as to present almost the form of discs (A), and at the same time have more or less of a peculiar twist or saddle-shaped curvature (B). It is in this genus that the supposed 'cana-

liculi' are most developed, and it is consequently here that they may be best studied; and of there being here really *costæ*, or internally projecting ribs, no reasonable doubt can remain after examination of them under the binocular microscope, especially with the 'black-ground' illumination. The form of the valves in most of the species is circular or nearly so; some are nearly flat, whilst in others the twist is greater than in the species here represented. Some of the species are marine, whilst others occur in fresh water; a very beautiful form, the *C. clypeus*, exists in such abundance in the infusorial stratum discovered by Ehrenberg at Soos, near Ezer, in Bohemia, that the earth seems almost entirely composed of it.

The next family, the *Striatellæ*, forms a very distinct group, differentiated from every other by having longitudinal *costæ* on the connecting portions of the frustules, these *costæ* being formed by the inward projection of annular siliceous plates (which do not, however, reach to the centre), so as to form septa dividing the cavity of the cell into imperfectly separated chambers. In some instances these annular septa are only formed during the production of the

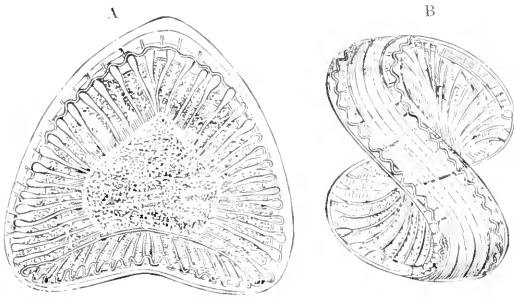

FIG. 454.—*Campylodiscus costatus*: A, front view; B, side view.

valves in the act of division, and on each repetition of such production, being thus always *definite* in number: whilst in other cases the formation of the septa is continued after the production of the valves, and is repeated an uncertain number of times before the recurrence of a new valve-production, so that the annuli are *indefinite* in number. In the curious *Grammatophora serpentina* (fig. 452) the septa have several undulations and incurved ends, so as to form serpentine curves, the number of which seems to vary with the length of the frustule. The lateral surfaces of the valves in *Grammatophora* are very finely striated, and some species, as *G. subtilissima* and *G. marina*, are used as test-objects. The frustules in most of the genera of this family separate into zigzag chains, as in *Diatoma*; but in a few instances they cohere into a filament, and still more rarely they are furnished with a stipe. The small family *Terpsinoëa* was separated by Mr. Ralfs from the *Striatellæ*, with which it is nearly allied in general characters, because its septa (which in the latter are longitudinal and divide the central portions into chambers) are transverse, and are confined to the lateral portions of the

frustules, which appear in the front view as in *Biddulphiæ*. The typical form of this family is the *Terpsinoë musica*, so named from the resemblance which the markings of its costæ bear to musical notes.

We next come to two families in which the lateral surfaces of the frustules are *circular*; so that, according to the flatness or convexity of the valves and the breadth of the intervening hooped band, the frustules may have the form either of thin discs, short cylinders, biconvex lenses, oblate spheroids, or even of spheres. Looking at the structure of the individual frustules, the line of demarcation between these two families, *Melosiræ* and *Coscinodisceæ*, is by no means distinct, the principal difference between them being that the valves of the latter are commonly areolated, whilst those of the former are smooth. Another important difference, however, lies in this, that the frustules of the *Coscinodisceæ* are always free, whilst those of the *Melosiræ* remain coherent into filaments, which often so strongly resemble those of the simple *Confervaceæ* as to be readily distinguishable only by the effect of heat. Of these last the most important genus is *Melosira* (fig. 444). Some of its species are marine, others fresh-water; one of the latter, *M. ochracea*, seems to grow best in boggy pools containing a ferruginous impregnation; and it is stated by Professor Ehrenberg that it takes up from the water, and incorporates with its own substance, a considerable quantity of iron. The filaments of *Melosira* very commonly fall apart at the slightest touch, and in the infusorial earths in which some species abound the frustules are always found detached (fig. 468, *a, a, d, d*). The meaning of the remarkable difference in the sizes and forms of the frustules of the same filaments (fig. 444) has not yet been fully ascertained. The sides of the valves are often marked with radiating striae (fig. 468, *d, d*); and in some species they have toothed or serrated margins, by which the frustules lock together. To this family belongs the genus *Hyalodiscus*, of which *H. subtilis* was first brought into notice by the late Professor Bailey as a test-object, its disc being marked, like the engine-turned back of a watch, with lines of exceeding delicacy, only visible by good objectives and careful illumination.

The family *Coscinodisceæ* includes a large proportion of the most beautiful of those discoidal diatoms of which the valves do not present any considerable convexity, and are connected by a narrow zone. The genus *Coscinodiscus*, which is easily distinguished from most of the genera of this family by not having its disc divided into compartments, is of great interest from the vast abundance of its valves in certain fossil deposits (fig. 467, *a, a, a*) especially, the infusorial earth of Richmond in Virginia, of Bermuda, and of Oran, as also in guano. Each frustule is of discoidal shape, being composed of two delicately undulating valves united by a hoop; so that if the frustules remain in adhesion, they would form a filament resembling that of *Melosira* (fig. 444, B). The regularity of the hexagonal areolation shown by its valves renders them beautiful microscopic objects; in some species the areole are smallest near the centre, and gradually increase in size towards the margin; in

others a few of the central areolæ are the largest, and the rest are of nearly uniform size; while in others, again, there are radiating lines formed by areolæ of a size different from the rest. Most of the species are either marine or are inhabitants of brackish water; when living they are most commonly found adherent to seaweeds or zoöphytes; but when dead the valves fall as a sediment to the bottom of the water. In both these conditions they were found by Professor J. Quekett in connection with zoöphytes which had been brought home from Melville Island by Sir E. Parry; and the species seem to be identical with those of the Richmond earth. The investigations of Mr. J. W. Stephenson¹ on *Coscinodiscus oculus iridis* show that the peculiar 'eye-like' appearance in the centre of each of its hexagonal areolæ arises from the intermingling of the markings of two distinct layers, differing considerably in structure, the markings of the lower layer being partially seen through those of the upper. By fracturing these diatoms Mr. Stephenson succeeded in separating portions of the two layers, so that each could be examined singly. He also mounted them in bisulphide of carbon.

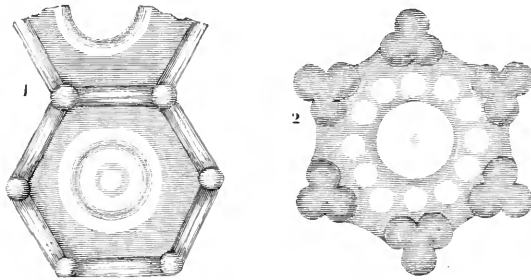

FIG. 455.—Structure of siliceous valve of *Coscinodiscus oculus iridis*: 1, hexagonal areola of inner or 'eye-spot' layer; 2, areola of outer layer.

the refractive index of which is high; and also in a solution of phosphorus in bisulphide of carbon, which has a still higher refractive index. If we suppose a diatom to be marked with *concave depressions*, they would act as concave lenses in air, which is less refractive than their own siliceous substance; but when such lenses are immersed in bisulphide of carbon, or in the phosphorus solution, they would be converted into *convex lenses* of the more refractive substance, and have their action in air reversed. Analogous but opposite changes must take place when convex diatom-lenses are viewed first in air, and then in the more refractive media. Applying these and other tests to *Coscinodiscus oculus iridis*, Mr. Stephenson considered both layers to be composed of hexagons, represented in fig. 455 from drawings by Mr. Stewart. The upper layer is much stronger and thicker than the lower one, and the framework of its hexagons more readily exhibits its beaded appearance. The lower layer is nearly transparent, and but little conspicuous when seen in bisulphide of carbon, except as shown in the figure, when the framework of

¹ *Monthly Microscopical Journal*, vol. x. 1873, p. 1.

the hexagons and the rings in the midst of them appear thickened and more refractive. In both layers the balance of observations tends to the belief that the hexagons have no floors, and are in fact perforated by foramina like those of minute polycystina. The cells formed by the hexagons of the upper layer are of considerable depth; those of the lower layer are shallower. It is very desirable that living forms of *Coscinodisci* should be carefully examined; since, if they really have foramina, some minute organs may be protruded through them.

The genus *Actinocyclus*¹ closely resembles the preceding in form, but differs in the markings of its valvular discs, which are minutely and densely punctated or areolated, and are divided radially by single or double dotted lines, which, however, are not continuous but interrupted. The discs are generally iridescent; and, when mounted in balsam, they present various shades of brown, green, blue, purple, and red; blue or purple, however, being the most frequent. An immense number of species have been erected by Professor Ehrenberg on minute differences presented by the rays as to number and distribution; but since scarcely two specimens can be found in which there is a perfect identity as to these particulars, it is evident that such minute differences between organisms otherwise similar are not of sufficient account to serve for the separation of species. This form is very common in guano from Ichaboe. Allied to the preceding are the two genera *Asterolampra* and *Asteromphalus*, both of which have circular discs of which the marginal portion is minutely areolated, whilst the central area is smooth and perfectly hyaline in appearance, but is divided by lines into radial compartments which extend from the central umbilicus towards the periphery. The difference between them simply consists in this, that in *Asterolampra* all the compartments are similar and equidistant and the rays equal, whilst in *Asteromphalus* (Pl. I. fig. 3) two of the compartments are closer together than the rest, and the enclosed hyaline ray (which is distinguished as the median or basal ray) differs in form from the others, and is sometimes specially continuous with the umbilicus. The eccentricity thus produced in the other rays has been made the basis of another generic designation, *Spatangidium*; but it may be doubted whether this is founded on a valid distinction.² These beautiful discs are for the most part obtainable from guano, and from soundings in tropical and antarctic seas. From these we pass on to the genus *Actinoptychus* (fig. 456), of which also the frustules are discoidal in form, but in which each valve, instead of being flat, has an undulating surface, as is seen in front view (B), giving to the side view (A) the appearance of being marked by radiating bands. Owing to this peculiarity of shape, the whole surface cannot be brought into focus at once except with a low power; and the

¹ The Author concurs with Mr. Ralfs in thinking it preferable to limit the genus *Actinocyclus* to the forms originally included in it by Ehrenberg, and to restore the genus *Actinoptychus* of Ehrenberg, which had been improperly united with *Actinocyclus* by Professors Kützing and W. Smith.

² See Greville in *Quart. Journ. Microsc. Science*, vol. vii. 1859, p. 158; and in *Trans. Microsc. Soc.*, vol. viii. n.s. 1860, p. 102, and vol. x. 1862, p. 41; also Wallich in the same *Transactions*, vol. viii. 1860, p. 44.

difference of aspect which the different radial divisions present in fig. 456 is simply due to the fact that one set is out of focus whilst the other is in it, since the appearances are reversed by merely altering the focal adjustment. The *number* of radial divisions has been considered a character of sufficient importance to serve for the distinction of species; but this is probably subject to variation; since we not unfrequently meet with discs, of which one has (say) eight, and another ten such divisions, but which are precisely alike in every other particular. The valves of this genus also are very abundant in the infusorial earth of Richmond, Bermuda, and Oran (fig. 467, *b, b, b*), and many of the same species have been found in guano and in the seas of various parts of the world. The frustules in their living state appear to be generally attached to seaweeds or zoöphytes.

The Bermuda earth also contains the very beautiful form which, though scarcely separable from *Actinopterychus* except by its marginal spines, has received from Professor Ehrenberg the distinctive appellation of *Heliopelta* (sun shield). The object is represented as seen on its *internal* aspect by the parabolic illuminator, which brings into view certain features that can scarcely be seen by ordinary transmitted light.

Five of the radial divisions are seen to be marked out into circular areolæ; but in the five which alternate with them a minute beaded structure is observable. This may be shown, by careful adjustment of the focus, to exist over the whole interior of the valve, even on the divisions in which

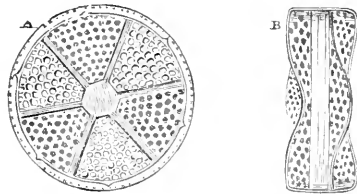

FIG. 456.—*Actinopterychus undulatus*.
A, side view; B, front view.

the circular areolation is here displayed; and it hence appears probable that this marking belongs to the *internal* layer,¹ and that the circular areolation exists in the *outer* layer of the silicified valves. In the alternating divisions whose surface is here displayed, the areolation of the outer layer, when brought into view by focussing down to it, is seen to be formed by equilateral triangles: it is not, however, nearly so well marked as the circular areolation of the first-mentioned divisions. The dark spots seen at the end of the rays, like the dark centre, appear to be solid areolations of silicium not traversed by markings, as in many other diatoms; they are apparently *not* orifices, as supposed by Professor Ehrenberg. Of this type, again, specimens are found presenting six, eight, ten, or twelve radial divisions, but in other respects exactly similar; on the other hand, two specimens agreeing in their number of divisions may exhibit minute differences of other kinds; in fact, it is rare to find two

¹ It is stated by Mr. Stodder (*Quart. Journ. Microsc. Science*, vol. iii. n.s. 1863, p. 215) that not only has he seen, in broken specimens, the inner granulated plate projecting beyond the outer, but that he has found the inner plate altogether separated from the outer. The Author is indebted to this gentleman for pointing out that his figure represents the *inner* surface of the valve.

that are *precisely* alike. It seems probable, then, that we must allow a considerable latitude of variation in these forms before attempting to separate any of them as distinct species. Another very beautiful discoidal diatom, which occurs in guano, and is also found attached to seaweeds from different parts of the world (especially to a species employed by the Japanese in making soup), is the *Arachnoidiscus* (Plate XII), so named from the resemblance which the beautiful markings on its disc cause it to bear to a spider's web. According to Mr. Shadbolt,¹ who first carefully examined its structure, each valve consists of two layers; the outer one, a thin flexible horny membrane, indestructible by boiling in nitric acid; the inner one siliceous. It is the former which has upon it the peculiar spider's-web-like markings; whilst it is the latter that forms the supporting framework which bears a very strong resemblance to that of a circular Gothic window. The two can occasionally be separated entire by first boiling the discs for a considerable time in nitric acid and then carefully washing them in distilled water. Even without such separation, however, the distinctness of the two layers can be made out by focussing for each separately under a $\frac{1}{4}$ - or $\frac{1}{5}$ -inch objective; or by looking at a valve as an opaque object (either by the parabolic illuminator, or by the Lieberkühn, or by a side light) with a $\frac{1}{10}$ -inch objective, first from one side and then from the other. But it can be seen to very best advantage by the use of apochromatic objectives of suitable power and a suitable diaphragm for *dark-ground* illumination.

This family is connected with the succeeding by the small group *Eupodisceæ*, the members of which agree with the *Coscinodisceæ* in the general character of their discoid frustules, and with the *Biddulphiæ* in having areolar processes on their lateral surfaces. In the beautiful *Aulacodiscus* these arecolations are situated near the margin, and are connected with bands radiating from the centre; the surface also is frequently inflated in a manner that reminds us of *Actinoptychus*. These forms are for the most part obtained from guano.

The members of the next family, *Biddulphiæ*, differ greatly in their general form from the preceding, being remarkable for the great development of the lateral valves, which, instead of being nearly flat or discoidal, so as only to present a thin edge in front view, are so convex or inflated as always to enter largely into the front view, causing the central zone to appear like a band between them. This band is very narrow when the new frustules are first produced by binary division, but it increases gradually in breadth, until the new frustule is fully formed and is itself undergoing the same duplicative change. In *Biddulphia* (fig. 445) the frustules have a quadrilateral form, and remain coherent by their alternate angles (which are elongated into tooth-like projections), so as to form a zigzag chain. They are marked externally by ribbings which seem to be indicative of internal *costæ* partially subdividing the cavity. Nearly allied to this is the beautiful genus *Isthmia* (fig. 457), in

¹ *Trans. Microsc. Soc.* 1st series, vol. iii. p. 49.

which the frustules have a trapezoidal form owing to the oblique prolongation of the valves; the lower angle of each frustule is coherent to the middle of the next one beneath, and from the basal frustule proceeds a stipe by which the filament is attached. Like the preceding, this genus is marine, and is found attached to the seaweeds of our own shores. The areolated structure of its surface is very conspicuous both in the valves and in the connecting 'hoop;' and this hoop, being silicified, not only connects the two new frustules (as at *b*, fig. 457), until they have separated from each other, but, after such separation, remains for a time round one of the frustules, so as to give it a truncated appearance (*a*, *c*).

The family *Angulifera*, distinguished by the angular form of its valves in their lateral aspect, is in many respects closely allied to the preceding; but in the comparative flattening of their valves its members more resemble the *Coscinodisceæ* and *Eupodisceæ*. Of this family we have a characteristic example in the genus *Triceratium*, of which striking form a considerable number of species are met with in the Bermuda and other infusorial earths, while others are inhabitants of the existing ocean and of tidal rivers. *T. furus* (fig. 442), which is one of the largest and most regularly marked of any of these, occurs in the mud of the Thames and in various other estuaries on our own coast; it has been found, also, on the surface of large sea-shells from various parts of the world, such as those of *Hippopus* and *Haliotis*, before they have been cleaned; and it presents itself likewise in the infusorial earth of Petersburg (U.S.A.). The projections at the angles which are shown in that species are prolonged in some other species into 'horns;' whilst in others, again, they are mere tubercular elevations. Although the *triangular* form of the frustule, when looked at sideways, is that which is characteristic of the genus, yet in some of the species there seems a tendency to produce *quadrangular* and even *pentagonal* forms, these being marked as *varieties* by their exact correspondence in sculpture, colour, &c., with the normal triangular forms.¹ This departure is extremely remarkable, since it breaks down what seems at first to be the most distinctive character of the genus; and its occurrence is an indication of the degree of latitude which we ought to allow in other cases. It is difficult, in fact, to distinguish the square forms of *Triceratium* from those included in the genus

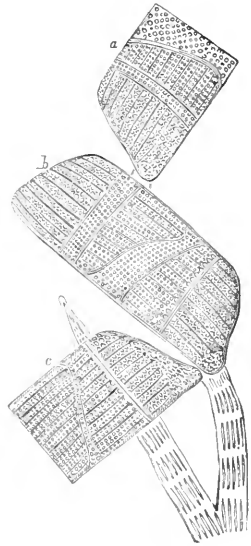

FIG. 457.—*Isthmia nervosa*.

¹ See Mr. Brightwell's excellent memoirs 'On the genus *Triceratium*' in *Quart. Journ. Microsc. Science*, vol. i. 1853, p. 245; vol. iv. 1856, p. 272; vol. vi. 1858, p. 153; also Wallich in the same Journal, vol. iv. 1858, p. 242; and Greville in *Trans. Microsc. Soc. n.s.* vol. ix. 1861, pp. 43, 69.

Amphitetras, which is chiefly characterised by the cubiform shape of its frustules. In the latter the frustules cohere at their angles, so as to form zigzag filaments, whilst in the former the frustules are usually free, though they have occasionally been found in chains.

Another group that seems allied to the *Biddulphiace* is the curious assemblage of forms brought together in the family *Chaetocerae*, some of the filamentous types of which seem also allied to the *Melosireae*. The peculiar distinction of this group consists in the presence of tubular 'awns,' frequently proceeding from the connecting hoop, sometimes spinous and serrated, and often of great length (fig. 458); by the interlacing of which the frustules are united into filaments whose continuity, however, is easily broken. In the genus *Bacteriastrum* (fig. 459) there are sometimes as many as twelve of these awns, radiating from each frustule like the spokes of a wheel, and in some instances regularly bifurcating.

With this group is associated the genus *Rhizosolenia*, of which several species are distinguished by the extraordinary length of the frustule (which may be from six to twenty

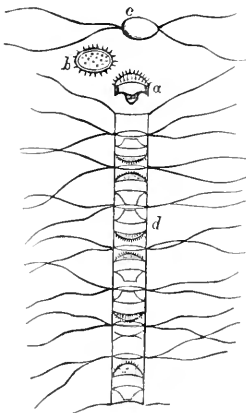

FIG. 458.—*Chatoceros Wighamii*: *a*, front view, and *b*, side view of frustule; *c*, side view of connecting hoop and awn; *d*, entire filament.



FIG. 459.—*Bacteriastrum furcatum*

times its breadth), giving it the aspect of a filament (fig. 460), by a transverse annulation that imparts to this filament a jointed appearance, and by the termination of the frustule at each end in a cone, from the apex of which a straight awn proceeds. It is not a little remarkable that the greater number of the examples of this curious family are obtained from the stomachs of Ascidians, Salpæ, Holothuriæ, and other marine animals.¹

The second principal division (B) of the *Diatomaceæ* consists, it will be remembered, of those in which the frustules have a median longitudinal line and a central nodule. In the first of the families which it includes, that of *Cocconeideæ*, the central nodule is obscure or altogether wanting on one of the valves, which is distinguished as

¹ See Brightwell in *Quart. Journ. Microsc. Science*, vol. iv. 1856, p. 105; vol. vi. 1858, p. 93; Wallich in *Trans. Microsc. Soc. n.s.* vol. viii. 1860, p. 48; and West, in the same, p. 151.

the inferior. This family consists but of a single genus, *Cocconeis*, which includes, however, a great number of species, some or other of them occurring in every part of the globe. Their form is usually that of ellipsoidal discs, with surfaces more or less exactly parallel, plane, or slightly curved; and they are very commonly found adherent to each other. The frustules in this genus are frequently invested by a membranous envelope which forms a border to them; but this seems to belong to the immature state, subsequently disappearing more or less completely.

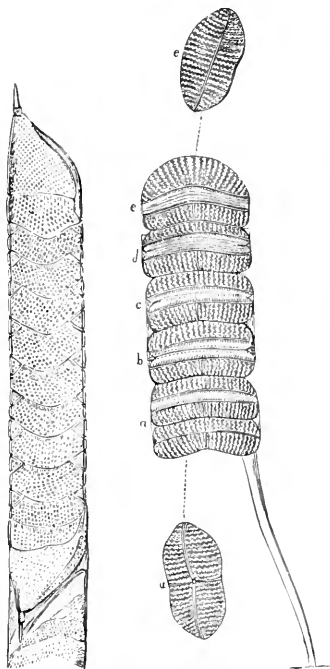

FIG. 460.—*Rhizosolenia imbricata*.

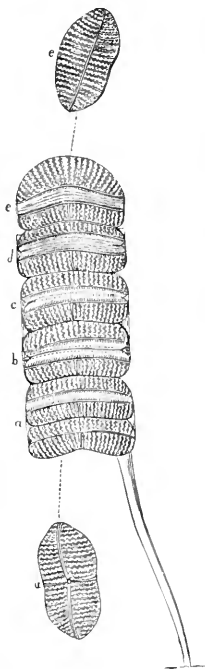

FIG. 461.—*Achnanthes longipes*: a, b, c, d, e, frustules in different stages of binary division.

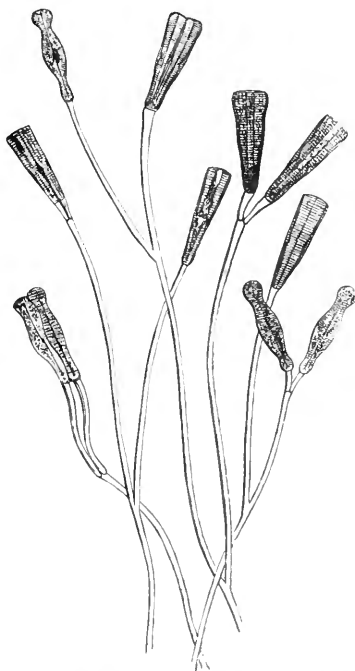

FIG. 462.—*Gomphonema geminatum*: its frustules connected by a dichotomous stipe.

Another family in which there is a dissimilarity in the two lateral surfaces is that of the *Achnantheæ*, the frustules of which are remarkable for the bend they show in the direction of their length, often more conspicuously than in the example here represented. This family contains free, adherent, and stipitate forms, one of the most common of the latter being *Achnanthes longipes* (fig. 461), which is often found growing on marine algae. The difference between the markings of the upper and lower valves is here distinctly seen; for, while both are traversed by striae, which are resolvable under a sufficient power into rows of dots, as well as

by a longitudinal line which sometimes has a nodule at each end (as in *Navicula*), the lower valve (*a*) has also a transverse line forming a *stauros*, or cross, which is wanting in the upper valve (*e*). A persistence of the connecting membrane, so as to form an additional connection between the cells, may sometimes be observed in this genus; thus in fig. 461 it not only holds together the two new frustules resulting from the subdivision of the lowest cell, *a*, which are not yet completely separated the one from the other, but it may be observed to invest the two frustules *b* and *c*, which have not merely separated, but are themselves beginning to undergo binary subdivision; and it may also be perceived to invest the frustule *d*, from which the frustule *e*, being the terminal one, has more completely freed itself.

In the family *Cymbelleæ*, on the other hand, both valves possess the longitudinal line with a nodule in the middle of its length; but the valves have the general form of those of the *Eunotieæ*, and the line is so much nearer one margin than the other that the nodule is sometimes rather marginal than central, as we see in *Cocconeæ* (fig. 468, *f*).

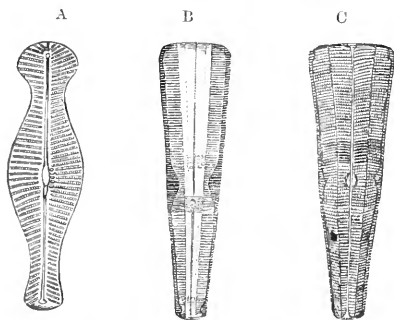

FIG. 463.—*Gomphonema geminatum*, more highly magnified: A, side view of frustule; B, front view; C, frustule in the act of division.

The *Gomphonemææ*, like the *Meridieæ* and *Licnophoreæ*, have frustules which are cuneate or wedge-shaped in their front view (figs. 462, 463), but are distinguished from those forms by the presence of the longitudinal line and central nodule. Although there are some free forms in this family, the greater

part of them, included in the genus *Gomphonema*, have their frustules either affixed at their bases or attached to a stipe. This stipe seems to be formed by an exudation from the frustule, which is secreted only during the process of binary division; hence, when this process has been completed, the extension of the single filament below the frustule ceases; but when it recommences, a sort of joint or articulation is formed, from which a new filament begins to sprout for each of the half-frustules; and when these separate, they carry apart the peduncles which support them as far as their divergence can take place. It is in this manner that the dichotomous character is given to the entire stipe (fig. 462). The species of *Gomphonema* are, with few exceptions, inhabitants of fresh water, and are among the commonest forms of *Diatomaceæ*.

Lastly, we come to the large family *Naviculeæ*, the members of which are distinguished by the symmetry of their frustules, as well in the lateral as in the front view, and by the presence of a median longitudinal line and central nodule in both valves. In the

genus *Navicula* and its allies the frustules are free or simply adherent to each other; while in another large section they are included within a gelatinous envelope, or are enclosed in a definite tubular or gelatinous frond. Of the genus *Navicula* an immense number of species have been described, the grounds of separation being often extremely trivial. Those which have a lateral sigmoid curvature have been separated by Mr. W. Smith under the designation *Pleurosigma*, which is now generally adopted; but his separation of another set of species under the name *Pinnularia* (which had been previously applied by Ehrenberg to designate the striated species), on the ground that its striæ (costæ) are not resolvable into dots, was not considered valid by Mr. Ralfs, because in many of the more minute species it is impossible to distinguish with certainty between striæ and costæ. Mr. Slack has since given an account of the resolution of the so-called costæ of twelve species of *Pinnularia* into 'beaded' structures.¹ The beautiful genus *Stauroneis*, which belongs to the same group, differs from all the preceding forms in having the central nodule of each valve dilated laterally into a band free from striæ, which forms a cross with the longitudinal band. The multitudinous species of the genus *Navicula* are for the most part inhabitants of fresh water; and they constitute a large part of most of the so-called 'infusorial earths' which were deposited at the bottoms of lakes. Among the most remarkable of such deposits are the substances largely used in the arts for the polishing of metals, under the names of Tripoli and rottenstone; these consist in great part of the frustules of *Navicula* and *Pinnularia*. The *Polierschiefer*, or 'polishing slate,' of Bilin in Bohemia, the powder of which is largely used in Germany for the same purpose, and which also furnishes the fine sand used for the most delicate castings in iron, occurs in a series of beds averaging fourteen feet in thickness, and these present appearances which indicate that they have been at some time exposed to a high temperature. The well-known 'Turkey-stone,' so generally employed for the sharpening of edge-tools, seems to be essentially composed of a similar aggregation of frustules of *Navicula*, &c., which have been consolidated by heat. The species of *Pleurosigma*, on the other hand, are for the most part either marine or are inhabitants of brackish water, and they comparatively seldom present themselves in a fossilised state. Of *Stauroneis* some species inhabit fresh water, while others are marine; and the former present themselves frequently in certain 'infusorial earths.'

Of the members of the sub-family *Schizonemææ*, consisting of those *Naviculææ* in which the frustules are united by a gelatinous envelope, some are remarkable for the great external resemblance they bear to acknowledged algae. This is especially the case with the genus *Schizonema*, in which the gelatinous envelope forms a regular tubular frond, more or less branched, and of nearly equal diameter throughout, within which the frustules lie either in single file or without any definite arrangement (fig. 464), all these frustules having arisen from the binary division of one individual. In the

¹ *Monthly Microscopical Journal*, vol. vi., 1871, p. 71.

genus *Mastogloia*, which is specially distinguished by having the annulus furnished with internal costæ projecting into the cavity of the frustule, each frustule is separately supported on a gelatinous cushion (fig. 465, B), which may itself be either borne on a branching stipe (A), or may be aggregated with others into an indefinite mass (fig. 466). The careful study of these composite forms is a matter of great importance, since it enables us to bring into comparison with each other great numbers of frustules which have unquestionably a common descent, and which must therefore be accounted as of the same species, and thus to obtain an idea of the *range of variation* prevailing in this group, without a knowledge of which specific definition is altogether unsafe. Of the very strongly marked varieties which may occur within the limits of a single species, we have an

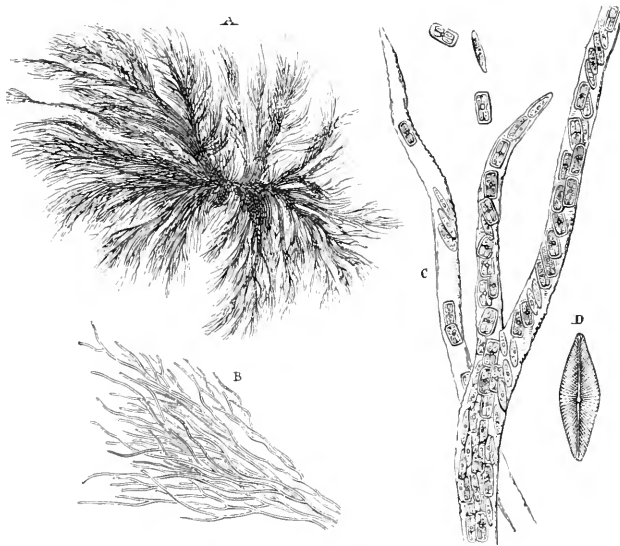

FIG. 464.—*Schizonema Grevillii*: A, natural size; B, portion magnified five diameters; C, filament magnified 100 diameters; D, single frustule.

example in the valves C, D, E, F (fig. 465), which would scarcely have been supposed to belong to the same specific type did they not occur upon the same stipe. The careful study of these varieties in every instance in which any disposition to variation shows itself, so as to *reduce* the enormous number of species with which our systematic treatises are loaded, is a pursuit of far greater real value than the *multiplication* of species by the detection of such minute differences as may be presented by forms discovered in newly explored localities; such differences as have already been pointed out being, probably, in a large proportion of cases, the result of the multiplication of some one form, which, under modifying influences that we do not yet understand, has departed from the ordinary type. The more faithfully and comprehensively this study is carried out in

any department of natural history, the more does it prove that the range of variation is far greater than had been previously imagined; and this is especially likely to be the case with such humble organisms as those we have been considering, since they are obviously more influenced than those of higher types by the conditions under which they are developed; whilst, from the very wide geographical range through which the same forms are diffused, they are subject to very great diversities of such conditions.

The general habits of this most interesting group cannot be better stated than in the words of Mr. W. Smith:—‘The

FIG. 465.

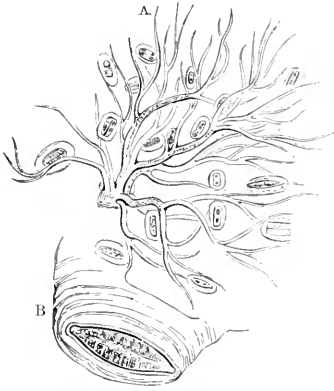

FIG. 466.

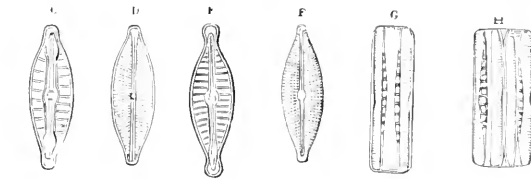

FIG. 465.—*Mastogloia Smithii*: A, entire stipe; B, frustule in its gelatinous envelope; C-F, different forms of frustule as seen in side view; G, front view; H, frustule undergoing subdivision.
FIG. 466.—*Mastogloia lanceolata*.

Diatomaceæ inhabit the sea or fresh water; but the species peculiar to the one are never found in a living state in the other locality; though there are some which prefer a medium of a mixed nature, and are only to be met with in water more or less brackish. The latter are often found in great abundance and variety in districts occasionally subject to marine influences, such as marshes in the neighbourhood of the sea, or the deltas of rivers, where, on the occurrence of high tides, the freshness of the water is affected by percolation from the adjoining stream, or more directly by the occasional overflow of its banks. Other favourite habitats of the *Diatomaceæ* are stones of mountain streams or waterfalls, and the shallow pools left by the

retiring tide at the mouths of our larger rivers. They are not, however, confined to the localities I have mentioned—they are, in fact, most ubiquitous, and there is hardly a roadside ditch, water-trough, or cistern, which will not reward a search and furnish specimens of the tribe.' Such is their abundance in some rivers and estuaries that their multiplication is affirmed by Professor Ehrenberg to have exercised an important influence in blocking up harbours and diminishing the depth of channels! Of their extraordinary abundance in certain parts of the ocean the best evidence is afforded by the observations of Sir J. D. Hooker upon the *Diatomaceæ* of the southern seas; for within the Antarctic Circle they are rendered peculiarly conspicuous by becoming enclosed in the newly formed ice, and by

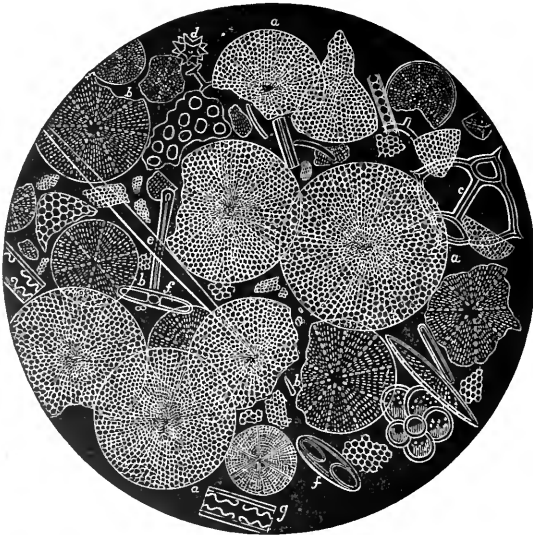

FIG. 467.—Fossil Diatomaceæ, &c., from Oran: *a, a, a, Coscinodiscus*; *b, b, b, Actinocyclus*; *c, Dictyocha fibula*; *d, Lithasteriscus radiatus*; *e, Spongolithis acicularis*; *f, f, Grammatophora parallela* (side view); *g, g, Grammatophora angulosa* (front view).

being washed up in myriads by the sea on to the 'pack' and 'bergs,' everywhere staining the white ice and snow a pale ochreous brown. A deposit of mud, chiefly consisting of the siliceous valves of *Diatomaceæ*, not less than 400 miles long and 120 miles broad, was found at a depth of between 200 and 400 feet on the flanks of Victoria Land in 70° south latitude. Of the thickness of this deposit no conjecture could be formed; but that it must be continually increasing is evident, the silex of which it is in a great measure composed being indestructible. A fact of peculiar interest in connection with this deposit is its extension over the submarine flanks of Mount Erebus, an active volcano of 12,400 feet elevation, since a communication between the ocean waters and the bowels of a volcano, such

as there are other reasons for believing to be occasionally formed, would account for the presence of *Diatomaceæ* in volcanic ashes and pumice which was discovered by Professor Ehrenberg. It is remarked by Sir J. D. Hooker that the universal presence of this microscopic vegetation throughout the South Polar Ocean is a most important feature, since there is a marked deficiency in this region of higher forms of vegetation; and were it not for them, there would neither be food for aquatic animals, nor (if it were possible for these to maintain themselves by preying on one another) could the ocean waters be purified of the carbonic acid which animal respiration and decomposition would be continually imparting to them.

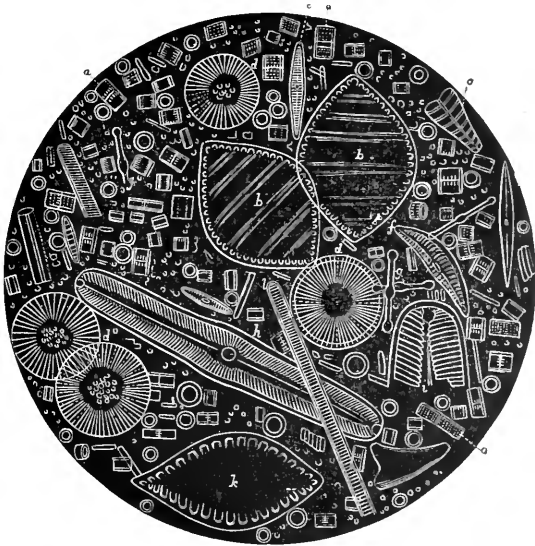

FIG. 468.—Fossil Diatomaceæ, &c., from Mourne Mountains, Ireland: *a, a, a*, *Gaillonella (Melosira) procera* and *G. granulata*; *d, d, d*, *G. biseriata* (side view); *b, b*, *Surirella plicata*; *c*, *S. craticula*; *k*, *S. caledonica*; *e*, *Gomphonema gracile*; *f*, *Cocconema fusidium*; *g*, *Tabellaria vulgaris*; *h*, *Pinnularia dactylus*; *i*, *P. nobilis*; *l*, *Synedra ulna*.

It is interesting to observe that some species of marine diatoms are found through every degree of latitude between Spitzbergen and Victoria Land, whilst others seem limited to particular regions. One of the most singular instances of the preservation of diatomaceous forms is their existence in guano, into which they must have passed from the intestinal canals of the birds of whose accumulated excrement that substance is composed, those birds having received them, it is probable, from shell-fish, to which these minute organisms serve as ordinary food.

The indestructible nature of the silicified casings of *Diatomaceæ* has also served to perpetuate their presence in numerous localities from which their living forms have long since disappeared: for the

accumulation of sediment formed by their successive production and death, even on the bed of the ocean or on the bottoms of fresh-water lakes, gives rise to deposits which may attain considerable thickness, and which, by subsequent changes of level, may come to form part of the dry land. Thus very extensive siliceous strata, consisting almost entirely of marine *Diatomaceæ*, are found to alternate, in the neighbourhood of the Mediterranean, with calcareous strata chiefly formed of *Foraminifera*, the whole series being the representative of the chalk formation of Northern Europe, in which the silex that was probably deposited at first in this form has undergone conversion into flint, by agencies hereafter to be considered. Of the diatomaceous composition of these strata we have a characteristic example in fig. 467, which represents the fossil *Diatomaceæ* of Oran in Algeria. The so-called 'infusorial earth' of Richmond in Virginia, and also that of Bermuda, both marine deposits, are very celebrated among microscopists for the number and beauty of the forms they have yielded; the former constitutes a stratum of eighteen feet in thickness, underlying the whole city, and extending over an area whose limits are not known. Several deposits of more limited extent, and apparently of fresh-water origin, have been found in our own islands; as, for instance, at Dolgelly in North Wales, at South Mourne in Ireland (fig. 468), and in the island of Mull in Scotland. Similar deposits in Sweden and Norway are known under the name of *Bergmehl*, or mountain-flour; and in times of scarcity the inhabitants of those countries are accustomed to mix these substances with their dough in making bread. This has been supposed merely to have the effect of giving increased bulk to their loaves, so as to render the really nutritive portion more satisfying; but as the *Bergmehl* has been found to lose from a quarter to a third of its weight by exposure to a red heat, there seems a strong probability that it contains organic matter enough to render it nutritious in itself. When thus occurring in strata of a fossil or sub-fossil character, the diatomaceous deposits are generally distinguishable as white or cream-coloured powders of extreme fineness.

For collecting fresh *Diatomaceæ* those general methods are to be had recourse to which have been already described. 'Their living masses,' says Mr. W. Smith, 'present themselves as coloured fringes attached to larger plants, or forming a covering to stones or rocks in cushion-like tufts—or spread over their surface as delicate velvet—or depositing themselves as a filmy stratum on the mud, or intermixed with the scum of living or decayed vegetation floating on the surface of the water. Their colour is usually a yellowish-brown of a greater or less intensity, varying from a light chestnut in individual specimens to a shade almost approaching black in the aggregated masses. Their presence may often be detected, without the aid of a microscope, by the absence, in many species, of the fibrous tenacity which distinguishes other plants; when removed from their natural position, they become distributed through the water, and are held in suspension by it, only subsiding after some little time has elapsed.' Notwithstanding every care, the collected specimens are liable to be mixed with much foreign matter: this may be partly got rid of by

repeated washings in pure water, and by taking advantage, at the same time, of the different specific gravities of the diatoms and of the intermixed substances, to secure their separation. Sand, being the heaviest, will subside first; fine particles of mud, on the other hand, will float after the diatoms have subsided. The tendency of living diatoms to make their way towards the light will afford much assistance in procuring the free forms in a tolerably clean state; for if the gathering which contains them be left undisturbed for a sufficient length of time in a shallow vessel exposed to the sunlight, they may be skimmed from the surface. Marine forms must be looked for upon seaweeds, and in the fine mud or sand of soundings or dredgings; they are frequently found also, in considerable numbers, in the stomachs of *Holothurizæ*, *Ascidians*, and *Salpæ*, in those of the oyster, scallop, whelk, and other testaceous molluscs, in those of the crab and lobster, and other *Crustacea*, and even in those of the sole, turbot, and other flat-fish. In fact, the diatom collector will do well to examine the digestive cavity of *any* small aquatic animals that may fall in his way, rare and beautiful forms having been obtained from the interior of *Noctiluca*. The separation of the diatoms from the other contents of these stomachs must be accomplished by the same process as that by which they are obtained from guano or the calcareous 'infusorial earths.' Of this the following are the most essential particulars: The guano or earth is first to be washed several times in pure water, which should be well stirred, and the sediment then allowed to subside for some hours before the water is poured off; since, if it be decanted too soon, it may carry the lighter forms away with it. Some kinds of earth have so little impurity that one washing suffices; but in any case it is to be continued so long as the water remains coloured. The deposit is then to be treated, in a flask or test-tube, with hydrochloric acid, and, after the first effervescence is over, a gentle heat may be applied. As soon as the action has ceased, and time has been given for the sediment to subside, the acid should be poured off and another portion added; and this should be repeated as often as any effect is produced. When hydrochloric acid ceases to act, strong nitric acid should be substituted; and after the first effervescence is over, a continued heat of about 200° F. should be applied for some hours. When sufficient time has been given for subsidence, the acid may be poured off and the sediment treated with another portion; and this is to be repeated until no further action takes place. The sediment is then to be washed until all trace of the acid is removed; and, if there have been no admixture of siliceous sand in the earth or guano, this sediment will consist almost entirely of *Diatomaceæ*, with the addition, perhaps, of sponge-spicules. The separation of siliceous sand and the subdivision of the entire aggregate of diatoms into the larger and the finer kinds, may be accomplished by stirring the sediment in a tall jar of water, and then, while it is still in motion, pouring off the supernatant fluid as soon as the coarser particles have subsided; this fluid should be set aside, and, as soon as a finer sediment has subsided, it should again be poured off; and this process may be repeated three or four times at

increasing intervals, until no further sediment subsides after the lapse of half an hour. The first sediment will probably contain all the sandy particles, with, perhaps, some of the largest diatoms, which may be picked out from among them; and the subsequent sediments will consist almost exclusively of diatoms, the sizes of which will be so graduated that the earliest sediments may be examined with the lower powers, the next with medium powers, while the latest will require the highest powers—a separation which is attended with great convenience.¹ It sometimes happens that fossilised diatoms are so strongly united to each other by siliceous cement as not to be separable by ordinary methods; in this case, small lumps of the deposit should be boiled for a short time in a weak alkaline solution, which will act upon this cement more readily than on the siliceous frustules; and as soon as the lump is softened, so as to crumble to mud, this must be immediately washed in a large quantity of water, and then treated in the usual way. If a very weak alkaline solution does not answer the purpose, a stronger one may then be tried. This method, devised by Professor Bailey, has been practised by him with much success in various cases.²

The mode of mounting specimens of *Diatomaceæ* will depend upon the purpose which they are intended to serve. If they can be obtained quite fresh, and if it be desired that they should exhibit, as closely as possible, the appearance presented by the living plants, they should be put up in aqueous media within cement-cells; but if they are not thus mounted within a short time after they have been gathered, about a tenth part of alcohol should be added to the water. If it be desired to exhibit the stipitate forms in their natural position adherent to other aquatic plants, the entire mass may be mounted in Deane's medium or in glycerin jelly, in a deeper cell; and such a preparation is a very beautiful object for the background illumination. If, on the other hand, the minute structure of the siliceous envelopes is the feature to be brought into view, the fresh diatoms must be boiled in nitric or hydrochloric acid, which must then be poured off (sufficient time being allowed for the deposit of the residue); and the sediment, after being washed, should be boiled in water with a small piece of soap, whereby the diatoms will be cleansed from the flocculent matter which they often obstinately retain.³ After a further washing in pure water, they are to be either mounted in balsam in the ordinary manner, or be set up 'dry' on a very thin slide. In order to obtain a satisfactory view of their markings, objectives of very large aperture are required, and all the improve-

¹ A somewhat more complicated method of applying the same principle is described by Mr. Okeden in the *Quart. Journ. Microsc. Science*, vol. iii. 1855, p. 158. The Author believes, however, that the method above described will answer every purpose.

² For other methods of cleaning and preparing diatoms, see *Quart. Journ. of Microsc. Science*, vol. vii. 1859, p. 167, and vol. i. n.s. 1861, p. 143; and *Trans. of Microsc. Soc.* vol. xi. n.s. 1863, p. 4. A little book entitled *Practical Directions for Collecting, Preserving, Transporting, Preparing, and Mounting Diatoms* (New York, 1877), containing papers by Professors A. Mead Edwards, Christopher Johnson, and Hamilton L. Smith, will be found to contain much useful information.

³ See Prof. H. L. Smith in *Amer. Journ. of Microscopy*, vol. v. 1880, p. 257. It is important that the soap should be free from kaolin, siliceous matter, or any other insoluble matter.

ments which have recently been introduced in the construction and mode of using the sub-stage condenser require to be put into practice. But to those who have the time, the will, and the appliances, there is a fine field now open for working, to a far higher point than we have touched at present, the true structure of such diatoms as can be made amenable to the powers possessed by our best recent optical appliances; and for the leisure of a professional or commercial man we know of no more suitable and attractive employment for the microscope. It will often be convenient to mount certain particular forms of *Diatomaceæ* separately from the general aggregate; but, on account of their minuteness, they cannot be selected and removed by the usual means. The larger forms, which may be readily distinguished under a simple microscope, may be taken up by a camel's-hair pencil which has been so trimmed as to leave two or three hairs projecting beyond the rest. But the smaller can only be dealt with by a single fine bristle or stout sable-hair, which may be inserted into the cleft end of a slender wooden handle; and if the bristle or hair should be split at its extremity in a brush-like manner it will be particularly useful. (Such split hairs may always be found in a shaving-brush which has been for some time in use; those should be selected which have their split portions so closely in contact that they appear single until touched at their ends.) When the split extremity of such a hair touches the glass slide, its parts separate from each other to an amount proportionate to the pressure: and, on being brought up to the object, first pushed to the edge of the fluid on the slide, may generally be made to seize it. A very experienced American diatomist, Professor Hamilton Smith, strongly recommends a thread of glass drawn out to capillary fineness and flexibility, by which (he says) the most delicate diatom may be safely taken up, and deposited upon a slide damped by the breath. For the selection and transference of diatoms under the compound microscope, recourse may be had to some of the forms of 'mechanical finger' which have been devised by American diatomists.¹

Phæosporeæ.—The greater number of the seaweeds exhibit a higher type of organisation than any that has hitherto been described. The old classification of seaweeds into *Melanosporeæ*, *Rhodosporeæ*, and *Chlorosporeæ*, according as their colouring matter is olive-brown, red, or green, cannot altogether be retained. Under the head of *Phæosporeæ* are now included a very large number of the brown and olive-brown seaweeds. In ascending this series we shall have to notice a *gradual differentiation* of organs, those set apart for reproduction being in the first place separated from those appropriated

¹ For a description of those of Prof. Hamilton Smith and Dr. Reznor, see *Journ. of Roy. Microsc. Soc.* vol. ii. 1879, p. 951, and that of Mr. Veeder, vol. iii. 1880, p. 700, of the same Journal.

[A very large number of observations have been made during recent years by Castracane, O. Müller, Lauterborn, Comber, Murray, Miquel, and others, on the structure of the diatom-valve, on the various modes of reproduction, and on the phenomena accompanying their apparently spontaneous powers of motion, and several schemes of classification of the genera have been proposed. On these, too numerous to mention here, and some of which still require confirmation, the reader should consult the successive volumes of the *Journal of the Royal Microscopical Society.*—Ed.]

to nutrition; while the principal parts of the nutritive apparatus, which are at first so blended into a uniform expansion or *thallus* that no real distinction exists between root, stem, and leaf, are progressively evolved on types more and more peculiar to each respectively, and have their functions more and more limited to themselves alone. Hence we find a 'differentiation,' not merely in the external form of organs, but also in their internal structure, its degree bearing a close correspondence to the degree in which their functions are respectively *specialised* or limited to particular actions. But this takes place by very slow gradations, a change of external form often showing itself before there is any decided differentiation either in structure or function. Thus in the simple *Ulveæ*, whatever may be the extent of the thallus, every part has exactly the same structure, and performs the same actions, as every other part, living *for* and *by* itself alone. And though, when we pass to the higher seaweeds, such as the common *Fucus* and *Laminaria*, we observe a certain foreshadowing of the distinction between root, stem, and leaf, this distinction is very imperfectly carried out, the root-like and stem-like portions serving for little else than the mechanical attachment of the leaf-like part of the plant. There is not yet any departure from the simple *cellular* type of structure, the only modification being that the several layers of cells, where many exist, are of different sizes and shapes, the texture being usually closer on the exterior and looser within, and that the texture of the stem and roots is denser than that of the leaf-like expansions or *fronds*. The cells of the *Phaeosporeæ* contain a substance closely resembling starch, and an olive-brown pigment, which they share with the *Fucaceæ*, known as *phyco-phavin* or *fuco-xanthin*. The group of olive-green seaweeds presents us with the lowest type in the family *Ectocarpaceæ*, which, notwithstanding, contains some of the most elegant structures that are anywhere to be found in the group, the full beauty of which can only be discerned by the microscope. Such is the case, for example, with *Sphacelaria*, a small and delicate seaweed, which is very commonly found growing upon larger algae, either near low-water mark or altogether submerged, its general form being remarkably characterised by a symmetry that extends also to the individual branches, the ends of which, however, have a decayed look. The apical cell of each branch is uncorticated, and frequently develops into a hollow chamber of considerable size, termed a *sphacelle*, and filled, when young, with a dark mucilaginous substance which, at a later stage, becomes watery. The *Sphacelariaceæ* are propagated in a non-sexual manner by peculiar buds or gemmæ known as *propagules*.

The ordinary mode of propagation of the *Phaeosporeæ* is by non-sexual zoöspores; and these are of two kinds, produced respectively in unilocular and multilocular zoösporangies. The former are comparatively large, nearly spherical, ovoid or pear-shaped cells, the contents of which break up into a large number of zoöspores. The multilocular zoösporangies have the appearance of jointed hairs, and are divided internally into a number of chambers, each of which gives birth to a single zoöspore. The zoöspores from the unilocular

sporangies appear in all cases to germinate directly, while those from the multilocular sporangies sometimes coalesce in pairs before germinating. The different families of *Phæosporæ* present a most interesting gradual transition from the conjugation of swarm-cells to the impregnation of a female 'oösphere' by male antherozoids. In *Ectocarpus*, *Giraudia*, and *Scytosiphon*, conjugation takes place between swarm-cells from the multilocular sporangies which appear to be exactly alike, but a slight differentiation is exhibited in one of them coming to rest and partially losing its cilia before conjugation takes place (fig. 469, II). Male sexual organs also occur in the *Sphacelariaceæ*, but no actual process of conjugation has as yet been observed. In *Cutleria* and *Zanardinia* the differentiation is more complete. The male and female swarm-cells are produced either on the same or on different individuals; the latter are much larger than the former, and come perfectly to rest, entirely losing their cilia before being impregnated by the former. In *Dictyota* the differentiation is carried still further, and the female reproductive bodies are true 'oöspheres,' being from the first motionless masses of protoplasm not provided with cilia, while the antherozoids exhibit motility only for a very short time, and each is provided only with a single cilium of unusual length. In the family *Laminariaceæ*, belonging to the *Phæosporæ*, are included many of the largest of the seaweeds, chiefly natives of southern seas, the frond often attaining enormous dimensions, and exhibiting rudimentary differentiation into rhizoids or organs of attachment, stem, and leaves. Such are *Lessonia*, which grows to a great height and resembles a branching tree with pendent leaves two or three feet long; *Macrocystis*, where the stalk like base of each branch of the leaf is hollowed out into a large pear-shaped air-bladder; *Nereocystis*, *Laminaria*, and others.

In the **Fucaceæ** the generative apparatus is contained in the globular 'conceptacles,' which are usually sunk in the tissue near the extremities of the fronds. In some species, as *Fucus platycarpus*, the same conceptacles contain both 'antherids' and 'oögones;' in others these two sexual elements are disposed in different conceptacles on the same plant; whilst in the commonest of all, *F. vesiculosus* (bladder-wrack), they are limited to different individuals. When a

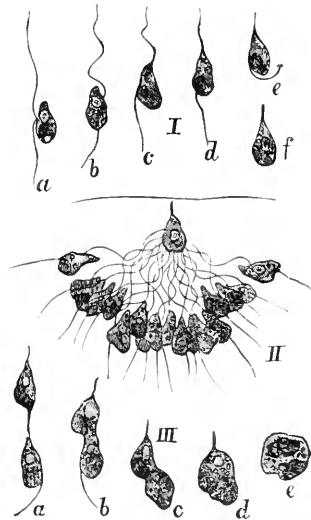

FIG. 469.—Process of conjugation in *Ectocarpus siliculosus*. (From Vines's 'Physiology.') I. a-f, the female zoöspore coming to rest; II, the female zoöspore at rest, surrounded by male zoöspores; III. a-c, fusion of male and female zoöspores.

section is made through one of the flattened conceptacles of *F. platycarpus*, its interior is seen to be a nearly globular cavity (fig. 470), lined with hairs, some of which are greatly elongated, so as to project through the pore by which the cavity opens on the surface. Among these are to be distinguished, towards the period of their maturity, certain filaments (fig. 471, A), the *antherids*, whose granular contents acquire an orange hue, and gradually shape themselves into oval bodies (B), each with an orange-coloured spot and two vibratile cilia of unequal length, placed laterally, which, when discharged by the rupture of the containing cell, have for a

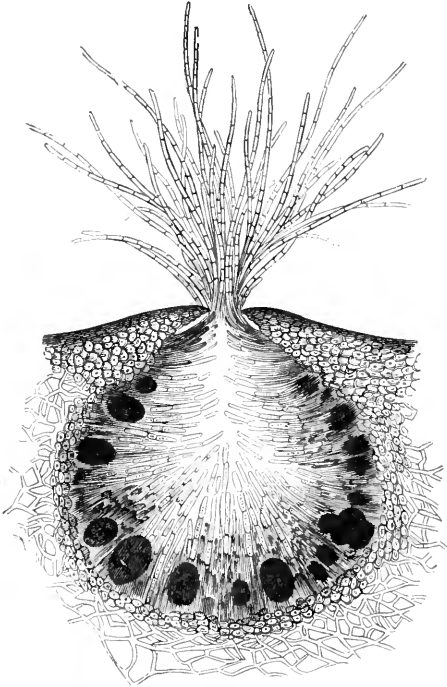

FIG. 470.—Vertical section of conceptacle of *Fucus platycarpus* lined with filaments, among which lie the antheridial cells and the oögones containing oöspheres.

time a rapid, undulatory motion whereby these *antherozoids* are diffused through the surrounding liquid. Lying amidst the mass of hairs, near the walls of the cavity, are seen (fig. 470) numerous dark pear-shaped bodies, which are the *oögones*, or parent-cells of the *oöspheres*. Each of these oögones gives origin, by binary subdivision, to a cluster of eight 'germ-cells' or oöspheres; and these are liberated from their envelopes before the act of fertilisation takes place. This act consists in the swarming of the antherozoids over the surface of the oöspheres, to which they communicate a rotatory motion by the vibration of their own cilia. In the hermaphrodite *Fuci* this takes place within the conceptacles, so that the oöspheres do not make

their exit from the cavity until after they have been fecundated; but in the monœcious and dioecious species each kind of conceptacle separately discharges its contents, which come into contact on their exterior. The antheridial cells are usually ejected entire, but soon rupture so as to give exit to the antherozoids; and the oögones also discharge their oöspheres, which, meeting with antherozoids, are fecundated by them. The fertilised *oöspores* soon acquire a new and firm envelope; and, under favourable circumstances, they speedily begin to develop themselves into new plants. The first change is

the projection and narrowing of one end into a kind of foot-stalk, by which the oöspore attaches itself, its form passing from the globular to the pear-shaped; a partition is speedily observable in its interior, its single cell being subdivided into two; and by a continuation of a like process of bipartition, first a filament and then a frondose expansion is produced, which gradually evolves itself into the likeness of the parent plant.

The whole of this process may be watched without difficulty by obtaining specimens of *F. vesiculosus* at the period at which the fructification is shown to be mature by the recent discharge of the contents of the conceptacles in little gelatinous masses outside their orifices; for if some of the oöspores which have been set free from the olive-green (female) conceptacles be placed in a drop of sea-water in a very shallow cell, and a small quantity of the mass of



FIG. 471.—Antherids and antherozoids of *Fucus platycarpus*: A, branching articulated hairs detached from the walls of the conceptacle, bearing antherids in different stages of development; B, antherozoids, some of them free, others still included in their antheridial cells.

antherozoids, set free from the orange-yellow (male) conceptacles, be mingled with the fluid, they will speedily be observed, with the aid of a magnifying power of 200 or 250 diameters, to go through the actions just described; and the subsequent processes of germination may be watched by means of the 'growing slide.'¹ The winter months, from December to March, are the most favourable for the observation of these phenomena; but where *Fuci* abound, some individuals will usually be found in fructification at almost any period of the year. This process of fertilisation usually takes place on fronds exposed to the air on the wet beach between high- and low-water mark; and, to assist in it, the comparatively heavy fronds of many *Fucaceæ* are buoyed up by air-cavities, which take the form of the well-known 'bladders' of the 'bladder-wrack' and

¹ A shallow cell should be used, so as to keep the pressure of the thin glass from the minute bodies beneath, whose movements it will otherwise impede.

other species of *Fucus*, imbedded in the frond, and the 'berries' of *Sargassum bacciferum*, the 'gulf-weed' of the Atlantic, which are elevated on pedicels above the surface of the water. The whole substance of the *Fucaceæ*, including the reproductive organs, is coloured brown by fuco-xanthin, the same pigment as that which is found in the *Phaeosporeæ*.

Among the **Florideæ**, or red seaweeds, also, we find various simple but most beautiful forms, which connect this group with the lower algæ, especially with the family *Coleochaetaceæ*; such delicate feathery or leaf-like fronds belong for the most part to the family *Ceramiceæ*, some members of which are found upon every part of

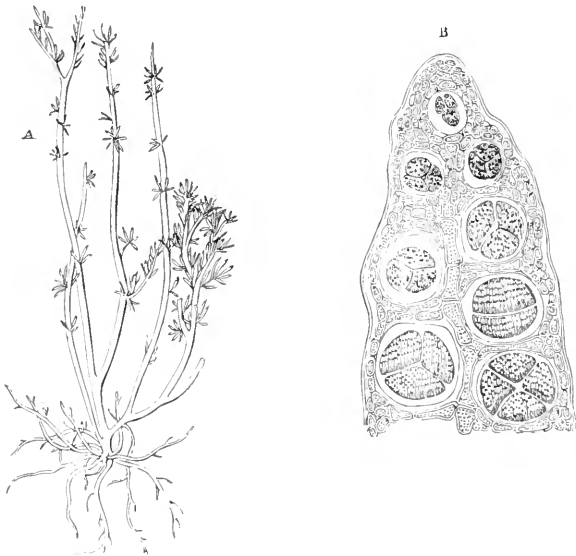

Fig. 472.—Arrangement of tetraspores in *Carpocaulon mediterraneum*: A, entire plant; B, longitudinal section of spore-bearing branch. (N.B.—Where only three tetraspores are seen, it is merely because the fourth did not happen to be so placed as to be seen at the same view.)

our coasts, attached either to rocks or stones or to larger algæ, and often themselves affording an attachment to zoöphytes and polyzœa. They chiefly live in deeper water than the other seaweeds, and their richest tints are only exhibited when they grow under the shade of projecting rocks or of larger dark-coloured algæ. Hence, in growing them artificially in aquaria, it is requisite to protect them from an excess of light, since otherwise they become unhealthy. Various species of the genera *Ceramium*, *Griffithsia*, *Callithamnion*, and *Ptilota* are extremely beautiful objects for low powers when mounted in glycerin jelly. In many of them the phenomenon to which we have previously referred under the name of 'continuity of protoplasm' is very beautifully exhibited. The colour of the red

seaweeds is due to the presence of a pigment known as *rhodosperrin* or *phycoc-erythrin*, soluble in fresh water, which may be separated in the form of beautiful regular crystals.

The only mode of propagation which was until recently known to exist in this group of seaweeds is the production and liberation of *tetraspores* (fig. 472, B), formed by two successive binary subdivisions of the contents of special cells, which sometimes form part of the general substance of the frond, but sometimes congregate in particular parts or are restricted to special branches. If the second binary division takes place in the same direction as the first, the tetraspores are arranged in linear series; but if its

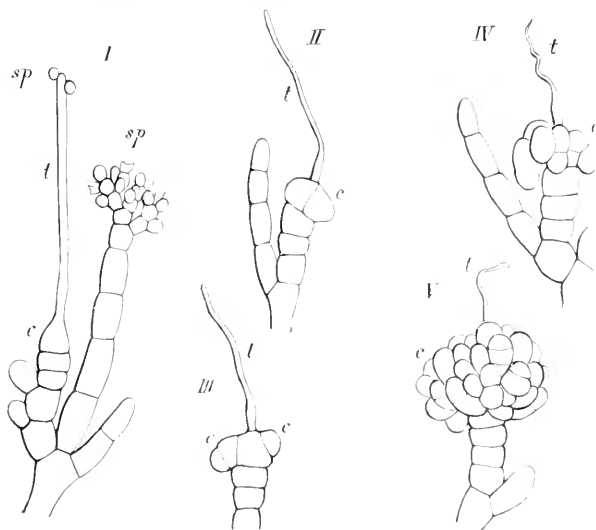

FIG. 473.—*Nemalion multifidum*: I, a branch with a carpogone, *c*, and pollinoids, *sp*; II, III, commencement of the formation of the fructification; IV, V, development of the spore-cluster; *t* denotes the trichogyne, *c* the carpogone and fructification. (From Goebel's 'Outline of Classification,' The Clarendon Press.)

direction is transverse to that of the first, the four spores cluster together. These, when separated by the rupture of their envelope, do not comport themselves as zoospores; but, being destitute of propulsive organs, are passively dispersed by the motion of the sea itself. Their production, however, taking place by simple cell-division, and not being the result of any form of sexual conjugation, the tetraspores of the *Florideæ* must be regarded, like the zoospores of the *Ulvacææ*, as *gonoids*, analogous rather to the *buds* than to the *seeds* of higher plants. It is now known that a true sexual process takes place in this group; but the sexual organs are not usually found on the plants which produce tetraspores. Antherial cells are found, sometimes on the general surface of the frond, more commonly at the ends of branches, and occasionally in special conceptacles. Their contents, however, are not motile

antherozoids, but minute rounded particles, known as *pollinoids* or 'spermatia,' having no power of spontaneous movement. Sometimes on the same individuals as the antherids, and sometimes on different ones, are produced the female organs, which curiously prefigure the pistil in flowering plants. This organ is known as the *procarp*, and consists, in its simplest form, e.g. in *Porphyra*, the 'purple laver,' of a single cell with a lateral hair-like appendage, the *trichogyne*. In the higher forms it is composed of one or more fertile cells constituting the *carpogone*, and one or more sterile cells which make up the *trichophore*, and convey the fertilising substance from the trichogyne to the carpogone. Fertilisation is effected by the attachment of one of the pollinoids to the trichogyne, the walls of which are absorbed at that spot, so that the fertilising material passes down its tube to the trichophore, and thence to the carpogone; one of the cells of the carpogone contains the oosphere, which, after fertilisation, breaks up into a number of *carpospores*; round these is frequently formed a hard investment, and this structure is then known as a *cystocarp*; from it the carpospores ultimately escape, and then germinate. In the true *Corallines*, which are *Florideæ* whose tissue is consolidated by calcareous deposit, not only the tetraspores, but also both kinds of sexual organ, are produced in cavities or *conceptacles*, imbedded in the thallus or forming wart-like swellings; the female conceptacle opens by a terminal orifice or *ostiole*; the pollinoids are furnished with wing-like appendages. In a considerable number of the red seaweeds, as, for example, in *Dulresnaya*, the process of fertilisation is more complex than this, and consists of two distinct stages. First the trichogyne is impregnated by the pollinoids; and secondly, the fertilising principle is then conveyed from the trichophore-cells at the base of the trichogyne to the cells which ultimately produce the carpospores, and which may be at a considerable distance from the trichogyne, even on a different branch. This transference is effected by means of long simple or branched tubes which are known as 'fertilising tubes.' The late Professor F. Schmitz held that, in the higher *Florideæ*, there are two acts of fertilisation, that of the pollinoid with the trichogyne, and that of the fertilising tube with the cells which produce the carpospores; but this view is not accepted by all authorities; and it is doubtful whether more than one true act of fertilisation, *i.e.* the fusion of male and female nuclei, takes place. The sexual mode of reproduction has, however, at present been observed in comparatively few species of seaweed; and considering the number of species of *Florideæ* found on our coasts, there is no branch of microscopical observation which is more likely to reward the young investigator with new discoveries.

CHAPTER IX

FUNGI

FUNGI, as already mentioned, differ essentially from algae in the absence of chlorophyll, and therefore in the absence of any power of directly forming starch or other similar substance by the mutual decomposition of carbonic acid and water, accompanied by evolution of oxygen. They must therefore, in all cases, be either *saprophytes* or *parasites*, deriving their nourishment from already organised food-materials, either, in the former case, from decaying animal or vegetable substances, or, in the latter case, from the living tissues of other plants or of animals. Fungus-parasites are the cause of most of the diseases to which plants, and of a large number of those to which animals, are subject.

The individual fungus always consists of one or more *hyphæ*, slender filaments containing protoplasm and a nucleus (except possibly in some of the most simple forms), but no chlorophyll and rarely any pigment. The cell-wall is composed of a substance differing somewhat in its properties from ordinary cellulose, since it is not coloured blue by iodine after treatment with sulphuric acid; it is known as *fungus-cellulose*. These hyphæ may be quite distinct or very loosely attached to one another; those which penetrate the soil, or the tissue of the 'host' on which the fungus is parasitic, constitute the *mycelæ*. In the larger fungi, such as the mushroom, the portion above the soil is composed of a dense mass of these hyphæ, lying side by side, constituting a so-called *pseudo-parenchymæ*, but never a true tissue. In some families the hyphæ have a tendency to become agglomerated into balls of great hardness called *sclerotes*, which have the power of maintaining their vitality for very long periods. The modes of reproduction of fungi, both sexual and non-sexual, are very various. Among the latter the most common are by non-motile *spores* or *gonids*, and by *zoospores*. The former are very minute bodies, each composed of a single cell, or less often of several cells, which are either formed within a spore-case or *sporangium*, or are detached from the extremity of hyphæ by a process of pinching off or *abstriction*. From their extreme lightness they are wafted through the air in enormous numbers, and thus bring about the extraordinarily rapid spread of many fungi, such as moulds. The zoospores are, like those of the lower algae, minute naked masses of protoplasm provided with one or more vibratile cilia, by means of which they move very rapidly through water, and finally force their way into the tissue of the host, where the zoospore loses its cilia,

invests itself with a cell-wall, and proceeds to germinate. This is effected, both in the case of the zoöspores and in that of the ordinary spores, by putting out a *germinating filament*, which ultimately develops into the new fungus plant. In a large number of fungi no process of sexual reproduction is known. The various modes which do occur will be described under the separate families.

Some families of fungi are characterised by the remarkable phenomenon known as *alternation of generations*. Each species occurs in two (or sometimes three) perfectly distinct forms, which bear no resemblance to one another, and were long supposed to belong to widely separated families. Each phase or 'generation' has its own mode of reproduction, but does not reproduce its own special form, but the other or one of the other forms; and two or three generations are thus required to complete the cycle. Each member of the cycle is, generally speaking, parasitic on a totally different plant from the 'host' of the other forms.

The classification of fungi is attended with very great difficulties, owing to our still imperfect acquaintance with the mode of reproduction in several of the groups. The following are the more distinct and remarkable types: ¹—

The **Myxomycetes**, Myxogastres, or Mycetozoa, are a group of very singular organisms, on the very confines of the animal and vegetable kingdoms, doubtfully included among the fungi, and believed by many to have a closer affinity to the rhizopods. They appear, indeed, at one period of their life-history to have an animal, at another period a vegetable mode of existence. Several species are not uncommon on decayed wood, bark, heaps of decaying leaves, &c. The 'plasmode' of *Æthalium septicum*, known as 'flowers of tan,' forms yellow flocculent masses in tan-pits. The development of other species is represented in fig. 474. Commencing with the germination of the spores, each *spore* is a spherical cell (C) enclosed in a delicate membranous wall; and when it falls into water this wall undergoes rupture (D), and an amoeba-like body (E) escapes from it, consisting of a little mass of protoplasm, with a round central nucleus enclosing a nucleole and a contractile vesicle, and having amoeba-like movements connected with the protrusion and withdrawal of peculiar processes or pseudopodes. This soon elongates (F), and becomes pointed at one end, whence a long *flagellum* is put forth, the lashing action of which gives motion to the body, which may now be termed a *swarm-spore*. After a time the flagellum disappears and the active movements of the spore cease; but it now begins again to put forth and to withdraw finger-like pseudopodes, by means of which it creeps about like an *Amaba*, and feeds like that rhizopod upon solid particles which it engulfs within its soft protoplasm. These swarm-cells may multiply by bipartition to an indefinite extent; but after a time 'conjugation' takes place between two of these *myxamoeba* (H), their substance undergoing a complete fusion into one body (I).

¹ [The classification of fungi here adopted is essentially that of De Bary in his *Comparative Morphology and Biology of the Fungi, Mycetozoa, and Bacteria*. Owing to the very large recent additions to our knowledge of the structure of fungi, it has been found necessary entirely to rearrange this portion of Dr. Carpenter's work.—Ed.]

from which extensions are put forth (J); and by the union of a number of these bodies are produced the motile protoplasmic bodies known as *plasmodes*, the ordinary form in which these singular bodies are known. These continue to grow by the ingestion and assimilation of the solid nutriment which they take into their substance; and, by the ramification and inoculation of these extensions, a complete network is formed.

The filaments of this network exhibit active undulatory move-

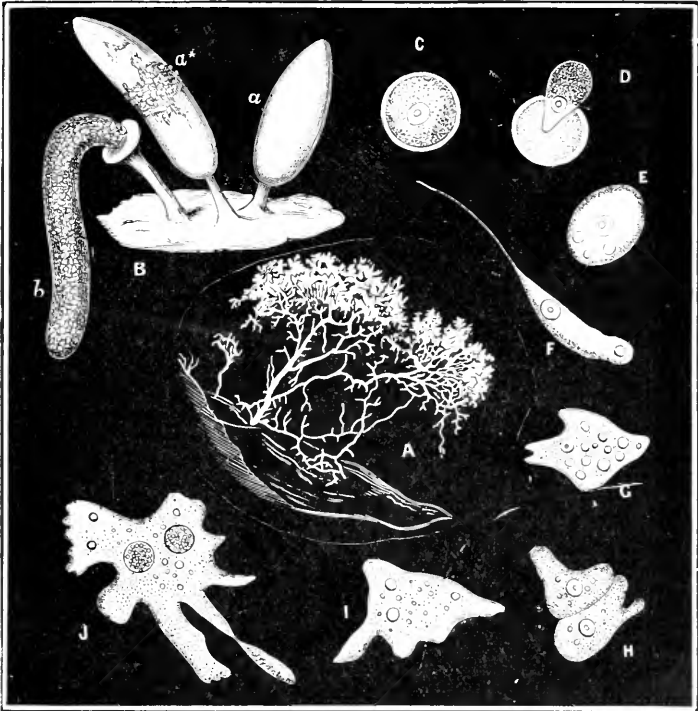

FIG. 474.—Development of *Myxomycetes*: A, plasmode of *Didymium serpylla*; B, successive stages, *a*, *a'*, *b*, of sporanges of *Arcyria flava*; C, ripe spore of *Physarum album*; D, its contents escaping; E, F, G, the swarm-spore first becoming flagellated, and then amoeboid; H, conjugation of two amoeboids, which, at I, have fused together, and, at J, are beginning to put out extensions and ingest nutriment, of which two pellets are seen in its interior.

ments, which in the larger ones are visible under an ordinary lens, or even to the naked eye, but which it requires microscopic power to discern in the smaller. With sufficiently high amplification, a constant movement of granules may be seen flowing along the threads, and streaming from branch to branch. Here and there offshoots of the protoplasm are projected, and again withdrawn, in the manner of the pseudopodes of an *Amoeba*; while the whole organism may be occasionally seen to abandon the support over which it had grown,

and to creep over neighbouring surfaces, thus far resembling in all respects a colossal ramified *Amœba*. The plasmodes are often found to have taken up into them and enclosed a great variety of foreign bodies, such as the spores of fungi, parts of plants, &c. They are curiously sensitive to light, and may sometimes be found to have retreated during the day to the dark side of the leaves, or into the recesses of the tan over which they had been growing, and again to creep out on the approach of night. Under certain conditions the swarm-spores may lose their power of motion and become encysted; they are then known as *microcysts*, and may remain in this resting condition for a considerable time, especially if desiccated. If again placed in water, they return to their motile swarming state. The plasmodes may also enter a resting state, in which they assume a wax-like consistence, and dry up into a brittle horny mass. They are then known as *sclerotes*. In a few genera the spores are not contained in sporanges, but are borne on external supports or *sporophores*. But in the great majority of genera the plasmode becomes ultimately transformed into *sporangies* (B. *a*, *a'*, *b*); either each plasmode becomes a single sporange, or it divides into a larger or smaller number of pieces, each of which undergoes this transformation. When mature, the cavity of the sporange is either entirely filled with the very numerous *spores*, or in most genera tubes or threads of different forms occur among the spores, and constitute the *capillitium*. These capillitium-tubes have often a spiral appearance, owing to irregular thickenings of the cell-wall, and are very beautiful objects under the microscope. The growth of many species of *Myxomycetes* is exceedingly rapid, going through their whole cycle of development, with its various phases, in the course of a few days.

The **Chytridiaceæ** are a group of minute microscopic fungi showing an affinity in some respects to the Myxomycetes, and even to the infusorial animalcules. Their ordinary mode of propagation is by zoospores bearing one or two cilia, which either germinate directly or conjugate to produce a resting-spore. They are parasitic on fresh-water organisms, both animal and vegetable; and their chief interest to the microscopist is that their zoospores have apparently frequently been mistaken for antherozoids of the 'host.'

The **Ustilagineæ** are fungi parasitic on flowering plants, attacking the stem, leaves, and other parts, where they form brown or yellow spots. They are often exceedingly destructive to vegetation, causing the diseases of cereal crops known as bunt, smut, &c. The course of development of these fungi is not yet in all cases accurately known. The mycele, consisting of slender segmented hyphæ, spreads extensively within the tissues of the host, and bears spores which either reproduce the mycele again directly, or with the intervention of so-called 'sporids.'

The **Uredineæ** afford the most remarkable illustration among fungi of the phenomenon already mentioned, that of *alternation of generations*; forms previously considered to belong to widely separated groups being now known to be stages in the cycle of development of the same species. A striking instance of this is furnished by the well-known and very destructive disease of wheat and other grasses

known as 'mildew,' produced by the attacks of the parasitic fungus *Puccinia graminis*. It was long ago observed that wheat was especially liable to this disease in the vicinity of barberry bushes; and it is now known that a fungus parasitic on barberry leaves, formerly known as *Æcidium berberidis*, is the 'æcidiospore' generation of the same species of which *Puccinia graminis* is the 'teleutospore'

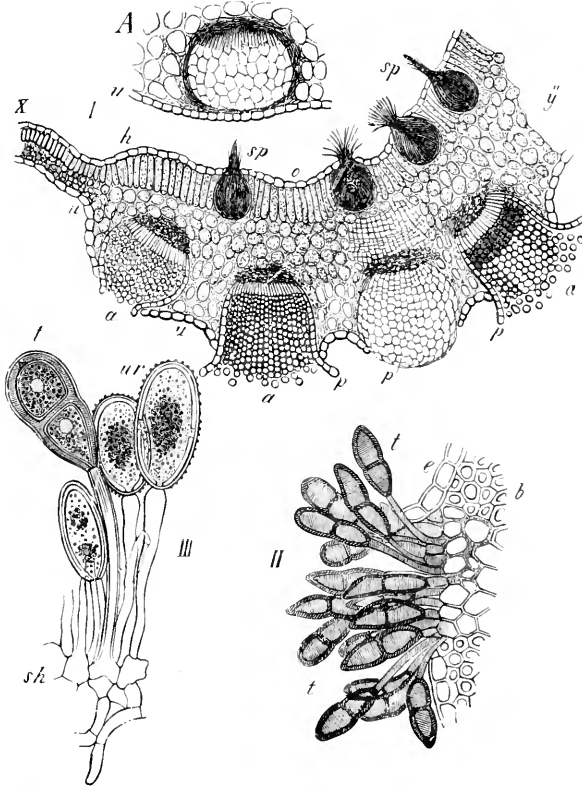

FIG. 475. — *Puccinia graminis*. From De Bary's 'Comparative Morphology and Biology of the Fungi.' (The Clarendon Press.) A, portion of leaf of *Berberis* with young aecidium; I., section through leaf containing aecidia; sp, spermatogones; a, aecidia opened; p, peridium; II., group of ripe teleutospores bursting through the epiderm e in leaf of *Triticum repens*; t, teleutospores; III., teleutospores t, and uredospores ur; I. slightly magnified; II. $\times 190$; III. $\times 390$.

generation. The complete cycle of development of the best known *Uredinea*, such as the mildew (fig. 475), is this. The form known as *Puccinia graminis* produces *teleutospores*, thick-walled spores, borne usually in pairs, at the extremity of elongated cells known as *basids* or *sterigmata*. Each of these teleutospores gives rise, on germinating within the tissue of the grass, to a hypha or *promycete*, the terminal cells of which develop, on slender basids, each a single spore or

sporid. These sporids will germinate only on the leaves of the barberry, where they produce, first of all, a mass of interwoven hyphae within the tissue, and then the peculiar reproductive bodies known as *aecidia* (fig. 476). The 'aecidium' is a cup-shaped receptacle of a bright red or yellow colour, which breaks through the epiderm of the leaf, and discharges a large number of *aecidiospores*, which are produced in rows or chains springing from basids at the base of the receptacle. These are accompanied, often on the other surface of the leaf, by *spermogones*, smaller spherical or flask-shaped receptacles, which also eventually break through the epiderm, and are filled with barren hyphae known as *paraphyses*. Among these are other shorter hyphae or 'sterigmata,' from the extremities of which are abstricted narrow ellipsoidal cells, the *spermatia*. The purpose of these is unknown; but they may be male elements which have lost their function. The aecidiospores will germinate only on the leaves and stems of grasses, either producing the teleutospore-form directly, or

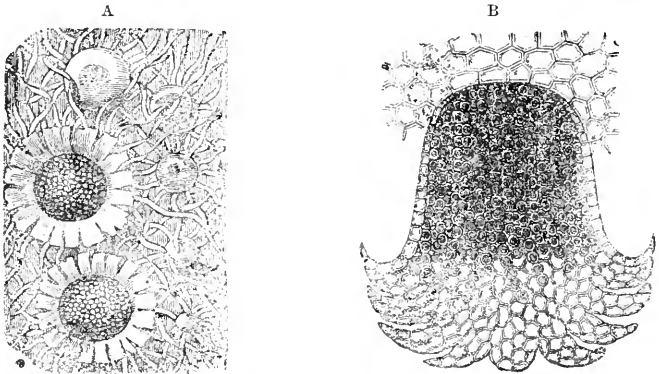

FIG. 476.—*Aecidium tussilaginis*: A, portion of the plant, magnified; B, section of one of the 'aecidia' with its spores.

giving rise to a third 'uredo-form.' This consists of filiform basids, each of which bears a round oval spore, the *uredospore*, which germinates very rapidly, constantly reproducing the same form. The same mycelé which produces the uredo-form also gives rise subsequently to the teleutospore-form. The fungus usually hibernates and remains in a state of rest in the teleutospore-form.

Of the **Peronosporæ** (fig. 477) some species grow on the dead bodies of animals and on dead plants, others are parasitic in the living tissues of flowering plants, causing widespread diseases, such as the potato-blight. On the mycelé, consisting of a number of distinct septated hyphae, are produced the sexual organs, *oögonies* and *antherids*. Fertilisation is not effected by means of motile antherozoids, as in other classes of fungi and of algae, but the antherid puts out a cylindrical or conical tube-like process, the *fertilisation-tube*. The antherids and oögonies are each single enlarged cells produced in close proximity to one another; the fertilisation-tube is produced from the part of the antherid which is in immediate contact with

the oögone, and discharges into the latter the contents of the antherid, thus causing its protoplasmic contents or 'oösphere' to develop into the impregnated 'oöspore.' The further history of the oöspore is singularly different, even in different species of the same genus. In some it germinates directly into a new mycele; in others it breaks up into a number of swarm-spores or zoöspores; each of these comes to rest, and after a time germinates into a new mycele. In

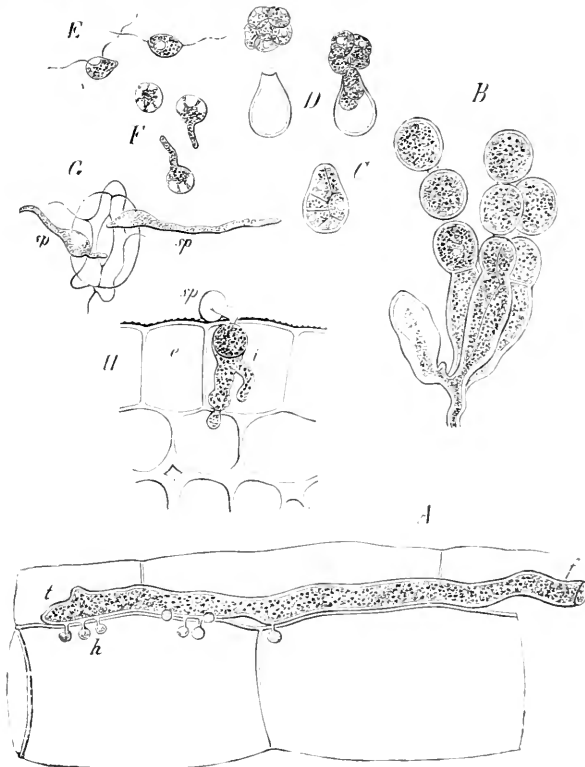

FIG. 477.—A-G, *Cystopus candidus*; H, *Phytophthora infestans*. A, branch of mycele growing at the apex *t*, with haustoria, *h*, between the cells of the pith of *Lepidium sativum*; B, branch of mycele bearing gonids; C, D, E, formation of swarm-spores from gonids; F, swarm-spores germinating; G, swarm-spores germinating on a stomate and piercing the epiderm of the stem of a potato at H. After De Bary; magnified about 400 times. From 'Outlines of Classification and Special Morphology of Plants,' by Dr. K. Goebel.

addition to the sexual organs of reproduction, many species of Peronosporæ also produce non-sexual spores or gonids, which are borne on special branches springing erect from the mycele, the sporophores or gonidiophores. A similar difference is exhibited in the further development of these spores. Either they germinate directly in water into a new mycele, or the protoplasmic contents break up into a number of zoöspores which germinate in the same way. In those

species which are parasitic on living plants, such as *Phytophthora infestans*, which produces the potato-disease, and *Cystopus candidus*, very common on cress and other cruciferous plants, the rapid spread of the disease is caused by the great facility with which the spores are disseminated by the wind; falling on leaves in moist weather, they there germinate; the germinating tube passes through a

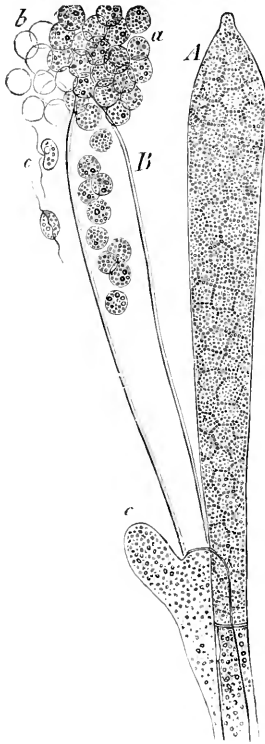

FIG. 478.—Two zoösporanges of *Achlya*. From Goebel's 'Outlines of Classification and Special Morphology.' A, still closed; B, open to discharge the zoöspores; a, zoöspores ejected, but still resting; c, zoöspores which have left their membrane at b behind them. Magn. about 300.

stomate, and the mycele is developed with great rapidity within the tissue of the host. The most favourable condition in the case of the potato-disease is said by Professor De Bary to consist in an undue thinness of the cuticle, accompanied by excessive humidity, whereby the spores of the fungus will germinate on the surface of the plant, sending out processes which penetrate to its interior, though otherwise germinating only on cut surfaces.

The **Saprolegnieæ** are saprophytic or parasitic fungi, nearly allied to the *Peronosporæ*, and differing from them chiefly in two points: although organs are known in many species closely resembling the antherids of the *Peronosporæ*, the act of impregnation has not actually been observed, the oöspore being, at least in many cases, apparently produced *parthenogenetically*, i.e. without impregnation. In some species a single oöspore is produced within each oögone; but more often the contents of the latter break up into a number of oöspores, each of which gives rise to a mycele, or breaks up into zoöspores. In some genera, e.g. *Achlya* (fig. 478), zoöspores are also produced in very large numbers by the breaking-up of the contents of zoösporanges, special enlarged cells of the mycele. The well-known salmon disease is caused by the attacks of the parasitic *Saprolegnia ferax* on the living flesh of the animal.

The **Mucorini** are filamentous fungi, resembling the two last orders in their vegetative development, but differing in their mode of reproduction. To this family belong some of the most common moulds which make their appearance on damp or decaying organic substances. The ordinary mode of non-sexual reproduction is by *endogenous spores*, produced within a sporange (fig. 479, A). The sporanges are borne at the ends of sporangiophores, long, erect, unseptated hyphae, springing directly from the mycele or from the original germinating filament. Several other kinds of non-

sexual spores occur in the family, including *chlamydozoospores*, reproductive cells formed within the ordinary cells of the hyphae. Sexual reproduction takes place by means of *zygospores* (C), but is at present known only in a few species. Either from ordinary hyphae or from sporangiophores spring a pair of short branches, the extremities of which become firmly attached to one another. These

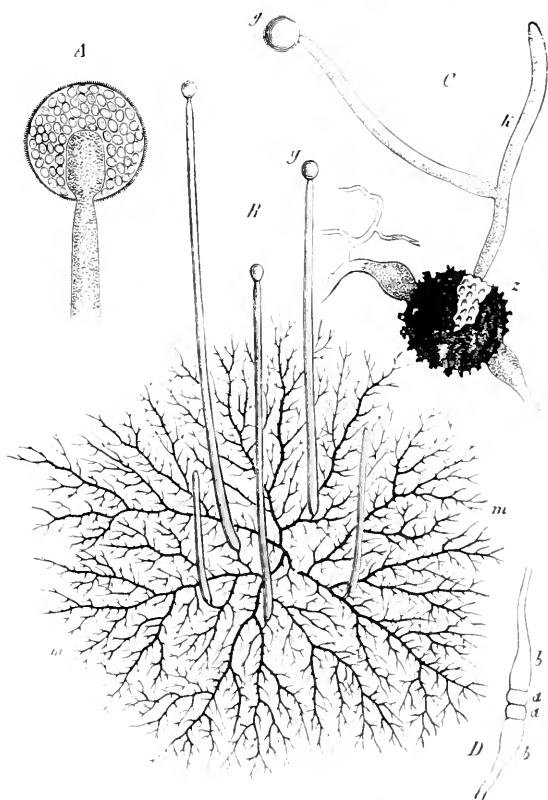

FIG. 479.—B, mycelium (three days old) of *Phycomyces nitens*, grown in a drop of mucilage with a decoction of plums; the finest ramifications are omitted; *g*, the conidiophore of *Mucor mucedo* in optical longitudinal section; C, a germinating zygospore of *Mucor mucedo*: the germ-tube, *k*, puts out a lateral conidiophore, *g*. In D are conjugating branches, *bb*, the extremities of which, *aa*, though they have not yet coalesced, are already cut off by transverse walls; the zygospore is formed from the coalescence of the cells *aa*. A, C, D, after Brefeld, greatly magnified; B, from nature, slightly magnified. From Goebel's 'Outlines of Classification and Special Morphology.'

swell out greatly into an obconical form, on account of the passage into them of a large amount of nutrient material. A larger or smaller piece is then cut off from each of them by a transverse wall: the median cell-wall which separates them disappears, and the two terminal portions thus cut off coalesce to form the zygospore,

which often swells to a considerable size, and its outer coat becomes frequently beautifully covered with warts or other protuberances. After a period of rest the zygosporer germinates, its inner coat of cellulose bursting through the outer warty and cuticularised *epispore*, and developing into the first germinating filament.

Very nearly allied to the Mucorini are the **Entomophthorææ**, parasitic fungi, the mycelium of which develops within the bodies of living insects, especially caterpillars and flies, and after death spreads outside the body as a flocculent felt. An example of this family of fungi is frequently presented in the destruction of the common house-fly by *Empusa muscæ*. In its fully developed condition the spore-bearing filaments of this plant stand out from the body of the fly like the 'pile' of velvet, and the spores thrown off from these in all directions form a white circle round it, as it rests motionless on a window-pane. The filaments which show themselves externally are the fructification of the fungus which occupies the interior of the fly's body, and this originates in the spores which find their way into the circulating fluid from without. A healthy fly shut up with a diseased one takes the disease from it by the deposit of a spore on some part of its surface; for this, beginning to germinate, sends out a process which finds its way into the interior, either through the breathing-pores or between the rings of the body; and, having reached the interior cavities, it gives off the germinating filaments which constitute the earliest stage of the *Empusa*. Again, it is not at all uncommon in the West Indies to see individuals of a species of *Polistes* (the representative of the wasp of our own country) flying about with plants of their own length projecting from some part of their surface, the germs of which have probably been introduced (as in the preceding case) through the breathing-pores at their sides, and have taken root in their substance, so as to produce a luxuriant vegetation. In time, however, this fungus growth spreads through the body and destroys the life of the insect; it then seems to grow more rapidly, the decomposing tissue of the dead body being still more adapted than the living structure to afford it nutriment.

The **Ascomycetes** include an enormous number of species, most of which are parasitic on living, or saprophytic on decaying leaves, many of them microscopic. The mycelium always consists of branched and septated hyphae. In only a comparatively few species is a sexual mode of reproduction known; the special character of the group is the non-sexual reproduction of *ascospores* within elongated sacs or tubes known as *asci*. These are commonly collected together in masses; the collection of hyphae which give birth to the asci is known as the *hymenium*, the mass of tissue enclosing or bearing the hymenia as the *receptacle* or *fructification*. Its form and structure vary greatly in the different sections of the family. The ascospores are always produced within the ascus by free-cell formation, and their number is almost always four or a 'power' of four, most commonly eight, occasionally less than four. The asci are usually surrounded by enlarged club-shaped or sterile hyphae, the *para-*

physes. In many Ascomycetes, in addition to the ascospores, ordinary exogenous *spores* or conids are produced at the extremity of *sporophores* or conidiophores (fig. 480, A). This is the case with a large number of moulds or mildews, of which the common blue mould, *Penicillium glaucum*, may be taken as a type. The familiar form of these moulds is that in which they produce these spores in enormous quantities; but, under certain conditions, especially when the supply of nutriment is limited, the sexual mode of reproduction

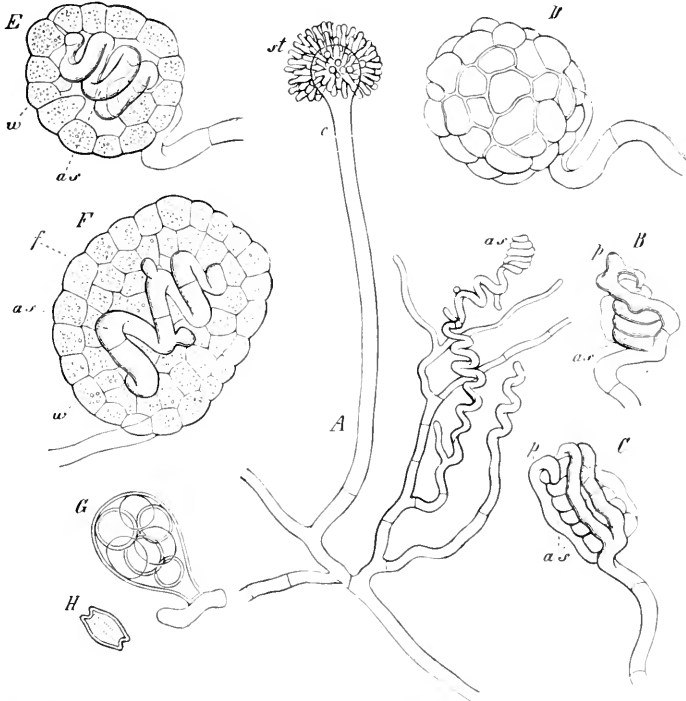

FIG. 480.—Development of *Eurotium repens*: A, small part of a mycele with the conidiophore, *c*, and young ascogones, *as*; B, the spiral ascogone, *as*, with the antheridial branch, *p*; C, the same with the filaments beginning to grow round it to form the wall of the sporocarp; D, a sporocarp seen from without; E, F, young sporocarp in optical longitudinal section; *w*, parietal cells; *f*, the filling tissue (pseudo-parenchymatous); *as*, the ascogone; G, an ascus; H, an ascospore. After De Bary. A, magnified 190, the rest 600 times.

sets up (fig. 480, B–H). One of the branches of the mycele elongates, and coils spirally upon itself into a corkscrew-like body, the carpogone or *ascogone*, which constitutes the female organ; whilst another branch acts as the male organ or antherid, extending itself over the spire and impregnating the ascogone by the passage of its protoplasm into the latter organ. The structure thus formed becomes enclosed in a mass of sterile tissue, and within this are developed the asci, each containing numerous spores, which

germinate directly into a new mycele. The enveloping tissue, together with the asci, is known as the *sporocarp*. In a large number of Ascomycetes the asci are, however, formed without any previous sexual process that has yet been detected. According to the structure of the mature sporocarp, the Ascomycetes may be arranged under three sections: the *Discomycetes*, in which the sporocarp is exposed, and is then known as an *apothecae*; the *Pyrenomycetes*, in

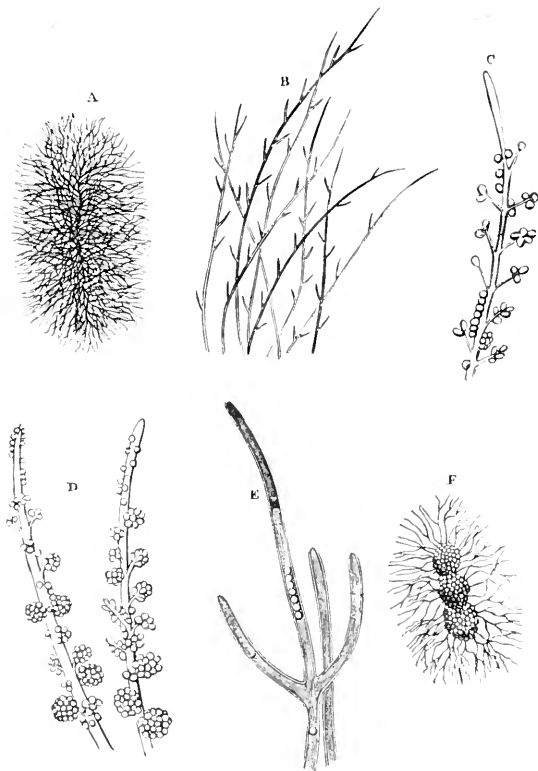

FIG. 481.—*Botrytis bassiana*: A, the fungus as it first appears at the orifices of the stigmas; B, tubular filaments bearing short branches, as seen two days afterwards; E, magnified view of the same; C, D, appearance of filaments on the fourth and sixth days; F, masses of mature spores falling off the branches, with filaments proceeding from them.

which the *perithece* is enclosed in a flask-shaped cavity with open neck; and a third section, in which the sporocarps are completely enclosed.

In some Ascomycetes a tendency is exhibited to the formation of sclerotes, dense hardened masses of interwoven hyphæ. An example of this is furnished by the structure known as 'ergot,' the sclerote of a fungus of this kind, *Claviceps purpurea*, which attacks the ovary

of rye and other grasses. Many species of *Peziza* have a peculiar form known as the *botrytis* form, reproduced by conidia only, and long believed to be altogether distinct from the Ascomycetes. Of this nature is the so-called *Botrytis bassiana* (fig. 481), a kind of mould, the growth of which is the real source of the disease termed *muscardine* which formerly carried off silkworms in large numbers, just when they were about to enter the chrysalis state, to the great injury of their breeders. The plant presents itself under a considerable variety of forms (A-F), all of which, however, are of extremely simple structure, consisting of elongated or rounded cells, connected in necklace-like filaments, very nearly as in the ordinary 'bead-moulds.' The spores of this fungus, floating in the air, enter the breathing-pores which open into the tracheal system of the silkworm; they first develop themselves within the air-tubes, which are soon blocked up by their growth; and they then extend themselves through the fatty mass beneath the skin, occasioning the destruction of this tissue, which is very important as a reservoir of nutriment to the animal when it is about to pass into its chrysalis condition. The disease invariably occasions the death of the grub which it attacks; but it seldom shows itself externally until afterwards, when it rapidly shoots forth from beneath the skin, especially at the junction of the rings of the body. Although it spontaneously attacks only the larva, yet it may be communicated by inoculation to the chrysalis and the moth, as well as to the grub; and it has also been observed to attack other lepidopterous insects. A careful investigation of the circumstances which favour the development of this disease was made by Audouin, who first discovered its real nature; and he showed that its spread was favoured by the overcrowding of the worms in the breeding establishments, and particularly by the practice of throwing the bodies of such as died into a heap in the immediate neighbourhood of a living silkworm: for this heap speedily became covered with this kind of mould, which found upon it a most congenial soil; and it kept up a continual supply of spores, which, being diffused through the atmosphere of the neighbourhood, were drawn into the breathing-pores of individuals previously healthy. The precautions obviously suggested by the knowledge of the nature of the disease, thus afforded by the microscope, having been duly put in force, its extension was successfully kept down. A similar growth of different species of the genus *Sphaeria* takes place in the bodies of certain caterpillars, in New Zealand, Australia, and China; and being thus completely pervaded by a dense substance, which, when dried, has almost the solidity of wood, these caterpillars come to present the appearance of twigs, with long slender stalks that are formed by the growth of the fungus itself. The Chinese species is valued as a medicinal drug.

Some forms of Ascomycetes, such as the genus *Tuber*, to which the truffle belongs, are formed completely underground.

The **Saccharomycetes** are now generally regarded as a degraded form of the Ascomycetes. They resemble the Schizomycetes in the simplicity of their character and in their 'zymotic' action. The most familiar form of this family is the *Saccharomyces (Torula) cerevisia*,

the presence of which in yeast gives to it the power of exciting the alcoholic fermentation in saccharine liquids. When a small drop of yeast is placed under a magnifying power of 400 or 500 diameters, it is seen to consist of a large number of globular or ovoid cells, averaging about $\frac{1}{3000}$ th of an inch in diameter, for the most part isolated, but sometimes connected in short series; and each cell is filled with a nearly colourless 'endoplasm,' usually exhibiting one or more vacuoles. When placed in a fermentable fluid containing some form of nitrogenous matter in addition to sugar,¹ they vegetate in the manner represented in fig. 482. Each cell puts forth one or two projections, which seem to be young cells developed as buds or offsets from their predecessors; these, in the course of a short time, become complete cells, and again perform the same process; and in this manner the single cells of yeast develop themselves, in the course of a few hours, into rows of four, five, or six, which remain in connection with each other whilst the plant is still growing, but which separate if the fermenting process be checked, and return to the isolated condition of those which originally constituted the yeast. Thus it is that the quantity of yeast first introduced into the fermentable fluid is multiplied six

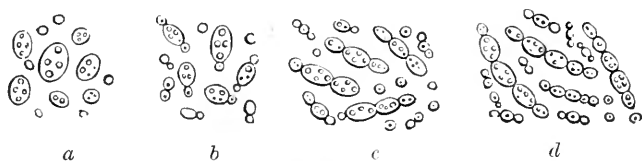

FIG. 482.—*Saccharomyces cerevisia*, or yeast-plant, as developed during the process of fermentation: a, b, c, d, successive stages of cell-multiplication.

times or more during the changes in which it takes part. Under certain conditions not yet determined, the yeast-cells multiply in another mode—namely, by the breaking up of the endoplasm into segments, usually four in number, around each of which a new 'cell-wall' forms itself; and these endogenous spores are ultimately set free by the dissolution of the wall of the parent cell, and soon enlarge and comport themselves as ordinary yeast-cells. The process of the formation of these spores resembles in all essential points the formation of ascospores; and hence *Torula* is regarded as a low or degraded type of that order. Many other fungi of like simplicity have the power to act as 'ferments;' thus in wine-making the fermentation of the juices of the grapes or other fruit employed is set going by the development of minute fungi whose germs have settled on their skins, these germs not being injured by desiccation, and being readily transported by the atmosphere in the dried-up state.

¹ It appears from the researches of Pasteur that, although the presence of albuminous matter (such as is contained in a saccharine wort, or in the juices of fruits) favours the growth and reproduction of yeast, yet that it can live and multiply in a solution of pure sugar, containing ammonium tartrate with small quantities of mineral salts, the decomposition of the ammonia salt affording it the nitrogen it requires for the production of protoplasm, while the sugar and water supply the carbon, oxygen, and hydrogen.

There is reason to believe, moreover, that a similar 'zymotic' action may be excited by fungi of a higher grade in the earlier stages of their growth, the alcoholic fermentation being set up in a suitable liquid (such as an aqueous solution of cane-sugar, with a little fruit-juice) by sowing in it the spores of any one of the ordinary moulds, such as *Penicillium glaucum*, *Mucor*, or *Aspergillus*, provided the temperature be kept up to blood-heat; and this even though the solution has been previously heated to 284° Fahr., a temperature which must kill any germs it may itself contain.

The **Basidiomycetes** are distinguished by the entire absence, as far as is at present known, of sexual organs, and by the formation of their conids or spores at the apex of special enlarged cells, the *basids*. They include the largest and most familiar of our fungi, such as the genera *Agaricus*, *Boletus*, *Polyporus*, *Lycoperdon*, *Phallus*, &c. They are saprophytes, obtaining their nourishment from the decaying vegetable matter in the soil, stumps of trees, &c., &c., among which the mycele penetrates, consisting often of a dense web of septated hyphæ, the 'spawn' of the mushroom. The ærial portion, known as the *receptacle* or fructification, bears either externally, as in the case of the mushroom (fig. 483), or internally, as

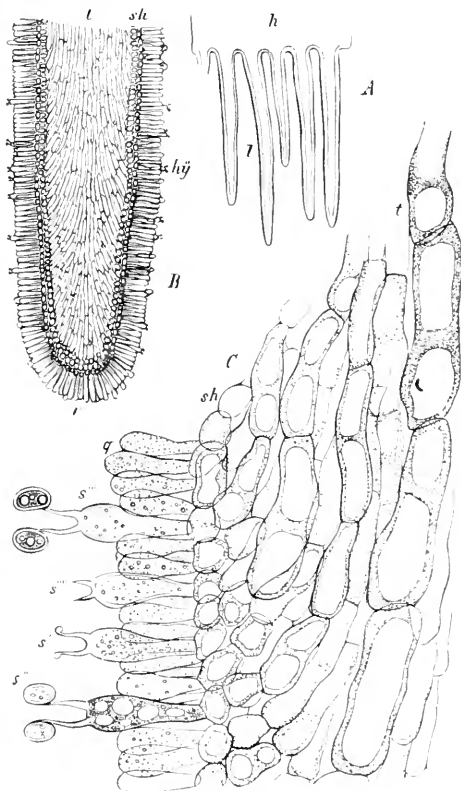

FIG. 483.—*Agaricus campestris*, formation of the hymenium: A and B, slightly magnified; C, a part of B, magnified 550 times. The portion marked with fine dots is protoplasm. (From Goebel's 'Classification and Morphology of Plants.')

in the case of the *Lycoperdon*, or 'puff-ball,' the fertile portion or *hymenium*. On this hymenium project the extremities of special hyphæ, which are swollen into *basids*; the non-sexual conids or *basidiospores* are formed at the extremity of the basids, usually in fours, from which they are easily detached, and, from their small size and great lightness, are readily carried through the air in great quantities. In the *Hymenomycetes*, of which the common mushroom

(*Agaricus campestris*) may be taken as a type, the receptacle has the form of a cap-shaped *pileus* (fig. 484), raised on a stalk or *stipe*, the whole composed of a pseudo-parenchyma consisting of a dense agglomeration of parallel hyphæ, the cortical portion of which is slightly differentiated into an epiderm. In the family to which the mushroom belongs, the hymenium is borne at the edge of narrow gill-like projections or *lamellæ* radiating from the apex of the stipe on the under side of the pileus. Among the basids are seen other

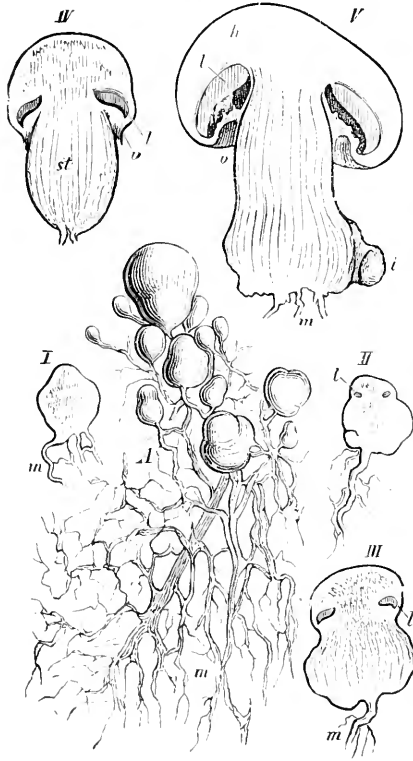

FIG. 484.—*Agaricus campestris*, natural size. (From Goebel's 'Classification and Morphology of Plants.')

cells of similar shape and usually larger size, also the extremities of special hyphæ, called *cystids*, the function of which is obscure. The basidiospores vary greatly in colour in different genera. They are always unicellular, and the membrane consists of two coats, the *endospore* and *exospore*, the former of which consists of fungus-cellulose, while the latter is more or less cuticularised. On germinating the endospore bursts through the exospore, and grows into a germinating filament, from which is developed the mycelium, and on this ultimately the receptacles.

Lichens.—The microscopic study of this group has acquired a new interest for the botanist, from the remarkable discovery announced in its complete form by Schwendener in 1869¹ (and now accepted by the highest authorities), that instead of constituting a special type of Thallophytes, parallel to *Algae* (with which they correspond in

¹ See his memorable work *Ueber die Algentypen der Flechtengonidien* (Basel, 1869).

general account of their curious organisation will here be attempted. The algal portion of a lichen belongs to one or other of the lower groups, and consists of cells termed *goniids*—usually green, but sometimes red or bluish-green—interspersed among long cellular filaments. The proportion between these two components of the thallus varies in different examples of the type. Thus, in the simplest wall-lichens the palmella-like parent-cell gives origin, by the ordinary process of cell-division, to a single layer of cells, which spreads itself over the stony surface in a more or less circular form; and the ‘thallus,’ which increases in thickness by the formation of new layers upon its free surface, has no very defined limit, and, in consequence of the slight adhesion of its components, is said to be ‘pulverulent.’ But in the more complex forms of lichens the thallus is mainly composed of long hyphæ, which dip down into the superficial layers of the bark of the trees on which they grow, and form by their

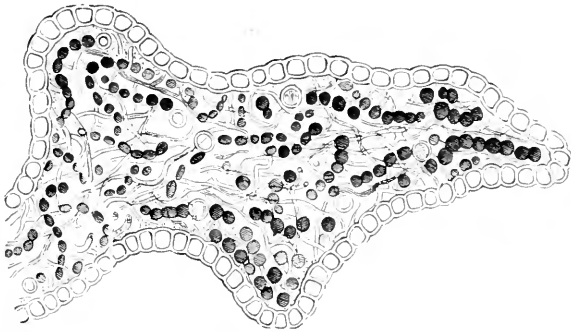

FIG. 485.—*Leptogium scotinum*: Vertical section of the gelatinous thallus, magnified 550 times. An epidermal layer clothes the inner tissue, which consists for the most part of formless and colourless jelly, in which the coiled strings of gonoids lie; single larger cells of the strings (the limiting cells) are of a higher colour; between them run the slender hyphæ. (From Goebel's 'Classification.')

interweaving a hard crustaceous ‘thallus,’ in which the *goniids* are imbedded, sometimes irregularly, sometimes in definite layers, known as the *gonidial layer* (fig. 485), covered by an envelope of interlacing filaments. It is from this algal portion of the structure that the *soredes* of lichens are formed, little projections of the surface, composed of single or aggregate *goniids*, invested by hyphæ, and falling, when dry, into a powder, of which every particle is capable of reproducing the plant from which it proceeded.

The *fructification* of lichens, on the other hand, is the production of their fungal overgrowths, which are nourished by the algal vegetation. The lichen-forming fungi, in fact, live upon their algal hosts, like the endophytic fungi (such as the ‘blights’ of corn), which infest the higher forms of vegetation, each of the former choosing its own alga, just as the latter mostly attach themselves to particular victims. The peculiarity in the parasitism of the lichen-fungi lies in the fact that they are not attached to their host externally at any one particular spot, and do not penetrate into its cells, but

weave themselves round them, and enclose them in their hyphal tissue. But not only this: the algal constituent of the lichen appears also to derive benefit from, and to be nourished by, the fungus-hyphae, affording an example of the singular kind of mutual dependence known as *commensalism* or *symbiosis* (fig. 486.) The formation of sexually produced 'spores' usually takes place in *asci* arranged vertically in the midst of straight elongated sterile cells termed *paraphyses*, so as to form a layer that lies either on the surface

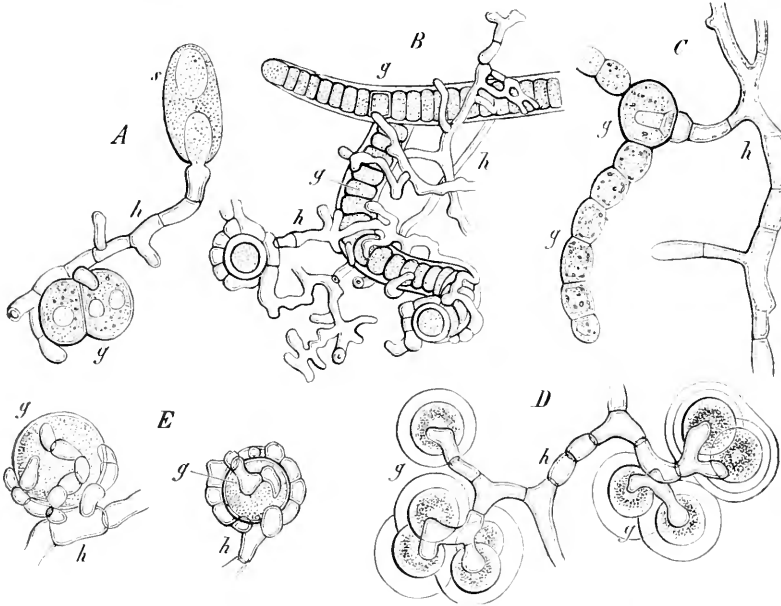
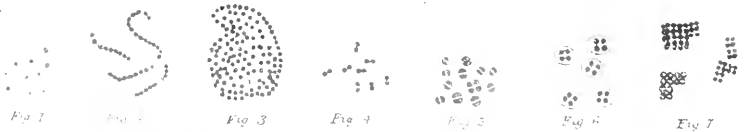

FIG. 486.—Examples of various algae which are employed as the gonids of lichens: *h* indicates always the hypha of the fungus; *g'* the gonid: A, germinating spore, *s*, of *Physcia parietina*, the germ-tube of which adheres closely to *Prototheca viridis*; B, a filament of *Scytonema* with hyphae of *Stereocaulon ramulosus* twined round it; C, from the thallus of the lichen *Physcia chalcographa*—a hyphal branch is entering a cell of the *Nostoc* filament (gonid); D, from the thallus of the lichen *Synalissa symphorea*—the gonids are the alga *Gloeocapsa*; E, from the thallus of the lichen *Cladonia furcata*; the gonids, which are being surrounded by the hyphae, are the cells of *Prototheca*. After Bornet. A, C, D, E, magnified 950; B, 650 times. (From Goebel's 'Classification and Special Morphology of Plants.')

of *apothecies*, or is completely enclosed within *peritheces*. Each of the *asci* contains a definite number of *ascospores*, usually eight, which are projected from the receptacles with some force; and their emission, which seems to be due to the different effects of moisture upon the several layers of the receptacle, is often kept up continuously for some time. The formation of these *asci*, as in the case of the ordinary *Ascomycetes*, is probably the result of a sexual union which takes place between the male *pollinoids* or 'spermatia' and the female *trichogyne*. These *pollinoids* are produced within



antherids which are often specially designated 'spermogones,' formed within these cavities, and, when mature, escaping in great numbers from their orifices. Having no power of spontaneous movement, they must probably be conveyed by the infiltration of rain-water to a trichogyne which lies imbedded in the tissue beneath; and when they have imparted their fertilising influence to the contents of the ascogone at its base, these develop themselves into a spore-bearing apothecae, the whole mass of spores which this contains being the product of the cell-division of the originally fertilised 'oöspore.'

The fungus-constituent of lichens belongs, in the great majority of cases, to the Ascomycetes, in a very few to the Basidiomycetes. The gonids have been referred to a very large number of genera of algae, among which may be mentioned *Protococcus*, *Chroöcoccus*, *Gloocapsa*, *Palmella*, *Scytonema*, *Nostoc*, and *Chroölepus*.

The Bacteria or Schizomycetes.—At the close of this chapter we place the *Bacteria*, *Schizomycetes*, or *fission-fungi*. These micro-organisms have been defined as minute vegetable cells destitute of nuclei. In spite of the labour which has been bestowed upon this group, and vast as the literature is to which it has given rise, it is impossible to assign an exact and clearly definable position to what is at the same time a remarkable and important group; and we therefore, as a matter of convenient arrangement, place them as PROTOPHYTES, at the base of the lowest Fungi, for no other, and therefore for the quite insufficient reason in the main, that they contain no chlorophyll (Plate XIII).

There can be no doubt that some forms of the Bacteria manifest affinity with the chlorophyllaceous Algae; but the affinity is in the present state of our knowledge none the less indefinable, even if our knowledge of the Bacteria as an entire group were complete enough to admit of a generalisation of their relations. On the other hand, according to Dallingier, the affinities of the Bacteria as a complete group are closer with the Flagellata than is generally admitted; and whenever the saprophytic Flagellata—which are the indispensable agents, *not* in the putrefactive fermentation by which *infusions and gelatine masses* are broken up, but by which *great masses of organic tissue* are reduced—and at the same time the Bacteria, as a whole, have been broadly and comprehensively worked out, it may be found that both their morphological and physiological affinities are of the closest order. It is impossible to take, for example, such a form as *B. lineola*, which has an easily demonstrated flagellate character, and reproduces in every fission a flagellum, common to both dividing forms, which snaps at the moment of complete division, leaving each form with a flagellum at either end—perfect as the primal form whence the fission arose—without observing how completely this coincides with the mode of fission in half a dozen saprophytic monads. But as an instance *Cercomonas typica* (named by Kent) may be given,¹ where the process is identical. True, the *Cercomonas* has a conjugating and subsequent resting stage, after which swarms emerge from spores thus formed.

¹ *Manual of the Infusoria*, i. 259.

throughout represent the granules of sulphur; 6 to 8 show fragments rich in sulphur with transverse septation developed by treatment with methyl-violet solution. In 8 the formation of cocci and spores

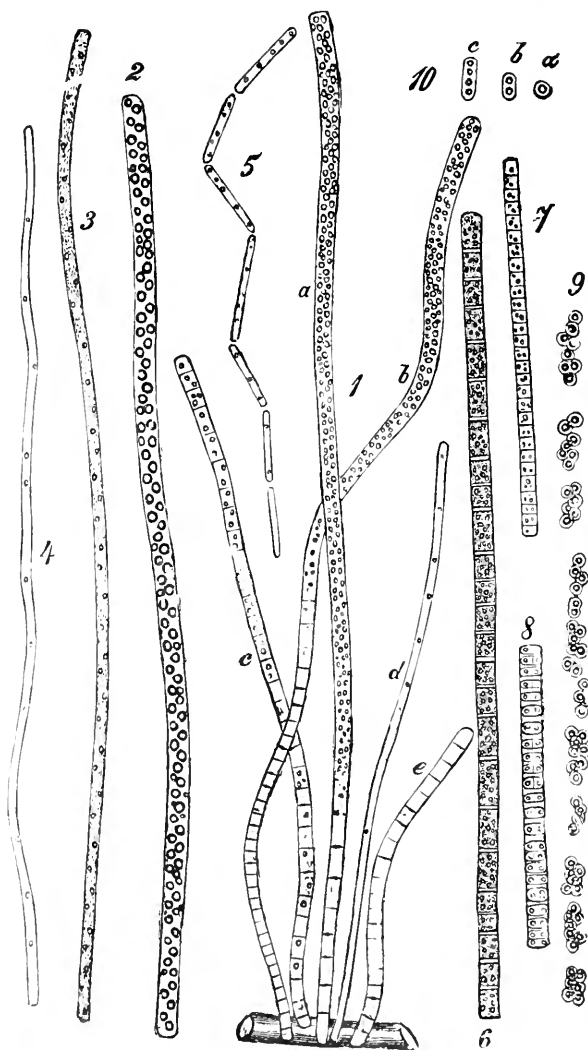

FIG. 487. *Beggiatoa alba*. (From De Bary's 'Comparative Morphology of Fungi'.)

is seen; 9 shows the result of filaments having broken up into spores; 10 shows spores in movement. 1 is magnified 540 diameters, the remainder 900 diameters.

Figure 488 shows the growth of the curved and spiral forms

of the same : A is a group of attached filaments ; B to H show portions of spiral filaments ; C, D, E, to H represent the act of division into smaller fragments but without motion ; in H the separate cells are distinctly shown ; E shows the separation of a complete spirillum form possessed of flagella and capable of great activity.

Bacteria may be united by some interfusing gelatinous material in which all action ceases or is of the most limited kind ; and these living films, which appear on the surface or suspended in the interior of putrescent fluids, are known as *Zooglia*. They may also be found on the surfaces of solid bodies, where the putrefactive ferment is in action.

Bacteria have been divided into two classes, distinguished by the formation of *endospores* in the one and of *arthrospores* in the other.

I. The *endosporous* forms are those whose multiplication is brought about by the formation within a cell of a minute globular or oval body, which, while the surrounding protoplasm of the mother-cell is assimilated, gradually reaches its mature condition. What it is that exactly determines the act of spore-formation is not known, but it is probable that free access to oxygen constitutes an important factor.

A chosen illustration of the *endosporous* Bacteria is *Bacillus megatherium*. It was first

observed on boiled cabbage leaves, and is considered by De Bary as an 'exceedingly instructive form.' It is 2.5μ in short diameter and about four times as long as this. It is illustrated in fig. 489. *a* represents a motile chain of the Bacilli in active vegetation. This is magnified 250 diameters. *b* two active rods magnified 600 diameters. *p* shows the result of treating a form in the condition *b* with an alcoholic solution of iodine. *c* is a rod with five cells preparing to form spores. *d* to *f* represent successive stages of a pair of rods in

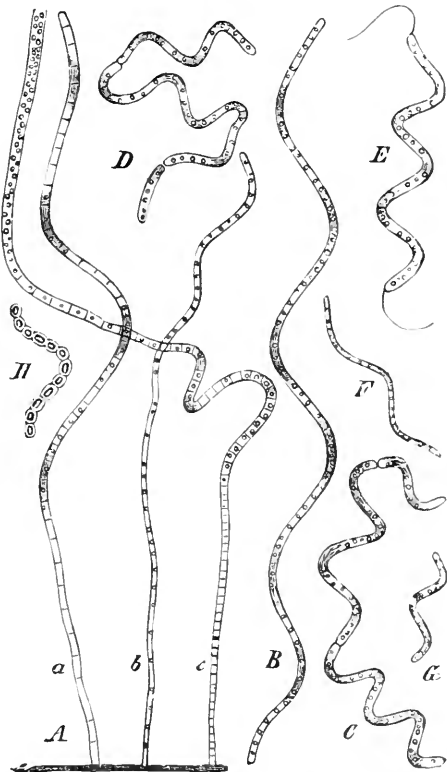

FIG. 488.—*Beggiatoa alba*, curved and spiral forms. (From De Bary's 'Comparative Morphology of Fungi.')

the act of forming spores, *e* an hour later than *d*, and *f* an hour later than *e*. The cells which did not contain spores disappeared or perished. *r* is a quadricellular rod with ripe spores. *g*¹ is a five-celled rod with three ripe spores placed in a nutrient solution after several days' desiccation. *g*² is the same an hour after; *g*³ is the same after another two hours and a half.

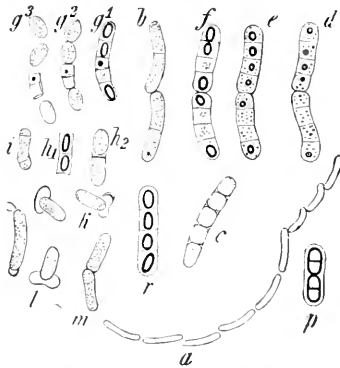

FIG. 489. — *Bacillus megatherium*. (From De Bary's 'Comparative Morphology of Fungi'.)

length and 1μ to 1.25μ in width (fig. 490). Fig. 491 shows two filaments grown on a microscopic slide (De Bary) in a solution of meat extract, partly in an advanced state of

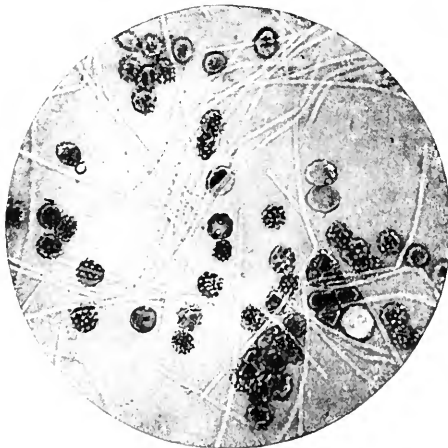

FIG. 490.—*Bacillus anthracis*, $\times 1,200$. Blood corpuscles and bacilli unstained; from an inoculated mouse. (Fränkel and Pfeiffer.)

Bacillus anthracis and *B. subtilis* are very typical examples of endosporous bacteria. *B. anthracis* has been proved to be the virus of anthrax or splenic fever. It is found in great profusion in the blood and tissues of animals attacked by this disease in the form of rods and filaments

5μ to 20μ in length and 1μ to 1.25μ in width (fig. 490). Fig. 491 shows two filaments grown on a microscopic slide (De Bary) in a solution of meat extract, partly in an advanced state of

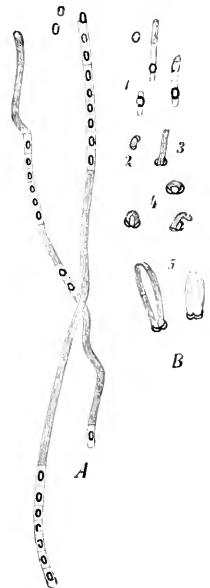

FIG. 491.—A, *Bacillus anthracis*; B, *B. subtilis*. (From De Bary's 'Fungi'.)

spore-formation. At the upper part of the figure two ripe spores have escaped. These spores on germination elongate and give rise to new groups of rods and filaments.

B. subtilis, which is the Bacillus common to decomposing hay infusion, has a life-history extremely similar to *B. anthracis*. It spores in precisely the same manner. The outer wall of the spore is comparatively thick, and the protoplasm elongates in the direction of the longer axis of the spore and of the mother-cell with which this coincided. B, fig. 491, represents the development of *B. subtilis*: 1 shows fragment of filaments with ripe spores; at 2 the spore is beginning to germinate; 3, the young rod is projecting from the wall of the spore; 4 represents germ rods curved in a horseshoe shape and with the extremities connected, one of them having one extremity subsequently released; 5, germ-tubes with the two extremities

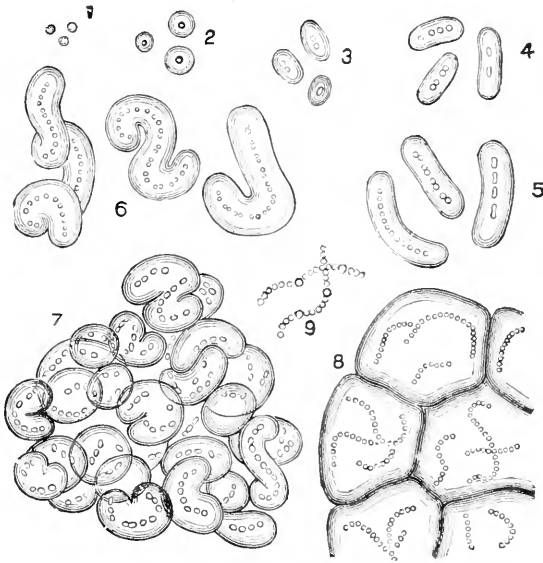

FIG. 492. *Leuconostoc mesenteroides*: 1, Spores; 2, Spores after germination, showing gelatinous envelope; 3, 4, 5, 6, Increase by division; 7, Glomerular form of zoöglæa; 8, Section of an old mass of zoöglæa; 9, Cocci chains with arthrospores (Tieghem and Cienkowski).

remaining connected and already greatly increased in size. The whole represents a magnification of 600 diameters.

11. *Arthrosporous* forms are reproduced by the separation of single members from their connection with a group, which then give origin to new generations. These cells, apparently not differing from the rest, become larger, with tougher walls and more refractive, and while the rest of the group die they, having acquired the properties of spores, can produce a new growth in any fresh nourishing soil.

A sufficiently detailed illustration of the arthrosporous Bacteria may be seen in *Leuconostoc mesenteroides* (fig. 492). This micro-organism occurs occasionally in beetroot juice and the molasses of sugar-makers, forming large gelatinous masses resembling frog spawn.

Chains of cocci are found by microscopical examination, and some of the cells in a chain are enlarged without changing their form and develop into typical arthrospores.

The Bacteria behave very variously under the same conditions of supply or exclusion of oxygen. The *aerobic* require free oxygen in quantity, as e.g. *B. subtilis*; while in the *anaerobic* the vital activities are promoted by its exclusion. But there can be no doubt that gradual modification of either condition will bring about adaptations. Naegeli has shown that there are forms which usually depend on oxygen which continue to vegetate when free oxygen ceases.

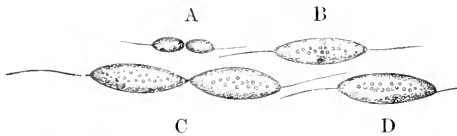

FIG. 493.—A, *Bacterium termo*, each cell furnished with a single flagellum. Magnified 4,000 diameters. B, C, D, *Bacterium lincola*, each cell when separated having a flagellum at either end. Magnified 3,000 diameters. (Dallinger.)

Their nutrition is carried on like that of other vegetative forms devoid of chlorophyll. The actual typical group are without doubt the saprophytic Bacteria. The relation of the *parasitic* or *pathogenic* forms to these is one of the most interesting problems in microscopic biology. That they are physiological modifications of the saprophytic forms appears *per se* a possibility; but in the light thrown upon biological change and survival by the hypothesis of the origin of species, the suggestion incites to practical inquiry and research. If the parasitic Bacteria are physiological modifications of the saprophytic forms, to know the path by which they biologically became such may

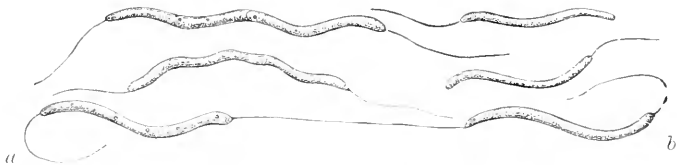

FIG. 494.—Four individuals of *Vibrio vulnificans*, each showing flagellum at one or both ends; two other individuals, *a* and *b*, separating from each other, and drawing out a protoplasmic filament to form their second flagella. Magnified 2,000 diameters. (Dallinger.)

be to put more into the hands of medicine than could be accomplished by any other means.

Bacterium termo is the most universally present and abundant of the saprophytic species. It is 1μ to 1.5μ long, and 0.5 to 0.7μ broad, usually of dumbbell form. These Bacteria are usually seen in 'vacillating' movement in their free state; each cell bears a flagellum at each end, as B, D (fig. 493), whilst the double cells bear a flagellum at each extremity. The formation of the second flagellum takes place by the drawing out of a filament of protoplasm between two cells that are separating from each other (as in fig. 494, *a*, *b*), the rupture

of which gives a new flagellum to each. Their flagella are so minute as to be among the most 'difficult' of all microscopic objects, their diameter being calculated from 200 measurements by Dallinger at no more than $\frac{1}{2000000}$ th of an inch.¹ Although this species does not ordinarily multiply in any other way than by transverse subdivision, yet, under 'cultivation' at a temperature of 86° Fahr., its cells have been seen to elongate themselves into motionless rods, resembling those of *Bacilli*, whose endoplasm breaks up into separate particles that are set free as small bright almost spherical spores, which sometimes congregate so as to form a *zoöglæa*-film. These germinate into short slender rods, which are at first motionless, but soon undergo transverse fission, and then acquire flagella.²

The *Vibriones* may be represented by *V. vulgata*, seen in fig. 494. They are slightly curved rods and threads, from 6 μ to 16 μ long, and varying in thickness from 0.5 μ to 2 μ . They have well-marked flagella, one at each end. They appear in vegetable infusions, causing fermentation of cellulose.

The *Spirilla* are the largest forms in the group, characterised by

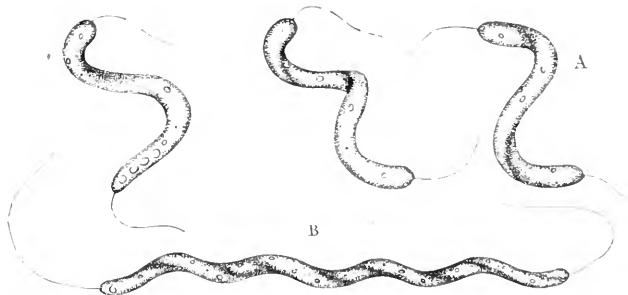

FIG. 495.—A, *Spirillum undula*, showing flagellum at each end. Magnified 3,000 diameters. B, *Spirillum volutans*. Magnified 2,000 diameters. (Dallinger.)

their spirally formed cells and their graceful spiral motion. They are fairly represented in fig. 495 by *Spirillum undula* (A) and *Spirillum volutans* (B). The threads of the former are from 1.1 μ to 1.4 μ in thickness, and from 9 μ to 12 μ in length. They are intensely active, and possess a flagellum at either end. They are found in varying decomposing infusions.

Spirillum volutans was known to and named by Ehrenberg. It is from 1.5 μ to 2.3 μ in thickness, and varies from 25 μ to 30 μ or more in length. It has distinctly granular contents, and a very easily demonstrable flagellum at each end of the spiral; a flagellum was distinctly suggested by Ehrenberg on account of the vortical action visible in the fluid before this spirillum as it advanced.

With the beautifully corrected 6mm. power of Zeiss (apochromatic dry N.A. 0.95), all but the most difficult of these can be seen in fresh specimens with relative ease on a dark ground with a 12 or 18 eyepiece, provided they be examined *alive with the flagella in motion*.

¹ Journ. of Roy. Microsc. Soc. vol. i. (1878), p. 175

² Ewart, *loc. cit.*

For the more difficult ones (*B. termo* and *B. lineola*) more careful arrangements are required. In dried specimens the flagella can be readily demonstrated, and easily photographed, by staining them by a special method introduced by Löffler (fig. 496).

The germinating power of the spores of Bacteria may be brought into operation at once on their reaching ripeness, or they may be desiccated for an indefinite time, and again, on reaching suitable surroundings, will germinate as before. This power is held in various degrees by different forms, but the whole subject needs more uniform and exhaustive inquiry. The spores of *B. subtilis* retain their vitality for years if kept in a dry air, while those of *B. anthracis* are stated by Pasteur to remain alive in absolute alcohol;¹ and Brefeld found their power to germinate uninjured after the lapse of three years in a dry atmosphere. He also found them proof against the boiling-point of water, and even a higher

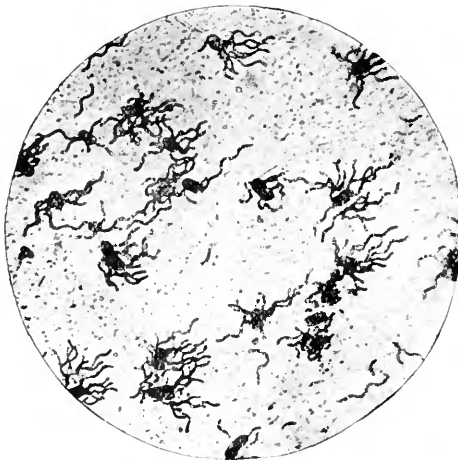

FIG. 496. — Flagella of Typhoid Bacilli, $\times 1,000$, stained by Löffler's method. (Fränkel and Pfeiffer.)

temperature, but he found that fewer and fewer survived in boiling nutrient fluid until the end of the third hour, when all were destroyed. So Buchner found that the same spores were wholly killed only after three or four hours boiling;² while Pasteur states that groups of uncertain spores can withstand a temperature of 130°C . There is, however, uncertainty, because a want of uniformity, in the results from various sources; 20° to 25°C , may be taken as the average degree of temperature at which these organisms will freely germinate; but *B. termo*, for example, has been known to germinate from 5.5°C . to 40°C .

Nothing like 'conjugation,' or any other form of sexual generation, has yet been witnessed in any Bacteria; and until such shall have been discovered, no confidence can be felt that we know the entire life-history of any one type.³ When these facts are allowed

¹ 'Charbon et Septicémie,' *Compt. Rend.* lxxxv. p. 99.

² Naegeli, *Unters. über niedere Pilze*, 1882, p. 220.

³ As it seems unquestionable that among the higher Fungi 'conjugation' often takes place at a very early stage of growth, it seems a not very improbable surmise that the 'granular spheres' observed by Ewart in *Bacillus* and *Spirillum*, which seem to correspond with the 'microplasts' observed by Ray Lankester in his *Bacterium rubescens*, may be a product of conjugation in the micrococcus stage of these organisms.

their due weight, no difficulty can be felt in admitting the action of Bacteria, &c., in producing decomposition under conditions which might at first view be fairly supposed to preclude the possibility of their presence. This action is altogether analogous to that of the yeast-plant in producing saccharine fermentation; and the careful and exact experiments of Pasteur, repeated and verified in a great variety of modes by Lister, Tyndall, and others, leave no doubt on these two points—(1) that putrefactive fermentation does not take place, even in liquids which are peculiarly disposed to pass into it, except in the presence of Bacteria; and (2) that neither these germs nor any others arise in such liquids *de novo*, but that they are all conveyed into them by the air when not otherwise introduced. It is thus also with the parasitic or pathogenic forms of Bacteria in setting up disease. Thus



FIG. 497.—Spore-bearing threads of *Bacillus anthracis*, double-stained with fuchsine and methylene blue, $\times 1,200$. (Crookshank.)



FIG. 498.—Photograph of a pure-cultivation of *Bacillus anthracis*. (Crookshank.)

'splenic fever' is producible by the inoculation of *Bacillus anthracis* (figs. 497 and 498); and tetanus or 'lock-jaw' by inoculation with another species of *Bacillus*, the microbes having been in both cases 'cultivated,' so as to be free from other contaminating matter. Similar observations have been made upon tuberculosis (figs. 499 and 500), actinomycosis, glanders, so that an animal suffering under any of these diseases may be a focus of infection to others, for precisely the same reason that a tub of fermenting beer is capable of propagating its fermentation to fresh wort. A most notable instance of such propagation is afforded by the spread of the disease termed 'pébrine' among the silkworms of the south of France, which, according to Pasteur, is caused by a minute organism named *Nosema Bombycis*, the mortality caused by it being estimated to produce a money loss of from three to four millions sterling annually for several years following 1853, when it

FIG. 499.—Bacilli of tubercle in sputum, $\times 2,500$ (from photographs), stained with carbolised fuchsine. (Crookshank.)

first broke out with violence. It has been shown by microscopic investigation that in silkworms strongly affected with this disease, every tissue and organ in the body is swarming with these minute cylindrical corpuscles about 4.2μ long, and that these even pass into the undeveloped eggs of the female moth, so that the disease is hereditarily transmitted. And it has been further ascertained by the researches of Pasteur that these corpuscles are the active agents in the production of the disease, which is engendered in healthy silkworms by their reception into their bodies; whilst, if due precautions be taken against their transmission, the malady may be completely exterminated.

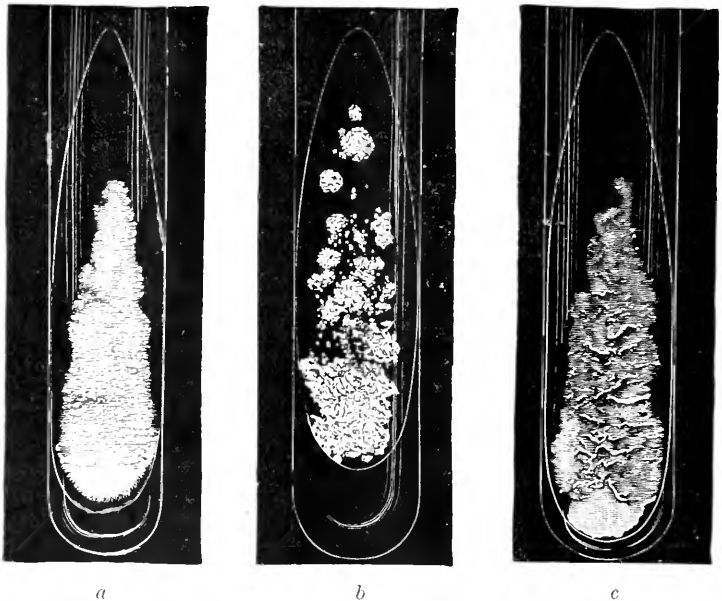

FIG. 500.—Pure-cultivations on glycerine-agar from human tubercular sputum: *a*, after six months' growth (fifth sub-culture); *b*, *c*, after ten months' growth (fourth sub-culture). (Crookshank.)

Bacteriology is now so distinctly a branch of biological science that it would be out of place here to present even a summary of its voluminous details and methods of research. The microscope in its most perfect form is an indispensable adjunct to the rapidly progressive work of this department of biological research, and the most delicate and refined employment of the microscope and all its adjuncts is in the last degree important. Only a skilled microscopist can be a successful bacteriologist. But for the methods of the bacteriological laboratory we must refer the reader to treatises on this branch of science,¹ it being enough here to remark that the

¹ The English student will find an admirable aid in the *Text-book of Bacteriology and Infective Diseases* (4th ed.), by Professor E. Crookshank.

employment of nutrient gelatine, nutrient agar-agar, and other similar media on glass plates, and in test-tubes (fig. 501), so as by

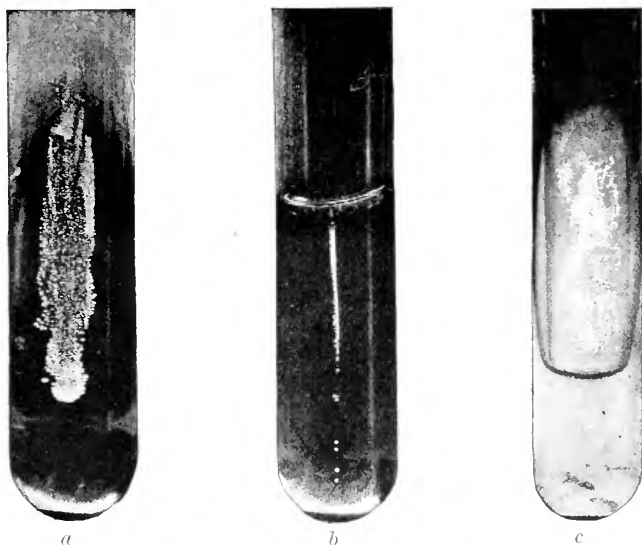

FIG. 501.—Pure-cultivations of *Streptococcus pyogenes*: *a*, on the surface of nutrient gelatine; *b*, in the depth of nutrient gelatine; *c*, on the surface of nutrient agar. (Crookshank.)

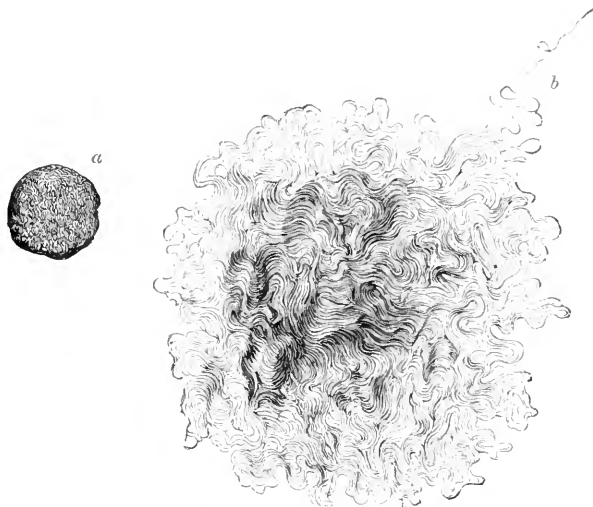
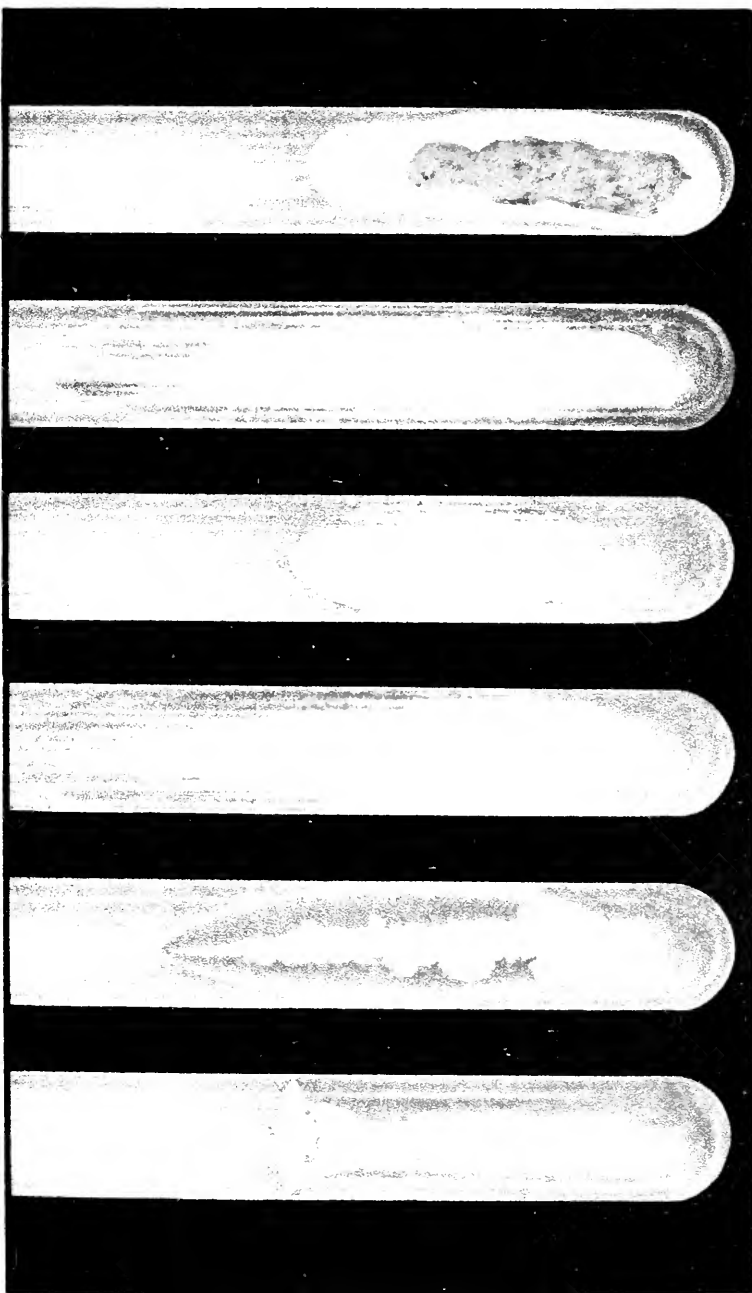

FIG. 502.—Colonies of *Bacillus anthracis*, $\times 80$: *a*, after 24 hours; *b*, after 48 hours. (Flügge.)

inoculation to obtain cultures of specific and isolated forms with their characteristic appearances, is one of the essential methods

(Plate XIV). The inoculated bacteria, instead of moving freely, as they would in a liquid medium, are fixed to one spot, where they develop 'colonies' in a characteristic manner, showing their own morphological features (fig. 502). Cleanliness and care, as well as practice in manipulation, are essential. In the same way we can only allude to the investigation of the chemical products of bacteria, such as *toxins*, and to those antidotal substances or *antitoxins* which develop in the blood of suitable animals inoculated with gradually increasing doses of toxins. Antitoxins and vaccines are now largely used in the treatment of tetanus, diphtheria, typhoid fever, plague, cholera, and septic diseases in the human subject.

The pathological and therapeutic value of these researches is far beyond our present ability to estimate, and must have an apparently increasing value. But it is a science with which a work of this sort may not deal further than to show the right use of the microscope and its appliances, by which the work of pathological bacteriology can alone be successfully done.





CHAPTER X

MICROSCOPIC STRUCTURE OF THE HIGHER CRYPTOGAMS

Hepaticæ.—Quitting now the algal and fungoid types, and entering the series of terrestrial cryptogams, we have first to notice the little group of *Hepaticæ*, or liverworts. This group presents numerous objects of great interest to the microscopist; and no species is richer in these than the very common *Marchantia polymorpha*, which may often be found growing between the paving-stones of damp courtyards, but which particularly luxuriates in the neighbourhood of springs or waterfalls, where its lobed fronds are found covering extensive surfaces of moist rock or soil, adhering by the radical filaments (rhizoids) which arise from their lower surface. At the period of fructification these fronds send up stalks, which carry at their summits either round shield-like discs, or radiating bodies that bear some resemblance to a wheel without its tire (fig. 503). The former carry the male organs or *antherids*; while the latter in the first instance bear the female organs or *archegones*, which afterwards give place to the *sporangies*, or spore-cases.¹



FIG. 503.—Frond of *Marchantia polymorpha*, with gemmiparous conceptacles, and lobed receptacles bearing archegones.

The green surface of the frond of *Marchantia* is seen, under a low magnifying power, to be divided into minute diamond-shaped spaces (fig. 504, A, *a, a*), bounded by raised bands (*c, c*); every one of these spaces has in its centre a curious brownish-coloured body (*b, b*), with an opening in its middle, which allows a few small green cells to be seen through it. When a thin vertical section is made of the frond (B), it is seen that each of the lozenge-shaped divisions of its surface corresponds with an air-chamber in its interior, which is bounded below by a floor (*a, a*) of closely set cells, from whose under surface the rhizoids arise; at the sides by walls (*c, c*) of similar solid

¹ In some species the same shields bear both sets of organs; and in *Marchantia androgyna* we find the upper surface of one half of the shield developing antherids, whilst the under surface of the other half bears archegones.

parenchyme, the projection of whose summits forms the raised bands on the surface; and above by an epiderm (*b, b*) formed of a single layer of cells; whilst its interior is occupied by a loosely arranged parenchyme composed of branching rows of cells (*f, f*) that seem to spring from the floor, these cells being what are seen from above when the observer looks down through the central aperture

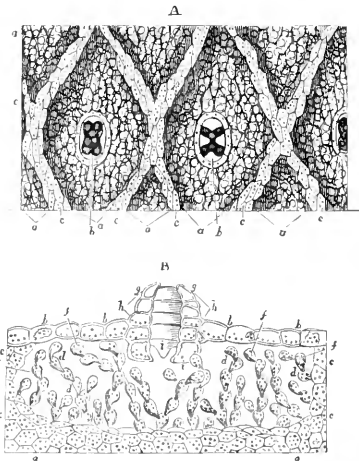

FIG. 504.—Structure of frond of *Marchantia polymorpha*: A, portion seen from above; *a, a*, lozenge-shaped divisions; *b, b*, stomates in the centre of the lozenges; *c, c*, greenish bands separating the lozenges. B, vertical section of the frond, showing *a, a*, the dense layer of cellular tissue forming the floor of the air-chamber, *d, d*, the epidermal layer, *b, b*, forming its roof; *c, c*, its walls; *f, f*, loose cells in its interior; *g, g*, stomate divided perpendicularly; *h, h*, rings of cells forming its wall; *i, i*, cells, forming the obturator-ring.

just mentioned. If the vertical section should happen to traverse one of the peculiar bodies which occupy the centres of the divisions, it will bring into view a structure of remarkable complexity. Each of these *stomates* (as they are termed, from the Greek *στόμα*, mouth) forms a sort of shaft (*g*), composed of four or five rings (like the 'courses' of bricks in a chimney) placed one upon the other (*h*), every ring being made up of four or five cells; and the lowest of these rings (*i*) appears to regulate the aperture by the contraction or expansion of the cells which compose it, and is hence termed the 'obturator-ring.' In this manner each of the air-chambers of the frond is brought into communication with the external atmosphere, the degree of that communication being regulated by the limitation of the aperture. We shall hereafter find that the leaves of the higher plants contain intercellular spaces, which also communicate with the exterior by stomates, but that the structure of these organs is far less complex in them than in this humble liverwort.

The frond of *Marchantia* usually bears upon its surface, as shown in fig. 503, a number of little open basket-shaped *gemmiparous conceptacles* (fig. 505), which may often be found in all stages of development, and are structures of singular beauty. They contain when mature a number of little green round or oblong discoidal *gemmae*, each composed of two or more layers of cells; and their wall is surmounted by a glistening fringe of 'teeth,' whose edges are themselves regularly fringed with minute outgrowths. This fringe is at first formed by the splitting up of the epiderm, as seen at B, at the time when the conceptacle and its contents are first making their way above the surface. The little *gemmae* are at first evolved as single globular cells, supported upon other cells which form their footstalks; these single cells, undergoing binary subdivision, evolve

themselves into the gemmæ; and these gemmæ, when mature, spontaneously detach themselves from their footstalks, and lie free within the cavity of the conceptacle. Most commonly they are at last washed out by rain, and are thus carried to different parts of the neighbouring soil, on which they grow very rapidly when well supplied with moisture; sometimes, however, they may be found growing whilst still contained within the conceptacles, forming natural grafts (so to speak) upon the stock from which they have been developed or detached; and many of the irregular lobes which the frond of *Marchantia* puts forth seem to have this origin. The very curious observation was long ago made by Mirbel, who carefully watched the development of these gemmæ, that stomates are formed on the side which happens to be exposed to the light, and that rhizoids are put forth from the lower side, it being apparently a matter of indifference which side of the little gemma is at first turned upwards, since each has the power of developing either stomates or rhizoids according to the influence it receives. After the tendency to the formation of these organs has once been given, however, by the sufficiently prolonged influence of light upon one side and of darkness and moisture on the other, any attempt to alter it is found to be vain; for if the surfaces of the young fronds be then inverted, a twisting growth soon restores them to their original aspect.

When *Marchantia* vegetates in damp shady situations which are favourable to the nutritive processes, it does not readily produce the true fructification, which is to be looked for rather in plants growing in more exposed places. Each of the stalked peltate (shield-like) discs contains a number of flask-shaped cavities opening upon its upper surface, which are brought into view by a vertical section; and in each of these cavities is lodged an *antherid* which is composed of a mass of 'sperm-cells,' within which are developed *antherozoids* like those of *Chara*; the whole being surmounted by a long neck that projects through the mouth of the flask-shaped cavity. The wheel-like receptacles (fig. 503), on the other hand, bear on their under surface, at an early stage, concealed between membranes that

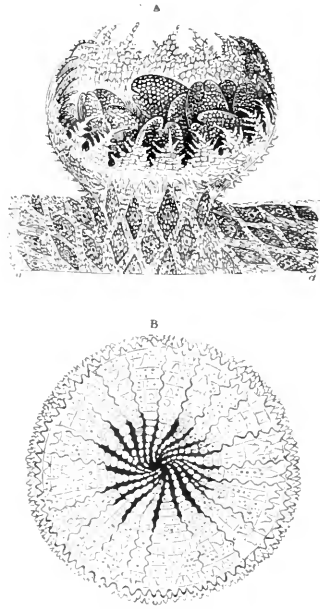

FIG. 505.—Gemmiparous conceptacles of *Marchantia polymorpha*: A, conceptacle fully expanded, rising from the surface of the frond, *a. a.* and containing gonidial gemmæ already detached. B, first appearance of conceptacle on the surface of the frond, showing the formation of the fringe by the splitting of the epiderm.

connect the origins of the lobes with one another, a set of *archegones*, shaped like flasks with elongated necks (fig. 507); each of these has in its interior an 'oosphere' or 'germ-cell,' to which a canal leads down from the extremity of the neck, and which is fertilised by the penetration of the antherozoids through this canal until they reach it. Instead, however, of at once evolving itself into a new plant resembling its parent, the fertilised oosphere or 'embryo-cell' develops itself into a mass of cells enclosed within a capsule, which is termed a *sporangium*; and thus the mature receptacle, in place of archegones, bears capsules or sporangia, each of them filled with an aggregation of cells that constitute the immediate progeny of the fertilised germ-cell. These cells, discharged by the bursting of the sporangium, are of two kinds; namely, *spores*, each enclosed in a double spore-membrane; and *elaters*, which are very elongated cells, each containing a double spiral fibre coiled up in its interior. This fibre is so elastic that when the surrounding pressure is withdrawn by the bursting of the sporangium, the elaters extend themselves (fig.



FIG. 506.—Elater and spores of *Marchantia*.

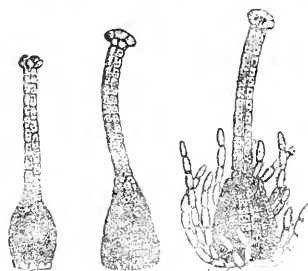

FIG. 507.—Archegone of *Marchantia polymorpha*, in successive stages of development.

506), tearing apart the cell-membrane; and they do this so suddenly as to jerk forth the spores which may be adherent to their coils, and thus assist in their dispersion. The spores, when subjected to moisture, with a moderate amount of light and warmth, develop themselves into little collections of cells,

which gradually assume the form of flattened fronds; and thus the species is very extensively multiplied, every one of the aggregate of spores which is the product of a single germ-cell being capable of giving origin to an independent individual.

Marchantia is the type of the section known as the *thalloid* Hepaticæ. Another section, the *foliose* Hepaticæ, is represented by the genus *Jungermannia*, exceedingly common plants, of a moss-like habit, growing on moist banks and similar situations. While the structure of the sexual organs, and of the sporangia, resembles in its main features that of *Marchantia*, the vegetative organs are very different, consisting of a slender creeping stem with small semi-transparent leaves. This distinct differentiation of stem and leaves indicates a decided advance in organisation, and marks the passage from the *thallophytic* to the *cormophytic* type of structure.

Musci.—There is not one of the tribe of *Mosses* whose external organs do not serve as beautiful objects when viewed with low powers of the microscope; while their more concealed wonders are admirably fitted for the detailed scrutiny of the practised observer. Mosses always possess a distinct axis of growth, commonly more or less erect, on which the minute and delicately formed leaves are arranged with great regularity. The stem shows some indication of the separation of a *cortical* or external portion from the *medullary* or central, by the intervention of a circle of bundles of elongated cells, which seem to prefigure the woody portion of the stem of

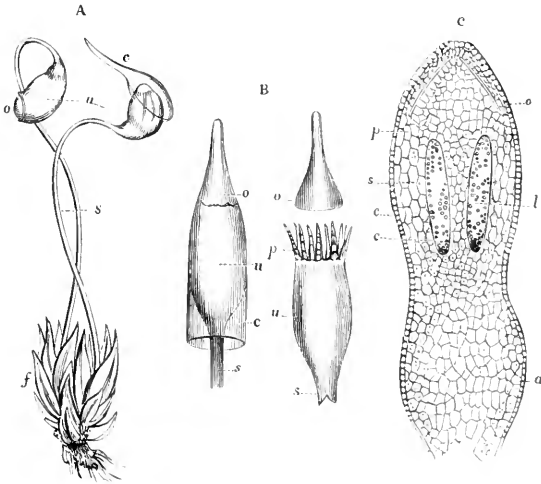
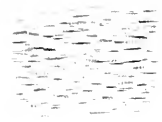

FIG. 508.—Structure of mosses: A, plant of *Funaria hygrometrica*, showing, *f* the leaves, *u* the sporangia supported upon the setae or footstalks *s*, closed by the opercule *o*, and covered by the calyptra *c*. B, sporangia of *Encalypta vulgaris*, one of them closed and covered with the calyptra, the other open; *u, u*, the sporangia; *o, o*, the opercula; *c*, calyptra; *p*, peristome; *s, s*, setae. C, longitudinal section of very young sporangium of *Splachnum*; *a*, solid tissue forming the lower part of the capsule; *c*, columel; *l*, space around it for the development of the spores; *c*, epidermal layer of cells, thickened at the top to form the opercule *o*; *p*, two intermediate layers, from which the peristome will be formed; *s*, inner layer of cells forming the wall of the cavity.

higher plants, and from which prolongations pass into the leaves, so as to afford them a sort of midrib. The leaf usually consists of either a single or a double layer of cells, having flattened sides by which they adhere one to another; they rarely present any distinct epidermal layer; but such a layer, perforated by stomates of simple structure, is commonly found on the *seta* or bristle-like footstalk bearing the fructification, and sometimes on the midribs of the leaves. The rhizoids of mosses, like those of *Marchantia*, consist of long tubular cells of extreme transparency, within which the protoplasm may frequently be seen to circulate, as in the elongated cells of *Chara*.

Faint, illegible text at the top of the page, possibly bleed-through from the reverse side.

Handwritten text or signature at the top of the central illustration.



Faint, illegible text at the bottom of the page, possibly bleed-through from the reverse side.

Faint, illegible text, likely bleed-through from the reverse side of the page.

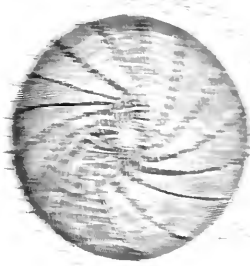

it exhibits in different genera of mosses—varieties whose existence and readiness of recognition render them characters of extreme value to the systematic botanist, whilst they furnish objects of great interest and beauty for the microscopist. The peristome seems always to be originally double, one layer springing from the outer, and the other from the inner, of two layers of cells which may be always distinguished in the immature sporange; but one or other of these is frequently wanting at the time of maturity, and sometimes both are obliterated, so that there is no peristome at all. The number of the teeth is always a 'power' of four, varying from four to sixty-four; sometimes they are prolonged into straight or twisted hairs. The *spores*, or gonidial cells, are contained in the upper part of the sporange, where they are clustered round a central pillar which is termed the *columel*. In the young sporange the whole mass is nearly solid (fig. 508, C), the space (*l*) in which the

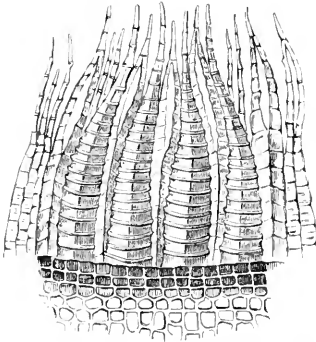

FIG. 512.—Double peristome of *Bryum intermedium*.

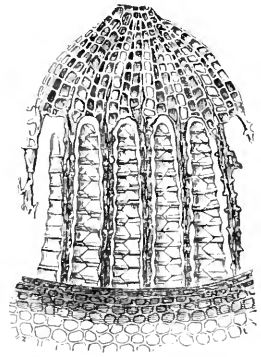

FIG. 513.—Double peristome of *Cinclidium arcticum*.

spores are developed being very small; but this gradually augments, the walls becoming more condensed, and at the time of maturity the interior of the sporange is almost entirely occupied by the spores. These are formed in groups of four by the binary subdivision of the mother-cells which first differentiate themselves from those forming the capsule itself. The capsule and seta of mosses together constitute the organ known as the *sporogone*.

The development of the spore into a new plant commences with the rupture of its firm yellowish-brown outer coat or *exospore*, and the protrusion of its cell-wall proper, or *endospore*, from the projecting extremity of which new cells are put forth by a process of outgrowth, forming a sort of confervoid filament known as the *protoneme*. At certain points of this filament its component cells multiply by subdivision, so as to form rounded clusters or buds, from every one of which an independent plant may arise. The Musci, therefore, present an example of the phenomenon known as *alternation of generations*. The life-history of each individual may be divided into two 'generations': the *sexual* generation or 'oöphyte,'

which consists of the leafy plant bearing the male and female organs; and the *non-sexual* generation or 'sporophyte,' composed of the sporogone with its spores, these two generations alternating with one another in the complete cycle of development.

The tribe of *Sphagnaceae*, or 'bog-mosses,' is now separated by muscologists from true mosses on account of the marked differences by which they are distinguished, the three groups, *Hepaticae*, *Bryaceae* (or ordinary mosses), and *Sphagnaceae*, being ranked as together forming the group of *Muscineae*.

The stem of *Sphagnaceae* is more distinctly differentiated than that of *Bryaceae* into the central or medullary, the outer or cortical, and the intermediate or woody portions: and a very rapid passage of fluid takes place through its elongated cells, especially in the medullary and cortical layers, so that if one of the plants be placed dry in a flask of water, with its rosette of leaves bent downwards, the water will speedily drop from this until the flask is emptied. The leaf-cells of the *Sphagnaceae* exhibit a very curious departure from the ordinary type: for instead of being small and polygonal, they are large and elongated (fig. 514); they contain no chlorophyll, but have spiral fibres loosely coiled in their interior: and their membranous walls have large rounded apertures, by which their cavities freely communicate with one another, as is sometimes curiously evidenced by the passage of wheel-

animalcules that make their habitation in these chambers. Between these coarsely spiral cells are some thick-walled narrow elongated cells containing chlorophyll; these, which give to the leaf its firmness, do not, in the very young leaf, differ much in appearance from the others, the peculiarities of both being evolved by a gradual process of differentiation. The antherids, or male organs, of *Sphagnaceae* resemble those of liverworts, rather than those of mosses, in their form and arrangement; they are grouped in 'catkins' at the tips of lateral branches, each of the imbricated perigonal leaves enclosing a single globose antherid on a slender footstalk, and they are surrounded by very long branched paraphyses of cobweb-like tenuity. The female organs, or archegones, which do not differ in structure from those of mosses, are grouped together in a sheath of deep green leaves at the end of one of the short lateral branchlets at the side of the rosette or terminal crown of leaves. The two sets of organs are always distributed on different branches, and in some instances on different plants. The 'sporangium' which is formed as the product of the impregnation of the germ-cell is very uniform in all the

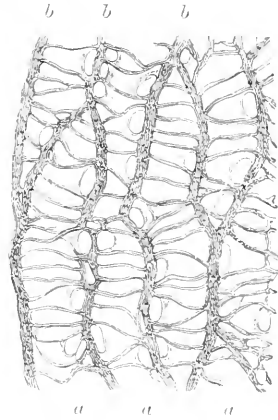

FIG. 514.—Portion of the leaf of *Sphagnum*, showing the large empty cells, *a, a, a*, with spiral fibres, and communicating apertures; and the intervening bands, *b, b, b*, composed of small elongated chlorophyllous cells.

species, being almost spherical, with a slightly convex lid, without beak or point, and showing no trace of a peristome; and the spores it contains are produced in groups of four (as in mosses) around a hemispherical 'columnel.' Besides the ordinary spores, however, the *Sphagnaceæ* sometimes develop a smaller kind, the 'microspores,' formed by a further division of the mother-cells; the significance of these is unknown.¹ The ordinary spores, when germinating, do not produce the branched confervoid filament of true mosses, but if growing on wet peat evolve themselves into a lobed foliaceous 'prothallium,' resembling the frond of liverworts; whilst if they develop in water a single long filament is formed, of which the lower end gives off rhizoids, while the upper enlarges into a bud, from which the young plant is evolved. In either case the prothallium and its temporary roots wither away as soon as the young plant begins to branch. From their extraordinary power of imbibing and holding water, the *Sphagnaceæ* are of great importance in the economy of Nature, clothing with vegetation many areas which would otherwise be sterile, and serving as reservoirs for storing up moisture for the use of higher forms of vegetation.

Filices.—In the general structure of *Ferns* we find a much nearer approximation to flowering plants; but this does not extend to their reproductive apparatus, which is formed upon a type essentially the same as that of mosses, though evolved at a very different period of life. As the tissues of

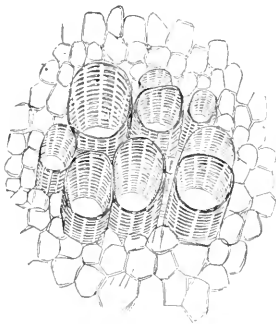

FIG. 515.—Oblique section of foot-stalk of fern leaf, showing bundle of scalariform ducts.

which their fabrics are composed are essentially the same as those to be described in the next chapter, it will not be requisite here to dwell upon them. The stem (where it exists) is for the most part made up of cellular parenchyma, which is separated into a cortical and a medullary portion by the interposition of a circular series of fibro-vascular bundles containing true woody tissue and ducts. These bundles form a kind of irregular network, from which prolongations are given off that pass into the leaf-stalks, and thence into the midrib and its lateral branches; and it is their peculiar arrangement in the leaf-stalk of the common brake which gives to the transverse section the marking commonly known as 'King Charles in the oak.' A thin section, especially if somewhat oblique (fig. 515), displays extremely well the peculiar character of the ducts of the fern, which are termed *scalariform* from the resemblance of the regular markings on their walls to the rungs of a ladder. These bundles of scalariform ducts or 'tracheids' are usually surrounded by sheaths of *scelerenchyma*, tissue composed of cells the walls of which

¹ These so-called 'microspores' are now believed to be spores of a parasitic fungus.—Ed.

have become very hard and of a deep brown colour. These sclerenchymatous sheaths are a very conspicuous feature in a transverse section of the stem or rhizome of most ferns, and are the principal agent in giving it strength and solidity.

What is usually termed the *fructification* of the fern affords a most beautiful and readily prepared class of opaque objects for the lower powers of the microscope; nothing more being necessary than to lay a fragment of the frond that bears it upon the glass stage-plate or to hold it in the stage-forceps, and to throw an adequate light upon it by the side-condenser. It usually presents itself in the form of isolated spots on the under surface of the frond termed *sori*, as in the common *Polypodium* (fig. 516), and in *Aspidium* (fig. 518); but sometimes these *sori* are elongated into bands, as in

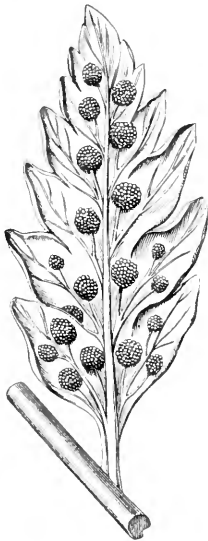

FIG. 516.—Leaflet of *Polypodium*, with sori.

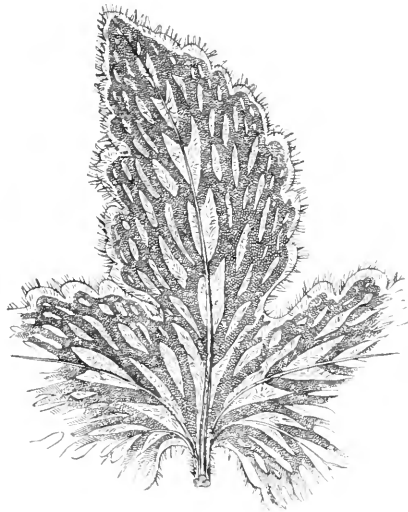

FIG. 517.—Portion of frond of *Hamionitis*, with sori.

the common *Scolopendrium* (hart's tongue); and these may coalesce with each other, so as almost to cover the surface of the frond with a network, as in *Hamionitis* (fig. 517); or they may form merely a single band along its borders, as in the common *Pteris* (brake-fern). The sori are sometimes 'naked' on the under surface of the fronds; but they are frequently covered with a delicate membrane termed the *indusium*, which may either form a sort of cap upon the summit of each sorus, as in *Aspidium* (fig. 518), or a long fold, as in *Scolopendrium* and *Pteris*, or a sort of cup, as in *Deparia* (fig. 519). Each of these sori, when sufficiently magnified, is found to be made up of a multitude of *sporangies*, or spore-capsules (figs. 518, 519), which are sometimes closely attached to the surface of the frond, but more commonly spring from it by a pedicel or footstalk. The

wall of the sporangium is composed of flattened cells, applied to each other by their edges; but there is generally one row of these thicker and larger than the rest which springs from the pedicel, and is continued over the summit of the sporangium, so as to form a projecting ring, which is known as the *annulus* (fig. 519). This ring has an elasticity superior to that of all the rest of the wall of the capsule, causing it to split across when mature, so that the contained spores may escape; and in many instances the two halves of the sporangium are carried widely apart from each other, the fissure extending to such a depth as to separate them completely. In *Osmunda* (the so-called 'flowering fern' or 'royal fern') and *Ophioglossum* (adder's tongue) the sporangia have no annulus, or one greatly modified. It will frequently happen that specimens of fern-fructification gathered for the microscope will be found to have all the sporangia burst and the spores dispersed, whilst in others less advanced the sporangia may all be closed; others, however, may often be met with in which some of the sporangia are closed and others are open; and if these be watched with sufficient attention the rupture of some of the

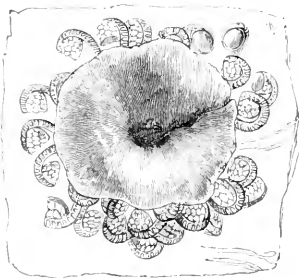

FIG. 518.—Sorus and indusium of *Aspidium*.

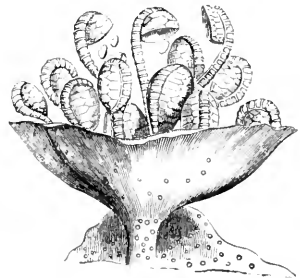

FIG. 519.—Sorus and cup-shaped indusium of *Deparia prolifera*.

sporangia and the dispersion of the spores may be observed to take place while the specimen is under observation in the field of the microscope. In sori whose sporangia have all burst, the annuli connecting their two halves are the most conspicuous objects, looking, when a strong light is thrown upon them, like strongly banded worms of a bright brown hue. This is particularly the case in *Scolopendrium*, whose elongated sori are remarkably beautiful objects for the microscope in all their stages; until quite mature, however, they need to be brought into view by turning back the two indusial folds that cover them. The commonest ferns, indeed, which are found in almost every hedge, furnish objects of no less beauty than those yielded by the rarest exotics; and it is in every respect a most valuable training to the young to teach them how much may be found to interest, when looked for with intelligent eyes, even in the most familiar, and therefore disregarded, specimens of Nature's handiwork.

The 'spores' (fig. 520, A) set free by the bursting of the sporangia, usually have a somewhat angular form, and are invested by a

yellowish or brownish outer coat, the *exospore*, which is marked very much in the manner of pollen-grains (fig. 565) with points, streaks, ridges, or reticulations. When placed upon a damp surface, and exposed to a sufficiency of light and warmth, the spore begins to germinate, the first indication of its vegetative activity being a slight enlargement, which is manifested in the rounding off of its angles. This is followed by the putting forth of a tubular prolongation (fig. 520, B, *a*) of the internal cell-wall or *endospore* through an aperture in the outer spore-coat; and moisture being absorbed through this, the cell becomes so distended as to burst the external unyielding integument, and soon begins to elongate itself in a direction opposite to that of the first rhizoid. A production of new cells by subdivision then takes place from its grow-

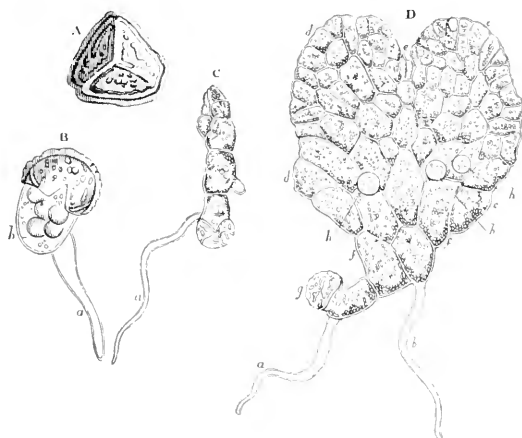

FIG. 520.—Development of prothallium of *Pteris serrulata*: A, spore set free from the sporange; B, spore beginning to germinate, putting forth the tubular prolongation *a*, from the principal cell *b*; C, first-formed linear series of cells; D, prothallium taking the form of a leaf-like expansion; *a*, first, and *b*, second rhizoid; *c*, *d*, the two lobes, and *e*, the indentation between them; *f*, *f*, first-formed part of the prothallium; *g*, external coat of the original spore; *h*, *h*, antherids.

ing extremity; this at first proceeds in a single series, so as to form a kind of confervoid filament (C); but the cell-division soon takes place transversely as well as longitudinally, so that a flattened leaf-like expansion (D) is produced, so closely resembling that of a young *Marchantia* as to be readily mistaken for it. This expansion, which is termed the *prothallium*, varies in its configuration in different species, but its essential structure always remains the same. From its under surface are developed, not merely the rhizoids (*a*, *b*), which serve at the same time to fix it in the soil and to supply it with moisture, but also the *antherids* and *archegones*, which constitute the true representatives of the essential parts of the flower of higher plants. Some of the former may be distinguished at an early period of the development of the prothallium (*h*, *h*); and at the time of its complete evolution these bodies are seen in considerable numbers,

especially in the neighbourhood of the rhizoids. Each has its origin in a peculiar protrusion that takes place from one of the cells of the prothallium (fig. 521, A, *a*); this is at first entirely filled with chlorophyll-granules, but soon cell-division sets up in it. A central cell *b* becomes distinguished from all the rest by its much larger size

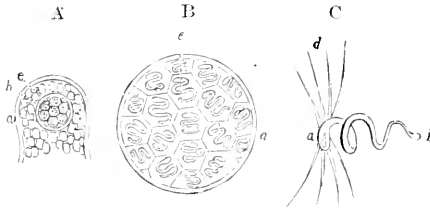

FIG. 521.—Development of the antherids and antherozoids of *Pteris serrulata*: A, projection of one of the cells of the prothallium, showing the antheridial cell *b*, with its sperm-cells *c*, within the cavity of the original cell *a*. B, antherid completely developed; *a*, wall of antheridial cell; *e*, sperm-cells, each enclosing an antherozoid. C, antherozoid more highly magnified, showing its large extremity *a*, its small extremity *b*, and its cilia *d*, *d*.

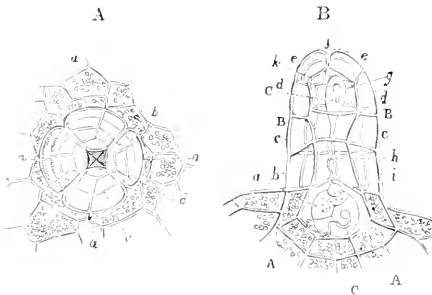

FIG. 522.—Archegone of *Pteris serrulata*: A, as seen from above; *a*, *a*, *a*, cells surrounding the base of the cavity; *b*, *c*, *d*, successive layers of cells, the highest enclosing a quadrangular orifice. B, side view, showing A, A, cavity containing the germ-cell, *a*; B, B, walls of the archegone, made up of the four layers of cells, *b*, *c*, *d*, *e*, and having an opening, *f*, on the summit; *c*, *c*, antherozoids within the cavity; *g*, large extremity; *h*, vibratile cilia; *i*, small extremity in contact with the germ-cell, and dilated.

originates in a single cell of its superficial layer, which undergoes subdivision by a horizontal partition. Of the two cells thus produced the upper gives origin, by successive subdivisions, to the 'neck' of the archegone, which, when fully developed (fig. 522), is composed of twelve or more cells, built up in layers of four cells each, one upon another, so as to form a kind of chimney or shaft. The lower of the two first-formed cells becomes the *central cell* of the archegone:

and is surrounded by one or two layers of much smaller cells known as the *tapetal* or *mantle-cells*. These take no part in the formation of the antherozoids; but the protoplasmic contents of the large central cell divide by free-cell-formation into a large number of cells known as the *antherozoid-mother-cells* (*c*); each of these again breaks up into four cells, not at first provided with cell-walls, the *sperm-cells*. Each of the sperm-cells (B, *e*) is seen, as it approaches maturity, to contain a spirally coiled filament; and when set free by the bursting of the antherid the sperm-cells themselves burst, and give exit to their antherozoids (C), which execute rapid movements of rotation on their axes, partly dependent on the long cilia with which they are furnished.

The *archegones* are fewer in number, and are found upon a different part of the prothallium. Each of them

and this again undergoing horizontal subdivision, the lower half becomes the *oosphere* or *germ-cell*, whilst the upper extends itself into the *neck*. By the conversion into micelage of a central row, an open passage or *canal* is formed, through which the antherozoids make their way to the oosphere lying at its bottom (fig. 522, B, a). The oosphere, when fertilised by the penetration of the antherozoids, becomes the 'embryo-cell' of a new plant, the development of which speedily commences.¹ In the aberrant group of *Ophioglossaceæ* (adder's-tongue ferns), the development of the prothallium takes place underground, in the form of a small roundish tuber, composed of parenchymatous tissue containing no chlorophyll, and producing antherids and archegones on its upper surface.

The early development of the embryo-cell takes place according to the usual method of repeated subdivision, producing a homogeneous globular mass of cells. Soon, however, rudiments of special organs begin to make their appearance; the embryo grows at the expense of the nutriment prepared for it by the prothallium, and it bursts forth from the cavity of the archegone, which organ in the meantime is becoming atrophied. In the very beginning of its development the tendency is seen in the cells of one extremity to grow upward so as to evolve the stem and leaves, and in those of the other extremity to grow downward to form the root; and when these organs have been sufficiently developed to absorb and prepare the nutriment which the young fern requires, the prothallium decays away. Thus, then, the 'spore' of the fern must be considered as a generative 'gonid' or detached flower-bud capable of developing itself into a prothallium that may be likened to a receptacle bearing the sexual apparatus. But this prothallium serves the further purpose of 'nursing' the embryos originated by the generative act; which embryos finally develop themselves, not, as in mosses, into mere sporogones, but, as in Phanerogams, into entire plants, con-

¹ The study of the development of the spores of ferns, and of the act of fertilisation and of its products, may be conveniently prosecuted as follows:—Let a frond of a fern whose fructification is mature be laid upon a piece of fine paper, with its spore-bearing surface downwards; in the course of a day or two this paper will be found to be covered with a very fine brownish dust, which consists of the discharged spores. This must be carefully collected, and should be spread upon the surface of a smoothed fragment of porous sandstone, the stone being placed in a saucer, the bottom of which is covered with water; and a glass tumbler being inverted over it, the requisite supply of moisture is ensured, and the spores will germinate luxuriantly. Some of the prothallia soon advance beyond the rest; and at the time when the advanced ones have long ceased to produce antherids, and bear abundance of archegones, those which have remained behind in their growth are beginning to be covered with antherids. If the crop be now kept with little moisture for several weeks, and then suddenly watered, a large number of antherids and archegones simultaneously open; and in a few hours afterwards the surface of the larger prothallia will be found almost covered with moving antherozoids. Such prothallia as exhibit freshly opened archegones are now to be held by one lobe between the forefinger and thumb of the left hand, so that the upper surface of the prothallium lies upon the thumb; and the thinnest possible sections are then to be made with a thin narrow-bladed knife, perpendicularly to its surface. Of these sections, which, after much practice, may be made no more than one-fifteenth of a line in thickness, some will probably lay open the canals of the archegones; and within these, when examined with a power of 200 or 300 diameters, antherozoids may be occasionally distinguished. The prothallium of the common *Osmunda regalis* will be found to afford peculiar facilities for observation of the development of the antherids, which are produced at its margin.

plete in everything but the true generative organs, which evolve themselves from the detached spores. Here we have, therefore, an example of *alternation of generations* differing in one important respect from that in mosses. In ferns the 'sexual generation' or 'oöphyte' which results from the germination of the spore consists of the prothallium only with its archegones and antherids, the leafy plant which bears the sporanges constituting the 'sporophyte' or 'non-sexual generation,' the product of the fertilisation of the archegone by an antherozoid. In mosses, on the other hand, the leafy plant belongs to the sexual generation.

The singular discovery has recently been made by the researches of De Bary, Farlow, and others, that the ordinary alternation of generations in ferns may be interrupted by the suppression either of the sporophyte, the non-sexual or spore-bearing generation, or of the oöphyte or sexual generation which bears the true reproductive organs. These phenomena are called respectively *apospory* and *apogamy*. The former has been observed especially in varieties of *Athyrium Filix-femina* and *Polystichum angulare*, and is shown by the production of prothalloid structures bearing antherids and archegones on the fronds in the place of ordinary sori. The latter occurs not unfrequently in *Pteris serrulata*, the sporophytic generation springing directly from the prothallium without the intervention of archegones and antherids.

The little group of **Equisetaceæ** (horse-tails), which seem nearly allied to the ferns in the type of their generative apparatus, though that of their vegetative portion is very different, affords certain objects of considerable interest to the microscopist. The whole of their structure is penetrated to such an extraordinary degree by *silica*, that even when its organic portion has been destroyed by prolonged maceration in dilute nitric acid, a consistent skeleton still remains. This mineral, in fact, constitutes in some species not less than 13 per cent. of the whole solid matter, and 50 per cent. of the inorganic ash; and it especially abounds in the epiderm, which is used by cabinet-makers for smoothing the surface of wood. Some of the siliceous particles are distributed in two lines, parallel to the axis; others, however, are grouped into oval forms, connected with each other, like the jewels of a necklace, by a chain of particles forming a sort of curvilinear quadrangle; and these (which are, in fact, the particles occupying the guard-cells of the stomates) are arranged in pairs. Their form and arrangement are peculiarly well seen under polarised light, for which the prepared epiderm is an extremely beautiful object; and it is asserted by Sir D. Brewster (whose authority upon this point has been generally followed) that each siliceous particle has a regular axis of double refraction. What is usually designated as the fructification of the Equisetaceæ forms a cone or spike at the extremity of certain of the stem-like branches (the real stem being a horizontal rhizome) and consists of a cluster of shield-like discs, each of which carries a circle of *sporangies* or spore-capsules, that open by longitudinal slits to set free the spores. In addition to the spores each sporange contains a number of elastic filaments (fig. 523), called *claters*. These are at first coiled up around

the spore, in the manner represented at A. though more closely applied to the surface; but, on the liberation of the spore, they extend themselves in the manner shown at B, the slightest application of moisture, however, serving to make them close together (the assistance which they afford in the dispersion of the spores being no longer required) when the spores have alighted on a damp surface. If a number of these spores be spread out on a slip of glass under the field of view, and, whilst the observer watches them, a bystander breathes gently upon the glass, all the filaments will be instantaneously put in motion, thus presenting an extremely curious spectacle, and will almost as suddenly return to their previous condition when the effect of the moisture has passed off. If one of the sporanges which has opened, but has not discharged its spores, be mounted in a cell with a movable cover, this curious action may be exhibited over and over again. These spores, like those of ferns, develop into a prothallium; and this bears antherids and archegones, the former at the extremities of the lobes, and the latter in the angles between them.

Nearly allied to Ferns, also, is a curious little group of small aquatic plants, the **Rhizocarpeæ** (or Pepper-worts), which either float on the surface or creep along shallow bottoms. These differ

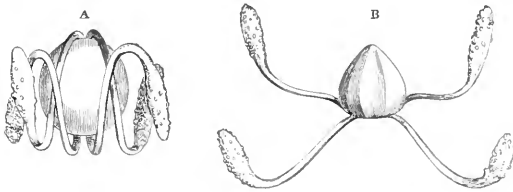

FIG. 523.—Spores of *Equisetum*, with their elaters.

from Ferns and Horse-tails in having two kinds of spore, produced in separate sporanges: the larger, or 'megaspores,' giving origin to prothallia which produce archegones only; and the smaller, or 'microspores,' undergoing progressive subdivision, usually without the formation of a distinct prothallium, each of the cells thus formed giving origin to an antherozoid. In this, as we shall presently see, there is a distinct foreshadowing of the mode in which the generative process is performed in flowering plants, the 'microspore' corresponding to the pollen-grain, while the 'megaspore' may be considered to represent the primitive cell of the ovule.

Another alliance of Ferns is to the **Lycopodiaceæ** (Club-mosses), a group which at the present time attains a great development in warm climates, and which, it would seem, constituted a large part of the arborescent vegetation of the Carboniferous epoch. In the *Lycopodia* proper the sporanges are all of one kind, and all the spores are of the same size, each, as in *Ophioglossum*, giving origin to a subterraneous prothallium that develops both antherids and archegones. The plant which originates from the fertilised 'germ-cell' of the archegone attains in colder climates only a moss-like

growth, with a creeping stem usually branching dichotomously, and imbricated leaves; but is distinguished from the true mosses, not only by its higher general organisation (which is on a level with that of ferns), but by the character of its fructification, which is a club-shaped 'spike,' bearing small imbricated leaves, in the axils of which lie the sporanges. The spores developed within these are remarkable for the large quantity of oily matter they contain, giving them an inflammability that causes their being used in theatres to produce 'artificial lightning.' But in the allied groups of *Selaginellæ* and *Isoëtæ* there are (as in the *Rhizocarpeæ*) two kinds of spore produced in separate sporanges; one set producing 'megaspores,' from which archegone-bearing prothallia are developed, and the other producing 'microspores,' which, by repeated subdivision, give origin to antherozoids without the formation of prothallia. It is a very interesting indication of a tendency towards the phanerogamic type of sexual generation, that the prothallium in this group is chiefly developed *within* the sporange, forming a kind of 'endosperm,' only the small part which projects from the ruptured apex of the spore producing one or more archegones. The arborescent *Lepidodendra* and *Sigillaria* of the Coal-measures seem to have formed connecting links between the *Vascular Cryptogams* and the *Phanerogams*, alike in the structure of their stems and in their fructification. For the *Lepidostrobi* or cone-like 'fruit' of these trees represent the club-shaped spikes of the *Lycopodiaceæ*; and seem to have borne 'megaspores' in the sporanges of their basal portion, and 'microspores' in those of their upper part. Some of the best seams of coal appear to have been chiefly formed by the accumulation of these 'megaspores.'

Thus, in our ascent from the lower to the higher Cryptogams, we have seen a gradual change in the general plan of structure, bringing their superior types into a close approximation to the flowering plant, which is undoubtedly the highest form of vegetation. But we have everywhere encountered a mode of generation which, whilst essentially the same throughout the series, is no less essentially distinct from that of the Phanerogam, the fertilising material of the 'sperm-cells' being embodied, as it were, in self-moving filaments, the antherozoids, which find their way to the 'germ-cells' by their own independent movements, and the 'embryo-cell' being destitute of that store of prepared nutriment which surrounds it in the true seed, and supplies the material for its early development. In the lower Cryptogamus we have seen that the fertilised oöspore is thrown at once upon the world, so to speak, to get its own living; but in ferns and their allies the 'embryo-cell' is nurtured for a while by the prothallium of the parent plant. While the true reproduction of the species is effected by the proper generative act, the multiplication of the individual is accomplished by the production and dispersion of 'gonidial' spores; and this production, as we have seen, takes place at very different periods of existence in the several

groups, dividing the life of each into two separate epochs, in which it presents itself under two very distinct phases that contrast remarkably with each other. Thus, the frond of *Marchantia*, evolved from the spore and bearing the antherids and archegones, is that which seems naturally to constitute the plant; but that which represents this phase in the ferns is the minute *Marchantia*-like prothallium. In ferns, on the other hand, the product into which the fertilised 'embryo-cell' evolves itself is that which is commonly regarded as the plant; and this is represented in the liverworts and mosses by the sporogone alone.¹ We shall encounter a similar diversity (which has received the inappropriate designation of 'alternation of generations') in some of the lower forms of the animal kingdom.

¹ For more detailed information on the structure and classification of the Cryptogams generally the reader is referred to Goebel's *Outlines of Classification and Special Morphology* and De Bary's *Comparative Anatomy of the Phanerogams and Ferns*, translations of both of which have been published by the Clarendon Press; and especially to Bennett and Murray's *Handbook of Cryptogamic Botany*, published by Longmans (London, 1889).

CHAPTER XI

OF THE MICROSCOPIC STRUCTURE OF PHANEROGAMIC PLANTS

BETWEEN the two great divisions of the Vegetable Kingdom which are known as *Cryptogamia* and *Phanerogamia* the separation is by no means so abrupt as it formerly seemed to be. For, as has been already shown, though the Cryptogamia were formerly regarded as altogether non-sexual, a true generative process, requiring the concurrence of male and female elements, is traceable almost throughout the series. And in the higher types of that series we have seen a foreshadowing of those provisions for the nurture of the fertilised embryo which constitute the distinctive characters of the Phanerogamia. On the other hand, although we are accustomed to speak of *Phanerogamia* as 'flowering plants,' yet not only are the conspicuous parts of the flower often wanting, but in the important group of *Gymnosperms* (including the *Conifera* and *Cycadea*) the essential parts of the generative apparatus are reduced to a condition closely approximating to that of the higher Cryptogams. There are, however, certain fundamental differences between the modes in which the act of fertilisation is performed in the two groups. For (1) whilst in all the higher Cryptogams it is in the condition of free-moving 'antherozoids' that the contents of the sperm-cell find their way to the germ-cell, these are conveyed to it, throughout the phanerogamic series, by an extension of the lining membrane of the sperm-cell or pollen-grain into a tube, which penetrates to the germ-cell, contained in the interior of the body called the *ovule*.¹ Again (2), while the 'germ-cell' or oösphere in the higher Cryptogams is contained in a structure that originated in a spore detached from the parent plant, it is not only formed and fertilised in all Phanerogams whilst still borne on the parent fabric, but continues for some time to draw from it the nutriment it requires for its development into the *embryo*. And at the time of its detachment from the parent the

¹ A very remarkable and interesting discovery, for which we are largely indebted to the brilliant observations of two Japanese botanists, Professors Ikeno and Hirase, has recently thrown great light on the approximation referred to by Dr. Carpenter between the higher Cryptogamia and the lower Phanerogamia. It is now known that in both the larger groups of Gymnosperms, the *Conifera* and the *Cycadea*, there are species in which the fertilising body is a motile antherozoid formed within a pollen-tube, thus combining the distinctive modes of fertilisation characteristic of the two great sections of the vegetable kingdom. As Dr. Carpenter does not include in his account of the 'Microscopic Structure of Phanerogamic Plants' a full description of the mode of impregnation in flowering plants, the reader is referred, for further details, to the most recent Text-books of Botany, or to the Summary of Current Researches in Botany in the *Journal of the R. Microscopical Society*.—[EDITH.]

matured 'seed' contains, not merely an embryo already advanced a considerable stage, but a store of nutriment to serve for its further development during germination. As there is nothing parallel to this among Cryptogams, it may be said that reproduction by *seeds*, not the possession of flowers, is the distinctive character of Phanerogams. The *ovules*, which when fertilised and matured become seeds, are developed from specially modified leaves, which remain open in Gymnosperms, but which in all other Phanerogams fold together so as to enclose the ovules within an *ovary*. Each ovule consists of a *nucellus* surrounded by *integuments* which remain unclosed at the apex, leaving open a short canal termed the *micropyle* or 'foramen.' One cell of the nucellus undergoes great enlargement, and becomes the *embryo-sac*, whose cavity is filled, in the first instance, with a mucilaginous fluid containing protoplasm. At the end of the embryo-sac which lies nearest the micropyle a germ-cell or *öosphere* is developed; in Angiosperms by free-cell-formation, but in Gymnosperms indirectly after the formation of a 'corpuscle,' which represents the archegone of *Selaginella*. By a further process of free-cell-formation the remainder of the embryo-sac comes to be filled with cells constituting what is termed the *endosperm*: and this serves, like the prothallium of ferns, to imbibe and prepare nutriment which is afterwards appropriated by the embryo. In many seeds (as those of the *Leguminosæ*) the whole nutritive material of the endosperm has been absorbed into the *cotyledons* (or seed-leaves) of the embryo by the time that the seed is fully matured and independent of the parent; but in other cases it remains as a 'separate endosperm.' In either case it is taken into the substance of the embryo during its germination.

Elementary Tissues.—No marked change shows itself in general organisation as we pass from the cryptogamic to the phanerogamic series of plants. A large proportion of the fabric of even the most elaborately formed tree (including the parts most actively concerned in living action) is made up of components of the very same kind as those which constitute the entire organisms of the simplest cryptogams. For, although the stems, branches, and roots of trees and shrubs are principally composed of *woody* tissue, such as we do not meet with in any but the highest Cryptogams, yet the special office of this is to afford mechanical support; when it is once formed, it takes no further share in the vital economy than to serve for the conveyance of fluid from the roots upwards through the stem and branches to the leaves; and even in these organs (in Exogens or Dicotyledons), not only the pith and the cortex, with the 'medullary rays,' which serve to connect them, but the 'cambium layer' intervening between the bark and the wood in which the periodical formation of the new layers both of bark and wood takes place, are composed of *cellular* substance. This tissue is found, in fact, wherever *growth* is taking place; as, for example, in the growing points of the root-fibres, in the leaf-buds and leaves, and in the flower-buds and sexual parts of the flower; it is only when these organs attain an advanced stage of development that *woody* structure is found in them; its function (as in the stem) being merely to give

support to their softer textures; and the small proportion of their substance which it forms is at once seen in those beautiful 'skeletons' which, by a little skill and perseverance, may be made of leaves, flowers, and certain fruits. All the softer and more pulpy tissue

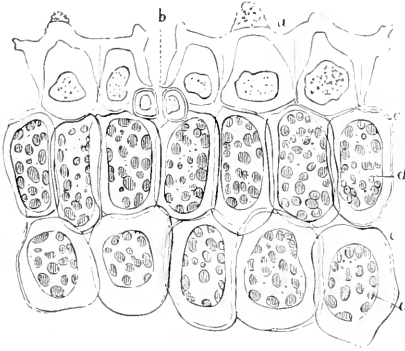

FIG. 524.—Section of leaf of *Agave*, treated with dilute nitric acid, showing the protoplasmic contents contracted in the interior of the cells; *a*, epidermal cells; *b*, guard-cells of the stomate; *c*, cells of parenchyma; *d*, their protoplasmic contents.

of these organs is composed of *cells*, more or less compactly aggregated together, and having forms that approximate more or less closely to the globular or ovoidal, which may be considered as their original type.

As a general rule, the rounded shape is preserved only when the cells are but loosely aggregated, as in the parenchymatous (or pulpy) substance of leaves, which often forms a distinct layer known as the 'spongy parenchyma' immediately beneath the epiderm of the upper surface (fig. 524); and it is then only that the distinctness of their walls becomes evident. When the tissue becomes more solid, the sides of the vesicles are pressed against each other, so as to flatten

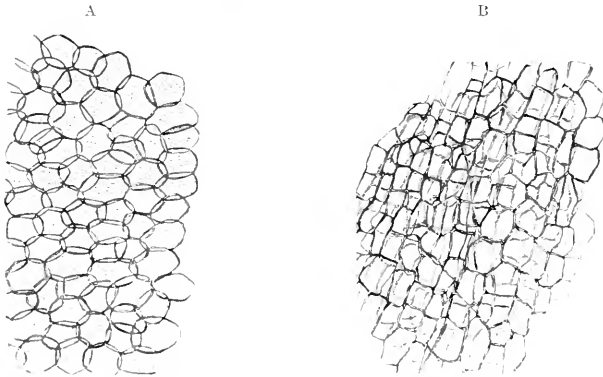

FIG. 525. Sections of cellular parenchyma of *Aralia*, or rice-paper plant. A, transversely to the axis of the stem; B, in the direction of the axis.

them and to bring them into close apposition, and then the cavities of adjacent cells are separated by a single partition wall. Frequently it happens that the pressure is exerted more in one direction than in another, so that the form presented by the outline of the cell

varies according to the direction in which the section is made. This is well shown in the pith of the young shoots of elder, lilac, or other rapidly growing trees, the cells of which, when cut transversely, generally exhibit circular outlines; whilst, when the section is made vertically, their borders are straight, so as to make them appear like cubes or elongated prisms, as in fig. 524. A very good example of such a cellular parenchyme is to be found in the substance known as 'rice-paper,' which is made by cutting the herbaceous stem of a Chinese plant termed *Aralia papyrifera* vertically round and round with a long sharp knife, so that its tissues may be (as it were) unrolled in a sheet. The shape of its cells when thus prepared is irregularly prismatic, as shown in fig. 525, B; but if the stem be cut transversely, their outlines are seen to be circular or nearly so (A). When, as often happens, the cells have a very elongated form, this elongation is in the direction of their growth, which is that, of course, wherein there is least resistance. Hence their greatest length is nearly always in the direction of the axis; but there is one remarkable exception, that, namely, which is afforded by the 'medullary rays' of exogenous stems, whose cells are greatly elongated in the horizontal direction (fig. 547, a), their growth being from the centre of the stem towards its circumference. It is obvious that fluids will be more readily transmitted in the direction of greatest elongation, being that in which they will have to pass through the least number of partitions; and whilst their ordinary course is in the direction of the length of the roots, stems, or branches, they will be enabled by means of the medullary rays to find their way in the *transverse* direction. One

of the most curious varieties of form which vegetable cells present is the *stellate* cell, represented in fig. 526, forming the spongy parenchymatous substance in the stems of many aquatic plants, of the rush for example, which are furnished with air-spaces. In other instances these air-spaces are large cavities which are altogether left void of tissue: such is the case in *Nuphar lutea* (the yellow water-lily), the foot-

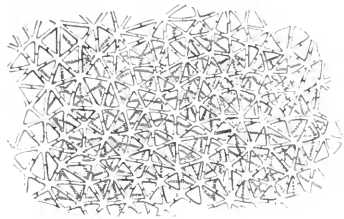

FIG. 526.—Section of stellate parenchyme of rush.

stalks of whose leaves contain large air-chambers, the walls of which are built up of very regular cubical cells, whilst some curiously formed large stellate cells project into the cavity which they bound (fig. 527). The dimensions of the component vesicles of cellular tissue are extremely variable; for although their diameter is very commonly between $\frac{1}{300}$ th and $\frac{1}{500}$ th of an inch, they occasionally measure as much as $\frac{1}{30}$ th of an inch across, whilst in other instances they are not more than $\frac{1}{300}$ th.

The cells of a growing tissue are always formed, as we have seen, by cell-division, that is, by the formation of cellulose walls across cells previously in existence. The original cell-wall must therefore always be single. It is only in older thick-walled cells that a line of

demarcation becomes obvious in the form of an intermediate lamella, at one time called 'intercellular substance,' and supposed to be a distinct structure, but now shown to be the result merely of a difference in density or molecular structure of the cell-walls during their thickening. This layer very frequently ultimately assumes a mucilaginous character. Where cells have a rounded outline, it is obvious that *intercellular spaces* must exist between them; and as the tissue develops, these spaces often increase greatly in size. They are called *schizogenous* if formed simply by the parting of cells from one another; *lysigenous* if resulting from the disappearance or absorption of cells. Recent observations have shown that the wall of intercellular spaces is frequently clothed with a lining of protoplasm. There are many forms of fully developed cellular parenchyme, in which, in consequence of the loose aggregation of their component cells, these may be readily isolated, so as to be prepared

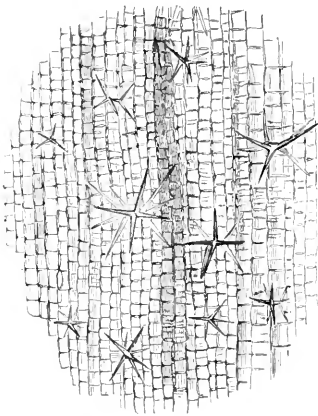

FIG. 527.—Cubical parenchyme, with stellate cells, from petiole of *Nuphar lutea*.

for separate examination without the use of reagents which alter their condition; this is the case with the pulp of ripe fruits, such as the strawberry or currant (the snowberry is a particularly favourable subject for this kind of examination), and with the parenchyme of many fleshy leaves, such as those of the carnation (*Dianthus caryophyllus*) or the London pride (*Saxifraga umbrosa*). Such cells usually contain evident *nuclei* which are turned brownish-yellow by iodine, whilst their membrane is only turned pale yellow, and in this way the nucleus may be brought into view when, as often happens, it is not previously distinguishable. If a drop of the iodised

solution of chloride of zinc be subsequently added, the cell-membrane becomes of a beautiful blue colour, whilst the nucleus and the granular protoplasm that surrounds it retain their brownish-yellow tint. The use of dilute nitric or sulphuric acid, of alcohol, of syrup, or of several other reagents, serves to bring into view the 'primordial' or *parietal utricle*, its contents being made to coagulate and shrink, so that it detaches itself from the cellulose wall with which it is ordinarily in contact, and shrivels up within its cavity, as shown in fig. 524. It would be a mistake, however, to regard this as a distinct membrane; for it is nothing else than the peripheral layer of protoplasm, naturally somewhat more dense than that which it includes, but passing into it by insensible gradations.

It is probable that all cells, at some stage or other of their growth, exhibit, in a greater or less degree of intensity, that curious movement of *cyclosis* which has been already described as occurring

in the *Characeæ* (see p. 564), and which consists in the steady flow of one or of several currents of protoplasm over the inner wall of the cell, this being rendered apparent by the movement of the particles which the current carries along with it. The best examples of it are found among submerged plants, in the cells of which it continues for a much longer period than it usually does elsewhere; and among these are two, *Vallisneria spiralis* and *Anacharis alismastrum* (or *Elodea canadensis*), which are peculiarly fitted for the exhibition of this interesting phenomenon. *Vallisneria* is an aquatic plant that grows abundantly in the rivers of the south of Europe, but is not a native of this country; it may, however, be readily grown in a tall glass jar having at the bottom a couple of inches of mould, which, after the roots have been inserted into it, should be closely pressed down, the jar being then filled with water, of which a portion should be occasionally changed.¹ The jar should be freely exposed to light, and should be kept in as warm but equable a temperature as possible. The long grass-like leaves of this plant are too thick to allow the transmission of sufficient light through them for the purpose of this observation, and it is requisite to make a thin slice or shaving with a sharp knife. If this be taken from the surface, so that the section chiefly consists of the superficial layer of cells, these will be found to be small, and the particles of chlorophyll, though in great abundance, will rarely be seen in motion. This layer should therefore be sliced off (or perhaps still better, scraped away) so as to bring into view the deeper layer, which consists of larger cells, some of them greatly elongated, with particles of chlorophyll in smaller number, but carried along in active rotation by the current of protoplasm; and it will often be noticed that the directions of the rotation in contiguous cells are opposite. If the movement (as is generally the case) be checked by the shock of the operation, it will be revived again by gentle warmth; and it may continue under favourable circumstances, in the separated fragment, for a period of weeks, or even of months. Hence, when it is desired to exhibit the phenomenon, the preferable method is to prepare the sections a little time before they are likely to be wanted, and to carry them in a small vial of water in the waistcoat pocket, so that they may receive the gentle and continuous warmth of the body. In summer, when the plant is in its most vigorous state of growth, the section may be taken from any one of the leaves; but in winter it is preferable to select those which are a little yellow. An objective of $\frac{1}{4}$ -inch focus will serve for the observation of this interesting phenomenon, and very little more can be seen with a $\frac{1}{2}$ -inch; but the $\frac{3}{5}$ -inch constructed by Messrs. Powell and Lealand enables the borders of the protoplasmic current, which carries along the particles of chlorophyll, to be distinctly defined; and this beautiful

¹ Mr. Quekett found it the most convenient method of changing the water in the jars in which *Chara*, *Vallisneria*, &c., are growing, to place them occasionally under a water-tap, and allow a very gentle stream to fall into them for some hours; for by the prolonged overflow thus occasioned all the impure water, with the *Conferva* that is apt to grow on the sides of the vessel, may be readily got rid of.

phenomenon may be most luxuriously watched under their patent binocular.

Anacharis alinastrum is a water-weed which, having been accidentally introduced into this country many years ago, has since spread itself with such rapidity through our canals and rivers as in many instances seriously to impede their navigation. It does not require to root itself in the bottom, but floats in any part of the water it inhabits; and it is so tenacious of life that even small fragments are sufficient for the origination of new plants. The leaves have no distinct epiderm, but are for the most part composed of two layers of cells, and these are elongated and colourless in the centre, forming a kind of midrib; towards the margins of the leaves, however, there is but a single layer. Hence no preparation whatever is required for the exhibition of this interesting phenomenon, all that is necessary being to take a leaf from the stem (one of the older yellowish leaves being preferable), and to place it, with a drop of water, either in the aquatic box or on a slip of glass beneath a thin glass cover. A higher magnifying power is required, however, than that which suffices for the examination of the cyclosis in *Chara* or in *Vallisneria*, the $\frac{1}{8}$ -inch object-glass being here preferable to the $\frac{1}{4}$ -inch, and the assistance of the achromatic condenser being desirable. With this amplification the phenomenon may be best studied in the single layer of marginal cells, although, when a lower power is used, it is most evident in the elongated cells forming the central portion of the leaf. The number of chlorophyll-granules in each cell varies from three or four to upwards of fifty; they are somewhat irregular in shape, some being nearly circular flattened discs, whilst others are oval; and they are usually from $\frac{1}{30000}$ th to $\frac{1}{50000}$ th of an inch in diameter. When the rotation is active the greater number of these granules travel round the margin of the cells, a few, however, remaining fixed in the centre; their rate of movement, though only $\frac{1}{30}$ th of an inch per minute, being sufficient to carry them several times round the cell within that period. As in the case of *Vallisneria*, the motion may frequently be observed to take place in opposite directions in contiguous cells. The thickness of the layer of protoplasm in which the granules are carried round is estimated by Mr. Wenham at no more than $\frac{1}{200000}$ th of an inch. When high powers and careful illumination are employed, delicate ripples may be seen in the protoplasmic currents.¹

Cyclosis, however, is by no means restricted to submerged plants; for it has been witnessed by numerous observers in so great a variety of other species that it may fairly be presumed to be universal. It is especially observable in the hairs of the epidermal surface. Such hairs are furnished by various parts of plants; and what is chiefly necessary is that the part from which the hair is gathered should be in a state of vigorous growth. The hairs should be detached by tearing off with a pair of fine pointed forceps the portion of the epiderm from which they spring, care being taken not to grasp the hair itself, whereby such an injury would be done to it as to check the movement within it. The apochromatic hair should then be

¹ *Quart. Journ. of Microsc. Science*, vol. iii. (1855), p. 277.

placed with a drop of water under thin glass; and it will generally be found advantageous to use a $\frac{1}{8}$ -inch with the 12 or the 18 eyepiece objective with an achromatic condenser. The nature of the movement in the hairs of different species is far from being uniform. In some instances, the currents pass in single lines along the entire length of the cells, as in the hairs from the filaments of *Tradescantia virginica*, or Virginian spiderwort (fig. 528. A); in others there are several such currents which retain their distinctness, as in the jointed hairs of the calyx of the same plant (B); in others, again, the streams coalesce into a network, the reticulations of which change their position at short intervals, as in the hairs of *Glaucoium luteum*; whilst there are cases in which the current flows in a sluggish uniformly moving sheet or layer. Where several distinct currents exist in one cell, they are all found to have one common point of departure and return, namely, the nucleus (B. a), from which it seems fairly to be inferred that this body is the centre of the vital activity of the cell. In all cases in which the cyclosis is seen in the hairs of a plant, the cells of the epiderm also display it, provided that their walls are not so opaque or so strongly marked as to prevent the movement from being distinguished. The epiderm may be most readily torn off from the stalk or the midrib of the leaf, and must then be examined as speedily as possible, since it loses its vitality when thus detached much sooner than do the hairs. Even when no obvious movement of particles is to be seen, the existence of

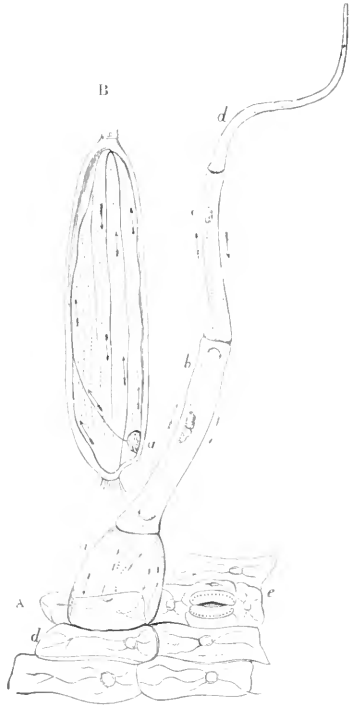

FIG. 528. —Rotation of fluid in hairs of *Tradescantia virginica*: A, portion of epiderm with hair attached; a, b, c, successive cells of the hair; d, cells of the epiderm; e, stomate. B, joints of a beaded hair showing several currents; a, nucleus.

a cyclosis may be concluded from the peculiar arrangement of the molecules of the protoplasm, which are remarkable for their high refractive power, and which, when arranged in a 'moving train,' appear as bright lines across the cell; and these lines, on being carefully watched, are seen to alter their relative positions. The leaf of the common *Plantago* (plantain) furnishes an excellent example of cyclosis, the movement being distinguishable at the same time both in the cells and in the hairs of the epiderm torn from its stalk

or midrib. It is a curious circumstance that when a plant which exhibits the cyclosis is kept in a cold dark place for one or two days, not only is the movement suspended, but the moving particles collect together in little heaps, which are broken up again by the separate motion of their particles when the stimulus of light and warmth occasions a renewal of the activity. It is well to collect the specimens about midday, that being the time when the rotation is most active, and the movement is usually quickened by artificial warmth, which, indeed, is a necessary condition in some instances to its being seen at all. The most convenient method of applying this warmth, while the object is on the stage of the microscope, is to blow a stream of air upon the thin glass cover previously heated in a spirit-lamp.

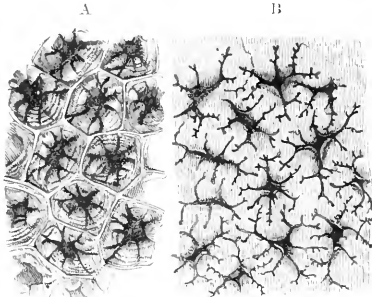

FIG. 529.—Tissue of the testa or seed-coat of star-anise; A, as seen in section; B, as seen on the surface.

The walls of the cells of plants are frequently thickened by deposits, which are first formed on the inner surface, and which may present very different appearances according to the manner in which they are arranged. In

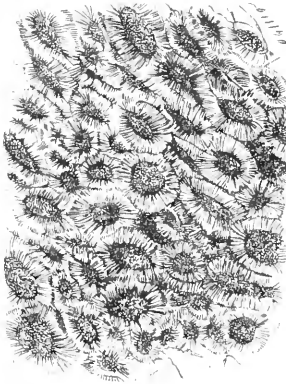

FIG. 530.—Section of cherry-stone, cutting the cells transversely.



FIG. 531.—Section of coquilla nut in the direction of the long diameter of the cells.

its simplest condition such a deposit forms a thin uniform layer over the whole internal surface of the cellulose wall, scarcely detracting at all from its transparency, and chiefly distinguishable by the 'dotted' appearance which the membrane then presents (fig. 525. A). These dots, however, are not pores, as their aspect might naturally suggest, but are merely points at which the deposit is wanting, so

that the original cell-wall there remains unthickened. A more complete consolidation of cellular tissue is effected by deposits of *sclerogen* (a substance which, when separated from the resinous and other matters that are commonly associated with it, is found to be allied in chemical composition to cellulose) in successive layers, one within another (fig. 529, A), which present themselves as concentric rings when the cells containing them are cut through; and these layers are sometimes so thick and numerous as almost to obliterate the original cavity of the cell. Such a tissue is known as *sclerenchyme* or sclerenchymatous tissue. By a continuance of the same arrangement as that which shows itself in the single layer of the dotted cell—each deposit being deficient at certain points, and these points corresponding with each other in the successive layers—a series of passages is left, by which the cavity of the cell is extended at some points to its membranous wall; and it commonly happens that the points at which the deposit is wanting on the walls of the contiguous cells are coincident, so that the membranous partition is the only obstacle to the communication between their cavities (figs. 529-531). It is of such tissue that the 'stones' of stone-fruit, the gritty substance which surrounds the seeds and forms little hard points in the fleshy substance of the pear, the shell of the cocoa-nut, and the endosperm of the seed of *Phytalephas* (known as 'vegetable ivory') are made up; and we see the use of this very curious arrangement in permitting the cells, even after they have attained a considerable degree of consolidation, still to remain permeable to the fluid required for the nutrition of the parts which such tissue encloses and protects.

The deposit sometimes assumes, however, the form of definite *fibres*, which lie coiled up on the inner surface of the cells, so as to form a single, a double, or even a triple or quadruple spire (fig. 532). Such *spiral cells* are found abundantly in the leaves of certain orchidaceous plants, immediately beneath the epiderm, where they are brought into view by vertical sections; and they may be obtained in an isolated state by macerating the leaf and peeling off the epiderm so as to expose the layer beneath, which is then easily separated into its components. In an orchidaceous plant named *Saccolabium guttatum* the spiral cells are unusu-



FIG. 532.—Spiral cells of leaf of *Oncidium*.

ally long, and have spires winding in opposite directions, so that by their mutual intersection a series of diamond-shaped markings is produced. Spiral cells are often found upon the surface of the testa or outer coat of seeds; and in *Collomia grandiflora*, *Salvia verbenaca* (wild clary), and some other plants, the membrane of these cells is so weak, and the elasticity of their fibres so great, that when the membrane is softened by the action of water the fibres suddenly uncoil and elongate themselves (fig. 533), springing out, as it were, from the surface of the seed, to which they give a

peculiar flocculent appearance. This very curious phenomenon may be best observed in the following manner:—A very thin transverse slice of the seed should first be cut, and laid upon the lower



FIG. 533.—Spiral fibres of seed-coat of *Collomia*.

glass of the aquatic box; the cover should then be pressed down, and the box placed upon the stage, so that the microscope may be exactly focussed to the object, the power employed being the 1-inch, $\frac{2}{3}$ -inch, or $\frac{1}{2}$ -inch. The cover of the aquatic box being then removed, a small drop of water should be placed on that part of its internal surface with which the slice of the seed had been in contact; and the cover being replaced, the object should be immediately looked at. It is important that the slice of the seed should be very thin, for two reasons: first, that the view of the spirals may not be confused

by their aggregation in too great numbers; and second, that the drop of water should be held in its place by capillary attraction, instead of running down and leaving the object, as it will do if the glasses be too widely separated.

In some part or other of most plants we meet with cells containing granules of *starch*, which specially abound in the tubers of the potato and in the seeds of cereals. Starch-grains are originally formed in the interior of chlorophyll-corpuscles, and therefore within the protoplasm-layer of the cell; but as they increase in size, the protoplasm-layer thins itself out as a mere covering film, and at last almost entirely disappears. So long as the starch-grains remain imbedded in the protoplasm-layer, they continue to grow; but when they accumulate so as to occupy the cell-cavity, their growth stops.

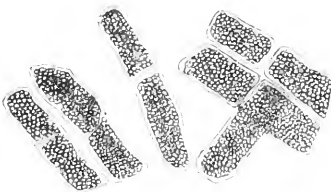

FIG. 534.—Cells of peony filled with starch.



FIG. 535.—Granules of starch as seen under polarised light.

They are sometimes minute and very numerous, and so closely packed as to fill the cell-cavity (fig. 534); in other instances they are of much larger dimensions, so that only a comparatively small number of them are included in any one cell; while in other

cases, again, they are both few and minute, so that they form but a small proportion of the cell-contents. Their nature is at once detected by the addition of a solution of iodine, which gives them a beautiful blue colour. Each granule when highly magnified exhibits a peculiar spot, termed the *hilum*, round which are seen a set of circular lines that are for the most part concentric (or nearly so) with it. When viewed by polarised light each grain exhibits a dark cross, the point of intersection being at the hilum (fig. 535); and when a selenite plate is interposed the cross becomes beautifully coloured. Opinions have been very much divided regarding the internal structure of the starch-grain, but the doctrine of Nägeli that it is composed of successive layers which increase by 'intussusception,' that is, by the intercalation of fresh molecules of starch between those already in existence, is favoured by many authorities, though the alternative theory of formation by the 'apposition' of successive layers also has many advocates. These layers differ in their proportion of water, the outermost layer, which is the most solid, having within it a watery layer, this, again, being succeeded by a firm layer, which is followed by a watery layer, and so on, the proportion of water increasing towards the centre in both kinds of layer, and attaining its maximum in the innermost part of the grain, where the formation of new layers takes place, causing the distension of the older ones. Although the dimensions of the starch-grains produced by any one species of plant are by no means constant, yet there is a certain average for each, from which none of them depart very widely; and by reference to this average the starch-grains of different plants that yield this product in abundance may be microscopically distinguished from one another—a circumstance of considerable importance in commerce. The largest starch-grains in common use are those of the plant (a species of *Canna*) known as 'tous-les-mois.' The average diameter of those of the potato is about the same as the diameter of the smallest of the 'tous-les-mois,' and the size of the ordinary starch-grains of wheat and of sago is about the same as that of the smallest grains of potato-starch; whilst the granules of rice-starch are so very minute as to be at once distinguishable from any of the preceding.

In certain plants, especially those belonging to particular natural orders, the stem, leaves, and other parts are permeated by long branched tubes, constituting the *laticiferous tissue*. The elements of this tissue may be either greatly enlarged prosenchymatous cells or true vessels. In either case they contain a copious milky-white or coloured juice, the *latex*, which exudes freely when the part containing it is wounded, and dries rapidly on exposure. The chemical composition of the latex varies; it may contain in solution powerful alkaloids, as in the case of the opium-poppy, or gum-resins. Caoutchouc and gutta-percha are the dried latex of tropical trees and shrubs belonging to several natural orders. Good examples of laticiferous tissue are furnished by the Papaveraceæ, of which our common field-poppy is an example, many Compositæ such as the dandelion and lettuce, Convolvulaceæ, Euphorbiaceæ or spurge, Apocynaceæ, Moraceæ including the mulberry &c.

Deposits of mineral matter in a crystalline condition, known as *raphides*, are not unfrequently found in vegetable cells, where they are at once brought into view by the use of polarised light. Their designation (derived from *ῥαφίς*, a needle) is very appropriate to one of the most common states in which these bodies present themselves, that, namely, of bundles of needle-like crystals, lying side by side in the cavity of the cells; such bundles are well seen in the cells lying immediately beneath the epiderm of the bulb of the medicinal squill. It does not apply, however, to other forms which are scarcely less abundant; thus, instead of bundles of minute needles, single large crystals, octahedral or prismatic, are frequently met with, and the prismatic crystals are often aggregated in beautiful stellate groups. The most common material of these crystals is oxalate of lime, which is generally found in the stellate form; and no plant yields these stellate raphides so abundantly as the common rhubarb, the best specimens of the dry medicinal root containing as much as 35 per cent. of them. In the epiderm of the bulb of the onion the same material occurs in the octahedral or the prismatic form. In other instances, the calcareous base is combined with tartaric, citric, or malic acid; the acicular raphides consist almost invariably of oxalate of lime. Some raphides are as long as $\frac{1}{40}$ th of an inch, while others measure no more than $\frac{1}{1000}$ th. They occur in all parts of plants—the wood, pith, bark, root, leaves, stipules, sepals, petals, fruit, and even in the pollen. They are always situated in cells, and not in the intercellular passages; the cell-membrane, however, is often so much thinned away as to be scarcely distinguishable. Certain plants of the *Cactus* tribe, when aged, have their tissues so loaded with raphides as to become quite brittle, so that when some large specimens of *C. senilis*, said to be a thousand years old, were sent to Kew Gardens from South America, some years since, it was found necessary for their preservation during transport to pack them in cotton like jewellery. Raphides are probably to be considered as non-essential results of the vegetative processes, being for the most part produced by the union of organic acids generated in the plant with mineral bases imbibed by it from the soil. The late Mr. E. Quekett succeeded in artificially producing raphides within the cells of rice-paper, by first filling these with lime-water by means of the air-pump, and then placing the paper in weak solutions of phosphoric and oxalic acids. The artificial raphides of phosphate of lime were rhombohedral; while those of oxalate of lime were stellate, exactly resembling the natural raphides of the rhubarb. Besides the structures already mentioned as affording good illustrations of different kinds of raphides, may be mentioned the parenchyma of the leaf of *Agave*, *Alôë*, *Cycas*, *Encephalartos*, &c.; the epiderm of the bulb of the hyacinth, tulip, and garlic; the bark of the apple, *Cascarilla*, *Cinchona*, lime, locust, and many other trees; the pith of *Elaeagnus*, and the testa of the seeds of *Anagallis* and the elm.

A large proportion of the denser parts of the fabric of the higher plants is made up of the substance which is known as *woody fibre* or *prosenchymatous tissue*. This, however, can only be regarded as a variety of cellular tissue; for it is composed of peculiarly elongated

cells (fig. 551), usually pointed at their two extremities so as to become spindle-shaped, whose walls have a special tendency to undergo consolidation by the internal deposit of sclerogen. It is obvious that a tissue consisting of elongated cells, adherent together by their entire length, and strengthened by internal deposit, must possess much greater tenacity than any tissue in which the cells depart but little from the primitive spherical form; and we accordingly find woody fibre present wherever it is requisite that the fabric should possess not merely density, but the power of resistance to tension. In the higher classes of the vegetable kingdom it constitutes the chief part of the stem and branches, where these have a firm and durable character; and even in more temporary structures, such as the herbaceous stems of annual plants, and the leaves and flowers of almost every tribe, this tissue forms a more or less important constituent, being especially found in the neighbourhood of the spiral vessels and ducts, to which it affords protection and support. Hence the bundles of fasciculi composed of these elements, which form the 'veins' of leaves, and which give 'stringiness' to various esculent vegetable substances, are commonly known under the name of *fibro-vascular* tissue. In their young and unconsolidated state the woody cells seem to conduct fluids with great facility in the direction of their length; and in the *Conifera*, whose stems and branches are destitute of ducts, they afford the sole channel for the ascent of the sap. The *fibro-vascular bundles*, which are the chief strengthening elements of such organs as the stem, branches, leaf-stalks, flower-stalks, &c., are, in the higher plants, structures of considerable complexity; in Exogens they consist of three distinct portions, the *xylem*-portion composed chiefly of the different kinds of vessels hereafter to be described, a *phloëm*-portion composed of prosenchymatous tissue and 'sieve-tubes,' and a formative *cambium*-portion.

A peculiar set of markings seen on the woody fibres of the *Conifera*, and of some other tribes, is represented in fig. 536: in each of these spots the inner circle appears to mark a deficiency of the lining deposit, as in the pitted cells of other plants; whilst the outer circle indicates the boundary of a lenticular cavity which intervenes between the adjacent cells at this point. There are varieties in this arrangement so characteristic of different tribes that it is sometimes possible to determine, by the microscopic inspection of a minute fragment, even of a fossil wood, the tribe to which it belonged. Markings of this kind, very characteristic of the wood of *Conifera*, though not peculiar to that

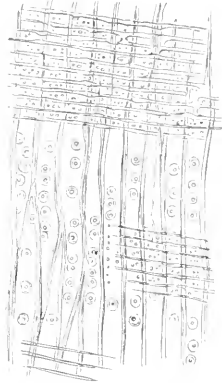

FIG. 536. — Section of coniferous wood in the direction of the tracheids, showing their 'bordered pits;' *a, a, a*, medullary rays crossing the fibres.

order, are known as *bordered pits*, and the elongated cells in which they occur as *tracheïds*.

All the more perfect forms of Phanerogams contain, in some part of their fabric, the peculiar structures which are known as *spiral vessels*.¹ These have the elongated shape of fibre-cells; but the internal deposit, as in the spiral cells, takes the form of a spiral fibre winding from end to end, and retaining its elasticity; this fibre may be single, double, or even quadruple, this last character presenting itself in the very large elongated fibre-cells of *Nepenthes* (pitcher-plant). Such vessels are especially found in the delicate membrane (medullary sheath) surrounding the pith of Exogens, and in the 'xylem-portion' of the woody bundles of Exogens and Endogens; thence they proceed to the leaf-stalks, through which they are distributed to the leaves. By careful dissection under the microscope these *fibro-vascular bundles* may be separated entire; but their structure may be more easily displayed by cutting round, but not through, the leaf-stalk of the strawberry, geranium, &c., and then drawing the parts asunder. The membrane composing the tubes of the vessels will thus be broken across; but the fibres within, being elastic, will be drawn out and unrolled. Spiral vessels are sometimes found to convey fluid, whilst in other cases they contain *air* only.

Although fluid generally finds its way with tolerable facility through the various forms of cellular tissue, especially in the direction of the greatest length of the cells, a more direct means of connection between distant parts is required for its active transmission. This is afforded by the peculiar kind of vessels known as *ducts*, which consist of cells laid end to end, the partitions between them being more or less obliterated. The origin of these ducts is occasionally very evident, both in the contraction of their diameter at regular intervals, and in the persistence of remains of their partitions (fig. 551, *b, b*): but in most cases it can only be ascertained by studying the history of their development, neither of these indications being traceable. Some of these ducts (fig. 537, 2) are indistinguishable from the *spiral* vessels already described, save in the want of elasticity in their spiral fibre, which causes it to break when the attempt is made to draw it out. This rupture would seem to have taken place, in some instances, from the natural elongation of the cells by growth, the fibre being broken up into rings, which lie sometimes close together, but more commonly at considerable intervals; such a duct is said to be *annular* (fig. 537, 1). Intermediate forms between the spiral and annular ducts, which show the derivation of the latter from the former, are very frequently to be met with. The spirals are sometimes broken up still more completely, and the fragments of the fibre extend in various directions, so as to meet and form an irregular network lining the duct, which is then said to be *reticulated*. The continuance of the deposit, however, gradually contracts the meshes,

¹ So long, however, as they retain their original cellular character, and do not coalesce with each other, these fusiform spiral cells cannot be regarded as having any more claim to the designation of *vessels*, than have the elongated cells of the woody tissue.

leaving the walls of the duct marked only by pores like those of porous cells; and such canals, designated as *pitted* ducts, are especially met with in parts of most solid structure and least rapid growth (fig. 537, 3). The *scalariform* ducts of ferns may be regarded as a modification of the spiral; but spiral ducts are frequently to be met with also in the rapidly growing leaf-stalks of flowering plants, such as the rhubarb. Not unfrequently, however, we find all forms of ducts in the same bundle, as seen in fig. 537. The size of these ducts is occasionally so great as to enable their openings to be distinguished by the unaided eye; they are usually largest in stems whose size is small in proportion to the surface of leaves which they support, such as the common cane or the vine; and, generally speaking, they are larger in woods of dense texture, such as oak and mahogany, than in those of which the fibres, remaining unconsolidated, can serve for the conveyance of fluid. They are entirely absent in the *Conifera*.

The vegetable tissues whose principal forms have been now described, but among which an immense variety of detail is found, may be either studied as they present themselves in thin sections of the various parts of the plant under examination, or in the isolated conditions in which they are obtained by dissection. The former process is the most easy, and yields a large amount of information; but still it cannot

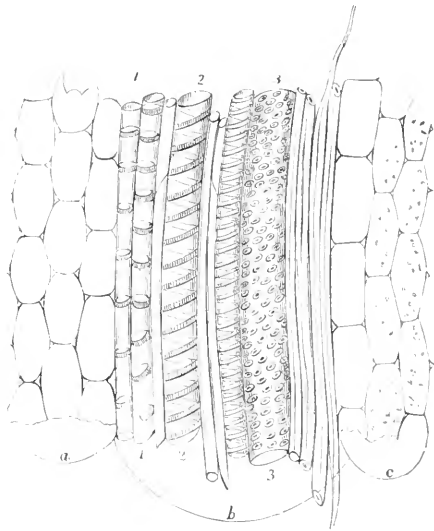

FIG. 537.—Longitudinal section of stem of Italian reed: *a*, cells of the pith; *b*, fibro-vascular bundle, containing 1, annular ducts; 2, spiral ducts; 3, pitted ducts with woody fibre; *c*, cells of the epiderm.

be considered that the characters of any tissue have been properly determined until it has been dissected out. Sections of some of the hardest vegetable substances, such as 'vegetable ivory,' the 'stones' of fruit, the 'shell' of the cocoa-nut, &c., can scarcely be obtained except by slicing and grinding; and these may be mounted either in Canada balsam or in glycerin jelly. In cases, however, in which the tissues are of only moderate firmness, the section may be most readily and effectually made with the 'microtome;' and there are few parts of the vegetable fabric which may not be advantageously examined by this means, any very soft or thin portions being placed in it between two pieces of cork, elder-pith, or carrot. In certain cases, however, in which even this compression would be injurious, the

sections must be made with a sharp knife, the substance being laid on the nail or on a slip of glass. In dissecting the vegetable tissues, scarcely any other instrument will be found really necessary than a pair of needles (in handles), one of them ground to a cutting edge. The adhesion between the component cells, fibres, &c., is often sufficiently weakened by a few hours' maceration to allow of their readily coming apart, when they are torn asunder by the needle-points beneath the simple lens of a dissecting microscope. But if this should not prove to be the case, it is desirable to employ some other method for the sake of facilitating their isolation. None is so effectual as the boiling of a thin slice of the substance under examination either in dilute nitric acid or in a mixture of nitric acid and chlorate of potassa. This last method (which was devised by Schultz) is the most rapid and effectual, requiring only a few minutes for its performance; but as oxygen is liberated with such freedom as to give an almost explosive character to the mixture, it should be put in practice with extreme caution. After being thus treated, the tissue should be boiled in alcohol, and then in water; and it will then be found very easy to tear apart the individual cells, ducts, &c. of which it may be composed. These may be preserved by mounting in weak spirit.

Stem and Root.—It is in the stems and roots that we find the greatest variety of tissues in combination, and the most regular plans of structure; and sections of these viewed under a low magnifying power are objects of peculiar beauty, independently of the scientific information which they afford. The axis (under which term are included the stem with its branches, and the root with its ramifications) always has for the basis of its structure a dense cellular parenchyme; though in an advanced stage of development this may constitute but a small portion of it. In the midst of the parenchyme we generally find fibro-vascular bundles, consisting of woody fibre, with ducts of various kinds, and (almost always) spiral vessels. It is in the mode of arrangement of these bundles that the fundamental difference exists between the stems which are commonly designated as *endogenous* (growing from within), and those which are more correctly termed *exogenous* (growing on the outside); for in the former the bundles are dispersed throughout the whole diameter of the axis without any peculiar plan, the intervals between them being filled up by cellular parenchyme; whilst in the latter they are arranged side by side in such a manner as to form a cylinder of *wood*, which includes within it the portion of the cellular substance known as *pith*, whilst it is itself enclosed in an envelope of the same substance that forms the *bark*. These two plans of axis-formation respectively characteristic of those two great groups into which Phanerogams are subdivided—namely, the *Monocotyledons* and the *Dicotyledons*—will now be more particularly described.

When a transverse section (fig. 538) of a *monocotyledonous* stem is examined microscopically, it is found to exhibit a number of fibro-vascular bundles, disposed without any regularity in the midst of the mass of cellular tissue, which forms (as it were) the matrix or basis of the fabric. Each bundle contains two, three, or more large

ducts, which are at once distinguished by the size of their openings; and these are surrounded by woody fibre and spiral vessels, the transverse diameter of which is so extremely small that the portion of the bundles which they form is at once distinguished in transverse

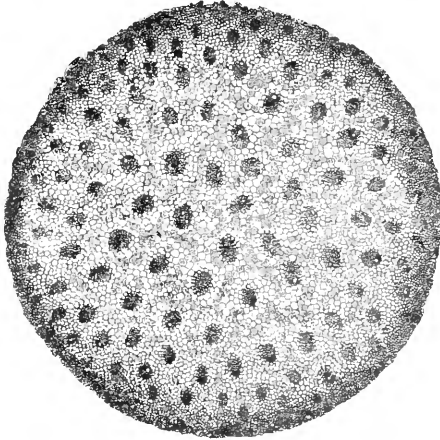

FIG. 538. — Transverse section of stem of young palm.

section by the closeness of its texture (fig. 539). The bundles are least numerous in the centre of the stem, and become gradually more crowded towards its circumference; but it frequently happens that the portion of the area in which they are most compactly arranged is not absolutely at its exterior, this portion being itself surrounded by an investment composed of cellular tissue only; and sometimes we find the central portion also completely destitute of fibro-vascular bundles; so that a sort of indication of the distinction between pith, wood, and bark is here presented. This distinction, however, is very imperfect; for we do not find either the central or the peripheral portions ever separable, like pith and bark, from the intermediate woody layer. In its young state the centre of the stem is always filled up with cells; but these not unfrequently disappear after a time, except at the *nodes*, leaving the stem hollow, as we see in the whole tribe of grasses. When a vertical section is made of a woody stem (as that of a palm) of sufficient length to trace the whole extent of the fibro-vascular bundles, it is found that, whilst they pass at their upper extremity into the leaves, they pass at the lower end

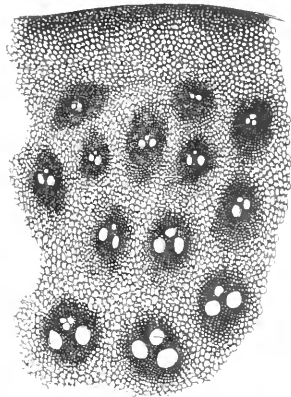

FIG. 539. — Portion of transverse section of stem of Wanghie cane.

towards the surface of the stem, and assist, by their interlacement with the outer bundles, in forming that extremely tough investment which the lower ends of these stems present. New fibro-vascular bundles are being continually formed in the upper part of the stem, in continuity with the leaves which are successively put forth at its summit; but while these take part in the elongation of the stem,

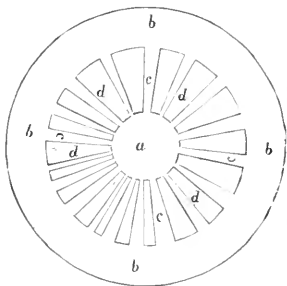

FIG. 540.—Diagram of the first formation of an exogenous stem: *a*, pith; *b, b*, bark; *c, c*, plates of cellular tissue (medullary rays) left between the woody bundles *d d*.

they contribute but little to the increase of its diameter. For those which are most recently formed only pass into the centre of the stem during the higher part of their course, and usually make their way again to its exterior at no great distance below; and, when once formed, they receive no further additions. It was from the idea formerly entertained that these successively formed bundles descend in the interior of the stem through its entire length until they reach the roots, and that the stem is thus continually receiving additions to its interior, that the term *endogenous* was given to this type of stem-structure; but, from the fact just stated regarding the course of the fibro-vascular bundles,

it is obvious that such a doctrine cannot be any longer admitted.

In the stems of dicotyledonous phanerogams, on the other hand, we find a method of arrangement of the several parts which must be regarded as the highest form of the development of the axis, being that in which the greatest differentiation exists. A distinct division is always seen in a transverse section (fig. 541) between three concentric areas—the *pith*, the *wood*, and the *bark*—the first (*a*) being

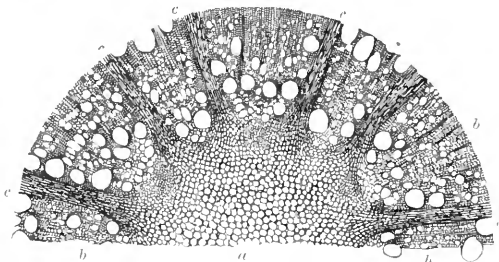

FIG. 541.—Transverse section of stem of *Clematis*: *a*, pith; *b, b, b*, woody bundles *c, c, c*, medullary rays.

central, the last (*b*) peripheral, and these having the wood interposed between them, its circle being made up of wedge-shaped bundles (*d d*), kept apart by the *medullary rays* composed of unchanged cellular tissue (*c, c*) that pass between the pith and the bark. The pith (fig. 541, *a*) is almost invariably composed of cellular tissue only, which usually presents (in transverse section) an hexagonal areolation. When newly formed it has a greenish hue, and its cells are filled with

fluid; but it gradually dries up and loses its colour; and not unfrequently its component cells are torn apart by the rapid growth of their envelope, so that irregular cavities are found in it; or if the stem should increase with extreme rapidity it becomes hollow, the pith being reduced to fragments, which are found adhering to its interior wall. The pith is immediately surrounded by a delicate membrane, consisting almost entirely of spiral vessels, which is termed the *medullary sheath*.

The *woody* portion of the stem (fig. 541, *b, b*) is made up of woody fibres, usually with the addition of ducts of various kinds; these, however, are absent in one large group, the *Conifera* or fir-tribe with its allies (figs. 545-548), in which the prosenchymatous cells or *tracheids* are of unusually large diameter, and are marked by the bordered pits already described. In any stem or branch of more than one year's growth the woody structure presents a more or less distinct appearance of division into concentric rings, the number of



FIG. 542.—Transverse section of stem of *Rhamnus* (buckthorn), showing concentric layers of wood.

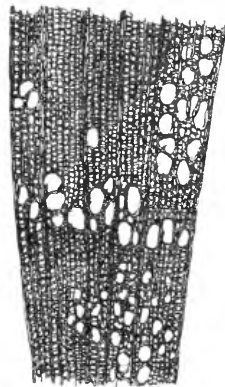

FIG. 543.—Portion of the same more highly magnified.

which varies with the age of the tree (fig. 542). The composition of the several rings, which are the sections of so many cylindrical layers, is uniformly the same, however different their thickness; but the arrangement of the two principal elements—namely, the cellular and the vascular tissue—varies in different species, the vessels being sometimes almost uniformly diffused through the whole layer, but in other instances being confined to its inner part; while in other cases, again, they are dispersed with a certain regular irregularity (if such an expression may be allowed), so as to give a curiously figured appearance to the transverse section (figs. 542, 543). The general fact, however, is that the vessels predominate towards the inner side of the ring (which is the part of it first formed), and that the outer portion of each layer is almost exclusively composed of cellular tissue. Such an arrangement is shown in fig. 541. This alternation of vascular and cellular tissue frequently serves to mark the succession of layers when, as is not uncommon, there is no very distinct line of separation between them.

The number of layers is usually considered to correspond with that of the years during which the stem or branch has been growing; and this is, no doubt, generally true in regard to the trees of temperate climates, which thus ordinarily increase by 'annual layers.' There can be no doubt, however, that such is not the universal rule; and that we should be more correct in stating that each layer indicates an 'epoch of vegetation,' which, in temperate climates, is usually (but not invariably) a year; but which is commonly much less in the case of trees flourishing in tropical regions. Thus among the latter it is very common to find the leaves regularly shed and replaced twice or even thrice in a year, or five times in two years; and for every crop of leaves there will be a corresponding layer of wood. It sometimes happens, even in temperate climates, that trees shed their leaves prematurely in consequence of continued drought, and that, if rain then follow, a fresh crop of leaves appears in the same season; and it cannot be doubted that in such a year there would be two rings of wood produced, which would probably not together exceed the ordinary single layer in thickness. That such a division may even occur as a consequence of an interruption to the processes of vegetation produced by seasonal changes—as by heat and drought

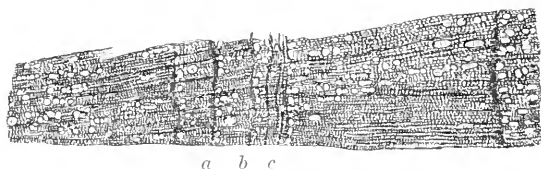

FIG. 544. — Portion of transverse section of stem of hazel, showing, in the portion *a, b, c*, six narrow layers of wood

in a tree that flourishes best in a cold, damp atmosphere, or by a fall of temperature in a tree that requires heat—would appear from the frequency with which a double or even a multiple succession of rings is found in transverse sections of wood to occupy the place of a single one. Thus in a section of hazel stem (in the Author's possession), of which a portion is represented in fig. 544, between two layers of the ordinary thickness there intervenes a band whose breadth is altogether less than that of either of them, and which is yet composed of no fewer than six layers, four of them (*c*) being very narrow, and each of the other two (*a, b*) being about as wide as these four together. The inner rings of wood, being not only the oldest, but the most solidified by resinous matters deposited within their component cells and vessels, are spoken of collectively under the designation *duramen* or 'heart-wood.' On the other hand, it is through the cells and ducts of the outer and newer layers that the sap rises from the roots towards the leaves; and these are consequently designated as *alburnum* or 'sap-wood.' The line of demarcation between the two is sometimes very distinct, as in lignum vitae and cocos-wood; and as a new ring is added every year to the exterior of the alburnum, an additional ring of the innermost part of the alburnum is every year consolidated by internal deposit, and is

thus added to the exterior of the duramen. More generally, however, this consolidation is gradually effected, and the albumnum and duramen are not separated by any abrupt line of division.

The *medullary rays* which cross the successive rings of wood connecting the cellular substance of the pith with that of the bark, and dividing each ring of wood into wedge-shaped segments, are thin

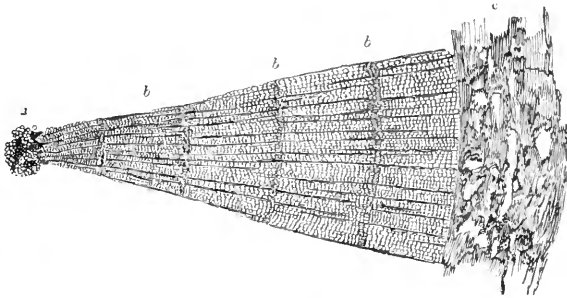

FIG. 545.—Portion of transverse section of the stem of cedar: *a*, pith; *b, b, b*, woody layers; *c*, bark.

plates of cellular tissue (fig. 541, *c, c*), not usually extending to any great depth in the vertical direction. It is not often, however, that their character can be so clearly seen in a transverse section as in the diagram just referred to; for they are usually compressed so closely as to appear darker than the wedges of woody tissue between which they intervene (figs. 543, 545), and their real nature is best understood by a comparison of *longitudinal* sections made in two

different directions—namely, *radial* and *tangential*—with the transverse. Three such sections of a fossil coniferous wood in the Author's possession are shown in figs. 546–548. The stem was of such large size that, in so small a part of the area of its transverse section as is represented in fig 546, the medullary rays seem to run parallel to each other, instead of radiating from a common centre. They are very narrow; but are so closely set together that only two or three rows of tracheids (no ducts being here present) intervene between any pair of them.

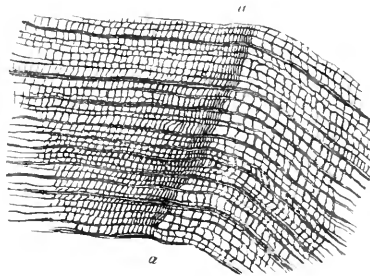

FIG. 546.—Portion of transverse section of large stem of coniferous wood (fossil), showing part of two annual rings, divided at *a, a*, and traversed by very thin but numerous medullary rays.

In the longitudinal section taken in a radial direction (fig. 547), and consequently passing in the same course with the medullary rays, these are seen as thin plates (*a, a, a*) made up of superposed cells very much elongated, and crossing in a horizontal direction the tracheids which lie parallel to one another vertically. And in the tangential section (fig. 548),

which is taken in a direction at right angles to that of the medullary rays, and therefore cuts them across, we see that each of the

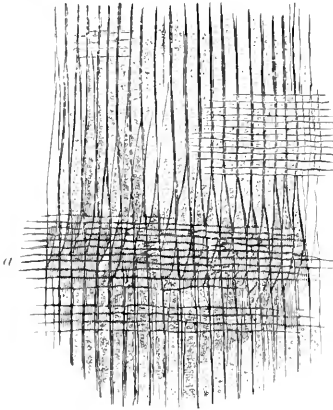

FIG. 547. Portion of vertical section of the same wood, taken in a radial direction, showing the tracheids with 'bordered pits,' without ducts, crossed by the medullary rays, *a, a*.

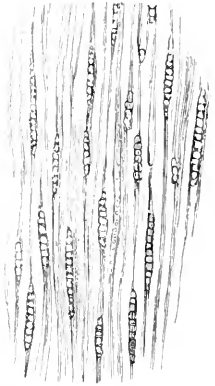

FIG. 548.—Portion of vertical section of the same wood, taken in a tangential direction, so as to cut across the medullary rays.

plates thus formed has a very limited depth from above downwards, and is composed of no more than one thickness of cells in the horizontal direction. A section of the stem of mahogany taken in the same direction as the last (fig. 549) gives a very good view of the cut ends of the medullary rays as they pass between the prosenchymatous cells; and they are seen to be here of somewhat greater thickness, being composed of two or three rows of cells, arranged side by side.

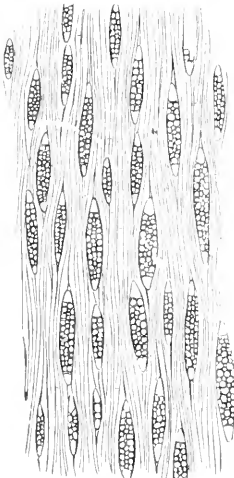

FIG. 549. Vertical section of mahogany.

In another fossil wood, whose transverse section is shown in fig. 550, and its tangential section in fig. 551, the medullary rays are seen to occupy a much larger part of the substance of the stem, being shown in the transverse section as broad bands (*a a, a a*) intervening between the closely set prosenchymatous cells, among which some large ducts are scattered; whilst in the tangential section they are observed to be not only deeper than the preceding from above downwards, but also to have a much greater thickness. This section also gives an excellent view of the ducts, *b b, b b*, which are here plainly seen to be formed by the coalescence of large cylindrical cells lying end to end. In another fossil wood in the Author's possession the medullary rays

constitute a still larger proportion of the stem; for in the transverse section (fig. 552) they are seen as very broad bands (*b, b*), alternating

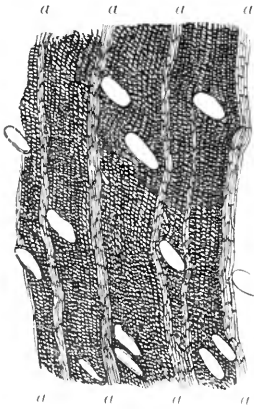

FIG. 550.—Transverse section of a fossil wood, showing the medullary rays, *a, a, a, a, a, a*, running nearly parallel to each other, and the openings of large ducts in the midst of the prosenchymatous tissue.

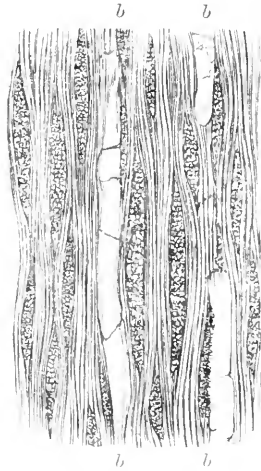
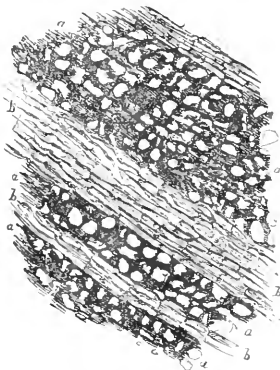

FIG. 551.—Vertical (tangential) section of the same wood, showing the prosenchymatous cells separated by the medullary rays, and by the large ducts, *b, b, b, b*.

with plates of woody structure (*a a*), whose thickness is often less than their own; whilst in the tangential section (fig. 553) the cut



FIGS. 552 and 553.—Transverse and vertical sections of a fossil wood, showing the separation of the woody plates, *a a, a a*, by the very large medullary rays, *b b, b b*.

extremities of the medullary rays occupy a very large part of the area, having apparently determined the sinuous course of the prosenchymatous cells, instead of looking (as in fig. 548) as if they

had forced their way between these cells, which there hold a nearly straight and parallel course on either side of them. The medullary rays maintain a connection between the external and the internal parts of the cellular tissue or *fundamental parenchyme* (also called 'ground-tissue') of the stem, which have been separated by the interposition of the wood.

The *bark* is usually found to consist of three principal layers: the external or *epiphleum*, which includes the *suberous* (or corky) layer; the middle, or *mesophleum*, also termed the 'cellular envelope'; and the internal, or *endophleum*, which is more commonly known as the *liber*.¹ The two outer layers are entirely cellular, and are chiefly distinguished by the form, size, and direction of their cells. The *epiphleum* is generally composed of one or more layers of colourless or brownish cells, which usually present a cubical or tabular form, and are arranged with their long diameters in the horizontal direction; it is this which, when developed to an unusual thickness, forms *cork*, a substance which is by no means the product of one kind of tree exclusively, but exists in greater or less abundance in the bark of every exogenous stem. The *mesophleum* consists of cells, usually containing more or less chlorophyll, prismatic in their form, and disposed with their long diameters parallel to the axis: it is more loosely arranged than the preceding, and contains intercellular passages, which often form a network of canals which have the character of laticiferous vessels; and, although usually less developed than the suberous layers, it sometimes constitutes the chief thickness of the bark. The *liber* or 'inner bark,' on the other hand, usually contains woody fibre in addition to the cellular tissue and laticiferous canals of the preceding; and thus approaches more nearly in its character to the woody layers, with which it is in close proximity on its inner surface. The *liber* may generally be found to be made up of a succession of thin layers, equalling in number those of the wood, the innermost being the last formed: but no such succession can be distinctly traced either in the cellular envelope or in the suberous layer, although it is certain that they, too, augment in thickness by additions to their interior, whilst their external portions are frequently thrown off in the form of thickish plates, or detach themselves in smaller and thinner laminae. The bark is always separated from the wood by the *cambium layer*, which is the part wherein all new growth takes place. This layer seems to consist of mucilaginous semi-fluid matter; but it is really made up of cells of a very delicate texture, which gradually undergo transformation, whereby they are for the most part converted into tracheïds, ducts, spiral vessels, &c. These materials are so arranged as to augment the fibro-vascular bundles of the wood on their external surface, thus forming a new layer of albumen, which encloses all those that preceded it; whilst they also form a new layer of liber on the interior of all those which preceded it. They also extend the medullary rays, which still maintain a continuous connection between the pith and the bark; and a portion remains unconverted, so as

¹ [The term 'liber' is also sometimes applied to the 'phloëm-portion' of a fibro-vascular bundle.—Ed.]

always to keep apart the liber and the albumen. This type of stem-structure is termed *exogenous*; a designation which applies very correctly to the mode of increase of the woody layers, although (as just shown) the liber is formed upon a truly endogenous plan.

Numerous departures from the normal type are found in particular tribes of dicotyledons. Thus in some the wood is not marked by concentric circles, their growth not being interrupted by any seasonal change. In other cases, again, each woody zone is separated from the next by the interposition of a thick layer of cellular substance. Sometimes wood is formed in the bark (as in *Calycanthus*), so that several woody columns are produced, which are quite independent of the principal woody axis, and cluster around it. Occasionally the woody stem is divided into distinct segments by the peculiar thickness of certain of the medullary rays, and in the stem, of which fig. 554 represents a transverse section, these cellular plates form

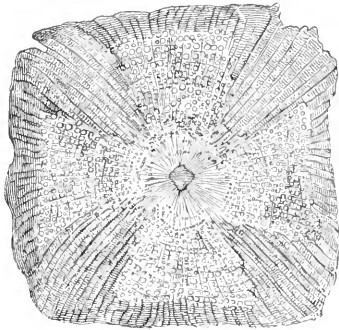

FIG. 554.—Transverse section of the stem of a climbing plant (*Aristolochia*?) from New Zealand.

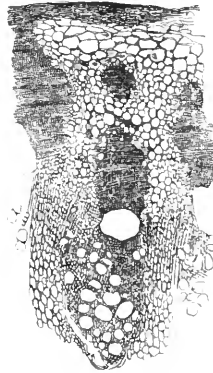

FIG. 555.—Portion of transverse section of *Arctium* (burdock), showing one of the fibro-vascular bundles that lie beneath the cellular epiderm.

four large segments disposed in the manner of a Maltese cross, and alternating with the four woody segments, which they equal in size.

The exogenous stem, like the (so-called) endogenous, consists, in its first-developed state, of cellular tissue only; but after the leaves have been actively performing their function for a short time, we find a circle of fibro-vascular bundles, as represented in fig. 540, interposed between the central (or *medullary*) and the peripheral (or *cortical*) portions of the fundamental tissue, these fibro-vascular bundles being themselves separated from each other by plates of cellular tissue, which still remain to connect the central and the peripheral portions of that tissue. This first stage in the formation of the exogenous axis, in which its principal parts—the pith, wood, bark, and medullary rays—are marked out, is seen even in the stems of herbaceous plants, which are destined to die down at the end of the season (fig. 555); and sections of these, which are very

easily prepared, are most interesting microscopic objects. In such stems the difference between the endogenous and the exogenous types is manifested in little else than the disposition of the fibro-vascular layers which are scattered through nearly the whole of the fundamental tissue (although more abundant towards its exterior) in the former case, but are limited to a circle within the peripheral portion of the cellular tissue in the latter. It is in the further development which takes place during succeeding years in the woody stems of perennial exogens that those characters are displayed which separate them most completely from the ferns and their allies, whose stems contain a cylindrical layer of fibro-vascular bundles, as well as from (so-called) endogens. For whilst the fibro-vascular layers of the latter, when once formed, undergo no further increase, those of exogenous stems are progressively augmented on their outer side by the metamorphosis of the cambium layer; so that each of the bundles which once lay as a mere series of parallel cords beneath the cellular-epiderm of a first-year's stem, may become in time the small end of a wedge-shaped mass of wood extending continuously from the centre to the exterior of a trunk of several feet in diameter, and becoming progressively thicker as it passes upwards. The fibro-vascular bundles of exogens are therefore spoken of as 'indefinite' or *open*, whilst those of endogens and vascular cryptogams (ferns, &c.) are said to be 'definite' or *closed*. The open fibro-vascular bundles of exogens and of gymnosperms may be stated to consist of three distinct parts: the *ylem* portion, which consists chiefly of ducts, of the nature of spiral, annular, or pitted vessels, and which is the portion of the bundle nearest to the centre of the organ; the *phloëm* or 'bast' portion, which consists largely of prosenchymatous cells, among which are almost always *sieve-tubes* with their *sieve plates*, and which is the peripheral portion of the bundle; while between them is the formative *cambium*, from which fresh xylem is constantly being formed on one side, fresh phloëm on the other side. The closed bundles of endogens and of vascular cryptogams consist of xylem and phloëm only. When the xylem and phloëm portions of fibro-vascular bundle lie side by side, as is usually the case, the bundle is said to be *collateral*; when either portion encloses the other like a cylinder, it is *concentric*.

The structure of the *roots* of endogens and exogens is essentially the same in plan as that of their respective stems. Generally speaking, however, the roots of exogens have no pith, although they have medullary rays; and the succession of distinct rings is less apparent in them than it is in the stems from which they diverge. In the delicate branches which proceed from the larger root-fibres a central bundle of vessels will be seen enveloped in a sheath of cellular substance; and this investment also covers in the end of the branch, which is usually somewhat dilated, and is furnished at its extremity with one or more layers of cells, which are constantly being thrown off, known as the *pileorhiza* or *root-cap*. The structure of the branches of the root may be well studied in the common buckweed, every floating leaf of which has a single root hanging down

from its lower surface. The central fibro-vascular cylinder, which is characteristic of the finer roots of exogens, as well as of endogens, is surrounded by a single layer of cells very clearly differentiated from the surrounding fundamental tissue, known as the *bundle-sheath*. We have already seen the peculiar form assumed by the bundle-sheath in the stem of ferns and other vascular cryptogams.

The structure of stems and roots cannot be thoroughly examined in any other way than by making sections in different directions with the microtome. The general instructions already given leave little to be added respecting this special class of objects, the chief points to be attended to being the preparation of the stems, &c. for slicing, the sharpness of the knife, and the dexterity with which it is handled, and the method of mounting the sections when made. The wood, if green, should first be soaked in strong alcohol for a few days, to get rid of the resinous matter; and it should then be macerated in water for some days longer for the removal of its gum, before being submitted to the cutting process. If the wood be dry, it should first be softened by soaking for a sufficient length of time in water, and then treated with spirit, and afterwards with water, like green wood. Some woods are so little affected even by prolonged maceration that boiling in water is necessary to bring them to the degree of softness requisite for making sections. No wood that has once been dry, however, yields such good sections as that which is cut fresh. When a piece of appropriate length has been placed in the grasp of the section instrument (wedges of deal or other soft wood being forced in with it, if necessary for its firm fixation), a few thick slices should first be taken, to reduce its surface to an exact level; the surface should then be wetted with spirit, the micrometer-screw moved through a small part of a revolution, and the slice taken off with the razor, the motion given to which should partake both of *drawing* and *pushing*. A little practice will soon enable the operator to discover in each case *how thin* he may venture to cut his sections without a breach of continuity, and the micrometer-screw should be turned so as to give the required elevation. If the surface of the wood has been sufficiently wetted, the section will not curl up in cutting, but will adhere to the surface of the razor, from which it is best detached by dipping the razor in water so as to float away the slice of wood, a camel-hair pencil being used to push it off if necessary. All the sections that may be found sufficiently thin and perfect should be put aside in a bottle of weak spirit until they be mounted. For the minute examination of their structure, they may be mounted either in weak spirit or in glycerin-jelly. Where a mere general view only is needed, dry mounting answers the purpose sufficiently well; and there are many stems, such as that of *Clematis*, of which transverse sections rather thicker than ordinary make very beautiful *opaque* objects when mounted dry on a black ground. Canada balsam should not be had recourse to, except in the case of very opaque sections, as it usually makes the structure too transparent. Transverse sections, however, when slightly charred by heating between two plates of glass until they turn brown, may be mounted with advantage in

Canada balsam, and are then very showy specimens for the gas-microscope. The number of beautiful and interesting objects which may be thus obtained from even the commonest trees, shrubs, and herbaceous plants at the cost of a very small amount of trouble can scarcely be conceived save by those who have specially attended to these wonderful structures; and a careful study of sections made in different parts of the stem, especially in the neighbourhood of the 'growing point,' will reveal to the eye of the physiologist some of the most important phenomena of vegetation. The judicious use of the *staining process* not only improves the appearance of such sections, but adds greatly to their scientific value. *Fossil woods*, when well preserved, are generally *silicified*, and can only be cut and polished by a lapidary's wheel. Should the microscopist be fortunate enough to meet with a portion of a *calcified* stem in which the organic structure is preserved, he should proceed with it

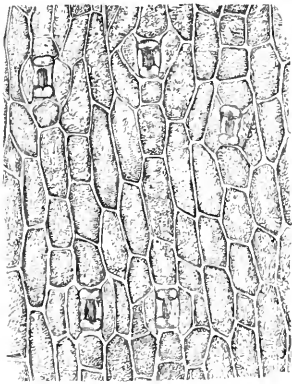

FIG. 556.—Epiderm of leaf of *Yucca*, showing stomates.

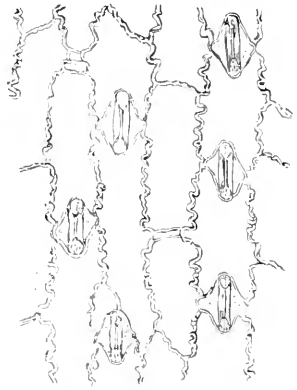

FIG. 557.—Epiderm of leaf of Indian corn (*Zea Mays*), showing stomates.

after the manner of other hard substances which need to be reduced by grinding.

Epiderm of Leaves.—On all the softer parts of the higher plants, save such as grow under water, we find a surface layer differing in its texture from the parenchyme beneath, and constituting a distinct membrane, known as the *epiderm*. This membrane is composed of cells, the walls of which are flattened above and below, whilst they adhere closely to each other laterally, so as to form a continuous stratum (figs. 560, 562, *a, a*). The shape of these cells is different in almost every tribe of plants; thus in the epiderm of the *Yucca* (fig. 556), Indian corn (fig. 557), *Iris* (fig. 561), and most other monocotyledons, they are elongated, and present an approach to a rectangular contour, their margins being straight in the *Yucca* and *Iris*, but minutely sinuous or crenated in the Indian corn. In most dicotyledons, on the other hand, the cells of the epiderm depart less from the rounded form, but their margins usually exhibit large irregular sinuosities, so that they seem to fit together

like the pieces of a dissected map, as is seen in the epiderm of the apple (fig. 558, *b, b*). Even here, however, the cells of that portion of the epiderm (*a, a*) which overlies the 'veins' of the leaf have an elongated form, approaching that of the wood-cells of which these veins are chiefly composed; and it seems likely, therefore, that the elongation of the ordinary epiderm cells of monocotyledons has reference to

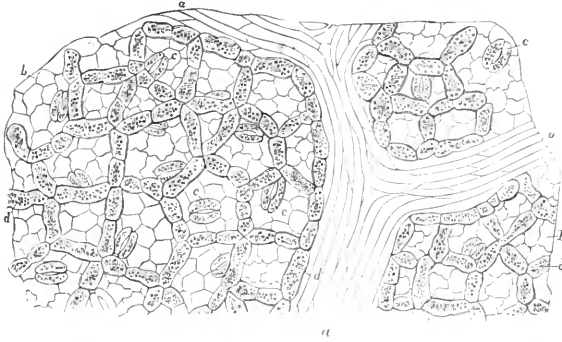

FIG. 558.—Portion of epiderm of lower surface of leaf of apple, with layer of parenchyma in immediate contact with it: *a, a*, elongated cells overlies the veins of the leaf; *b, b*, ordinary epiderm-cells, overlies the parenchyma; *c, c*, stomates; *d, d*, green cells of the spongy parenchyma, forming a very open network near the lower surface of the leaf.

that parallel arrangement of the veins which their leaves almost constantly exhibit.

The cells of the epiderm are colourless, or nearly so, having no or but little chlorophyll in their interior; and their walls are generally

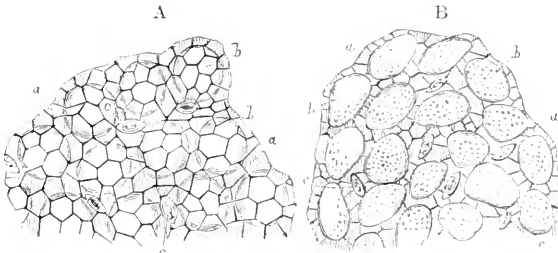

FIG. 559.—Portion of epiderm of upper surface of leaf of *Rochea falcata*, as seen at A from its inner side, and at B from its outer side: *a, a*, small cells forming inner layer; *b, b*, large prominent cells of outer layer; *c, c*, stomates disposed between the latter.

thickened by secondary deposit, especially on the side nearest the atmosphere. This outermost hardened continuous wall of the epidermal layer of cells is known as the *cuticle*. The deposit (*cutin*) is of a nature to render the membrane very impermeable to fluids, so as to protect the soft tissue of the leaf from drying up. In most

European plants the epiderm consists of but a single row of cells, which, moreover, are usually thin-walled; whilst in the generality of tropical species there exist two, three, or even four layers of thick-walled cells, this last number being seen in the oleander, the epiderm of which, when separated, has an almost leathery firmness. This difference in conformation is obviously adapted to the conditions of growth under which these plants respectively exist; since the epiderm of a plant indigenous to temperate climates would not afford a sufficient protection to the interior structure against the rays of a tropical sun; whilst the less powerful heat of this country would scarcely overcome the resistance presented by the dense and non-conducting integument of a species formed to exist in tropical climates.

A very curious modification of the epiderm is presented by *Roechea falcata*, which has the surface of its ordinary epiderm (figs. 559, 560, *a, a*) nearly covered with a layer of large prominent isolated cells, *b, b*. A somewhat similar structure is found in *Mesembryanthemum crystallinum*, commonly known as the 'ice-plant,' a designation it owes to the peculiar appearance of its surface, which looks as if it were covered with frozen dewdrops. In other instances the epiderm is partially invested by a layer of *scales*, which are nothing else than flattened hairs, often having a very peculiar form; the 'peltate scales' of *Elaeagnus* and other shrubs and herbs are very beautiful objects under the microscope. In

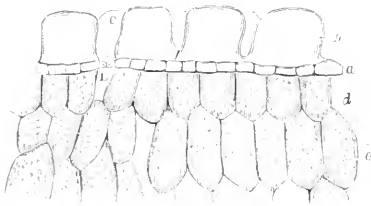

FIG. 560. — Portion of vertical section of leaf of *Roechea*, showing the small cells, *a, a*, of the inner layer of epiderm; the large cells, *b, b*, of the outer layer; *c*, one of the stomates; *d, d*, cells of the parenchyma; *l*, cavity between the parenchymatous cells into which the stomate opens.

numerous other cases, again, we find the surface beset with true *hairs*, which occasionally consist of single elongated cells, but are more commonly made up of a linear series, attached end to end. Sometimes these hairs bear little glandular bodies at their extremities, by the secretion of which a peculiar viscosity is given to the surface of the leaf, stem, or flower-stalk, as in many kinds of rose, geranium, &c. In other instances, the

hair has a glandular body at its base, containing a peculiar secretion; when this secretion is of an irritating quality, as in the nettle, it constitutes a 'sting.' A great variety of such organs may be found by a microscopic examination of the surface of the leaves of plants having any kind of superficial investment to the epiderm. Many connecting links present themselves between hairs and scales, such as the stellate hairs of *Deutzia scabra*, which a good deal resemble those within the air chambers of the yellow water-lily (fig. 527). The so-called 'glands' or 'tentacles' of the sundew (*Drosera*) are not really hairs, but outgrowths of the internal tissue of the leaf, each being penetrated by a fibro-vascular bundle.

The epiderm in many plants, especially those belonging to the grass tribe, has its cell-walls impregnated with *silex*, like that of *Equisetum*; so that, when the organic matter seems to have been got rid of by heat or by acids, the forms of the epidermal cells, hairs, stomates, &c., are still marked out in *silex*, and (unless the dissipation of the organic matter has been most perfectly accomplished) are most beautifully displayed by polarised light. Such silicified epiderms are found in the husks of the grains yielded by these plants; and there is none in which a larger proportion of mineral matter exists than that of rice, which contains some curious elongated cells with toothed margins. The hairs with which the *palae* (chaff-scales) of most grasses are furnished are strengthened by the like siliceous deposit; and in *Festuca pratensis*, one of the common meadow-grasses, the *palae* are also beset with longitudinal rows of little cup-like bodies formed of *silex*. The epiderm and scaly hairs of *Deutzia scabra* also contain a large quantity of *silex*, and are remarkably beautiful objects for the polariscope.

In nearly all plants which possess a distinct epiderm, this is perforated by the minute openings termed *stomates* (figs. 557, 561), which are bordered by cells of a peculiar form, the *guard-cells*, differing from those of the epiderm, and more resembling in character those of the tissue beneath.

They are further distinguished by containing a larger number of chlorophyll-grains than the ordinary cells of the epiderm. These guard-cells are usually somewhat kidney-shaped, and lie in pairs (fig. 561, *b*), with an oval opening between them; but by an alteration in their form, the opening may be contracted or nearly closed. In the epiderm of *Yucca*, however, the opening is bounded by two pairs of cells, and is somewhat quadrangular (fig. 556); and a like doubling of the guard-cells, with a narrower slit between them, is seen in the epiderm of the Indian corn (fig. 557). In the stomates of no phanerogam, however, do we

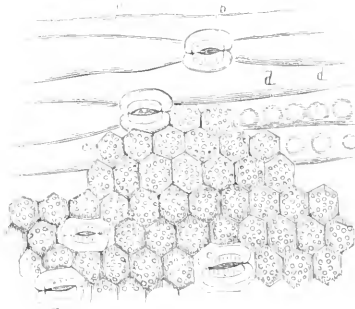

FIG. 561. Portion of epiderm of leaf of *Iris germanica* torn from its surface, and carrying away with it a portion of the parenchymatous layer in immediate contact with it: *a, a*, elongated cells of the epiderm; *b, b*, cells of the stomates; *c, c*, cells of the parenchyme; *d, d*, impressions on the epidermal cells formed by their contact; *e*, cavity in the parenchyme, corresponding to the stomate.

meet with any conformation at all to be compared in complexity with that which has been described in the humble *Marchantia*. Stomates are usually found most abundantly (and sometimes exclusively) in the epiderm of the lower surface of leaves, where they open into the air-chambers that are left in the parenchyme which lies next the inferior epiderm; in leaves which float on the surface of water, however, they are found in the epiderm of the upper surface only; whilst in leaves that habitually live entirely submerged, as

there is no distinct epiderm, so there are no stomates. In the erect leaves of grasses, the *Iris* tribe, &c., they are found equally (or nearly so) on both surfaces. As a general fact, they are least numerous in succulent plants, whose moisture, obtained in a scanty supply, is destined to be retained in the system; whilst they abound most in those which exhale fluid most readily, and therefore absorb it most quickly. It has been estimated that no fewer than 160,000 are contained in every square inch of the under surface of the leaves of *Hydrangea* and of several other plants, the greatest number seeming always to be present where the upper surface of the leaves is entirely destitute of these organs. In *Iris germanica* each surface has nearly 12,000 stomates in every square inch; and in *Yucca* each surface has 40,000. In the oleander, *Banksia*, and some other plants, the stomates do not open directly upon the lower surface of the epiderm, but lie in the deepest part of little pits or depressions, which are excavated in it and lined with hairs; the mouths of these pits, with the hairs that line them, are well brought into view by taking a thin slice from the surface of the epiderm with a sharp knife; but the form of the cavities and the position of the stomates can only be well made out in vertical sections of the leaves.

The internal structure of *Leaves* is best brought into view by making vertical sections, traversing the two layers of epiderm and the intermediate cellular parenchyme; portions of such sections are shown in figs. 560, 562, and 563. In close apposition with the cells

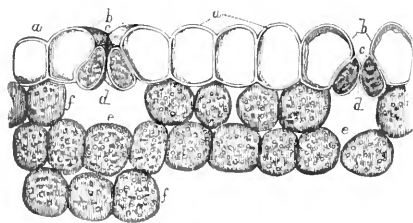

FIG. 562.—Vertical section of epiderm and of portion of subjacent parenchyme of leaf of *Iris germanica* taken in a transverse direction: *a, a*, cells of epiderm; *b, b*, cells at the sides of the stomates; *c, c*, guard-cells; *d, d*, openings of the stomates; *e, e*, cavities in the parenchyme into which the stomates open; *f, f*, cells of the parenchyme.

of the upper epiderm (fig. 562, *a, a*), which may or may not be perforated with the stomates (*c, c, d, d*), we find a layer of soft, thin-walled cells, with their longest diameter at right angles to the surface of the leaf, and containing a large quantity of chlorophyll; these generally press so closely one against another that their sides become mutually flattened, and no spaces are left, save where there is a definite air-chamber into which the stomate opens (fig. 562, *e*); and the compactness of this superficial layer is well seen when, as often happens, it adheres so closely to the epiderm as to be carried away with this when it is torn off (fig. 561, *c, c*). This layer, usually peculiar to the upper surface of leaves, is known as the *palisade-parenchyme*. Beneath this first layer of leaf-cells there are usually several others rather less compactly arranged; and the tissue gradually becomes more and more lax, its cells not being in close apposition, and large inter-cellular passages being left amongst them, until we reach the lower epiderm, which the parenchyme only touches at certain points, its lowest layer forming a sort of network, the so-called *spongy paren-*

chyme. This layer is well seen when, as often happens, it adheres so closely to the epiderm as to be carried away with this when it is torn off (fig. 561, *c, c*). This layer, usually peculiar to the upper surface of leaves, is known as the *palisade-parenchyme*. Beneath this first layer of leaf-cells there are usually several others rather less compactly arranged; and the tissue gradually becomes more and more lax, its cells not being in close apposition, and large inter-cellular passages being left amongst them, until we reach the lower epiderm, which the parenchyme only touches at certain points, its lowest layer forming a sort of network, the so-called *spongy paren-*

chyme (fig. 558, *d. d.*), with large interspaces, into which the stomates open. It is to this arrangement that the darker shade of green almost invariably presented by the upper surface of leaves is principally due, the colour of the component cells of the parenchyme not being deeper in one part of the leaf than in another. In those plants, however, whose leaves are erect instead of being horizontal, so that their two surfaces are equally exposed to light, the parenchyme is arranged on both sides in the same manner, and their epiderms are furnished with an equal number of stomates. This is the case, for example, with the leaves of the common garden *Iris* (fig. 563), in which, moreover, we find a central portion (*d. d.*) formed by thick-walled colourless tissue, very different either from ordinary leaf-cells or from woody fibre. The explanation of its presence is to be found in the peculiar conformation of the leaves; for if we pull one of them from its origin, we shall find that what appears to be the flat expanded blade really exposes but half its surface, the blade being doubled together longitudinally, so that what may be considered its under surface is entirely concealed.

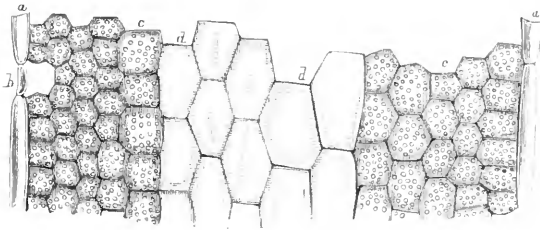

FIG. 563.—Portion of vertical longitudinal section of leaf of *Iris*, extending from one of its flattened sides to the other: *a, a*, elongated cells of epiderm; *b, b*, stomata cut through longitudinally; *c, c*, green cells of parenchyme; *d, d*, colourless tissue, occupying interior of leaf.

The two halves are adherent together at their upper part; but at their lower they are commonly separated by a new leaf which comes up between them; and it is from this arrangement, which resembles the position of the legs of a man on horseback, that the leaves of the *Iris* tribe are said to be *equitant*. Now by tracing the middle layer of colourless cells, *d. d.*, down to that lower portion of the leaf where its two halves diverge from one another, we find that it there becomes continuous with the epiderm, to the cells of which (fig. 563, *a*) these bear a strong resemblance in every respect, save the greater proportion of their breadth to their length. Another interesting variety in leaf-structure is presented by the water-lily and other plants whose leaves float on the surface; for here the usual arrangement is entirely reversed, the closely set layers of green leaf-cells being found in contact with the lower surface, whilst all the upper part of the leaf is occupied by a loose spongy parenchyme, containing a very large number of air-spaces that give buoyancy to the leaf; and these spaces communicate with the external air through the

numerous stomates, which, contrary to the general rule, are here found in the upper epiderm alone.

The examination of the foregoing structures is attended with very little difficulty. Many epiderms may be torn off, by the exercise of a little dexterity, from the surfaces of the leaves they invest without any preparation; this is especially the case with monocotyledons generally, the veins of whose leaves run parallel, and with such dicotyledons as have very little woody structure in their leaves. In those, on the other hand, whose leaves are furnished with reticulated veins to which the epiderm adheres (as is the case in by far the larger proportion), this can only be detached by first macerating the leaf for a few days in water; and if their texture is particularly firm, the addition of a few drops of nitric acid to the water will render their epiderms more easily separable. Epiderms may be advantageously mounted either in weak spirit or in glycerin-jelly. Very good sections of most leaves may be made by a sharp knife, handled by a careful manipulator; but it is generally preferable to use the microtome, placing the leaf between two pieces either of very soft cork or of elder-pith or carrot, or imbedding it in paraffin. In order to study the structure of leaves with the fulness that is needed for scientific research, numerous sections should be made in different directions, and slices taken parallel to the surfaces at different distances from them should also be examined. There is no known medium in which such sections can be preserved altogether without change; but some one of the methods formerly described will generally be found to answer sufficiently well.

Flowers.—Many small flowers, when looked at entire with a low magnifying power, are very striking microscopic objects; and the interest of the young in such observations can scarcely be better

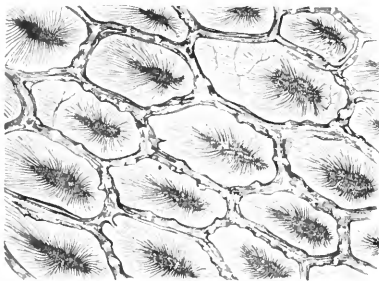

FIG. 564.—Cells from petal of *Pelargonium*.

excited than by directing their attention to the new view they thus acquire of the 'composite' nature of the humble daisy, or to the beauty of the minute blossoms of many of those unbelliferous plants which are commonly regarded only as rank weeds. The scientific microscopist, however, looks more to the organisation of the separate parts of the flower; and among these he finds abundant sources of gratification, not merely to his

love of knowledge, but also to his taste for the beautiful. The general structure of the *sepals* and *petals*, which constitute the *perianth*, or floral envelope, closely corresponds to that of leaves. The petals seldom contain unchanged chlorophyll; but usually either the chlorophyll in the petals (and sometimes also in the sepals) is changed into a solid yellow pigment (*carotin*); or the chlorophyll has entirely disappeared, and is replaced by a pigment, blue, red,

purple, or some other bright colour; *anthocyan*, *erythrophyll*, &c., dissolved in the cell-sap. There are some petals whose cells exhibit very interesting peculiarities, either of form or marking, in addition to their distinctive coloration; such are those of the *Pelargonium*, of which a small portion is represented in fig. 564. The different portions of this petal—when it has been dried after stripping it of its epiderm, immersed for an hour or two in oil of turpentine, and then mounted in Canada balsam—exhibit a most beautiful variety of vivid coloration, which is seen to exist chiefly in the thickened partitions of the cells; whilst the surface of each cell presents a very curious opaque spot with numerous diverging prolongations. This method of preparation, however, does not give a true idea of the structure of the cells; for each of them has a peculiar mammillary protuberance, the base of which is surrounded by hairs; and this it is which gives the velvety appearance to the surface of the petal, and which, when altered by drying and compression, occasions the peculiar spots represented in fig. 564. Their real character may be brought into view by Dr. Inman's method, which consists in drying the petal (when stripped of its epiderm) on a slip of glass, to which it adheres, and then placing on it a little Canada balsam diluted with turpentine, which is to be boiled for an instant over the spirit lamp, after which it is to be covered with a thin glass. The boiling 'blisters' it, but does not remove the colour; and on examination many of the cells will be found showing the mammilla very distinctly, with a score of hairs surrounding its base, each of these slightly curved, and pointing towards the apex of the mammilla. The petal of the common scarlet pimpernel (*Anagallis arvensis*), that of the common chickweed (*Stellaria media*), together with many others of a small and delicate character, are also very beautiful microscopic objects; and the two just named are peculiarly favourable subjects for the examination of the spiral vessels in their natural position. For the 'veins' which traverse these petals are entirely made up of spiral vessels, none of which individually attain any great length, but one follows or takes the place of another, the conical commencement of each somewhat overlapping the like termination of its predecessor; and where the 'veins' seem to branch, this does not happen by the bifurcation of a spiral vessel but by the 'splicing on' (so to speak) of one to the side of another, or of two new vessels diverging from each other to the end of that which formed the principal vein.

The *Anthers* and *Pollen-grains* also present numerous objects of great interest, both to the scientific botanist and to the amateur microscopist. In the first place, they afford a good opportunity of studying that form of 'free-cell-formation' which seems peculiar to the parts concerned in the reproductive process, and which consists in the development of new cell-walls round a number of isolated masses of protoplasm forming parts of the contents of a parent cell, so that the new cells lie free within its cavity, instead of being formed by its subdivision, as in the ordinary method of multiplication. If the anther be examined by thin sections at an early stage of its development within the young flower-bud, it will be found to

be made up of ordinary cellular parenchyme in which no peculiarity anywhere shows itself; but a gradual differentiation speedily takes place, consisting in the development of a set of very large cells in two vertical rows, which occupy the place of the *loculi* or 'pollen-chambers' that afterwards present themselves; and these cells give origin to the pollen-grains, whilst the ordinary parenchyme remains to form the walls of the pollen-chambers. The pollen-grains are formed within 'mother-cells,' the endoplasm of each breaking up into four segments. These become invested by a double envelope, a firm *extine*, and a thin *intine*; and they are set free, when mature, by the bursting of the pollen-chambers. It is not a little curious that the layer of cells which lines the pollen-chambers should exhibit, in a considerable proportion of plants, a strong resemblance in structure, though not in form, to the elaters of *Marchantia* (fig. 506). For they have in their interior a fibrous deposit, which sometimes forms a continuous spiral (like that in fig. 532), as in *Narcissus* and *Hyosegyamus*; but it is often broken up, as it were, into rings, as in the *Iris* and hyacinth; in many instances it forms an irregular network, as in the violet and saxifrage; in other cases again, a set of interrupted arches, the fibres being deficient on one side, as in the yellow water-lily, bryony, primrose, &c.; whilst a very peculiar stellate aspect is often given to these cells by the convergence of the interrupted fibres towards one point of the cell-wall, as in the cactus, geranium, madder, and many other well-known plants. Various intermediate modifications exist; and the particular form presented often varies in different parts of the wall of one and the same anther. It seems probable that, as in Hepaticæ, the elasticity of these spiral cells may have some share in the opening of the pollen-chambers and in the dispersion of the pollen-grains.

The form of the pollen-grains seems to depend in part upon the mode of division of the cavity of the parent cell into quarters; generally speaking, it approaches the spheroidal, but it is very often elliptical, and sometimes tetrahedral. It varies more, however, when the pollen is dry than when it is moist; for the effect of the imbibition of fluid, which usually takes place when the pollen is placed in contact with it, is to soften down angularities, and to bring the cell nearer to the typical sphere. The extine, or outer coat of the pollen-grain, often exhibits very curious markings, which seem due to an increased thickening at some points and a thinning away at others. Sometimes these markings give to the surface layer so close a resemblance to a stratum of cells (fig. 565, B, C, D) that only a very careful examination can detect the difference. The roughening of the surface by spines or knobby protuberances, as shown at A, is a very common feature; and this seems to enable the pollen-grains more readily to hold to the surface whereon they may be cast. Besides these and other inequalities of the surface, most pollen-grains have what appear to be pores or slits in their extine (varying in number in different species), through which the intine protrudes itself as a tube, when the bulk of its contents has been increased by imbibition. It seems probable, however, that the extine is not absolutely deficient at these points, but is only thinned

away. Sometimes the pores are covered by little disc-like pieces or lids, which fall off when the *pollen-tube* is protruded. This action takes place naturally when the pollen-grains fall upon the surface of the stigma, which is moistened with a viscid secretion; and the pollen-tubes, at first mere protrusions of the inner coat of their cell, insinuating themselves between the loosely packed cells of the stigma, grow downwards through the style, sometimes even to the length of several inches, until they reach the ovary. The first change, namely the protrusion of the inner membrane through the pores of the exterior, may be made to take place artificially by moistening the pollen with water, thin syrup, or dilute acids (different kinds of pollen-grains requiring different modes of treatment); but the subsequent extension by growth will only take place under the natural conditions. By treating some pollen-grains, as those of *Lilium japonicum*, *L. rubrum*, or *L. auratum*, with the viscid liquid abundantly secreted by the stigma, not only may the extrusion and lengthening of the pollen-tubes be watched, but the grains with their extruded tubes may be preserved almost unchanged by mounting in this liquid.

The darker kinds of pollen may be generally rendered transparent by mounting in Canada balsam; or, if it be desired to avoid the use of heat, in the benzol solution of Canada balsam, setting aside the slide for a time in a warm place. For the less opaque pollens the dammar solution is preferable. The more delicate pollens, however, become too transparent

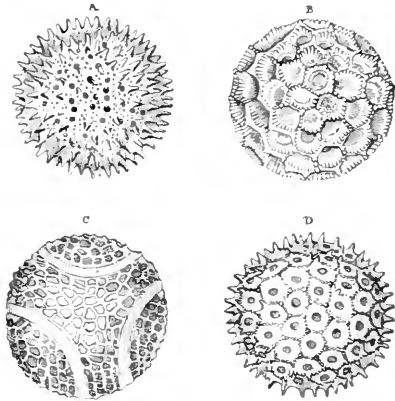

FIG. 565. —Pollen-grains of A, *Althaea rosea* (hollyhock); B, *Cobaea scandens*; C, *Passiflora carulea*; D, *Ipomoea purpurea*.

in either of these media; and it is consequently preferable to mount them either dry, or (if they will bear it without rupturing) in fluid. The most interesting forms are found, for the most part, in plants of the orders *Amaranthaceae*, *Cichoriaceae*, *Cucurbitaceae*, *Malvaceae*, and *Passiflorae*; others are furnished also by *Convolvulus*, *Campanula*, *Oenothera*, *Pelargonium* (geranium), *Polygonum*, *Sedum*, and many other plants. It is frequently preferable to lay down the entire anther, with its adherent pollen-grains (where these are of a kind that hold to it), as an opaque object; this may be done with great advantage in the case of the common mallow (*Malva sylvestris*) or of the hollyhock (*Althaea rosea*), the anthers being picked soon after they have opened, whilst a large proportion of their pollen is yet undischarged, and laid down as flat as possible, before they have begun to wither, between two pieces of smooth blotting-paper, then subjected to moderate pressure, and finally mounted

upon a black surface. They are then, when properly illuminated, most beautiful objects for objectives of $\frac{2}{3}$ -, 1-, $1\frac{1}{2}$ -, or 2-in. focus, especially with the binocular microscope.¹

There are, in fact, few more interesting objects for the young microscopist than pollen-grains, both from the ease with which they can always be procured, and the almost infinite variety and beauty in their forms. Some of the commonest weeds, such as the dandelion and groundsel, are distinguished by the beauty of their pollen-grains. The grains are sometimes nearly or quite spherical, as in the hazel, birch, or poplar; or of very irregular outline, as in many grasses. But the most common form is elliptical, with three or five longitudinal furrows, as in the wallflower, hyacinth, and crocus, the surface being sometimes covered with warts, as in the snowdrop. In the fuchsia they are triangular. In addition to the mallow and hollyhock, spiny pollen-grains occur in the groundsel, dandelion, *Cineraria*, and many other plants. Sometimes the grains are united together by delicate threads, as in the *Rhododendron* and *Fuchsia*; and this union is much more complete in the *Orchideae* and *Asclepiadeae*, where the whole of the pollen in each anther-lobe is glued together by a viscid substance into a club-shaped *pollinium*, or pollen-mass. In what are called *anemophilous* flowers, in which the pollen is carried through the air by the agency of the wind, the grains are small, light, dry, and usually spherical; while in *entomophilous* flowers, the pollen of which is carried from flower to flower by insects in search of honey, the various forms above described, and many others, are adapted to cause the grains to adhere to the hairy under side of the body of the insect, and thus promote their dispersion. The various species of *Epilobium* (willow-herb) and *Evening primrose* are very favourable objects for observing the emission of pollen-tubes and their entrance into the stigma.

The structure and development of the *ovules* that are produced within the ovary at the base of the pistil, and the operation in which their *fertilisation* essentially consists, are subjects of investigation which have a peculiar interest for scientific botanists, but which, in consequence of the special difficulties that attend the inquiry, are not commonly regarded as within the province of ordinary microscopists. Some general instructions, however, may prove useful to such as would like to inform themselves as to the mode in which the generative function is performed in phanerogams. In tracing the origin and early history of the ovule, very thin sections should be made through the flower-bud, both vertically and transversely; but when the ovule is large and distinct enough to be separately examined, it should be placed on the thumb-nail of the left hand, and very thin

¹ It sometimes happens that when the pollen of pines or firs is set free, large quantities of it are carried by the wind to a great distance from the woods and plantations in which it has been produced, and are deposited as a fine yellow dust, so strongly resembling sulphur as to be easily mistaken for it. This (supposed) general diffusion of sulphur (such as occurred in the neighbourhood of Windsor in 1879) has frightened ignorant rustics into the belief that the 'end of the world' was at hand. Its true nature is at once revealed by placing a few grains of it under the microscope.

sections made with a sharp razor; the ovule should not be allowed to dry up, and the section should be removed from the blade of the razor by a wetted camel-hair pencil. The tracing downwards of the pollen-tubes through the tissue of the style may be accomplished by sections (which, however, will seldom follow one tube continuously for any great part of its length), or, in some instances, by careful dissection with needles. Plants of the *Orchis* tribe are the most favourable subjects for this kind of investigation, which is best carried on by artificially applying the pollen to the stigma of several flowers, and then examining one or more of the styles daily. 'If the style of a flower of *Epipactis*,' says Schacht, 'to which the pollen has been applied about eight days previously, be examined in the manner above mentioned, the observer will be surprised at the extraordinary number of pollen-tubes, and he will easily be able to trace them in large strings, even as far as the ovules. *Viola tricolor* (heartsease) and *Ribes nigrum* and *rubrum* (black and red currant) are also good plants for the purpose; in the case of the former plant withered flowers may be taken and branched pollen-tubes will not unfrequently be met with.' The entrance of the pollen-tube into the micropyle may be most easily observed in orchidaceous plants and in *Euphrasia*, it being only necessary to tear open with a needle the ovary of a flower which is just withering, and to detach from the placenta the ovules, almost every one of which will be found to have a pollen-tube sticking in its micropyle. These ovules, however, are too small to allow of sections being made, whereby the origin of the embryo may be discerned; and for this purpose, *Oenothera* (evening primrose) has been had recourse to by Hofmeister, whilst Schacht recommends *Lathraea squamaria*, *Pedicularis palustris*, and particularly *Pedicularis sylvatica*.

We have now, in the last place, to notice the chief points of interest to the microscopist which are furnished by mature seeds. Many of the smaller kinds of these bodies are very curious, and some are very beautiful objects when looked at in their natural state under a low magnifying power. Thus the seed of the poppy (fig. 566. A) presents a regular reticulation upon its surface, pits, for the most part hexagonal, being left between projecting walls; that of the pink (D) is regularly covered with curiously jagged divisions, every one of which has a small bright black hemispherical knob in its

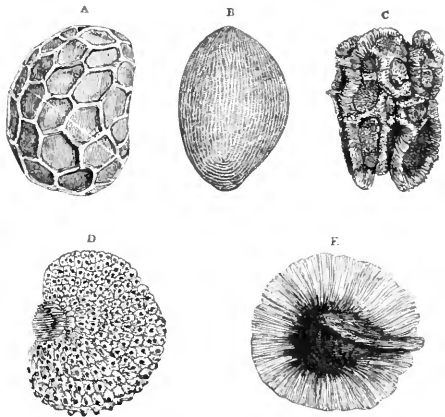

FIG. 566.—Seeds as seen under a low magnifying power; A, poppy; B, *Amaranthus* (prince's feather); C, *Antirrhinum majus* (snapdragon); D, *Dianthus* (clove-pink); E, *Bignonia*.

middle; that of *Amaranthus hypochondriacus* has its surface traced with extremely delicate markings (B); that of *Antirrhinum* is strangely irregular in shape (C), and looks almost like a piece of furnace-slag; and those of many *Bignoniaceae* are remarkable for the beautiful radiated structure of the translucent membrane which surrounds them (E). This structure is extremely well seen in the seed of *Eccremocarpus scaber*, a half-hardy climbing plant common in our gardens; and when its membranous 'wing' is examined under a sufficient magnifying power, it is found to be formed by an extraordinary elongation of the cells of the seed-coat at the margin of the seed; the side-walls of which cells (those, namely, which lie in contact with one another) being thickened so as to form radiating ribs for the support of the wing, whilst the front and back walls (which constitute its membranous surface) retain their original transparency, and are marked only with an indication of spiral deposit in their interior. In the seed of *Dictyoloma peruviana*, besides the principal 'wing' prolonged from the edge of the seed-coat, there is a series of successively smaller wings, whose margins form concentric rings over either surface of the seed; and all these wings are formed of radiating fibres only, composed, as in the preceding case, of the thickened walls of adjacent cells, the intervening membrane, originally formed by the front and back walls of these cells, having disappeared, apparently in consequence of being unsupported by any secondary deposit. Several other seeds, as those of *Sphenogyne speciosa* and *Lophospermum erubescens*, possess wing-like appendages: but the most remarkable development of these organs is said by Mr. Quekett to exist in a seed of *Calosanthus indica*, an East Indian plant, in which the wing extends more than an inch on either side of the seed. Some seeds are distinguished by a peculiarity of form which, although readily discernible by the naked eye, becomes much more striking when they are viewed under a very low magnifying power. This is the case, for example, with the seeds of the carrot, whose long radiating processes make it bear, under the microscope, no trifling resemblance to some kinds of starfish; and with those of *Cyanthus minor*, which bear about the same degree of resemblance to shaving-brushes. In addition to the preceding, the following may be mentioned as seeds easily to be obtained and as worth mounting for opaque objects:—*Anagallis*, *Anethum graveolens*, *Begonia*, *Carum carvi*, *Coreopsis tinctoria*, *Datura*, *Delphinium*, *Digitalis*, *Elatine*, *Erica*, *Gentiana*, *Gesnera*, *Hyoscyamus*, *Hypericum*, *Lepidium*, *Linnocharis*, *Linaria*, *Lychnis*, *Mesembryanthemum*, *Nicotiana*, *Origanum onites*, *Orbanche*, *Petunia*, *Reseda*, *Saxifraga*, *Scrophularia*, *Sedum*, *Semperivivum*, *Silene*, *Stellaria*, *Symphytum asperinum*, and *Verbena*. The following may be mounted as transparent objects in Canada balsam: *Drosera*, *Hydrangea*, *Monotropa*, *Orchis*, *Parnassia*, *Pyrola*, *Saxifraga*.¹ The seeds of umbelliferous plants generally are remarkable for the peculiar *vitta*, or receptacles for essential oil, which are found in the closely applied pericarp or seed-vessel which encloses

¹ A part of these lists have been derived from the *Micrographic Dictionary*.

them. Various points of interest respecting the structure of the *testa* or envelope of seeds, such as the fibre-cells of *Cobaea* and *Collomia*, the stellate cells of the star-anise, and the densely consolidated tissue of the 'shells' of the coquilla-nut, cocoa-nut, &c. having been already noticed, we cannot here stop to do more than advert to the peculiarity of the constitution of the husk of corn-grains. In these, as in other grasses, the ovary itself continues to envelop the seed, giving a covering to it that surrounds the *testa*, and closely adheres to it. The 'bran' detached in grinding consists not only of these two coats, but also (as the microscope reveals) of an outer layer of the grain itself, formed of hexagonal cells disposed with great regularity. As these are filled with *gluten*, the removal of this layer takes away one of the most nutritious parts of the grain; and it is most desirable, therefore, that only the two outer indigestible coats should be detached by the 'decorticating' process devised for the purpose. The hexagonal cell-layer is so little altered by a high temperature as still to be readily distinguishable when the grain has been ground after roasting, thus enabling the microscopist to detect even a small admixture of roasted corn with coffee or chicory without the least difficulty.¹

¹ In a case in which the Author was called upon to make such an investigation, he found as many as *thirty* distinctly recognisable fragments of this cellular envelope in a *single grain* of a mixture consisting of chicory with only 5 per cent. of roasted corn.

CHAPTER XII

MICROSCOPIC FORMS OF ANIMAL LIFE—PROTOZOA

PASSING ON, NOW, to the Animal Kingdom, we begin by directing our attention to those minute and simple forms which correspond in the animal series with the *Protophyta* in the vegetable (Chap. VIII.); and this is the more desirable since the formation of a distinct group to which the name of PROTOZOA (first proposed in this sense by Siebold) may be appropriately given is one of the most interesting results of microscopic inquiry. This group, which must be placed at the very base of the animal scale, is characterised by the apparent simplicity that prevails in the structure of the beings that compose it, the lowest of them being single protoplasmic particles or 'jelly-specks,' whilst even among the highest, however numerous their units may be, these are (as among *protophytes*) mere repetitions of one another, each capable of maintaining an independent existence. In this there is a very curious and significant parallelism to the earliest embryonic stage of higher animals; for the fertilised germ of any one of these first shapes itself as a single cell, and then, by repeated binary subdivisions, develops itself into a *morula* or 'mulberry-mass' of cells, corresponding to the 'multicellular' organisms met with among the higher Protozoa. There is, so far, in neither case any sign of that 'differentiation' of organs which is characteristic of the higher animals; but whilst, in the Protozoön, each cell is not merely similar to its fellows, but is independent of them, the *morula*, in such as go on to a higher stage, becomes the subject of a series of developmental changes tending to the production of a single whole, whose parts are mutually dependent. The first of these changes is its conversion into a *gastrula* or primitive stomach, whose wall is formed of a double membrane, the outer lamella, or *ectoderm*,¹ being derived directly from the external cell-layer of the *morula* whilst the inner, or *endoderm*, is formed by the 'invagination' of that layer into the space left void by the dissolution of the central cells of the 'morula.'² This *gastrula-stage*,² as we shall see hereafter, remains permanent in the great group of *Celentera*, though the endoderm and ectoderm are separated from each other in its higher forms by the development of generative and other organs between

¹ The terms *epiblast* and *hypoblast* are generally used by English embryologists in place of the 'ectoderm' and 'endoderm' used here.

² The *gastrula-stage* is in a number of cases brought about by a concentric splitting of the walls of the *morula* into two layers, and by the appearance at one point of an orifice which leads into the central cavity; this cavity is the original segmentation cavity of the *morula*, and not a fresh cavity, as in 'invaginate gastrulae.'

them. But in all classes above the cœlenterates the primitive stomach forms a part, and often only an insignificant part, of the whole digestive tract. Thus the whole animal kingdom may be divided, in the first place, into the PROTOZOA, which are either single cells or aggregates of similar cells corresponding to the *morula*-stage of higher types; and the METAZOA, in which the morula takes on the condition of an individualised organism, the life of every part of which contributes to the general life of the whole. Putting this important truth into other words, we may say of the Protozoa that they are either unicellular or unicellular aggregates, while the Metazoa are multicellular, and their constituent cells have different functions.

The lowest of the *Protozoa*, however, like the simplest protophytes, do not even attain the rank of a true *cell*, understanding by that designation a definite protoplasmic unit (*plastid*), which is limited by a cell-wall, and contains a 'nucleus.' For they consist of particles of protoplasm, termed 'cytodes,' of indefinite extent, which have neither cell-wall nor nucleus, but which yet take in and digest food, convert it into the material of their own bodies, cast out the indigestible portions, and reproduce their kind, with the regularity and completeness that we have been accustomed to regard as characteristic of higher animals. With regard, however, to this apparent absence of a nucleus we have to bear in mind that the progress of research is continually diminishing the number of forms devoid of a nucleus, or, at any rate, of a nuclear material scattered throughout the substance of the plastid; in retaining, therefore, the group of non-nucleated Protozoa we are acting on the principle of not going beyond our evidence, and by no means reflecting on the later systematists who have merged the various types (whether nucleated or non-nucleated) among other divisions of the Protozoa. Between some of these *Monerozoa* (as they have been designated by Professor Haeckel, who first drew attention to them) and the *Myxomycetes* or the *Chlamydomyxa* already described, no definite line of division can be drawn, the only justification for the separation here adopted being that the affinities of the former seem to be rather with the lowest forms of vegetation, whilst the whole life-history of the types now to be described, and the connected graduation by which they pass into undoubted rhizopods, leave no doubt of *their* claim to a place in the animal kingdom.

MONEROZOA.

A characteristic example of this lowest protozoic type is presented by the *Protomyxa aurantiaca* (fig. 567), a marine 'moner' of an orange-red colour, found by Professor Haeckel upon the dead shells of *Spirula* which are so abundant on the shores of the Canary Islands. In its active state it has the stellar form shown at F, its arborescent extensions dividing and inosculating so as to form a constantly changing network of protoplasmic threads, along which stream in all directions orange-red granules, obviously belonging to the body

itself, together with foreign organisms (*b, c*)—such as marine diatoms, radiolarians, and infusoria—which, having been entrapped in the pseudopodial network, are carried by the protoplasmic stream into the central mass, where the nutrient matter of their bodies is extracted, the hard skeletons being cast out. Neither nucleus nor contractile vesicle is to be discerned, but numerous floating and inconstant vacuoles (*a*) are dispersed through the substance of the body. After a time the currents become slower; the ramified extensions are gradually

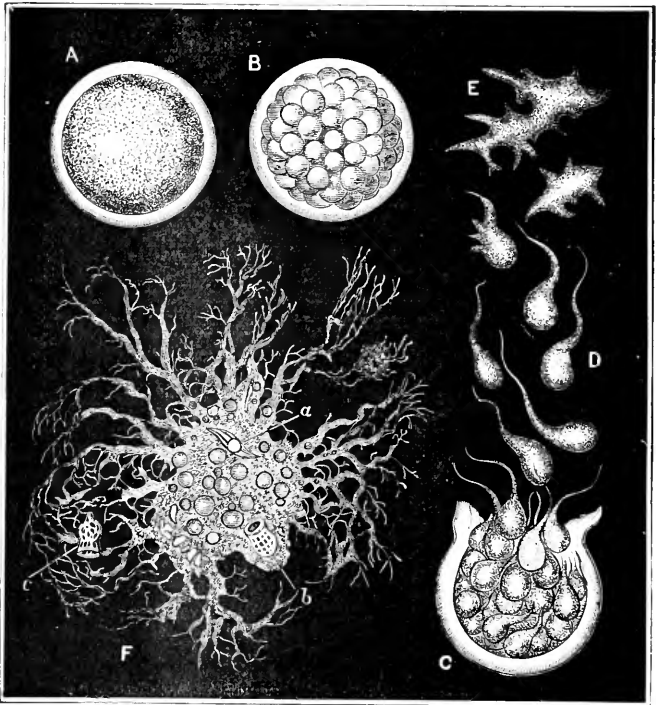

FIG. 567.—*Protomyxa aurantiaca*: A, encysted statospore; B, incipient formation of swarm-spores, shown at C escaping from the cyst, at D swimming freely by their flagellate appendages, and at E creeping in the amoeboid condition; F, fully developed reticulate organism, showing numerous vacuoles, *a*, and captured prey, *b, c*.

drawn inwards; and, after ejecting any indigestible particles it may still include, the body takes the form of an orange-red sphere round which a cyst soon forms itself, as shown in A. After a period of quiescence the protoplasmic substance retreats from the interior of the cyst, and breaks up into a number of small spheres (B), which, at first inactive, soon begin to move within the cyst, and change their shape to that of a pear with the small end drawn out to a point. The cyst then bursts, and the red pear-shaped bodies issue forth into the water (C), moving freely about by the vibrations of *flagella*

formed by the drawing out of their small ends, just as do the flagellated zoöspores of protophytes. These bodies, being without trace of either nucleus, contractile vesicle, or cell-wall, are to be regarded as particles of simple homogeneous protoplasm, to which the designation *plastidules* has been appropriately given. After about a day the motions cease; the flagella are drawn in, and the plastidules take the form and lead the life of *Amaba*, putting forth inconstant pseudopodial processes, and engulfing nutrient particles in their substance (D). Two or more of these amœbiform bodies unite to form a 'plasmodium,' as in the *Myromycetes*; its pseudopodial extensions send out branches which inosculate to form a net-

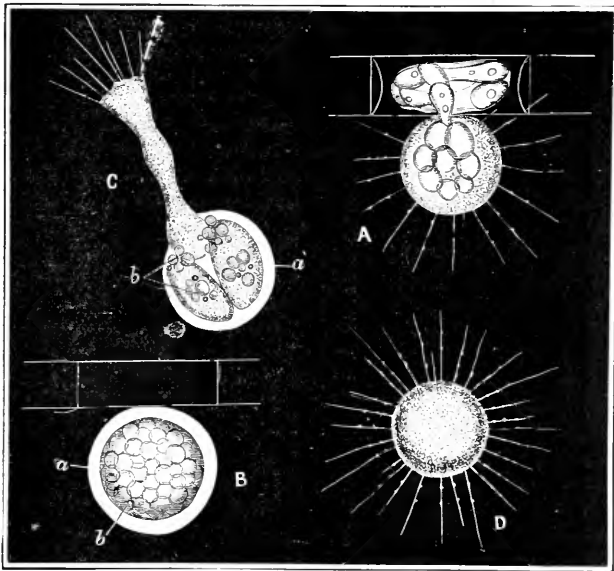

FIG. 568.—*Vampyrella spirogyra*, as seen at A, sucking out contents of *Spirogyra*-cell; at B in encysted condition, the cyst *a* enclosing granular protoplasm *b*; at C, division of contents of cyst into tetraspores, of which one is escaping in the amœboid condition to develop itself into the adult form shown at D.

work; and the body grows, by the ingestion of nutriment, to the size of the original. In this cycle of change there seems no intervention of a generative act, the coalescence of the amœbiform plastidules having none of the characters of a true 'conjugation.' But it is by no means improbable that after a long course of multiplication by successive subdivisions some kind of conjugation may intervene.

Another very interesting 'moneric' type is the *Vampyrella*, of which one form (fig. 568) has long been known in its encysted condition as a minute brick-red sphere attached to the filaments of the conjugate *Spirogyra*; whilst another (fig. 569) similarly attaches itself to the branches of *Gomphonema*. The walls of the

cysts are composed of two membranes, of which the interior gives the characteristic reaction of cellulose, whilst the softer external layer is nitrogenous. After remaining some time in the quiescent condition the encysted protoplasm breaks up into two or four tetraspores (fig. 569, *b, d*); these escape by openings in the cyst (fig. 568, *C*), and soon take the spherical form, emitting very slender pseudopodial filaments (figs. 568, *D*, 569, *e*) like those of an *Actinophrys*, but possessing neither nucleus nor contractile vesicle. In this condition they show great activity, moving about in search of the special nutriment they require, drawing themselves out in strings and fine filaments which tear asunder and again unite to send off branches and form fine fan-like expansions, and these occasionally contracting again into minute spheres. When the *V. spirogyra* is watched in water containing some filaments of *Spirogyra*, it may be seen to wander until it meets one of these filaments, to which, if it be healthy and loaded with chlorophyll, it attaches itself. It soon begins to perforate the wall of the filament; and when the interior of this has been reached, its endoplasm, carrying with it the chlorophyll-granules it includes, passes slowly into the body of the *Vampyrella*. In this manner cell after cell is emptied of its contents; and the plunderer, satiated with food, resumes its quiescent spherical form to digest it. The chlorophyll-granules which it has ingested become diffused through the body, but gradually cease to be distinguishable, the protoplasmic mass assuming a brick-red colour. The first layer it exudes to form its cyst is the outer or nitrogenous investment, within which the cellulose layer is afterwards formed. The *V. gomphonematis* in like manner creeps over the stems and branches of the *Gomphonema* (fig. 569, *e*), adapting itself to the form of its support; and as soon as it has reached one of the terminal siliceous cells of the diatom, it extends itself over it so as completely to envelop the cell in a thin layer of protoplasm. From the surface of this a number of fine pseudopodia radiate into the surrounding water (*f*); whilst another portion of the protoplasm finds its way between the two siliceous valves into the interior, and appropriates its contents. The valves, when emptied, break off from their support, and are cast out of the body of the *Vampyrella*, which soon proceeds to another *Gomphonema*-cell and plunders it in the same manner. After thus ingesting the nutriment furnished by several cells, and acquiring its full size, it passes, like *V. spirogyra*, into the encysted condition, to recommence—after a period of quiescence—the same cycle of change. Mr. Bolton discovered near Birmingham, and Professor Ray Lankester described, a form allied to *Vampyrella*—*Archerina Boltoni*—which is remarkable for being chlorophyllogenous; this species presents another interesting peculiarity:—‘Groups of ghost-like outlines corresponding to chlorophyll-corpuscles and their radiant filamentous pseudopodia, entirely devoid of any substance,’ were observed, and were compared to the numerous cellulose chambers which are secreted and abandoned by the protoplasm of *Chlamydomyxa*.

Intermediate between the foregoing and the ‘reticularian’ rhizopods to be presently described, is another simple protozoön dis-

covered in ponds in Germany by MM. Claparède and Lachmann, and named by them *Lieberkuehnia Wageneri*.¹ The whole substance of the body of this animal and its pseudopodial extensions (fig. 570) is composed of a homogeneous, semi-fluid, granular protoplasm, the particles of which, when the animal is in a state of activity, are continually performing a circulatory movement, which may be likened to the rotation of the particles in the protoplasmic

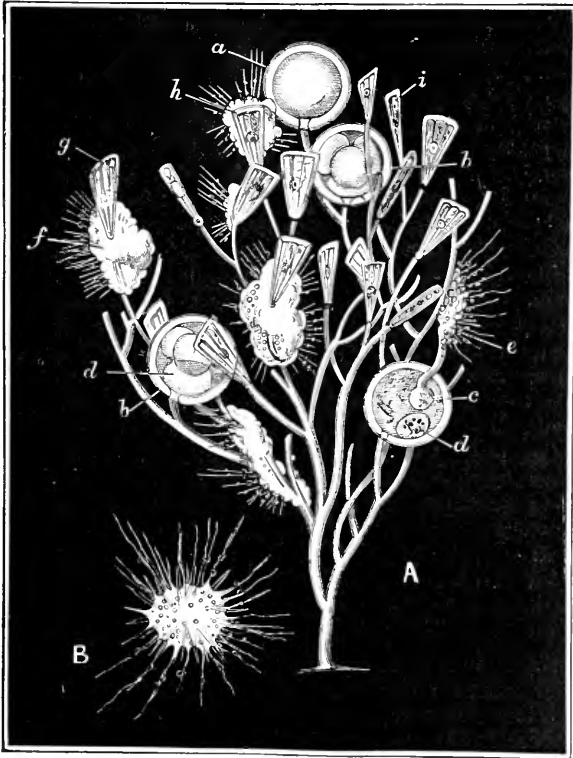

FIG. 569.—*Vampyrella gomphonematis*: A, colony of *Gomphonema* attacked by *Vampyrella*; a, encysted state; b, b, cysts with contents breaking up into tetraspores, d, d, seen escaping at e; at f is shown a *Vampyrella* sucking out contents of *Gomphonema*-cells, the emptied frustules of which, g, h, are cast forth. B, isolated *Vampyrella* creeping about by its extended pseudopodia.

network within the cell of a *Tradescantia*. It is a marked peculiarity of the pseudopodial extension of this type that it does not take place by radiation from all parts of the body indifferently, but that it

¹ *Etudes sur les Infusoires et les Rhizopodes*, Geneva, 1858-1861. The beautiful figure of *Lieberkuehnia*, given by M. Claparède, has been reproduced by the Author in Plate I. of his *Introduction to the Study of the Foraminifera*.

proceeds entirely from a sort of trunk that soon divides into branches which again speedily multiply by further subdivision, until at last a multitude of finer and yet finer threads are spun out by whose continual inosculations a complicated network is produced, which may be likened to an animated spider's web. The protoplasm is invested in a very delicate and closely applied envelope. Any small alimentary particles that may come into contact with the glutinous surface of the pseudopodia are retained in adhesion by it, and speedily partake of the general movement going on in their substance. This movement takes place in two principal directions—

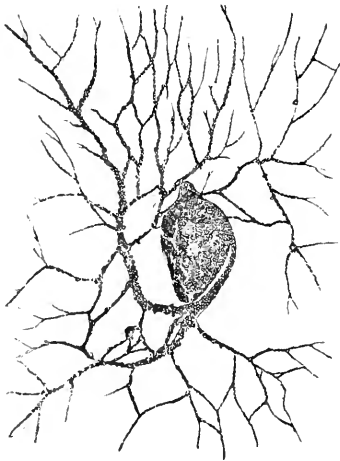

FIG. 570.—*Lieberkuehnia Wageneri*.

from the body towards the extremities of the pseudopodia, and from these extremities back to the body again. In the larger branches a double current may be seen, two streams passing at the same time in opposite directions; but in the finest filaments the current is single and a granule may be seen to move in one of them to its very extremity, and then to return, perhaps meeting and carrying back with it a granule that was seen advancing in the opposite direction. Even in the broader processes granules are sometimes observed to come to a stand, to oscillate for a time, and then to take a retrograde course, as if they had been entangled in the opposing current, just as is often to be seen in *Chara*. When a granule arrives at a point where a filament bifurcates, it is often arrested for a time, until drawn into one

or the other current; and when carried across one of the bridge-like connections into a different band, it not unfrequently meets a current proceeding in the opposite direction, and is thus carried back to the body without having proceeded very far from it. The pseudopodial network along which this 'cyclosis' takes place is continually undergoing changes in its own arrangement, new filaments being put forth in different directions, sometimes from its margin, sometimes from the midst of its ramifications, whilst others are retracted. Not unfrequently it happens that to a spot where two or more filaments have met, there is an afflux of the protoplasmic substance that causes it to accumulate there as a sort of secondary centre, from which a new radiation of filamentous processes takes place. Occasionally the pseudopodia are entirely retracted, and all activity ceases; so that the body presents the appearance of an inert lump. But if watched sufficiently long its activity is resumed, so that it may be presumed to have been previously satiated with food, which

is undergoing digestion during its stationary period. No encysting process has been noticed in *Lieberkuehnia*; but Cienkowsky has discovered that in *L. paludosa* reproduction is effected by a process of fission, which commences with the formation of a new pseudopodial stalk at the base of the animal, the envelope being perforated at this point. As the marine type of it occurs on our own coasts, the fresh-water type may very likely be found in our ponds, and either may be recommended as a most worthy object of careful study.

RHIZOPODA.

We now arrive at the group of *rhizopods*, or 'root-footed' animals, first established by Dujardin for the reception of the *Amaba* and its allies, which had been included by Professor Ehrenberg among his infusory animalcules, but which Dujardin separated from them as being mere particles of *sarcodé* (protoplasm), having neither the definite body-wall nor the special mouth of the true *Infusoria*, but putting forth extensions of their sarcodic substance, which he termed *pseudopodia* (or false feet), serving alike as instruments of locomotion and as prehensile organs for obtaining food. According to Dujardin's definition of this group, the *Monerazoa*, already described, would be included in it; but it seems on various grounds desirable to limit the term *Rhizopoda* to those Protozoa in which the presence of a *nucleus*, the differentiation of an *ectosarc* (or firmer superficial layer of protoplasm) from the semi-fluid *endosarc*, together with the more definite form and restricted size, indicate a distinct approach to the condition of true cells. Many different schemes for the classification of the rhizopods have been proposed, but none of them can be regarded as entirely satisfactory, our knowledge of the reproductive processes, and of other important parts of the life-history of these creatures, being still extremely imperfect; and as some parts of the scheme proposed by the Author many years ago,¹ based on the characters of the pseudopodial extensions, have been accepted by more recent systematists, it seems best still to adhere to it.

I. In the first division, *Reticularia*, the pseudopodia freely ramify and inosculate, so as to form a network, exactly as in *Lieberkuehnia*, from which they are distinguished by the possession of a nucleus and by the investment of their sarcodic bodies in a firm envelope. This is most commonly either a *calcareous* shell of very definite shape, or a *test* built up of sand-grains or other minute particles more or less firmly united by a calcareous cement exuded from the sarcodic body. These testaceous forms, which are exclusively marine, constitute the group of *Foraminifera*, whose special interest to the microscopist entitles it to separate consideration; and it is only for convenience that two *Reticularia* which inhabit fresh water also, and the envelopes of whose bodies are usually membranous, are here separated from the Foraminifera (to which they properly belong) for description as types of the group. The *Reticularia* have little locomotive power, and only seem to

¹ *Natural History Review*, 1861, p. 456; and *Introduction to the Study of the Foraminifera*, 1862, chap. ii.

exercise it to find a suitable situation for their attachment, the capture of their food being effected by their pseudopodial network.

II. The second division, *Heliozoa*, consists of the rhizopods whose pseudopodia extend themselves as straight radiating rods, having little or no tendency to subdivide or ramify, though they are still sufficiently soft and homogeneous (at least in the lower types) to coalesce when they come into contact with each other. These have usually (probably always) a contractile vesicle as well as a nucleus; and the higher forms of them are characterised by the enclosure of symbiotic yellow corpuscles (*zöochlorellæ*) in the substance of their endosarc. By far the larger number of this group also have skeletons of mineral matter, which are always *siliceous*; and these are sometimes perforated casings of great regularity of form, as in the marine *Polycystina*, sometimes internal frameworks of marvellous symmetry, as in the marine *Radiolaria*. These two groups, also, will be reserved for special notice, the simple *Heliozoa*, which are among the commonest inhabitants of fresh water, furnishing the best illustrations of the essential characters of the type. They seem, for the most part, to have but little locomotive power, capturing their prey by their extended pseudopodia. The tendency of modern writers is to separate the *Heliozoa*, as here understood, into the two groups of *Heliozoa* (sens. strict.) and *Radiolaria*, the latter being distinguished by the presence of a central capsule or mass of protoplasm surrounded by a special envelope, the better development of the skeleton, the greater tendency of the pseudopodia to coalesce with one another, and the not unfrequent presence of 'yellow bodies.'

III. The third group, *Lobosa*, contains the rhizopods which most nearly approach the condition of true cells, in the differentiation of their almost membranous ectosarc and their almost liquid endosarc, and in the non-coalescence of their pseudopodial extensions, which, instead of being either thread-like or rod-like, are *lobate*, that is, irregular projections of the body, including both ectosarc and endosarc, which are continually undergoing change both in form and number. The *Lobosa* are comparatively active in their habits, moving freely about in search of food, which is still received into the substance of their bodies through any part of their surface—unless this is enclosed in envelopes such as are formed by many of them, either by exudation from the surface of their bodies of some material (probably chitinous) which hardens into a membrane, or by aggregating and uniting grains of sand or other small solid particles, which they build up into 'tests.' A large proportion of them are inhabitants of fresh water, and some are even found in damp earth.

Reticularia.—This type is very characteristically represented by the genus *Gromia* (fig. 571), some of whose species are marine, and are found, like ordinary *Foraminifera*, among tufts of corallines, algae, &c.; whilst others inhabit fresh water, adhering to *Conferve* and other plants of running streams. It was in this type that the presence of a nucleus, formerly supposed to be wanting in *Reticularia*

generally, was first established by Dr. Wallich. The sarcode-body of this animal is encased in an egg-shaped, brownish-yellow, chitinous envelope, which may attain a diameter of from $\frac{1}{2}$ th to $\frac{1}{10}$ th of an inch, looking to the naked eye so like the egg of a zoöphyte or the seed of an aquatic plant, that its real nature would not be suspected so long as it remained quiescent. The 'test' has a single round orifice, from which, when the animal is in a state of activity, the sarcodic substance streams forth, speedily giving off ramifying extensions, which, by further ramification and inosculation, form a network like that of Lieberkuehnia. But the sarcode also extends itself so as to form a continuous layer over the whole exterior of the 'test,' and from any part of this layer fresh pseudopodia may be given off. By the alternate extension and contraction of these, minute protophytes and protozoa are entrapped and drawn into the interior of the test, where their nutritive material is extracted and assimilated; and if the 'test' (as happens in some species) be sufficiently transparent, the indigestible hard parts (such as the siliceous valves of diatoms, shown in fig 571) may be distinguished in the midst of the sarcodic substance. By the same agency the *Gromia*

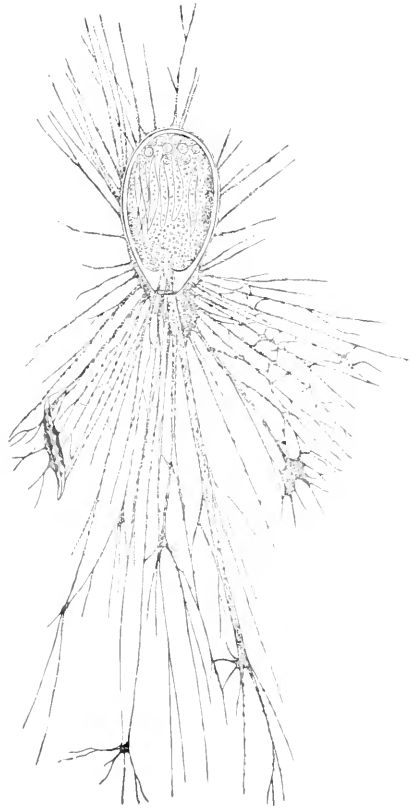

FIG. 571.—*Gromia oriformis*, with its pseudopodia extended.

sometimes creeps up the sides of a glass vessel. In the intervals of quiescence, on the other hand, the whole sarcodic body, except a film that serves for the attachment of the test, is withdrawn into its interior.

Another example of the reticularian group is afforded by the curious little *Microgromia socialis* (fig. 572), first discovered by Mr. Archer, and further investigated with great care by Hertwig,¹ which

¹ 'Ueber *Microgromia*,' in *Archiv für Mikr. Anat.*, bd. x. Supplement.

has the curious habit of uniting with neighbouring individuals by the fusion of the pseudopodia, into a common 'colony,' the individuals sometimes remaining at a distance from one another as at A, but sometimes aggregating themselves into compact masses as at B. The nearly globular thin calcareous shell is prolonged into a short neck having a circular orifice, from which the sarcod-body extends itself,

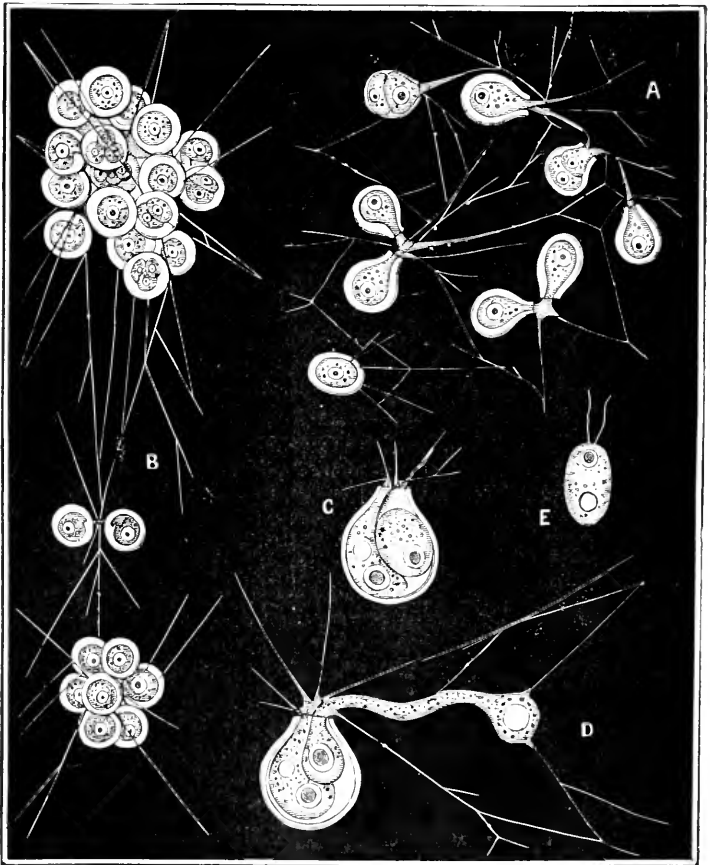

FIG. 572. —*Microgromia socialis*: A, colony of individuals in extended state, some of them undergoing transverse fission; B, colony of individuals (some of them separated from the principal mass) in compact state; C, D, formation and escape of swarm-spore, seen free at E.

giving off very slender pseudopodia which radiate in all directions. A distinct nucleus can be seen in the deepest part of the cavity; while a contractile vesicle lies imbedded in the sarcodic substance nearer the mouth. Multiplication by duplicative subdivision has been distinctly observed in this type; but with a peculiar departure

from the usual method. A transverse constriction divides the body into two halves—as shown in two individuals of colony A—each half possessing its own nucleus and contractile vesicle; the posterior segment, which at first lies free at the bottom of the cell, then presses forwards towards its orifice, as shown at C, and finally, by amœboid movements, escapes from it, sometimes stretching itself out like a worm (as seen at D), sometimes contracting itself into a globe, and sometimes spreading itself out irregularly over the pseudopodia of the colony. But it finally gathers itself together and takes an oval form; and either develops a pair of flagella, and forsakes the colony as a free-swimming *monad*, or assumes the form of an *Actinophrys*, moving about by three or four pointed pseudopodia—probably in each case coming after a time to rest, excreting a shell, and laying the foundation of a new colony. There is reason to think that a multiplication by longitudinal fission also takes place, in which the escaping segment and the one left behind in the old shell remain attached by their pseudopodia, and the former develops a new shell without undergoing any change of condition.

Heliozoa.¹—The *Actinophrys sol*, sometimes termed the ‘sun-animalcule’ (fig. 573), is one of the commonest examples of this group, being often met with in lakes, ponds, and streams, amongst *Conferva* and other aquatic plants, as a whitish-grey spherical particle distinguishable by the naked eye, from which (when it is brought under sufficient magnifying power) a number of very pellucid, slender, pointed rods are seen to radiate. The central portion of the body is composed of homogeneous sarcode, inclosing a distinct nucleus; but the peripheral part has a ‘vesicular’ aspect, as in the type next to be described (fig. 574). This appearance is due to the number of ‘vacuoles’ filled with a watery fluid, which are included in the sarcodic substance, and which may be artificially made either to coalesce into larger ones or to subdivide into smaller. A ‘contractile vesicle,’ pulsating rhythmically with considerable regularity, is always to be distinguished, either in the midst of the sarcodic body, or (more commonly) at or near its surface; and it sometimes projects considerably from this, in the form of a sacculus with a delicate membranous wall, as shown at fig. 573. A, *cc.* The cavity of this sacculus is not closed externally, but communicates with the surrounding medium—not, however, by any distinct and permanent orifice, the membranous wall giving way when the vesicle contracts, and then closing over again. This alternating action seems to serve a respiratory purpose, the water thus taken in and expelled being distributed through a system of channels and vacuoles excavated in the substance of the body, some of the vacuoles which are nearest the surface being observed to undergo distension when the vesicle contracts, and to empty themselves gradually as it refills. The body of this animal is nearly motionless.²

¹ A systematic account of this group is to be found in Dr. F. Schaudinn’s ‘Heliozoa,’ the first part of the comprehensive *Das Tierreich*, edited by the German Zoological Society, Berlin, 1896. M. Pénard’s memoir, ‘Etudes sur quelques Héliozoaires d’Eau Douce,’ in vol. ix. of the *Arch. de Biol.*, should be consulted.

² A swimming Heliozoön has lately been described by M. E. Pénard, who calls it *Myriophrys paradoxa*.

but it is supplied with nourishment by the instrumentality of its pseudopodia, its food being derived not merely from vegetable particles, but from various small animals, some of which (as the young of Entomostraca) possess great activity as well as a comparatively high organisation. When one of these happens to come into contact with one of the pseudopodia (which have firm axis-filaments (*ax*) clothed with a granular sarcode), this usually retains it by adhesion; but the mode in which the particle thus taken captive is introduced into the body differs according to circumstances. If the prey is large and vigorous enough to struggle to escape from its entanglement, it may usually be observed that the neighbouring pseudopodia bend over and

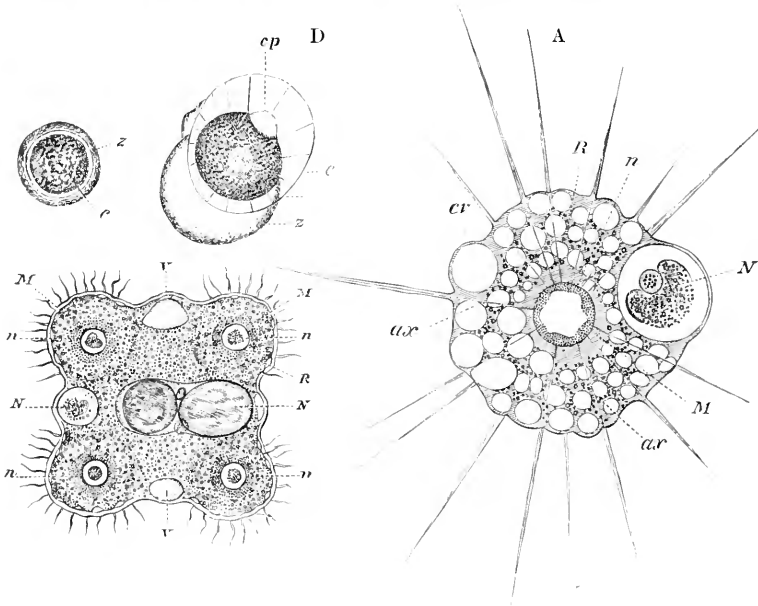

FIG. 573. *Actinophrys sol*: A, figure showing the wide vacuolated cortical layer or ectosarc (*R*) and the fine granulated endosarc (*M*); *n*, central nucleus, *ax*, axial filaments of pseudopodia; *cr*, contractile vacuole; *N*, food-mass inclosed in a large food-vacuole. B, a colony of four individuals, after treatment with acetic acid; *R*, *M*, and *N*, as before; *v*, *v*, vacuoles. C, a cyst; *z*, *c*, outer and inner envelopes. D, a burst cyst from which the young is escaping, though still inclosed by the inner envelope. (From Bütschli, after Grenacher, Stein, and Cienkowski.)

apply themselves to it, so as to assist in holding it captive, and that it is slowly drawn by their joint retraction towards the body of its captor. Any small particle not capable of offering active resistance, on the other hand, may be seen after a little time to glide towards the central body along the edge of the pseudopodium, without any visible movement of the latter, much in the same manner as in *Gromia*. When in either of these modes the food has been brought to the surface of the body, this sends over it on either side a prolongation of

its own sarcode-substance ; and thus a marked prominence is formed (fig. 573, A, x), which gradually subsides as the food is drawn more completely into the interior. The struggles of the larger animals, and the ciliary action of *Infusoria* and *Rotifera*, may sometimes be observed to continue even after they have been thus received into the body ; but these movements at last cease, and the process of digestion begins. The alimentary substance is received into one of the vacuoles, where it lies in the first instance surrounded by liquid ; and its nutritive portion is gradually converted into an indistinguishable gelatinous mass, which becomes incorporated with the material of the sarcode-body, as may be seen by the general diffusion of any colouring particles it may contain. Several

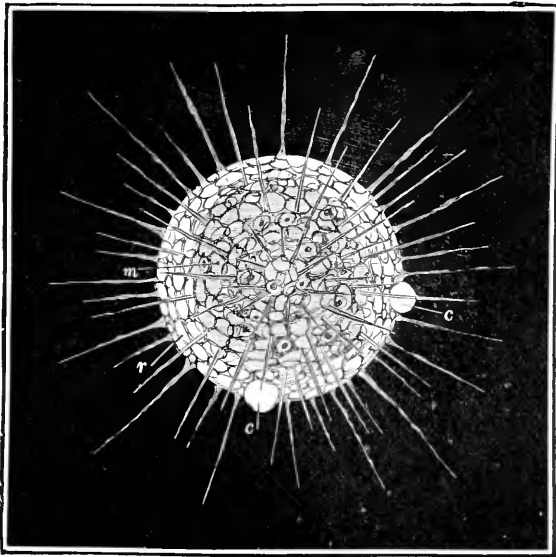

FIG. 574.—*Actinosphaerium Eichornii*; *m*, endosarc; *r*, ectosarc; *c*, *c*, contractile vacuoles.

vacuoles may be thus occupied at one time by alimentary particles ; frequently four to eight are thus distinguishable, and occasionally ten or twelve ; Ehrenberg, in one instance, counted as many as sixteen, which he described as multiple stomachs. Whilst the digestive process, which usually occupies some hours, is going on, a kind of slow circulation takes place in the entire mass of the endosarc with its included vacuoles. If, as often happens, the body taken in as food possesses some hard indigestible portion (as the shell of an entomostracan or rotifer), this, after the digestion of the soft parts, is gradually pushed towards the surface, and is thence extruded by a process exactly the converse of that by which it was drawn in. If the particle be large, it usually escapes at once by an opening which

extemporises itself for the occasion ; but if small it sometimes glides along a pseudopodium from its base to its point, and escapes from its extremity.

The ordinary mode of reproduction in *Actinophrys* seems to be by binary subdivision, its spherical body showing an annular constriction, which gradually deepens so as to separate its two halves by a sort of hour-glass constriction, and the connecting band becoming more and more slender, until the two halves are completely separated. The segments thus divided are not always equal, and sometimes their difference in size is very considerable. A junction of two individuals, on the other hand, has been seen to take place in *Actinophrys*, and has been supposed to correspond to the 'conjugation' of protophytes ; it is very doubtful, however, whether this junction really involves a complete fusion of the substance of the bodies which take part in it,

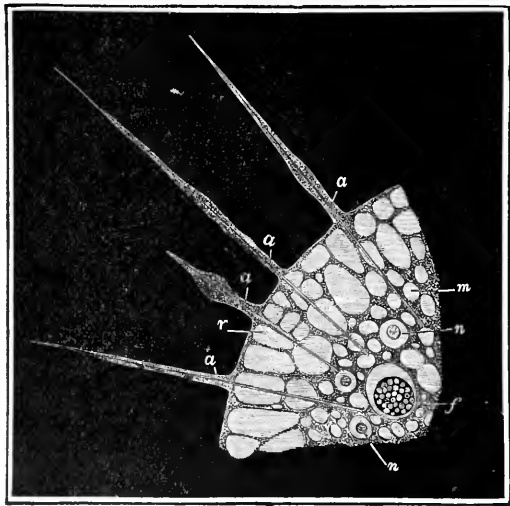

FIG. 575.—Marginal portion of *Actinospherium Eichornii* as seen in optical section under a higher magnifying power: *m*, endosarc; *r*, ectosarc; *a, a, a*, pseudopodia; *n, n*, nuclei with nucleoli; *f*, ingested food-mass.

and there is not sufficient evidence that it has any true generative character. Under these circumstances we must hope that Dr. F. Schaudinn's preliminary notes of his observations¹ may soon be followed by a more detailed account. This author claims to have demonstrated the fusion of the nuclei of *A. sol*, and the resemblance of the course of events to the maturation of the ova of higher animals is very striking. Certain it is that such a junction or 'zygosis' may take place, not between two only, but even several individuals at once, their number being recognised by that of their contractile vesicles ; and that, after remaining thus united for several

¹ SB. Akad., Berlin, 1896, p. 49.

hours as a colony, they may separate again without having undergone any discoverable change.

Under the generic name *Actinophrys* was formerly ranked the larger but less common Heliozoön, now distinguished as *Actinosphaerium Eichornii* (fig. 574); the pseudopodia are longer and more numerous; there are generally a number instead of one contractile vacuole, and there is more than one nucleus. The axis of the pseudopodia may be seen to be clothed with a layer of soft sarcode derived from the superficial or cortical zone of the body.

Several nuclei (u, n) are usually to be seen imbedded in the protoplasmic mass. The general life-history of this type corresponds with that of the preceding, but its mode of reproduction presents some marked peculiarities. In many if not in all cases it commences, as first observed by Kölliker, with the conjugation of two separate individuals. The binary segmentation is preceded by a withdrawal of the pseudopodia, even their clearly defined axis becoming indistinct and finally disappearing; the body becomes enveloped by a clear gelatinous exudation, which forms a kind of cyst; and within this the process of binary subdivision is repeatedly performed, until the original single mass is replaced by a sort of

morula, each spherule of which shows the distinction between the central and cortical regions, the former including a single nucleus, whilst the latter is strengthened by siliceous deposit into a firm investment. After remaining in this state during the winter the young *Actinosphaeria* come forth in the spring without this siliceous investment, and gradually grow into the likeness of their parent.¹

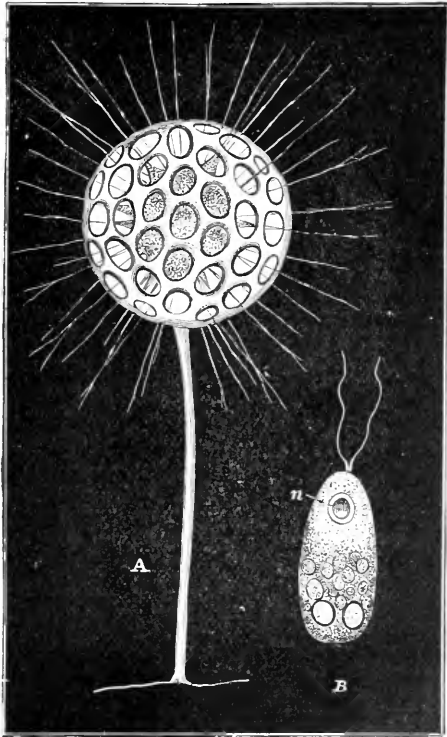

FIG. 576. — *Clathrulina elegans*: A, complete organism; B, swarm-spore showing nucleus, n , and two contractile vesicles near its opposite end.

¹ On the results of the artificial division of *Actinosphaerium* see K. Brandt, *Ueber Actinosphaerium Eichornii*, Halle a S., 1877; Gruber, *Berichte d. Naturf. Ges. zu Freiburg i. B.*, 1886; Nussbaum, *Arch. f. Mikr. Anat.* xxvi.

A large number of new and curious fresh-water forms of this type are being frequently brought under notice, of which the *Clathrulina elegans* (fig. 576) may be specially mentioned as presenting an obvious transition to the *Polycystine* type. This has been found in various parts of the Continent, and also (by Mr. Archer¹) in Wales and Ireland, occurring chiefly in dark ponds shaded by trees and containing decaying leaves. Its soft sarcode-body, which is not differentiated into ectosarc and endosarc, is encased by a siliceous capsule of spherical form, regularly perforated with oval apertures, and supported on a long silicified peduncle. The body itself and the pseudopodia which it puts forth through the apertures of the capsule seem closely to correspond with those of *Actinophrys*. Reproduction here takes place not only by binary fission, but by the formation of 'swarm-spores.' In the first mode one of the two segments remains in possession of the siliceous capsule, whilst the other finds its way out through one of the apertures, lives for some hours in a free condition as an *Actinophrys*, and ultimately produces the capsule and stem characteristic of its type. In the second mode numerous small rounded sarcode masses, each possessing a nucleus, are produced within the capsule, in what manner cannot be clearly made out; and every one of these is

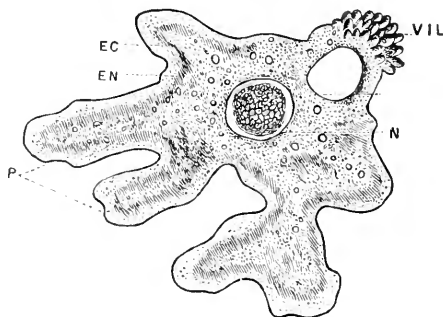

FIG. 577.—Diagrammatic representation of *Amœba proteus*: E C, ectosarc; E N, endosarc; C V, contractile vesicle; N, nucleus; P, pseudopodia; VIL, villous tuft.

opposite end. After swarming for some hours in this condition, they change to the free *Actinophrys* form, and finally acquire the siliceous capsule and stem of the *Clathrulina*.

Lobosa.—No example of the rhizopod type is more common in streams and ponds, vegetable infusions, &c., than the *Amœba* (fig. 577); a creature which cannot be described by its form, for this is as changeable as that of the fabled Proteus, but may yet be definitely characterised by peculiarities that separate it from the two groups already described. The distinction between 'ectosarc' and 'endosarc' is here clearly marked, so that the body approaches

¹ See his memoir on Fresh-water Radiolaria in *Quart. Journ. of Microsc. Sci.* n.s. vol. ix. 1869, p. 250.

much more closely in its characters to an ordinary 'cell' composed of cell-wall and cell-contents. It is through the 'endosarc' alone, E N, that those coloured and granular particles are diffused, on which the hue and opacity of the body depend; its central portion seems to have an almost watery consistence, the granular particles being seen to move quite freely upon one another with every change in the shape of the body; but its superficial portion is more viscid, and graduates insensibly into the firmer substance of the 'ectosarc.' The ectosarc, E C, which is perfectly pellucid, forms an almost membranous investment to the endosarc: still it is not possessed of such tenacity as to oppose a solution of its continuity at any point, for the introduction of alimentary particles, or for the extrusion of effete matter;¹ and thus there is no evidence, in *Amœba* and its immediate allies, of the existence of any more definite orifice, either oral or anal, than exists in other rhizopods. The more advanced differentiation of the ectosarc from the endosarc of *Amœba* is made evident by the effects of reagents. If an *Amœba radiosa* be treated with a dilute alkaline solution, the granular and molecular endosarc shrinks together and retreats towards the centre, leaving the radiating extensions of the ectosarc in the condition of caecal tubes, of which the walls are not soluble at the ordinary temperature either in acetic or mineral acids, or in dilute alkaline solutions, thus agreeing with the envelope noticed by Cohn as possessed by *Paramecium* and other ciliated *Infusoria*, and with the containing membrane of ordinary animal cells. A 'nucleus,' N, is always distinctly visible in *Amœba*, adherent to the inner portion of the ectosarc, and projecting from this into the cavity occupied by the endosarc: when most perfectly seen it presents the aspect of a clear flattened vesicle surrounding a solid and usually spherical nucleolus; it is readily soluble in alkadies, and first expands and then dissolves when treated with acetic or sulphuric acid of moderate strength; but when treated with dilute acid it is rendered darker and more distinct, in consequence of the precipitation of a finely granular substance in the clear vesicular space that surrounds the nucleolus. A 'contractile vesicle,' C V, seems also to be uniformly present, though it does not usually make itself so conspicuous by its external prominence as it does in *Actinophrys*; and the neighbouring part of the body is often prolonged into a set of villous processes, V I L, the presence of which has been thought by some to mark a specific distinction, but which seems too variable and transitory to be so regarded.

The pseudopodia, which are not appendages, but lobate extensions of the body itself, are few in number, short, broad, and rounded; and their outlines present a sharpness which indicates that the substance of which their exterior is composed possesses considerable tenacity. No movement of granules can be seen to take place along the surface of the pseudopodia; and when two of these organs come

¹ This remarkable character has been stated by Professor Huxley in the following admirable sentence: 'Physically the ectosarc might be compared to the wall of a soap-bubble, which, though fluid, has a certain viscosity, which not only enables its particles to hold together and form a continuous sheet, but permits a rod to be passed into or through the bubble without bursting it, the walls closing together, and recovering their continuity as soon as the rod is drawn away.'

into contact they scarcely show any disposition even to mutual cohesion, still less to fusion of their substance. Sometimes the protrusion seems to be formed by the ectosarc alone, but more commonly endosarc also extends into it, and an active current of granules may be seen to pass from what was previously the centre of the body into the protruded portion, when the latter is undergoing rapid elongation; whilst a like current may set towards the centre of the body from some other protrusion which is being withdrawn into it. It is in this manner that an *Amaba* moves from place to place, a protrusion like the finger of a glove being first formed, into which the substance of the body itself is gradually transferred, and another protrusion being put forth, either in the same or in some different direction, so soon as this transference has been accomplished, or even before it is complete. The kind of progression thus executed by an *Amaba* is described by most observers as a 'rolling' movement, this being certainly the aspect which it commonly seems to present; but it is maintained by M.M. Claparède and Lachmann that the appearance of rolling is an optical illusion, since the nucleus and contractile vesicle always maintain the same position relatively to the rest of the body, and that 'creeping' would be a truer description of the mode of progression. It is in the course of this movement from place to place that the *Amaba* encounters particles which are fitted to afford it nourishment; and it appears to receive such particles into its interior through any part of the ectosarc, whether of the body itself or of any of its lobose expansions, insoluble particles which resist the digestive process being got rid of in the like primitive fashion.

It may often be seen that portions of the sarcode-body of an *Amaba*, detached from the rest, can maintain an independent existence; and it is probable that such separation of fragments is an ordinary mode of increase in this group. When a pseudopodial lobe has been put forth to a considerable length, and has become enlarged and fixed at its extremity, the subsequent contraction of the connecting portion, instead of either drawing the body towards the fixed point, or retracting the lobe into the body, causes the connecting band to thin away until it separates; and the detached portion speedily shoots out pseudopodial processes of its own, and comports itself in all respects as an independent *Amaba*. Multiplication also takes place by regular binary subdivision. Various observers have seen phenomena which they have supposed to be evidence of the formation of 'swarm-spores'¹ or of the development of cysts, but it must be borne in mind that a large number of protozoa pass during the course of their life through amebiform stages, some of which may have been taken as true species of *Amaba*. No sexual act has been certainly recognised as part of the life-history of *Amaba*, the union of two or more individuals, which may be occasionally witnessed, having more the character of the 'zygosis' of Actinophrys.

A sarcodic organism discovered by Greef, and named by him *Pelomyxa palustris* (fig. 578), which spreads over the bottom of stagnant ponds in the condition of slimy masses of indefinite form,

¹ Prof. A. M. Edwards (U.S.A.) in *Monthly Microsc. Journ.*, vol. viii, 1872, p. 29.

exhibits a further advance upon the Amœban type. The substance of its body, which may be of the size of two millimetres, exhibits a very clear differentiation between the homogeneous hyaline ectosarc (B. *a, d*) and the contained endosarc, which contains such a multitude of spherical vacuoles, *b*, as to have a 'vesicular' or frothy aspect. When it feeds upon the decomposing vegetable matter at the bottom of the pool it inhabits, its body acquires a blackish hue, but in other situations it may be colourless. Besides the vacuoles there are seen in the endosarc a great number of nucleus-like bodies,

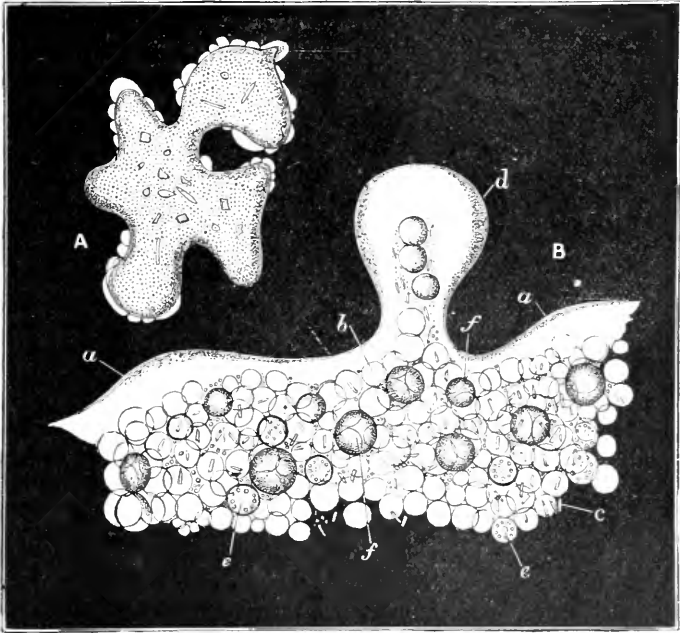

FIG. 578.—*Pelomyxa palustris*: A, as it appears when in amoeboid motion; B, portion more highly magnified, showing *a, a*, the hyaline ectosarc; *b*, one of the vacuoles of the endosarc; *c*, rod-like bodies (probably *Bacteria*) scattered through the endosarc; *d*, protruded extension of ectosarc with endosarc passing into it; *e, e*, nuclei; *f, f*, globular hyaline bodies.

e, e, and also many hyaline globular brilliant bodies, *f, f*, which are regarded by Greef as germs or swarm-spores developed from nucleoli set free within the general cavity of the body by the bursting of the nuclei. This creature during the active period of its life moves like an amœba, either by general undulations of its surface, or by special pseudopodial extensions, *d*. After a time, however, its movements cease, and it looks as if dead; but by the giving way of its ectosarc, a multitude of minute amœbiform bodies break forth, each having its nucleus and contractile vesicle. These at first live as *Amæbae*, but afterwards pass into a resting state, assuming a spherical

or oval shape, and then put forth flagella, by which they swim actively for a time; later on, they probably settle down to develop themselves into the parental form.

The Amœban like the Actinophryan type shows itself in the testaceous as well as in the naked form, the commonest examples of this being known under the names *Arcella* and *Diffugia*. The body of the former is inclosed in a 'test' composed of a horny membrane, apparently resembling in constitution the *chitin* which gives solidity to the integuments of insects; it is usually discoidal (fig. 579, C, D) with one face flat and the other arched, the aperture being in the centre of the flat side; and its surface is often marked with a minute and regular pattern. The test of *Diffugia*, on the other hand, is more or less pitcher-shaped (A, B), and is chiefly made up of minute particles of gravel, shell, &c. cemented together. In each of these genera the sarcode-body resembles that of *Amœba* in every essential particular, the contrast being very marked between its large, distinct, lobose extensions, and the ramifying and inosculating pseudopodia of *Cromia* (fig. 571). In each case a detached portion of the sarcodic body will put forth pseudopodia of

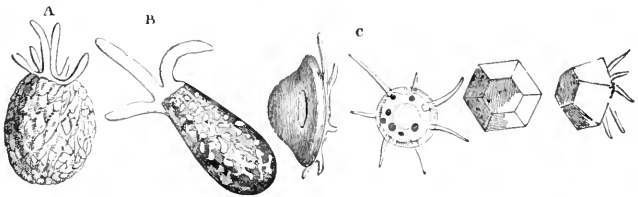

FIG. 579.—Testaceous forms of Amœban rhizopods: A, *Diffugia proteiformis*; B, *Diffugia oblonga*; C, *Arcella acuminata*; D, *Arcella dentata*.

its own type; and the separation of a bud or gemmule put forth from the mouth of the test seems to be an ordinary mode of propagation among the amœbians thus inclosed. In *Arcella* it has been observed that the pseudopodia of two or more individuals unite by bridges of protoplasm, and afterwards separate; and it seems to be almost certain that this is a true 'conjugation,' and not a mere 'zygosis.' A remarkable method of reproduction has been observed by Gruber in *Euglypha alveolata*; in an active form highly refractive bodies, which, seen from the surface, look like discs, are to be found beside the nucleus. Reproduction commences with the protrusion of protoplasm from the orifice of the test, and, later on, the just-mentioned bodies pass out also, and form a covering for the extruded protoplasm; in about an hour the process is complete, but the new or daughter-cell is still without a nucleus. This is derived from that of the mother, which increases in size, elongates greatly, and then becomes constricted; the anterior portion passes into the daughter-cell. Here we have the remarkable phenomena of the formation of the test by the parent-cell and the rare case of division of the protoplasmic body preceding that of its nucleus.

Many testaceous *amebians* have been recently discovered, which form tests of remarkable regularity and sometimes of singular beauty; and it is difficult to determine, in many cases, whether the minute plates of which they are composed have been formed by exudation from their own bodies or have been picked up from the surface over which the animals crawl. There can be no doubt of this kind, however, in regard to the *Quadrula symmetrica* represented in fig. 580; the sarcode-body is here encased in a pear-shaped test, of glassy transparency, made up of a great number of square plates which touch each other by their edges. The sarcode-body does not usually fill the test, the intervening space being occupied by a clear liquid, and traversed by bands of protoplasm. In the posterior part of the body is seen a large clear spherical nucleus, with a distinct dark nucleolus; and in front of this are contractile vesicles, usually two in number.¹

Coccoliths and Coccospheres.—This would seem the most appropriate place for the description of certain peculiar little bodies found very extensively diffused over the deep-sea bottom, especially abounding in the Globigerina-mud, which may be considered as chalk in process of formation. It was in the specimens of this mud brought up by the 'Cyclops' soundings in 1857 that Professor Huxley first found the *Coccoliths* (fig. 581, 1, 2) which Dr. Wallich in 1860 found aggregated in the spherical masses which he designated as 'coccospheres' (3). Regarding the gelatinous matrix in which they

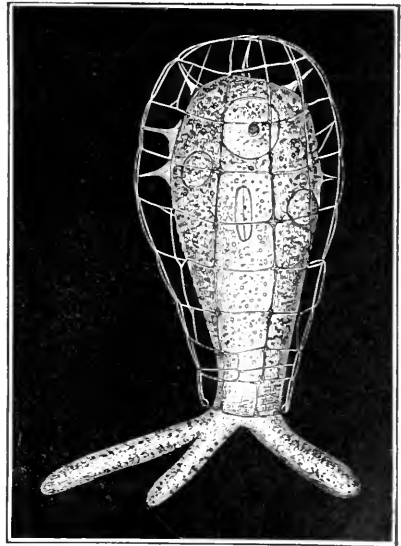

FIG. 580.—*Quadrula symmetrica*, with extended pseudopodia.

were imbedded as a new type of the *Monerozoa* described by Haeckel, having the condition of an indefinitely extended *plasmodium*, Professor Huxley proposed to designate it by the name *Bathybius*, indicative of its habitat in the depths of the sea; and this idea was accepted by Haeckel, whose representation of a living specimen of *Bathybius*, with imbedded coccoliths, is given in fig. 581, 3. The observations made in the 'Challenger' Expedition, however, have not confirmed this view; the supposed *Bathybius* being a gelatinous

¹ See especially the admirable work of Professor Leidy on the fresh-water rhizopods of the United States, 1880. It is to be regretted that its able author's time and opportunities did not permit him to follow out the life-histories of the many interesting forms which he has described and figured.

precipitate, consisting of sulphate of lime, slowly deposited in water to which strong spirit has been added. Whatever be their nature,¹ coccoliths and coccospheres are bodies of great interest; since their occurrence in chalk and in very early limestones is an additional link in the evidence of the similarity of the conditions under which they were formed to those at present prevailing on the sea-bed of the Atlantic and other oceans. Two distinct types are recognisable among the coccoliths, which Professor Huxley has designated respectively *discoliths* and *cyatholiths*. The former are round or oval discs, having a thick strongly refracting rim and a thinner internal portion, the greater part of which is occupied by a slightly opaque, cloud-like patch lying round a central corpuscle (fig. 518, *5*). In general, the 'discoliths' are slightly convex on one side, slightly concave on the other, and the rim is raised into a prominent ridge on the more

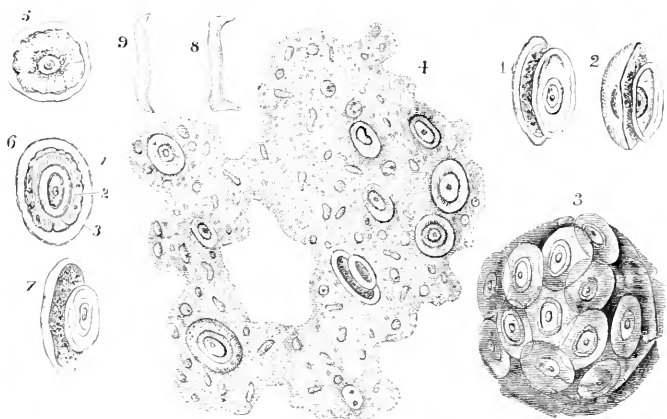

FIG. 581.—*Coccoliths* and *Coccospheres*: 1, 2, 7, cyatholiths seen obliquely; 3, coccosphere with imbedded cyatholiths; 4, coccoliths imbedded in supposed protoplasmic expansion; 5, discolith seen in front view; 6, cyatholith seen in front view, showing (1) central corpuscle, (2) granular zone, (3) transparent outer zone; 8, 9, discoliths seen edgewise.

convex side; so that when viewed edgewise they present the appearances shown in figs. 8, 9. Their length is ordinarily between $\frac{1}{40000}$ th and $\frac{1}{50000}$ th of an inch; but it ranges from $\frac{1}{27000}$ th to $\frac{1}{11000}$ th. The largest are commonly free, but the smallest are generally found imbedded among heaps of granular particles, of which some are probably discoliths in an early stage of development. The 'cyatholiths,' also, which have the general appearance of a cup and saucer, have, when full grown, an oval contour, though they are often circular when immature. They are convex on one face and flat or concave on the other; and when left to themselves they lie on one or other of these two faces. In either of these aspects they seem to be composed of two concentric zones (fig. 6, 2, 3) surrounding an oval thick-walled central corpuscle (1), in the centre of which is a clear space some-

¹ Messrs. Murray and Blackman have, in a preliminary notice (*Proc. Roy. Soc.*, London, lxiii, 1898, p. 269), suggested that the *Coccospheraceae* are unicellular Algae.

times divided into two. The zone (2) immediately surrounding the central corpuscle is usually more or less distinctly granular, and sometimes has an almost bead-like margin. The narrower outer zone (3) is generally clear, transparent, and structureless, but sometimes shows radiating striæ. When viewed sidewise or obliquely, however, the 'cyatholiths' are found to have a form somewhat resembling that of a shirt-stud (figs. 1, 2, 7). Each consists of a lower plate, shaped like a deep saucer or watch-glass; of a smaller upper plate, which is sometimes flat, sometimes more or less concavo-convex; of the oval, thick-walled, flattened corpuscle, which connects these two plates together at their centres; and of an intermediate granular substance which more or less completely fills up the interval between the two plates. The length of these cyatholiths ranges from about $\frac{1}{1600}$ th to $\frac{1}{8000}$ th of an inch, those of $\frac{1}{3000}$ of an inch and under being always circular. It appears from the action of dilute acids upon the coccoliths that they must mainly consist of calcareous matter, as they readily dissolve, leaving scarcely a trace behind. When the cyatholiths are treated with very weak acetic acid, the central corpuscle rapidly loses its strongly refracting character; and there remains an extremely delicate, finely granular membranous framework. When treated with iodine they are stained, but not very strongly, the intermediate substance being the most affected. Both discoliths and cyatholiths are completely destroyed by strong hot solutions of caustic potash or soda. The coccospheres (fig. 3) are made up by the aggregation of bodies resembling 'cyatholiths' of the largest size in all but the absence of the granular zone; they sometimes attain a diameter of $\frac{1}{760}$ th of an inch. What is their relation to the coccoliths, and under what conditions these bodies are formed, are questions whereon no positive judgment can be at present given.

SPOROZOA.

The term Sporozoa was applied by Leuckart to a group of protozoic animals of which the well-known Gregarinida, the Coccididea, the Hemosporidia, the Myxosporidia, and the Sarcosporidia¹ are the chief divisions. They are especially characterised by the peculiarities of their mode of reproduction, in which a period of encystation (which may or may not be preceded by conjugation) is succeeded by the breaking up of the contained protoplasm into a large number of small 'spores,' the products of which become intracellular parasites.

The Gregarinida lead a parasitic life, and may often be met with in the intestinal canal or other cavities of earthworm, insects, &c., and sometimes in that of higher animals. An individual *Gregarina* essentially consists of a large single cell, usually more or less ovate in form, and sometimes attaining the extraordinary length of *two-thirds of an inch*.² A sort of beak or proboscis frequently projects from one extremity; and in some instances this is furnished with a

¹ Consult the memoir by Dr. R. Blanchard in *Bull. Soc. Zool. France*, x, p. 244.

² See Prof. Ed. Van Beneden on *Gregarina gigantea* (found in the intestinal canal of the lobster) in *Quart. Journ. Microsc. Sci.*, n.s. vol. x, 1870, p. 51, and vol. xi, p. 242.

circular row of hooklets, closely resembling that which is seen on the head of *Tænia*. There is here a much more complete differentiation between the cell-membrane and its contents than exists either in *Actinophrys* or in *Amæba*; and in this respect we must look upon *Gregarina* as representing a decided advance in organisation. Being nourished upon the juices already prepared for it by the digestive operations of the animal which it infests, it has no need of any such apparatus for the introduction of solid particles into the interior of its body, as is provided in the 'pseudopodia' of the rhizopods and in the oral cilia of the Infusoria. Within the cavity of the cell, whose contents are usually milk-white and minutely granular, there is generally seen a pellucid nucleus; and when, as often happens,



FIG. 582.—Cyst of *Monocystis agilis*, the Gregarinid of the earthworm (750 diams.), showing ripe chlamydospores and complete absence of any residual protoplasm in the cyst. (After Professor Ray Lankester.)

the cell undergoes duplicative subdivision, the process commences in a constriction and cleavage of this nucleus. The membrane and its contents, except the nucleus, are soluble in acetic acid. The movements of the body are of very various kinds; there is a forward movement which may be due, as suggested by Lankester, to the undulations of the body. The cell itself may undergo contraction, and consequent change in form, which may, or may not, be accompanied by locomotion; circular constrictions may extend along the body; or the cell may bend on itself and again straighten out. By Van Beneden the contractility of the cell is localised in a layer of the

ectoplasm, the so-called 'myocyte' which he has found to consist of a layer of contractile fibrils. When the process of encystation commences we find that, whatever the original form of the body may be, it becomes globular, ceases to move, and becomes invested by a structureless 'cyst,' within which the substance of the body undergoes a singular change. The nucleus disappears, and the sarcodic mass breaks up into a series of globular particles, which gradually resolve themselves (as shown at *b, c, d, e*, fig. 583) into forms very like those of *Navicula*, and a cyst more advanced, and greatly magnified, is shown in fig. 582. These 'pseudo-navicellæ' or 'spores,' as it is better to call them, are set free in time by the bursting of the capsule that incloses them; and they develop themselves into a new generation of Gregarinae, first passing through an

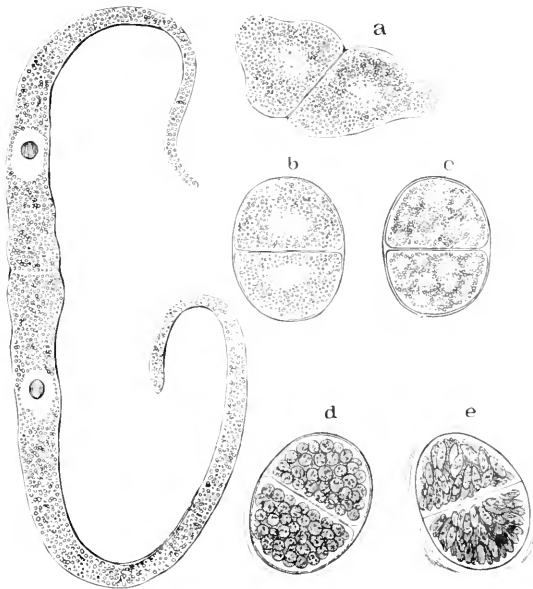

FIG. 583.—*Gregarina Senuridis*, from testis of *Tubifex rivulorum*, two adults uniting; *a*, succeeding stage; *b*, encystation stage; in *c* and *d* the contents are seen breaking up; in *e* the characteristic pseudo-navicellar form has been acquired by the spores. (After Kùlliker.)

amœba-like stage. A sort of 'conjugation' has been seen to take place between two individuals whose bodies, coming into contact with each other by corresponding points, first became more globular in shape, and are then encysted by the formation of a capsule around them both; the partition-walls between their cavities disappear; and the substance of the two bodies becomes completely fused together. But as the products of this 'zygosis' are the same as that of the ordinary encysting process, there seems no sufficient reason

for regarding it, like the 'conjugation' of protophytes, as a true generative act.

The *Coccidia* (fig. 584) are Sporozoa which look like minute ova, and which are found resting *within* the cells of their hosts; the young, developed from spores, are falciform in shape, and, moving about actively, are able to penetrate fresh cells. They have been found in the epithelium of the intestine of various forms, and in the liver of vertebrates. Some parasites found in the blood (*Hæmamebidæ*), such as *Drepanidium ranarum*, Lankester, are allied to the *Coccidia*, but are distinguished by having naked spores. Their chief interest lies perhaps in their relation to various forms of malaria.¹ Among

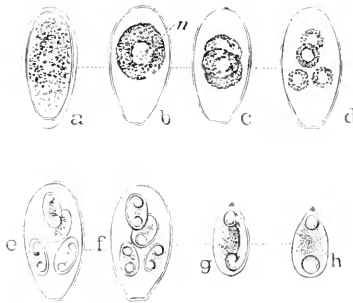

FIG. 584. —*Coccidium oriforme* (Lankester) from the liver of the rabbit: *a*, cyst just formed; *b*, condensed contents, the outer envelope has disappeared; *c*, contents divided into four sporoblasts; *d*, the sporoblasts have become rounded and clearer internally; *e* and *f*, formation of the falciform germ; *g* and *h*, spores more highly magnified—*g* from the side, *h* from in front.

the Myxosporidia is *Glycæa*, the cause of the silkworm disease. The Sarcosporidia are only known from the striped muscular tissue of some vertebrates.

Of the imperfectly known *Myxosporidia* it may be said that their spores are the bodies which are known as 'sporospersms'; while the bodies observed by Rainey and others, and wrongly regarded as the cause of the cattle plague, are sarcocystids which live in the muscular fibre of mammals.

¹ More and more interest is being taken in this subject, and some of the results of recent researches are of great interest and importance. Malaria appears to be due to a *Hæmamebid* which develops in gnats of the genus *Anopheles*; when they arrive in the human subject they appear as minute amoebula which live in or on the red blood corpuscles; they give rise to sporocytes which multiply indefinitely, or to sexual gametocytes which undertake their sexual functions as soon as they enter the stomach of gnats. See Ross and Fielding Ould, *Quart. Journ. Micro. Sci.* xliii. (1900) p. 571, and a very interesting 'Note on the Morphological Significance of the Various Phases of *Hæmamebidæ*,' by E. Ray Lankester, tom. cit. p. 581. The student should also consult M. A. Labbé's 'Recherches Zoologiques, Cytologiques et Biologiques sur les Coccidies,' in *Arch. Zool. Expér.* 1896, p. 517 *et seq.*, and Dr. Wasielewski's *Sporozoocenkunde*, Jena, 1896. A detailed bibliography will be found in Prof. G. Schneidmühl's *Die Protozoen als Krankheitsreger*, Leipzig, 1898. The various Memoirs of Grassi, Laveran, and Léger may be profitably studied.

CHAPTER XIII

ANIMALCULES—INFUSORIA AND ROTIFERA

NOTHING can be more vague or scientifically inappropriate than the title *Animalcules*; since it only expresses the small dimensions of the beings to which it is applied, and does not indicate any of their characteristic peculiarities. In the infancy of microscopic knowledge, it was natural to associate together all those creatures which could only be discerned at all under a high magnifying power, and whose internal structure could not be clearly made out with the instruments then in use; and thus the most heterogeneous assemblage of plants, zoöphytes, minute crustaceans, larvæ of worms, molluscs, &c., came to be aggregated with the true animalcules under this head. The class was being gradually limited by the removal of all such forms as could be referred to others; but still very little was known of the real nature of those that remained in it until the study was taken up by Professor Ehrenberg, with the advantage of instruments which had derived new and vastly improved capabilities from the application of the principle of achromatism. One of the first and most important results of his study, and that which has most firmly maintained its ground, notwithstanding the overthrow of Professor Ehrenberg's doctrines on other points, was the separation of the entire assemblage into two distinct groups, having scarcely any feature in common except their minute size, one being of very *low*, and the other of comparatively *high* organisation. On the lower group he conferred the designation of *Polygastrica* (many-stomached), in consequence of having been led to form an idea of their organisation which the united voice of the most trustworthy observers now pronounces to be erroneous; and as the retention of this term must tend to perpetuate the error, it is well to fall back on the name *Infusoria*, or infusory animalcules, which simply expresses their almost universal prevalence in infusions of organic matter. To the higher group Professor Ehrenberg's name *Rotifera* or *Rotatoria* is, on the whole, very appropriate, as significant of that peculiar arrangement of their cilia upon the anterior parts of their bodies, which, in some of their most common forms, gives the appearance (when the cilia are in action) of wheels in revolution; the group, however, includes many members in which the ciliated lobes are so formed as not to bear the least resemblance to wheels. In their general organisation these 'wheel-animalcules' stand at a much higher level than the unicellular *Infusoria*, but it

is difficult to decide what is their relationship to other groups of animals. Notwithstanding the wide zoological separation between these two kinds of animalcules, it seems most suitable to the plan of the present work to treat of them in connection with one another; since the microscopist continually finds them associated together, and studies them under similar conditions.

SECTION I.—INFUSORIA.

This term, as now limited by the separation of the *Rhizopoda* on the one hand, and of the *Rotifera* on the other, is applied to a far smaller range of forms than was included by Professor Ehrenberg under the name of 'polygastric' animalcules. For a large section of these, including the *Desmidiaceæ*, *Diatomaceæ*, *Volvocineæ*, and many other protophytes, have been transferred by general (though not universal) consent to the vegetable kingdom. And it is not impossible that many of the reputed *Infusoria* may be but larval forms of higher organisms, instead of being themselves complete animals. Still an extensive group remains, of which no other account can at present be given than that the beings of which it is composed go through the whole of their lives, so far as we are acquainted with them, in a grade of existence which is essentially protozoic, each individual apparently consisting of but a *single cell*, though its parts are often so highly differentiated as to represent (only, however, by way of *analogy*) the 'organs' of the higher animals after which they are usually named.

Among the *ciliate* Infusoria, which form not only by far the largest, but also the most characteristic division of the group, there is probably none save such as are degraded by parasitic habits which has not a *mouth*, or permanent orifice for the introduction of food, which is driven towards it by ciliary currents; while a distinct *anal* orifice, for the ejection of the indigestible residue, is not infrequently present. The mouth is often furnished with a *dental* armature, and leads to an *oesophageal canal*, down which the food passes into the digestive cavity. This cavity is still occupied, however, as in rhizopods, by the *endosarc* of the cell; but instead of lying in mere vacuoles formed in the midst of this, the food-particles are usually aggregated, during their passage down the oesophagus, into minute pellets, each of which receives a special investment of firm protoplasm, constituting it a *digestive vesicle* (fig. 589); and these go through a sort of circulation within the cell-cavity.

The 'contractile vesicles,' again, attain a much higher development in this group, and are sometimes in connection with a network of canals channelled out in the 'ectosarc;' while their rhythmical action resembles that of the *circulatory* and *respiratory* apparatus of higher animals. There is ample evidence, also, of the presence of a specially contractile modification of the protoplasmic substance, having the action (though not the structure) of *muscular* fibre; and the manner in which the movements of the active free-swimming Infusoria are directed—so as to avoid obstacles and find out passages—

seems to indicate that another portion of their protoplasmic substance must have to a certain degree the special endowments which characterise the *nervous* systems of higher animals. Altogether, it may be said that in the ciliate Infusoria *the life of the single cell finds its highest expression*.¹

Before proceeding to the description of the *ciliate* Infusoria, however, it will be of advantage to notice two smaller groups—the *flagellate* and the *sactorial*—which, on account of the peculiarities of their structure and actions, are now ranked as distinct, and of whose ‘unicellular’ character there can be no reasonable doubt, since they are, for the most part, ‘closed’ cells, scarcely distinguishable morphologically from those of protophytes.

Flagellata.—Our knowledge of this tribe has been greatly augmented in recent years, not only by the discovery of a great variety of new forms, but still more by the careful study of the life-history of several among them. The *monads*, properly so called,² which are amongst the smallest living things at present known, are its simplest representatives; but it also includes organisms of much greater complexity; and some of its composite forms seem to have a very remarkable relation to sponges. The *Monas levis*, long familiar to microscopists as occurring in stagnant waters and infusions of decomposing organic matter, is a spheroidal particle of protoplasm, from $\frac{1}{2000}$ th to $\frac{1}{5200}$ th of an inch in diameter, enclosed in a delicate hyaline investment or ‘ectosarc,’ and moving freely through the water by the lashing action of its slender *flagellum*, whose length is from three to five times the diameter of the body. Within the body may be seen a variable number of vacuoles; and these are occasionally occupied by particles distinguishable by their colour, which have been introduced as food. These seem to enter the body, not by any definite mouth (or permanent opening in the ectosarc), but through an aperture that forms itself in some part of the oral region near the base of the flagellum. In some true *Monadina* neither nucleus nor contractile vesicle is distinguishable, but in the majority a nucleus can be clearly seen. The life-history of several simple *Monadina* presenting themselves in infusions of decaying animal matter (a cod’s head being found the most productive material) has been studied with admirable perseverance

¹ The doctrine of the unicellular nature of the *Infusoria* has been a subject of keen controversy amongst zoölogists from the time when it was first definitely put forward by Von Siebold (*Lehrbuch der vergleich. Anat.*, Berlin, 1845) in opposition to the then paramount doctrine of Ehrenberg as to the complexity of their organisation, which had as yet been called in question only by Dujardin (*Hist. Nat. des Infusoires*, Paris, 1841). Of late, however, there has been a decided convergence of opinion in the direction above indicated; which has been brought about in great degree by the contrast between the *protozoic* simplicity of the reproductive and developmental processes in Infusoria, as, for example, shown by Dallinger and Drysdale, and by the former alone in the life-histories of the Sappophytes, and the complexity of the like processes as seen in even the lowest of the *Metazoa*, which has been specially and forcibly insisted on by Hæckel (*Zur Morphologie der Infusorien*, *Jenaische Zeitschr.* Bd. vii. 1873). An excellent summary of the whole discussion was given by Professor Allman in his Presidential Address to the Linnean Society in 1875.

² The family *Monadina* of Ehrenberg and Dujardin consists of an aggregate of forms now known to be of very dissimilar nature, many of them belonging to the vegetable kingdom

and thoroughness by Messrs. Dallinger and Drysdale, of whose important observations a general summary will now be given.¹

The present Editor adopts the lead of Dr. Carpenter, in arranging the *saprophytic* monad forms in this place in the organic series. They possess features that ally them, as has been already suggested, to the vegetable series, and indicate affinities with certain Nostocaceæ and the Bacteria.

There are some reasons for looking at the saprophytic monad forms as a possibly degraded but still specialised group. In common with saprophytic Bacteria, they are specifically related to the setting up and carrying on of decomposition in dead organic tissues. In organic infusions and films of gelatine, or tubes of agar-agar, the bacterial forms are, as a rule, enough to set up and carry on the destructive ferment. But where great masses of tissue are decomposing, the presence of the larger monad forms is certain and inevitable; and by them, accompanied by the Bacteria, the processes of fermentative rotting are carried to the end.

It is their morphology which points to the Flagellata, and we should incline to consider them a degenerate, and by degeneration specialised form of the Flagellata if they—about eight or nine distinct forms in this latitude—belong properly to the Flagellata at all.

The simplest of these organisms is represented in fig. 1, Plate XV. A. It has been named by Saville Kent *Monas Dallingeri*, and has by comparison a simple life-history. As it is with the entire group, all is subservient to rapidity of multiplication; and there are two methods in which this is effected. The first and commonest is by fission; fig. 1, A, represents the normal form of the organism. It has a long diameter of about the $\frac{1}{6000}$ th of an inch, and has great ease and grace, and relative power of movement. In a certain stage of its history as it swims freely there suddenly appears a constriction across its body, as in fig. 2. This is at once accompanied by an apparent effort of the opposite flagella to pull against each other; the consequence is a very rapid stretching of a neck of sarcode between two halves of the body, as at fig. 3. This becomes longer, as at 4, and attains the length of two flagella as at 5, when the two dividing halves approach and mutually dart from each other, snapping the connecting fibre of sarcode in the middle, so that two perfect forms are set free, as in 6 and 7.

This, in the course of from two to three minutes, is once more begun and carried on in each half successively, so that there is an increase of the form by this means in rapid geometric ratio.

But this is an exhaustive process vitally, for after a period varying from eight to ten days there always appear in the unaltered and unchanged field of observation normal forms, with a remarkable diffluent or amoeba-like envelope, as seen in figs. 8 and 9. A. These

¹ See their successive papers in the *Monthly Microsc. Journ.* vol. x. 1873, pp. 53, 245; vol. xi. 1874, pp. 7, 69, 97; vol. xii. 1874, p. 261; and vol. xiii. 1875, p. 185; and *Proceed. Roy. Soc.* vol. xxvii. 1878, p. 332. But especially for the latest results with recent objectives, *Journ. Roy. Micro. Soc.* vol. v. 1885, p. 177; vol. vi. p. 193; vol. vii. p. 185; vol. viii. p. 177.

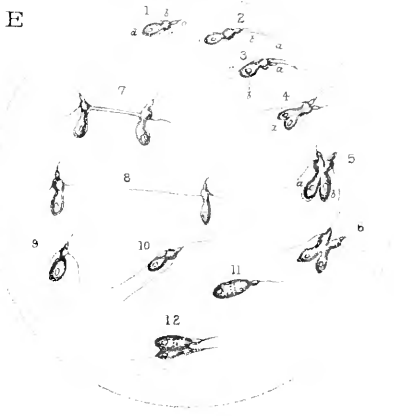
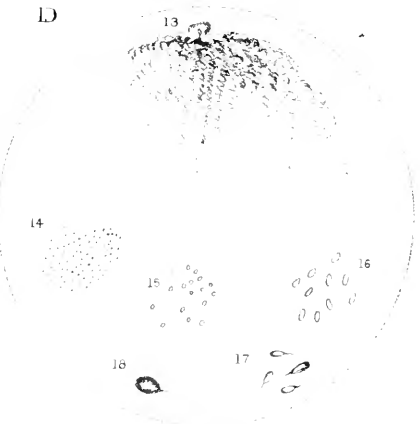
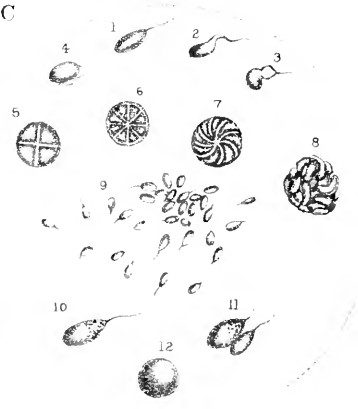
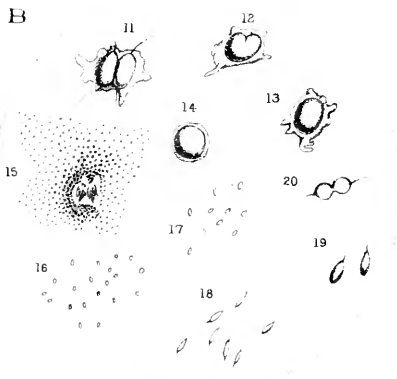
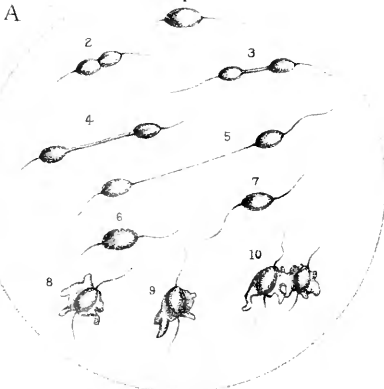

J. H. Dalmeyer del. ad nat.

A. S. Huth, L. Sc. London

sometimes swim and sometimes creep, amoeba-like, by pseudopodia; but directly the diffuent sarcode of one touches that of another they at once melt together, as in fig. 10, A. This leads to the rapid approach of the oval bodies of the two organisms, as in fig. 11, B, resulting in their fusion, as in figs. 12, 13, 14, and a still condition of the sac (fig. 14) for a period of not less than six hours; when it bursts, as seen in fig. 15, pouring out an immense host of exquisitely minute *spores*, as shown in fig. 15. These are opaque or semi-opaque, but by observation upon them at a temperature of 65° to 70° Fahr., they in the course of thirty minutes become transparent, elongate, as in figs. 16 and 17, and, continuing to grow, assume the conditions and sizes represented in figs. 18 and 19; and we were able to trace them through all their changes of growth from the spore into the adult condition, as at fig. 20, until they entered upon and passed through the self-division into two described and figured in A.

The next form, though even more simple in appearance, has a much more complex morphological history. It is seen in its normal form in fig. 1, C. It has but one flagellum, and, as we believe, on that account has a much more restricted power of movement. It is from the $\frac{1}{50000}$ th to the $\frac{1}{70000}$ th of an inch in long diameter. In its motion at one stage of its life its oval body becomes uncertain in form, as seen in 2, 3, 4, C; but when this has continued for not more than a minute, the flagellum falls in upon the body, as in 4, and the organism becomes perfectly still. In this condition, after a space ranging from ten to twenty minutes, two white bars at right angles suddenly appear, as in fig. 5; this is almost immediately followed by another and a similar one at right angles to the first, as in fig. 6. Then the circumference of the flattened sphere twists, leaving the centre unaffected, so that the body assumes a turbinated appearance as seen in fig. 7. After this the interior substance breaks up, and becomes a knot of slightly moving but compact forms, as in fig. 8; which remains in this state for from fifteen to twenty minutes, and then becomes dissociated, as in fig. 9; so that we have here a complex form of multiple partition, giving rise to enormous numbers, because, although much smaller than the form in which they arose, they consume and assimilate food all over, and are simply swimming in their pabulum, and so rapidly reach the normal size, when they each enter upon and pass through a similar process.

But here also at certain periods there appeared forms that inaugurate distinctly genetic processes. A form like fig. 10, C, appears, larger than the normal form, and always mottled in the part nearest the flagellum. These forms rapidly attached themselves to the normal forms, as seen in fig. 11, which resulted in a blending of the two as they swam together, until 'either was melted into other;' and a still sac, shown in fig. 12, resulted.

This remained from thirty to thirty-six hours absolutely inert; but at the expiration of that time it burst, as seen in fig. 13, D, and poured out an enormously diffusive fluid, which as it flowed into the surrounding water appeared like a denser fluid, diffusing itself through one of less density; but no spores were at this stage at all apparent. It

was only after much effort that we at last, by keeping the finest of our lenses near the mouth of the empty sac, were able to discover, where before nothing was visible, the appearance of minute specks, which became larger and larger, growing as seen in 14, 15, 16, 17, until the adult size was reached, as at 18, and by the act of multipartition on the part of one of these, watched from its first disclosure by the microscope, we were able to re-enter the cycle of its life-history.

The third form, which we may here consider fully, so as to present a good group of histories typical in their presentation of the morphology of the whole of the monad-saprophytes as we at present know them, is given in E and F, Plate XV.

The monad has been named by S. Kent *Dallingeria Drysdali*. The form more recently and completely studied by Mr. Dallinger—with all the advantages derived from trained experience, and under objectives of the highest quality and greatest magnifying power—is seen in its normal shape in fig. 1, is a long oval, slightly constricted in the middle, and having a kind of pointed neck (*a*), from which proceeds a flagellum about half as long again as the body. From the shoulder-like projections behind this (*b, c*) arise two other long and fine flagella, which are directed backwards. The sarcode-body is clear, and apparently structureless, with minute vacuoles distributed through it; and in its hinder part a nucleus (*d*) is distinguishable. The extreme length of the body is seldom more than the $\frac{1}{40,000}$ th of an inch, and is often the $\frac{1}{60,000}$ th. This monad swims with great rapidity, its movements, which are graceful and varied, being produced by the action of the flagella, which can not only impel it in any direction, but can suddenly reverse its course or check it altogether. But besides this free-swimming movement, a very curious 'springing' action is performed by this monad when the decomposing organic matter of the infusion is breaking up, the process of disintegration being apparently assisted by it. The two posterior flagella anchor themselves and coil into a spiral, and the body then darts forwards and upwards, until the anchored flagella straighten out again, when the body falls forward to its horizontal position, to be again drawn back by the spiral coiling of the anchored flagella. This monad multiplies by longitudinal fission, the first stage of which is the splitting of the anterior flagellum into two (fig. 2, *a, b*), and a movement of the nucleus (*c*) towards the centre. In the course of *from thirty to sixty seconds* the fission extends down the neck (fig. 3, *a*); a line of division is also seen at the posterior end (*c*), and the nucleus (*b*) shows an incipient cleavage. In a few seconds the cleavage-line runs through the whole length of the body, the separation being widest posteriorly (fig. 4, *a*); and in from one to four minutes the cleavage becomes almost complete (fig. 5), the posterior part of the body, with the two halves (*a* and *b*) of the original nucleus, being now quite disconnected, though the anterior parts are still held together by a transverse band of sarcode, as seen in fig. 6, which continues to rapidly elongate, as in fig. 7, and becomes the length of two side flagella, as in fig. 8. The forms then approach and rapidly recede from each other, snapping the cord, as in figs. 9 and 10. In this way *two* forms exist instead of one; and each of these almost im-

mediately enters upon and passes through the same process of fission, which from first to last is completed in from four to seven minutes; and being repeated at intervals of a few minutes, this mode of multiplication produces a rapid increase in the number of the monads.

Such fission does not, however, continue indefinitely, for after a successive series of fissions, followed in one of the divided bodies for eight or nine hours, certain individuals do not again enter upon the process of fission, but undergo a peculiar change, which shows itself first in the absorption of the two lateral flagella and the great development of the nucleus, and afterwards in the formation of a transverse granular band across the middle of the body (fig. 11, E). One of these altered forms, swimming into a group in the 'springing' state, within a few seconds firmly attaches itself to one of them, which at once unanchors itself, and the two swim freely and vigorously about, shown in fig. 12, generally for from thirty-five to forty-five minutes. Gradually, however, a 'fusion' of the two bodies and of their respective nuclei takes place, the two trailing flagella of the 'springing' form being drawn in (fig. 13, F): and in a short time longer the two anterior flagella also disappear, and all trace of the separate bodies is lost, the nuclei vanish, and the resultant is an irregular amoeboid mass (fig. 14), which gradually acquires the smooth, distended, and 'still' condition represented in fig. 14, *a*. This is a cyst filled with reproductive particles of such extraordinary minuteness that, when emitted from the ends of the cyst (fig. 15, *a*) after the lapse of four or five hours, they can only be distinguished under an amplification of 5,000 diameters, with perfect central illumination, *i.e.* the full cone of a large-angled condenser. Yet these particles, when continuously watched, are soon observed to enlarge and to undergo elongation (figs. 16, 17, 18, 19, 20), and within two hours after their emission from the sac the anterior flagellum, and afterwards the two lateral flagella (fig. 19), can be distinguished. Slight movements then commence, the neck-like protrusion shows itself, and in about half an hour more the regular swimming action begins. About four hours after the escape of its germ from the sac, the monad acquires its characteristic form (fig. 21), though still only one-half the length of its parent: but this it attains in another hour, and the process of multiplication by fission, as already described, commences very soon afterwards. There can be no reasonable doubt that the 'conjugation' of two individuals, followed by the transformation of their fused bodies into a sac filled with reproductive germs, is to be regarded (as in protophytes) in the light of a true *generative* process: and it is interesting to observe the indication of sexual distinction here marked by the different states of the two conjugating individuals. There is every reason to believe that *the entire life-cycle* of this monad has thus been elucidated; and it will now be sufficient to notice the principal diversities observed by Messrs. Dallingier and Drysdale in the life-cycles of the other monadine forms which they have studied.

The *bi-flagellate* or 'acorn' monad of the same observers (identified by Kent with the *Polytoma acella* of Ehrenberg) presents some remarkable peculiarities in its mode of reproduction. Its binary fission extends only to the protoplasmic substance of its body, leaving

its envelope entire; and by a repetition of the process, as many as sixteen segments, each attaining the likeness of the parent, are seen thus inclosed, their flagella protruding through the general investment. This compound state being supposed by Ehrenberg to be the normal one, he named it accordingly. But the parent-cyst soon bursts, and sets free the contained 'macro-spores,' which swim about freely, and soon attain the size of the parent. Again, the posterior part of the body of certain individuals shows an accumulation of granular protoplasm, giving to that region a roughened acorn-cup-like aspect; the bursting of the projection, while the creature is actively swimming through the water, sets free a multitude of indefinitely shaped granular fragments, within each of which a minute bacterium-like corpuscle is developed; and this, on its release, acquires in a few hours the size and form of the original monad. This process seems analogous to the development of 'microspores' among protophytes by the direct breaking up of the protoplasm. It is, like the previous process, non-sexual or *gonidial*, the true generative process consisting here, as in the preceding cases, in the 'conjugation' of two individuals, with the usual results.

The *hooked monad* (*Heteromita uncinata*, Kent) is another bi-flagellate form, usually ovate with one end pointed, and from $\frac{1}{3000}$ th to $\frac{1}{4000}$ th of an inch in length, being distinguished from the preceding by the peculiar character of its flagella, of which the one that projects forwards is not more than half the length of the body, and is permanently hooked, while the other, whose length is about twice that of the body, is directed backwards, flowing in graceful curves. Its motion consists of a succession of springs or jerks rapidly following each other, which seems produced by the action of the hooked flagellum. Multiplication takes place by *transverse* fission, and continues uninterruptedly for several days. A difference then becomes perceptible between larger and smaller individuals, the former being further distinguished by the presence of what seems to be a contractile vesicle in the anterior part of the body. Conjugation occurs between one of the larger and one of the smaller forms, the latter being, as it were, absorbed into the body of the larger; and the resulting product is a spherical cyst, which soon begins to exhibit a cleavage-process in its interior. This continues until the whole of its sarcode substance is subdivided into minute oval particles, which are set free by the rupture of the cyst, and of which each is usually furnished with a single flagellum, by whose lashing movement it swims freely. These germs speedily attain the size and form of the parent, and then begin to multiply by transverse fission, thus completing the 'genetic' cycle.

The *calycine monad* of the same observers (*Tetramitus rostratus*, Perty) has a length of from $\frac{1}{5000}$ th to $\frac{1}{10000}$ th of an inch, and a compressed body tapering backwards to a point. Its four flagella (which constitute its generic distinction) arise nearly together from the flattened front of the body, and its swimming movement is a graceful gliding. Near the base of the flagella are a pair of contractile vesicles, and further behind is a large nucleus. Multiplication takes place by longitudinal fission, which is preceded by a change to a semi-

ameboid state. This gives place to a more regular pear-like form, the four flagella issuing from the large end; and the fission commences at their base, two pairs being separated by the cleavage-plane. The nucleus also undergoes cleavage, and its two halves are carried apart by the backward extension of the cleavage. The two half-bodies at last remain connected only by their hinder prolongations, which speedily give way, and set them free. Each, however, has, as yet, only two flagella; but these speedily fix themselves by their free extremities, undergo a rapid vibratory movement, and in the course of about two minutes split themselves from end to end. A still more complete change into the ameboid condition, in which the creature not only moves, but also feeds, like an *Amaba* (devouring all the living and dead Bacteria in its neighbourhood), occurs previously to 'conjugation;' and this takes place between two of the ameboid forms, which begin to blend into each other almost immediately upon coming into contact. The conjugated bodies, however, swim freely about for a time, the two sets of flagella apparently acting in concert. But by the end of about eighteen hours the fusion of the bodies and nuclei is complete, the flagella are lost, and a spherical distended sac is then formed, which, in a few hours more without any violent splitting or breaking up, sets free innumerable masses of reproductive particles. These under a magnifying power of 2,500 diameters can be just recognised as oval granules, which rapidly develop themselves into the likeness of their parents, and in their turn multiply by duplicative fission, thus completing the 'genetic' cycle.

One of the most important researches thus ably prosecuted by Messrs. Dallinger and Drysdale has reference to the temperatures respectively endurable by the adult or developed forms of these monads, and by their reproductive germs. A large number of experiments upon the several forms now described indubitably led to the conclusion that all the *adult* forms, as well as all those which had reached a stage of development in which they can be distinguished from the reproductive granules, are utterly destroyed by a temperature of 150° Fahr. But, on the other hand, the reproductive granules emitted from the cysts that originate in 'conjugation' were found capable of sustaining a *fluid* heat of 220°, and a *dry* heat of about 30° more, those of the Cercomonad surviving exposure to a *dry* heat of 300° Fahr. This is a fact of the highest interest in its bearing on the question of 'spontaneous generation,' or abiogenesis; since it shows that germs capable of surviving desiccation may be everywhere diffused through the air, and may, on account of their extreme minuteness (as they certainly do not exceed $\frac{1}{2000000}$ th of an inch in diameter), altogether escape the most careful scrutiny and the most thorough cleansing processes: while (2) their extraordinary power of resisting heat will prevent these germs from being killed, either by boiling, or by dry-heating up to even 300° Fahr.¹

Beyond these facts others of some importance, as well as a new

¹ Descriptions of the special apparatus used by Messrs. Dallinger and Drysdale in their researches will be found in *Monthly Microsc. Journ.* vol. xi. 1874, p. 97; *ibid.* vol. xv. 1876, p. 165; and *Proceed. Roy. Soc.* vol. xxvii. 1878, p. 343.

saprophytic organism¹ of special character, have been discovered during a recent period. But it will be of more moment here to note to what an extent in this series of observations *the new homogeneous objectives, especially in their apochromatic form*, have been successfully employed in enlarging the area of knowledge.

The present Editor has gone carefully over the greater part of the work, revising all the critical points with the best apochromatic objectives, and the homogeneous forms of achromatics with an aperture of 1.50 and with a clear demonstration of the immensely greater ease with which the work could have been done had these lenses been used in the original investigation.

But the easily accessible proof of this is given in the work done by Dr. Dallinger upon the *nucleus* of the nucleated forms of these monads.

Briefly to present the facts, we may recall the part taken in the *act of fission* in the form last described (*Dallingeria Drysdali*). It will be seen by reference that it appeared to us that the *nucleus followed the processes inaugurated by the somatic sarcode*. That in fact it was a passive participator in the act of fission. This is all that can be made out *to-day* by the very lenses originally employed.

But by the employment of a $\frac{1}{12}$ th inch and $\frac{1}{20}$ th inch homogeneous of N.A. 1.50 by Powell and Lealand, and an apochromatic of $\frac{1}{12}$ th inch N.A. 1.40 by the same firm; and also by the use of the beautiful 3 mm. and 2 mm. N.A. 1.40 of Zeiss (apochromatic), it can be seen with comparative ease *that it is in the nucleus that all the activities of the body are originated*.

This may be followed from a study of Plate XVI. Fig. 1, A, represents the nucleus of the form drawn at fig. 1, E, Plate XV. In long diameter it is of an average length of $\frac{1}{20000}$ th of an inch; but instead of being a darkly refractive object, as seen with the objectives used twelve years ago, it is with the present lenses, freed from chromatic and spherical aberration, a body in the monad undergoing no process of change, an oval globule with a complicated plexus-like involution throughout its substance, as seen in fig. 6, A, Plate XVI. But directly the process of fission is to be inaugurated, we need not wait to see its first action in the splitting of the flagellum, as in fig. 2, E, Plate XV; for by observing the nucleus we discover, before any change has begun in the body-substance, that the *plexus* in the nucleus has condensed itself on *either side of the nucleus*, as in fig. 1, b, A, Plate XVI. A clear space is left at *c*, and no change has taken place in the body-sarcode, *a, a, a*. But shortly an incision takes place in the nucleus, as at *d*, fig. 2, and this is immediately *followed* by the incision *f* in the body-sarcode, and the process goes on simultaneously in nucleus and body, as in fig. 3, until the division of the nucleus is completely effected, and the total severance of the body follows.

But as soon as the nucleus is *divided*, the plexus, which has been during division, as in fig. 3, condensed over *part* of each dividing half, at once distributes itself evenly again, as in fig. 6, A, and remains so until another change is inaugurated in the form to which the nucleus belongs.

¹ *Journ. of Royal Micros. Soc.* vol. v.

A

2

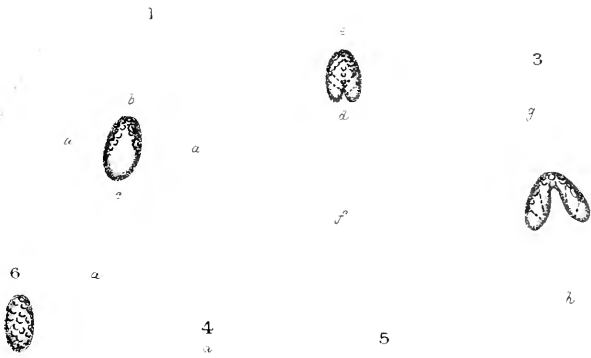

B

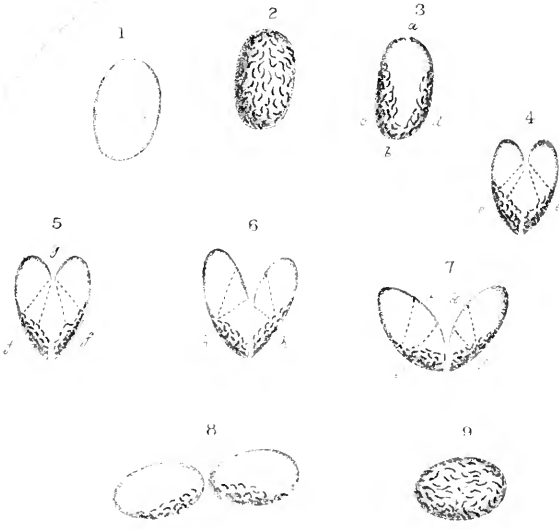

Not less remarkable is this in the *conjugation* of the same form. With the old lenses we could only discover that the end of a series of fissions had been reached by the change which came over the entire body of the terminal form seen in fig. 11, E, Plate XV. But now, before the amœboid state preceding the assumption of the condition shown in fig. 11 takes place, it can be seen that the nucleus undergoes remarkable change, for it passes from a highly refractive plexus-like condition into a large milky structureless state, and in this condition blends with one of the ordinary forms whose nucleus is of the ordinary type. The first result of fusion is seen in fig. 4, A, Plate XVI, showing only the greatly magnified blended nuclei, and where the blending between them is seen to be nearly complete at *a*, and a nucleus or nucleolus is manifest; while when the blending is more perfect there is a diffusion of this central or nucleolar body through the substance of the whole, as in fig. 5, A.

In B, Plate XVI, the nucleus only, separate from the body of the organism known as *Tetramitus rostratus*, is shown as we can reveal it with recent German and English apochromatic objectives. This entire organism is relatively large, and its nucleus will average in long diameter the $\frac{1}{10000}$ th of an inch.

Hence it affords a still better means of study. Now this organism divides by fission for a very considerable time, but at length many forms become amœboid—acting precisely as an amœba, but retaining traces of their primal form. In this state two of them blend, and as a result a sac of spore is formed from which a new generation arises.

We could with the old objectives determine nothing more than the fact that the amœboid form had supervened; but now it is easy to show that the nucleus in the body of a form not yet amœboid is undergoing change upon which the amœboid state is certain to supervene.

This is even more striking in the growth of the germ. It attains a certain size in growth, and then there is an arrest of all enlargement. This we had long observed in the earlier observations. But now with apochromatic object-glasses it has been demonstrated that this arrest of outward growth is only the signal for an internal development. Fig. 1, B, Plate XVI, shows the condition of the nucleus when there is an apparent pause in its growth. Fig. 2 shows the same nucleus after about forty minutes of external inaction, a plexus-like formation having filled its substance.

The nucleus remains thus in the mature body of the monad *until fission is to be inaugurated*, when the change seen in fig. 3, followed by the changes and deeper division seen in figs. 4, 5, 6, 7, and 8, ensue, and *after* the state of the nucleus seen in fig. 4 has been reached, the division of the entire body begins.

It thus appears that a form of *karyokinesis* takes place in the nucleus of even such lowly forms as these, and that it is the nucleus that is the seat of their intensest vitality.

A large series of more complex forms of flagellate Infusoria has been brought to our knowledge by the researches of the late

Professor James Clark (U.S.A.),¹ followed by those of Stein, Saville Kent,² and Bergh. In some of these a sort of collar-like extension of what appears to be the protoplasmic ectosarc proceeds from the anterior extremity of the body (fig. 585, *cl*), forming a kind of funnel, from the bottom of which the flagellum arises; and by its vibrations a current is produced within the funnel, which brings down food-particles to the 'oral disc' that surrounds its origin while the ectosarc seems softer than that which envelops the rest of the body. Towards the base of the collar a nucleus (*n*) is seen; while near the posterior termination of the body is a single or double contractile vesicle (*cv*). The body is attached by a pedicel proceeding from its posterior extremity, which also seems to be a prolongation of the ectosarc. These animalcules multiply by longitudinal fission; and this, in some cases (as in the genus *Monosiga*), proceeds to the extent of a complete separation of the two bodies, which henceforth, as in the

ordinary *Monadina*, live quite independently of each other. But in other forms, as *Codosiga*, the fission does not extend through the pedicel, and the twin bodies being thus held together at their bases, and themselves undergoing duplicative fission, clusters are produced which spring from common pedicels (fig. 586); and by the extension down the pedicels themselves, composite arborescent fabrics, like those of zoöphytes, are produced.



FIG. 585. — Single zooid of *Codosiga umbellata*: *cl*, collar; *n*, nucleus; *cv*, double contractile vesicle.

In another group a structureless and very transparent horny calyx, closely resembling in miniature the polype-cell of a *Campanularia*, forms itself round the body of the monad, which can retract itself into the bottom of it; and in the genus *Salpingoeca* both calyx and collar are present. In some forms of this group multiplication seems to take place, not by fission, but by gemmation; and, as among hydroid polypes, the *gemmae* may either detach themselves and live independently, or may remain in connection with their parent-stocks, forming composite fabrics, in some of which the calyces follow one another in linear series, while in others they

¹ See his memoirs in *Ann. Nat. Hist.* ser. 3, vol. xviii. 1866; *op. cit.* ser. 4, vol. i. 1868; vol. vii. 1871; and vol. ix. 1872.

² See his *Manual of the Infusoria*, 1880-82, 2 vols. and 1 vol. of plates.

take on a ramifying arrangement. While some of these composite organisms are sedentary, others, as *Dinobryon*, are free-swimming.

Two solitary flagellate forms, *Anthophysa* and *Anisonema*, may be specially noticed as presenting several interesting points of resemblance to the peculiar type next to be described, the most noticeable being the presence of a distinct mouth and the possession of two different motor organs—one a comparatively stout and stiff bristle, of uniform diameter throughout, which moves by occasional jerks, and the other a very delicate tapering flagellum, which is in constant vibratory motion. If, as appears from the observations of Bütschli, the well-known *Astasia*—of which one species has a blood-red colour, and sometimes multiplies to such an extent as to tinge the water of the ponds it inhabits—has a true mouth for the

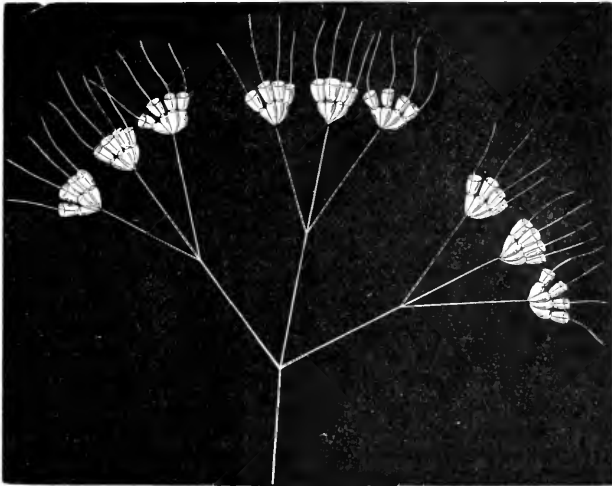

FIG. 586.—*Codosiga umbellata*: Colony-stock, springing from single pedicel tripartitely branched.

reception of its food, it must be regarded as an animal, and separated from the *Euglena* (with which it has been generally associated), the latter being pretty certainly a plant belonging to the same group as *Volvox*.¹

There can be no longer any doubt that the well-known *Noctiluca miliaris*—to which is attributable the *diffused* luminosity that frequently presents itself in British seas—is to be regarded as a gigantic type of the ‘unicellular’ *Flagellata*. This animal, which is of spheroidal form, and has an average diameter of about $\frac{1}{60}$ th of an inch, is just large enough to be discerned by the naked eye when the water in which it may be swimming is contained in a glass jar held up to

¹ See the memoir by Prof. Bütschli in *Zeitschrift f. Wissensch. Zool.* Bd. xxx., of which an abridgment (with plate) is given in *Quart. Journ. Microsc. Sci.* vol. xix. 1879, p. 63.

the light; and its tail-like appendage, whose length about equals its own diameter, and which serves as an instrument of locomotion, may be discerned with a hand-magnifier. The form of *Noctiluca* is nearly that of a sphere, so compressed that while on one aspect (fig. 587. A) its outline when projected on a plane is nearly circular, it is irregularly oval in the aspect (B) at right angles to this. Along one side of this body is a meridional groove, resembling that of a peach: and this leads at one end into a deep depression of the surface *a*, termed the *atrium*, from the shallower commencement of which the *tentacle*, *d*,¹ originates; whilst it deepens down at the base of the tentacle to the mouth, *e*. Along the opposite meridian there extends a slightly elevated ridge, *c*, which commences with the appearance of a bifurcation at the end of the atrium farthest from

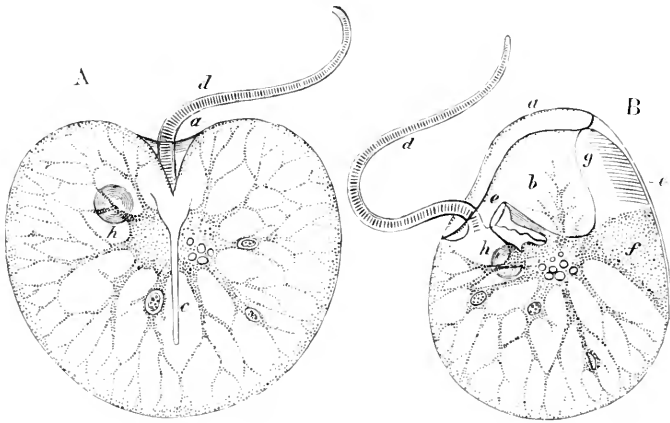

FIG. 587. — *Noctiluca miliaris* as seen at A on the aboral side, and at B on a plane at right angles to it: *a*, entrance to atrium; *b*, atrium; *c*, superficial ridge; *d*, tentacle; *e*, mouth leading to oesophagus, within which are seen the flagellum springing from its base, and the tooth-like process projecting into it from above; *f*, broad process from the central protoplasmic mass proceeding to superficial ridge; *g*, duplicature of wall; *h*, nucleus. (Magnified about 90 diameters.)

the tentacle: this is of firmer consistence than the rest of the body, and has somewhat the appearance of a rod imbedded in its walls. The mouth opens into a short oesophagus, which leads directly down to the great central protoplasmic mass; on the side of this canal, farthest from the tentacle, is a firm ridge that forms a tooth-like projection into its cavity; whilst from its floor there arises a long

¹ The organ here termed 'tentacle' is commonly designated *flagellum*; while what is here termed the *flagellum* is spoken of by most of those who have recognised it as a *cilium*. The Author agrees with M. Robin in considering the former organ, which has a remarkable resemblance to a single fibrilla of striated muscle, as one peculiar to *Noctiluca*, and the latter as the true homologue of the flagellum of the ordinary Flagellata. It is curious that several observers have been unable to discover the so-called cilium, which was first noticed by Krohn. Professor Huxley sought for it in at least fifty individuals without success; and out of the great number which he afterwards examined he did not get a clear view of it in more than half a dozen.

flagellum, which vibrates freely in its interior. The central protoplasmic mass sends off in all directions branching prolongations of its substance, whose ramifications inosculate; these become thinner and thinner as they approach the periphery, and their ultimate filaments, coming into contact with the delicate membranous body-wall, extend themselves over its interior, forming a protoplasmic network of extreme tenuity (fig. 588). Besides these branching prolongations, there is sent off from the central protoplasmic mass a broad, thin, irregularly quadrangular extension (fig. 587, B, *f*), which extends to the superficial rod-like ridge, and seems to coalesce with it; its lower free edge has a thickened border; whilst its upper edge becomes continuous with a plate-like striated structure, *g*, which seems to be formed by a peculiar duplicature of the body-wall. At one side of the protoplasmic mass is seen a spherical vesicle, *h*, of

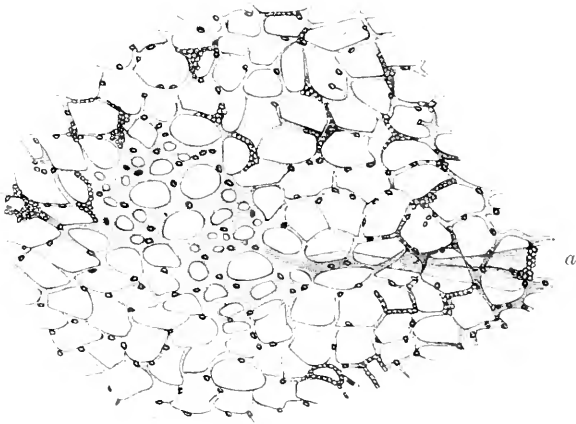

FIG. 588. — Portion of superficial protoplasmic reticulation formed by ramification of an extension *a* of central mass. (Magnified 1,000 diameters.)

about $\frac{1}{2000}$ ths of an inch in diameter, having clear colourless contents, among which transparent oval corpuscles may usually be detected. This, from the changes it undergoes in connection with the reproductive process, must be regarded as a *nucleus*.

The particles of food drawn into the mouth (probably by the vibrations of the flagellum) seem to be received into the protoplasmic mass at the bottom of the oesophagus by extensions of its substance, which inclose them in filmy envelopes that maintain themselves as distinct from the surrounding protoplasm, and thus constitute extemporised digestive vesicles. These vesicles soon find their way into the radiating extensions of the central mass (as shown in fig. 587, B), and are ensheathed by the protoplasmic substance which goes on to form the peripheral network (fig. 589). Their number and position are alike variable; sometimes only one or two are to be distinguished; more commonly from four to eight can be seen;

and even twelve or more are occasionally discernible. The place of each in the body is constantly being changed by the contractions of the protoplasmic substance, these in the first place carrying it from the centre towards the periphery of the body, and then carrying it back to the central mass, into whose substance it seems to be fused as soon as it has discharged any indigestible material it may have contained, which is got rid of through the mouth. Every part of the protoplasmic reticulation is in a state of incessant change, which serves to distribute the nutrient material that finds its way into it through the walls of the digestive vesicles; but no regular *cyclosis* (like that of plants) can be observed in it. Besides the "digestive vesicles," vacuoles filled with clear fluid may be distinguished, alike in the central protoplasmic mass, and in its extensions as is shown in the centre of fig. 587. There is no contractile vesicle.

The peculiar 'tentacle' of *Noctiluca* is a flattened whip-like filament, gradually tapering from its base to its extremity, the two flattened faces being directed respectively towards and away from the oral aperture. When either of its flattened faces is examined, it

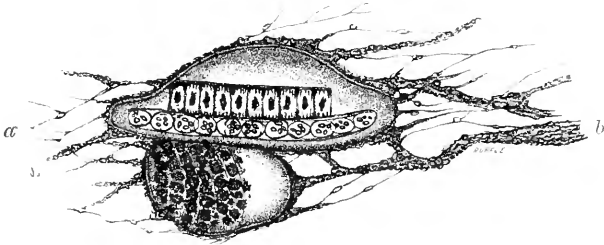

FIG. 589. — Pair of digestive vesicles of *Noctiluca* lying in course of extension of central protoplasmic mass, *a*, to form peripheral reticulation, *b*, and containing remains of Algae. (Magnified 480 diameters.)

shows an alternation of light and dark spaces, in every respect resembling those of striated muscular fibre, except that the clear spaces are not subdivided. But when looked at in profile, it is seen that between the striated band and the aboral surface is a layer of granular protoplasm. The tentacle slowly bends over towards the mouth about five times in a minute, and straightens itself still more slowly, the middle portion rising first, while the point approaches the base, so as to form a sort of loop, which presently straightens. It seems probable that the contraction of the substance forming the dark bands produces the bending of the filament; whilst, when this relaxes, the filament is straightened again by the elasticity of the granular layer.

The extreme transparency of *Noctiluca* renders it a particularly favourable subject for the study of the phenomena of phosphorescence. When the surface of the sea is rendered luminous by the general diffusion of *Noctiluca*, they may be obtained by the tow-net in unlimited quantities; and when transferred into a jar of sea-water, they soon rise to the surface, where they form a thick stratum. The slightest agitation of the jar in the dark causes an instant emission of

their light, which is of a beautiful greenish tint, and is vivid enough to be perceptible by ordinary lamp-light. This luminosity is but of an instant's duration, and a short rest is required for its renewal. A brilliant but short-lived display of luminosity, to be followed by its total cessation, may be produced by electric or chemical stimulation. Professor Allman found the addition of a drop of alcohol to the water containing specimens of *Noctiluca*, on the stage of the microscope, produced a luminosity strong enough to be visible under a half-inch objective, lasting with full intensity for several seconds, and then gradually disappearing. He was thus able to satisfy himself that the special seat of the phosphorescence is the peripheral protoplasmic reticulation which lines the external structureless membrane.

The reproduction in this interesting type is effected in various ways. According to Cienkowsky, even a small portion of the protoplasm of a mutilated *Noctiluca* will (as among rhizopods) reproduce the entire animal. Multiplication by fission or binary subdivision, beginning in the enlargement, constriction, and separation of the two halves of the nucleus, has been frequently observed. Another form of non-sexual reproduction, which seems parallel to the 'swarming' of many protophytes, commences by a kind of encysting process. The tentacle and flagellum disappear, and the mouth gradually narrows, and at last closes up; the meridional groove also disappears, so that the animal becomes a closed hollow sphere. The nucleus elongates, and becomes transversely constricted, and its two halves separate, each remaining connected with a portion of the protoplasmic network. This duplicative subdivision is repeated over and over again, until as many as 512 'gemmales' are formed, each consisting of a nuclear particle enveloped by a protoplasmic layer, and each having its flagellum. The entire aggregate forms a disc-like mass projecting from the surface of the sphere; and this mass sometimes detaches itself as a whole, subsequently breaking up into individuals; whilst, more commonly, the gemmales detach themselves one by one, the separation beginning at the margin of the disc, and proceeding towards its centre. The gemmales are at first closed monadiform spheres, each having a nucleus, contractile vesicle, and flagellum; the mouth is subsequently formed, and the tentacle and permanent flagellum afterwards make their appearance. A process of 'conjugation' has also been observed, alike in ordinary *Noctiluca* and in their closed or encysted forms, which seems to be sexual in its nature. Two individuals, applying their oral surfaces to each other, adhere closely together, and their nuclei become connected by a bridge of protoplasmic substance. The tentacles are thrown off, the two bodies gradually coalesce, and the two nuclei fuse into one. The whole process occupies about five or six hours, but its results have not been followed out.¹

¹ *Noctiluca* has been the subject of numerous memoirs, of which the following are the most recent: Cienkowsky, *Arch. f. micros. Anat.* Bd. vii. 1871, p. 131, and Bd. ix. 1873, p. 47; Allman, *Quart. Journ. Microsc. Sci.* n.s. vol. xii. 1872, p. 327; Robin, *Journ. de l'Anat. et de Physiol.* tom. xiv. 1878, p. 586; Vignal, *Arch. de Physiol.* sér. ii. tom. v. 1878, p. 415; Stein, *Der Organismus der Infusionsthierchen*, iii. 2, 1883; and Bütschli, *Morphol. Jahrbüch.* x. 1885, p. 529. For the group of which it and the Mediterranean genus *Leptodiscus* (Hertwig) are the representatives, Haeckel has suggested the name *Cystoflagellata*.

The name *Cilio-flagellata* and the definition of the group must both be altered, now that Klebs and Bütschli have shown that what was regarded as cilia in the transverse grooves of their bodies is really a flagellum; the name to be used is *Dinoflagellata*.¹ Although this group does not contain any great diversity of forms, yet it is specially worthy of notice, not only on account of the occasional appearance of some of them in extraordinary multitudes, but also for their power of forming cellulose—a property which is often thought to be particularly characteristic of plants. The *Peridinium* observed by Professor Allman in 1854 was present in such quantities that it imparted a brown colour to the water of some of the large ponds in Phenix Park, Dublin, this colour being sometimes uniformly diffused, and sometimes showing itself more deeply in dense clouds, varying in extent from a few square yards to upwards of a hundred. The animal (fig. 590, A, B) has a form approaching the spherical, with a diameter of from $\frac{1}{13,000}$ th to $\frac{1}{5,000}$ th of an inch, and is partially divided into two hemispheres by a deep equatorial furrow, *a*, whilst the flagellum-bearing hemisphere, A, has a deep meridional groove on one side, *b*, extending from the equatorial groove to the pole, the flagellum taking its origin from the bottom of this vertical

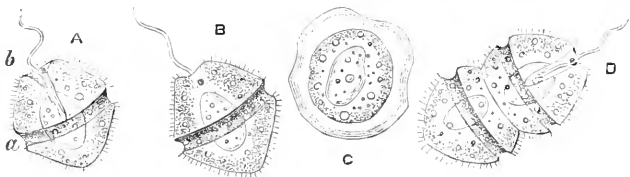

FIG. 590. *Peridinium aberrimum*: A, B, front and back views; C, encysted stage; D, duplicative subdivision.

groove, near its junction with the equatorial. The members of this group vary considerably in their mode of taking food; from the researches of Bergh it would appear that those which are provided with chromatophores have a plant-like mode of obtaining food, while those which are without chromatophores are truly animal in their method of alimentation. A 'contractile vesicle' has been rarely observed; but a large nucleus, sometimes oval and sometimes horse-shoe-shaped, seems always present. The *Peridinia* multiply by transverse fission (fig. 590, D), which commences in the subdivision of the nucleus, and then shows itself externally in a constriction of the ungrooved hemisphere, parallel to the equatorial furrow. They pass into a quiescent condition, subsiding towards the bottom of the water, and the loricated forms appear to throw off their envelopes. There is reason to believe that conjugation obtains in certain cases: *Glenodinium cinctum* has been observed by Professor Askenasy to copulate, but the development of the zygote, as the product of copulation may be called, has not yet been worked out. Some of the *Peridinia* are found in sea-water,² but the most remarkable marine

¹ Or, more correctly, *Dinomastigophora*.

² See F. Schütt, '*Die Peridineen der Plankton Expedition*,' *Ergebn. Plankton Exped.*, 1895. 170 pp. and 27 pls.

forms of the cilio-flagellate group belong to the genus *Ceratium* (fig. 591), in which the cuirass extends itself into long horny appendages. In the *Ceratium tripos* (1) there are three of these appendages; two of them curved, proceeding from the anterior portion of the cuirass, and the third, which is straight or nearly so, from its posterior portion. They are all more or less jagged or spinous. In *Ceratium furca* (2) the two anterior horns are prolonged straight forwards, one of them being always longer than the other; whilst the posterior is prolonged straight backwards. The anterior and posterior halves of the cuirass are separated by a ciliated furrow, from one point of which the flagellum arises; and at the origin of this is a deep

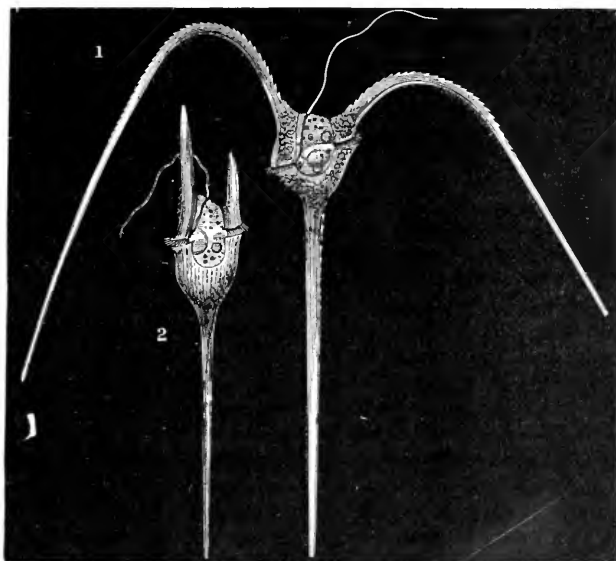

FIG. 591.—1, *Ceratium tripos*; 2, *Ceratium furca*.

depression into which the flagellum may be completely and suddenly withdrawn. The Author has found the *Ceratium tripos* extremely abundant in Lamlash Bay, Arran, where it constitutes a principal article of the food of the *Antedons* that inhabit its bottom.¹

Ciliata.—As it is in this tribe of animalcules that the action of the organs termed *cilia* has the most important connection with the vital functions, it seems desirable here to introduce a more particular notice of them. They are always found in connection with *cells*, of whose protoplasmic substance they may be considered as extensions, endowed in a special degree with its characteristic contractility. The form of the filaments is usually a little flattened,

¹ See Allman in *Quart. Microsc. Journ.* vol. iii. 1855, p. 24; H. James-Clark in *Ann. Nat. Hist.* ser. iii. vol. xviii. 1866, p. 429; Bergh, *Morphol. Jahrbüch.* vii. 1881, p. 177, and Vanhöffen, *Zool. Anzeig.* xix. 1896, pp. 133-4.

tapering gradually from the base to the point. Their size is extremely variable, the largest that have been observed being about $\frac{1}{5000}$ th of an inch in length, and the smallest about $\frac{1}{130000}$ th. When in motion each filament appears to bend from its root to its point, returning again to its original state, like the stalks of corn when depressed by the wind; and when a number are affected in succession with this motion, the appearance of progressive waves following one another is produced, as when a cornfield is agitated by successive gusts. When the ciliary action is in full activity, however, little can be distinguished save the whirl of particles in the surrounding fluid; but the *back* stroke may often be perceived, when the *forward* stroke is made too quickly to be seen, and the real direction of the movement is then opposite to the apparent. In this back stroke, when made slowly enough, a sort of 'feathering' action may be observed, the thin edge being made to cleave the

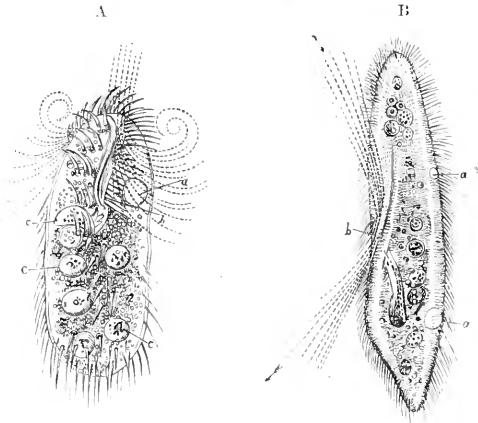

FIG. 592.—A, *Kerona silurus*: a, contractile vesicle; b, mouth; c, c, animalcules swallowed by the *Kerona*, after having themselves ingested particles of indigo. B, *Paramecium caudatum*: a, a, contractile vesicles; b, mouth. The dotted lines indicate currents.

liquid which has been struck by the broad surface in the opposite direction. It is only when the rate of movement has considerably slackened that the shape and size of the cilia, and the manner in which their stroke is made, can be clearly seen. Their action has been observed to continue for many hours, or even days, after the death of the body at large. As *cilia* are not confined to animalcules and zöophytes, but give motion to the zöospores of many protophytes, and also clothe the free internal surfaces of the respiratory and other passages in all the higher animals, including man (our own experience thus assuring us that their action takes place, not only without any exercise of *will*, but even without *consciousness*), it is clear that to regard animalcules as possessing a 'voluntary' control over the action of their cilia is altogether unscientific.

In the ciliated Infusoria, the differentiation of the sarcodic substance into 'ectosarc' or cell-wall, and 'endosarc' or cell-contents, becomes very complete, the ectosarc possessing a membranous firmness which prevents it from readily yielding to pressure, and having a definite internal limit, instead of graduating insensibly (as in rhizopods) into the protoplasmic layer which lines it. A 'nucleus' seems always present, being sometimes 'parietal' (or adherent to the interior of the ectosarc), in other cases lying in the midst of the endosarc. In many *Ciliata* a distinct 'cuticle' or exudation-layer may be recognised on the surface of the ectosarc; and this cuticle, which is studded with regularly arranged markings like those of Diatomaceæ, seems to be the representative of the carapace of *Arcella* &c. as of the cellulose coat of protophytes. It is sometimes hardened, so as to form a 'shield' that protects the body on one side only, or a 'lorica' that completely invests it; and there are other cases in which it is so prolonged and doubled upon itself as to form a sheath resembling the 'cell' of a zöophyte, within which the body of the animalcule lies loosely, being attached only by a stalk at the bottom of the case, and being able either to project itself from the outlet or to retract itself into the interior. In the marine forms known as *Dictocysta*, and in *Codonella*, described by Haeckel, the body is enclosed in a silicious lattice-work shell, usually bell-shaped or helmet-shaped, which bears so strong a resemblance to the shells of many Radiolaria as to be easily mistaken for them. The form of the body is usually much more definite than that of the naked rhizopods, each species having its characteristic shape, which is only departed from, for the most part, when the animalcule is subjected to pressure from without, or when its cavity has been distended by the ingestion of any substance above the ordinary size. The *cilia* and other mobile appendages of the body are extensions of the outer layer of the 'ectosarc' proper; and this layer, which retains a high degree of vital activity, is sometimes designated the 'cilia-layer.' Beneath this is a layer in which (or in certain bands of which) regular, parallel, fine striae may be distinguished, and as this striation is also distinguishable in the eminently contractile foot-stalk of *Vorticella*¹ (fig. 593, B) there seems good reason to regard it as indicating a special modification of protoplasmic substance, which resembles muscle in its endowments. Hence this is termed the 'myophan-layer.' Beneath this, in certain species of Infusoria, there is found a thin stratum of condensed protoplasm, including minute 'trichocysts,' which resemble in miniature the 'thread-cells' of zöophytes; and this, where it exists, is known as the 'trichocyst-layer.' The hair-like processes of protoplasm may be caused to protrude from the cell by such irritation as is effected by the addition of a little iodine to the water in which the animalcule is living.

The vibration of ciliary filaments, which are either disposed along the entire margin of the body, as well as around the oral

¹ On the morphology of the Vorticellinae see Bütschli, *Morphol. Jahrb.* xi. p. 553.

aperture (fig. 593, A, B), or are limited to some one part of it, which is always in the immediate vicinity of the mouth, supplies the means in this group of *Infusoria* both for progression through the water and for drawing alimentary particles into the interior of their bodies. In some their vibration is constant, whilst in others it is only occasional. The modes of movement which infusory animalcules execute by means of these instruments are extremely varied and remarkable. Some propel themselves directly forwards, with a velocity which appears, when highly magnified, like that of an arrow, so that the eye can scarcely follow

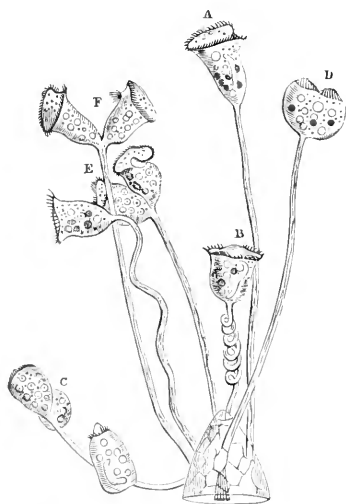

FIG. 593.—Group of *Vorticella nebulifera* showing, A, the ordinary form; B, the same with the stalk contracted; C, the same with the bell closed; D, E, F, successive stages of fissiparous multiplication.

them; whilst others drag their bodies slowly along like a leech. Some attach themselves by one of their long filaments to a fixed point, and revolve around it with great rapidity, whilst others move by undulations, leaps, or successive gyrations: in short, there is scarcely any kind of animal movement which they do not exhibit. But there are cases in which the locomotive filaments have a bristle-like firmness, and, instead of keeping themselves in rapid vibration, are moved (like the spines of Echini) by the contraction of the integument from which they arise, in such a manner that the animalcule crawls by their means over a solid surface, as we see especially in *Trichoda lynceus* (fig. 597, P, Q). In *Chilodon* and *Nassula*, again, the mouth is provided with a circlet of plications or folds, looking like bristles, which, when imperfectly seen, received the designation of 'teeth';

their function, however, is rather that of laying hold of alimentary particles by their expansion and subsequent drawing together (somewhat after the fashion of the tentacula of zöophytes) than of reducing them by any kind of masticatory process. Some, like *Opalina*, are entoparasitic, and have no mouth; a form allied to *Opalina* (*Anoplophrya circulans*) lives in the blood of *Asellus aquaticus*; other entoparasites, such as *Trichonympha* in the 'white ant,' still possess their mouth. The curious contraction of the foot-stalk of the *Vorticella* (fig. 593), again, is a movement of a different nature, being due to the contractility of the tissue that occupies the interior of the tubular pedicle. This stalk serves to attach the bell-shaped body of the animalcule to some fixed object, such as a leaf or stem of duck-weed; and when the animal is in search of

food, with its cilia in active vibration, the stalk is fully extended. If, however, the animalcule should have drawn to its mouth any particles too large to be received within it, or should be touched by any other that happens to be swimming near it, or should be 'jarred' by a smart tap on the stage of the microscope, the stalk suddenly contracts into a spiral, from which it shortly afterwards extends itself again into its previous condition. The central cord, to whose contractility this action is due, has been described as muscular, though not possessing the characteristic structure of either kind of muscular fibre: it possesses, however, the special irritability of muscle, being instantly called into contraction (according to the observations of Kühne) by electrical excitation. The only special 'impressionable' organs¹ for the direction of their actions with the possession of which Infusoria can be credited are the delicate bristle-like bodies which project in some of them from the neighbourhood of the mouth, and in *Stentor* from various parts of the surface. The red spots seen in many *Infusoria*, which have been designated as eyes by Professor Ehrenberg, from their supposed correspondence with the eye-spots of *Rotifera*, really bear a much greater resemblance to the red spots which are so frequently seen among protophytes. R. Hertwig, who seems to have successfully defended himself against the strictures of Professor Vogt, has described a vorticellid—*Erythroopsis agilis*—as having a pigment-spot which cannot but be regarded as a rudimentary eye; Metschnikoff, who thinks that *Erythroopsis* is an Acinetan, found a similar form with a similar eye near Madeira; and Harker observed that if light be allowed to fall on a part only of a colony of *Ophridium versatile* all the members soon congregate to the illuminated portion.²

The interior of the body does not always seem to consist of a simple undivided cavity occupied by soft protoplasm: for the tegumentary layer appears in many instances to send prolongations across it in different directions, so as to divide it into chambers of irregular shape, freely communicating with each other, which may be occupied either by protoplasm, or by particles introduced from without. The alimentary particles which can be distinguished in the interior of the transparent bodies of Infusoria are usually protophytes of various kinds, either entire or in a fragmentary state. The Diatomaceæ seem to be the ordinary food of many; and the insolubility of their *lorica* enables the observer to recognise them unmistakably. Sometimes entire Infusoria are observed within the bodies of others not much exceeding them in size (fig. 597, B); but this is only when they have been recently swallowed, since the prey speedily undergoes digestion. It would seem as if these creatures do not feed by any means indiscriminately, since particular kinds of them are attracted by particular kinds of aliment: the crushed bodies and eggs of Entomostraca, for example, are so voraciously

¹ The term 'organs of sense' implies a *consciousness* of impressions, with which it is difficult to conceive that unicellular Infusoria can be endowed. The component cells of the human body do their work without themselves knowing it.

² These results are confirmed by the observations of R. Franzó; see *Zeitschr. wiss. Zool.* lvi. 1893, pp. 138-64.

consumed by the *Coleps* that its body is sometimes quite altered in shape by the distension. This circumstance, however, by no means proves that such creatures possess a sense of taste and a power of determinate selection; for many instances might be cited in which actions of the like apparently conscious nature are performed without any such guidance. The ordinary process of feeding, as well as the nature and direction of the ciliary currents, may be best studied by diffusing through the water containing the animalcules a few particles of indigo or carmine. These may be seen to be carried by the ciliary vortex into the mouth, and their passage may be traced for a little distance down a short (usually ciliated) œsophagus. There they commonly become aggregated together, so as to form a little pellet of nearly globular form; and this, when it has attained the size of the hollow within which it is moulded, seems to receive an investment of firm sarcode substance, resembling the 'digestive vesicles' of *Noctiluca*, and to be then projected into the softer endosarc of the interior of the cell, its place in the œsophagus being occupied by other particles subsequently ingested. (This 'moulding,' however, is by no means universal, the aggregations of coloured particles in the bodies of Infusoria being often destitute of any regularity of form.) A succession of such pellets being thus introduced into the cell-cavity, a kind of circulation is seen to take place in its interior, those that first entered making their way out after a time (first yielding up their nutritive materials), generally by a distinct anal orifice, but sometimes by the mouth. When the pellets are thus moving round the body of the animalcule, two of them sometimes appear to become fused together, so that they obviously cannot have been separated by any firm membranous investment. The mode of formation of food vacuoles has been carefully studied by Miss Greenwood¹ in *Carchesium polypinum*, which may be recommended for the study of the processes of protozoan digestion. When the animalcule has not taken food for some time, 'vacuoles,' or clear spaces, extremely variable both in size and number, filled only with a very transparent fluid, are often seen in its protoplasm; and their fluid sometimes shows a tinge of colour, which seems to be due to the solution of some of the vegetable chlorophyll upon which the animalcule may have fed last.

Contractile vesicles (fig. 592, *a, a*), usually about the size of the 'vacuoles,' are found, either singly or to the number of from two to sixteen, in the bodies of most ciliated animalcules; and may be seen to execute rhythmical movements of contraction and dilatation at tolerably regular intervals, being so completely obliterated, when emptied of their contents, as to be quite undistinguishable, and coming into view again as they are refilled. These vesicles do not change their position in the individual, and they are pretty constant, both as to size and place, in different individuals of the same species; hence they are obviously quite different in character from the 'vacuoles.' In *Paramecium* there are always to be observed two globular vesicles (fig. 592, *B, a, a*), each of them surrounded by

¹ *Phil. Trans.* 1894, B, pp. 355-83.

several elongated cavities, arranged in a radiating manner, so as to give to the whole somewhat of a star-like aspect, and the liquid contents are seen to be propelled from the former into the latter, and *vice versa*. Further, in *Stentor*, a complicated network of canals, apparently in connection with the contractile vesicles, has been detected in the substance of the 'ectosarc,' and traces of this may be observed in other Infusoria. In some of the larger animalcules it may be distinctly seen that the contractile vesicles have *permanent* valvular orifices opening outwards, and that an expulsion of fluid from the body into the water around it is effected by their contraction; in some vorticellids the contractile vesicle is connected by a canal with the 'vestibule' which lies beneath the mouth opening, and when the vesicle contracts the water is driven into the mouth, and so to the exterior. Hence it appears likely that their function is of a respiratory and depuratory nature; and that they serve, like the gill-openings of fishes, for the expulsion of water which has been taken in by the mouth, and which has traversed the interior of the body.

Of the reproduction of the ciliated Infusoria our knowledge though imperfect has advanced. As has been well said by Mr. Adam Sedgwick,¹ 'the more recent work of Bütschli and Maupas [has] shown that in their reproduction these animals resemble other Protozoa; that is to say, that the whole body participates in the reproductive fission, that the parent disappears in the offspring, and that special conjugating cells of the nature of ova and spermatozoa are not formed. Maupas² especially, by following the history of the individual resulting from conjugation, has definitely established the fundamental distinction between conjugation and reproduction, and has thrown a flood of light upon the meaning of the whole phenomenon of conjugation.' The best evidence is that of Gruber, which will be mentioned directly. Binary subdivision would seem to be universal among them, and has in many instances been observed (as elsewhere) to commence in the nucleus. The division takes place in some species longitudinally, that is, in the direction of the greatest length of the body (fig. 593, D, E, F), in other species transversely (fig. 597, C, D); while in some, as in *Chilodon cucullulus* (fig. 595), it has been supposed to occur in either direction indifferently. But it may fairly be questioned whether, in this last case, one set of the apparent 'fissions' is not really 'conjugation' of two individuals. This duplication is performed with such rapidity, under favourable circumstances, that, according to the calculation of Professor Ehrenberg, no fewer than 268 millions might be produced in a month by the repeated subdivisions of a single *Paramecium*. When this fission occurs in *Vorticella* (fig. 593), it extends down the stalk, which thus becomes double for a greater or less part of its length; and thus a whole bunch of these animalcules may spring (by a repetition of the same process) from one base. In some members of the same family arborescent structures are produced resembling that of *Colosiga*

¹ Student's *Textbook of Zoology*, 1898, p. 26.

² See particularly his memoirs, in vols. vi. and vii. of the second series of the *Arch. Zool. Exper.* 1888-9.

(fig. 586) by the like process of continuous subdivision. Another curious result of this mode of multiplication presents itself in the family *Ophrydium*, masses of individuals which separately resemble certain *Vorticellina* being found imbedded in a gelatinous substance of a greenish colour, sometimes adherent and sometimes free. These masses, which may attain the diameter of four or five inches, present such a strong general resemblance to a mass of *Nostoc*, or even of frog's spawn, as to have been mistaken for such; but they simply result from the fact that the multitude of individuals produced by a repetition of the process of self-division remain connected with each other for a time by a gelatinous exudation from the surface of their bodies, instead of at once becoming completely isolated. From a comparison of the dimensions of the individual *Ophryda*, each of which is about $\frac{1}{20}$ th of an inch in length, with those of the composite masses, some estimate

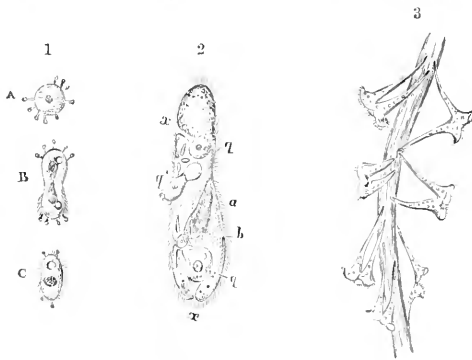

FIG. 594. — Reproduction of *Infusoria*.

may be formed of the number included in the latter; for a cubic inch would contain nearly *eight millions* of them if closely packed; and many times that number must exist in the larger masses, even making allowance for the fact that the bodies of the animalcules are separated from each other by their gelatinous cushion, and that the masses have their central portions occupied by water only. Hence we have, in such clusters, a distinct proof of the extraordinary extent to which multiplication by duplicative subdivision may proceed without the interposition of any other operation. These animalcules, however, free themselves at times from their gelatinous bed, and have been observed to undergo an 'encysting process' corresponding with that of the *Vorticellina*. The chemical composition of this jelly or zöocytium has been investigated by Halliburton, who finds that it resembles vegetable cellulose in its general properties, but differs from it and agrees with the form of cellulose manufactured by the Tunicata in being less easily converted into sugar.

Many, perhaps all, ciliated Infusoria at certain times undergo an *encysting process*, resembling the passage of protophytes into the 'still' condition, and apparently serving like it as a provision for their preservation under circumstances which do not permit the continuance of their ordinary vital activity. Previously to the formation of the cyst, the movements of the animalcule diminish in vigour, and gradually cease altogether; its form becomes more rounded; its oral aperture closes; and its cilia or other filamentous prolonga-

tions are either lost or retracted, as is well seen in *Vorticella* (fig. 596, A). A new wreath of cilia, however, is developed near the base, and in this condition the animal detaches itself from its

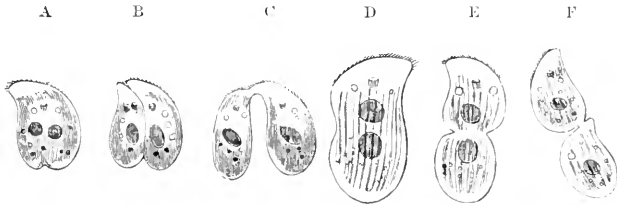

FIG. 595.—Fissiparous multiplication of *Chilodon cucullulus*: A, B, C, successive stages of longitudinal fission (?); D, E, F, successive stages of transverse fission.

stem and swims freely for a short time, soon passing, however, into the 'still' condition. The surface of the body then exudes a gelatinous excretion that hardens around it so as to form a complete coffin-like case, within which little of the original structure of the animal can be distinguished. Even after the completion of the cyst,

however, the contained animalcule may often be observed to move freely within it, and may sometimes be caused to come forth from its prison by the mere application of warmth and moisture. In the simplest form of the 'encysting process,' indeed, the animalcule seems to remain altogether quiescent through the whole period of its torpidity; so that, however long may be the duration of its imprisonment, it emerges without any essential change in its form or condition. But in other cases this process seems to be subservient either to multi-

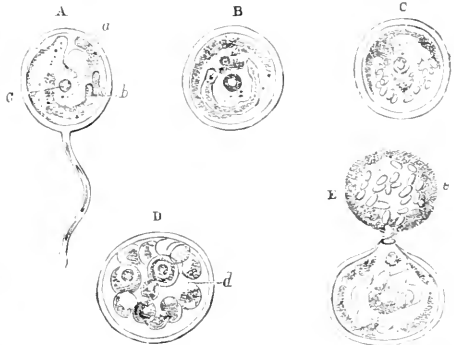

FIG. 596.—Encysting process in *Vorticella microstoma*: A, full-grown individual in its encysted state; *a*, retracted oval circle of cilia; *b*, nucleus; *c*, contractile vesicle; B, a cyst separated from its stalk; C, the same more advanced, the nucleus broken up into spore-like globules; D, the same more developed, the original body of the *Vorticella*, *d*, having become sacculated, and containing many clear spaces; at E, one of the sacculations having burst through the enveloping cyst, a gelatinous mass, *e*, containing the gemmules is discharged.

plication or to metamorphosis. For in *Vorticella* the substance of the encysted body (B) appears to break up (C, D) into eight or nine segments, which, when set free by the bursting of the cyst, come forth as spontaneously moving spherules. Each of these soon increases in size, develops a ciliary wreath within which a mouth

makes its appearance, and gradually assumes the form of the *Trichodina grandinella* of Ehrenberg. It then develops a posterior wreath of cilia and multiplies by transverse fission; each half fixes itself by the end on which the mouth is situated, a short stem becomes developed, and the cilia-wreath disappears. A new mouth and cilia-wreath then form at the free extremity, and the growth of the stem completes the development into the true vorticellan form.¹ In *Trichoda lynceus*, again, the 'encysting process' appears subservient to a like kind of metamorphosis, the form which emerges from the cyst differing in many respects from that of the animalcule which became encysted. According to M. Jules Haime, by whom this history was very carefully studied,² the form to be considered as the larval one is that shown in fig. 597, A, E, which has been described by Professor Ehrenberg under the name of *Oxytricha*. This possesses a long, narrow, flattened body, furnished with cilia along the greater part of both margins, and having also at its two extremities a set of larger and stronger hair-like filaments; and its mouth, which is an oblique slit on the right-hand side of its fore-part, has a fringe of minute cilia on each lip. Through this mouth large particles are not unfrequently swallowed, which are seen lying in the midst of the endosarc without any surrounding vesicle; and sometimes even an animalcule of the same species, but in a different stage of its life, is seen in the interior of one of these voracious little devourers (B). In this phase of its existence the *Trichoda* undergoes multiplication by transverse fission, after the ordinary mode (C, D); and it is usually one of the short-bodied 'doubles' (E) thus produced that passes into the next phase. This phase consists in the assumption of the globular form and the almost entire loss of the locomotive appendages (F); in the escape of successive portions of the granular protoplasm, so that 'vacuoles' make their appearance (G); and in the formation of a gelatinous envelope or cyst, which, at first soft, afterwards acquires increased firmness (H). After remaining for some time in this condition, the contents of the cyst become clearly separated from their envelope; and a space appears on one side, in which ciliary movement can be distinguished (I). This space gradually extends all round, and a further discharge of granular matter takes place from the cyst, by which its form becomes altered (K); and the distinction between the newly formed body to which the cilia belong and the effete residue of the old becomes more and more apparent (L). The former increases in size, whilst the latter diminishes; and at last the former makes its escape through an aperture in the wall of the cyst, a part of the latter still remaining within its cavity (M). The body thus discharged (N) does not differ much in appearance from that of the *Oxytricha* before its encystment (F), though of only about two-thirds its diameter; but it soon develops itself (O, P, Q) into an animalcule very different from that in which it originated. First it becomes still smaller by the discharge of a portion of its substance; numerous very stiff bristle-

¹ Everts, *Untersuchungen an Vorticella nebulifera*, quoted by Professor Allman, *loc. cit.*

² *Annales des Sci. Nat.* ser. iii. tome xix. 1853, p. 109.

like organs are developed, on which the animalcule creeps, as by legs, over solid surfaces; the external integument becomes more consolidated on its upper surface, so as to become a kind of carapace; and a mouth is formed by the opening of a slit on one side, in front of which is a single hair-like flagellum, which turns round and round with great rapidity, so as to describe a sort of inverted cone whereby a current is brought towards the mouth. This latter form had been described by Professor Ehrenberg under the name of *Aspidisca*. It is very much smaller than the larva, the difference being, in fact, twice as great as that which exists between A and

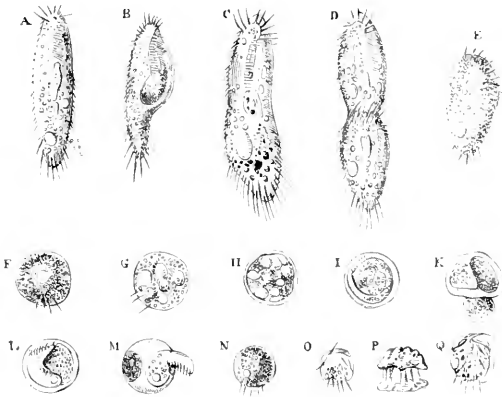

FIG. 597. —Metamorphoses of *Trichoda lynceus*: A, larva (*Oxytricha*); B, a similar larva after swallowing the animalcule represented at M; C, a very large individual on the point of undergoing fission; D, another in which the process has advanced further; E, one of the products of such fission; F, the same body become spherical and motionless; G, aspect of this sphere fifteen days afterwards; H, later condition of the same, showing the formation of the cyst; I, incipient separation between living substance and exuvial matter; K, partial discharge of the latter, with flattening of the sphere; L, more distinct formation of the confined animal; M, its escape from the cyst; N, its appearance some days afterwards; O, more advanced stage of the same; P, Q, perfect *Aspidisca*, one as seen sideways, moving on its bristles, the other as seen from below (magnified twice as much as the preceding figures).

P, Q (fig. 597), since the last two figures are drawn under a magnifying power double that employed for the preceding. How the *Aspidisca*-form in its turn gives origin to the *Oxytricha*-form has not yet been made out. A similar 'encysting process' has been observed to take place among several other forms of ciliated Infusoria; so that, considering the strong general resemblance in kind and degree of organisation which prevails throughout the group, it does not seem unlikely that it may occur at some stage of the life of nearly all these animalcules. And it is not improbable in the 'encysted' condition that their dispersion chiefly takes place, since they have been found to endure desiccation in this state, although in their ordinary condition of activity they cannot be dried

up without loss of life. When this circumstance is taken into account, in conjunction with the extraordinary rapidity of multiplication of these animalcules, there seems no difficulty in accounting for the universality of their diffusion. It may be stated as a general fact that wherever decaying organic matter exists in a liquid state, and is exposed to air and warmth, it speedily becomes peopled with some or other of these minute inhabitants; and it may be fairly presumed that, as in the case of the Fungi, the dried cysts or germs of Infusoria are everywhere floating about in the air, ready to develop themselves wherever the appropriate conditions are presented; but we must remember that but few definite observations have been made as to the length of time these cysts will survive desiccation; at present, the observations of Nussbaum and Maupas make the limit less than two years.

Gruber has recently reinvestigated the process of conjugation in the Infusoria: he finds that the nucleolus of each becomes a striated spindle, and approaches the nucleolus of the other cell; the two touch and finally fuse, thereby effecting an intermixture of the different germ-plasmas. If this be the correct manner of interpreting the phenomenon, it is clearly comparable to the sexual reproduction of multicellular animals.

There can be no doubt as to the occurrence of 'conjugation' among ciliated Infusoria; and this not only in the free-swimming, but also in the attached forms, as *Stentor* (fig. 594, 3). In *Vorticella*, according to several recent observers, what has been regarded as *gemmiparous* multiplication—the putting forth of a bud from the base of the body—is really the conjugation of a small individual in the free-swimming stage with a fully developed fixed individual (microgamete) with whose body its own becomes fused. But it is doubtful whether such conjugation has any reference to the encysting process. According to Bütschli and Engelmann, the conjugating process results in the breaking up of the nucleus and (so-called) nucleolus of the conjugating individuals; these individuals separate again, and after the expulsion of the broken-up nuclear structures the characteristic nucleus and nucleolus are re-formed. There is still much uncertainty in regard to the embryonic forms of ciliate Infusoria, some eminent observers asserting that the 'gemmule' in the first instance, besides forming a cilia-wreath, puts forth suctorial appendages (fig. 594, 1, A, B, C), by means of which it imbibes nourishment until the formation of its mouth permits it to obtain its supplies in the ordinary way; whilst others maintain these acinetiform bodies to be parasites, which even imbed themselves in the substance of the Infusoria they infest.¹

It is obvious that no classification of Infusoria can be of any permanent value until it shall have been ascertained by the study of their entire life-history what are to be accounted really distinct

¹ There can be no doubt that Stein was wrong in his original doctrine that the fully developed *Acinetina* are only transition stages in the development of *Vorticellina* and other ciliated Infusoria. But the balance of evidence seems to the writer to be in favour of his later statement, that the bodies figured in fig. 594, 1, are really infusorian embryos, and not parasitic Acinetæ.

forms. And the differences between them, consisting chiefly in the shape of their bodies, the disposition of their cilia, the possession of other locomotive appendages, the position of the mouth, the presence of a distinct anal orifice, and the like, are matters of such trivial importance as compared with those leading features of their structure and physiology on which we have been dwelling that it does not seem desirable to attempt in this place to give any detailed account of them. The life-history of the *ciliate Infusoria* is a subject pre-eminently worthy of the attention of microscopists, who can scarcely be better employed than in tracing out the sequence of its phenomena with similar care and assiduity to that displayed by Messrs. Dallinger and Drysdale in the study of the *Monalina*. 'In pursuing our researches,' say these excellent observers, 'we have become practically convinced of what we have theoretically assumed—the absolute necessity for prolonged and patient observation of the same forms. Competent optical means, careful interpretation, close observation, and *time* are alone capable of solving the problem.'

Suctoria.—The *suctorial Infusoria* constitute a well-marked group, all belonging to one family, *Acinetina*, the nature of which has been until recently much misunderstood, chiefly on account of the parasitism of their habit. They may be regarded as a sub-class of the *Infusoria*, and be known as the *Acinetaria*. Like the typical *Monalina*, they are closed cells, each having its nucleus and contractile vesicle; but instead of freely swimming through the water, they attach themselves by flexible peduncles, sometimes to the stems of *Volvicellina*, but also to filamentous *Algae*, stems of *zöophytes*, or to the bodies of larger animals. Their nutriment is obtained through delicate tubular extensions of the ectosarc, which act as *suctorial tentacles* (fig. 598), the free extremity of each being dilated into a little knob, which flattens out into a button-like disc when it is applied to a food-particle. Free-swimming *Infusoria* are captured by these organs, of which several quickly bend over towards the one which was at first touched, so as firmly to secure the prey; and when several have thus attached themselves, the movements of the imprisoned animal become feebler, and at last cease altogether, its body being drawn nearer to that of its captor. Instead, however, of being received into its interior like the prey of *Actinophrys*, the captured animalcule remains on the outside, but yields up its soft substance to the *suctorial power* of its victor. As soon as the sucking disc has worked its way through the envelope of the body to which it has attached itself, a very rapid stream, indicated by the granules it carries, sets along the tube, and pours itself into the interior of the *Acineta*-body. Solid particles are not received through these *suctorial tentacles*, so that the *Acinetina* cannot be fed with indigo or carmine; but, so far as can be ascertained by observation of what goes on within their bodies, there is a general protoplasmic *cyclosis* without the formation of any special 'digestive vesicles.' The better known forms of this group are ranked under the two genera *Acineta* and *Podophrya*, which are chiefly distinguished by the presence of a firm envelope or *lorica* in the former, while the body

of the latter is naked. In one curious form, the *Ophryodendron*, the suckers are borne in a brush-like expansion on a long retractile proboscis-like organ; and the rare *Dendrosoma*, whose size is comparatively gigantic, forms by continuous gemmation an arborescent 'colony,' of which the individual members remain in intimate connection with one another.

Multiplication in this group seems occasionally to take place by transverse fission, but this is rare in the adult state. Sometimes external *gemmae* are developed by a sort of pinching off of a part of the free end of the body, which includes a portion of the nucleus; the tentacula of this bud disappear, but its surface be-

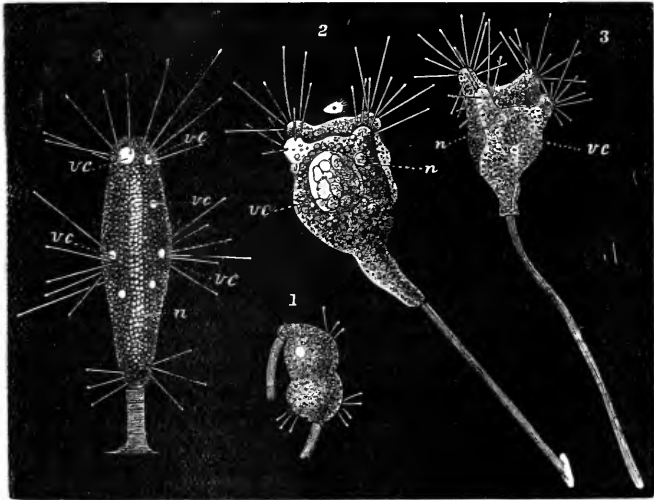

FIG. 598.—Suctorial Infusoria: 1, Conjugation of *Podophrya*¹ *quadripartita*; 2, formation of embryos by enlargement and subdivision of the nucleus; 3, ordinary form of the same; 4, *Podophrya elongata*.

comes clothed with cilia; and, after a short time, it detaches itself and swims away—comporting itself subsequently like the internal embryos, whose production seems the more ordinary method of propagation in this type. These originate in the breaking up of the nucleus into several segments, each of which incloses itself in a protoplasmic envelope; and this becomes clothed with cilia, by the vibrations of which the embryos are put in motion within the body of the parent (fig. 598, 2), from which they afterwards escape by its rupture. In this condition (*a*) they swim about freely, and seem identical with what has been described by Ehrenberg as a

¹Now called, after Bütschli, *Tokophrya*, on account of its mode of reproduction; see his *Protozoa*, p. 1928.

distinct generic form, *Megatricha*. And, according to the observations of Mr. Badcock,¹ these *Megatricha*-forms multiply freely by self-division. After a short time, however, they settle down upon filamentous Alge or other supports, lose their cilia, put forth suctorial tentacles (which seem to shoot out suddenly in the first instance but are afterwards slowly retracted and protruded with a kind of spiral movement), and assume a variety of amœbiform shapes (fig. 599, 1, 2, 3), some of them corresponding to that of the genus *Trichophrya*. In this stage they become quiescent at the approach of winter, the suctorial tentacles and the contractile vesicles disappearing; they do not, however, seem to acquire any special envelope, remaining as clear, motionless, protoplasmic particles. But with the return of warmth their development recommences, a

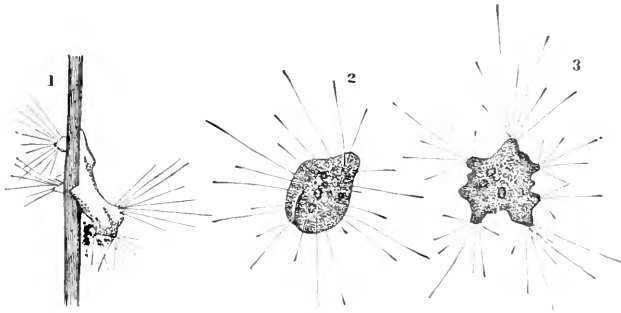

FIG. 599.—Immature forms of *Podophrya quadripartita*: 1, Amœboid state (*Trichophrya* of Claparède and Lachmann); 2, the same more advanced; 3, incipient division into lobes.

footstalk is formed, and they gradually assume the characteristic form of *Podophrya quadripartita*. A regular 'conjugation' has been observed in this type, the body of one individual bending down so as to apply its free surface to the corresponding part of another, with which it becomes fused (fig. 598, 1); but whether this always precedes the production of internal embryos, or is any way preparatory to propagation, has not yet been ascertained.²

¹ *Journ. of Roy. Microsc. Soc.*, vol. iii. 1880, p. 563.

² The *Acinetina* were described both by Ehrenberg and Dujardin; but the first full account of their peculiar organisation was given by Stein in his *Organismus der Infusionsthierchen*. Misled, however, by their parasitic habits, Stein originally supposed them not to be independent types, but to be merely transitional stages in the development of *Vorticellina* and other ciliate Infusoria; this doctrine he long since abandoned. Much information as to this group will also be found in the beautiful *Études sur les Infusoires et les Rhizopodes* of MM. Claparède and Lachmann, Geneva, 1858-61.

SECTION II.—ROTIFERA, OR WHEEL-ANIMALCULES.

We now come to that higher group of animalcules which, in point of complexity of organisation, is as far removed from the preceding as mosses are from the simplest protophytes, the only point of real resemblance between the two groups, in fact, being the minuteness of size which is common to both. A few species of the wheel-animalcules are marine, or the inhabitants of brackish pools near the seashore. Dr. E. v. Daday, who has made a study of the

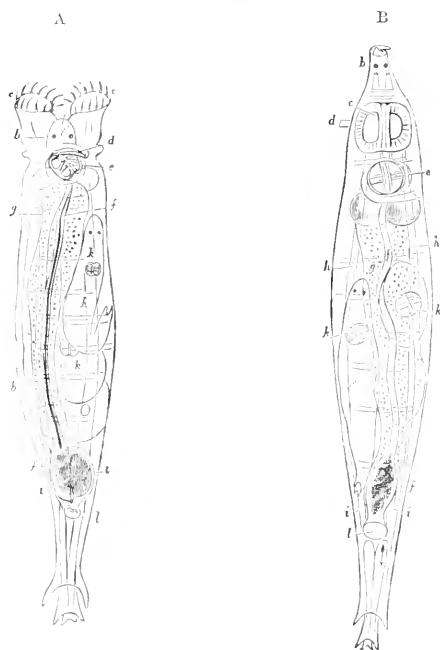

FIG. 600.—*Rotifer culmaris*, as seen at B, with the wheels drawn in, and at A with the wheels expanded: *b*, eye-spots; *c*, wheels; *d*, antenna; *e*, jaws and teeth; *f*, alimentary canal; *g*, cellular mass inclosing it; *h*, longitudinal muscles; *i, i*, tubes of water-vascular system; *k*, young animal; *l*, cloaca.

Rotifera of the Bay of Naples, stated that in 1891, 50 species were known from the Baltic, 13 from the Mediterranean, 8 from elsewhere, but 32 of these occur also in fresh water. The vast majority known to us belong, therefore, to fresh water, and are to be found in ditches, ponds, reservoirs, lakes, and slowly running streams—sometimes attached to the leaves and stems of water-plants, sometimes creeping on Alge, on which some are parasitic,¹ sometimes

¹ Compare particularly the interesting observations of Prof. W. Rothert in vol. ix, 1896, of the *Zoolog. Jahrb. (Abth. Systemat.)*, pp. 672-713.

swimming freely through the water. They are met with also in gutters on the house-top, in water-butts, on wet moss, grass, and liver-worts, in the interior of *Volvox globator* and *Vaucheria*, in vegetable infusions, on the backs of *Entomostraca*, in the viscera of slugs, earth-worms, and *Naiades*, and in the body-cavities of *Synapta*—in fact, in almost every place where there are moisture and food. The wheel-like organs from which the class derives its designation are most characteristically seen in the common *Rotifer* (fig. 600), where they consist of two disc-like lobes or projections of the body whose margins are fringed with long cilia; and it is the uninterrupted succession of strokes given by these cilia, each row of which nearly returns (as it were) into itself, that gives rise by an optical illusion to the notion of 'wheels.' The disposition of the cilia varies much in the different genera, but it may be said broadly that they are arranged so as to fulfil three different purposes, viz. to bring food to the mouth, to conduct it through the alimentary canal, and to enable the animal to swim.

The great transparency of the Rotifera permits their general structure to be easily recognised. They have usually an elongated form, similar on the two sides; but this rarely exhibits any traces of segmental division. The body is covered with an envelope of two layers. The inner of these is a soft lining to the outer, which may be soft and flexible, or membranous and of very varying degrees of stiffness, or even of an inflexible substance capable of resisting the action of caustic potash. In this latter condition it is called a *lorica*. The greater number of the Rotifera have an organ of attachment at the posterior extremity of the body, which is usually prolonged into a tail or false foot, by which they can affix themselves to any solid object; and this is their ordinary position when keeping their 'wheels' in action for a supply of food or of water; they have no difficulty, however, in letting go their hold and moving through the water in search of a new attachment, and may therefore be considered as perfectly free. The sessile species, in their adult stage, on the other hand, remain attached by the posterior extremity to the spot on which they have at first fixed themselves, and their cilia are consequently employed for no other purpose than that of creating currents in the surrounding water. In considering the internal structure of Rotifera we shall take as its type the arrangement which it presents in *Brachionus rubens* (fig. 601), a common large and handsome animal, and one that bears the temporary captivity of a compressorium remarkably well.

Its vase-shaped *lorica* is hard and transparent; open in front to allow the protrusion of the head, and closed behind, except where a small aperture permits the passage of the foot. The anterior dorsal edge bears six sharp spines, and the ventral edge has a wavy outline. The *head* is shaped like a truncated cone, with the larger end forward, is rounded at each side, and carries on its front surface three protuberances (*sp.*), covered with stout vibrating hairs called *styles*. All round the rim of the head runs a row of cilia which on the ventral surface dips down into either side of a ciliated *buccal funnel*. At the bottom of the buccal funnel is the *mouth* (*mc.*), a

muscular bulb containing the jaws or *trophi* (*ti*). These latter are hard, glassy bodies consisting of two hammer-like pieces called *mallei* (fig. 602) and a third anvil-piece called an *incus*. Each *malleus* (*ms*) is in two parts—the *manubrium* (*mn*), or handle, and the *uncus* (*us*), of five finger-like processes, which unite to

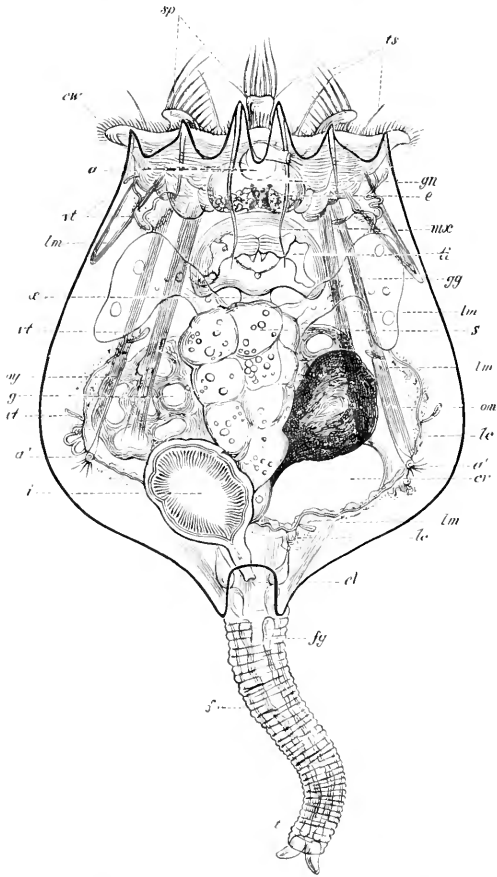

FIG. 601.—*Brachionus rubens*: *sp*, styligerous prominences *cw*, coronal wreath; *ts*, tactile styles; *a*, dorsal antenna; *a'*, *a'*, lateral antennae; *lm*, longitudinal muscles; *a*, oesophagus; *oy*, ovary; *om*, ovum; *g*, germ; *vt*, vibratile tags; *i*, intestine; *f*, foot; *t*, toes; *gn*, brain; *c*, eye; *mx*, mastax; *ti*, trophi; *gg*, gastric glands; *s*, stomach; *lc*, longitudinal canals; *cv*, contractile vesicle; *cl*, cloaca; *fg*, foot-gland. (After Dr. Hudson.)

form the hammer's head. The *incus* (*is*), or anvil, is formed of two prism-shaped bodies, or *rami* (*rs*), pointed at their free ends, and attached at their broad ends to a thin plate called the *fulcrum* (*fm*), which, seen ventrally or dorsally, looks like a rod. These various parts are connected by muscular fibres, and so acted on by muscles

attached to themselves, and to the interior of the mastax, that the unci rise and fall at the same time that the rami open and shut. The food is torn by the unci, crushed by the rami, and then passes between the latter down a short œsophagus (*a*) into the *stomach* (*s*). This has thick cellular walls, and is lined with cilia, especially at its lower third, which is often divided by a constriction from the upper part, and is often so different in its shape and contents as to merit the name of an *intestine* (*i*). The lower end of the intestine generally expands into a *cloaca* (*cl*), into which open the ducts of the *ovary* (*ov*), and *contractile vesicle* (*cv*). Just above the mastax, and sometimes just below it, on the œsophagus, are what are supposed to be *salivary glands*: while attached to the upper end of the stomach are two *gastric glands* (*gg*), often possessing visible ducts. There are two further glands (*fg*) in the foot, which is itself a prolongation of the ventral portion of the trunk below the aperture of the cloaca. These foot-glands secrete a viscid substance which is discharged by ducts passing to the tips of the two toes (*t*) and which serves to attach the animal to one spot when it is using its frontal cilia to procure food.

Longitudinal muscles (*lm*) for withdrawing the head and foot within the lorica can be readily seen, and these parts are driven out again by the pressure of transverse muscular fibres acting on the fluids of the body.

On either side of the body is a tortuous tube commencing in a plexus in the head and running down to open on the *contractile vesicle* (*cv*). These tubes bear little *tags* (*rt*), each of which appears to contain a vibrating cilium. The real structure of these bodies is uncertain, and the use of the whole apparatus is much disputed; but the tags are possibly very minutely ciliated funnels, their free ends open to the body-cavity; and it seems probable that the fluids of the body-cavity are conducted through them, along the tortuous tubes, into the contractile vesicle, and are by it discharged into the cloaca. The apparatus would therefore be mainly an excretory one.¹

There is a bilobed *nervous ganglion* (*gn*) between the buccal funnel and the dorsal surface. Above it is the *eye* (*e*)—a refracting sphere on a mass of crimson pigment. From the ganglion pass nerve-threads to a *dorsal antenna* (*a*) and to two *lateral antennæ* (*a'*) on either side of the dorsal surface. These latter organs are rocket-headed terminations of the nervous threads, and have each a bundle of fine hairs passing through a hole in the lorica. The dorsal

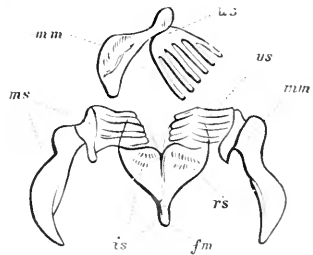

FIG. 602.—Malleate type of jaw.

- ms*, malleus
- us*, unci.
- mm*, manubrium.
- is*, incus
- rs*, ramus.
- fm*, fulcrum.

¹ But see Dr. Hudson's Presidential Address, *Journ. of the Roy. Microsc. Soc.* Feb. 1891, p. 13, in which reasons are given for suspecting that the contractile vesicle may also have a respiratory function, and the vibratile tags and longitudinal canals an excretory one.

antenna has a similar bundle and lies sheathed in a tube (fig. 605) which has its base just above the nervous ganglion, and passes thence between the two central anterior spines of the lorica. It is furnished with a muscle, by means of which the bunch of setae at the free extremity can, by invagination, be drawn within the tube.

The ovary is large and its germs are conspicuous. The animal is oviparous and the huge egg is easily discharged through the oviduct and cloaca owing to the very fluid condition of its contents. It is retained by a thread till hatched at the bottom of the lorica. There are three kinds of eggs: the common soft-shelled eggs, which are large, oval, and produce females; similar soft eggs, which are smaller, more spherical, and produce males; and *ephippial* eggs (fig. 603), with thick cellular coverings, often ornamented with spines. These latter can be dried completely without losing their vitality, and so, lying buried in the mud of dried-up ponds, preserve the species for next year.

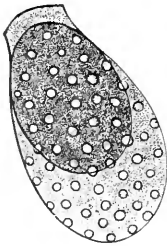

FIG. 603.
Ehippial egg.

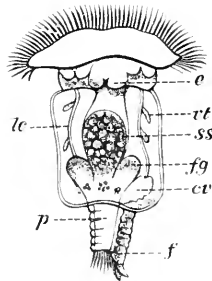

FIG. 604.—Male: *e*, eye; *lc*, longitudinal canals; *vt*, vibratile tag; *cv*, contractile vesicle; *ss*, sperm-sac; *p*, penis; *f*, foot; *fg*, foot-gland.

The *male* (fig. 604) is but a third of the length of the female, and is unlike it in shape. It has a cylindrical trunk, small foot, and flat round head, surrounded by a simple ring of long cilia. It has no *lorica* nor any *alimentary tract* of any kind, but it has a *nervous system* similar to that of the female, a red eye, and antennae. Its *excretory* and *muscular* systems are also of the female pattern. The only other internal organ is a large *sperm-sac* (*ss*) ending at its lower extremity in a protrusile, ciliated, hollow *penis* (*p*), whose outlet holds the position of the anus in the female: that is, on the dorsal surface, at the base of the foot.

The Rotifera have been divided by Dr. Hudson and Mr. P. H. Gosse¹ into four orders, according to their powers of locomotion. These are:

1. RHIZOZA (*the rooted*). Fixed when adult.

¹ *The Rotifera, or Wheel-animals*. Longmans, 1889. It should be added that Dr. Plate, in 1890 (*Zeitschr. f. wiss. Zool.* xli.), has suggested a division according to the paired or unpaired character of the gonads.

2. *BDELOIDA* (*the leech-like*). That swim with their ciliary wreath, and creep like a leech.
3. *PLOÏMA* (*the sea-worthy*). That only swim with their ciliary wreath.
4. *SCIPTOPODA* (*the skippers*). That swim with their ciliary wreath and skip with arthropodous limbs.

The order *Rhizota* contains two families, chiefly differing from each other in the position of the mouth, which in the *Flosculariidae* (figs. 1 and 2, Plate XVII) is central, lying in the body's longer axis, but in the *Melicertidae* (fig. 3, Plate XVII) is lateral. Almost all the species of both families live in gelatinous tubes secreted by themselves, and often fortified in various ways: by *débris* gathered from the water by the action of their ciliary wreaths and showered down at random: by pellets formed in a ciliated cup near the anterior end of the body, and deposited in regular order on the gelatinous tube; or by large fecal pellets also regularly deposited.



FIG. 605.
Dorsal
antenna
in tube.

The second order, *Bdelloida* (fig. 7, Plate XVII), while having many points in common with the *Melicertidae*, have a foot peculiarly their own. It has several false joints that can be drawn one within the other like those of a telescope. The corona consists of two nearly circular discs, each surrounded with a double row of cilia, and both of these can be withdrawn into an infolding of the ventral surface at the anterior end of the body, leaving the animal with a long pointed conical head. When the discs are so furled the animal fixes the toes of its foot, elongates the foot and body, catches hold with the furthest point of the conical head, releases the foot, and then, contracting the body and foot while the head remains fixed, draws forward the toes and reflexes them, and so *de capo*. It can swim, however, in the usual fashion, with its ciliary wreath. All the species of this order can, under proper circumstances, be dried up into balls, which will retain their vitality for even years, though in a state of utter dustiness. This is due to their secreting round their bodies (after having drawn in both head and foot) a gelatinous covering which retains the body-fluids safe from evaporation.¹ This process takes some time, so that if an attempt is made to dry them on an ordinary glass-slip they simply disintegrate. In a house gutter or in wet moss or sand, where the drying up of the water, in which the Rotifera are, is slowly accomplished, the animals have time to complete their gelatinous coverings before the water fails them. In this order the males have not as yet been discovered.

The third order, *Ploïma*, is divided into a loricate and an illoricate group, which are not, however, very sharply separated; as in some cases the outer layer of the skin is, though horny, yet thin and flexible. *Brachionus rubens* (fig. 601), which has already been fully described, is a good type of the *Loricata* and *Copeus cerberus* (fig. 6, Plate XVII) of the *Illoricata*. Most of the species of this order have

¹ See Davis in *Monthly Microsc. Journ.* vol. ix. 1863, p. 207; Slack, at p. 241 of same volume; and the report of a discussion on the subject at the Royal Microscopical Society, *Journ. of Royal Microsc. Soc.* 1887, p. 179.

a forked jointed foot, the fork being formed of two toes varying greatly in size and shape, but all secreting the viscous fluid already mentioned. The great majority of the Rotifera belong to the *Plöima*.

The fourth order, *Scirtopoda*, contains but one family, *Pedalionida*, and has only two genera, *Pedalion* and *Hexarthra*, and the latter of these has but one known species, the former only two. *Pedalion* (figs. 4, 5, 8, Plate XVII) is an extraordinary creature. Its internal organs are on the usual rotiferous plan, but its body bears no fewer than six hollow limbs, ending in plumes like those of the *Arthropoda*, and worked by pairs of opposing muscles which traverse their entire length. These limbs are arranged round the body, some on the dorsal, some on the ventral surface, and all running parallel to the body's longer axis. In *Hexarthra*, on the contrary, all the limbs are on the ventral surface, and are arranged radiatingly. There is no foot in either Rotifer; but in *Pedalion* there are two ciliated club-like processes at the posterior extremity, rising above the dorsal surface and secreting a similar viscous fluid to that secreted in the toes of other *Rotifera*.

This strange creature was discovered by Dr. C. T. Hudson in a pond near Clifton in 1871; *Hexarthra* was discovered by Dr. Schmarda in a brackish ditch near the Nile in 1853; their arthropodous limbs give them a strong resemblance to a Nauplius larva, and make it probable that the nearest relations of the *Rotifera* are the *ARTHIROPODA*;¹ at any rate, there is more probability in this suggestion than in that of Professor Hartog that they are allied to the *Pilidium*-larva of Nemertine worms.²

¹ The following treatises and memoirs (in addition to those already referred to) contain valuable information in regard to the life-history of animalcules and their principal forms:—Ehrenberg, *Die Infusionsthierchen*, Berlin, 1838; Dujardin, *Histoire naturelle des Zoophytes infusoires*, Paris, 1841; Pritchard, *History of Infusoria*, 4th ed. London, 1861 (a comprehensive repertory of information); Stein, *Der Organismus der Infusionsthierchen*, Leipzig: Erste Abtheilung, 1859; Zweite Abtheilung, 1867; Dritte Abtheilung, Hülft I. 1878. Saville Kent's *Manual of the Infusoria*, 1880-1; and Professor Bütschli's *Protozoa* (1880-1) in the new edition of Broun's *Thierreichs*. For the Rhizopoda and Infusoria specially see Claparède and Lachmann, *Études sur les Infusoires et les Rhizopodes*, Geneva, 1858-61; Cohn, in *Siebold und Kölliker's Zeitschrift*, 1851-4 and 1857; Lieberkühn, in *Müller's Archiv*, 1856, and *Ann. of Nat. Hist.* 2nd ser. vol. xviii. 1856; Engelmann, *Zur Naturgeschichte der Infusionsthierchen*, 1862; and Professor Bütschli's *Studien über die Conjugation der Infusorien &c.*, 1876. For the Rotifera specially see Leydig, in *Siebold und Kölliker's Zeitschrift*, Bd. vi. 1854; Gosse on *Melicerta ringens*, in *Quart. Journ. of Microsc. Sci.* vol. i. 1853, p. 1; on the Manducatory Organs of Rotifera, *Phil. Trans.* 1856; Huxley on *Lacinularia socialis* in *Trans. Microsc. Soc.* ser. ii. vol. i. 1853, p. 1; Cohn, in *Siebold und Kölliker's Zeitschrift*, Bde. vii. ix. 1856, 1858; Dr. Moxon, *Trans. Linn. Soc.* 1861; Karl Eckstein, *Siebold und Kölliker's Zeitschrift*, 1883; Bourne, *Rotifera*, in the 9th edition of the *Encyclopædia Britannica*; Joliet, 'Monographie des Mélicertes,' *Archiv. zool. expér.* sér. ii. tom. i. p. 131; and Plate, *Jenaische Zeitschr.* xix. p. 1. *The Rotifera, or Wheel-animalcules*, by Hudson and Gosse, Longmans, 1889. This has been usefully supplemented by Mr. C. F. Roussetlet in two papers entitled 'List of New Rotifers since 1889,' in *Journ. R. Microsc. Soc.* 1893, pp. 450-8, and 'Second List, &c. in the same journal for 1897, pp. 10-15. The bibliographical lists appended by Mr. Roussetlet will be found of much service, as since the publication of the work of Messrs. Hudson and Gosse there has been a great revival among the students of this group. Mr. Slack's *Marrels of Pond Life*, 2nd edit. (London, 1871), contains many interesting observations on the habits of Infusoria and Rotifera.

² See his remarks on the relation of the Rotifera to the Trochophore, in *Rep. Brit.*

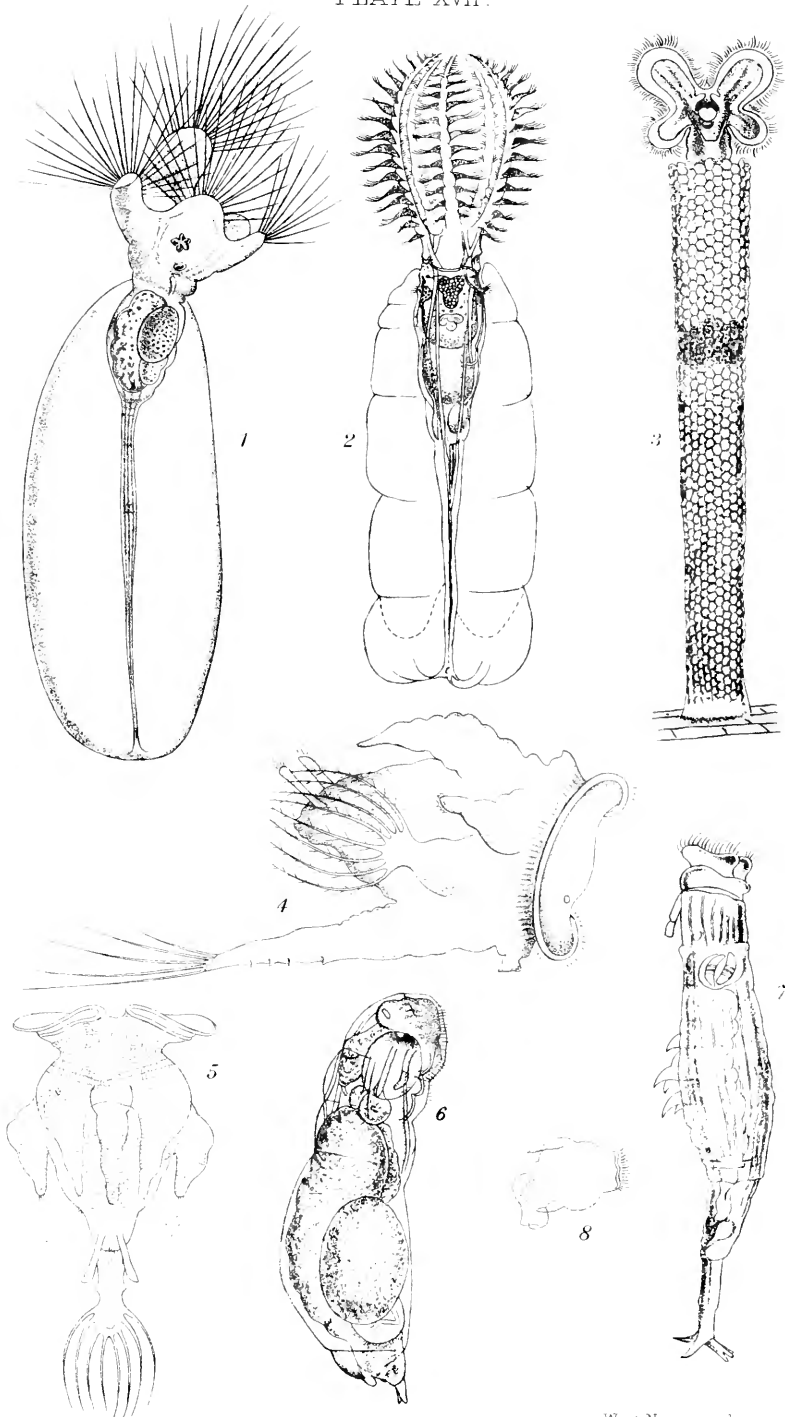

West. Newman chromo

Typical Rotifers

APPENDIX TO CHAPTER XIII

THE preparation and preservation of Rotifers well extended as in life to serve as type specimens is now possible, and the following is an outline of Mr. C. F. Rousset's method, which consists of three stages: narcotising, killing and fixing, and preserving. The whole operation is necessarily performed under a dissecting microscope.

The first step in the preparation of Rotifers is to isolate the animals by transferring as many as may be available by means of a very fine pipette to a fresh watchglass full of perfectly clean water until all particles of foreign matter have been eliminated. This is necessary because when the animals are dead these particles adhere to the cilia of the Rotifers, from whence it is very difficult to remove them. In the case of fixed Rotifers, such as *Melicerta*, *Limnias*, *Stephanoceros*, &c., it is necessary to cut off and trim a very small piece of the plant to which they are attached ready for mounting, so as not to have to do this when the animals are killed and prepared. It is also necessary to separate the different species, as most of them require a little different, more or less prolonged, treatment under the narcotic. The great difficulty with Rotifers has always been to kill and fix them whilst fully extended as in life. The most rapid killing agents are too slow to prevent complete retraction; recourse, therefore, has been had to narcotising, and after many experiments a satisfactory narcotic has been found in the following mixture:

2 per cent. solution of hydrochlorate of cocaine	3 parts
Methylated spirit	1 "
Water	6 "

The Rotifers then, separated as to species, and in a watchglass full of perfectly clean water, are ready for narcotising. One or two drops of the above solution are added to the water and mixed. The effect of the narcotic is most varied in different species. Some will not mind it at all and continue to swim about, others will contract at once but soon come out again and swim about at a diminishing rate until they finally sink to the bottom with the cilia beating but feebly. Then is the right time for killing and fixing. In the case of more vigorous species, after three or four minutes another dose of two or three drops of the narcotic is added, and then repeated again if necessary until it is seen that the animals can move but very slowly. At this moment the animals are killed quickly and suddenly by adding one drop of very weak ($\frac{1}{4}$ to $\frac{1}{2}$ per cent.) solution of osmic acid.

The different species of Rotifers vary so much in their behaviour under the narcotic that it is by no means easy to always hit the exact moment for killing the animals fully extended; repeated failures and practice alone can guide one in this respect. It is very essential that the animals be still living when the osmic acid is added, as when a Rotifer is quite dead various post-mortem changes begin immediately to take place in the tissues, whilst it is desired to fix and preserve the tissues as in life. The word 'fixing' implies rapid killing and at the same time hardening of the tissues to such an extent as to prevent their undergoing any further change by subsequent treatment with preserving fluids. The action of osmic acid is very rapid, half a minute being quite enough; if

left much longer in this fluid the animals will become more or less blackened, and it is therefore necessary to remove the Rotifers as soon as possible, by means of the fine pipette, in three or four changes of clean water, so as to get rid of every trace of the acid. Finally the animals are transferred into the preservative fluid, which is a solution of $2\frac{1}{2}$ per cent. formaldehyde (the commercial formalin is a 40 per cent. solution of formaldehyde).

In this preservative the Rotifers are mounted in ringed or excavated cells on micro-slides in the usual way.¹

¹ More detailed particulars in the treatment of the various species and in mounting in cells will be found in Mr. Rousselet's papers on the subject, particularly those of March 1895 and November 1898, in the *Journ. of the Quckett Micr. Club*, vol. vi. pp. 5-13, and vol. vii. pp. 93-97.

CHAPTER XIV

FORAMINIFERA AND RADIOLARIA

RETURNING now to the lowest or *rhizopod* type of animal life (Chapter XII), we have to direct our attention to two very remarkable series of forms, almost exclusively marine, under which that type manifests itself, all of them distinguished by *skeletons* so consolidated by mineral deposit as to retain their form and intimate structure long after the animals to which they belonged have ceased to live, even for those undefined periods in which they have been imbedded as fossils in strata of various geological ages. In the first of these groups, the *Foraminifera*, the skeleton usually consists of a *calcareous* many-chambered shell, which closely invests the sarcode-body, and which, in a large proportion of the group, is perforated with numerous minute apertures; this shell, however, is sometimes replaced by a 'test,' formed of minute grains of sand cemented together; and there are a few cases in which the animal has no other protection than a membranous envelope. In the second group, the *Radiolaria*, the skeleton is always *silicious* and may either be composed of disconnected spicules, or may consist of a symmetrical open framework, or may have the form of a shell perforated by numerous apertures, which more or less completely incloses the body. The *Foraminifera* probably take, and always have taken, the largest share of any animal group in the maintenance of the solid calcareous portion of the earth's crust by separating from its solution in ocean-water the carbonate of lime continually brought down by rivers from the land. The *Radiolaria* do the same, though in far less measure, for the siliceous matter. And both extract from sea-water the organic matter universally diffused through it, converting it into a form that serves for the nutrition of higher marine animals.

SECTION I.—FORAMINIFERA.¹

The animals of this group belong to that *reticularian* form of the rhizopod type in which—with a differentiation between the containing and the contained protoplasm which is involved in the formation of a definite investment—a distinct *nucleus* (sometimes single, in other cases multiple) is probably always

¹ For the earlier literature consult Mr. C. D. Sherborn's 'Bibliography of the *Foraminifera*, recent and fossil, from 1565 to 1888,' London, 1888.

present.¹ The shells of Foraminifera are, for the most part, *polythalamous*, or many-chambered (Plates XVIII and XIX), often so strongly resembling those of *Nautilus*, *Spirula*, and other cephalopod molluscs, that it is not surprising that the older naturalists, to whom the structure of these animals was entirely unknown, ranked them under that class. But independently of the entire difference in the character of the animal bodies by which the two kinds of shells are formed, there is a most important distinction between them in regard to the relation of the animal to the shell. For whilst in the chambered shells of the *Nautilus* and other cephalopods the animal is a single individual tenanted only the last formed chamber, and withdrawing itself from each chamber in succession, as it adds to this another and larger one, the animal of a nautiloid foraminifer has a *composite* body consisting of a number (sometimes very large) of 'segments,' each repeating the rest, which continues to increase by *gemmation* or budding from the last-formed segment. And thus each of the chambers, however numerous they may be, is not only formed, but continues to be occupied by its own segment, which is connected with the segments of earlier and later formation by a continuous 'stolon' (or creeping stem), that passes through apertures in the *septa* or partitions dividing the chambers. From what we know of the semi-fluid condition of the sarcode-body in the reticularian type, there can be little doubt that there is an incessant circulatory change in the actual substance of each segment; so that the material taken in as food by the segments nearest the surface or margin is speedily diffused through the entire mass. The relation between these 'polythalamous' forms, therefore, and the *monothalamous* or single-chambered, of which we have already had an example in *Gromia*, and of which others will be presently described, is simply that, whereas any buds produced by the latter detach themselves to form separate individuals, those put forth by the former remain in continuity with the parent stock and with each other, so as to form a 'composite' animal and a 'polythalamous' shell.

According to the plan on which the gemmation takes place will be the configuration of the shelly structure produced by the segmented body. Thus, if the bud should be put forth from the aperture of a *Lagena* (Plate XIX, fig. 12) in the direction of the axis of its body, and a second shell should be formed around this bud in continuity with the first, and this process should be successively repeated, a straight rod-like shell would be produced, whose multiple chambers communicate with each other by the openings that originally constituted their mouths, the mouth of the last-formed chamber being the only aperture through which the protoplasmic body, thus composed of a number of segments connected by a peduncle or 'stolon' of the same material, could now project itself or draw in its food. The successive segments may be all of the same size, or nearly so, in which case the entire rod will approach the cylindrical form, or will resemble a line of beads; but it often happens that each segment is somewhat larger than the preceding

¹ Dr. Schaudinn (*Zeitschr. f. wiss. Zool.* lix, 1895, p. 191) has traced the details of nuclear division in *Calvituba polymorpha*.



Plate XVIII

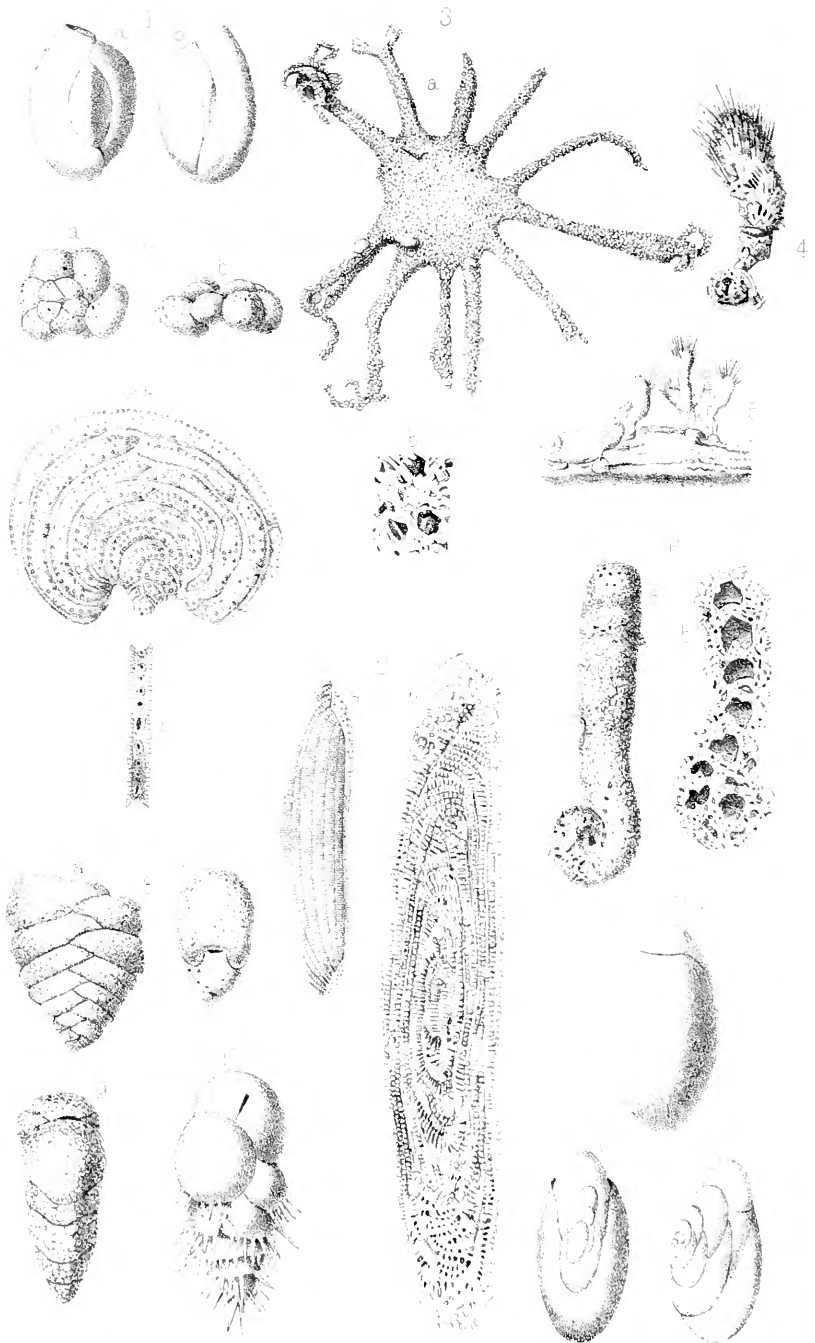

(fig. 16), so that the composite shell has a conical form, the apex of the cone being the original segment, and its base the last one formed. The method of growth now described is common to a large number of Foraminifera, chiefly belonging to the sub-family *Nodosarinae*; but even in that group we have every gradation between the *rectilineal* (fig. 16) and the *spiral* mode of growth (fig. 22); whilst in the genus *Peneroplis* it is not at all uncommon for shells which commence in a spiral to exchange this in a more advanced stage for the rectilineal habit. When the successive segments are added in a spiral direction, the character of the spire will depend in great degree upon the enlargement or non-enlargement of the successively formed chambers; for sometimes it opens out very rapidly, every whorl being considerably broader than that which it surrounds, in consequence of the great excess of the size of each segment over that of its predecessor, as in *Peneroplis*, fig. 606; but more commonly there is so little difference between the successive segments, after the spire has made two or three turns, that the breadth of each whorl scarcely exceeds that of its predecessor, as is well seen in the section of the *Rotalia* represented in fig. 624. An intermediate condition is



FIG. 606.—Foraminifera:—*Peneroplis* and *Orbiculina*.

presented by *Rotalia*, which may be taken as a characteristic type of a very large and important group of Foraminifera, whose general features will be presently described. Again, a spiral may be either 'nautiloid' or 'turbinoid,' the former designation being applied to that form in which the successive convolutions all lie in one plane (as they do in the *Nautilus*), so that the shell is 'equilateral' or similar on its two sides; whilst the latter is used to mark that form in which the spire passes obliquely round an axis, so that the shell becomes 'inequilateral,' having a more or less conical form, like that of a snail or a periwinkle, the first-formed chamber being at the apex. Of the former we have characteristic examples in *Polystomella* (Plate XIX, fig. 23) and *Nonionina*; whilst of the latter we find a typical representative in *Rotalia Beccarii* (fig. 22). Further, we find among the shells whose increase takes place upon the spiral plan a very marked difference as to the degree in which the earlier convolutions are invested and concealed by the latter. In the great *rotaline* group, whose characteristic form is a turbinoid spiral, all the convolutions are usually visible, at least on one side (fig. 17); but among the *nautiloid* tribes it more frequently happens that the last-formed whorl encloses the preceding

to such an extent that they are scarcely, or not at all, visible externally, as is the case in *Cristellaria* (fig. 17), *Polystomella* (fig. 23), and *Nonionina*. The turbinoid spire may coil so rapidly round an elongated axis that the number of chambers in each turn is very small; thus in *Globigerina* (figs. 20, 21, Plate XIX) there are usually only four; and in *Valvulina* the regular number is only three. Thus we are led to the *biserial* arrangement of the chambers, which is characteristic of the *textularian* group (fig. 8, *a*, *b*, and 9, Plate XVIII), in which we find the chambers arranged in two rows, each chamber communicating with that above and that below it on the opposite side, without any direct communication with the chamber of its own side, as will be understood by reference to fig.

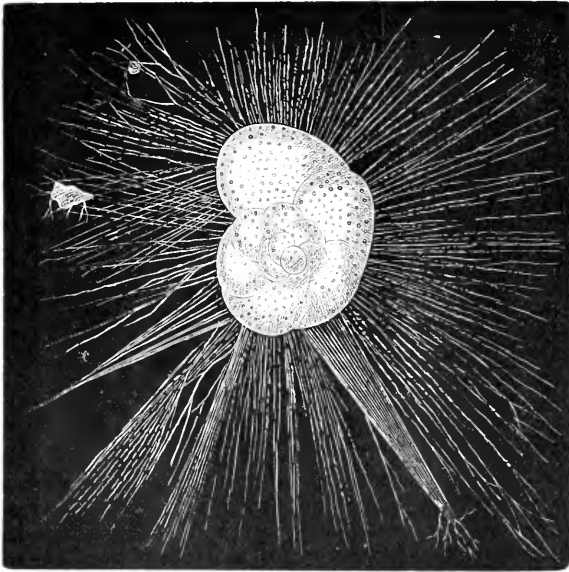
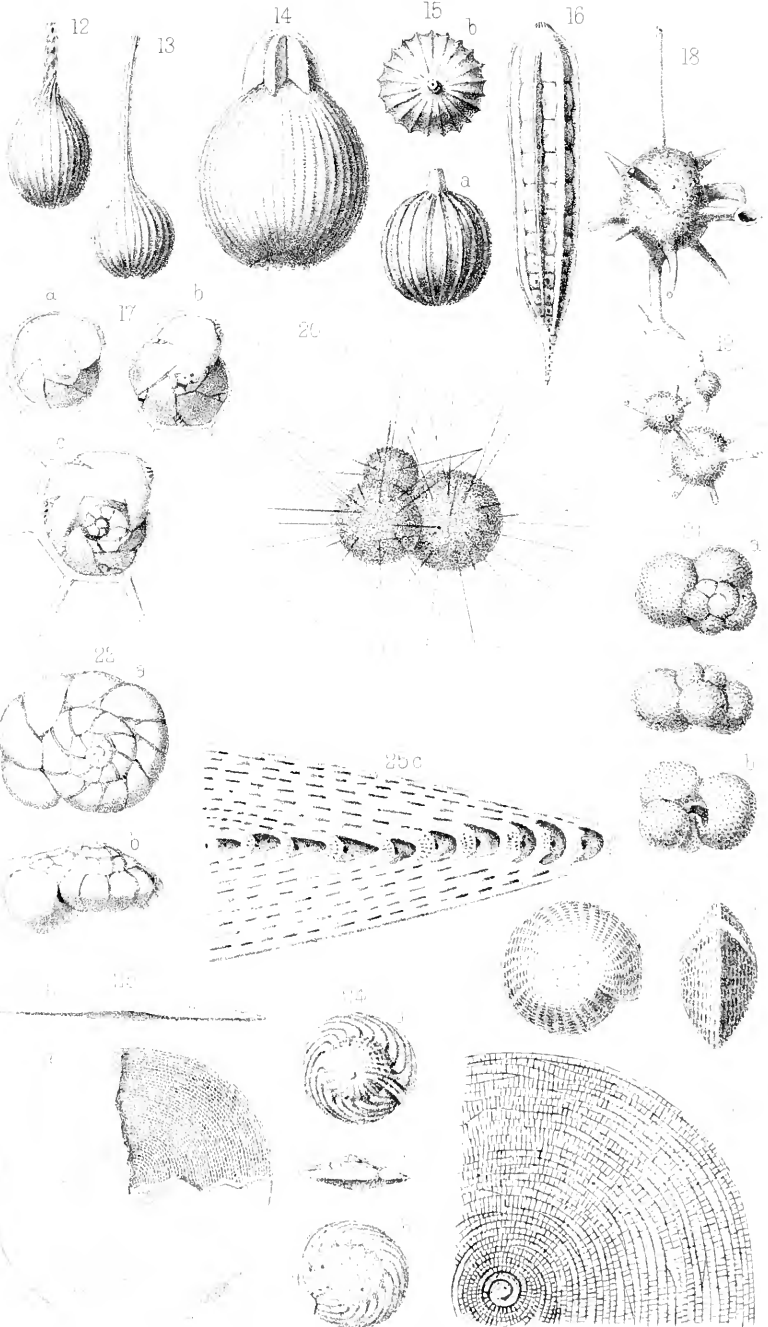

FIG. 607.—*Discorbina globularis* (*Rosalina varians*, Schultze), with its pseudopodia extended.

622, A. which shows a 'cast' of the sarcode-body of the animal. On the other hand, we find in the nautiloid spire a tendency to pass (by a curious transitional form to be presently described) into the *cyclical* mode of growth: in which the original segment, instead of budding forth on one side only, develops *gemma* all round, so that a ring of small chambers (or chamberlets) is formed around the primordial chamber, and this in its turn surrounds itself after the like fashion with another ring; and by successive repetitions of the same process the shell comes to have the form of a disc made up of a great number of concentric rings, as we see in *Orbitolites* (fig. 609) and in *Cyclolypus* (fig. 627).

These and other differences in the *plan of growth* were made by

Plate XIX



M. d'Orbigny the foundation of his classification of this group, which, though at one time generally accepted, has now been abandoned by most of those who have occupied themselves in the study of the Foraminifera. For it has come to be generally admitted that 'plan of growth' is a character of very subordinate importance among the Foraminifera, so that any classification which is primarily based upon it must necessarily be altogether unnatural, those characters being of primary importance which have an immediate and direct relation to the physiological condition of the animal, and are thus indicative of the real affinities of the several groups which they serve to distinguish. The most important of these characters will now be noticed.¹

Two very distinct types of shell structure prevail among ordinary Foraminifera—namely, the *porcellanous* and the *hyaline* or *vitreous*. The shell of the former, when viewed by reflected light, presents an opaque-white aspect which bears a strong resemblance to porcelain; but when thin natural or artificial laminae of it are viewed by transmitted light the opacity gives place to a rich brown or amber colour, which in a few instances is tinged with crimson. No structure of any description can be detected in this kind of shell substance, which is apparently homogeneous throughout. Although the shells of this 'porcellanous' type often present the appearance of being perforated with foramina, yet this appearance is illusory, being due to a mere 'pitting' of the external surface, which, though often very deep, never extends through the whole thickness of the shell. Some kind of inequality of that surface, indeed, is extremely common in the shells of the 'porcellanous' Foraminifera, one of the most frequent forms of it being a regular alternation of ridges and furrows, such as is occasionally seen in *Miliola*, but which is an almost constant characteristic of *Peucomplis* (fig. 606). But no difference of texture accompanies either this or any other kind of inequality of surface, the raised and depressed portions being alike homogeneous. In the shells of the *vitreous* or *hyaline* type, on the other hand, the proper shell substance has an almost glassy transparency, which is shown by it alike in thin natural lamellae and in artificially prepared specimens of such as are thicker and older. It is usually colourless, even when (as in the case with many *Rotalina*) the substance of the animal is deeply coloured; but in some few species, such as *Globigerina rubra*, *Truncatulina rosea*, and *Polytrema miniaceum*, the shell is commonly, like the animal body, of a more or less deep crimson hue. All the shells of the hyaline type are beset more or less closely with *tubular perforations*, which pass directly, and (in general) without any subdivision, from one surface to the other. These tubuli are in some instances sufficiently coarse for their orifices to be distinguished with a low magnifying power as 'punctations' on the surface of the shell, as is shown in fig. 607; whilst in other cases they are so minute as only to be discernible in thin sections seen by transmitted light under a higher magnifying

¹ This subject will be found amply discussed in the Author's *Introduction to the Study of the Foraminifera*, published by the Ray Society, to which work he would refer such of his readers as may desire more detailed information in regard to it.

power, as is shown in figs. 632, 633. When they are very numerous and closely set, the shell derives from their presence that kind of opacity which is characteristic of all minutely tubular textures whose tubuli are occupied either by air or by any substance having a refractive power different from that of the intertubular substance, however perfect may be the transparency of the latter. The straightness, parallelism, and isolation of these tubuli are well seen in vertical sections of the thick shells of the largest examples of the group, such as *Nummulites* (fig. 631). It often happens, however, that certain parts of the shell are left unchannelled by these tubuli; and such are readily distinguished, even under a low magnifying power, by the readiness with which they allow transmitted light to pass through them, and by the peculiar vitreous lustre they exhibit when light is thrown obliquely on their surface. In shells formed upon this type we frequently find that the surface presents either bands or spots which are so distinguished, the non-tubular *bands* usually marking the position of the septa, and being sometimes raised into ridges, though in other instances they are either level or somewhat depressed; whilst the non-tubular *spots* may occur on any part of the surface, and are most commonly raised into tubercles, which sometimes attain a size and number that give a very distinctive aspect to the shells that bear them.

Between the comparatively *coarse* perforations which are common in the *rotaline* type, and the *minute* tubuli which are characteristic of the *nummuline*, there is such a continuous gradation as indicates that their mode of formation, and probably their uses, are essentially the same. In the former, it has been demonstrated by actual observation that they allow the passage of pseudopodial extensions of the sarcode-body through every part of the external wall of the chambers occupied by it (fig. 607); and there is nothing to oppose the idea that they answer the same purpose in the latter, since, minute as they are, their diameter is not too small to enable them to be traversed by the finest of the threads into which the branching pseudopodia of Foraminifera are known to subdivide themselves. Moreover the close approximation of the tubuli in the most finely perforated nummulines makes their collective area fully equal to that of the larger but more scattered pores of the most coarsely perforated rotalines. Hence it is obvious that the *tubulation* or *non-tubulation* of foraminiferal shells is the key to a very important physiological difference between the animal inhabitants of the two kinds respectively; for whilst every segment of the sarcode-body in the former case gives off pseudopodia, which pass at once into the surrounding medium, and contribute by their action to the nutrition of the segment from which they proceed, these pseudopodia are limited in the latter case to the *final* segment, issuing forth only through the aperture of the last chamber, so that all the nutrient material which they draw in must be first received into the last segment, and be transmitted thence from one segment to another until it reaches the earliest. With this difference in the physiological condition of the animal of these two types is usually associated a further very important difference in the conformation of the shell—viz.

that whilst the aperture of communication between the chambers and between the last chamber and the exterior is usually very small in the 'vitreous' shells, serving merely to give passage to a slender *stolon* or thread of sarcode from which the succeeding segment may be budded off, it is much wider in the 'porcellanous' shells, so as to give passage to a 'stolon' that may not only bud off new segments, but may serve as the medium for transmitting nutrient material from the outer to the inner chambers.

Between the highest types of the *porcellanous* and the *vitreous* series respectively, which frequently bear a close resemblance to each other in *form*, there are certain other well-marked differences in *structure*, which clearly indicate their essential dissimilarity. Thus, for example, if we compare *Orbitolites* (fig. 609) with *Cycloclypeus* we recognise the same plan of growth in each, the chamberlets being arranged in concentric rings around the primordial chamber; and to a superficial observer there would appear little difference between them. But a minuter examination shows that not only is the texture of the shell 'porcellanous' and non-tubular in *Orbitolites*, whilst it is 'vitreous' and minutely tubular in *Cycloclypeus*, but that the partitions between the chamberlets are *single* in the former, whilst they are *double* in the latter, each segment of the sarcode-body having its own proper shelly investment. Moreover, between these double partitions an additional deposit of calcareous substance is very commonly found, constituting what may be termed the *intermediate skeleton*; and this is traversed by a peculiar system of inosculating *canals*, which pass around the chamberlets in interspaces left between the two laminae of their partitions, and which seem to convey through its substance extensions of the sarcode-body whose segments occupy the chamberlets. We occasionally find this 'intermediate skeleton' extending itself into peculiar *outgrowths*, which have no direct relation to the chambered shell. Of this we have a very curious example in *Calcarina*; and it is in these that we find the 'canal system' attaining its greatest development. Its most regular distribution, however, is seen in *Polystomella* and in *Operculina*; and an account of it will be given in the description of those types.

Porcellanea.—Commencing, now, with the *porcellanous* series, we shall briefly notice some of its most important forms, which are so related to each other as to constitute but the one family *Miliolida*. Its simplest type is presented by the *Cornuspira* of our own coasts, found attached to seaweeds and zoöphytes; this is a minute spiral shell, of which the interior forms a continuous tube not divided into chambers; the latter portion of the spire is often very much flattened out, as in *Peneroplis*, so that the form of the mouth is changed from a circle to a long narrow slit. Among the commonest of the Foraminifera, and abounding near the shores of almost every sea, are some forms of the *milioline* type, so named from the resemblance of some of their minute fossilised forms (of which enormous beds of limestone in the neighbourhood of Paris are almost entirely composed) to millet-seeds. The peculiar mode of growth by which these are characterised will be best understood by examining, in the first

instance, the form which has been designated as *Spiroloculina*. This shell is a spiral, elongated in the direction of one of its diameters, and having at each turn a contraction at either end of that diameter which partially divides each convolution into two chambers; the separation between the consecutive chambers is often made more complete by a peculiar projection from the inner side of the cavity, known as the 'tongue' or 'valve,' which may be considered as an imperfect septum. Now it is a very common habit in the milioline type for the chambers of the later convolutions to extend themselves over those of the earlier, so as to conceal them more or less completely; and this they very commonly do somewhat unequally, so that more of the earlier chambers are visible on one side than on the other. *Miliolæ* thus modified (fig. 1, Pl. XVIII) have received the names of *Quinqueloculina* and *Triloculina* according to the number of chambers visible externally; but the extreme inconstancy which is found to mark such distinctions, when the comparison of specimens has been sufficiently extended, entirely destroys their value as differential characters, and the term *Miliolina* is now more frequently applied to them collectively. Sometimes, on the other hand, the earlier convolutions are so completely concealed by the later that only the two chambers of the last turn are visible externally; and in this type, which has been designated *Biloculina*, there is often such an increase in the breadth of the chambers as altogether changes the usual proportions of the shell, which has almost the shape of an egg when so placed that either the last or the penultimate chamber faces the observer. It is very common in milioline shells for the external surface to present a 'pitting,' more or less deep, a ridge-and-furrow arrangement (fig. 3), or a honeycomb division; and these diversities have been used for the characterisation of species. Not only, however, may every intermediate gradation be met with between the most strongly marked forms, but it is not at all uncommon to find the surface smooth on some parts, whilst other parts of the surface in the same shell are deeply pitted or strongly ribbed or honeycombed; so that here, again, the inconstancy of these differences deprives them of much of their value as distinctive characters.

An interesting illustration of the tendency to dimorphism amongst the Foraminifera has been observed by MM. Muir Chalmas and Schlumberger¹ in the structure of the shells of this group. They find that while two forms, which they distinguish as form A and form B, are similar externally they differ in internal structure, form B having its initial chamber much smaller than that of form A, and this 'microsphere' is followed by a larger number of chambers than is the 'megaspere' of form A. What this difference signifies it is at present impossible to say, but it has been suggested that it may be one of sexual character, or, better, of a series in a cycle of generations. The observations of the French naturalists referred to open out a new field of inquiry, and one which is enjoying the attention of several workers in this department of research.²

¹ *Bulletin Soc. Géol.* ser. iii. vol. xiii. p. 273.

² Cf. J. J. Lister in *Phil. Trans.* 136 B (1895), p. 401, and F. Schandinn, 'Ueber den Dimorphismus der Foraminiferen,' *S.B. Ges. Naturf. Berlin*, 1895, p. 87.

Reverting again to the primitive type presented in the simple spiral of *Cornuspira*, we find the most complete development of it in *Peneroplis* (fig. 606), a very beautiful form, which, although not to be found on our own coasts, is one of the commonest of all Foraminifera in the shore-sands and shallow-water dredgings of warmer regions. This is normally a nautiloid shell, of which the spire flattens itself out as it advances in growth. It is marked externally by a series of transverse bands, which indicate the position of the internal septa that divide the cavity into chambers; and these chambers communicate with each other by numerous minute pores traversing each of the septa, and giving passage to threads of sarcode that connect the segments of the body. At *a* is shown the 'septal plane' closing in the last-formed chamber, with its single row of pores through which the pseudopodial filaments extend themselves into the surrounding medium. The surface of the shell, which has a peculiarly 'porcellanous' aspect, is marked by closely set *striae* that cross the spaces between the successive septal bands; these markings, however, do not indicate internal divisions, and are due to a surface-furrowing of the shelly walls of the chambers. This type passes into two very curious modifications, one having a spire which, instead of flattening itself out, remains turgid, like that of a *Nautilus*, having only a single aperture, which sends out fissured extensions that subdivide like the branches of a tree, suggesting the name of *Dendritina*, the other having its spire continued in a rectilinear direction, so that the shell takes the form of a crosier, this being distinguished by the name of *Spirolina*. A careful examination of intermediate forms, however, has made it evident that these modifications, though ranked as of generic value by M. d'Orbigny, are merely *varietal*, a continuous gradation being found to exist from the elongated septal plane of the typical *Peneroplis*, with its single row of isolated pores, to the arrow-shaped septal plane of *Dendritina*, with all its pores fused together (so to speak) into one dendritic aperture, and a like gradation being presented between the ordinary forms and the 'spiroline' varieties, with oval or even circular septal plane, into which both *Peneroplis* and *Dendritina* tend to elongate themselves.

From the ordinary nautiloid multilocular spiral we now pass to a more complex and highly developed form, which is restricted to tropical and subtropical regions, but is there very abundant—that, namely, which has received the designation *Orbiculina* (fig. 606). The relation of this to the preceding type will be best understood by an examination of its earlier stage of growth; for here we see that the shell resembles that of *Peneroplis* in its general form, but that its principal chambers are divided by 'secondary septa' passing at right angles to the primary into 'chamberlets' occupied by sub-segments of the sarcode-body. Each of these secondary septa is perforated by an aperture, so that a continuous gallery is formed, through which (as in fig. 609) there passes a stolon that unites together all the sub-segments of each row. The chamberlets of successive rows alternate with one another in position; and the pores of the principal septa are so disposed that each chamberlet of

any row normally communicates with two chamberlets in each of the adjacent rows. The later turns of the spire very commonly grow completely over the earlier, and thus the central portion or 'umbilicus' comes to be protuberant, whilst the growing edge is thin. The spire also opens out at its growing margin, which tends to encircle the first-formed portion, and thus gives rise to the peculiar shape represented in fig. 606, in the illustration on the extreme right, which is the common *aduncal* type of this organism. But sometimes even at an early age the growing margin extends so far round on each side that its two extremities meet on the opposite side of the original spire, which is thus completely inclosed by it; and its subsequent growth is no longer *spiral* but *cyclical*, a succession of *concentric rings* being added, one around the other, as shown in the middle illustration in the same figure. This change is extremely curious, as demonstrating the intimate relationship between the *spiral* and the *cyclical* plans of growth, which at first sight appear essentially distinct. In all but the youngest examples of *Orbiculina* the septal plane presents more than a single row of pores, the number of rows increasing in the thickest specimens to six or eight. This increase is associated with a change in the form of the sub-segments of sarcode from little blocks to columns, and with a greater complexity in the general arrangement, such as will be more fully described hereafter in *Orbitolites*. The largest existing examples of this type are far surpassed in size by those which make up a considerable part of a Tertiary limestone on the Malabar coast of India, whose diameter reaches seven or eight lines.

A very curious modification of the same general plan is shown in *Alveolina*, a genus of which the largest existing forms (fig. 608) are commonly about one-third of an inch long, while far larger specimens are found in the Tertiary limestones of Scinde. Here the spire turns round a very elongate axis, so that the shell has almost the form of a cylinder drawn to a point at each extremity. Its surface shows a series of longitudinal lines which mark the principal septa; and the bands that intervene between these are marked transversely by lines which show the subdivision of the principal chambers into 'chamberlets.' The chamberlets of each row are connected with each other, as in the preceding type, by a continuous gallery; and they communicate with those of the next row by a series of multiple pores in the principal septa, such as constitute the external orifices of the last-formed series seen on its septal plane at *a. a.*

The highest development of the cyclical plan of growth which we have seen to be sometimes taken on by *Orbiculina* is found in *Orbitolites*; a type which, long known as a very abundant fossil in the earlier Tertiaries of the Paris basin, has lately proved to be scarcely less abundant in certain parts of the existing ocean. The largest recent specimens of it, sometimes attaining the size of a shilling, have hitherto been obtained only from the coast of New Holland, the Fijian reefs, and various other parts of the Polynesian Archipelago; but discs of comparatively minute size and simpler organisation are to be found in almost all foraminiferal sands and dredgings from the shores of the warmer regions of the globe, being

especially abundant in those of some of the Philippine Islands, of the Red Sea, of the Mediterranean, and especially of the Ægean. When such discs are subjected to microscopic examination, they are found (if uninjured by abrasion) to present the structure represented in fig. 609, where we see on the surface (by incident light) a number

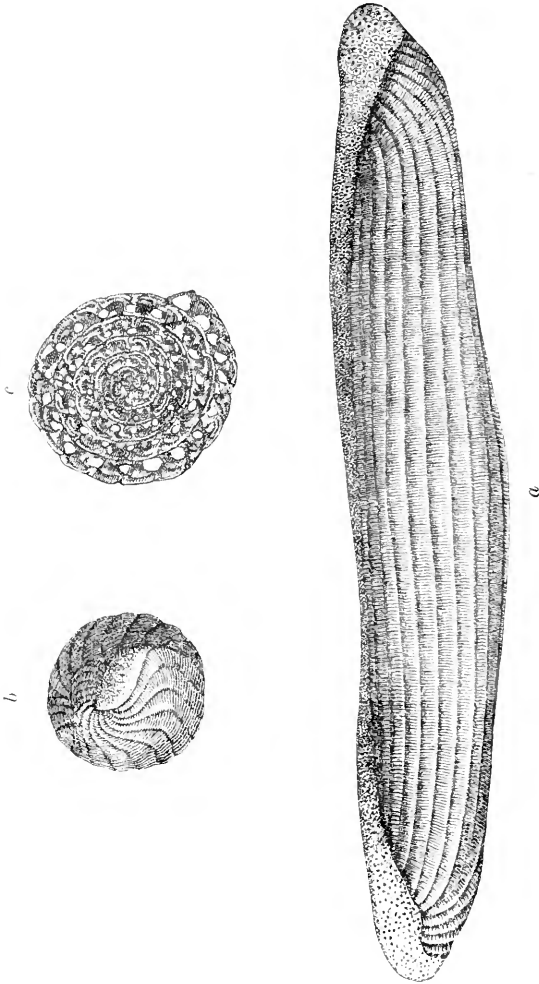

FIG. 608. — *Alveolina Bosetti*: a, lateral aspect; b, terminal aspect; c, transverse section of shell.

of rounded elevations, arranged in concentric zones around a sort of nucleus (which has been laid open in the figure to show its internal structure); whilst at the margin we observe a row of rounded projections with a single aperture or pore in each of the intervening depressions. In very thin discs the structure may often be brought into view by mounting them in Canada balsam and transmitting

light through them ; but in those which are too opaque to be thus seen through, it is sufficient to rub down one of the surfaces upon a stone, and then to mount the specimen in balsam. Each of the superficial elevations will then be found to be the roof or cover of an ovate cavity or 'chamberlet,' which communicates by means of a lateral passage with the chamberlet on either side of it in the same ring ; so that each circular zone of chamberlets might be described as a continuous annular passage dilated into cavities at intervals. On the other hand, each zone communicates with the zones that are internal and external to it by means of passages in a radiating direction ; these passages run, however, not from the chamberlets of the inner zone to those of the outer, but from the connecting passages of the former to the chamberlets of the latter ; so that the chamberlets of each zone *alternate* in position with those of the zones

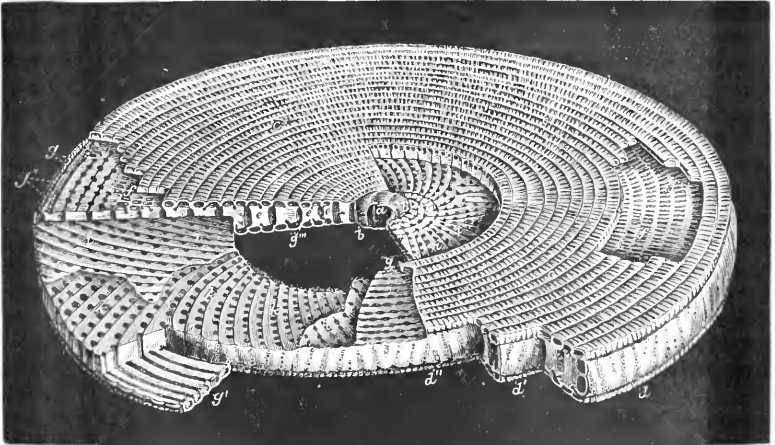

FIG. 609.—*Orbitolites*. Ideal representation of a disc of complex type.

internal and external to it. The radial passages from the outermost annulus make their way at once to the margin, where they terminate, forming the 'pores' which (as already mentioned) are to be seen on its exterior. The central nucleus, when rendered sufficiently transparent by the means just adverted to, is found to consist of a 'primordial chamber' (*a*), usually somewhat pear-shaped, that communicates by a narrow passage with a much larger 'circumambient chamber' (*b*), which nearly surrounds it, and which sends off a variable number of radiating passages towards the chamberlets of the first zone, which forms a complete ring round the circumambient chamber.¹

¹ Although the above may be considered the *typical* form of the Orbitolite, yet, in a very large proportion of specimens, the first few zones are not complete circles, the early growth having taken place from one side only ; and there is a very beautiful variety in which this one-sidedness of increase imparts a distinctly *spiral* character to the early growth, which soon, however, gives place to the *cyclical*. In the *Orbitolites italica* (fig. 611), brought up from depths of 1,500 fathoms or more, the 'nucleus'

The idea of the nature of the living occupant of these cavities which might be suggested by the foregoing account of their arrangement, is fully borne out by the results of the examination of the sarcode-body, which may be obtained by the maceration in dilute acid (so as to remove the shelly investment) of specimens of *Orbitolites* that have been gathered fresh and preserved in spirit. For this body is found to be composed (fig. 610) of a multitude of segments of sarcode, presenting not the least trace of higher organisation in any part, and connected together by 'stolons' of the like substance. The 'primordial' pear-shaped segment, *a*, is seen to have budded off its 'circumambient' segment, *b*, by a narrow foot-stalk or stolon; and this circumambient segment, after passing almost entirely round the primordial, has budded off three stolons, which swell into new sub-segments from which the first ring is formed. Scarcely any two specimens are precisely alike as to the mode in which the first ring originates from the 'circumambient segment'; for sometimes a score or more of radial passages extend themselves from every part of the margin of the latter (and this, as corresponding with the plan of growth afterwards followed, is probably the *typical* arrangement); whilst in other cases (as in the example before us) the number of these primary offsets is extremely small. Each zone is seen to consist of an assemblage of ovate sub-segments, whose height (which could not be shown in the figure) corresponds with the thickness of the disc; these sub-segments, which are all exactly similar and equal to one another, are connected by annular stolons; and each zone is connected with that on its exterior by radial extensions of those stolons passing off from the sub-segments.

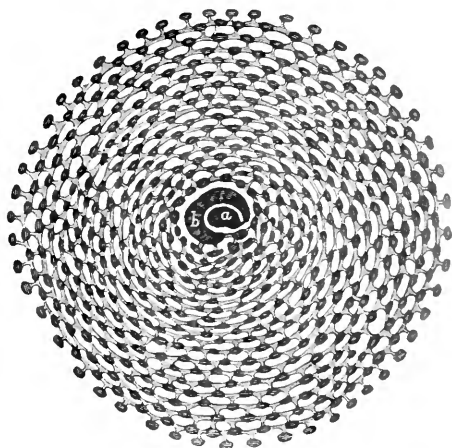

FIG. 610.—Composite animal of simple type of *Orbitolites complanata*:—*a*, central mass of sarcode; *b*, circumambient segment, giving off peduncles, in which originate the concentric zones of sub-segments connected by annular bands.

The radial extensions of the outermost zone issue forth as pseudopodia from the marginal pores, searching for and drawing in alimentary materials in the manner formerly described; the whole of the soft body, which has no communication whatever with

is formed by three or four turns of a spiral closely resembling that of a *Cornuspira* with an interruption at every half-turn, as in *Spiroloculina*, the growth afterwards becoming purely concentric.

the exterior, save through these marginal pores, being nourished by the transmission of the products of digestion from zone to zone through similar bands of protoplasmic substance. In all cases in which the growth of the disc takes place with normal regularity it is probable that a complete circular zone is added at once. Thus we find this simple type of organisation giving origin to fabrics of by no means microscopic dimensions, in which, however, there is no other differentiation of parts than that concerned in the formation of the shell, every segment and every stolon (with the exception of the two forming the 'nucleus') being, so far as can be ascertained, a precise repetition of every other, and the segments of the nucleus differing from the rest in nothing else than their form. The equality of the endowments of the segments is shown by the fact—of which accident has repeatedly furnished proof—that a small portion of a disc, entirely separated from the remainder, will not only continue

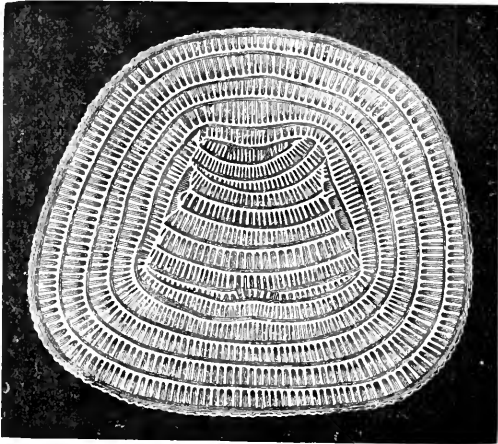

FIG. 611.—Disc of *Orbitolites italica*, Costa, sp. (*O. tenuissima*, Carp.), formed round fragment of previous disc.

to live, but will so increase as to form a new disc (fig. 611), the want of the 'nucleus' not appearing to be of the slightest consequence, from the time that active life is established in the outer zones.

One of the most curious features in the history of this type is its capacity for developing itself into a form which, whilst fundamentally the same as that previously described, is very much more complex. In all the larger specimens of *Orbitolites* we observe that the marginal pores, instead of constituting but a single row, form many rows one above another; and, besides this, the chamberlets of the two surfaces, instead of being rounded or ovate in form, are usually oblong and straight-sided, their long diameters lying in a radial direction, like those of the cyclical type of *Orbiculina*. When a vertical section is made through such a disc, it is found that these oblong chambers constitute two *superficial* layers, between which

are interposed *columnar* chambers of a rounded form; and these last are connected together by a complex series of passages, the arrangement of which will be best understood from the examination of a part of the sarcode-body that occupies them (fig. 612). For the oblong superficial chambers are occupied by sub-segments of sarcode, *c c, d d*, lying side by side, so as to form part of an annulus, but each of them disconnected from its neighbours, and communicating only by a double footstalk with the two annular 'stolons,' *a a', b b'*, which obviously correspond with the single stolon of 'simple' types (fig. 610). These indirectly connect together not merely all the superficial chamberlets of each zone, but also the columnar sub-segments of the intermediate layer; for these columns (*e e, e' e'*) terminate above and below in the annular stolons, sometimes passing directly from one to the other, but sometimes going out of their direct course to coalesce with another column. The columns of the successive zones (two sets of which are shown in the figure) communicate with each other by threads of sarcode in such a manner that (as in the simple type) each column is thus brought into connection with two columns of the zone next interior, to which it alternates in position. Similar threads, passing off from the outermost zone through the multiple ranges of marginal pores, would doubtless act as pseudopodia.

Now this plan of growth is so different from that previously described that there would at first seem ample ground for separating the *simple* and the *complex* types as distinct species. But the test furnished by the examination of a *large number*

of specimens, which ought never to be passed by when it can possibly be appealed to, furnishes these very singular results: 1st, that the two forms must be considered as specifically identical; since there is not only a gradational passage from one to the other, but they are often combined in the same individual, the *inner* and first-formed portion of a large disc frequently presenting the simple type, whilst the *outer* and later-formed part has developed itself upon the complex; 2nd, that although the last-mentioned circumstance would naturally suggest that the change from the one plan to another may be simply a feature of advancing age, yet this cannot be the case: since, although the complex sometimes evolves itself even from the very first (the 'nucleus,' though resembling that of the simple form, sending

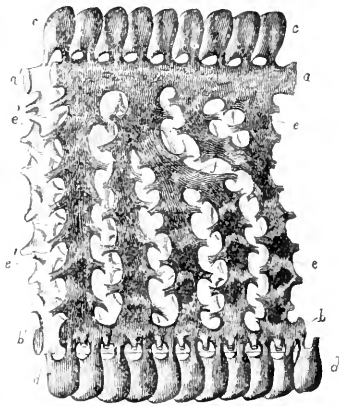

FIG. 612.—Portion of animal of complex type of *Orbitolites complanata*: *a a', b b'*, the upper and lower rings of two concentric zones; *c c*, the upper layer of superficial sub-segments, and *d d*, the lower layer, connected with the annular bands of both zones; *e e* and *e' e'*, vertical sub-segments of the two zones.

out two or more tiers of radiating threads), more frequently the simple prevails for an indefinite number of zones, and then changes itself in the course of a few zones into the complex. No department of natural history could furnish more striking instances than are afforded by the different forms presented by the foraminiferal types now described, of the wide *range of variation* that may occur within the limits of one and the same species; and the microscopist needs to be specially put on his guard as to this point in respect to the lower types of animal as to those of vegetable life, since the determination of form seems to be far less precise among such than it is in the higher types.¹

In what manner the reproduction of *Orbitolites* is accomplished, we can as yet do little more than guess; but from appearances sometimes presented by the sarcode-body, it seems reasonable to infer that *gemmules*, corresponding with the zöospores of proto-phytes, are occasionally formed by the breaking up of the sarcode into globular masses, and that these, escaping through the marginal pores, are sent forth to develop themselves into new fabrics.

Arenacea.—In certain forms of the preceding family, and especially in the genus *Miliola*, we not unfrequently find the shells encrusted with particles of sand, which are imbedded in the proper shell substance. This incrustation, however, must be looked on as (so to speak) accidental, since we find shells that are in every other respect of the same type altogether free from it. A similar accidental incrustation presents itself among certain ‘vitreous’ and perforate shells; but there, too, it is usually on a basis of true shell, and the sandy incrustation is often entirely absent. There is, however, a group of Foraminifera in which the true shell is constantly and entirely *replaced* by a sandy envelope, which is distinguished as a ‘test,’ the arenaceous particles being held together only by a cement exuded by the animal. It is not a little curious that the forms of these arenaceous ‘tests’ should represent those of many different types among both the ‘porcellanous’ and the ‘vitreous’ series; whilst yet they graduate into one another in such a manner as to indicate that all the members of this ‘arenaceous’ group are closely related to each other, so as to form a series of their own. And it is further remarkable that while the deep-sea dredgings recently carried down to depths of from 1,000 to 2,500 fathoms have brought up few forms of either ‘porcellanous’ or ‘vitreous’ Foraminifera that were not previously known, they have added greatly to our knowledge of the ‘arenaceous’ types, the number and variety of which far exceed all previous conception. These have been systematically described by Mr. H. B. Brady, F.R.S.,² whose researches have led him to believe that the long-established division

¹ For further information on the subject of *Orbitolites* see the Author's account of the genus in the reports of H.M.S. *Challenger*. Mr. H. B. Brady in his ‘*Challenger*’ Report (p. 224) describes a remarkable allied type from the Southern Ocean—*Keramosphæra Murrayi*—in which the test is spherical, and the chambers are arranged in concentric layers.

² See his important report on the Foraminifera dredged by H.M.S. *Challenger* (1884), illustrated by 116 plates. A large number of deep-sea forms has lately been described by Dr. A. Goes, from the dredgings of the *Albatross*; see *Bull. Mus. Comp. Zool.* xxix. (1896).

of the Foraminifera into the arenaceous and calcareous groups does not correspond to any natural arrangement; for, although the rule is tolerably constant in many groups, there are others, notably certain sub-families of *Textulariidae*, in which it is by no means uniform.

In the midst of the sandy mud which formed the bottom where the warm area of the 'Globigerina mud' abutted on that over which a glacial stream flowed, there were found a number of little pellets, varying in size from a large pin's head to a large pea, formed of an aggregation of sand-grains, minute foraminifers, &c., held together by a tenacious protoplasmic substance. On tearing these open the whole interior was found to have the same composition, and no trace of any structural arrangement could be discovered in their mass. Hence they might be supposed to be mere accidental agglomerations were it not for their conformity to the 'monerozoic' type previously described; for, just as a simple 'moner.' by a differentiation of its homogeneous sarcode, becomes an *Amoeba*, so would one of these uniform blendings of sand and sarcode by a separation of its two components—the sand forming the investing 'test' and the sarcode occupying its interior—become the arenaceous *Astrochiza*. This type, which abounds on the sea-bed in certain localities presents remarkable variations of form, being sometimes globular, sometimes stellate, sometimes cervicorn. But the same general arrangement prevails throughout, the cavity being occupied by a dark-green sarcode, while the 'test' is composed of loosely aggregated sand-grains not held together by any recognisable cement, and has *no definite orifice*, so that the pseudopodia must issue from interstices between the sand-grains, which spaces are probably occupied during life with living protoplasm that continues to hold together the sand-grains after death. These are by no means microscopic forms, the 'stellate' varieties ranging to 0·3 or even 0·4 inch in diameter, and the 'cervicorn' to nearly 0·5 inch in length.¹ A much larger form was found by Mr. Brady among the dredgings made in the Faroë Channel (see his "Challenger" Report, p. 242); *Syringamina* appears, when complete, to have been a sphere about an inch and a half in diameter; owing to its large size the almost complete absence of cement becomes very noticeable, for the fragile form can scarcely support its own weight when taken out of the water.

Later on another large and interesting type belonging to the same group was obtained by Mr. Wood-Mason, late of the Indian Museum, from the Bay of Bengal.² This has received the generic name *Masonella*. The test consists of a thin sandy disc, nearly half an inch in diameter, either flat or saucer-shape, with a central chamber and simple or branched radiating tubuli open at the periphery.

The purely *arenaceous* Foraminifera are ranged by Mr. H. B. Brady³ (by whom they have been especially studied) under two

¹ See the description and figures of this type given by the Author in *Quart. Journ. Microsc. Sci.* vol. xvi. 1876, p. 221.

² *Ann. and Mag. Nat. Hist.* 1889, ser. vi. vol. iii. p. 293, woodcuts.

³ See his 'Notes' in *Quart. Journ. of Microsc. Sci.* n.s. vol. xix. 1879, p. 20, and vol. xxi. 1881, p. 31.

families, the first of which, *Astrohizida*, includes with the preceding a number of coarse sandy forms, usually of considerable size, and essentially monothalamous, though sometimes imperfectly chambered by constrictions at intervals. Some of the more interesting examples of this family will now be noticed, beginning with the *Saccamina*¹ (Sars), which is a remarkably regular type, composed of coarse sand-grains firmly cemented together in a globular form, so as to constitute a wall nearly smooth on the outer, though rough on the inner surface, with a projecting neck surrounding a circular mouth (fig. 613, *a, b, c*). This type, which occurs in extraordinary abundance in certain localities (as the entrance of the Christiania fjord, and still further north on the shores of Franz Josef Land), is of peculiar interest from the fact that a closely allied species (*Saccamina Carteri*) is,

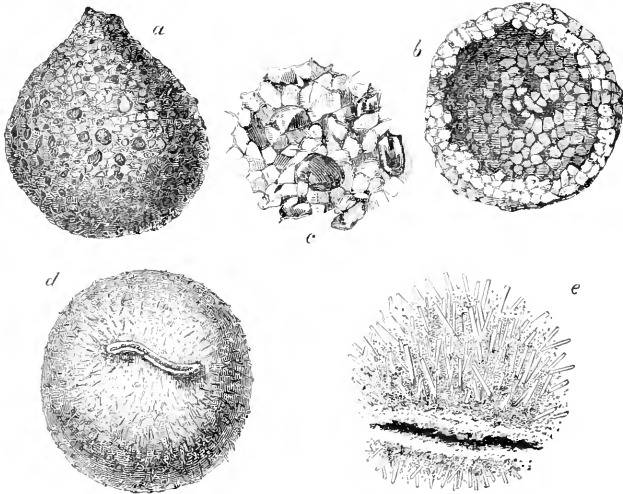

FIG. 613. —Arenaceous Foraminifera: *a*, *Saccamina spherica*; *b*, the same laid open; *c*, portion of the test, enlarged to show its component sand-grains; *d*, *Pilulina Jeffreysi*; *e*, portion of the test enlarged, showing the arrangement of the sponge-spicules.

as Mr. H. B. Brady has shown, one of the chief constituents of certain beds of the Lower Carboniferous limestone of the north of England and elsewhere. In striking contrast to the preceding is another single-chambered type, distinguished by the whiteness of its 'test,' to which the Author has given the name of *Pilulina*, from its resemblance to a homœopathic 'globule' (fig. 613, *d, e*). The form of this is a very regular sphere; and its orifice, instead of being circular and surrounded by a neck, is a slit or fissure with slightly raised lips, and having a somewhat S-shaped curvature. It is by the structure of its 'test,' however, that it is especially distinguished; for this is composed of the finest ends of sponge-spicules, very regularly 'laid' so as to form a kind of felt, through the sub-

¹ For a detailed account of *S. spherica* consult L. Rumbler, in vol. lvii. of *Zeitschr. f. wiss. Zool.*

stance of which very fine sand-grains are dispersed. This 'felt' is somewhat flexible, and its components do not seem to be united by any kind of cement, as it is not affected by being boiled in strong nitric acid; its tendency, therefore, seems entirely due to the wonderful manner in which the separate silicious fibres are 'laid.' It is not a little curious that these two forms should present themselves in the same dredging, and that there should be no perceptible difference in the character of their sarcode bodies, which, as in the preceding case, have a dark-green hue. The *Marsipella elongata* (fig. 614, *d*), on the other hand, is somewhat fusiform in shape, and has its two extremities elongated into tubes, with a circular orifice at the end of each. The materials of the 'tests' differ remarkably according to the nature of the bottom whereon they live. When

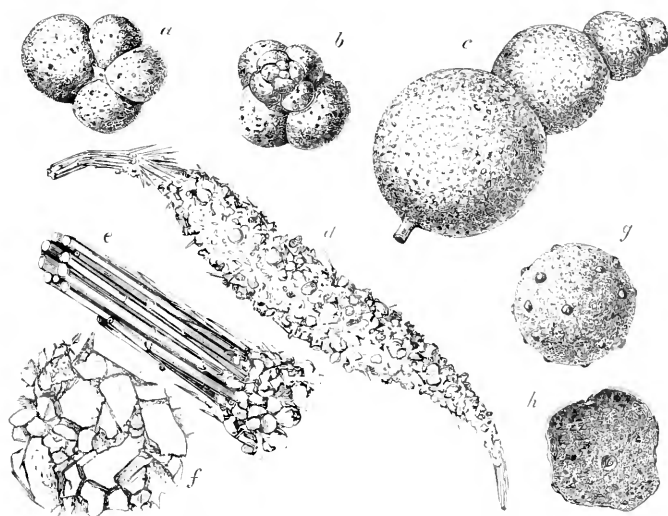

FIG. 614.—Arenaceous Foraminifera: *a*, *b*, upper and lower aspects of *Haplophragmium globigeriniforme*; *c*, *Hormosira globulifera*; *d*, *Marsipella elongata*; *e*, terminal portion, and *f*, middle portion of the same, enlarged; *g*, *Thurammina papillata*; *h*, portion of its inner surface, enlarged.

they come up with 'Globigerina mud,' in which sponge-spicules abound, whilst sand-grains are scarce, they are almost entirely made up of the former, which are 'laid' in a sort of lattice-work, the interspaces of which are filled up by fine sand-grains; but when they are brought up from a bottom on which sand predominates, the larger part of the 'test' is made up of sand-grains and minute Foraminifera, with here and there a sponge-spicule (fig. 614, *d*, *f*). In each case, however, the tubular extensions (one of which sometimes forms a sort of proboscis, *e*, nearly equalling the body itself in length) are entirely made up of sponge-spicules laid side by side with extraordinary regularity. The genus *Rhabdammina* (Sars) resembles *Saccammina* in the structure of its 'test,' which is composed of sand-grains very firmly cemented together; but the grains

are of smaller size, and they are so disposed as to present a smooth surface internally, though the exterior is rough. What is most remarkable about this is the geometrical regularity of its form, which is typically triradiate (fig. 615, *c*), the rays diverging at equal angles from the central cavity, and each being a tube (*d*) with an orifice at its extremity. Not unfrequently, however, it is quadri-radiate, the rays diverging at right angles; and occasionally a fifth ray presents itself, its radiation, however, being generally in a different plane. The three rays are normally of equal length; but one of them is sometimes shorter than the other two; and when this is the case the angle between the long rays increases at the expense of the other two, so that the long rays lie more nearly in a straight line. Sometimes the place of the third ray is indicated only by a little knob; and then the two long rays have very nearly the same direction. We are thus led to forms in which there is no vestige of a third ray, but merely a single straight tube, with an orifice at each end; and the length of this, which often exceeds half an inch, taken in connection with the abundance in which it presents itself in dredgings in which the triradiate forms are rare, seems to preclude the idea that these long single rods are broken rays of the latter. It is undoubtedly in this group that we are to place the genus *Haliphysema*, which, from constructing its 'test' entirely of sponge-spicules, and even including these in its pseudopodial expansions, has been ranked as a sponge, although observation of it in its living state leaves no doubt whatever of its rhizopodal character.¹

Lituolida.—The type of this family, which is named after it, is a large sandy many-chambered fossil form occurring in the chalk, to which the name *Lituola* was given by Lamarck, from its resemblance in shape to a crosier. A great variety of recent forms, mostly obtained by deep-sea dredging, are now included in it, as bearing a more or less close resemblance to it and to each other in their chambered structure, and in the arrangement of the sand-grains of which their tests are formed. These grains are, for the most part, finer than those of which the tests of the preceding family are constructed, and are set (so to speak) more artistically, and a considerable quantity of a cement exuded by the animal is employed in uniting them. This is often mixed up with sandy particles of extreme fineness to form a sort of 'plaster' with which the exterior of the test is smoothed off, so as to present quite a polished surface. It is remarkable that the cement contains a considerable quantity of oxide of iron, which imparts a ferruginous hue to the 'tests' in which it is largely employed. The forms of the *Lituoline* 'tests' often simulate in a very curious way those of the simpler types of the *vitreous* series. Thus, the long spirally coiled undivided sandy tube of *Ammodiscus* is the isomorph of *Spirillina*. In the genus *Haplophragmium* (fig. 614, *a, b*, and Plate XVIII, fig. 6) we have singular imitations of the Globigerine, Rotaline, and Nonionine types; and in

¹ See Mr. Saville Kent in *Ann. of Nat. Hist.* ser. v. vol. ii. 1878; Professor Ray Lankester in *Quart. Journ. Microsc. Sci.* vol. xix. 1878, p. 176; and Professor Möbius's *Foraminifera von Mauritius*, 1880.

Thurammina papillata (fig. 614, *g*) a not less remarkable imitation of the Orbuline. This last is specially noteworthy for the admirable manner in which its component sand-grains are set together, these being small and very uniform in size, and being disposed in such a manner as to present a smooth surface both inside and out (fig. 614, *b*), whilst there are at intervals nipple-shaped protuberances, in every one of which there is a rounded orifice. A like perfection of finish is seen in the test of *Hormosina globulifera* (fig. 614, *c*), which is composed of a succession of globular chambers rapidly increasing in size, each having a narrow tubular neck with a rounded orifice, which is received into the next segment. In other species of the same genus there is a nearer approach to the ordinary Nodosarine type, their tests being sometimes constructed with the regularity characteristic of the shells of the true *Nodosaria*, Plate XIX, 16, whilst in other

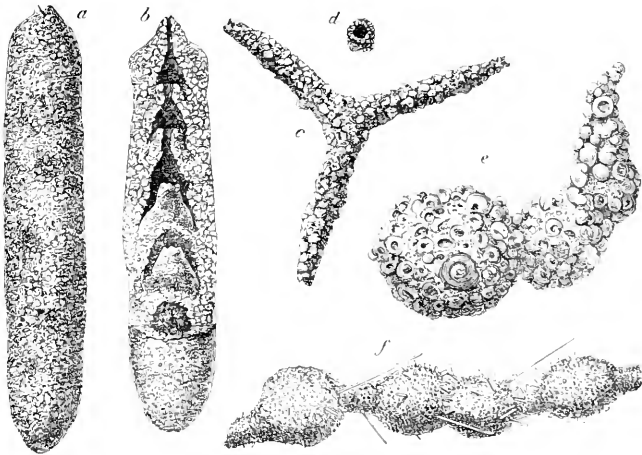

FIG. 615.—Arenaceous Foraminifera: *a*, *b*, exterior and sectional views of *Rhecophax sabulosa*; *c*, *Rhabdammina abyssorum*; *d*, cross section of one of its arms; *e*, *Rhecophax scorpiurus*; *f*, *Hormosina Carpenteri*.

cases the chambers are less regularly disposed (fig. 615, *f*), having rather the character of bead-like enlargements of a tube, whilst their walls show a less exact selection of material, sponge-spicules being worked in with the sand-grains, so as to give them a hirsute aspect. A greater rudeness of structure shows itself in the Nodosarine forms of the genus *Rhecophax*, in which not only are the sand-grains of the test very coarse, but small Foraminifera are often worked up with them (fig. 615, *e*). A straight, many-chambered form of the same genus (fig. 615, *a*, *b*) is remarkable for the peculiar finish of the neck of each segment; for whilst the test generally is composed of sand-grains, as loosely aggregated as those of which the test of *Astrorhiza* is made up, the grains that form the neck are firmly united by ferruginous cement, forming a very smooth wall to the tubular orifice.

The highest development of the 'arenaceous' type at the present time is found in the forms that imitate the very regular *nautiloid*

shells, both of the 'porcellanous' and the 'vitreous' series; and the most remarkable of these is the *Cyclammmina cancellata* (fig. 616), which has been brought up in considerable abundance from depths ranging downwards to 1,900 fathoms, the largest examples being found within 700 fathoms. The test (fig. 616, *a*) is composed of aggregated sand-grains firmly cemented together and smoothed over externally with 'plaster,' in which large glistening sand-grains are sometimes set at regular intervals, as if for ornament. On laying open the spire it is found to be very regularly divided into chambers by partitions formed of cemented sand-grains (*b*), a communication between these chambers being left by a fissure at the inner margin of the spire, as in *Operculina* (fig. 628). One of the most curious features in the structure of this type is the extension of the cavity of each chamber into passages excavated in its thick external wall,

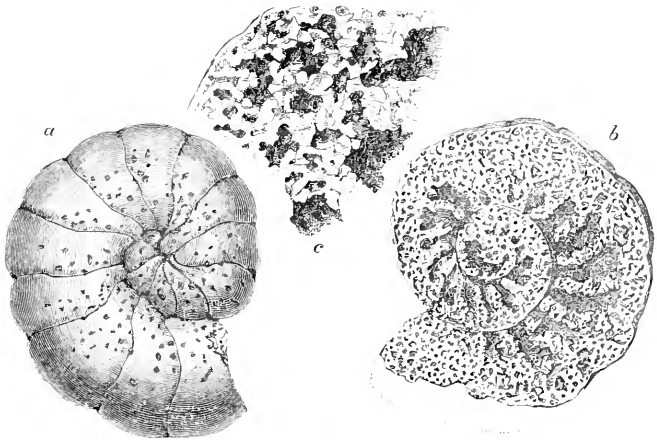

FIG. 616.—*Cyclammmina cancellata*, showing at *a*, its external aspect; *b*, its internal structure; *c*, a portion of its outer wall in section, more highly magnified, showing the sand-grains of which it is built up and the passages excavated in its substance.

each passage being surrounded by a very regular arrangement of sand-grains, as shown at *c*. It not unfrequently happens that the outer layer of the test is worn away, and the ends of the passages then show themselves as pores upon its surface; this appearance, however, is abnormal, the passages simply running from the chamber-cavity into the thickness of its wall, and having (so long as this is complete) no external opening. This 'labyrinthine' structure is of great interest, from its relation not only to the similar structure of the large fossil examples of the same type, but also to that which is presented in other gigantic fossil arenaceous forms to be presently described.

Although some of the nautiloid *Lituola* are among the largest of existing Foraminifera, having a diameter of 0.3 inch, they are mere dwarfs in comparison with two gigantic fossil forms, whose

structure has been elucidated by Mr. H. B. Brady and the Author.¹ Geologists who have worked over the Greensand of Cambridgeshire have long been familiar with solid spherical bodies which there present themselves not unfrequently, varying in size from that of a pistol-bullet to that of a small cricket-ball; and whilst some regarded them as mineral concretions others were led by certain appearances presented by their surfaces to suppose them to be fossilised sponges. A specimen having been fortunately discovered, however, in which the original structure had remained unconsolidated by mineral in-

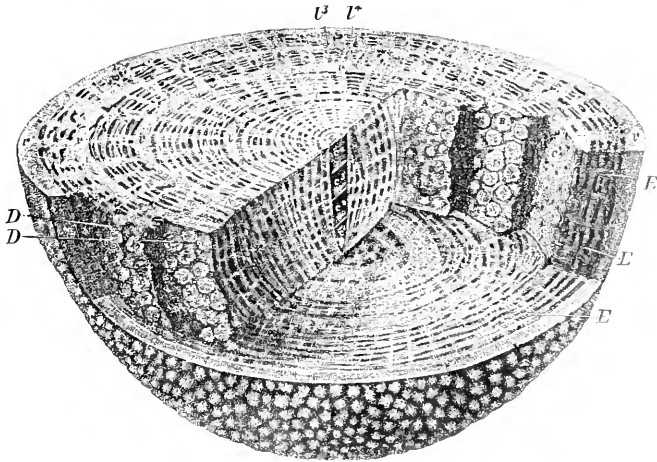

FIG. 617.—General view of the internal structure of *Parkeria*: In the horizontal section, *1*, *2*, *3*, *4* mark the four thick layers; in the vertical sections *A* marks the internal surface of a layer separated by concentric fracture; *B*, the appearance presented by a similar fracture passing through the radiating processes; *C*, the result of a tangential section passing through the cancellated substance of a lamella; *D*, the appearance presented by the external surface of a lamella separated by a concentric fracture which has passed through the radial processes; *E*, the aspect of a section taken in a radial direction, so as to cross the solid lamellae and their intervening spaces: *c*¹, *c*², *c*³, *c*⁴, successive chambers of nucleus.

filtration, it was submitted by Professor Morris to the Author, who was at once led by his examination of it to recognise it as a member of the arenaceous group of Foraminifera, to which he gave the designation *Parkeria*, in compliment to his valued friend and coadjutor, Mr. W. K. Parker. A section of the sphere taken through its centre (fig. 617) presents an aspect very much resembling that of an Orbitolite, a series of chamberlets being concentrically arranged round a 'nucleus;' and as the same appearance is presented, whatever be the direction of the section, it becomes apparent that these

¹ See their 'Description of *Parkeria* and *Loftusia*' in *Philosophical Transactions*, 1869, p. 721. Though it appears convenient to allow this description of *Parkeria* to remain, it must be noted that some of those most competent to judge are of opinion that *Parkeria* is one of the Stromatoporoids, an obscure and difficult group of fossil *Hydroïda* (see the memoir by Professor Alleyne Nicholson, published in 1886 by the Palaeontographical Society).

chamberlets, instead of being arranged in successive *rings* on a single plane, so as to form a disc, are grouped in concentric *spheres*, each completely investing that which preceded it in date of formation. The outer wall of each chamberlet is itself penetrated by extensions of the cavity into its substance, as in the *Cyclammina* last described; and these passages are separated by partitions very regularly built up of sand-grains, which also close in their extremities, as is shown in fig. 618. The concentric spheres are occasionally separated by walls of more than ordinary thickness, and such a wall is seen in fig. 617 to close in the last-formed series of chamberlets. But these

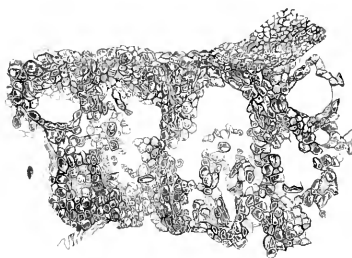

FIG. 618.—Portion of one of the lamellæ of *Parkeria*, showing the sand-grains of which it is built up, and the passages extending into its substance.

walls have the same 'labyrinthic' structure as the thinner ones, and an examination of numerous specimens shows that they are not formed at any regular intervals. The 'nucleus' is always composed of a single series of chambers arranged end to end, sometimes in a straight line, as in fig. 617, c^1, c^2, c^3, c^4 , sometimes forming a spiral, and in one instance returning upon itself.

But the outermost chamber enlarges, and extends itself over the whole 'nucleus,' very much as the 'circumambient' chamber of the

Orbitolite extends itself round the primordial chamber; and radial prolongations given off from this in every direction form the first investing sphere, round which the entire series of concentric spheres are successively formed. Of the sand of which this remarkable fabric is constructed about 60 per cent. consists of phosphate of lime, and nearly the whole remainder of carbonate of lime. Another large fossil arenaceous type, constructed upon the same general plan, but growing spirally round an elongated axis, after the manner of *Alveolina* (fig. 608), and attaining a length of three inches, has been described by Mr. H. B. Brady (*loc. cit.*) under the name *Loftusia*, after its discoverer, the late Mr. W. K. Loftus, who brought it from the Turko-Persian frontier, where specimens were found in considerable numbers imbedded in 'a blue marly limestone,' probably of early Tertiary age.

There is nothing, it seems to the Author, more wonderful in Nature than the building up of these elaborate and symmetrical structures by mere 'jelly-specks,' presenting no trace whatever of that definite 'organisation' which we are accustomed to regard as necessary to the manifestations of conscious life. Suppose a human mason to be put down by the side of a pile of stones of various shapes and sizes, and to be told to build a dome of these, smooth on both surfaces, without using more than the least possible quantity of a very tenacious but very costly cement in holding the stones together. If he accomplished this well, he would receive credit for great intelligence and skill. Yet this is exactly what these little 'jelly-specks'

do on a most minute scale, the 'tests' they construct, when highly magnified, bearing comparison with the most skilful masonry of man. From *the same sandy bottom* one species picks up the *coarser* quartz-grains, unites them together with a ferruginous cement secreted from its own substance, and thus constructs a flask-shaped 'test,' having a short neck and a single large orifice. Another picks up the *finer* grains and puts them together with the same cement into perfectly spherical 'tests' of the most extraordinary finish, perforated with numerous small pores disposed at pretty regular intervals. Another selects the *minutest* sand-grains and the terminal portions of sponge-spicules and works these up together—apparently with no cement at all, but by the mere 'laying' of the spicules—into perfect white spheres, like homeopathic globules, each having a single fissured orifice. And another, which makes a straight many-chambered 'test,' the conical mouth of each chamber projecting into the cavity of the next, while forming the walls of its chambers of ordinary sand-grains rather loosely held together, shapes the conical mouths of the successive chambers by firmly cementing to each other the quartz-grains which border it. To give these actions the vague designation 'instinctive' does not in the least help us to account for them; since what we want is to discover the *mechanism* by which they are worked out; and it is most difficult to conceive how so artificial a selection can be made by creatures so simple.

Vitrea.—Returning now to the Foraminifera which form true *shells* by the calcification of the superficial layer of their sarcodibodies, we shall take a similar general survey of the *vitreous* series, whose shells are perforated by multitudes of minute foramina (fig. 607). Thus, *Spirillina* has a minute, spirally convoluted, undivided tube, resembling that of *Cornuspira*, but having its wall somewhat coarsely perforated by numerous apertures for the emission of pseudopodia. The 'monothalamous' forms of this growth mostly belong to the family *Lagenida*, which also contains a series of transition forms leading up gradationally to the 'polythalamous' nautiloid type. In *Lagena* (Plate XIX, figs. 12, 13, 14, 15) the mouth is narrowed and prolonged into a tubular neck, giving to the shell the form of a microscopic flask; this neck terminates in an everted lip, which is marked with radiating furrows. A mouth of this kind is a distinctive character of a large group of many-chambered shells, of which each single chamber bears a more or less close resemblance to the simple *Lagena*, and of which, like it, the external surface generally presents some kind of ornamentation, which may have the form either of longitudinal ribs or of pointed tubercles. Thus the shell of *Nodosaria* (Plate XIX, fig. 16) is obviously made up of a succession of lageniform chambers, the neck of each being received into the cavity of that which succeeds it; whilst in *Cristellaria* (fig. 17) we have a similar succession of chambers, presenting the characteristic radiate aperture, and often longitudinally ribbed, disposed in a nautiloid spiral. Between *Nodosaria* and *Cristellaria*, moreover, there is such a gradational series of connecting forms as shows that no essential difference exists between these two types, and it is a fact of no little interest that some of the simpler of these varietal forms,

of which many are to be met with on our own shores, but which are more abundant on those of the Mediterranean and especially of the Adriatic, can be traced backwards in geological time at least as far as the Permian epoch. In another genus, *Polymorphina*, we find the shell to be made up of lageniform chambers arranged in a double series, alternating with each other on the two or more sides of a rectilinear axis; here, again, the forms of the individual chambers, and the mode in which they are set one upon another, vary in such a manner as to give rise to very marked differences in the general configuration of the shell, which are indicated by the name it bears.

Globigerinida.—Returning once again to the simple ‘monothalamous’ condition, we have in *Orbulina*—a minute spherical shell that presents itself in greater or less abundance in deep-sea dredgings, from almost every region of the world—a globular chamber with porous walls, but destitute of any general aperture, the office of which is served by a series of larger pores scattered throughout the wall of the sphere. It has been maintained by some that *Orbulina* is really a detached generative segment of *Globigerina*, with which it is generally found associated. The shell of *Globigerina* consists of an assemblage of nearly spherical chambers (fig. 619), having coarsely

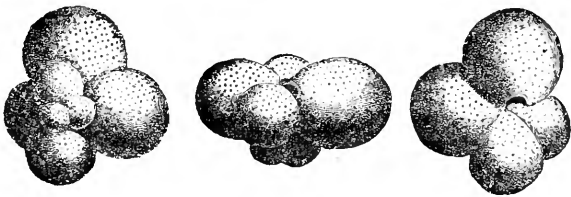

FIG. 619.—*Globigerina bulloides* as seen in three positions.

porous walls, and cohering externally into a more or less regular turbinoid spire, each turn of which consists of four chambers progressively increasing in size. These chambers, whose total number seldom exceeds sixteen, may not communicate directly with each other, but open separately into a common ‘vestibule’ which occupies the centre of the under side of the spire. This type has attracted great attention, from the extraordinary abundance in which it occurs at great depths over large areas of the ocean bottom. Thus its minute shells have been found to constitute no less than 97 per cent. of the ‘ooze’ brought up from depths of from 1,260 to 2,000 fathoms in the middle of the northern parts of the Atlantic Ocean. The younger shells, consisting of from eight to twelve chambers, are thin and smooth, but the older shells are thicker, their surface is raised into ridges that form an hexagonal areolation round the pores (fig. 620); and this thickening is shown by examination of thin sections of the shell to be produced by an exogenous deposit around the original chamber wall (corresponding with the ‘intermediate skeleton’ of the more complex types), which sometimes contains little flask-shaped cavities filled with sarcodæ—as was first pointed out by the late Dr. Wallich. But the sweeping of the upper waters

of the ocean by the 'tow net,' which was systematically carried on during the voyage of the 'Challenger,' brought into prominence the fact that these waters in all but the coldest seas are inhabited by *floating Globigerina*, whose shells are beset with multitudes of delicate calcareous spines, which extend themselves radially from the angles at which the ridges meet to a length equal to four or five times the diameter of the shell (fig. 621). Among the bases of these spines the sarcode substance of the body exudes through the pores of the shell, forming a flocculent fringe around it; and this extends

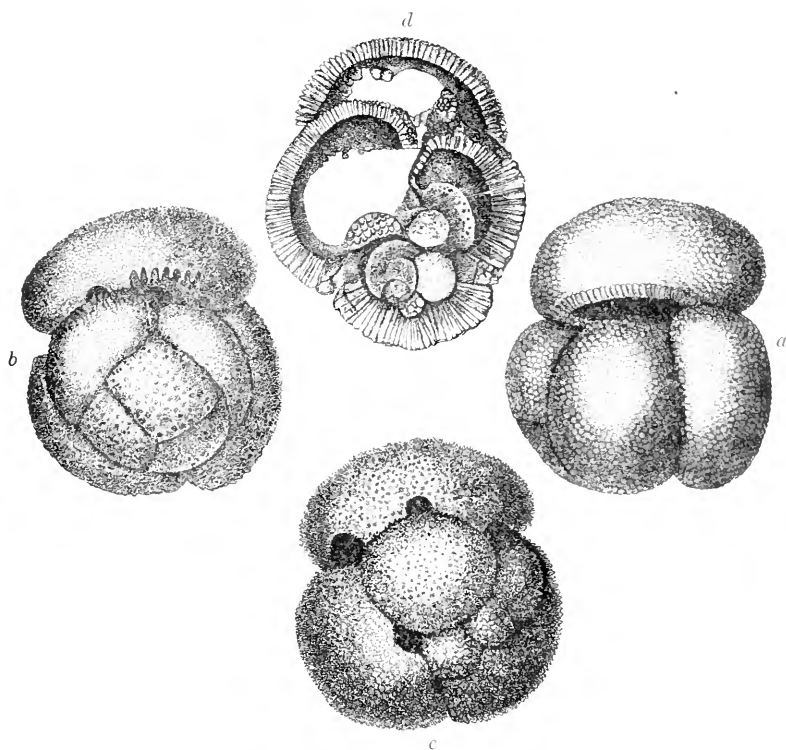

FIG. 620.—*Globigerina conglobata* (Brady): *a*, *b*, *c*, bottom specimens; *d*, section of shell.

itself on each of the spines, creeping up one side to its extremity, and passing down the other with the peculiar flowing movement already described. The whole of this sarcode extension is at once retracted if the cell which holds the *Globigerina* receives a sudden shock, or a drop of any irritating fluid is added to the water it contains. It was maintained by Sir Wyville Thomson that the bottom deposit is formed by the continual 'raining down' of the *Globigerinae* of the upper waters, which (he affirmed) only *live* at or near the surface, and which, when they die, lose their spines and subside. The

Author, however, from his own examination of the *Globigerina* ooze, is of opinion that the shells forming its surface-layer must *live on the bottom*, being incapable of floating in consequence of their weight; and that if they have passed the earlier part of their lives in the upper waters they drop down as soon as the calcareous deposit continually exuding from the body of each animal, instead of being employed in the formation of new chambers, is applied to the thickening of those previously formed. That many types of Foraminifera

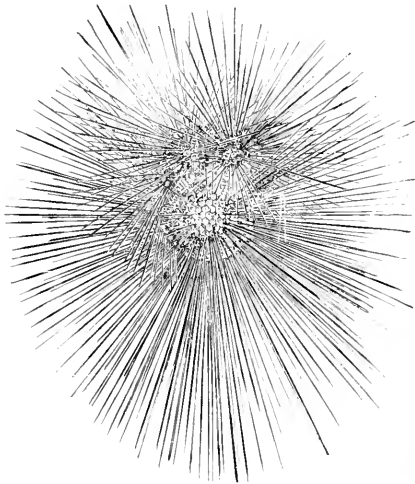

FIG. 621.—*Globigerina*, as captured by tow-net floating at or near surface.

pass their whole lives at depths of at least 2,000 fathoms is proved, in regard to those forming calcareous shells, by their attachment to stones, corals, &c.; and in the case of the arenaceous types by the fact that they can only procure *on the bottom* the sand of which their 'tests' are made up.

A very remarkable type has recently been discovered adherent to shells and corals brought from tropical seas, to which the name *Carpenteria* has been given. This may be regarded as a highly developed form of *Globigerina*, its first formed portion having all the essential characters of that genus.

It grows attached by the apex of its spire, and its later chambers increase rapidly in size, and are piled on the earlier in such a manner as to form a depressed cone with an irregular spreading base. The essential character of *Globigerina*—the separate orifice of each of its chambers—is here retained with a curious modification; for the central vestibule into which they all open forms a sort of vent whose orifice is at the apex of the cone, and is sometimes prolonged into a tube that proceeds from it; and the external wall of this cone is so marked out by septal bands that it comes to bear a strong resemblance to a minute *Balanus* (acorn-shell), for which this type was at first mistaken. The principal chambers are partly divided into chamberlets by incomplete partitions, as we shall find them to be in *Eozöon*. The presence of sponge-spicules in large quantity in the chambers of many of the best preserved examples of this type was for some time a source of perplexity; but this was explained by the late Professor Max Schultze,¹ who showed how the pseudopodia of this rhizopod have the habit, like those of *Haliphysema*, of taking into themselves sponge-spicules, which they draw into the chambers, so that they become incorporated with the sarcod-body. It should be added that Pro-

¹ *Archiv f. Naturgesch.* xxix, 1863, p. 81.

fessor Schultze, with whom Mr. H. J. Carter,¹ Mr. H. B. Brady,² and Dr. Goes³ are in agreement, regard *Carpenteria* as allied to *Polytrema*. Some interesting observations have been made by Professor Möbius⁴ on a large branching and spreading form of *Carpenteria* which he recently met with on a reef near Mauritius, and to which he has given the name of *C. raphidodendron*.

A less aberrant modification of the Globigerine type, however, is presented in the two great series which may be designated (after the leading forms of each) as the *Textularian* and the *Rotalian*. For, notwithstanding the marked difference in their respective plans of growth, the characters of the individual chambers are the same, their walls being coarsely porous, and their apertures being oval, semi-oval, or crescent-shaped, sometimes merely fissured. In *Textularia* (Plate XVIII, fig. 9) the chambers are arranged biserially along a straight axis, the position of those on the two sides of it being alternate, and each chamber opening into those above and below it on the opposite side by a narrow fissure, as is well shown in such

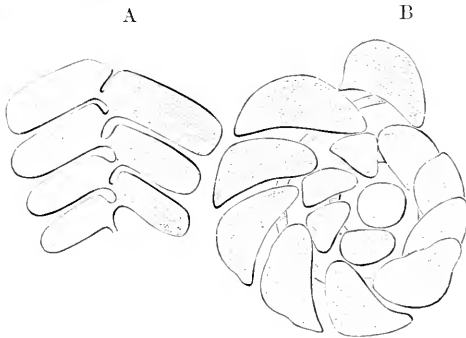

FIG. 622.—Internal silicious casts representing the forms of the segments of the animals of, A, *Textularia*; B, *Rotalia*.

'internal casts' (fig. 622, A) as exhibit the forms and connections of the segments of sarcodæ by which the chambers were occupied during life. In the genus *Bulimina* the chambers are so arranged as to form a spire like that of a *Bulimus*, and the aperture is a curved fissure whose direction is nearly transverse to that of the fissure of *Textularia*; but in this, as in the preceding type, there is an extraordinary variety in the disposition of the chambers. In both, moreover, the shell is often covered by a sandy incrustation, so that its perforations are completely hidden, and can only be made visible by the removal of the adherent crust. And so many cases are now known in which the shell of *Textularina* is entirely replaced by a sandy test, that some systematists prefer to range this group among the *Arenacea*.

In the *Rotalian* series the chambers are disposed in a turbinoid spire, opening one into another by an aperture situated on the lower

¹ *Annals and Mag. Nat. Hist.* ser. iv. vols. xvii. xix. xx.

² 'Challenger' Report.

³ *K. Svenska Vet. Handlingar*, xix. No. 4, p. 94.

⁴ See his *Foraminifera von Mauritius*, 1880, plates v. vi.

and inner side of the spire, as shown in Plate XIX, fig. 22, the forms and connections of the segments of their sarcodite-bodies being shown in such 'internal casts' as are represented in fig. 622, B. One of the lowest and simplest forms of this type is that very common one now distinguished as *Discorbina*. The early form of *Planorbulina* is a Rotaline spire, very much resembling that of *Discorbina*; but this afterwards gives place to a cyclical plan of growth, and in those most developed forms of this type which occur in warmer seas the earlier chambers are completely overgrown by the latter, which are often piled up in an irregular 'acervuline' manner, spreading over the surfaces of shells or clustering round the stems of zöophytes.

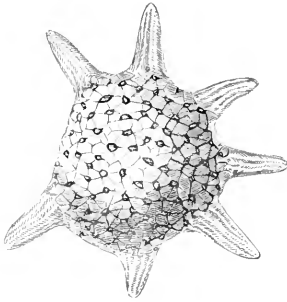

FIG. 623.—*Tinoporus baculatus*.

In the genus *Tinoporus* there is a more regular growth of this kind, the chambers being piled successively on the two sides of the original median plane, and those of adjacent piles communicating with each other obliquely (like those of *Textularia*) by large apertures, whilst they communicate with those directly above and below by the ordinary pores of the shell. The simple or smooth varieties of this genus forming the sub-genus *Gypsina* present great diversities of shape, with great constancy in their internal structure, being sometimes spherical, sometimes resembling a minute sugar-loaf, and sometimes being irregularly flattened out. The typical form (fig. 623), in which the walls of the piles are thickened at their meeting angles into solid columns that appear on the surface as tubercles, and are sometimes prolonged into spinous outgrowths that radiate from the central mass, is of very common occurrence in shore-sands and shallow-water dredgings on some parts of the Australian coasts and among the Polynesian islands. To the simple form of this genus we are probably to refer many of the fossils of the Cretaceous and early Tertiary period that have been described under the name *Orbitolina*, some of which attain a very large size. Globular *Orbitolinae*, which appear to have been artificially perforated and strung as beads, are not unfrequently found associated with the 'flint-implements' of gravel-beds. Another very curious modification of the Rotaline type is presented by *Polytrema*, which so much resembles a zöophyte as to have been taken for a minute millepore, but which is made up of an aggregation of 'Globigerine' chambers communicating with each other like those of *Tinoporus*, and differs from that genus primarily in its erect and usually branching manner of growth and the freer communication between its chambers. This, again, is of special interest in relation to *Eozöon*, showing that an indefinite zöophytic mode of growth is perfectly compatible with truly foraminiferal structure.

In *Rotalia*, properly so called, we find a marked advance towards the highest type of foraminiferal structure, the partitions that

divide the chambers being in the best developed examples composed of two laminae, and spaces being left between them which give passage to a system of canals whose general distribution is shown in fig. 624. The proper walls of the chambers, moreover, are thickened by an extraneous deposit or 'intermediate skeleton,' which sometimes forms radiating outgrowths. This peculiarity of conformation, however, is carried much further in the genus *Calcarina*, which has been so designated from its resemblance to a spur-rowel (fig. 629). The solid club-shaped appendages with which this shell is provided entirely belong to the 'intermediate skeleton' *b*, which is quite independent of the chambered structure *a*; and this is nourished by a set of canals containing prolongations of the sarcode-body which not only furrow the surface of these appendages, but are seen to traverse their interior when this is laid open by section, as shown at *c*. In no other recent foraminifer does the 'canal system' attain a like development; and its distribution in this minute shell, which has been made out by careful microscopic study, affords a valuable clue to its meaning in the gigantic fossil organism *Eozoon canalense*. The resemblance which *Calcarina* bears to the radiate forms of *Tinoporos* (fig. 623), which are often found with them in the same dredgings, is frequently extremely striking; and in their early growth the two can scarcely be distinguished, since both commence in a 'Rotaline' spire with radiating appendages; but whilst the successive chambers of *Calcarina* continue to be added on the same plane, those of *Tinoporos* are heaped up in less regular piles.

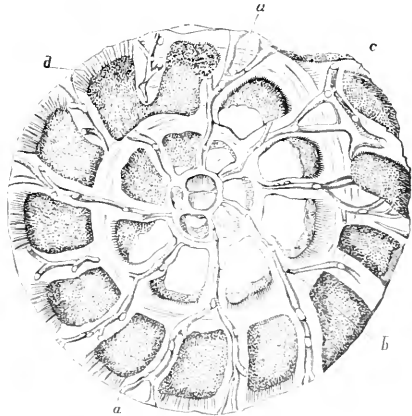

FIG. 624. Section of *Rotalia Schroeteriana* near its base and parallel to it, showing, *a*, *a*, the radiating interseptal canals; *b*, their internal bifurcations; *c*, a transverse branch; *d*, tubulated wall of the chambers.

Certain beds of Carboniferous limestone in Russia are entirely made up, like the more modern Nummulitic limestone, of an aggregation of the remains of a peculiar type of Foraminifera, to which the name *Fusulina* (indicative of its fusiform or spindle-like shape) has been given (fig. 625). In general aspect and plan of growth it so much resembles *Alveolina* that its relationship to that type would scarcely be questioned by the superficial observer. But when its mouth is examined it is found to consist of a single slit in the middle of the lip; and the interior, instead of being minutely divided into chamberlets, is found to consist of a regular series of simple chambers; while from each of these proceeds a pair of

elongated extensions, which correspond to the 'alar prolongations' of other spirally growing Foraminifera, but which, instead of wrapping round the preceding whorls, are prolonged in the direction of the axis of the spire, those of each whorl projecting beyond those of the preceding, so that the shell is elongated with every increase in its diameter. Thus it appears that in its general plan of growth *Fusulina* bears much the same relation to a symmetrical Rotuline or Nummuline shell that *Alveolina* bears to *Orbiculina*; and this view of its affinities is fully confirmed by the Author's microscopic examination of the structure of its shell. For although the *Fusulina* limestone of Russia has undergone a degree of metamorphism, which so far obscures the tubulation of its component shells as to prevent him from confidently affirming it, yet the appearances he could distinguish were decidedly in its favour. And having since received from Dr. C. A. White specimens from the Upper Coal Measures of Iowa, U.S.A., which are in a much more perfect state of

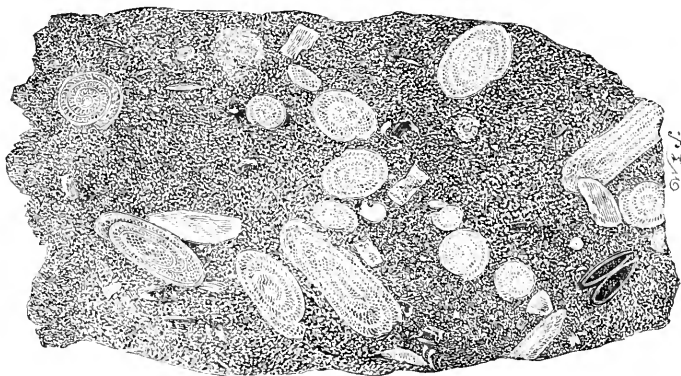

FIG. 625.—Section of *Fusulina* limestone.

preservation, he is able to state with certainty, not only that *Fusulina* is tubular, but that its tubulation is of the large coarse nature that marks its affinity rather to the *Rotuline* than to the *Nummuline* series. This type is of peculiar interest as having long been regarded as the oldest form of Foraminifera which was known to have occurred in sufficient abundance to form rocks by the aggregation of its individuals. It will be presently shown, however, that in point both of antiquity and of importance it is far surpassed by another.

Nummulinidæ.—All the most elaborately constructed, and the greater part of the largest, of the 'vitreous' Foraminifera belong to the group of which the well-known Nummulite may be taken as the representative. Various plans of growth prevail in the family; but its distinguishing characters consist in the completeness of the wall that surrounds each segment of the body (the septa being generally double instead of single), the density and fine porosity of the shell-substance, and the presence of an 'intermediate skeleton,'

with a 'canal system' for its nutrition. It is true that these characters are also exhibited in the highest of the Rotaline series, whilst they are deficient in the genus *Amphistegina*, which connects the Nummuline series with the Rotaline; but the occurrence of such modifications in their border forms is common to other truly natural groups. With the exception of *Amphistegina*, all the genera of this family are symmetrical in form, the spire being nautiloid in such as follow that plan of growth, whilst in those which follow the cyclical plan there is a constant equality on the two sides of the median plane; but in *Amphistegina* there is a reversion to the Rotalian type in the turbinoid form of its spire, as in the characters already specified, although its general conformity to the Nummuline type is such as to leave no reasonable doubt as to its title to be placed in this family. Notwithstanding the want of symmetry of its spire, it accords with *Operculina* and *Nummulites* in having its chambers extended by 'alar prolongations' over each surface of the previous whorl; but on the under side these prolongations are almost entirely cut off from the principal chambers, and are so displaced as apparently to alternate with them in position, so that M. d'Orbigny, supposing them to constitute a distinct series of chambers, described its plan of growth as a biserial spire, and made this the character of a separate order.¹

The existing *Nummulinidae* are almost entirely restricted to tropical climates; but a beautiful little form, *Polystomella crispa*, the representative of a genus that presents the most regular and complete development of the 'canal system' anywhere to be met with, is common on our own coasts. The peculiar surface-marking shown in the figure consists in a strongly marked ridge-and-furrow plication of the shelly wall of each segment along its posterior margin, the furrows being sometimes so deep as to resemble fissures opening into the cavity of the chamber beneath. No such openings, however, exist, the only communication which the sarcode-body of any segment has with the exterior being either through the fine tubuli of its shelly walls or through the row of pores that are seen in front view along the inner margin of the septal plane, collectively representing a fissured aperture divided by minute bridges of shell. The meaning of the plication of the shelly wall comes to be understood when we examine the conformation of the segments of the sarcode-body, which may be seen in the common *Polystomella crispa* by dissolving away the shell of fresh specimens by the action of dilute acid, but which may be better studied in such internal casts (fig. 626) of the sarcode-body and canal system of the large *P. craticulata* of the Australian coast as may sometimes be obtained by the same means from dead shells which have undergone infiltration with ferruginous silicates.² Here

¹ For an account of this curious modification of the Nummuline plan of growth, the real nature of which was first elucidated by Messrs. Parker and Rupert Jones, see the Author's *Introduction to the Study of the Foraminifera* (published by the Ray Society).

² It was by Professor Ehrenberg that the existence of such 'casts' in the Greensands of various geological periods (from the Silurian to the Tertiary) was first pointed out, in his memoir 'Ueber den Grünsand und seine Erläuterung des

we see that the segments of the sarcode-body are smooth along their anterior edge b, b^1 , but that along their posterior edge, a , they are prolonged backwards into a set of 'retrol processes;' and these processes lie under the ridges of the shell, whilst the shelly wall dips down into the spaces between them, so as to form the furrows seen on the surface. The connections of the segments by stolons, c, c^1 , passing through the pores at the inner margin of each septum, are also admirably displayed in such 'casts.' But what they serve most beautifully to demonstrate is the canal system, of which the distribution is here most remarkably complete and symmetrical. At d, d^1, d^2 are seen three turns of a spiral canal which passes along one end of all the segments of the like number of convolutions, whilst a corresponding canal is found on the side which in the figure is undermost; these two spires are connected by a set of meridional canals, e, e^1, e^2 , which pass down between the two layers of the septa that

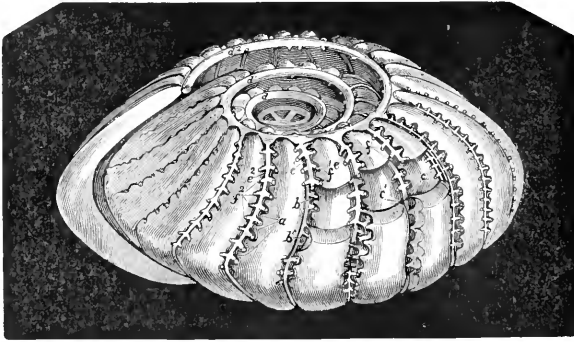

FIG. 626.—Internal cast of *Polystomella craticulata*: a , retrol processes proceeding from the posterior margin of one of the segments; b, b^1 , smooth anterior margin of the same segment; c, c^1 , stolons connecting successive segments, and uniting themselves with the diverging branches of the meridional canals; d, d^1, d^2 , three turns of one of the spiral canals; e, e^1, e^2 , three of the meridional canals; f, f^1, f^2 , their diverging branches.

divide the segments; whilst from each of these there passes off towards the surface a set of pairs of diverging branches, f, f^1, f^2 , which open upon the surface along the two sides of each septal band, the external openings of those on its anterior margin being in the furrows between the retrol processes of the next segment. These canals appear to be occupied in the living state by prolongations of the sarcode-body; and the diverging branches of those of each convolution unite themselves, when this is inclosed by another convolution,

organischen Lebens,' in *Abhandlungen der königl. Akad. der Wissenschaften*, Berlin, 1855. It was soon afterwards shown by the late Professor Bailey (*Quart. Journ. Microsc. Sci.* vol. v. 1857, p. 83) that the like infiltration occasionally takes place in recent Foraminifera, enabling similar 'casts' to be obtained from them by the solution of their shells in dilute acid; the Author, as well as Messrs. Parker and Rupert Jones, soon afterwards obtained most beautiful and complete internal casts from recent Foraminifera brought from various localities. A number of Greensands yielding similar casts were collected on the 'Challenger' Expedition, the most notable from the coast of Australia.

with the stolon processes connecting the successive segments of the latter, as seen at *c*¹. There can be little doubt that this remarkable development of the canal system has reference to the unusual amount of shell-substance which is deposited as an 'intermediate skeleton' upon the layer that forms the proper walls of the chambers, and

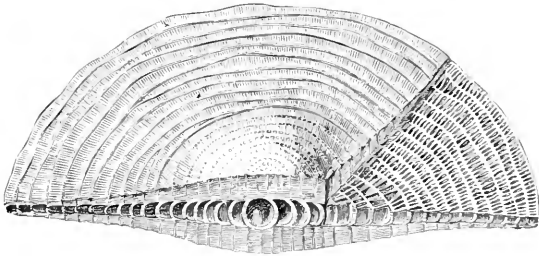

FIG. 627.—*Cycloclypeus*—external surface and vertical and horizontal sections.

which fills up with a solid 'boss' what would otherwise be the depression at the umbilicus of the spire. The substance of this 'boss' is traversed by a set of straight canals, which pass directly from the spiral canal beneath, towards the external surface, where they open in little pits, as is shown in Plate XIX. 23, the umbilical boss in *P. crispa*, however, being much smaller in proportion than it

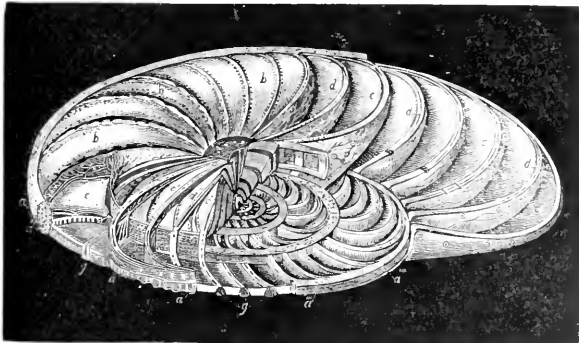

FIG. 628.—*Operculina* laid open to show its internal structure: *a*, marginal cord seen in cross-section at *a'*; *b*, *b*, external walls of the chambers; *c*, *c*, cavities of the chambers; *c'*, *c'*, their alar prolongations; *d*, *d*, septa divided at *d'* *d'* and at *d''* so as to lay open the interseptal canals, the general distribution of which is seen in the septa *e*, *e'*; the lines radiating from *e*, *e'* point to the secondary pores; *g*, *g*, non-tubular columns.

is in *P. craticulata*. There is a group of Foraminifera to which the term *Nonionina* is properly applicable, that is probably to be considered as a sub-genus of *Polystomella*, agreeing with it in its general conformation, and especially in the distribution of its canal system, but differing in its aperture, which is here a single fissure at the inner edge of the septal plane, and in the absence of the 'retrol

processes' of the segments of the sarcode-body, the external walls of the chambers being smooth. This form constitutes a transition to the ordinary Nummuline type, of which *Polystomella* is a more aberrant modification.

The Nummuline type is most characteristically represented at the present time by the genus *Operculina*, which is so intimately united to the true *Nummulite* by intermediate forms that it is not easy to separate the two, notwithstanding that their typical examples are widely dissimilar. The former genus (fig. 628) is represented on our own coast and in northern seas by very small and feeble forms, but it attains a much higher development in the tropics, where its diameter sometimes reaches one-fourth of an inch. The shell is a flattened nantiloid spire, the breadth of whose earlier convolutions increases in a regular progression, but of which the last convolution (in full-grown specimens) usually flattens itself out like that of *Peneroplis*, so as to be very much broader than the preceding. The external walls of the chambers, arching over the spaces between the septa, are seen at *b, b*; and these are bounded at the outer edge of

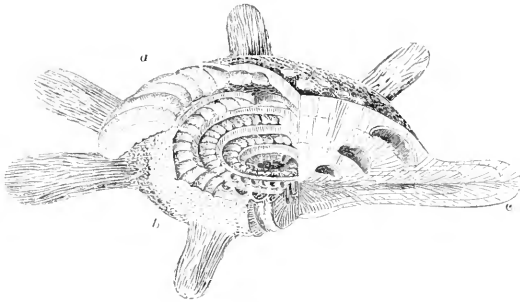

FIG. 629.—*Calcarina* laid open to show its internal structure: *a*, chambered portion; *b*, intermediate skeleton; *c*, one of the radiating prolongations proceeding from it, with extensions of the canal system.

each convolution by a peculiar band, *a*, termed the 'marginal cord.' This cord, instead of being perforated by minute tubuli like those which pass from the inner to the outer surface of the chamber-walls without division or inosculation (fig. 632), is traversed by a system of comparatively large inosculating passages seen in cross-section at *a'*, and these form part of the canal system to be presently described. The principal cavities of the chambers are seen at *c, c*; while the 'alar prolongations' of those cavities over the surface of the preceding whorl are shown at *c', c'*. The chambers are separated by the septa *d, d, d*, formed of two laminae of shell, one belonging to each chamber, and having spaces between them in which lie the 'interseptal canals,' whose general distribution is seen in the septa marked *e, e*, and whose smaller branches are seen irregularly divided in the septa *d', d'*, whilst in the septum *d''* one of the principal trunks is laid open through its whole length. At the approach of each septum to the marginal cord of the preceding is seen the narrow fissure which constitutes the principal aperture of communi-

cation between the chambers; in most of the septa, however, there are also some isolated pores (to which the lines point that radiate from *e*, *e*) varying both in number and position. The interseptal canals of each septum take their departure at its inner extremity from a pair of spiral canals, of which one passes along each side of the marginal cord; and they communicate at their outer extremity with the canal system of the 'marginal cord,' as shown in fig. 634. The external walls of the chambers are composed of the same finely tubular shell-substance that forms them in the Nummulite; but, as in that genus, not only are the septa themselves composed of vitreous non-tubular substance, but that which lies over them, continuing them to the surface of the shell, has the same character, showing itself externally in the form sometimes of continuous ridges, sometimes of rows of tubercles, which mark the position of the septa beneath. These non-tubular plates or columns are often traversed by branches of the canal system, as seen at *g*, *g*. Similar columns of non-tubular substance, of which the summits show themselves as tubercles on the surface, are not unfrequently seen between the septal bands, giving a variation to the surface-marking which, taken in conjunction with variations in general conformation, might be fairly held sufficient to characterise distinct species, were it not that on a comparison of a great number of specimens these variations are found to be so gradational that no distinct line of demarcation can be drawn between the individuals which present them.

The genus *Nummulites*, though represented at the present time by small and comparatively infrequent examples, was formerly developed to a vast extent, the Nummulitic limestone, chiefly made up by the aggregation of its remains (the material of which the Pyramids are built), forming a band, often 1,800 miles in breadth and frequently of enormous thickness, that may be traced from the Atlantic shores of Europe and Africa, through Western Asia to Northern India and China, and likewise over vast areas of North America (fig. 630). The diameter of a large proportion of fossil Nummulites ranges between half an inch and an inch; but there are some whose diameter does not exceed $\frac{1}{16}$ th of an inch, whilst others attain the gigantic diameter of $4\frac{1}{2}$ inches. Their typical form is that of a double-convex lens; but sometimes it much more nearly approaches the globular shape, whilst in other cases it is very much flattened; and great differences exist in this respect among individuals of what must be accounted one and the same species. Although there are some Nummulites which closely approximate *Operculina* in their mode of growth, yet the typical forms of this genus present certain well-marked distinctive peculiarities. Each convolution is so completely invested by that which succeeds it, and the external wall or spiral lamina of the new convolution is so completely separated from that of the convolution it incloses by the 'alar prolongations' of its own chambers (the peculiar arrangement of which will be presently described), that the spire is scarcely if at all visible on the external surface. It is brought into view, however, by splitting the Nummulite through the median plane, which may often be accomplished simply by striking it on one edge with a hammer, the opposite

edge being placed on a firm support ; or, if this method should not succeed, by heating it in the flame of a spirit-lamp, and then throwing it into cold water or striking it edgeways. Nummulites usually show many more turns, and a more gradual rate of increase in the breadth of the spire, than Foraminifera generally : this will be apparent from an examination of the vertical section shown in fig. 631, which is taken from one of the commonest and most characteristic

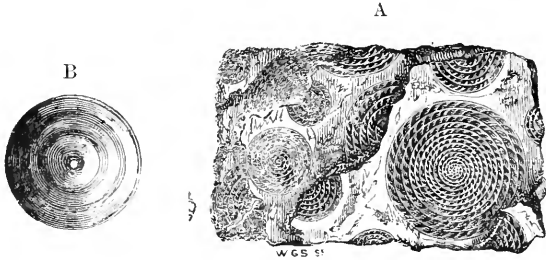

FIG. 630.—A, piece of *Nummulitic limestone* from Pyrenees, showing Nummulites laid open by fracture through median plane: B, *Orbitoides*.

fossil examples of the genus, and which shows no fewer than ten convolutions in a fragment that does not nearly extend to the centre of the spire. This section also shows the complete inclosure of the older convolutions by the newer, and the interposition of the alar prolongations of the chambers between the successive layers of the spiral lamina. These prolongations are variously arranged in different

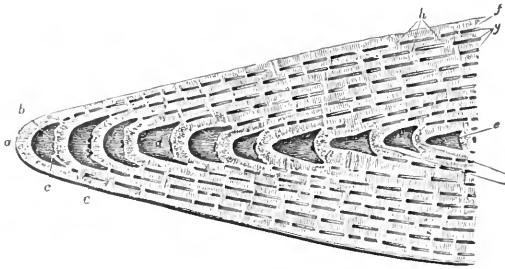

FIG. 631.—Vertical section of portion of *Nummulites laevigata*: *a*, margin *bf* external whorl; *b*, one of the outer row of chambers; *c, c*, whorl invested by *a*; *d*, one of the chambers of the fourth whorl from the margin; *e, e'*, marginal portions of the inclosed whorls; *f, f'*, investing portions of outer whorl; *g, g*, spaces left between the investing portion of successive whorls; *h, h*, sections of the partitions dividing these.

examples of the genus ; thus in some, as *N. distans*, they keep their own separate course, all tending radially towards the centre : in others, as *N. laevigata*, their partitions inosculate with each other, so as to divide the space intervening between each layer and the next into an irregular network, presenting in vertical section the appearance shown in fig. 631; whilst in *N. garansensis* they are broken

up into a number of chamberlets having little or no direct communication with each other.

Notwithstanding that the inner chambers are thus so deeply buried in the mass of investing whorls, yet there is evidence that

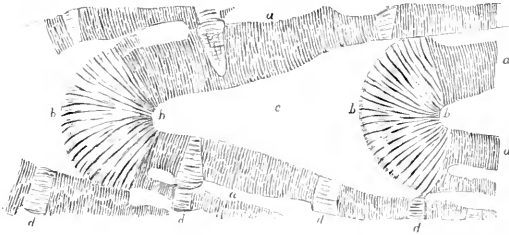

FIG. 632.—Portion of a thin section of *Nummulites larvigata* taken in the direction of the preceding, highly magnified to show the minute structure of the shell: *a, a*, portions of the ordinary shell-substance traversed by parallel tubuli; *b, b*, portions forming the marginal cord, traversed by diverging and larger tubuli; *c*, one of the chambers laid open; *d, d, d*, pillars of solid substance not perforated by tubuli.

the segments of sarcode which they contained were not cut off from communication with the exterior, but that they may have retained their vitality to the last. The shell itself is almost everywhere minutely porous, being penetrated by parallel tubuli, which pass directly from one surface to the other. These tubes are shown, as divided lengthwise by a vertical section, in fig. 632, *a, a*; whilst the appearance they present when cut across in a horizontal section is shown in fig. 633, the transparent shell substance

a, a, a being closely dotted with minute punctations which mark their orifices. In that portion of the shell, however, which forms the margin of each whorl (fig. 632, *b, b*), the tubes are larger, and diverge from each other at greater intervals; and it is shown by horizontal sections that they communicate freely with each other laterally, so as to form a network such as is seen at *b, b*, fig. 634. At certain other points, *d, d, d*, fig. 632, the shell-substance is not perforated by tubes, but is peculiarly dense in its texture, forming solid pillars which seem to strengthen the other parts; and in *Nummulites* whose surfaces have been much exposed to attrition, it commonly happens that the pillars of the superficial layer, being harder than the ordinary shell-substance, and being consequently less worn down, are left as

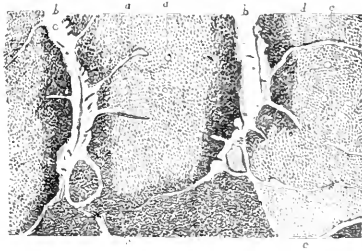

FIG. 633. Portion of horizontal section of *Nummulites* showing the structure of the walls and of the septa of the chambers: *a, a, a*, portion of the wall covering three chambers, the punctations of which are the orifices of tubuli; *b, b* septa between these chambers containing canals which send out lateral branches, *c, c*, entering the chambers by larger orifices, one of which is seen at *d*.

is peculiarly dense in its texture, forming solid pillars which seem to strengthen the other parts; and in *Nummulites* whose surfaces have been much exposed to attrition, it commonly happens that the pillars of the superficial layer, being harder than the ordinary shell-substance, and being consequently less worn down, are left as

prominences, the presence of which has often been accounted (but erroneously) as a specific character. The successive chambers of the same whorl communicate with each other by a passage left between the inner edge of the partition that separates them and the 'marginal cord' of the preceding whorl; this passage is sometimes a single large broad aperture, but is more commonly formed by the more or less complete coalescence of several separate perforations, as is seen in fig. 631, *b*. There is also, as in *Operculina*, a variable number of isolated pores in most of the septa, forming a secondary means of communication between the chambers. The canal system of *Nummulites* seems to be arranged upon essentially the same plan as that of *Operculina*; its passages, however,

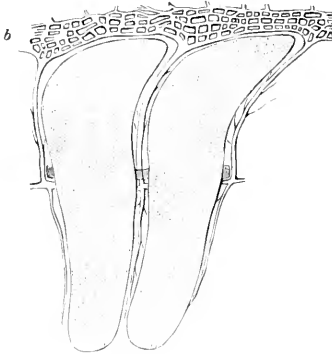

FIG. 634.—Internal cast of two of the chambers of *Nummulites striata*, with the network of canals, *b*, in the marginal cord communicating with canals passing between the chambers.

are usually more or less obscured by fossilising material. A careful examination will generally disclose traces of them in the middle of the partitions that divide the chambers (fig. 633, *b, b*), while from these may be seen to proceed the lateral branches (*c, c*), which, after burrowing (so to speak) in the walls of the chambers, enter them by large orifices (*d*). These 'interseptal' canals, and their communication with the insculating system of passages excavated in the marginal cord, are extremely well seen in the 'internal cast' represented in fig. 634.

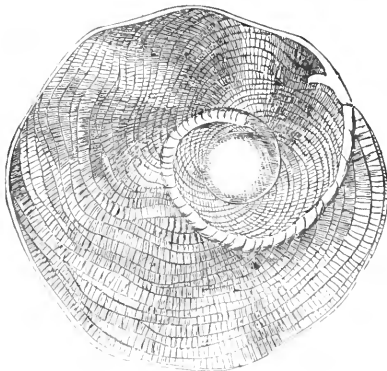

FIG. 635.—*Heterostegina*.

just as a *Peneroplis* would be converted by the like subdivision into an *Orbiculina*. Moreover, we see in *Heterostegina*, as in *Orbiculina*, a great tendency to the opening out of the spire with the advance of

age; so that the apertural margin extends round a large part of the shell, which thus tends to become discoidal. And it is not a little curious that we have in this series another form, *Cycloclypens*, which bears exactly the same relation to *Heterostegina* that *Orbitolites* does to *Orbiculina*, in being constructed upon the *cyclical* plan from the commencement, its chamberlets being arranged in rings around a central chamber. This remarkable genus, at present only known in the recent condition by specimens dredged at considerable depths from the coast of Borneo and at one or two points in the Western Pacific, is perhaps the largest of existing Foraminifera, some specimens of its discs in the British Museum having a diameter of two and a quarter inches. Notwithstanding the difference of its plan of growth, it so precisely accords with the Nummuline type in every character which essentially distinguishes the genus that there cannot be a doubt of the intimacy of their relationship. It will be seen from the examination of that portion of the figure which shows *Cycloclypens* in vertical section that the solid layers of shell by which the chambered portion is inclosed are so much thicker, and consist of so many more lamellae in the central portion of the disc than they do nearer its edge, that new lamellae must be progressively added to the surfaces of the disc concurrently with the addition of new rings of chamberlets to its margin. These lamellae, however, are closely applied one to the other without any intervening spaces; and they are all traversed by columns of non-tubular substance, which spring from the septal bands, and gradually increase in diameter with their approach to the surface, from which they project in the central portion of the disc as glistening tubercles.¹

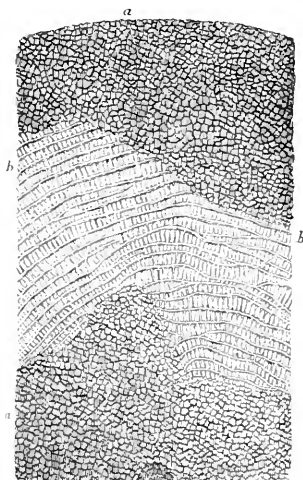

FIG. 636.—Section of *Orbitoides Fortisii*, parallel to the surface, traversing, at *a, a*, the superficial layer, and at *b, b*, the median layer.

The Nummulitic limestone of certain localities (as the south-west of France, Southern Germany, North-Eastern India, &c.) contains a vast abundance of discoidal bodies termed *Orbitoides* (fig. 630, B), which are so similar to Nummulites as to have been taken for them, but which bear a much closer resemblance to *Cycloclypens*. These are only known in the fossil state; and their structure can only be ascertained by the examination of sections thin enough to be translucent. When one of these discs (which vary in size, in different species, from that of a fourpenny-piece to that of half a crown or even larger) is rubbed down so as to display its internal organisation,

¹ Dr. L. Rhumbler's 'Entwurf eines natürlichen Systems der Thalamophoren' (*Nachr. Ges. Göttingen*, 1891, p. 51) is chiefly based on paleontological considerations.

two different kinds of structure are usually seen in it, one being composed of chamberlets of very definite form, quadrangular in some species, circular in others, arranged with a general but not constant regularity in concentric circles (figs. 636, 637, *b, b*); the other, less

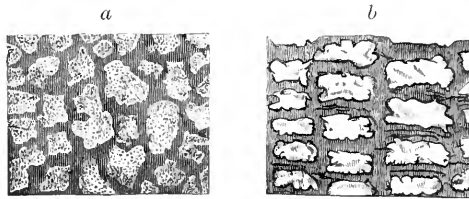

FIG. 637.—Portions of the section of *Orbitoides Fortisii*, shown in fig. 636, more highly magnified: *a*, superficial layer; *b*, median layer.

transparent, being formed of minuter chamberlets which have no such constancy of form, but which might almost be taken for the pieces of a dissected map (*a, a*). In the upper and lower walls of these last, minute punctations may be observed, which seem to be



FIG. 638.—Vertical section of *Orbitoides Fortisii*, showing the large central chamber at *a*, and the median layer surrounding it, covered above and below by the superficial layers.

the orifices of connecting tubes whereby they are perforated. The relations of these two kinds of structure to each other are made evident by the examination of a vertical section (fig. 638), which shows that the portion *b*, figs. 636, 637, forms the median plane, its concentric circles of chamberlets being arranged round a large central chamber, as in *Cyctoclypeus*; whilst the chamberlets of the

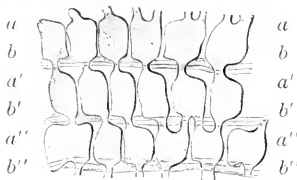

FIG. 639.—Internal cast of portion of median plane of *Orbitoides Fortisii*, showing, at *a a, a' a', a'' a''*, six chambers of each of three zones, with their mutual communications; and at *b b, b' b', b'' b''*, portions of three annular canals.

portion *a* are irregularly superposed one upon the other, so as to form several layers which are most numerous towards the centre of the disc, and thin away gradually towards its margin. The disposition and connections of the chamberlets of the median layer in *Orbitoides* seem to correspond very closely with those which have been already described as prevailing in *Cyctoclypeus*, the most satisfactory indications to this effect being furnished by the silicious internal casts to be met with in certain Greensands, which afford a model of the sarcode-body of the animal. In such a

fragment (fig. 639) we recognise the chamberlets of three successive zones, *a, a', a''*, each of which seems normally to communicate by one or two passages with the chamberlets of the zone internal and external to its own: whilst between the chamberlets of the same

zone there seems to be no direct connection. They are brought into relation, however, by means of annular canals, which seem to represent the spiral canals of the Nummulite, and of which the 'internal casts' are seen at *b b*, *b' b'*, *b'' b''*.

A most remarkable fossil, referable to the foraminiferal type, was discovered in strata much older than the very earliest that were previously known to contain organic remains; and the determination of its real character may be regarded as one of the most interesting results of microscopic research. This fossil, which has received the name *Eozöon canadense* (fig. 640), is found in beds of Serpentine limestone that occur near the base of the

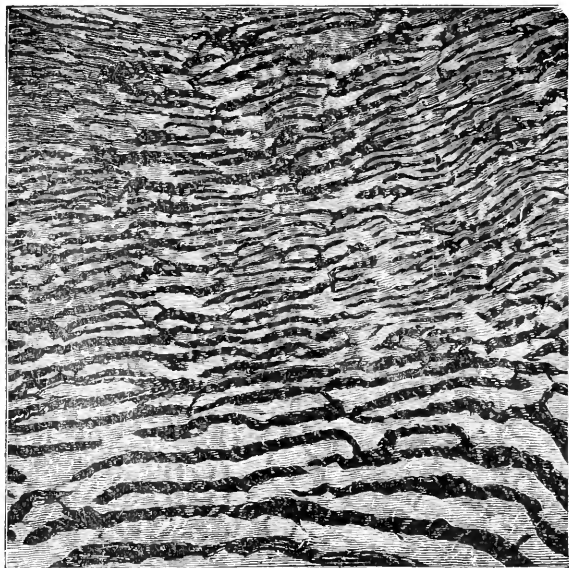

FIG. 640.—Vertical section of *Eozöon canadense*, showing alternation of calcareous (light) and serpentinous (dark) lamellæ.

Laurentian formation of Canada, which has its parallel in Europe in the 'fundamental gneiss' of Bohemia and Bavaria, and in the very earliest stratified rocks of Scandinavia and Scotland. These beds are found in many parts to contain masses of considerable size, but usually of indeterminate form, disposed after the manner of an ancient coral reef, and consisting of alternating layers—frequently numbering from 50 to 100—of carbonate of lime and serpentine (silicate of magnesia). The regularity of this alternation and the fact that it presents itself also between other calcareous and silicious minerals having led to a suspicion that it had its origin in organic structure, thin sections of well-preserved specimens were submitted to microscopic examination by the late Sir W. Dawson, of Montreal,

who at once recognised its foraminiferal nature,¹ the *calcareous* layers presenting the characteristic appearances of true *shell*, so disposed as to form an irregularly chambered structure, and frequently traversed by systems of ramifying canals corresponding to those of *Calcarina*; whilst the *serpentinous* or other silicious layers were regarded by him as having been formed by the infiltration of silicates in solution into the cavities originally occupied by the sarcode-body of the animal—a process of whose occurrence at various geological periods, and also at the present time, abundant evidence has already been adduced. Having himself taken up the investigation (at the instance of Sir William Logan), the Author was not only able to confirm Dr. Dawson's conclusions, but to adduce new and important evidence in support of them.² Although this determination has been called in question, on the ground that some resemblance to the supposed organic structure of *Eozöon* is presented by bodies of purely mineral origin,³ yet, as it has been accepted not only by most of those whose knowledge of foraminiferal structure gives weight to their judgment (among whom the late Professor Max Schultze may be specially named), but also by geologists who have specially studied the micro-mineralogical structure of the older Metamorphic rocks,⁴ the Author feels justified in here describing *Eozöon* as he believes it to have existed when it originally extended itself as an animal growth over vast areas of the sea-bottom in the Laurentian epoch.

Whilst essentially belonging to the Nummuline group, in virtue of the fine tubulation of the shelly layers forming the 'proper wall' of its chambers, *Eozöon* is related to various types of recent Foraminifera in its other characters. For in its indeterminate zöophytic mode of growth it agrees with *Polytrema* in the incomplete separation of its chambers; it has its parallel in *Carpenteria*; whilst in the high development of its 'intermediate skeleton' and of the 'canal system' by which this is formed and nourished, it finds its nearest representative in *Calcarina*. Its calcareous layers were so superposed one upon another as to include between them a succession

¹ This recognition was due, as Dr. Dawson has explicitly stated in his original memoir (*Quart. Journ. of Geol. Soc.* vol. xxi. p. 54), to his acquaintance, not merely with the Author's previous researches on the minute structure of the Foraminifera, but with the special characters presented by thin sections of *Calcarina* which had been transmitted to him by the Author. Dr. Dawson has given an account of the geological and mineralogical relations of *Eozöon*, as well as of its organic structure, in a small book entitled *The Dawn of Life*.

² For a fuller account of the results of the Author's own study of *Eozöon*, and of the basis on which the above reconstruction is founded, see his papers in *Quart. Journ. of Geol. Soc.* vol. xxi. p. 59, and vol. xxii. p. 219, and in the *Intellectual Observer*, vol. vii. 1865, p. 278; and his 'Further Researches' in *Ann. of Nat. Hist.* June 1874.

³ See the memoirs of Professors King and Rowney in *Quart. Journ. of Geol. Soc.* vol. xxii. p. 185, and *Ann. of Nat. Hist.* May 1874.

⁴ Among these the Author is permitted to mention Professor Geikie, of Edinburgh, who has thus studied the older rocks of Scotland, and Professor Bonney of London, who has made a like study of the Cornish and other Serpentine. By both these eminent authorities he is assured that they have met with no purely mineral structure in the least resembling *Eozöon*, either in its regular alternation of calcareous and serpentinous lamellæ, or in the dendritic extensions of the latter into the former; and while they accept as entirely satisfactory the doctrine of its organic origin maintained by the Author, they find themselves unable to conceive of any inorganic agency by which such a structure could have been produced.

of 'storeys' of chambers (fig. 641, A^1 , A^1 , A^2 , A^2), the chambers of each 'storey' usually opening one into another, as at *a, a*, like apartments *en suite*, but being occasionally divided by complete *septa*, as at *b, b*. These *septa* are traversed by passages of communication between the chambers which they separate, resembling those which, in existing types, are occupied by *stolons* connecting together the segments of the sarcode-body. Each layer of shell consists of two finely tubulated or 'Nummuline' lamellæ, B, B, which form the boundaries of the chambers beneath and above, serving (so to speak) as the *ceiling* of the former, and as the *floor* of the latter; and of an intervening deposit of homogeneous shell-substance C, C, which constitutes the 'inter-

mediate skeleton.' The tubuli of this 'Nummuline' layer (fig. 643) are usually filled up (as in the Nummulites of the 'Nummulitic limestone') by mineral infiltration, so as in transparent sections to present a fibrous appearance; but it fortunately happens that through their having in some cases escaped infiltration the tubulation is as distinct as it is even in recent Nummuline shells (fig. 643), bearing a singular resemblance in its occasional waviness to that of the crab's claw. The thickness of this interposed layer varies considerably in differ-

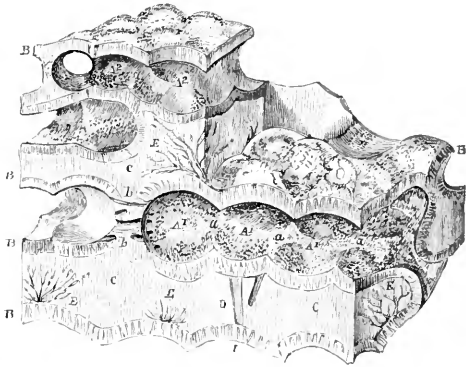

FIG. 641.—Portion of the calcareous shell of *Eozoon canadense* as it would appear if the serpentine that fills its chambers were dissolved away: A^1 , A^1 , chambers of lower storey opening into each other at *a, a*, but occasionally separated by a septum, *b, b*; A^2 , A^2 , chambers of upper storey; B, B, proper walls of the chambers, formed of a finely tubular or Nummuline substance; C, C, intermediate skeleton, occasionally traversed by large stolon-passages, D, connecting the chambers of different storeys, and penetrated by the arborescent systems of canals, E, E, E.

ent parts of the same mass, being in general greatest near its base and progressively diminishing towards its upper surface. The 'intermediate skeleton' is occasionally traversed by large passages (D), which seem to establish a connection between the successive layers of chambers; and it is penetrated by arborescent systems of canals (E, E), which are often distributed both so extensively and so minutely through its substance as to leave very little of it without a branch. These canals take their origin, not directly from the chambers, but from irregular *lacunæ* or interspaces between the outside of the proper chamber-walls and the 'intermediate skeleton,' exactly as in *Calcarina*, the extensions of the sarcode-body which occupied them having apparently been formed by the coalescence of the pseudopodial filaments that passed through the tubulated lamellæ.

In the fossilised condition in which *Eozöon* is most commonly found, not only the cavities of the chambers, but the canal systems to their smallest ramifications are filled up by the silicious infiltration which has taken the place of the original sarcode-body, as in the cases already cited, and thus when a piece of this fossil is subjected to the action of dilute acid, by which its calcareous portion is dissolved away, we obtain an *internal cast* of its chambers and canal system (fig. 642), which, though altogether dissimilar in *arrangement*, is essentially analogous in *character* to the 'internal casts' represented in figs. 622, 626. This cast presents us, therefore, with a *model* in hard serpentine of the soft sarcode-body which originally occupied the chambers, and extended itself into the ramifying canals, of the calcareous shell; and, like that of *Polystomella*, it affords an even more satisfactory elucidation of the relations of these parts than we could have gained from the study of the living organism.

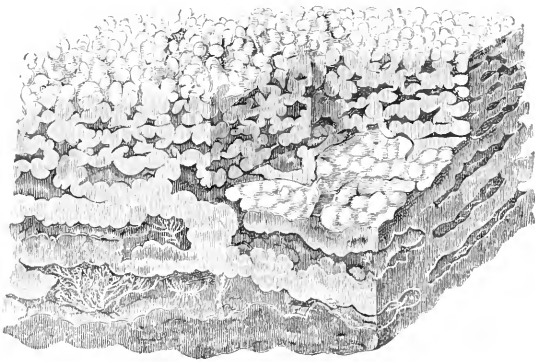

FIG. 642.—Decalcified portion of *Eozöon canadense* shell, showing the serpentinous *internal cast* of the chambers, canals, and tubuli of the original, presenting an exact model of the animal substance which originally filled them.

We see that each of the layers of serpentine, forming the lower part of such a specimen, is made up of a number of coherent segments, which have only undergone a partial separation; these appear to have extended themselves horizontally without any definite limit, but have here and there developed new segments in a vertical direction, so as to give origin to new layers. In the spaces between these successive layers, which were originally occupied by the calcareous shell, we see the 'internal casts' of the branching canal system, which give us the exact models of the extensions of the sarcode-body that originally passed into them. But this is not all. In specimens in which the Nummuline layer constituting the 'proper wall' of the chambers was originally well preserved, and in which the decalcifying process has been carefully managed (so as not, by too rapid an evolution of carbonic acid gas, to disturb the arrangement of the serpentinous residuum), that layer is represented by a thin white film covering the exposed surfaces of the segments; the superficial aspect

of which, as well as its sectional view, is shown in fig. 642. And when this layer is examined with a sufficient magnifying power it is found to consist of extremely minute needle-like fibres of serpentine, which sometimes stand upright, parallel, and almost in contact with each other, like the fibres of asbestos (so that the film which they form has been termed the 'asbestiform layer'), but which are frequently grouped in converging brush-like bundles, so as to be very close to each other in certain spots at the surface of the film, whilst widely separated in others. Now these fibres, which are less than $\frac{1}{100000}$ th of an inch in diameter, are the 'internal casts' of the tubuli of the Nummuline layer (a precise parallel to them being presented in the 'internal cast' of a recent *Amphistegina* which was in the Author's possession); and their arrangement presents all the varieties which have been mentioned as existing in the shells of *Operculina*. Thus



FIG. 643.—Vertical section of a portion of one of the calcareous lamellae of *Eozöon canadense*: *a a*, Nummuline layer perforated by parallel tubuli, which show a flexure along the line *a' a''*; beneath this is seen the intermediate skeleton, *c c*, traversed by the large canals, *b, b*, and by oblique cleavage planes, which extend also into the Nummuline layer.

these delicate and beautiful silicious fibres represent those *pseudopodial* threads of sarcode which originally traversed the minutely tubular walls of the chambers; and a precise model of the most ancient animal of which we have any knowledge, notwithstanding the extreme softness and tenuity of its substance, is thus presented to us with a completeness that is scarcely even approached in any later fossil.

In the upper part of the 'decalcified' specimen shown in fig. 642 it is to be observed that the segments are confusedly heaped together instead of being regularly arranged in layers, the *lamellated* mode of growth having given place to the *acervuline*. This change is by no means uncommon among Foraminifera, an irregular piling together of the chambers being frequently met with in the later growth of types whose earlier increase takes place upon some much

more definite plan. After what fashion the *earliest* development of *Eozoon* took place, we have at present no knowledge whatever; but in a *young* specimen which has been recently discovered it is obvious that each successive 'storey' of chambers was limited by the closing in of the shelly layer at its edges, so as to give to the entire fabric a definite form closely resembling that of a straightened *Peneroplis*. Thus it is obvious that the chief peculiarity of *Eozoon* lay in its capacity for *indefinite extension*, so that the product of a single germ might attain a size comparable to that of a massive coral. Now this, it will be observed, is simply due to the fact that its increase by gemmation takes place *continuously*, the new segments successively budded off remaining in connection with the original stock, instead of detaching themselves from it as in Foraminifera generally. Thus the little *Globigerina* forms a shell of which the number of chambers does not usually seem to increase beyond *sixteen*, any additional segments detaching themselves so as to form separate shells; but by the repetition of this multiplication the sea-bottom of large areas of the Atlantic Ocean at the present time has come to be covered with accumulations of *Globigerina*, which, if fossilised, would form beds of limestone not less massive than those which have had their origin in the growth of *Eozoon*. The difference between the two modes of increase may be compared to the difference between a herb and a tree. For in the herb the individual organism never attains any considerable size, its extension by gemmation being limited; though the aggregation of individuals produced by the detachment of its buds (as in a potato-field) may give rise to a mass of vegetation as great as that formed in the largest tree by the continuous putting forth of new buds.

It has been hitherto only in the Laurentian serpentine limestone of Canada that *Eozoon* has presented itself in such a state of preservation as fully to justify the assumption of its organic nature. But from the greater or less resemblance which is presented to this by serpentine-limestones occurring in various localities among strata that seem the geological equivalents of the Canadian Laurentians, it seems a justifiable conclusion that this type was very generally diffused in the earlier ages of the earth's history, and that it had a large (and probably the chief) share in the production of the most ancient calcareous strata, separating carbonate of lime from its solution in ocean water, in the same manner as do the polypes by whose growth coral reefs and islands are being upraised at the present time.

An elaborate work, 'Der Bau des *Eozoon* Canadense' (1878), has been recently published by Professor Mübius, of Kiel, in which the structure of *Eozoon* is compared with that of various types of Foraminifera, and, as it differs from that of every one of them, is affirmed not to be organic at all, but purely mineral. Upon this the Author would remark, that if the validity of this mode of reasoning be admitted, *any* fossil whose structure does not correspond with that of some existing type is to be similarly rejected. Thus the *Stromatopora* of Silurian and Devonian rocks, which some palæontologists regard as a coral, others as polyzoary, others as a calcareous sponge, and others as a foraminifer, would not be a fossil at all, because it

differs from every known living form. Yet the suggestion that it is of mineral origin would be scouted as absurd by every palæontologist. Again it is urged by Professor Möbius that as the supposed canal system of *Eozöon* has not the constancy and regularity of distribution which it presents in existing Foraminifera, it must be accounted a mineral infiltration. To this the Author would reply—(1) that a prolonged and careful study of this ‘canal system,’ in a great variety of modes, with an amount of material at his disposal many times greater than Professor Möbius could command, has satisfied him that in well-preserved specimens the canal system, so far from being vague and indefinite, has a very regular plan of distribution; (2) that this plan does not differ more from the arrangements characteristic of the several types of existing Foraminifera than these differ from each other, its *general* conformity to them being such as to satisfy Professor Max Schultze (one of the ablest students of the group) of its foraminiferal character; and (3) that not only does the distribution of the canal system of *Eozöon* differ in certain essential features from every form of mineral infiltration hitherto brought to light, but that *canal systems in no respect differing from each other in distribution are occupied by different minerals*; a fact which seems conclusively to point to their *pre-existence* in the calcareous layers, and the *subsequent* penetration of these minerals into the passages previously occupied by sarcode—precisely as has happened in those ‘internal casts’ of existing Foraminifera which Professor Möbius altogether ignores.

The argument for the foraminiferal nature of *Eozöon* is essentially a *cumulative* one, resting on a number of *independent probabilities*, no one of which, taken separately, has the cogency of a *proof*; yet the accordance of them all with that hypothesis has an almost demonstrative value, no other hypothesis accounting at once for the whole assemblage of facts.¹

Collection and Selection of Foraminifera.—Many of the Foraminifera attach themselves in the living state to seaweeds, zöophytes, &c.; and they should therefore be carefully looked for on such bodies, especially when it is desired to observe their internal organisation and their habits of life. They are often to be collected in

¹ The above account of *Eozöon* is allowed to stand as Dr. Carpenter’s name has become so intimately connected with the view, now not commonly held, that the body has an animal origin. It may be noted that Prof. J. W. Gregory, who has had an opportunity of examining the so-called Tudor specimen of *Eozöon*, communicated to the Geological Society, on March 11, 1891, a paper, of which the following is an abstract:—

After careful examination of all the slides and figures, and after consideration of Sir W. Dawson’s interpretation, the author is absolutely unable to recognise in the specimen any trace of the ‘proper wall,’ ‘canals,’ or ‘stolon passages,’ which are claimed to occur in *Eozöon*, or any reasons for regarding the calcite bands as the ‘intermediate skeleton’ of a foraminifer. There are points in Sir W. Dawson’s figure which might pass as ‘stolon passages,’ but they appear very different in a photograph, and the specimen agrees with the latter. The author, however, gives reasons for concluding that the case against the organic origin of the Tudor specimen does not rest on negative evidence alone; for, though the rock is much contorted, the twin lamelle and cleavage-planes of the calcite are not bent; and the fact that the crystalline bands cut across the bedding-planes further shows their secondary origin. The rock in which the specimen was found is not ‘Lower Laurentian,’ and is included by Messrs. Selwyn and Vennor in the Huronian.

much larger numbers, however, from the sand or mud dredged up from the sea-bottom, or even from that taken from between the tide-marks. In a paper containing some valuable hints on this subject¹ Mr. Legg mentions that, in walking over the Small-mouth Sand, which is situated on the north side of Portland Bay, he observed the sand to be distinctly marked with white ridges, many yards in length, running parallel with the edge of the water; and upon examining portions of these, he found Foraminifera in considerable abundance. One of the most fertile sources of supply that our own coasts afford is the ooze of the oyster-beds, in which large numbers of living specimens will be found; the variety of specific forms, however, is usually not very great. In separating these bodies from the particles of sand, mud, &c., with which they are mixed, various methods may be adopted in order to shorten the tedious labour of picking them out one by one under the simple microscope; and the choice to be made among these will mainly depend upon the condition of the Foraminifera, the importance (or otherwise) of obtaining them alive, and the nature of the substances with which they are mingled. Thus, if it be desired to obtain *living* specimens from the oyster-ooze for the examination of their soft parts, or for preservation in an aquarium, much time will be saved by stirring the mud (which should be taken from the surface only of the deposit) in a jar with water, and then allowing it to stand for a few moments; for the finer particles will remain diffused through the liquid, while the coarser will subside; and, as the Foraminifera (in the present case) will be among the *heavier*, they will be found at the bottom of the vessel with comparatively little extraneous matter, after this operation has been repeated two or three times. It would always be well to examine the first deposit let fall by the water that has been poured away, as this may contain the smaller and lighter forms of Foraminifera. But supposing that it be only desired to obtain the *dead* shells from a mass of sand brought up by the dredge, a very different method should be adopted. The whole mass should be exposed for some hours to the heat of an oven, and be turned over several times, until it is found to have been thoroughly dried throughout; and then, after being allowed to cool, it should be stirred in a large vessel of water. The chambers of their shells being now occupied by air alone (for the bodies of such as were alive will have shrunk up almost to nothing), the Foraminifera will be the *lightest* portion of the mass; and they will be found floating on the water, while the particles of sand &c. subside. Another method, devised by Mr. Legg, consists in taking advantage of the relative sizes of different kinds of Foraminifera and of the substances that accompany them. This, which is especially applicable to the sand and rubbish obtainable from sponges (which may be got in large quantity from the sponge-merchants), consists in sifting the whole aggregate through successive sieves of wire-gauze, commencing with one of ten wires to the inch, which will separate large extraneous particles, and proceeding to those of twenty, forty, seventy, and a hundred wires to the inch, each (especially that of seventy) retaining a much

¹ *Trans. of Microsc. Soc.* ser. ii, vol. ii, 1854, p. 19.

larger proportion of foraminiferal shells than of the accompanying particles; so that, a large portion of the extraneous matter being thus got rid of, the final selection becomes comparatively easy. Certain forms of Foraminifera are found attached to shells, especially bivalves (such as the *Chamida*) with foliated surfaces; and a careful examination of those of tropical seas, when brought home 'in the rough,' is almost sure to yield most valuable results. The final selection of specimens for mounting should always be made under some appropriate form of single microscope, a fine camel-hair pencil, with the point wetted between the lips, being the instrument which may be most conveniently and safely employed, even for the most delicate specimens. In mounting Foraminifera as microscopic objects the method to be adopted must entirely depend upon whether they are to be viewed by *transmitted* or by *reflected* light. In the former case they should be mounted in Canada balsam, the various precautions to prevent the retention of air-bubbles, which have been already described, being carefully observed. In the latter no plan is so simple, easy, and effectual as attaching them with a little gum to wooden slides. They should be fixed in various positions, so as to present all the different aspects of the shell, particular care being taken that its mouth is clearly displayed; and this may often be most readily managed by attaching the specimen *sideways* to the wall of the circular depression of the slide. Or the specimens may be attached to discs fitted for being held in a disc-holder; whilst for the examination of specimens in every variety of position Mr. R. Beck's disc-holder will be found extremely convenient. Where, as will often happen, the several individuals differ considerably from one another, special care should be taken to arrange them in *series* illustrative of their range of variation and of the mutual connections of even the most diverse forms. For the display of the internal structure of Foraminifera it will often be necessary to make extremely thin sections, in the manner already described; and much time will be saved by attaching a number of specimens to the glass slide at once and by grinding them down together. For the preparation of sections, however, of the extreme thinness that is often required, those which have been thus reduced should be transferred to separate slides and finished off each one by itself.

For the collection and examination of fossil Foraminifera, which are of great interest and importance, the following suggestions will be of use: they are the result of the ripe experience of Mr. F. Chapman:

Perhaps the foraminiferous clays are the most satisfactory for those who desire to collect foraminifera. Ordinary clays require to be slowly and thoroughly dried, broken into small pieces of about a cubic inch or so, and placed in a vessel of water with steep sides. After some little time the material will be found to have become disintegrated. The vessel should then be shaken round, and after the coarser particles have subsided the fine muddy portion may be poured off. The materials should again be shaken with very little water, and more water should then be added so as to cleanse the mud, and the decanting process afterwards repeated. If this be done

several times a fine sand with foraminiferal and other shells will be obtained. This can be then dried and sifted in the manner already described for the sands from modern deposits. To insure obtaining the minutest shells, the water which is poured off should be passed through a fine cambric or silken sieve.

The following are some of the more productive of the fossiliferous deposits :

→ Weathered surfaces of carboniferous limestone and seams of clay in the joints of it.

Clay from the lias formation.

Gault clay especially from the upper zones.

The softer beds of the upper chalk and especially the phosphatic chalk of Taplow, which washes down easily.

Foraminifera may be fixed by gum arabic with three drops of glycerine added to the ounce, or with gum tragacanth, which has the advantage of drying with a dead surface.

SECTION II.—RADIOLARIA.

It has been shown that one series of forms belonging to the *rhizopod* type is characterised by the *radiating* arrangement of their rod-like *pseudopodia*, suggesting the designation *Heliozoa* or 'sun-animalcules;' and that even among those fresh-water forms that do not depart widely from the common *Actinophrys* there are some whose bodies are inclosed in a complete silicious skeleton. Now just as the reticularian type of rhizopod life culminates in the marine calcareous-shelled *Foraminifera*, so does the heliozoic type seem to culminate in the marine *Radiolaria*; which, living for the most part near the surface of the ocean, form *silicious* skeletons (often of marvellous symmetry and beauty) that fall to the bottom on the death of the animals that produced them, and may remain unchanged, like those of the diatoms, through unlimited periods of time. Some of these skeletons, mingled with those of diatoms, had been detected by Professor Ehrenberg in the midst of various deposits of foraminiferal origin, such as the calcareous Tertiaries of Sicily and Greece, and of Oran in Africa; and he established for them the group of *Polycystina*, to which he was able also to refer a beautiful series of forms making up nearly the whole of a silicious sandstone prevailing through an extensive district in the island of Barbadoes (fig. 644). Nothing, however, was known of the nature of the animals that formed them until they were discovered and studied in the living state by Professor J. Müller,¹ who established the group of *Radiolaria*, including therein, with the *Polycystina* of Ehrenberg, the *Acanthometrina* first recognised by himself, and the *Thalassicolla* which had been discovered by Professor Huxley. Not long afterwards appeared the magnificent and 'epoch-making' work of Professor Haeckel;²

¹ 'Ueber die *Thalassicollen*, *Polycystinen*, und *Acanthometren* des Mittelmeeres,' in *Abhandlungen der königl. Akad. der Wissensch. zu Berlin*, 1858, and separately published; also 'Ueber die im Hafen von Messina beobachteten *Polycystinen*,' in the *Monatsberichte* of the Berlin Academy for 1855, pp. 671-676.

² *Die Radiolarien* (Rhizopoda Radiaria), Berlin, 1862. This great work has lately been followed by a gigantic monograph published in the '*Challenger*' Reports,

and since that time much has been added by various observers to our knowledge of this group, which still remains, however, very imperfect.

Each individual radiolarian consists of two portions of coloured or colourless sarcode—one portion nucleated and central, the other portion peripheral, and almost always containing certain yellow corpuscles. These two portions are separated by a membrane called the *capsule*; but this is so porous as to allow of their free communication with each other. The inner central capsule is also the special

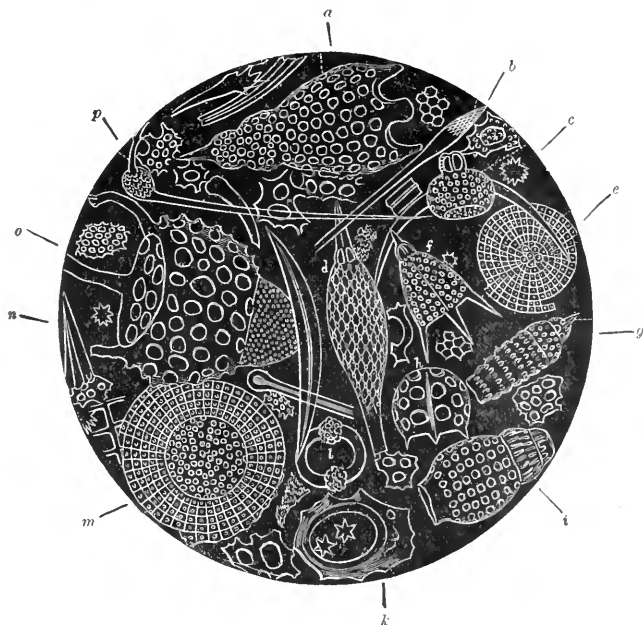

FIG. 644.—Fossil *Radiolaria* from Barbadoes: *a*, *Podocyrtes mitra*; *b*, *Rhabdolithus sceptrum*; *c*, *Lychnocanium falciiferum*; *d*, *Eucyrtidium tubulus*; *e*, *Flustrella concentrica*; *f*, *Lychnocanium lucerna*; *g*, *Eucyrtidium elegans*; *h*, *Dictyospyris clathrus*; *i*, *Eucyrtidium Mongolfieri*; *k*, *Stephanolithis spinescens*; *l*, *S. nodosa*; *m*, *Lithocyelia ocellus*; *n*, *Cephalolithis sylvina*; *o*, *Podocyrtes cothurnata*; *p*, *Rhabdolithus pipa*.

organ of reproduction, for it is the intracapsular protoplasm, with the nuclei imbedded in it, which serves for the formation of flagellate spores; the outer capsule has the special office of protecting and providing nourishment for the cell.¹ The *pseudopodia* radiate in all directions (fig. 645) from the deeper portion of the extracapsular sarcode; they have generally much persistency of direction and very

which extends over 1,800 pages, and is illustrated by 140 plates. In it are described 4,318 species, of which 3,508 are new to science.

¹ The structure of the central capsule of *Aulacantha* has been carefully worked out by W. Karawaiew, in *Zool. Anzeig.* xviii. (1895), p. 286 and p. 293.

little flexibility; in some species (but not ordinarily) they branch and anastomose, while in others they are inclosed in hollow rods that form part of the silicious skeleton, and issue forth from the extremities of these. A flow of granules takes place among them; and the mode in which they obtain food-particles (consisting of diatoms and other minute algæ, marine infusoria, &c.), and draw them into the sarcode-bodies of the radiolarians, appears to correspond entirely with their action in *Actinophrys* and other Heliozoa. The yellow cells, or *Zöovanthelle*, as K. Brandt has proposed to call them, so often seen in these cells, are not confined to Radiolaria,

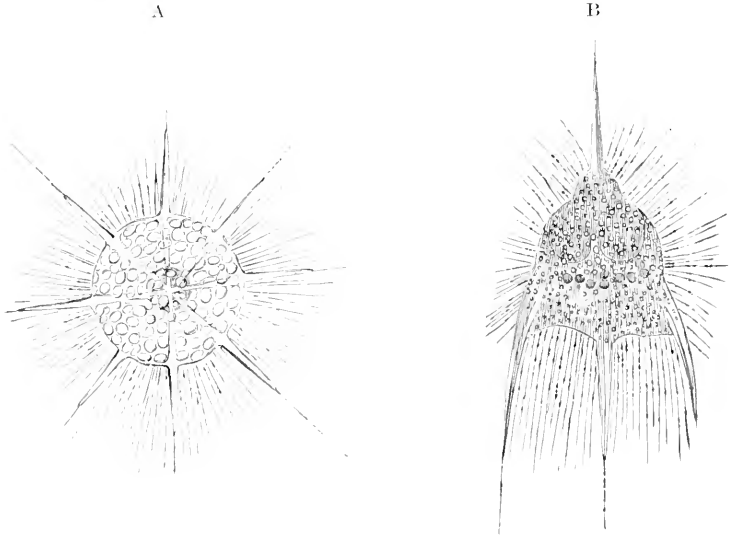

FIG. 645.—Polycystina: A, *Halionema hystrix*; B, *Pterocanium*, with animal.

for they are found also in Actiniae and various other invertebrates; nor are they always present in examples studied; they are now completely recognised¹ as algæ which form a 'symbiotic' relation with their host, the animal profiting by the removal of its waste products by its messmate, by the oxygen which its guest evolves in sunlight, and by the food-material it provides after death, while the plant feeds on the waste of the animal.

In most *Radiolaria* skeletal structures are developed in the sarcode-body, either inside or outside the capsule, or in both positions; sometimes in the form of investing networks having more or less of a *spheroidal* form (fig. 647, 1, 2), or of *radiating* spines, 3, or of combinations of these, 4, 5. But in many cases the skeleton consists only of a few scattered spicules; and this is especially the case in certain large composite forms or 'colonies' (fig. 652), which may

¹ See especially K. Brandt, *Verhandl. Physiol. Gesellsch.* Berlin, 1881-82, p. 22; *Mitth. Zool. Stat. Neapel*, iv, p. 191; P. Geddes, *Nature*, xxv, p. 303.

consist of as many as a thousand zöoids aggregated together in various forms, discoidal, cylindrical, spheroidal, chain-like, or even neck-lace-like. The colonies seem to be produced, like the multiple segments of the bodies of Foraminifera, by the non-sexual multiplication of a primordial zöoid; but whether this multiplication takes place by fission, or by the budding off of portions of the sarcode-body, has not yet been clearly made out. The emission of flagellated zöospores, provided with a very large nucleus, and in some cases with a rod-like crystal, has been observed in many radiolarians; but of the mode in which they are produced, and of their subsequent history, very little is at present known. Until the structure and life history of the animals of this very interesting type shall have been more fully elucidated, no satisfactory classification of them can be framed; and nothing more will be here attempted than to indicate some of the principal forms under which the radiolarian type presents itself.¹

Discida.—Among the beautiful silicious structures which are met with in the radiolarian sandstone of Barbadoes (fig. 644) there is none more interesting than the skeleton of *Astromma* (fig. 648), in which we have a remarkable example of the *range of variation* that is compatible with conformity to a general plan of structure. As in other forms of Haeckel's group of *Discida*, there is in this skeleton a combination of radial and of circumferential parts, the former consisting of solid

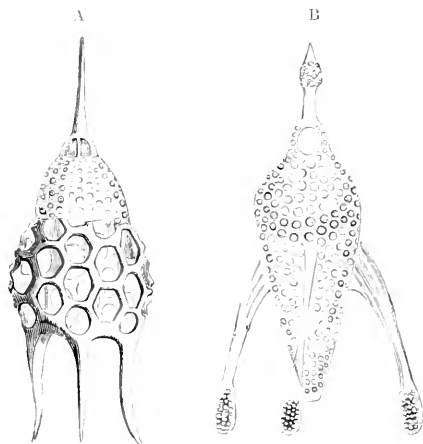

FIG. 646.—Polycystina: A, *Podoryctis Schomburgkii*; B, *Rhopalocanium ornatum*.

latter is composed of a silicious network more or less completely filling up the spaces between the rays. The radial part of the skeleton predominates in the beautiful four-rayed example represented at D, having the form of a cross with equal arms; whilst in F and G it still shows itself very conspicuously, though the spaces between the rays are in great part filled up by the circumferential network. In the five-rayed specimens A and B, on the other hand, the radial portion is much less developed, while the circumferential becomes more discoidal. And in C and E, while the circumferential network forms a pentagonal disc, the radial portion is represented only by solid projections at its angles. The transition between the extreme forms is found to be so gradual when a number of specimens are compared that no lines of specific distinction can be drawn between them; and

¹ Considerable attention has been given to the question of the classification of the Radiolaria by Haeckel and by R. Hertwig, *Jenaische Denkschr.* ii. 1879, p. 129.

the difference in the *number* of rays is probably of no more account in these low forms of animal life than it is in the discoidal diatoms. Other discoidal forms, showing a like combination of radial and circumferential parts, are represented in figs. 649 and 650, and also in fig. 644, *e, m*.

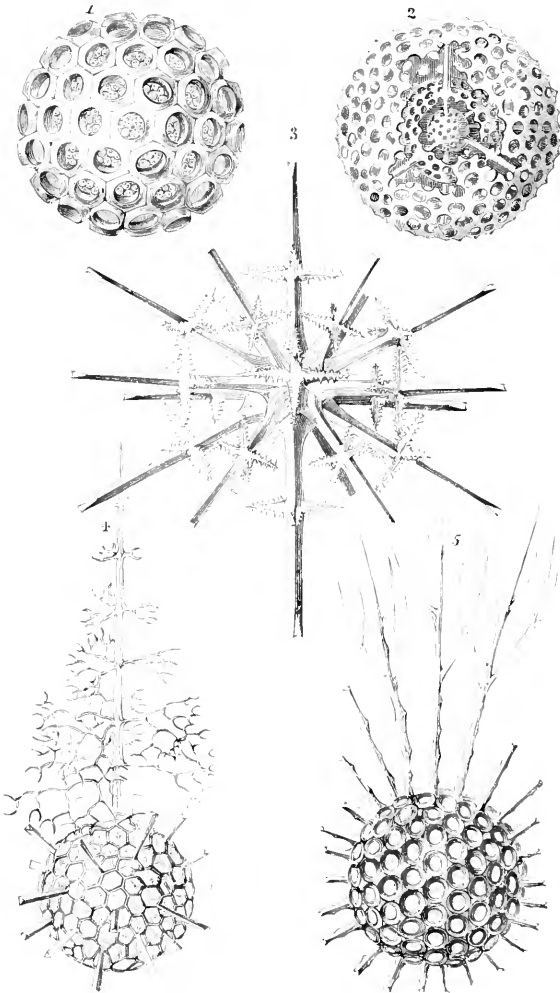

FIG. 647.—Various forms of Radiolaria (after Haeckel): 1, *Ethmosphæra siphonophora*; 2, *Actinomma incrua*; 3, *Acanthometra xiphicantha*; 4, *Arachnosphæra oligacantha*; 5, *Cladococcus riminalis*.

Entosphærida.—In this group the silicious shell is spheroidal, and is formed *within* the capsule; and it is not traversed by radii, although prolongations of the shell often extend themselves radially

outwards, as in *Cladococcus* (fig. 647, 5). Sometimes the central sphere is inclosed in two, three, or even more concentric spheres connected by radii, as in the beautiful *Actinomma* (fig. 647, 2), reminding us of the wonderful concentric spheres carved in ivory by

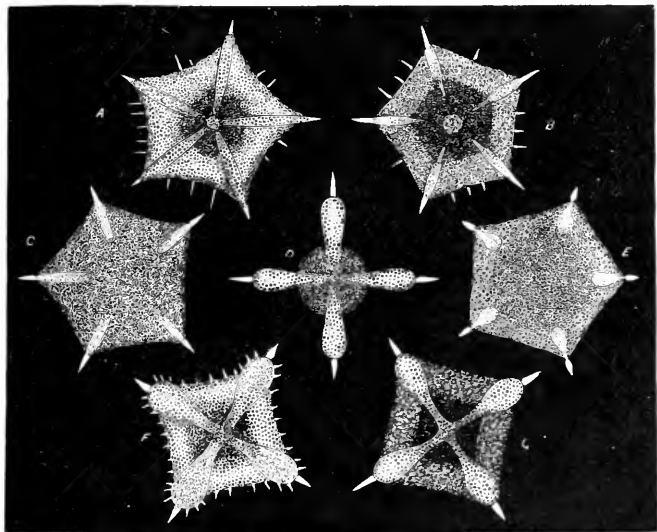

FIG. 648.—Varietal modifications of *Astromma*.

the Chinese. One of the most common examples of this group is the *Haliomma Humboldtii* (fig. 651), in which the shell is double.

Polycystina.—This name, which originally included the preceding group, is now restricted to those which have the shell formed *outside*

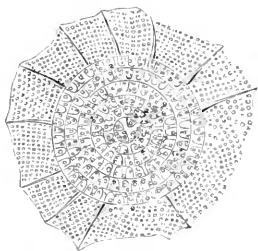

FIG. 649.—*Perichlamyditium praeertum*.

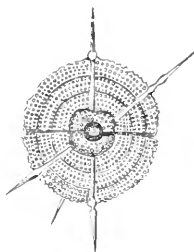

FIG. 650.—*Stylodyctya gracilis*.

the capsule. This shell may, as in the preceding, be a simple sphere composed of an open silicious network, as in *Ethmosphara* (fig. 647, 1); or it may consist of two or three concentric spheres connected by radii; or, again, it may put forth radial outgrowths, which sometimes

extend themselves to several times the diameter of the shell, and ramify more or less minutely, as in *Arachnosphaera* (fig. 647. 4). But more frequently the shell opens out at one pole into a form more or less bell-like, as in *Podocyrtis* (fig. 646. A, and fig. 644. a, o), *Rhopalocanium* (fig. 646. B), and *Pterocanium* (fig. 645. B); or it may be elongated into a somewhat cylindrical form, one pole remaining closed, while the other is more or less contracted, as in *Eucyrtidium* (fig. 644. d, g, i). The transition between these forms, again, proves to be as gradational, when many specimens are compared,¹ as it is among Foraminifera.

Acanthometrina.—In this group the animal is not inclosed within a shell, but is furnished with a very regular skeleton, composed of elongated spines, which radiate in all directions from a common centre (fig. 645. A). The soft sarcode-body is spherical in form, and occupies the spaces left between the bases of these spines, which are sometimes partly inclosed (as in the species represented) by transverse projections. The 'capsule' is pierced by the pseudopodia, whose convergence may be traced from without inwards,

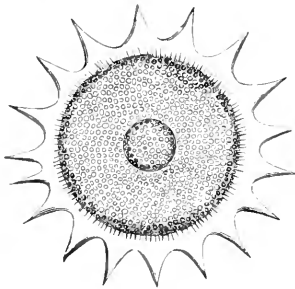

FIG. 651.—*Haliomma Humboldtii*.

afterwards passing through it; and it is itself enveloped in a layer of less tenacious protoplasm, resembling that of which the pseudopodia are composed. One species, the *Acanthometra echinoides*, which presents itself to the naked eye as a crimson-red point, the diameter of the central part of its body being about $\frac{1}{10000}$ ths of an inch, is very common on some parts of the coast of Norway, especially during the prevalence of westerly winds; and the Author has himself met with it abundantly near Shetland, in the floating brown masses termed *madre* by the fishermen (who believe them to furnish food to the herring), which consists mainly of this *Acanthometra* mingled with *Eutomostraca*.

Phæodaria.—Among the most important of the *Radiolaria* collected by the 'Challenger' are the comparatively large (as much as 1 mm. in diameter) single-celled forms which are remarkable for the constant presence of large dark brown granules, which are scattered irregularly round the central capsule and cover the greater part of its outer surface. The nucleus is large, the capsular membrane is always double, and is pierced by one or more large openings; the whole cell is inclosed in a thick gelatinous covering, and there is nearly always a well-developed extracapsular silicious skeleton, according to the structure of which the group is subdivided.²

Collozoa.—To this group belong those remarkable composite forms which, exhibiting the characteristic radiolarian type in their

¹ The general plan of structure of the *Polycystina*, and the signification of their immense variety of forms, were ably discussed by Dr. Wallich in the *Trans. of the Microsc. Soc.* n.s. vol. xiii. 1865, p. 75.

² On reproduction in this group, cf. A. Borgert, *Zool. Anzeig.* xix. (1896), p. 307.

individual zöoids, are aggregated into masses in which the skeleton is represented only by scattered spicules, as in *Spharozoum* (fig. 652) and *Thalassicolla*. These 'sea-jellies,' which so abound in the seas of warm latitudes as to be among the commonest objects collected by the tow-net, are small gelatinous rounded bodies, of very variable size and shape, but usually either globular or discoidal. Externally they are invested by a layer of condensed sarcode, which sends forth pseudopodial extensions that commonly stand out like rays, but sometimes inosculate with each other so as to form a network. Towards the inner surface of this coat are scattered a great number of oval bodies resembling cells having a tolerably distinct membraniform wall and a conspicuous round central nucleus. Each of these bodies appears to be without any direct connection with the rest, but it serves as a centre round which a number of minute yellowish-green vesicles are disposed.

Each of these groups is protected by a silicious skeleton, which sometimes consists of separate spicules (as in fig. 652), but which may be a thin perforated sphere, like that of certain *Polycystina*, sometimes extending itself into radial prolongations. The internal portion of each mass is composed of an aggregation of large vesicle-like bodies imbedded in a softer sarcode substance.¹

From the researches made during the 'Challenger' Expedition, it appears that the *Radiolaria* are very widely diffused through the waters of the ocean, some forms being more abundant in tropical and others in temperate seas; and that they live not only at or near the surface, but also at considerable depths. Their silicious skeletons accumulate in some localities (in which the calcareous remains of Foraminifera are wanting) to such an extent as to form a 'radiolarian ooze;' and it is obvious that the elevation of such a deposit into dry land would form a bed of silicious sandstone resembling the well-known Barbadoes rock, which is said to attain a thickness of 1,100 feet, or a similar rock of yet greater thickness in the Nicobar

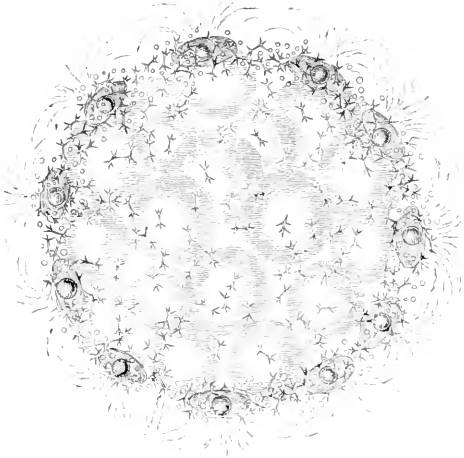

FIG. 652.—*Spharozoum ovoidimare*.

¹ See Professor Huxley (to whom we owe our first knowledge of these forms) in *Ann. Nat. Hist.* ser. ii. vol. viii. 1851, p. 433; also Professor Müller, of Berlin, in *Quart. Journ. Microsc. Sci.* vol. iv. 1856, p. 72, and in his treatise *Ueber die Thalassicollen, Polycystinen, und Acanthometren des Mittelmeeres*, the magnificent work of Professor Haeckel, *Die Radiolarien*, and the monograph by K. Brandt, published in the *Fauna und Flora des Golfes von Neapel*, 1885, 'Die koloniebildenden Radiolarien (Spherozoöen) des Golfes von Neapel.'

Islands. Few microscopic objects are more beautiful than an assemblage of the most remarkable forms of the Barbadian *Polycystina* (fig. 644), especially when seen brightly illuminated upon a black ground; since (for the reason formerly explained) their solid forms then become much more apparent than they are when these objects are examined by light transmitted through them. And when they are mounted in Canada balsam the black-ground illumination is much to be preferred for the purpose of display, although minute details of structure can be better made out when they are viewed as transparent objects with higher powers. Many of the more solid forms when exposed to a high temperature on a slip of platinum foil undergo a change in aspect which renders them peculiarly beautiful as opaque objects, their glassy transparency giving place to an enamel-like opacity. They may then be mounted on a black ground and illuminated either with a side condenser or with the parabolic speculum. No class of object is more suitable than these to the binocular microscope, its stereoscopic projection causing them to be presented to the mind's eye in complete relief, so as to bring out with the most marvellous and beautiful effect all their delicate sculpture.¹

¹ For a fuller description of the fossil forms of this group see Professor Ehrenberg's memoirs in the *Monatsberichte* of the Berlin Academy for 1846, 1847, and 1850; also his *Microgeologie*, 1854; and *Ann. of Nat. Hist.* vol. xx. 1847. The best method of separating the *Polycystina* from the Barbadoes sandstone is described by Mr. Furlong in the *Quart. Journ. of Microsc. Sci.* n.s. vol. i. 1861, p. 64.

CHAPTER XV

SPONGES AND ZÖOPHYTES

I. SPONGES

WE now leave the PROTOZOA and commence the study of the METAZOA, or those forms in which the egg-cell undergoes subdivision, the resulting elements of which do not separate or lead an independent existence, but combine to form an organic whole, various parts undertaking various functions. Of these Metazoa the simplest examples are to be found among SPONGES. The determination of the real character of the animals of this class has been entirely effected by the microscopic examination of their minute structure: for until this came to be properly understood, not only was the general nature of these organisms entirely misapprehended, but they were regarded by many naturalists as having no certain claim to a place in the animal kingdom. What that place is, is, to some extent, still an open question,¹ but it may now be unhesitatingly affirmed that a sponge is an aggregate of protozoic units only in the sense in which all Metazoa are composed of cells; some of these cells have a striking resemblance to the collared *Flagellata* (fig. 585), whilst others resemble *Amoeba* (fig. 577). These units are held together by a continuous connective-tissue-like substance which clothes the skeletal framework that represents our usual idea of a sponge, and is itself made up of distinct cellular elements. In the simpler forms of sponges, however, this framework is altogether absent; in others it is represented only by calcareous or silicious 'spicules,' which are dispersed through the sarcodic substance (fig. 654, B); in others, again, the skeleton is a keratose (horny) network, which may be entirely destitute (as in our ordinary sponge) of any mineral support, but which is often strengthened by calcareous or silicious spicules (fig. 654); whilst in what may be regarded as the highest types of the group, the silicious component of the skeleton increases, and the keratose diminishes until the skeleton consists of a beautiful silicious network resembling spun glass. But whatever may be the condition of the *skeleton*, that of the body that clothes it remains

¹ For an instructive discussion on this point, consult Prof. E. A. Minchin's essay on 'The Position of Sponges in the Animal Kingdom' in *Science Papers*, i. (n.s.) (1897), to which is appended a useful list of works on the subject. Some authors demur to the association of sponges with other Metazoa, and Professor Sella has suggested the use of the group-name Parazoa. See also *Treatise on Zoology*, vol. ii. London, 1900.

essentially the same; and the peculiarity that chiefly distinguishes the sponge-colony from the plant-like colonies of the flagellate Infusoria is that whilst the latter extend themselves *outwards* by repeated ramification, sending their zöoid-bearing branches to meet the water they inhabit, the surface of the former extends itself *inwards*, forming a system of passages and cavities lined by these and the amöboïd cells, through which a current of water is drawn in to meet them by the action of the flagella. The minute pores (fig. 653, *b, b*) with which the surface *a, a* of the living sponge is beset lead to incurrent passages that open into chambers lying beneath it (*c, c*), and open into the 'ampullaceous sacs,' or, as they are now called, 'flagellate chambers,' from the presence round their walls of the flagellate or collared cells. The water drawn in by their agency is driven outwards through a system of excurrent canals, which, uniting into larger trunks, proceed to the

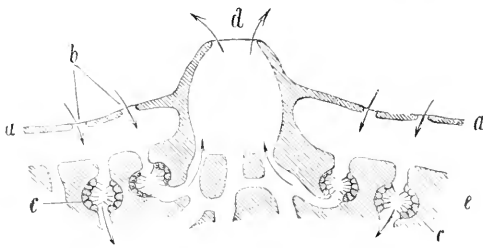

FIG. 653.—Diagrammatic section of a sponge: *a, a*, superficial layer; *b, b*, inhalant apertures or pores; *c, c*, flagellated chambers; *d, d*, exhalant oscule; *e, e*, deeper substance of the sponge.

oscula or projecting vents, *d, d*, from each of which, during the active life of the sponge, a stream of water, carrying out excrementitious matter, is continually issuing. The in-current brings into the chambers both food-material and oxygen; and from the manner in which coloured particles experimentally diffused

through the water wherein a sponge is living are received into its protoplasmic substance, it seems clear that the nutrition of the entire fabric is the resultant of the feeding action of the flagellate units, each of which takes in, after its kind, the food-particles brought by the current of water, and imparts the product of its digestion of them to the general sarcoëdic mass.

The continuous substance that clothes the skeleton of the sponge and constitutes the chief part of its living body includes great numbers of stellate granular cells. Their long slender pseudopodia, radiating towards those of their neighbours, often unite together to form a complex network; on the chief parts of the course of the water-way they become fusiform in shape and contractile in function, and it is by their agency that the continual contractions and expansions of the oscula are produced, which are very characteristic of the living sponge. As was first shown by Professor C. Stewart, sensory organs, formed of groups of cells with long projecting filaments, are to be seen on the surface of many sponges. Any one of these amöboïds, again, detached from the mass, may lay the foundation of a new 'colony.' In the aggregate mass produced by its continuous segmentation certain globular clusters are distinguishable, each having a cavity in

its interior; and the amœboids that form the wall of this cavity become metamorphosed into collared flagellate cells whose flagella project into it. Thus is formed one of the characteristic 'ampullaceous sacs,' which, at first closed, afterwards communicates with the exterior, on the one hand by an incurrent passage, and on the other with the excurrent canal-system leading to the oscula. Besides this reproduction by 'microspores,' there is another form of non-sexual reproduction by macrospores, which are clusters of amœboids encysted in firm capsules, frequently strengthened on their exterior by a layer of spicules of very peculiar form. These 'seed-like bodies,' which answer to the encysted states of many protophytes, are met with in the substance of the sponge, chiefly in winter; and after being set free through the oscula they give exit to their contained amœboids, each of which may found a new colony. A true process of sexual generation, moreover, is known to take place in sponges, certain of the amœboids, like certain cells of *Folcor*, becoming 'sperm-cells,' and developing spermatozoa by the metamorphosis of their nuclei; while others become 'germ-cells,' developing themselves by segmentation (when fertilised) into the bodies known as 'ciliated gemmules,' which are set free from the walls of the canals, swim forth from the vents, and for a time move actively through the water. In a word, there is true sexual reproduction by ova and spermatozoa, as in all animals that are not Protozoa.¹

The arrangement of the keratose reticulation in the sponges with which we are most familiar may be best made out by cutting thin slices of a piece of sponge submitted to firm compression, and viewing these slices, mounted upon a dark ground, with a low magnifying power under incident light. Such sections, thus illuminated, are not merely striking objects, but serve to show very characteristically the general disposition of the larger canals and of the smaller pores with which they communicate. In the ordinary sponge the fibrous skeleton is almost entirely destitute of spicules, the absence of which, in fact, is one important condition of that flexibility and compressibility on which its uses depend. When spicules exist in connection with such a skeleton, they are usually either altogether imbedded in the fibres, or are implanted into them at their bases; but smaller and simpler sponges, such as *Grantia*, have no horny skeleton, and their calcareous spicules are imbedded in the general substance of the body. Sponge-spicules are much more frequently silicious than calcareous; and the variety of forms presented by the silicious spicules is much greater than that which we find in the comparatively small division in which they are composed of carbonate of lime. The long needle-like spicules, which are extremely abundant in several sponges, lying close together in bundles, are sometimes straight, sometimes slightly curved; they are sometimes pointed at both ends, sometimes at one only; one or both ends may be furnished with a head like that of a

¹ See Chapter V. of Mr. Saville Kent's *Manual of the Infusoria*, and Chapter V. of vol. i. of Mr. Balfour's *Comparative Embryology*, as well as Professor Haeckel's important work on the Calcareous Sponges.

pin or may carry three or more diverging points which sometimes curve back so as to form hooks. When the spicules project from the horny framework they are usually somewhat conical in form, and their surface is often beset with little spines arranged at regular inter-

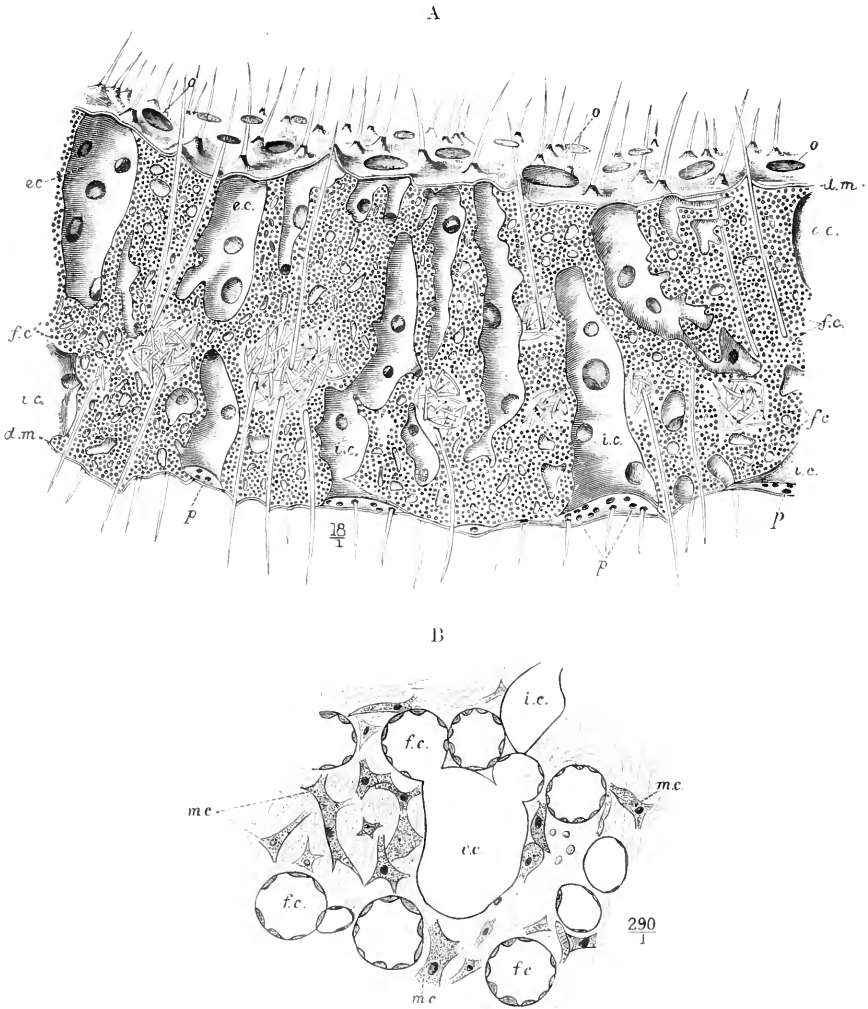

FIG. 654.—A, section through *Phakellia ventilabrum*, var. *connexida*, taken at right angles to the surface, to show the arrangement of the parts of a sponge: *p*, pores on the surface leading to *ic*, the inhalant canals, then to the flagellated chambers, *fc*, and thence to the exhalant canals, *ec*, to *o*, the oscula in the dermal membrane, *dm*. B, more highly magnified view of the internal portion (choanosome) of *Axinella paradoxa* $\times 290$: *mc*, so-called mesodermal cells. Other letters as in A. (After Ridley and Dendy.)

vals, giving them a jointed appearance.¹ The more recent authorities on Sponges, such as Professor Sollas and Messrs. Ridley and Dendy, have recognised that in the present state of our knowledge the spicules which are ordinarily found in silicious Sponges belong to one of two groups, which, as they differ considerably in size, may be called megaloscleres (or, more correctly, megaloscleres) and microscleres. It is to the definite arrangement of the former that, with or without the addition of spongin, the sponge owes its definite skeleton: the microscleres give consistency to the tissue of the sponge, and are irregularly scattered throughout its substance. If we desire to give them physiological names we may call the megaloscleres skeletal spicules, and the microscleres flesh-spicules. If we bear in mind that in the opinion of the most competent spongiologists the polyaxial spicules are the most primitive, there is no practical objection to our noticing them in the reverse order, a method which will be found to conduce to simplicity of description. In the examination of spicules, it is necessary, first of all, to distinguish between *axes* and *rays*; thus in the Monaxonida the megaloscleres have but a single axis, but the growth from the point of origin may be on either side, when we have two-rayed or diactinal megaloscleres, or it may extend in one direction only, when the scleres are said to be monactinal. In the Calcispongiae there are three axes and three rays; but in some sponges, such as Venus's flower-basket, the growth is along both directions of the axes, so that while there are three axes there are six rays, or the spicules are hexactinellid. In others, such as *Coelia* and the Lithistid Sponges, there are four axes, whence such forms are called tetraxonid.

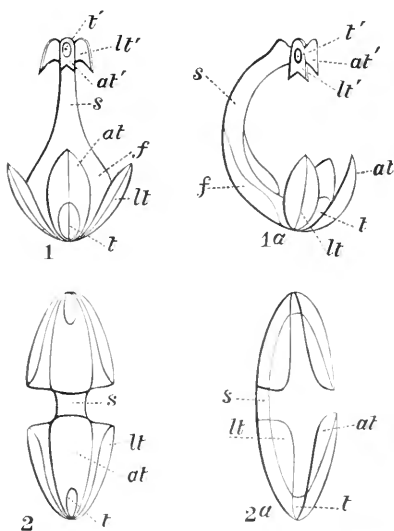

FIG. 655.—Structure of the chele of Monaxonid Sponges: 1, tridentate anisochela from in front; 1a, from the side; 2, 2a, front and side views of a palmate isochela: *t*, *t'*, tubercle; *at*, *at'*, anterior tooth or palm; *lt*, *lt'*, lateral tooth or palm; *s*, shaft; *f*, fimbria. (After Ridley and Dendy.)

¹ A minute account of the various forms of spicules contained in Sponges is given by Mr. Bowerbank in his first memoir 'On the Anatomy and Physiology of the Spongiadae' in *Phil. Trans.* 1858, pp. 279-332; and in his *Monograph of the British Spongiadae*, published by the Ray Society. The Calcareous Sponges have been made by Professor Haeckel the subject of an elaborate monograph, *Die Kalkschwämme*, Berlin, 1872. For enumerations and classifications of the various kinds of spicules, see Professor Sollas, art. 'Sponges,' in the 9th edition of the *Encycl. Britannica*, and Messrs. Ridley and Dendy, *Report on the 'Challenger' Monaxonida*, pp. xv-xxi.

Lastly there are the least regular megaloscleres, which may be multi-radiate or spherical.

As is well known, the flesh-spicules are of the most varied forms, and it is a matter of some difficulty so to group them as to render them more easy of comprehension by the student. Messrs. Ridley and Dendy suggest that, provisionally at any rate, we should regard them as (1) simple linear, (2) hooked, (3) stellate. The first may be pointed at either end, and these are often spinous, or they may be long and hair-like, and be or not be arranged in bundles (*dragmata*); a common form is that of a bow, and these, again, are sometimes arranged in bundles, which have been formed within one and the same cell. The hooked forms may be simple signiform microscleres, or the shape may be complicated by the inner margin of the shaft or hook thinning out to a fine knife-edge. The most complex forms of this group are the microscleres which the just-quoted authors denominate *chela*. They describe these scleres (fig. 655) as having a more or less curved shaft (s), which bears at each end a variable number of

sharply recurved processes (*at, at', lt, lt'*), which they call the 'teeth,' or if broad and expanded the 'palms'; these are connected with the shaft by a buttress-like projection, which is generally so transparent as to be with difficulty made out. The shaft itself is frequently drawn out at the side into wing-like processes or fimbriæ (*f*). If the two ends of the spicule are equal, we have *isochela*; if unequal, *anisochela*. The stellate microscleres may be spiral, have a shaft with spinose whorls, or a cylindrical shaft with a toothed whorl at either end. The

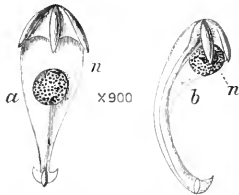

FIG. 656.—Anisochela of *Cladarrhiza inversa*, showing *n*, the nucleus of the mother-cell of the spicule, from in front, *a*, and from the side, *b*. $\times 300$. (After Ridley and Dendy.)

spicules of sponges cannot be considered, like the *raphides* of plants, as mere deposits of mineral matter in a crystalline state; for, like all other parts of the organism, they are of cellular origin (fig. 656), and the special cells which produce them are distinguished as silico-blasts; in this there is first developed a central organic thread around which concentric layers of silica or chalk are laid down.¹

There is an extremely interesting group of Sponges in which the horny skeleton is entirely replaced by a *silicious* framework of great firmness and of singular beauty of construction. This framework may be regarded as fundamentally consisting of an arrangement of *six-rayed* spicules, the extensions of which come to be, as it were, soldered to one another; and hence the group is distinguished as *severadiate*. Of this type the beautiful *Euplectella* of the Manila seas—which was for a long time one of the greatest of zoölogical rarities, but which now, under the name of 'Venus's flower-basket,' is a common ornament of our drawing-rooms—is one of the most characteristic examples.² Another example is presented by the

¹ For a compendious statement of the characters of sponge-spicules see pp. 82-4 of Mr. A. Sedgwick's *Student's Text-book of Zoölogy*, London, 1898.

² The structure and arrangement of the soft parts of *Euplectella aspergillum* have

Holténia Carpenteri, of which four specimens, dredged up from a depth of 530 fathoms between the Faroë Islands and the north of Scotland, were among the most valuable of the 'treasures of the deep' obtained during the first deep-sea exploration (1868) carried out by Sir Wyville Thomson and the Author. This is a turnip-shaped body, with a cavity in its interior, the circular mouth of which is surrounded with a fringe of elongated silicious spicules; whilst from its base there hangs a sort of beard of silicious threads that extend themselves, sometimes to a length of several feet, into the Atlantic mud on which these bodies are found. The framework is much more massive than that of *Euplectella*, but it is not so exclusively mineral; for if it be boiled in nitric acid it is resolved into separate spicules, these being not soldered together by silicious continuity, but held together by animal matter. Besides the regular sex-radiate spicules, there is a remarkable variety of other forms, which have been fully described and figured by Sir Wyville Thomson.¹ One of the greatest features of interest in this *Holténia* is its singular resemblance to the *Ventriculites* of the Cretaceous formation. Subsequent investigations have shown that it is very widely diffused, and that it is only one of several deep-sea forms, including some of singularly beautiful structure, which are the existing representatives of the old ventriculite type. One of these was previously known from being occasionally cast up on the shore of Barbadoes after a storm. This *Dictyodalyx puniceus* has the shape of a mushroom, the diameter of its disc sometimes ranging to a foot. A small portion of its reticulated skeleton is a singularly beautiful object when viewed with incident light under a low magnifying power.

With the exception of the genus *Spongilla* and its allies, all known sponges are marine, but they differ very much in habit of growth. For whilst some can only be obtained by dredging at considerable depths, others live near the surface, whilst others attach themselves to the surfaces of rocks, shells, &c. between the tide-marks. The various species of *Grantia* in which, of all the marine sponges, the flagellate cells can most readily be observed, belong to this last category. They have a peculiarly simple structure, each being a sort of bag whose wall is so thin that no system of canals is required, the water absorbed by the outer surface passing directly towards the inner, and being expelled by the mouth of the bag. The flagella may be plainly distinguished with a $\frac{1}{4}$ -inch objective on some of the cells of the gelatinous substance scraped from the interior of the bag; or they may be seen *in situ* by making very thin transverse sections of the substance of the sponge. It is by such sections alone that the internal structure of sponges, and the relation of their spicular and horny skeletons to their fleshy substance, can be demonstrated. They are best made by the imbedding process. In order to obtain the *spicules* in an isolated condition, the animal matter must be got rid of either by incineration or by chemical

been investigated by Prof. F. E. Schulze, *Trans. Royal Soc. of Edinburgh*, xxix. p. 661.

¹ See his elaborate memoir in *Phil. Trans.* 1870, and his *Depths of the Sea*, 1872 p. 71.

reagents. The latter method is preferable, as it is difficult to free the mineral residue from carbonaceous particles by heat alone. If (as is commonly the case) the spicules are *silicious*, the sponge may be treated with strong nitric or nitro-muriatic acid, until its animal substance is dissolved away; if, on the other hand, they are *calcareous*, a strong solution of potass may be employed instead of the acid. The operation is more rapidly accomplished by the aid of heat; but if the saving of time be not of importance, it is preferable on several accounts to dispense with it. The spicules, when obtained in a separate state, should be mounted in Canada balsam. Sponge tissue may often be distinctly recognised in sections of agate, chalcidony, and other silicious concretions, as will be more fully stated hereafter.¹

II. ZÖOPHYTES (CÆLENTERA)

Under the general designation *Zöophytes* it will be still convenient to group those animals which form composite skeletons or 'polyaries' of a more or less plant-like character, associating with them the *Acalephs*, which are now known to be the 'sexual zöoids' of polypes, but excluding the *Polyzoa* on account of their very different structure, notwithstanding their zöophytic forms and habits of life. The animals belonging to this group may be considered as formed upon the primitive *gastrula* type, their gastric cavity (though sometimes extending itself almost indefinitely) being lined by the original *endoderm*, and their surface being covered by the original *ectoderm*, and these two lamellæ not being separated by the interposition of any body-cavity or *cœlom*. It is a fact of great interest

that although the product of the development of a *morula* is here a distinctly individualised polype, in which several mutually dependent parts make up

FIG. 657.—Longitudinal section of the body of a hydra killed in full digestion: *ec*, ectoderm; *en*, endoderm; *mp*, muscular processes; *d*, a diatom; *f*, food. (After T. J. Parker.)

a single organic whole, yet these parts still retain much of their independent protozoic life; which is manifested in two very remarkable modes. In the first place, the digestive sac is observed to be lined by a layer of amoeboid cells, which send out pseudopodial

¹ A complete and valuable handbook to the Sponges has been published by Dr. G. C. Vosmaer as vol. ii. of Bronn's *Klassen und Ordnungen des Thierreichs*, Leipzig, 1887. Compare also the article by Professor Sollas in the ninth edition of the

prolongations into its cavity (fig. 657) by whose agency (it may be pretty certainly affirmed) the nutrient material is first introduced into the body-substance. This process of 'intracellular digestion' was first noticed by Professor Allman in the beautiful hydroid polype *Myriothele*; ¹ the like has been since shown by Mr. Jeffery Parker to be true of the ordinary *Hydra*; ² and Professor E. Ray Lankester has made the same observation upon the curious little Medusa (*Limnocoodium*), which lives in *fresh-water* tanks in this country, whither it has undoubtedly been introduced; while the observations of Krukenberg have shown that a similar process obtains among the sea-anemones. ³ (It may be mentioned in this connection, that Metschnikoff has seen the cells which line the alimentary canal of the lower planarian worms gorging themselves with coloured food-particles, exactly in the manner of *Amoeba* and the liver-fluke, and that a number of larvæ are known to obtain their nourishment in the same way.) ⁴ The second 'survival' of protozoic independence is shown in the extraordinary power possessed by *Hydra*, *Actinia*, &c. of reproducing the entire organism from a mere fragment. This great division includes the two principal groups the HYDROZOA and the ACTINOZOA, the former comprehending the *Polypes*, and the latter the *Anemones*. In the Hydrozoa the mouth is placed on a projecting oral cone, while in the Anthozoa it is sunk below the level of the oral circle of tentacles, and the cavity developed from and connected with the digestive cavity separates its wall from the body-wall and is traversed by a series of vertical partitions or septa. As most of the hydroid polypes are essentially microscopic animals, they need to be described with some minuteness; whilst in regard to the Actinozoa those points only will be dwelt on which are of special interest to the microscopist.

Hydrozoa.—The type of this group is the *Hydra* or fresh-water polype, a very common inhabitant of pools and ditches, where it is most commonly to be found attached to the leaves or stems of aquatic plants, floating pieces of stick, &c. Two species are common in this country, the *H. viridis* or green polype, and the *H. vulgaris*, which is usually orange-brown, but sometimes yellowish or red (its colour being liable to some variation according to the nature of the food on which it has been subsisting); a third less common species, the *H. fusca*, is distinguished from both the preceding by the length of its tentacles, which in the former are scarcely as long as the body, whilst in the latter they are, when fully extended, many times longer

Encyclopædia Britannica; the 'Challenge' Reports by Professor Schulze, Messrs. Ridley and Dendy, Poléjoeff, and Sollas; and the numerous memoirs of Professors O. Schmidt and Schulze. More recently important additions to our knowledge of Sponges have been made by Prof. Yves Delage and Monsieur E. Topsent in the *Arch. Zool. Expér. et Gén.* 1892-5, and by Dr. O. Maas in the *Mitth. Zool. Stat. Neapel*, x. and elsewhere.

¹ *Phil. Trans.* 1875, p. 552. It should be noted that the late Professor Claus called attention to the ingestion of foreign bodies by amoeboid cells of *Monophyes* in 1874. See his *Schriften Zool. Inhalts* (Wien, 1874), p. 30.

² *Proc. of Roy. Soc.* vol. xxx. 1880, p. 61.

³ *Quart. Journ. Microsc. Sci.* u.s. vol. xx. 1880, p. 371.

⁴ Consult an interesting article on 'Intercellular Digestion,' by Metschnikoff, in *Revue Scientifique*, ser. iii. vol. xi. p. 683.

(fig. 658).¹ The body of the Hydra consists of a simple bag or sac, which may be regarded as a stomach, and is capable of varying its shape and dimensions in a very remarkable degree, sometimes extending itself in a straight line so as to form a long narrow cylinder, at other times being seen (when empty) as a minute contracted globe, whilst, if distended with food, it may present the form of an inverted flask or bottle, or even of a button. At the upper end of this sac is a central opening, the mouth; and this is surrounded by

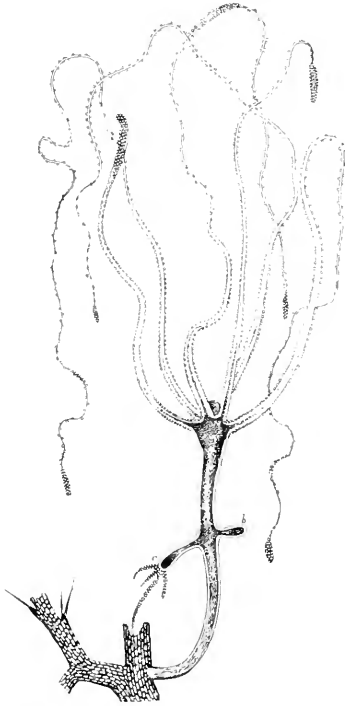

FIG. 658.—*Hydra fusca*, with a young bud at *b*, and a more advanced bud at *c*.

a circle of tentacles or 'arms,' usually from six to ten in number, which are arranged with great regularity around the orifice. The body is prolonged at its lower end into a narrow base, which is furnished with a suctorial disc, and the Hydra usually attaches itself by this, while it allows its tendril-like tentacles to float freely in the water. The wall of the body is composed of two layers of cells; and between these, which are the ectoderm and endoderm, there is a delicate intermediate layer, which forms the supporting lamella.² The arms are made up of the same materials as the body; but their surface is beset with little wart-like prominences, which, when carefully examined, are found to be composed of clusters of 'thread-cells,' having a single large cell with a long spiculum in the centre of each. The structure of these thread-cells or 'urticating organs' will be described hereafter; at present it will be enough to point out that this apparatus, repeated

many times on each tentacle, is doubtless intended to give to the organ a great prehensile power, the minute filaments forming a rough surface adapted to prevent the object from readily slipping out of the grasp of the arm, whilst the central spicule or 'dart' is projected into its substance, probably conveying into it a poisonous fluid secreted by a vesicle at its base.

¹ On the specific characters of *Hydra* consult Haucke, *Jenaische Zeitschr.* xiv. p. 133; and Jickeli, *Zöol. Anzeig.* v. p. 491.

² To this intermediate layer, Mr. G. C. Bourne applies the term *mesogloia*. For an account of its variations and structure among the Coelentera, and a discussion of its homology with the mesoderm of higher Metazoa, see his essay on *Fungia* in vol. xxvii. of the *Quart. Journ. Microsc. Sci.* u.s.

The latter inference is founded upon the oft-repeated observation that if the living prey seized by the tentacles have a body destitute of hard integument, as is the case with the minute aquatic worms which constitute a large part of its aliment, this speedily dies, even though, instead of being swallowed, it escapes from their grasp; whilst, on the other hand, minute Entomostraca, insects, and other animals or ova, with hard envelopes, may escape without injury, even after having been detained for some time in the polype's embrace.

The contractility of the tentacles (the interior of which is traversed by a canal that communicates with the cavity of the stomach) is very remarkable, especially in the *Hydra fusca*, whose arms, when extended in search of prey, are not less than seven or eight inches in length; whilst they are sometimes so contracted, when the stomach is filled with food, as to appear only like little tubercles around its entrance. By means of these instruments the Hydra is enabled to draw its support from animals whose activity, as compared with its own slight powers of locomotion, might have been supposed to remove them altogether from its reach: for when, in its movements through the water, a minute worm or a water-flea happens to touch one of the tentacles of

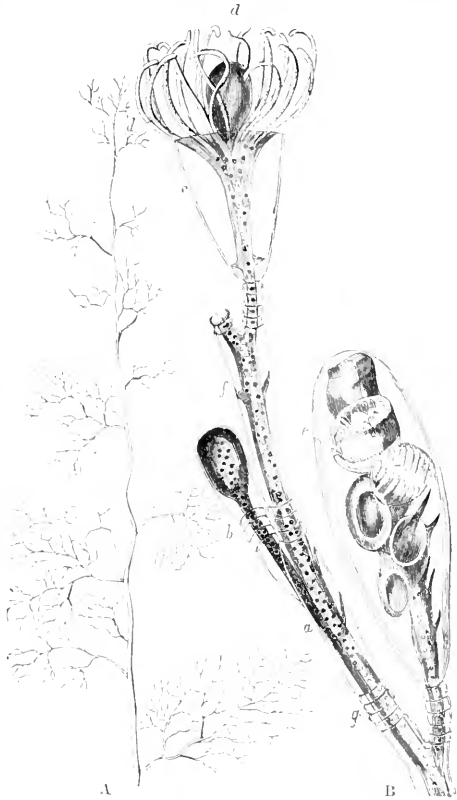

FIG. 659.—*Campanularia gelatinosa*.

the polype, spread out as these are in readiness for prey, it is immediately seized by this; other arms are soon coiled around it, and the unfortunate victim is speedily conveyed to the stomach, within which it may frequently be seen to continue moving for some little time. Soon, however, its struggles cease, and its outline is obscured by a turbid film, which gradually thickens, so that at last its form is wholly lost. The soft parts are soon completely dissolved, and the harder indigestible portions are rejected through the mouth. A second orifice has been observed at the lower extremity

of the stomach; but this would not seem to be properly regarded as anal, since it is not used for the discharge of such exuviae; it is probably rather to be considered as representing, in the *Hydra*, the entrance to that ramifying cavity which, in the *compound Hydrozoa*, brings into mutual connection the lower extremities of the stomachs of all the individual polypes.

The ordinary mode of reproduction in this animal is by a 'gemination' resembling that of plants. Little bud-like processes (fig. 658, *b*, *c*) developed from its external surface gradually come to resemble the parent in character, and to possess a digestive sac, mouth, and tentacles; for a long time, however, their cavity is connected with that of the parent, but at last the communication is cut off by the

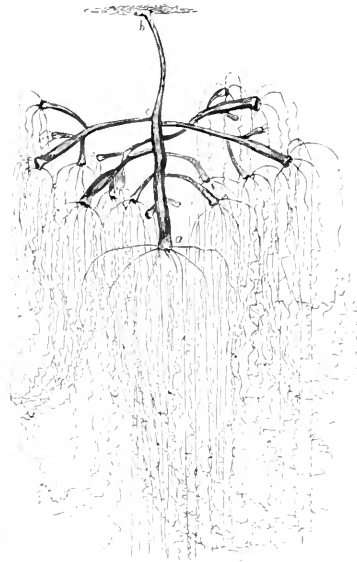

FIG. 660.—*Hydra fusca* in gemination: *a*, mouth; *b*, base; *c*, origin of one of the buds.

closure of the canal of the foot-stalk, and the young polype quits its attachment and goes in quest of its own maintenance. A second generation of buds is sometimes observed on the young polype before quitting its parent; and as many as *nineteen* young *Hydra* in different stages of development have been seen thus connected with a single original stock (fig. 660). This process takes place most rapidly under the influence of warmth and abundant food: it is usually suspended in winter, but may be made to continue by keeping the polypes in a warm situation and well supplied with food. Another very curious endowment seems to depend on the same condition—the extraordinary power which one portion possesses of reproducing the rest. Into whatever number of parts a *Hydra* may be divided, each may retain its vitality, and give origin to a

new and entire fabric: so that *thirty* or *forty* individuals may be formed by the section of one. The *Hydra* also propagates itself, however, by a truly sexual process, the fecundating apparatus, or vesicle producing 'sperm-cells,' and the ovum (containing the 'germ-cell,' imbedded in a store of nutriment adapted for its early development), being both evolved in the substance of the walls of the stomach—the male apparatus forming a conical projection just beneath the arms, while the female ovary, or portion of the body-substance in which the ovum is generated, has the form of a knob protruding from the middle of its length. It would appear that sometimes one individual *Hydra* develops only the male cysts or sperm-cells, while another develops only the female cysts or ovi-

sacs; but the general rule seems to be that the same individual forms both organs. The fertilisation of the ova, however, cannot take place until after the rupture of the spermatocyst and of the ovisac, by which the contents of both are set free. The autumn is the chief time for the development of the sexual organs, but they also present themselves in the earlier part of the year, chiefly between April and July. According to Ecker, the eggs of *H. viridis* produced early in the season run their course in the summer of the same year; while those produced in the autumn pass the winter without change. When the ovum is nearly ripe for fecundation the ovary bursts its ectodermal covering, and remains attached by a kind of pedicle. It seems to be at this stage that the act of fecundation occurs: a very strong elastic shell or capsule then forms round the ovum, the surface of which is in some cases studded with spine-like points, in others tuberculated, the divisions between the tubercles being polygonal. The ovum finally drops from its pedicle, and attaches itself by means of a mucous secretion, till the hatching of the young Hydra, which comes forth provided with four rudimentary tentacles like buds. The Hydra possesses the power of free locomotion, being able to remove from the spot to which it has attached itself to any other that may be more suitable to its wants; its changes of place, however, seem rather to be performed under the influence of *light*, towards which the Hydra seeks to move itself, than with reference to the search after food.¹

The *compound Hydroids* may be likened to a *Hydra* whose gemmæ, instead of becoming detached, remain permanently connected with the parent; and as these in their turn may develop gemmæ from their own bodies, a structure of more or less arborescent character, termed a *polygyny*, may be produced. The form which this will present, and the relation of the component polypes to each other, will depend upon the mode in which the gemmation takes place; in all instances, however, the entire cluster is produced by continuous growth from a single individual; and the stomachs of the several polypes are united by tubes, which proceed from the base of each, along the stalk and branches, to communicate with the cavity of the central stem. Whatever may be the form taken by the stem and branches constituting the polygyny of a hydroid colony, they will be found to be, or to contain, fleshy tubes having two distinct layers, the inner (endoderm) having nutritive functions; the outer (ectoderm) usually secreting a hard cortical layer, and thus giving rise to fabrics of various forms. Between these a muscular coat is sometimes noticed. The fleshy tube, whether single or compound, is called a *canosare*, and through it the nutrient matter circulates. The 'zöoids,' or individual members of the colony, are of two kinds: one the *polypite*, or *alimentary zöoid*, resembling the Hydra in essential

¹ A very full account of the structure and development of *Hydra* has been published by Kleiemberg, of whose admirable monograph a summary is given by Professor Allman, with valuable remarks of his own, in *Quart. Journ. Microsc. Sci.* n.s. vol. xiv. 1874, p. 1. See also the important paper by the late Mr. Jeffery Parker already cited. On the chlorophyll corpuscles of *H. viridis* consult Brandt, *Mitth. Zool. Stat. Neapel*, iv. p. 191; Hamann, *Zool. Anzeig.* vi. p. 367; and Lankester *Quart. Journ. Microsc. Sci.* n.s. xxii. p. 229.

structure, and more or less in aspect; the other, the *gonozöoid*, or *sexual zöoid*, developed at certain seasons only, in buds of particular shape.¹

The simplest division of the Hydroida is that adopted by Mr. Hincks,² who groups them under the sub-order *Athecata* and *Thecata*, the latter being again divided into the *Thecaphora* and the *Gymnochroa*. In the first, neither the 'polypites' nor the sexual zöoids bear true protective cases; in the second the polypites are lodged in cells, or, as Mr. Hincks prefers to call them, *calyces*, many of which resemble exquisitely formed crystal cups, variously ornamented, and sometimes furnished with lids or opercula; in the third, which contains the Hydraz, there is no polypary, and the reproductive zöoids (gonozöoids) are always fixed and developed in the body-walls. According to Mr. Hincks, the two sexes are sometimes borne on the same colony, but more commonly the zöophyte is dioecious. The cases, however, are much less rare than has been supposed in which both male and female are mingled on the same shoots. The sexual zöoids either remain attached, and discharge their contents at maturity, or become free and enter upon an independent existence. The free forms nearly always take the shape of *Medusa* (jelly-fish), swimming by rhythmical contractions of their bell or umbrella. The digestive cavity is in the handle (manubrium) of the bell; and the generative elements (sperm-cells or ova) are developed either between the membranes of the manubrium or in special sacs in the canals radiating from it. The ova, when fertilised by the spermatozoa, undergo 'segmentation' according to the ordinary type, the whole yolk-mass subdividing successively into two, four, eight, sixteen, thirty-two or more parts, until a 'mulberry mass' is formed; this then begins to elongate itself, its surface being at first smooth and showing a transparent margin, but afterwards becoming clothed with cilia, by whose agency these little *planula*, closely resembling ciliated Infusoria, first move about within the capsule, and then swim forth freely when liberated by the opening of its mouth. At this period the embryo can be made out to consist of an outer and an inner layer of cells, with a hollow interior; after some little time the cilia disappear, and one extremity becomes expanded into a kind of disc by which it attaches itself to some fixed object; a mouth is formed, and tentacles sprout forth around it; and the body increases in length and thickness, so as gradually to acquire the likeness of one of the parent polypes, after which the 'polypary' characteristic of the genus is gradually evolved by the successive development of polype-buds from the first-formed polype and its subsequent offsets. The *Medusa* of these polypes (fig. 663) belong to the division called 'naked-eyed,' on account of the eye-spots usually seen surrounding the margin of the bell at the base of the tentacles.

A characteristic example of this production of medusa-like 'gonozöoids' is presented by the form termed *Syucoryne Sarsii* (fig.

¹ A useful list of the principal terms used in describing hydroids, with definitions, will be found on pp. 16 and 17 of Professor Allman's *Report on the Hydroida (Plumulariida) of the Challenger*.

² *History of British Hydroid Zöophytes*, 1868.

661) belonging to the sub-order *Athecata*. At A is shown the alimentary zöoid, or polypite, with its tentacles, and at B the successive stages *a*, *b*, *c*, of the sexual zöoids, or medusa-buds. When sufficiently developed the Medusa swims away, and as it grows to maturity enlarges its manubrium, so that it hangs below the bell. The Medusæ of the genus *Syncoryne* (as now restricted) have the form named *Sarsia* in honour of the Swedish naturalist Sars. Their normal character is that of free swimmers; but Agassiz ascertained that in some cases towards the end of the breeding season the sexual zöoids remain fixed, and mature their products while attached to the zöophyte.¹ This latter condition of the sexual zöoids is very common amongst the Hydroids; and various intermediate stages may be traced in different genera between the mode in which the gonozöoids are produced in the common Hydra, as already described, and that of *Syncoryne*. In *Tabularia* the gonozöoids, though permanently attached, are furnished with swimming bells, having four tubercles representing marginal tentacles. A common and interesting species, *Tabularia indicisa*, receives its specific name from the infrequency with which branches are given off from the stems, these for the most part standing erect and parallel, like the stalks of corn, upon the base to which they are attached. This beautiful zöophyte, which sometimes grows between the tide-marks, but is more abundantly obtained by dredging in deep water, often attains a size which renders it scarcely a microscopic object, its stems being sometimes no less than a foot in height and a line in diameter. Several curious phenomena, however, are brought into view by microscopic examination. The polype-stomach is connected with the cavity of the stem by a circular opening, which is surrounded by a sphincter; and an alternate movement of dilatation and contraction takes place in it, fluid being apparently forced up from below, and then expelled again, after which the sphincter closes in preparation for

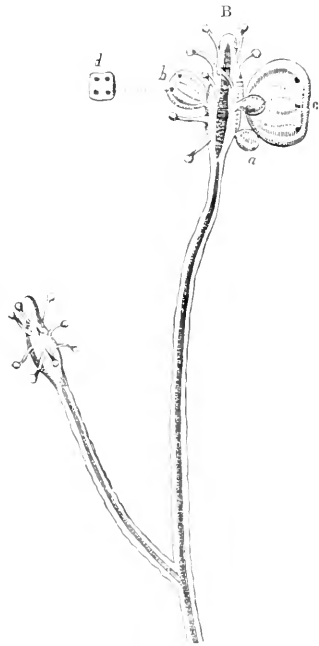

FIG. 661.—Development of Medusa-buds in *Syncoryne Sarsi*: A, an ordinary polype, with its club-shaped body covered with tentacles; B, a polype putting forth medusoid gemmæ: *a*, a very young bud; *b*, a bud more advanced, the quadrangular form of which, with the four nuclei whence the cirri afterwards spring, is shown at *d*; *c*, a bud still more advanced.

¹ Hincks, *op. cit.* p. 49.

a recurrence of the operation, this, as observed by Mr. Lister, being repeated at intervals of eighty seconds. Besides the foregoing movement, a regular flow of fluid, carrying with it solid particles of various sizes, may be observed along the whole length of the stem, passing in a somewhat spiral direction. It is worthy of mention here that when a *Tubularia* is kept in confinement the polype-heads almost always drop off after a few days, but are soon renewed by a new growth from the stem beneath; and this exuviation and regeneration may take place many times in the same individual.¹

It is in the families *Campanulariida* and *Sertulariida* (whose polyparies are commonly known as 'corallines') that the horny branching fabric attains its completest development, not only affording an investment to the stem, but forming cups or cells for the protection of the polypites, as well as capsules for the reproductive gonozoids. Both these families thus belong to the sub-order *Thecata*. In the *Campanulariida* the polype-cells are campanulate or bell-shaped, and are borne at the extremities of ringed stalks (fig. 659, *c*); in the *Sertulariida*, on the other hand, the polype-cells lie along the stem and branches, attached either to one side only, or to both sides (fig. 662). In both the general structure of the individual polypes (fig. 659, B, *d*) closely corresponds with that of the *Hydra*; and the mode in which they obtain their food is essentially the same. Of the products of digestion, however, a portion finds its way down into the tubular stem, for the nourishment of the general fabric; and very much the same kind of circulatory movement can be seen in *Campanularia* as in *Tubularia*, the circulation being most vigorous in the neighbourhood of growing parts. It is from the 'conosarc' (fig. 659, *f*) contained in the stem and branches that new polype-buds (*b*) are evolved; these carry before them (so to speak) a portion of the horny integument, which at first completely invests the bud; but as the latter acquires the organisation of a polype, the case thins away at its most prominent part, and an opening is formed through which the young polype protrudes itself.

The origin of the reproductive capsules or 'gonothecæ' (*e*) is exactly similar, but their destination is very different. Within them are evolved, by a budding process, the generative organs of the zöophyte; and these in the *Campanulariida* may either develop themselves into the form of independent medusoids, which completely detach themselves from the stock that bore them, make their way out of the capsule, and swim forth freely, to mature their sexual products (some developing sperm-cells, and others ova), and give origin to a new generation of polypes; or, in cases in which the medusoid structure is less distinctly pronounced, may not completely detach themselves, but (like the flower-buds of a plant) expand one after another at the mouth of the capsule, withering and dropping off after they have matured their generative products. In the *Sertulariida*, on the other hand, the medusan conformation is wanting, as the gonozoids are always fixed: the reproductive cells (fig. 662, *a*), which were shown by Professor Edward Forbes to be really meta-

¹ The British *Tubulariida* form the subject of a most complete and beautiful monograph by the late Professor Allman, published by the Ray Society.

morphosed branches, developing in their interior certain bodies which were formerly supposed to be ova, but which are now known to be 'medusoids' reduced to their most rudimentary condition. Within these are developed—in separate gonothecæ, sometimes perhaps on distinct polyparies—spermatozoa and ova; and the latter are fertilised by the entrance of the former whilst still contained within their capsules. The fertilised ova, whether produced in free or in attached medusoids, develop themselves in the first instance into ciliated 'gemmules,' or planulæ, which soon evolve themselves into true polypes, from every one of which a new composite polypary may spring.

There are few parts of our coast which will not supply some or other of the beautiful and interesting forms of zöo-phytic life which have been thus briefly noticed, without any more trouble in searching for them than that of examining the surfaces of rocks, stones, seaweeds, and dead shells between the tide-marks. Many of them habitually live in that situation; and others are frequently cast up by the waves from the deeper waters, especially after a storm. Many kinds, however, can only be obtained by means of the dredge. Of the remarkable forms dredged by the 'Challenger' mention can only be made here of the gigantic Tubularian—*Monocaulus*—the stem of which measured seven feet four inches, while there was a spread

of nine inches from tip to tip of the extended tentacles, and of the elegant *Streptocaulus pulcherrimus*, in which by the twisting of the stem the ultimate ramules are thrown into 'a graceful and beautiful spiral.' For observing them during their living state, no means is so convenient as the zöo-phyte-trough. In mounting compound Hydrozoa, as well as Polyzoa, it will be found of great advantage to place the specimens alive in the cells they are permanently to occupy, and to then add osmic acid drop by drop to the sea-water; this has the effect of causing the protrusion of the animals, and of rendering their tentacles rigid. The liquid may be withdrawn, and replaced by Goadby's solution, Deane's gelatine, glycerin jelly, weak spirit, diluted glycerin, a mixture of spirit and glycerin with sea-water, or any other menstruum, by means of

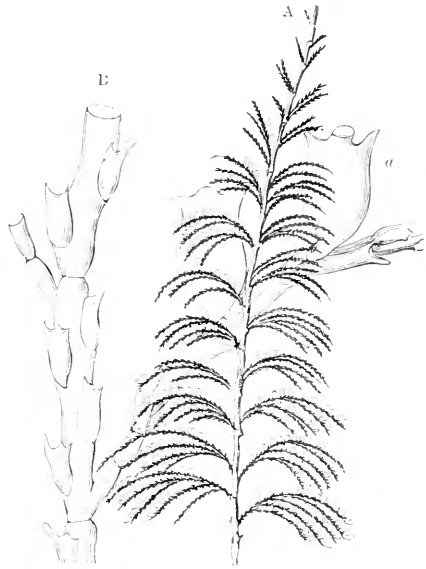

FIG. 662.—*Sertularia cupressina*: A, natural size; B, portion magnified.

the syringe; and it is well to mount specimens in several different menstrua, marking the nature and strength of each, as some forms are better preserved by one and some by another.¹ An excellent method of preservation has been discovered by M. Foettinger² in the use of chloral hydrate: when all the polypes in a vessel containing 100 c.c. of water are fully expanded some crystals of chloral hydrate are to be dropped into the vessel; these dissolve rapidly and gradually diffuse through the water. About ten minutes later a little more chloral should be added, and in three-quarters of an hour the whole colony will be found to have become insensible; the advantage of this method lies in the fact that the action is merely narcotic, and that the tissues are not affected. When the influence is so complete that irritation fails to produce retraction of the polypes the colony may be put into alcohol. The size of the cell must of course be proportioned to that of the object; and if it be desired to mount such a specimen as may serve for a characteristic illustration of the mode of growth of the species it represents, the large shallow cells, whose walls are made by cementing four strips of glass to the plate that forms the bottom, will generally be found preferable. The horny polyparies of the *Sertulariida*, when mounted in Canada balsam, are beautiful objects for the polariscope; but in order to prepare them successfully some nicety of management is required. The following are the outlines of the method recommended by Dr. Golding Bird, who very successfully practised it. The specimens selected, which should not exceed two inches in length, are first to be submitted, while immersed in water of 120°, to the vacuum of an air-pump. The ebullition which will take place within the cavities will have the effect of freeing the polyparies from dead polypes and other animal matter; and this cleansing process should be repeated several times. The specimens are then to be dried, by first draining them for a few seconds on bibulous paper, and then by submitting them to the vacuum of an air-pump, within a thick earthenware ointment-pot fitted with a cover, which has been previously heated to about 200°; by this means the specimens are very quickly and completely dried, the water being evaporated so quickly that the cells and tubes hardly collapse or wrinkle. The specimens are then placed in camphine, and again subjected to the exhausting process for the displacement of the air by that liquid; and when they have been thoroughly saturated, they should be mounted in Canada balsam in the usual mode. When thus prepared they become very beautiful transparent objects for low magnifying powers; and they present a gorgeous display of colours when examined by polarised light, with the interposition of a plate of selenite, the effect being much enhanced by the use of black-ground illumination.

No result of microscopic research was more unexpected than the discovery of the close relationship subsisting between the hydroid *Zöophytes* and the medusoid *Acalepha* (or 'jelly-fish'). We now know that the small free-swimming medusoids belonging to

¹ See Mr. J. W. Morris in *Quart. Journ. of Microsc. Sci.* n.s. vol. ii. 1862, p. 116.

² *Archives de Biologie*, vi. p. 115.

the 'naked-eye' group, of which *Thaumantias* (fig. 663) may be taken as a representative, are really to be considered as the detached sexual apparatus of the zöophytes from which they have been

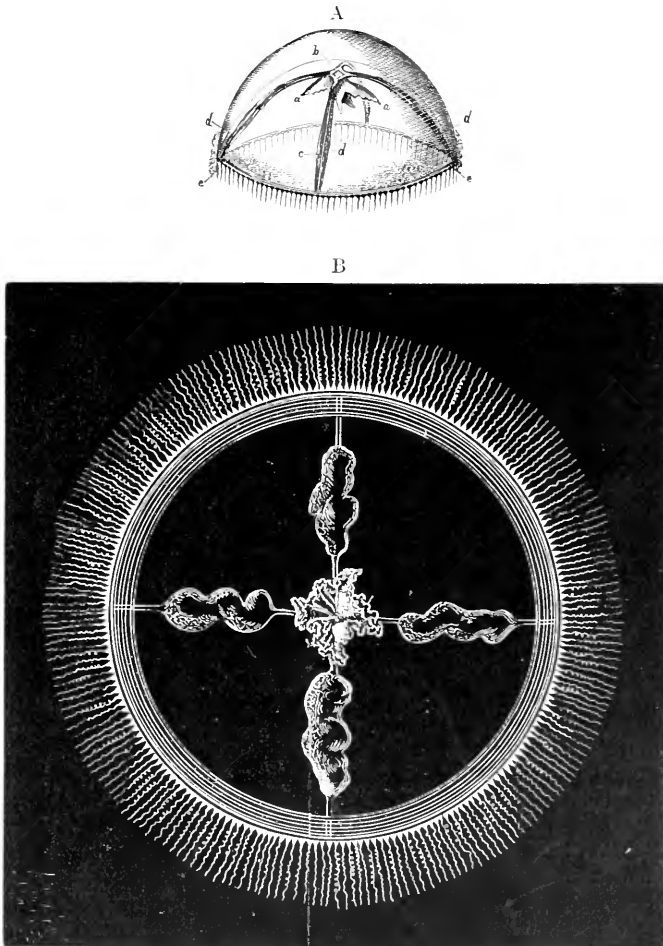

FIG. 663.—A, *Thaumantias pilosella*, one of the 'naked-eye' Medusæ: *a, a*, oral tentacles; *b*, stomach; *c*, gastro-vascular canals, having the ovaries, *d, d*, on either side, and terminating in the marginal canal, *e, e*. B, *Thaumantias Eschscholtzii*, Haeckel.

budded off, endowed with independent organs of nutrition and locomotion, whereby they become capable of maintaining their own existence and of developing their sexual products. The general conformation of these organs will be understood from the accompanying figure. Many of this group are very beautiful objects for

microscopic examination, being small enough to be viewed entire in the zöophyte-trough. There are few parts of the coast on which they may not be found, especially on a calm warm day, by skimming the surface of the sea with the tow-net; and they are capable of being stained and preserved in cells after being hardened by osmic acid.

The history of the large and highly developed *Medusa*¹ or ACALEPHE which are commonly known as 'jelly-fish' is essentially similar; for their progeny have been ascertained to develop themselves in the first instance under the polype form, and to lead a life which in all essential respects is zöophytic; their development into Medusæ taking place only in the closing phase of their existence, and then rather by gemmation from the original polype than by a metamorphosis of its own fabric. The huge *Rhizostoma* found commonly swimming round our coasts, and the beautiful *Chrysaora* remarkable for its long 'furbelows' which act as organs of prehension, are oceanic acalephs developed from very small polypites, which fix themselves by a basal cup or disc. The embryo emerges from the cavity of its parent, within which the first stages of its development have taken place, in the condition of a ciliated 'planula,' of rather oblong form, very closely resembling an infusory animalcule, but destitute of a mouth. One end soon contracts and attaches itself, however, so as to form a foot; the other enlarges and opens to form a mouth, four tubercles sprouting around it which grow into tentacles; whilst a slit in the midst of the central cells gives rise to the cavity of the stomach. Thus a hydra-like polype is formed, which soon acquires many additional tentacles; and this, according to the observations of Sir J. G. Dalyell on the *Hydra-tuba*, which is the polype stage of the *Chrysaora* and other jelly-fish, leads in every important particular the life of a Hydra; propagates like it by repeated gemmation, so that whole colonies are formed as offsets from a single stock; and can be multiplied like it by artificial division, each segment developing itself into a perfect Hydra. There seems to be no definite limit to its continuance in this state, or to its power of giving origin to new polype-buds; but when the time comes for the development of its sexual gonozöoids, the polype quits its original condition of a minute bell with slender tentacles (fig. 664), assumes a cylindrical form, and elongates itself considerably; a constriction or indentation is then seen around it, just below the ring which encircles the mouth and gives origin to the tentacles; and similar constrictions are soon repeated round the lower parts of the cylinder, so as to give to the whole body somewhat the appearance of a rouleau of coins; a sort of fleshy bulb, *a* (fig. 664. 11), somewhat of the form of the original polype, being still left at the attached extremity. The number of circles is indefinite, and all are not formed at once, new constrictions appearing below, after the upper portions have been detached; as many as thirty or even forty have thus been produced in one specimen. The constrictions then gradually deepen, so as to divide the cylinder into a pile of saucer-like bodies, the division being

¹ See Professor Claus, *Untersuchungen über die Organisation und Entwicklung der Medusen*, Prague and Leipzig, 1883, and Miss Ida H. Hyde, 'Entwicklungsgeschichte einiger Scyphomedusen,' in *Zeitschr. f. wiss. Zöol.* lviii. p. 531.

most complete above, and the upper discs usually presenting some increase in diameter; and whilst this is taking place the edges of the discs become divided into lobes, each lobe soon presenting the cleft with the supposed rudimentary eye at the bottom of it, which is to be plainly seen in the detached Meduse (fig. 665, C). Up to this period, the tentacles of the original polype surmount the highest of the discs; but before the detachment of the topmost disc, this circle disappears, and a new one is developed at the summit of the bulb which remains at the base of the pile. At last the topmost and largest disc begins to exhibit a sort of convulsive struggle; it

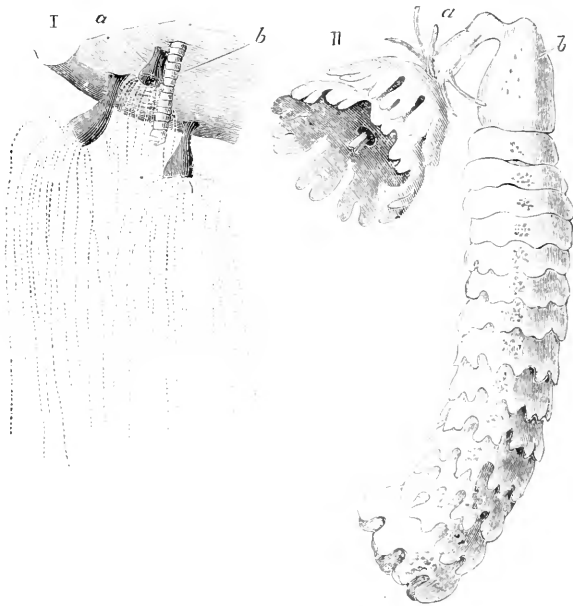

FIG. 664.—I, two *Hydra tube* (*Scyphistoma*-stage) of *Cyanea capillata*, with two *a*, *b* undergoing fission (*Strobila*-stage). II, *a* and *b* of fig. I three days later. In *a* the tentacles are developed beneath the lowest of the *Ephyrae*, from the stalk of the *Strobila*, which will persist as a *Hydra* tube. (After Van Beneden.)

becomes detached, and swims freely away; and the same series of changes takes place from above downwards, until the whole pile of discs is detached and converted into free-swimming Meduse. But the original polypoid body still remains, and may return to its original polype-like mode of gemmation, becoming the progenitor of a new colony, every member of which may in its turn bud off a pile of Medusa discs.

The bodies thus detached have all the essential characters of the adult *Medusa*. Each consists of an umbrella-like disc divided at its edge into a variable number of lobes, usually eight; and of a

stomach, which occupies a considerable proportion of the disc, and projects downwards in the form of a proboscis, in the centre of which is the quadrangular mouth (fig. 665, A, B). As the animal advances towards maturity the intervals between the segments of the border of the disc gradually fill up, so that the divisions are obliterated; tubular prolongations of the stomach extend themselves over the disc; and from its borders there sprout forth tendril-like filaments which hang down like a fringe around its margin. From the four angles of the mouth, which, even in the youngest detached animal, admits of being greatly extended and protruded, prolongations are put forth, which form the four large tentacles of the adult. The young Medusæ are very voracious, and grow rapidly, so as to attain

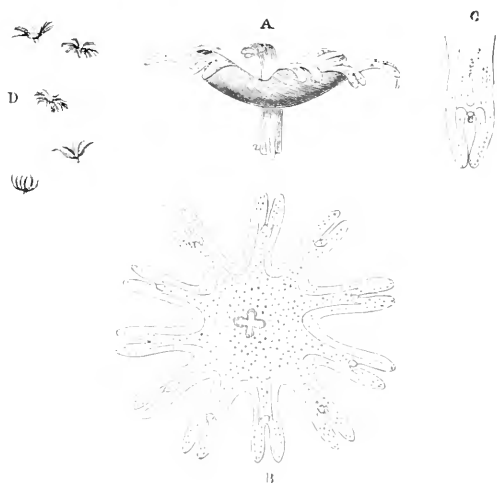

FIG. 665.—Development of *Chrysaora* from *Hydra tuba*: A, detached individual viewed sideways, and enlarged, showing the proboscis *a*, and *b* the bifid lobes; B, individual seen from above, showing the bifid lobes of the margin, and the quadrilateral mouth; C, one of the bifid lobes still more enlarged, showing the rudimentary eye (?) at the bottom of the cleft; D, group of young Medusæ, as seen swimming in the water, of the natural size.

a very large size. The *Cyanea* and *Chrysaora*, which are common all round our coasts, often have a diameter of from six to fifteen inches; while *Rhizostoma* sometimes reaches a diameter of from two to three feet. The quantity of solid matter, however, which their fabrics contain is extremely small. It is not until adult age has been attained that the generative organs make their appearance, in four chambers disposed around the stomach, which are occupied by plaited membranous ribbons containing sperm-cells in the male and ova in the female, and the embryos evolved from the latter, when they have been fertilised by the agency of the former, repeat the extraordinary cycle of phenomena which has been now described, developing themselves in the first instance into hydroid polypes, from which medusoids are subsequently budded off.

This cycle of phenomena is one of those to which the term 'alternation of generations' was applied by Steenstrup,¹ who brought together under this designation a number of cases in which generation A does not produce a form resembling itself, but a different form, B; whilst generation B gives origin to a form which does not resemble itself, but returns to the form A, from which B itself sprang. It was early pointed out, however, by the Author² that the term 'alternation of generations' does not appropriately represent the facts either of this case or of any of the other cases grouped under the same category, the real fact being that the two organisms, A and B, constitute two stages in the life-history of *one generation*, and the production of one form from the other being in only one instance by a truly *generative* or sexual act, whilst in the other it is by a process of *gemmation* or budding. Thus the *Medusa* of both orders (the 'naked-eyed' and the 'covered-eyed' of Forbes) are detached flower-buds, so to speak, of the hydroid zöophytes which bud them off, the zöophytic phase of life being the most conspicuous in such *Thecata* as *Campanulariida* and *Sertulariida*, whose *Medusa*-buds are of small size and simple conformation, and not unfrequently do not detach themselves as independent organisms; whilst the *Medusan* phase of life is the most conspicuous in the ordinary *Acalephs*, their zöophytic stage being passed in such obscurity as only to be detected by careful research. The Author's views on this subject, which were at first strongly contested by Professor E. Forbes and other eminent zöologists, have now come to be generally adopted.³

Actinozoa.—Of this group the common sea-anemones may be taken as types, constituting, with their allies, the order *Zoantharia*, or helianthoid polypes, which have numerous tentacles disposed in several rows. Next to them come the *Aleyonaria*, consisting of those whose polypes, having always eight broad short tentacles, present a star-like aspect when expanded; as is the case with various composite sponge-like bodies, unpossessed of any hard skeleton, which inhabit our own shores, and also with the red coral and the *Tubipora* of warmer seas, which have a stony skeleton that is internal in the first case and external in the second, as also with the sea pens and the *Gorgonia* or sea-fans. A third order, *Rugosa*, consists of fossil corals, whose stony polyparies are intermediate in character between those of the two preceding. And lastly, the *Ctenophora*, free-swimming gelatinous animals, many of which are beautiful objects for the microscope, are by some zöologists ranked with the Actinozoa.⁴

Of the *Zoantharia* the common *Actinia* or 'sea-anemone' may be taken as the type, the individual polypites of all the composite fabrics included in the group being constructed upon the same model.⁵ In by far the larger proportion of these zöophytes, the bases of the

¹ See his treatise on *The Alternation of Generations*, a translation of which has been published by the Ray Society.

² *Brit. and For. Med. Chir. Review*, vol. i. 1848, p. 192 *et seq.*

³ Compare Huxley, *Anatomy of Invertebrated Animals*, p. 133; and Balfour, *Comparative Embryology*, i. p. 151.

⁴ Professor Haeckel, led by the study of *Ctenaria ctenophora*, associates the *Ctenophora* with the *Hydrozoa* (*Sitzungsber. Jenaische Gesellschaft*, May 16, 1879).

⁵ On the anatomy of *Actinia* and its allies, see O. and R. Hertwig's monograph in vols. xiii. and xiv. of the *Jenaische Zeitschrift*.

polypites, as well as the soft flesh that connects together the members of aggregate masses, are consolidated by calcareous deposit into stony corals; and the surfaces of these are beset with 'cells,' usually of a nearly circular form, each having numerous vertical plates or *lamella* radiating from its centre towards its circumference, which are formed by the consolidation of the lower portions of the radiating partitions that divide the space intervening between the stomach and the general integument of the animal into separate chambers. This arrangement is seen on a large scale in the *Fungia* or 'mushroom-coral' of tropical seas, which is the stony base of a solitary anemone-like animal; on a far smaller scale, it is seen in the little *Caryophyllia*, a like solitary anemone of our own coasts, which is scarcely distinguishable from an Actinia by any other character than the presence of this disc, and also on the surface of many of those stony corals known as 'madrepores;' whilst in some of these the individual polype-cells are so small that the lamellated arrangement can only be made out when they are considerably magnified. Portions of the surface of such corals, or sections taken at a small depth, are very beautiful objects for low powers, the former being viewed by reflected and the latter by transmitted light. And thin sections of various fossil corals of this group are very striking objects for the lower powers of the oxy-hydrogen microscope. An exceedingly useful method of preparing sections of corals has been devised by Dr. G. von Koch; the corals with all their soft parts in place are hardened in absolute alcohol, and then placed in a solution of copal in chloroform. After thorough permeation they are taken out and dried slowly until the masses become quite hard. These masses may now be cut into sections with a fine saw and rubbed down on a whetstone in the ordinary manner; after staining, the sections may be mounted in Canada balsam. The great value of this method lies in the fact that by it the soft and hard parts are retained in their proper relations with each other.¹

The chief point of interest to the microscopist, however, in the structure of these animals lies in the extraordinary abundance and high development of those 'filiferous capsules,' or 'thread-cells,' the presence of which on the tentacles of the hydroid polypes has been already noticed, and which are also to be found, sometimes sparingly sometimes very abundantly, in the tentacles surrounding the mouth of the Medusæ, as well as on other parts of their bodies. If a tentacle of any of the sea-anemones so abundant on our coasts (the smaller and more transparent kinds being selected in preference) be cut off, and be subjected to gentle pressure between the two glasses of the aquatic box or the compressorium, multitudes of little dart-like organs will be seen to project themselves from its surface near its tip; and if the pressure be gradually augmented, many additional darts will every moment come into view. Not only do these organs present different forms in different species, but even in one and the same individual very strongly marked diversities are shown, of which a few examples are given in fig. 666. At A, B, C, D is shown the appearance of the 'filiferous capsules,' whilst as yet the

¹ See *Zöologischer Anzeiger*, i. p. 36; and *Proc. Zöol. Soc. London*, 1880, p. 24.

thread lies coiled up in their interior; and at E, F, G, H are seen a few of the most striking forms which they exhibit when the thread or dart has started forth. These thread-cells are found not merely in the tentacles and other parts of the external integument of Actinozoa, but also in the long filaments which lie in coils within the chambers that surround the stomach, in contact with the sexual organs which are attached to the lamellæ dividing the chambers. The latter sometimes contain 'sperm-cells' and sometimes ova, the two sexes being here divided, not united in the same individual. What can be the office of the filiferous filaments thus contained in the interior of the body it is difficult to guess at. They are often found to protrude from rents in the external tegument, when any violence has been used in detaching the animal from its base; and when there is no external rupture they are often forced through the wall of the stomach into its cavity, and may be seen hanging out of the mouth. The largest of these capsules, in their unprotected state, are about $\frac{3}{100}$ th of an inch in length: while the thread or dart, in *Corynactis Allmanni*, when fully extended is not less than $\frac{1}{8}$ th of an inch, or thirty-seven times the length of its capsule.¹

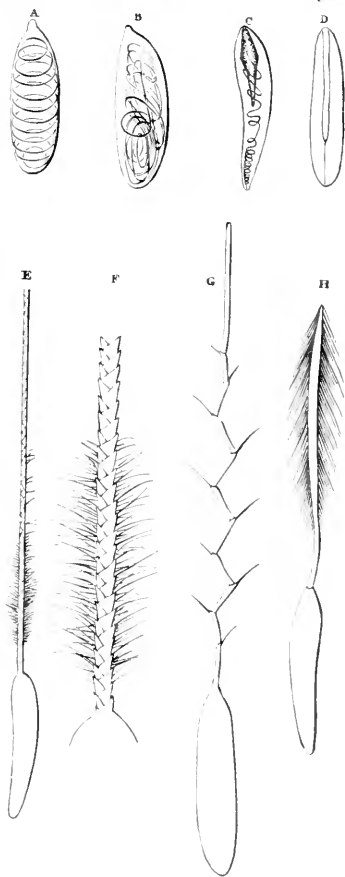

Of the *Alcyonaria* a characteristic example is found in the *Alcyonium digitatum* of our coasts: a lobed sponge-like mass, covered with a tough skin, which is commonly known under the name of 'dead-man's toes,' or by the more elegant name of 'mermaid's fingers.' When a specimen of this is first torn from the rock to which it has attached itself, it contracts into an unshapely mass, whose surface presents nothing

¹ See Mr. Gosse's *Naturalist's Rambles on the Devonshire Coast*, and Professor Milneus, 'Ueber den Bau u.s.w. der Nesselkapseln einiger Polypen und Quallen,' in *Abhandl. Naturw. Vereins zu Hamburg*, Band v. 1866. On the relations of stinging cells to the nervous system, see Dr. v. Lendenfeld, *Quart. Journ. of Microsc. Sci.* n.s. xxvii. p. 393. On the stinging cells of Coelentera generally, see N. Iwanzoff in *Bull. Soc. Moscou*, 1896, pp. 95 and 323.

but a series of slight depressions arranged with a certain regularity. But after being immersed for a little time in a jar of sea-water the mass swells out again, and from every one of these depressions an eight-armed polype is protruded, 'which resembles a flower of exquisite beauty and perfect symmetry. In specimens recently taken, each of the petal-like tentacula is seen with a hand-glass to be furnished with a row of delicately slender *pinnae* or filaments, fringing each margin, and arching onwards; and with a higher power these *pinnae* are seen to be roughened throughout their whole length with numerous prickly rings. After a day's captivity, however, the petals shrink up into short, thick, unshapely masses, rudely notched at their edges.' (Gosse.) When a mass of this sort is cut into it is found to be channelled out somewhat like a sponge by ramifying canals; the vents of which open into the stomachal cavities of the polypes, which are thus brought into free communication with each other, a character that especially distinguishes this order. A movement of fluid is kept up within these canals (as may be distinctly seen through



FIG. 667.—Spicules of *Alcyonium* and *Gorgonia*.



FIG. 668.—A, spicules of *Gorgonia guttata* B, spicules of *Muricea elongata*.

their transparent bodies) by means of cilia lining the internal surfaces of the polypes; but no cilia can be discerned on their external surfaces. The tissue of this spongy polypidom is strengthened throughout, like that of sponges, with mineral spicules (always, however, calcareous), which are remarkable for the elegance of their forms: these are disposed with great regularity around the bases of the polypes, and even extend part of their length upwards on their bodies. In the *Gorgonia* or sea-fan, whilst the central part of the polypidom is consolidated into a horny axis, the soft flesh which clothes this axis is so full of tuberculated spicules, especially in its outer layer, that, when this dries up, they form a thick yellowish or reddish incrustation upon the horny stem. This crust is, however, so friable that it may be easily rubbed down between the fingers, and when examined with the microscope it is found to consist of spicules of different shapes and sizes, more or less resembling those shown in figs. 667, 668, sometimes colourless, but sometimes of a beautiful crimson, yellow,

or purple. These spicules are best seen by black-ground illumination, especially when viewed by the binocular microscope. They are, of

course, to be separated from the animal substance in the same manner as the calcareous spicules of sponges; and they should be mounted, like them, in Canada balsam. The spicules always possess an organic basis, as is proved by the fact that when their lime is dissolved by dilute acid a gelatinous-looking residuum is left which preserves the form of the spicule.

The *Ctenophora*, or 'comb-bearers,' are so named from the comb-like arrangement of the rows of tiny



FIG. 669.—1. *Euplokamis stationis*, with its tentacles extended, about twice the natural size: *m*, mouth; *c*, ctenophoral plate; *t*, tentacular apparatus. (After Chun.)
2. Diagrammatic view of *Hormiphora plumosa*, seen from the aboral pole: *c*, as before; *tv*, tentacular vessel; *pp*, polar plates. (After Chun.)

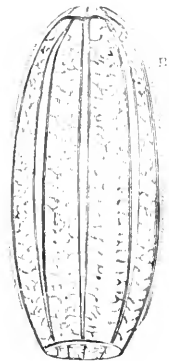

FIG. 670. *Beroë Forskalii*, showing the tubular prolongations of the stomach.

'paddles' by the movement of which the bodies of these animals are propelled. A very beautiful and not uncommon representative of

this order is furnished by the *Cydlippe*¹ *pileus* (compare fig. 669), very commonly known as the *Beroë*, which designation, however, properly appertains to another animal (fig. 670) of the same grade of organisation. The body of *Cydlippe* is a nearly globular mass of soft jelly, usually about $\frac{3}{8}$ ths of an inch in diameter, and it may be observed, even with the naked eye, to be marked by eight bright bands, which proceed from pole to pole like meridian lines. These bands are seen with the microscope to be formed of rows of flattened filaments, far larger than ordinary cilia, but lashing the water in the same manner; they sometimes act quite independently of one another, so as to give to the body every variety of motion, but sometimes work all together. If the sunlight should fall upon them when they are in activity, they display very beautiful iridescent colours. In addition to these 'paddles' the *Cydlippe* is furnished with a pair of long tendril-like filaments, rising from the bottom of a pair of cavities in the posterior part of the body, and furnished with lateral branches; within these cavities they may lie doubled up, so as not to be visible externally; and when they are ejected, which often happens quite suddenly, the main filaments first come forth, and the lateral tendrils subsequently uncoil themselves, to be drawn in again and packed up within the cavities with almost equal suddenness. The mouth of the animal situated at one of the poles leads first to a quadrifid cavity bounded by four folds which seem to represent the oral proboscis of the ordinary *Medusæ* (fig. 664); and this leads to the true stomach, which passes towards the opposite pole, near to which it bifurcates, its branches passing towards the polar surface on either side of a little body which has every appearance of being a nervous ganglion, and which is surmounted externally by a fringe-like apparatus that seems essentially to consist of sensory tentacles.² From the cavity of the stomach tubular prolongations pass off beneath the ciliated bands, very much as in the true *Beroë*. These may easily be injected with coloured liquids by the introduction of the extremity of a fine-pointed glass syringe into the mouth. The liveliness of this little creature, which may sometimes be collected in large quantities at once by the stick-net, renders it a most beautiful subject for observation when due scope is given to its movements; but for the sake of microscopic examination, it is of course necessary to confine these. Various species of true *Beroë*,³ some of them even attaining the size of a small lemon, are occasionally to be met with on our coasts, in all of which the movements of the

¹ More correctly *Horniphora*.

² It is commonly stated that the two branches of the alimentary canal open on the surface by two pores situated in the hollow of the fringe, one on either side of the nervous ganglion. The Author, however, has not been able to satisfy himself of the existence of such excretory pores in the ordinary *Cydlippe* or *Beroë*, although he has repeatedly injected their whole alimentary canal and its extensions, and has attentively watched the currents produced by ciliary action in the interior of the bifurcating prolongations, which currents always appear to him to return as from caecal extremities. He is himself inclined to believe that this arrangement has reference solely to the nutrition of the nervous ganglion and tentacular apparatus, which lies imbedded (so to speak) in the bifurcation of the alimentary canal, so as to be able to draw its supply of nutriment direct from that cavity.

³ On the anatomy of *Beroë*, see Eimer, *Zöologische Studien auf Capri*. I. Ueber *Beroë ovatus*, Leipzig, 1873.

body are effected by the like agency of paddles arranged in meridional bands. These are splendidly luminous in the dark, and the luminosity is retained even by fragments of their bodies, being augmented by agitation of the water containing them. All the *Ctenophora* are reproduced from eggs, and are already quite advanced in their development by the time they are hatched. Long before they escape, indeed, they swim about with great activity within the walls of their diminutive prison, their rows of locomotive paddles early attaining a large size, although the long flexile tentacles of *Cydlippe* are then only short stumpy protuberances. By *Caloplana* and *Ctenoplana* the *Ctenophora* appear to be allied to the Planarian Worms.¹

Those who may desire to acquire a more systematic and detailed acquaintance with the zoöphyte group may be especially referred to the following treatises and memoirs, in addition to those already cited, and to the various recent systematic treatises on zoölogy:—Dr. Johnston's *History of British Zoöphytes*; Professor Milne-Edwards's 'Recherches sur les Polypes,' and his 'Histoire des Corallaires' (in the *Suites à Buffon*), Paris, 1857; Professor Van Beneden, 'Sur les Tubulaires' and 'Sur les Campanulaires,' in *Mém. de l'Acad. Roy. de Bruxelles*, tom. xvii., and his 'Recherches sur l'Hist. Nat. des Polypes qui fréquentent les Côtes de Belgique,' *op. cit.* tom. xxxvi.; Sir J. G. Dalyell's *Rare and Remarkable Animals of Scotland*, vol. i.; Trembley's *Mém. pour servir à l'histoire d'un genre de Polype d'eau douce*; M. Hollar's 'Monographie du Genre *Actinia*' in *Ann. des Sci. Nat.* ser. iii. tom. xv.; Professor Max Schultze, 'On the Male Reproductive Organs of *Campanularia geniculata*' in *Quart. Journ. Micr. Sci.* vol. iii. 1855, p. 59; Professor F. E. Schulze's memoirs on *Cordylophora lacustris*, Leipzig, 1871, and on *Syncoryne*, 1873; Professor Agassiz's beautiful monograph on American Medusæ, forming the third volume of his *Contributions to the Natural History of the United States of America*; Mr. Hincks's *British Hydroid Zoöphytes*; Professor Allman's admirable memoirs on *Cordylophora* and *Myriothele* in the *Phil. Trans.* for 1853 and 1875; Professor Lacaze-Duthiers's *Hist. Nat. du Corail*, Paris, 1864, and his essays on the Development of Corals, in vols. i. and ii. of the *Archives de Zool. expérimentale*; Professor J. R. Greene's *Manual of the Sub-kingdom Coelenterata*, which contains a bibliography very complete to the date of its publication, and the articles 'Actinozoa,' 'Ctenophora,' and 'Hydrozoa' in the supplement to the Natural History Division of the *English Cyclopædia*. The *Ctenophora* are specially treated of in vol. iii. of Professor Agassiz's *Contributions to the Natural History of the United States*. See also Professor Alex. Agassiz's *Seaside Studies in Natural History* and his *Illustrated Catalogue of the Museum of Comparative Zoölogy at Harvard College*; Professor James Clark in *American Journal of Science*, ser. ii. vol. xxxv. p. 348; Dr. D. Macdonald in *Trans. Roy. Soc. Edinb.* vol. xxiii. p. 515; Mr. H. N. Moseley, 'On the Structure of a Species of *Millepora*,' in *Phil. Trans.* 1877, p. 117, and 'On the Structure of the *Stylasterida*,' *ibid.* 1878, p. 425; and on the *Acalepha*, Professor Haeckel's *Beiträge zur Naturgeschichte der Hydromedusen*: the masterly work of the brothers Hertwig, *Das Nervensystem und die Sinnesorgane der Medusen*, 1878; and the memoir of Professor Schäfer, 'On the Nervous System of *Aurelia aurita*,' in *Phil. Trans.* 1878, p. 563. Of later treatises Professor Ray Lankester's article on Hydrozoa, in the 9th edition of the *Encyclopædia Britannica*; the '*Challenger*' Reports of Professor Allman on the Hydroïda (Plumulariïdæ only), Professor Haeckel on the Medusæ, Professor Moseley on Deep-sea Corals, Dr. R. Hertwig on the Actiniaria, Professors E. P. Wright and Studer on the Aleyonaria, and Mr. George Brook on the Antipatharia; the monographs by Dr. A. Andres on Actinie and by Dr. C. Chun on Ctenophora, published in the *Fauna und Flora des Golfes von Neapel*, should be consulted. Dr. Chun has made some progress with a general account of the Coelentera in Brom's 'Thierreich,' Bd. ii. Abth. 2. On fresh-water Medusæ, see Mr. R. T. Günther in *Quart. Journ. Micr. Sci.* xxxvi. p. 284.

¹ See Korotneff, *Zeitschr. f. wiss. Zool.* xliii. p. 242, and Dr. A. Willey *Quart. Journ. Micr. Sci.* xxxix. p. 323.

CHAPTER XVI

ECHINODERMA

As we ascend the scale of animal life, we meet with such a rapid advance in complexity of structure that it is no longer possible to acquaint oneself with any organism by microscopic examination of it as a whole; and the dissection or analysis which becomes necessary, in order that each separate part may be studied in detail, belongs rather to the comparative anatomist than to the ordinary microscopist. This is especially the case with the *Echinus* (sea-urchin), *Asterias* (star-fish), and other members of the class Echinodermata, of whose complex organisation even a general account would be quite foreign to the purpose of this work. Yet there are certain parts of their structure which furnish microscopic objects of such beauty and interest that they cannot by any means be passed by; while the study of their embryonic forms, which can be prosecuted by any seaside observer, brings into view an order of facts of the highest scientific interest.

It is in the structure of that calcareous skeleton which exists under some form in nearly every member of this class that the ordinary microscopist finds most to interest him. This attains its highest development in the *Echinoidea*, in which it forms a box-like shell or 'test,' composed of numerous polygonal plates jointed to each other with great exactness, and beset on its external surface with 'spines,' which may have the form of prickles of no great length, or may be stout club-shaped bodies, or, again, may be very long and slender rods. The intimate structure of the shell is everywhere the same; for it is composed of a *network*, which consists of carbonate of lime with a very small quantity of animal matter as a basis, and which extends in every direction (i.e. in thickness as well as in length and breadth), its *areolæ* or interspaces freely communicating with each other (figs. 671, 672). These 'areolæ,' and the solid structure which surrounds them, may bear an extremely variable proportion one to the other; so that in two masses of equal size the one or the other may greatly predominate; and the texture may have either a remarkable lightness and porosity, if the network be a very open one, like that of fig. 671, or may possess a considerable degree of compactness, if the solid portion be strengthened. Generally speaking, the different layers of this network, which are connected together by pillars that pass from one to the other in a direction perpendicu-

lar to their plane, are so arranged that the perforations in one shall correspond to the intermediate solid structure in the next; and their transparence is such that when we are examining a section thin enough to contain only two or three such layers, it is easy, by properly focussing the microscope, to bring either one of them into distinct view. From this very simple but very beautiful arrangement, it comes to pass that the plates of which the entire 'test' is made up possess a very considerable degree of strength, notwithstanding that their porousness is such that if a portion of a fractured edge, or any other part from which the investing membrane has been removed, be laid upon fluid of almost any description, this will be rapidly sucked up into its substance. A very beautiful example of the same kind of calcareous skeleton, having a more regular conformation, is furnished by the disc or 'rosette' which is contained in the tip of every one of the tubular suckers put forth by the living Echinus from the 'ambulacral pores' that are seen in the rows of

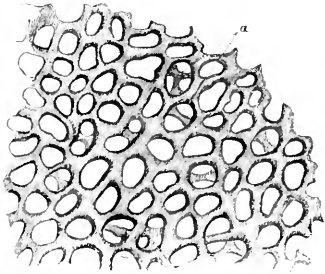

FIG. 671.—Section of shell of *Echinus* showing the calcareous network of which it is composed: *a a*, portions of a deeper layer.

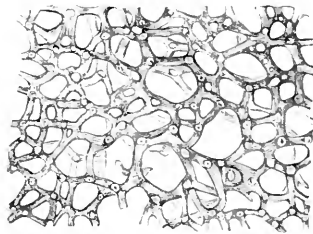

FIG. 672.—Transverse section of central portion of spine of *Heterocentrotus*, showing its more open network.

smaller plates interposed between the larger spine-bearing plates of its box-like shell. If the entire disc be cut off, and be mounted when dry in Canada balsam, the calcareous rosette may be seen sufficiently well; but its beautiful structure is better made out when the animal membrane that incloses it has been got rid of by boiling in a solution of caustic potass; and the appearance of one of the five segments of which it is composed, when thus prepared, is shown in fig. 674.

The most beautiful display of this reticulated structure, however, is shown in the conformation of the 'spines' of *Echinus*, *Cidaris*, &c., in which it is combined with solid ribs or pillars, disposed in such a manner as to increase the strength of these organs, a regular and elaborate pattern being formed by their intermixture, which shows considerable variety in different species. When we make a thin transverse section of almost any spine belonging to the genus *Echinus* (the small spines of our British species, however, being exceptional in this respect) or its immediate allies, we see it to be

made up of a number of concentric layers, arranged in a manner that strongly reminds us of the concentric rings of an exogenous tree

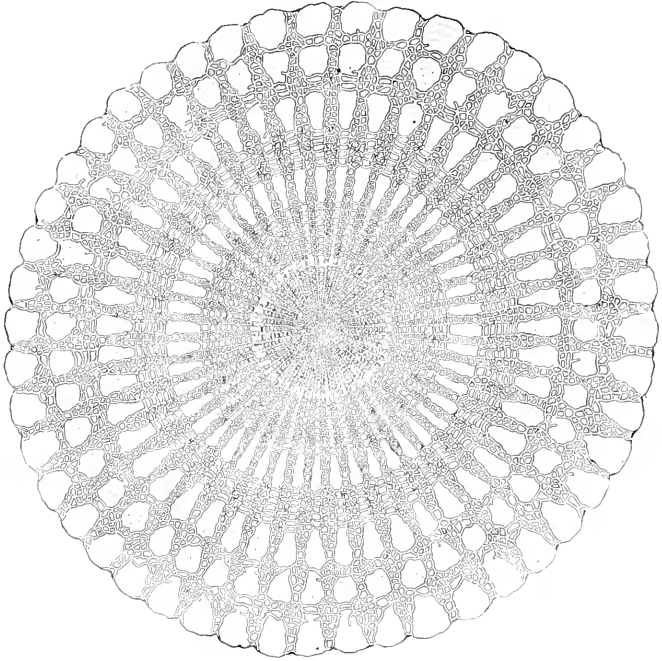

FIG. 673.—Transverse section of spine of *Echinometra*.

(fig. 673). The number of these layers is extremely variable, depending not merely upon the age of the spine, but (as will presently

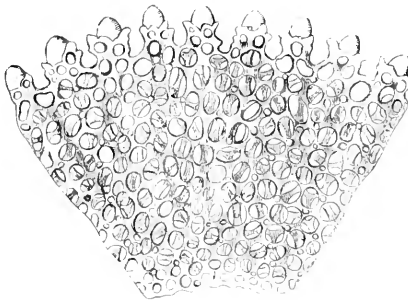

FIG. 674.—One of the segments of the calcareous skeleton of an ambulacral disc of *Echinus*.

appear) upon the part of its length from which the section happens to be taken. The centre is usually occupied by a very open network (fig. 672): and this is bounded by a row of transparent spaces (like those at *a a'*, *b b'*, *c c'*, &c., fig. 675), which on a cursory inspection might be supposed to be void, but are found on closer examination to be the sections of solid ribs or pillars, which run in the direction of the length of the spine, and form the exterior of every layer. Their solidity becomes very obvious when we

either examine a section of a spine whose substance is pervaded (as often happens) with a colouring matter of some depth, or when we look at a very thin section by black-ground illumination. Around the innermost circle of these solid pillars there is another layer of the calcareous network, which again is surrounded by another circle of solid pillars; and this arrangement may be repeated many times, as shown in fig. 675, the outermost row of pillars forming the projecting ribs that are commonly to be distinguished on the surface of the spine. Around the cup-shaped base of the spine is a membrane which is continuous with that covering the surface of the shell, and serves not merely to hold down the cup upon the tubercle over which it works, but also by its contractility to move the spine in any required direction. The increase in size of the spine appears to be due to the protoplasmic substance which fills up the spaces in the open network of the spine and other skeletal structures. Each new formation completely ensheathes the old, not merely surrounding the part previously formed, but also projecting considerably beyond it; and thus it happens that the number of layers shown in a transverse section

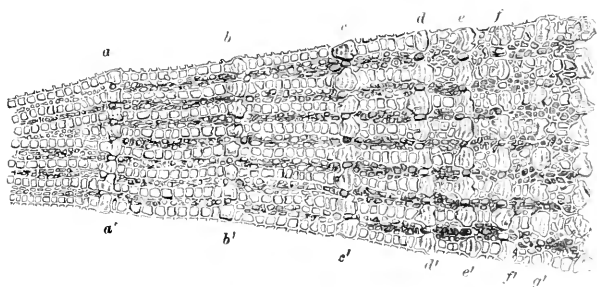

FIG. 675.—Portion of transverse section of spine of *Heterocentrotus mammillatus*.

will depend in part upon the place of that section. For if it cross near the base, it will traverse every one of the successive layers from the very commencement; whilst if it cross near the apex, it will traverse only the single layer of the last growth, notwithstanding that, in the club-shaped spines, this terminal portion may be of considerably larger diameter than the basal; and in any intermediate part of the spine, so many layers will be traversed as have been formed since the spine first attained that length. The basal portion of the spine is enveloped in a reticulation of a very close texture without concentric layers, forming the cup or socket which works over the tubercle of the shell.

Their combination of elegance of pattern with richness of colouring renders well-prepared specimens of these spines among the most beautiful objects that the microscopist can anywhere meet with. The large spines of the various species of the genus *Heterocentrotus* furnish sections most remarkable for size and elaborateness, as well as for depth of colour (in which last point, however, the deep purple spines of *Echinus lividus* are pre-eminent); but for exquisite

neatness of pattern there are no spines that can approach those of *Echinometra* (fig. 673). The spines of *Stomopneustes variolaris* are also remarkable for their beauty. No succession of concentric layers is seen in the spines of the British *Echini*, probably because (according to the opinion of the late Sir J. G. Dalzell) these spines are cast off and renewed every year, each new formation thus going to make an entire spine, instead of making an addition to that previously existing. Most curious indications are sometimes afforded by sections of Echinus-spines of an extraordinary power of reparation inherent in these bodies. For irregularities are often seen in the transverse sections which can be accounted for in no other way than by supposing the spines to have received an injury when the irregular part was at the exterior, and to have had its loss of substance supplied by the growth of new

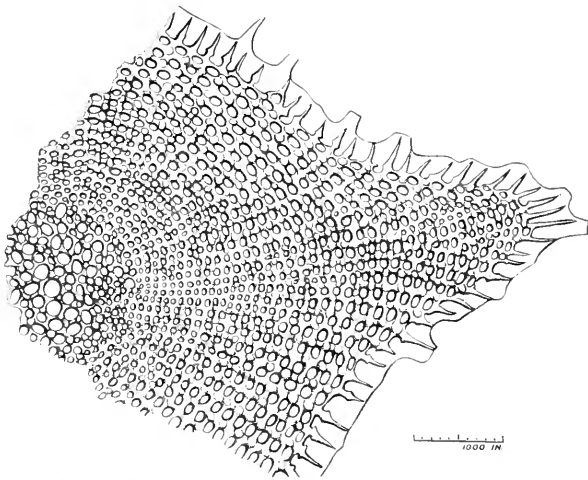

FIG. 676.—Transverse section of a spine of *Goniocidaris florigera*, which shows that the prickles on the spine are formed, not by the crust only, but also by the inner reticular tissue. (From Bell.)

tissue, over which the subsequent layers have been formed as usual. And sometimes a peculiar ring may be seen upon the surface of a spine, which indicates the place of a complete fracture, all beyond it being a new growth, whose unconformableness to the older or basal portion is clearly shown by a longitudinal section.¹ The spines of *Cidaris* present a marked departure from the plan of structure exhibited in *Echinus*; for not only are they destitute of concentric layers, but the calcareous network which forms their principal substance is incased in a solid calcareous sheath perforated with tubules, which seems to take the place of the separate pillars of the *Echini*. This is usually found to close in the spine at its tip also:

¹ See the Author's description of such reparations in the *Monthly Microscopical Journal*, vol. iii. 1870, p. 225.

and thus it would appear that the entire spine must be formed at once, since no addition could be made either to its length or to its diameter, save on the outside of the sheath, where it is never to be found. The sheath itself often rises up in prominent points or ridges on the surface of these spines; but, as is shown in fig. 676, the reticular portion may have a share in the formation of the rings. This view of the mode of formation of the Cidarid spine is contested by Professor Jeffrey Bell, who has brought forward¹ evidence to show that if two spines of different sizes be taken from two examples of *Cidarid metularia*, also differing in size, the quantity of solid calcareous sheath seen in transverse section is proportionately less in the larger than in the smaller spine; from this he concludes that the growth is due to the internal reticulated portion rather than to the outer crust. The slender, almost filamentary spines

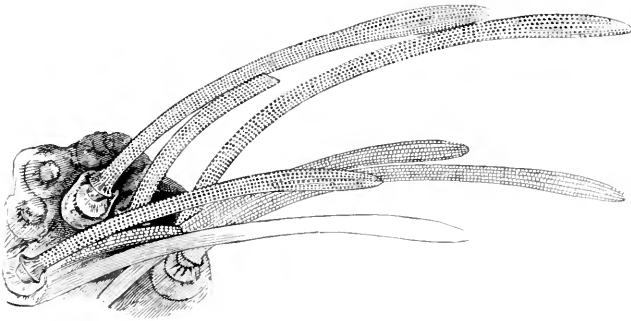

FIG. 677.—Spine of *Spatangus*.

of *Spatangus* (fig. 677) and the innumerable minute hair-like processes attached to the shell of *Clypeaster* are composed of the like regularly reticulated substance;² and these are very beautiful objects for the lower powers of the microscope, when laid upon a black ground and examined by reflected light without any further preparation. It is interesting also to find that the same structure presents itself in the curious *Pedicellariæ* (forceps-like bodies often mounted on long stalks), which are found on the surface of many Echinida and Asterida, and the nature of which was formerly a source of much perplexity to naturalists, some having maintained that they were parasites, whilst others considered them as proper appendages of the Echinus itself. The complete conformity which exists between the structure of their skeleton and that of the animal to which they are attached removes all doubt of their being truly appendages to it, as observation of their actions in the living state would indicate.³

¹ *Journ. Roy. Microsc. Soc.* 1884, p. 845.

² A number of rare spines are described and figured by Prof. H. W. Mackintosh in vols. xxvi. (p. 475) and xxviii. (pp. 241 and 259) of the *Trans. Roy. Irish Academy*.

³ Prof. Alex. Agassiz has shown the relations of the *Pedicellariæ* to the spines. Much information regarding the various forms of these curious bodies will be found in Professor Perrier's memoir in the *Ann. Sc. Nat.* (5), vols. xii. and xiii.; Mr Sladen's

Another example of the same structure is found in the peculiar framework of plates which surrounds the interior of the oral orifice of the shell, and which includes the five *teeth* that may often be seen projecting externally through that orifice, the whole forming what is known as the 'lantern of Aristotle.' The texture of the plates or jaws resembles that of the shell in every respect, save that the network is more open; but that of the teeth differs from it so widely as to have been likened to that of the bone and dentine of vertebrate animals. The careful investigations of Mr. James Salter,¹ however, have fully demonstrated that the appearances which have suggested this comparison are to be otherwise explained, the plan of structure of the *tooth* being essentially the same as that of the *shell*, although greatly modified in its working out. The complete tooth has some-

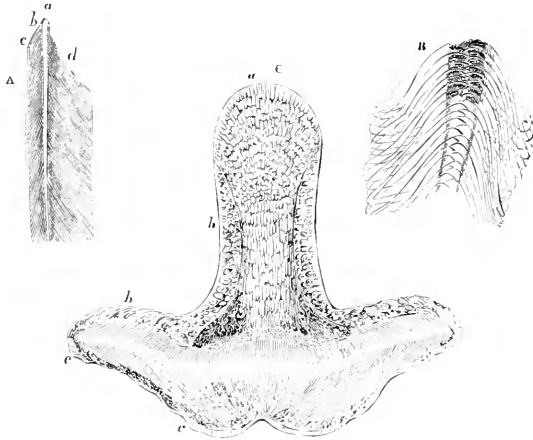

FIG. 678. —Structure of the tooth of *Echinus*: A, vertical section, showing the form of the apex of the tooth as produced by wear, and retained by the relative hardness of its elementary parts; *a*, the clear condensed axis; *b*, the body formed of plates; *c*, the so-called enamel; *d*, the keel. B, commencing growth of the tooth, as seen at its base, showing its two systems of plates; the dark appearance in the central portion of the upper part is produced by the incipient reticulations of the flabelliform processes. C, transverse section of the tooth, showing at *a* the ridge of the keel; at *b* its lateral portion, resembling the shell in texture; at *c*, the enamel.

what the form of that of the front tooth of a rodent, save that its concave side is strengthened by a projecting 'keel,' so that a transverse section of the tooth presents the form of a **L**. This keel is composed of cylindrical rods of carbonate of lime, having club-shaped extremities lying obliquely to the axis of the tooth (fig. 678, A, *d*); these rods do not adhere very firmly together, so that it is difficult to keep them in their places in making sections of the part. The

essay in *Ann. and Mag. Nat. Hist.* (5), vi, p. 101; and M. Foettinger's paper in vol. ii, p. 455 of the *Archives de Biologie*.

¹ See his memoir, 'On the Structure and Growth of the Tooth of *Echinus*,' in *Phil. Trans.* for 1861, p. 387. See also Giesbrecht, 'Der feinere Bau der Seeigelzähne,' *Morph. Jahrbuch*, vi, p. 79.

convex surface of the tooth (*c, c, c*) is covered with a firmer layer, which has received the name of 'enamel.' This is composed of shorter rods, also obliquely arranged, but having a much more intimate mutual adhesion than we find among the rods of the keel. The principal part of the substance of the tooth (*A, b*) is made up of what may be called the 'primary plates.' These are triangular plates of calcareous shell-substance, arranged in two series (as shown at *B*), and constituting a sort of framework with which the other parts to be presently described become connected. These plates may be seen by examining the growing base of an adult tooth that has been preserved with its attached soft parts in alcohol, or (which is preferable) by examining the base of the tooth of a fresh specimen, the minuter the better. The lengthening of a tooth below, as it is worn away above, is mainly effected by the successive addition of new 'primary plates.' To the outer edge of the primary plates at some little distance from the base we find attached a set of lappet-like appendages, which are formed of similar plates of calcareous shell-substance, and are denominated by Mr. Salter 'secondary plates.' Another set of appendages termed 'flabelliform processes' is added at some little distance from the growing base; these consist of elaborate reticulations of calcareous fibres, ending in fan-shaped extremities. And at a point still further from the base we find the different components of the tooth connected together by 'soldering particles,' which are minute calcareous discs interposed between the previously formed structures; and it is by the increased development of this connective substance that the intervening spaces are narrowed into the semblance of tubuli like those of bone or dentine. Thus a vertical section of the tooth comes to present an appearance very like that of the *bone* of a vertebrate animal, with its lacunae, canaliculi, and lamella; but in a transverse section the body of the tooth bears a stronger resemblance to *dentine*; whilst the keel and enamel layer more resemble an oblique section of *Pisna* than any other form of shell-structure.

The calcareous plates which form the less compact skeletons of the *Asteroidea* ('star-fish' and their allies) and of the *Ophiuroidea* ('sand-stars' and 'brittle stars') have the same texture as those of the shell of *Echinus*. And this presents itself, too, in the spines or prickles of their surface when these (as in the great *Goniaster equestris* or 'knotty cushion-star') are large enough to be furnished with a calcareous framework. An example of this kind, furnished by the *Astrophyton*, is represented in fig. 679. The spines with which the arms of the species of *Ophiothrix* ('brittle star') are beset are often remarkable for their beauty of conformation; those of *O. pentaphyllum*, one of the most common kinds, might serve (as Professor E. Forbes justly remarked), in point of lightness and beauty, as



FIG. 679.—Calcareous plate and claw of *Astrophyton*.

models for the spire of a cathedral. These are seen to the greatest advantage when mounted in Canada balsam, and viewed by the binocular microscope with black-ground illumination. It is interesting to remark that the minute tooth of *Ophiothrix* clearly exhibits, with scarcely any preparation, that gradational transition between the ordinary reticular structure of the shell and the peculiar substance of the tooth which in the adult tooth of the *Echinus* can only be traced by making sections of it near its base. The tooth of *Ophiothrix* may be mounted in balsam as a transparent object with scarcely any grinding down; and it is then seen that the basal portion of the tooth is formed upon the open reticular plan characteristic of the shell, whilst this is so modified in the older portion by subsequent addition that the upper part of the tooth has a bone-like character.

The calcareous skeleton is very highly developed in the *Crinoidea*, their stems and branches being made up of a calcareous network closely resembling that of the shell of the *Echinus*. This is extremely well seen, not only in the recent *Pentacrinus asterius*, a somewhat rare animal of the West Indian seas, but also in a large proportion of the fossil crinoids, whose remains are so abundant in many of the older geological formations; for, notwithstanding that these bodies have been penetrated in the act of fossilisation by a mineral infiltration, which seems to have substituted itself for the original fabric (a regularly crystalline cleavage being commonly found to exist in the fossil stems of *Enerinites*, &c., as in the fossil spines of *Echinida*), yet their organic structure is often most perfectly preserved.¹ In the circular stems of *Enerinites* the texture of the calcareous network is uniform, or nearly so, throughout; but in the pentangular *Pentacrinus* a certain figure or pattern is formed by variations of texture in different parts of the transverse section.²

The minute structure of the shells, spines, and other solid parts of the skeleton of Echinoderma can only be displayed by thin sections made upon the general plan already described in Chapter VII. But their peculiar texture requires that certain precautions should be taken: in the first place, in order to prevent the section from breaking whilst being reduced to the desirable thickness; and in the second, to prevent the interspaces of the network from being clogged by the particles abraded in the reducing process. An illustration of a section cut from a spine of *Echinometra* is given in fig. 673. A section of the shell, spine, or other portion of the skeleton should first be cut with a fine saw, and be rubbed on a flat file until it is about as thin as ordinary card, after which it should be smoothed on one side by friction with water on a Water-of-Ayr

¹ The calcareous skeleton even of living Echinoderms has a crystalline aggregation, as is very obvious in the more solid spines of *Echinometra*, &c.; for it is difficult, in sawing these across, to avoid their tendency to *cleavage* in the oblique plane of calcite. And the Author is informed by Mr. Sorby that the calcareous deposit which fills up the areole of the fossilised skeleton has always the same crystalline system with the skeleton itself, as is shown not merely by the uniformity of their cleavage, but by their similar action on polarised light.

² See figs. 74-76 of the Author's memoir on 'Shell Structure' in the *Report of the British Association*, 1847.

stone. It should then, after careful washing, be dried, first on white blotting-paper, afterwards by exposure for some time to a gentle heat, so that no water may be retained in the interstices of the network which would oppose the complete penetration of the Canada balsam. Next, it is to be attached to a glass slip by balsam hardened in the usual manner; but particular care should be taken, first, that the balsam be brought to exactly the right degree of hardness, and second, that there be enough not merely to attach the specimen to the glass, but also to saturate its substance throughout. The right degree of hardness is that at which the balsam can be with difficulty indented by the thumb-nail; if it be made harder than this, it is apt to chip off the glass in grinding, so that the specimen also breaks away; and if it be softer, it holds the abraded particles, so that the openings of the network become clogged with them. If, when rubbed down nearly to the required thinness, the section appears to be uniform and satisfactory throughout, the reduction may be completed without displacing it; but if (as often happens) some inequality in thickness should be observable, or some minute air-bubbles should show themselves between the glass and the under surface, it is desirable to loosen the specimen by the application of just enough heat to melt the balsam (special care being taken to avoid the production of fresh air-bubbles) and to turn it over so as to attach the side last polished to the glass, taking care to remove or to break with the needle point any air-bubbles that there may be in the balsam covering the part of the glass on which it is laid. The surface now brought uppermost is then to be very carefully ground down, special care being taken to keep its thickness uniform through every part (which may be even better judged of by the touch than by the eye), and to carry the reducing process far enough, without carrying it too far. Until practice shall have enabled the operator to judge of this by passing his finger over the specimen, he must have continual recourse to the microscope during the latter stages of his work; and he should bear constantly in mind that, as the specimen will become much more translucent when mounted in balsam and covered with glass than it is when the ground surface is exposed, he need not carry his reducing process so far as to produce at once the entire translucence he aims at, the attempt to accomplish which would involve the risk of the destruction of the specimen. In mounting the specimen liquid balsam should be employed, and only a very gentle heat (not sufficient to produce air-bubbles or to loosen the specimen from the glass) should be applied; and if, after it has been mounted, the section should be found too thick, it will be easy to remove the glass cover and to reduce it further, care being taken to harden to the proper degree the balsam which has been newly laid on.

If a number of sections are to be prepared at once (which it is often useful to do for the sake of economy of time, or in order to compare sections taken from different parts of the same spine), this may be most readily accomplished by laying them down, when cut off by the saw, without any preliminary preparation save the blowing of the calcareous dust from their surfaces, upon a thick slip of

glass well covered with hardened balsam; a large proportion of its surface may thus be occupied by the sections attached to it, the chief precaution required being that all the sections come into equally close contact with it. Their surfaces may then be brought to an exact level by rubbing them down, first upon a flat piece of grit (which is very suitable for the rough grinding of such sections) and then upon a large Water-of-Ayr stone whose surface is 'true.' When this level has been attained the ground surface is to be well washed and dried, and some balsam previously hardened is to be spread over it, so as to be sucked in by the sections, a moderate heat being at the same time applied to the glass slide; and when this has been increased sufficiently to loosen the sections without overheating the balsam, the sections are to be turned over, one by one, so that the *ground* surfaces are now to be attached to the glass slip, special care being taken to press them all into close contact with it. They are then to be very carefully rubbed down, until they are nearly reduced to the required thinness; and if, on examining them from time to time, their thinness should be found to be uniform throughout, the reduction of the entire set may be completed at once; and when it has been carried sufficiently far, the sections, loosened by warmth, are to be taken up on a camel-hair brush dipped in turpentine and transferred to separate slips of glass whereon some liquid balsam has been previously laid, in which they are to be mounted in the usual manner. It more frequently happens, however, that, notwithstanding every care, the sections, when ground in a number together, are not of uniform thickness, owing to some of them being underlain by a thicker stratum of balsam than others; and it is then necessary to transfer them to separate slips before the reducing process is completed, attaching them with hardened balsam, and finishing each section separately.

A very curious *internal* skeleton, formed of detached plates or spicules, is found in many members of this class, often forming an investment like a coat of mail to some of the viscera, especially the ovaries. The forms of these plates and spicules are generally so diverse, even in closely allied species, as to afford very good differential characters. This subject is one that has been as yet but very little studied, Mr. Stewart being the only microscopist who has given much attention to it,¹ but it is well worthy of much more extended research.

It now remains for us to notice the curious and often very beautiful structures which represent, in the class *Holothurioidea*, the solid calcareous skeleton of the classes already noticed. The greater number of the animals belonging to this order are distinguished by the flexibility and absence of firmness of their envelopes; and excepting in the case of the various species which have a set of calcareous plates, disposed around the wall of the pharynx, we do not find among them any representation, that is apparent to the unassisted eye, of that skeleton which constitutes so distinctive a feature of the

¹ See his memoir in the *Linnean Transactions*, xxv. p. 365; see also Bell, *Journ. Roy. Microsc. Soc.* 1882, p. 227.

class generally.¹ But a microscopic examination of their integument at once brings to view the existence of great numbers of minute isolated plates, every one of them presenting the characteristic reticulated structure, which are set with greater or less closeness in

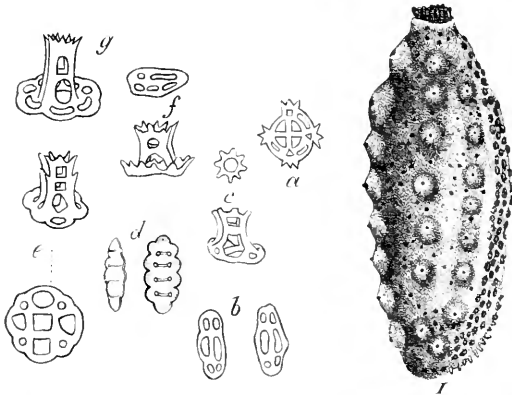

FIG. 680.—Holothurioidea: I, *Stichopus Keferstemii*; a, calcareous plate of same; b, c, calcareous plates of *Holothuria vagabunda*; d, the same of *H. inhabilis*; e, the same of *H. botellus*; f, of *H. pardalis*; g, of *H. edulis*.

the substance of the skin. Various forms of the plates which thus present themselves in *Holothuria* are shown in fig. 680.² In the *Synapta*, one of the long-bodied forms of this order, which abounds in the Mediterranean Sea, and of which two species (the *S. digitata*

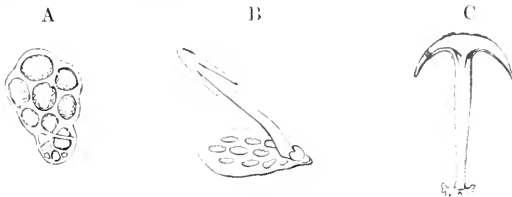

FIG. 681.—Calcareous skeleton of *Synapta*: A, plate imbedded in skin; B, the same, with its anchor-like spine attached; C, anchor-like spine separated.

and *S. inlucens*) occasionally occur upon our own coasts,³ the calcareous plates of the integument have the regular form shown at A, fig. 681; and each of these carries the curious anchor-like appendage, C, which is articulated to it by the notched piece at the foot, in the

¹ For an account of a very remarkable form see Moseley 'On the Pharynx of an unknown Holothurian, of the family Dendrochirotae, in which the calcareous skeleton is remarkably developed,' *Quart. Journ. Microsc. Sci.* n.s. xxiv. p. 255.

² For figures of the spicules of British Holothurians, see Bell, *Catalogue of the British Echinoderms*, London, 1892, pls. i.-vi.

³ 'On the spicules of *Synapta*, together with some general remarks on the architecture of Echinoderm spicules,' consult R. Semon, *Mitth. Zool. Stat. Neapel*, vii. p. 272. An excellent summary of our knowledge of the spicules of Holothurians is given by Prof. Ludwig in his volume in Bronn's *Thierreich*, pp. 35-61.

manner shown (in side view) at B. The anchor-like appendages project from the surface of the skin, and may be considered as representing the spines of Echinida. Nearly allied to the Synapta is the *Chiridota*, the integument of which is entirely destitute of 'anchors,' but is furnished with very remarkable wheel-like plates; those represented in fig. 682 are found in the skin of *Chiridota violacea*, a species inhabiting the western parts of the Indian Ocean. These 'wheels' are objects of singular beauty and delicacy, being especially remarkable for the very minute notching (scarcely to be discerned in the figure without the aid of a magnifying glass) which is traceable round the inner margin of their 'tires.' There can be scarcely any reasonable doubt that almost every member of this class has some kind of calcareous skeleton disposed in a manner conformable to the examples now cited; and it is now generally acknowledged that the marked peculiarities by which they are respectively distinguished are most useful in the determination of genera and species.¹ The plates may be obtained separately by the usual



FIG. 682.—Wheel-like plates from skin of *Chiridota violacea*

method of treating the skin with a solution of potass, and they should be mounted in Canada balsam. But their position in the skin can only be ascertained by making sections of the integument both vertical and parallel to its surface; and these sections, when dry, are most advantageously mounted in the same medium, by which

their transparence is greatly increased. All the objects of this class are most beautifully displayed by the black-ground illumination, and their solid forms are seen with increased effect under the binocular. The black-ground illumination applied to *very thin* sections of Echinus spines brings out some effects of marvellous beauty; and even in these the solid form of the network connecting the pillars is better seen with the binocular than it can be with the ordinary microscope.²

Echinoderm Larvæ.—We have now to notice that most remarkable set of objects furnished to the microscopic inquirer by the *larval* states of this class; for our first knowledge of which we were indebted to the painstaking and widely extended investigations of Professor J. Müller.³ All that our limits permit is a notice of two of the most curious forms of these larvæ by way of sample of the won-

¹ No systematic account of a species of Holothurian can be regarded as complete which does not contain an account of the form of its spicules, when these are present. Figures of various forms will be found in Professor Semper's *Reisen im Archipel der Philippinen: Holothurien*, Dr. Théel's '*Challenger*' Reports, and the memoirs of Professors Bell, Ludwig, and Selenka.

² It may be here pointed out that the reticulated appearance is sometimes deceptive, what seems to be *solid* network being in many instances a *hollow* network of passages channelled out in a solid calcareous substance. Between these two conditions, in which the relation between the solid framework and the intervening space is completely reversed, there is every intermediate gradation.

³ Of later works consult especially the 'Selections from Embryological Monographs, ii. Echinodermata,' edited by Mr. A. Agassiz, in vol. ix. of the *Memoirs of the Museum of Comparative Zoölog.*

derful phenomena which his researches brought to light, and to which the attention of microscopists who have the opportunity of studying them should be the more assiduously directed, as even the most delicate of these organisms have been found capable of such perfect preservation as to admit of being studied, when mounted as preparations, even better than when alive. The larval zöoids have, by secondary adaptations to their mode of life, acquired a type quite different from that which characterises the adults; for instead of a *radial* symmetry they exhibit a *bilateral*, the two sides being precisely alike, and each having a ciliated fringe along the greater part or the whole of its length. The two fringes are united by a superior and an inferior transverse ciliated band, and between these two the mouth of the zöoid is always situated. The external forms of these larvæ, however, vary in a most remarkable degree, owing to the unequal evolution of their different parts; and there is also a considerable diversity in the several orders as to the proportion of the fabric of the larva which enters into the composition of the adult form. When the young begins to acquire the characters of the fully developed star-fish and sea-urchin, the parts which are not retained shrivel up, and their substance goes to feed the young form.

One of the most remarkable forms of Echinoderm larvæ is that which has received the name of *Bipinnaria* (fig. 683), from the symmetrical arrangement of its natatory organs. The mouth (*a*), which opens in the middle of a transverse furrow, leads through an œsophagus, *a'*, to a large stomach, around which the body of a star-fish is developing itself; and on one side of this mouth are observed the intestinal tube and anus (*b*). On either side of the anterior portion of the body are six or more narrow fin-like appendages, which are fringed with cilia: and the posterior part of the body is prolonged into a sort of pedicle, bilobed towards its extremity, which also is covered with cilia. The organisation of this larva seems completed, and its movements through the water become very active, before the mass at its anterior extremity presents anything of the aspect of the star-fish, in this respect corresponding with the movements of the *Pluteus* of the Echinoidea. The temporary mouth of the larva does not remain as the permanent mouth of the star-fish: for the

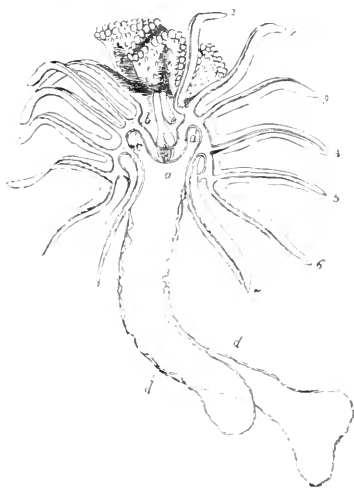

FIG. 683.—*Bipinnaria asterigera*, or larva of star-fish: *a*, mouth: *a'*, œsophagus: *b*, intestinal tube and anal orifice: *c*, furrow in which the mouth is situated: *d d'*, bilobed peduncle: 1, 2, 3, 4, 5, 6, 7, ciliated arms.

oesophagus of the latter enters on what is to become the dorsal side of its body, and the true mouth is subsequently formed by the thinning away of the integument on its ventral surface. The young star-fish is separated from the Bipinnarian larva by the forcible contractions of the connecting stalk, as soon as the calcareous consolidation of its integument has taken place and its true mouth has been formed, but long before it has attained the adult condition; and as its ulterior development has not hitherto been observed in any instance, it is not yet known what are the species in which this mode of evolution prevails. The larval zöoid continues active for several days after its detachment: and it is possible, though perhaps scarcely probable, that it may develop another asteroid by a repetition of this process of gemmation.

In the Bipinnaria, as in other larval zöoids of the *Asteroidea*, there is no internal calcareous framework; such a framework, however, is found in the larvæ of the *Echinoidea* and *Ophiuroidea*, of which the form delineated in fig. 684 is an example. The embryo issues from the ovum as soon as it has attained, by repeated 'segmentation' of the yolk, the condition of the 'mulberry-mass,' and the superficial cells of this are covered with cilia by whose agency it swims freely through the water. So rapid are the early processes of development that no more than from twelve to twenty-four hours intervene between fecundation and the emersion of the embryo, the division into two, four, or even eight segments taking place within three hours after impregnation. Within a few hours after its emersion the embryo changes from the spherical into a sub-pyramidal form with a flattened base; and in the centre of this base is a depression, which gradually deepens, so as to form a mouth that communicates with a cavity in the interior of the body which is surrounded by a portion of the yolk-mass that has returned to the liquid granular state. Subsequently a short intestinal tube is found, with an anal orifice opening on one side of the body. The pyramid is at first triangular, but it afterwards becomes quadrangular; and the angles are greatly prolonged round the mouth (or base), whilst the apex of the pyramid is sometimes much extended in the opposite direction, but is sometimes rounded off into a kind of dome (fig. 684, A). All parts of this curious body, and especially its most projecting portions, are strengthened by a framework of thread-like calcareous rods (*e*). In this condition the embryo swims freely through the water, being propelled by the action of the cilia, which clothe the four angles of the pyramid and its projecting arms, and which are sometimes thickly set upon two or four projecting lobes (*f*); and it has received the designation of *Pluteus*. The mouth is usually surrounded by a sort of proboscis, the angles of which are prolonged into four slender processes (*g, g, g, g*), shorter than the four outer legs, but furnished with a similar calcareous framework.

The first indication of the production of the young Echinus from its 'pluteus' is given by the formation of a circular disc (fig. 684, A, *c*) on one side of the central stomach (*b*): and this disc soon presents five prominent tubercles (B), which subsequently become elongated into tubular processes, which will form the 'sucking-

feet of the adult. The disc gradually extends itself over the stomach, and between its tubules the rudiments of spines are seen to protrude (D); these, with the tubules, increase in length, so as to project against the envelope of the pluteus, and to push themselves through it; whilst, at the same time, the original angular appendages of the pluteus diminish in size, the

ciliary movement becomes less active, being superseded by the action of the suckers and spines, and the mouth of the pluteus closes up. By the time that the disc has grown over half of the gastric sphere, very little of the pluteus remains, except some of the slender calcareous rods, and the number of suckers and spines rapidly increases. The calcareous framework of the shell at first consists, like that of the star-fishes, of a series of isolated networks developed between the cirrhi, and upon these rest the first formed spines (D). But they gradually become more consolidated, and extend themselves over the granular mass, so as to form the series of plates constituting the shell. The mouth of the Echinus (which is altogether distinct from that of the pluteus) is formed at that side of the granular mass over which the shell is last extended; and the first indication of it consists in the appearance of the five calcareous concretions, which are the summits of the five portions of the framework of jaws and teeth that surround it. All traces of the original pluteus are now lost; and the larva, which now presents the general aspect of an Echinoid animal, gradually augments in size, multiplies the number of its plates, cirrhi, and

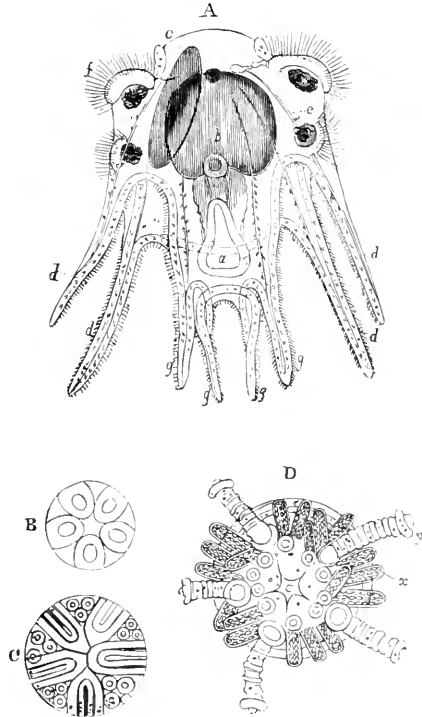

FIG. 684.—Embryonic development of *Echinus*: A *Pluteus* larva at the time of the first appearance of the disc; a, mouth, in the midst of the four-pronged proboscis; b, stomach; c, Echinoid disc; d, d, d, d, four arms of the pluteus-body; e, calcareous framework; f, ciliated lobes; g, g, g, g, ciliated processes of the proboscis; B, disc with the first indication of the sucking-feet; C, disc, with the origin of the spines between the tubular sucking-feet; D, more advanced disc, with the feet, g, and spines, x, projecting considerably from the surface. (N.B.—In B, C, and D, the Pluteus is not represented, its parts having undergone no change, save in becoming relatively smaller.)

spines, evolves itself into its particular generic and specific type, and undergoes various changes of internal structure tending to the development of the complete organism.¹

An excellent summary of the developmental history of the several Echinoderm types, with references to the principal memoirs which treat of it, will be found in Chapter XX. of Mr. Balfour's 'Comparative Embryology,' and in Professor A. Lang's 'Jahrbuch der vergleichenden Anatomie,' which has been translated into English.² In collecting the free-swimming larvæ of Echinoderma the stick-net should be carefully employed in the manner already described, and the search for them is of course most likely to be successful in those localities in which the adult forms of the respective species abound, and on warm calm days, in which they seem to come to the surface in the greatest numbers. The following mode of preparing and mounting them has been kindly communicated to the Author by Mr. Percy Sladen:— For killing and preserving echinodermzöoids, I have come to prefer either osmic acid or the picro-sulphuric mixture of Kleinenberg of one-third strength. The latter, of course, destroys all calcareous structures; but the soft parts are preserved in a wonderful manner. If the diluted Kleinenberg's mixture is used, let the zöoids remain in it for one or two hours; then wash them *thoroughly* in 70 per cent. spirit, until all trace of acid is removed; then stain; then again wash in 70 per cent. spirit, transfer them to 90 per cent. spirit for some hours, and lastly to absolute alcohol. Transfer them from this to oil of cloves; and finally mount in Canada balsam in the usual manner. If osmic acid be used, place three or four of the living zöoids in a watch-glass of sea-water, and add a drop of the 1 per cent. solution. They should not remain even in this weak solution for more than a minute, and should then be thoroughly washed in a superabundance of 35 per cent. spirit, to prevent the deposit of crystals of salt consequent on the action of the osmic acid. Then transfer the specimens to 70 per cent. spirit, and proceed as in the other case.³

One of the most interesting to the microscopist of all Echinoderma is the *Antedon*³ (more generally known as *Comatula*), or 'feather-star' (fig. 685), which is the commonest existing representative of the great fossil series of *Crinoidea*, or 'lily-stars,' that were among the most abundant types of this class in the earlier epochs of the world's history. Like these, the young of *Antedon* is attached by a stalk to a fixed base, part of which is shown in fig. 686; but when it has arrived at a certain stage of development it drops off from this like a fruit from its stalk, and the animal is thenceforth free to move through the ocean water it inhabits. It can swim with con-

¹ Abbreviated development, in which there is no free-swimming larva, is now known to be more common than was once supposed; among Holothurians *Cucumaria crocea*, among Ophiuroids *Ophiacantha vivipara*, and among Echinoids *Hemiaster cavernosus* may be cited as examples.

² Those who wish to carry their study further must consult the recent memoirs of Mr. Bury, Prof. MacBride, and Dr. Willey, and that of Dr. T. Mortensen, *Die Echinoderm-Larven der Plankton Expedition* (Kiel and Leipzig, 1898), in which there is a systematic revision of the Echinoderm larvæ already known.

³ See the Author's 'Researches on the Structure, Physiology, and Development of *Antedon rosaceus*,' Part I., in *Phil. Trans.* 1866, p. 671.

siderable activity, but it exerts this power chiefly to gain a suitable place for attaching itself by means of the jointed prehensile cirrhi put forth from the aboral (under) side of the central disc (fig. 685); so that, notwithstanding its locomotive power, it is nearly as stationary in its free adult condition as it is in its earlier pentacrinoid stage. The *pentacrinoid larva*¹—first discovered by Mr. J. V. Thompson, of Cork, in 1823, but originally supposed by him to be a permanently attached Crinoid—forms a most beautiful object for the lower powers of the microscope, when well preserved in fluid, and viewed by a strong incident light (fig. 686.3); and a series of specimens in different stages of development shows most curious modifications in the form and arrangement of the various component pieces of its calcareous skeleton. In its earlier stage (fig. 686. 1) the body is inclosed in a calyx composed of two circles of plates, namely, five *basals*, forming a sort of pyramid whose apex points downwards, and is attached to the highest joint of the stem; and five *orals* superposed on these, forming when closed a like pyramid whose apex points upwards, but usually separating to give passage to the tentacles, of which a circle surrounds the mouth. In this condition there is no rudiment of arms. In the more advanced stage shown at 2.

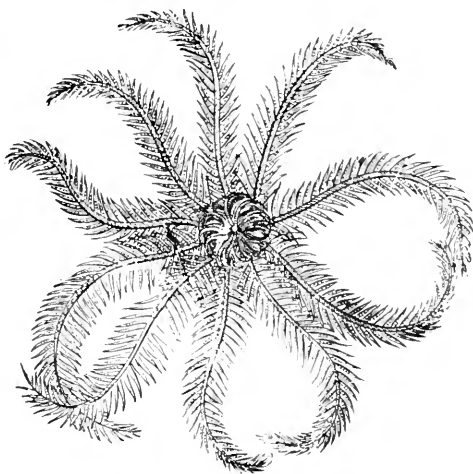

FIG. 685.—*Antedon* (Comatula), or feather-star, seen from its aboral side.

the arms have begun to make their appearance, and the skeleton when carefully examined is found to consist of the following pieces, as shown in fig. 686. 1. *b, b*, the circle of *basals* supported on the top of the stem; *r¹*, the circle of *first radials*, now interposed between the basals and the orals, and alternating with both; between two of these is interposed the single *anal* plate *a*; whilst they support the *second* and the *third radials* (*r²*, *r³*), from the latter of which the bifurcating arms spring; finally, between the second radials we see the five *orals* lifted from the basals on which they originally rested by the interposition of the first radials. In the more advanced stage shown in fig. 686. 3, we find the highest joint of the stem

¹ The pentacrinoid larvae of *Antedon* have been found abundantly (attached to seaweeds and zoöphytes) at Millport, on the Clyde, and in Lamash Bay, Arran; in Kirkwall Bay, Orkney; in Lough Strangford, near Belfast, and in the Bay of Cork; and at Ilfracombe and in Salcombe Bay, Devon.

beginning to enlarge, to form the *centro-dorsal* plate (2, *c d*), from which are beginning to spring the dorsal cirrhi (*cir*) that serve to

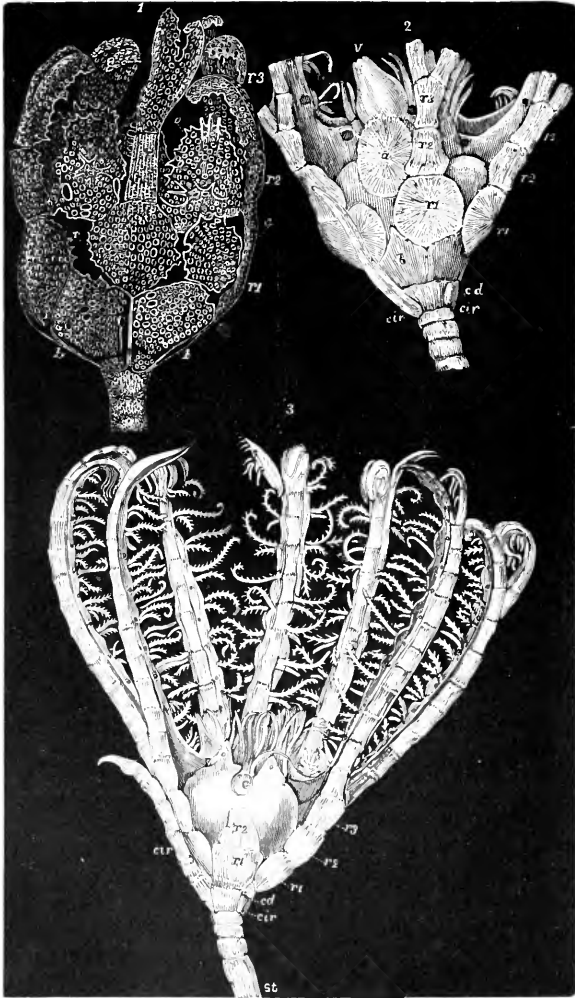

FIG. 685. —Pentacrinoid larva of *Antedon*. 1. Skeleton of early pentacrinoid, under black-ground illumination, showing its component plates: *b, b*, basals, articulated below to the highest point of the stem; r^1, r^1 , first radials, between two of which is seen the single anal plate, *a*; r^2, r^2 , second radials; r^3, r^3 , third radials, giving off the bifurcating arms at their summit; *o, o*, orals. 2, 3. Back and front views of a more advanced pentacrinoid, as seen by incident light, one of the pair of arms being cut away in fig. 3 in order to bring the mouth and its surrounding parts into view: *b, b*, basals; r^1, r^2, r^3 , first, second, and third radials; *a*, anal, now carried upwards by the projection of the vent, *v*; *o, o*, orals; *cir*, dorsal cirrhi, developed from the highest joint of the stem.

anchor the animal when it drops from the stem ; this supports the *basals*, on which rest the *first radials* (r^1) ; whilst the *anal* plate is now lifted nearly to the level of the *second radials* (r^2) by the development of the anal funnel or vent to which it is attached. The *oral* plates are not at first apparent, as they no longer occupy their first position ; but on being carefully looked for they are found still to form a circlet around the mouth (3, o , o), not having undergone any increase in size, whilst the visceral disc and the calyx in which it is lodged have greatly extended. These *oral* plates finally disappear by absorption ; while the *basals* are at first concealed by the great enlargement of the centro-dorsal (which finally extends so far as to conceal the first radials also) ; and at last undergo metamorphosis into a beautiful 'rosette,' which lies between the cavity of the centro-dorsal and that of the calyx. In common with other members of its class, the *Antedon* is represented in its earliest phase of development by a free-swimming 'larval zöoid' or *pseudembryo*, which was first observed by Busch, and has been since carefully studied by Professors Wyville Thomson¹ and Goette.² This zöoid has an elongated egg-like form, and is furnished with transverse bands of cilia and with a mouth and anus of its own. After a time, however, rudiments of the calcareous plates forming the stem and calyx begin to show themselves in its interior ; a disc is then formed at the posterior extremity by which it attaches itself to a seaweed (very commonly *Laminaria*), zöophyte, or polyzoary ; the calyx containing the true stomach, with its central mouth surrounded by tentacles, is gradually evolved ; and the sarcodic substance of the pseudembryo, by which this calyx and the rudimentary stem were originally invested, gradually shrinks, until the young pentacrinoid presents itself in its characteristic form and proportions.³

¹ 'On the Development of *Antedon rosaceus*' in *Phil. Trans.* for 1865, p. 513.

² *Archiv f. mikrosk. Anat.* Bd. xii. p. 583.

³ The general results of the Author's own later studies of this most interesting type (the key to the life-history of the entire geological succession of *Crinoidea*) are embodied in a notice communicated to the *Proceedings of the Royal Society* for 1876, p. 211, and in a subsequent note, p. 451. Of the further contributions recently made to our knowledge of it the memoir of Dr. H. Ludwig 'Zur Anatomie der Crinoideen' (Leipzig, 1877), forming part of his *Morphologische Studien an Echinodermen*, is the most important. Those who wish to carry further their study of the *Crinoidea* should consult the two monographs by Dr. P. Herbert Carpenter in the 'Challenger' Reports.

CHAPTER XVII

POLYZOA AND TUNICATA

As in previous editions of this work the Author followed the once prevalent habit of regarding the Polyzoa and Tunicata as structurally allied, and as it would be necessary to entirely recast the work were the two groups to be now otherwise dealt with, and as, finally, there is no real inconvenience or impropriety in discussing them in one chapter, it is proposed to continue, with this word of warning, the original arrangement of the Author. Some members of both these groups are found on almost every coast, and are most interesting objects for anatomical examination, as well as for observation in the living state.¹

Polyzoa.—The group which is known under this name to many British naturalists (corresponding with that which by Continental zoologists is designated *Bryozoa*) was formerly ranked as an order of zöophytes, and it has been entirely by microscopic study that its comparatively high organisation has been ascertained. The animals of the Polyzoa, in consequence of their universal tendency to multiplication by gemmation, are seldom or never found solitary, but form clusters or colonies of various kinds; and as each is inclosed in either a horny or a calcareous sheath or 'cell,' a composite structure is formed, closely corresponding with the 'polypidom' of a zöophyte, which has been appropriately designated the *polyzoary*. The individual cells of the polyzoary are sometimes only connected with each other by their common relation to a creeping stem or *stolon*, as in *Laganula* (fig. 687); but more frequently they bud forth directly, one from another, and extend themselves in different directions over plane surfaces, as is the case with *Flustra*, *Lepralia*, &c. (fig. 688); whilst not unfrequently the polyzoary develops itself into an arborescent structure (fig. 689), which may even present somewhat of the density and massiveness of the stony corals. Each individual is composed externally of a sort of sac, of which the outer or tegumentary layer is either simply membranous, or is horny, or in some instances calcified, so as to form the cell; this investing sac is lined by a more delicate membrane, which closes its orifice, and which then becomes continuous with the wall of the alimentary canal; this lies freely in the visceral sac, floating (as it were) in the liquid which it contains.

The principal features in the structure of this group will be best understood from the examination of a characteristic example, such as the *Laganula repens*, which is shown in the state of expansion at A, fig. 687, and in the state of contraction at B and C. The mouth is

¹ For a good general account see Dr. Harmer in vol. ii. of the *Cambridge Natural History*, 1896.

surrounded by a circle of tubular tentacles, which are clothed by vibratile cilia; these tentacles, in the species we are considering, vary from ten to twelve in number, but in some other instances they are more numerous. By the ciliary investment of the tentacles the Polyzoa are at once distinguishable from those hydroid polypes to which they bear a superficial resemblance, and with which they were at one time confounded; and accordingly, while still ranked among zöophytes, they were characterised as *ciliobrachiæ*. The tentacula are seated upon an annular disc, which is termed the *lophophore*, and which forms the roof of the visceral or perigastric cavity; and this cavity extends itself into the interior of the tentacula,¹ through perforations in the lophophore, as is shown at D, fig. 687, representing a portion of the tentacular circle on a larger scale. *a a* being the tentacula, *b b* their internal canals, *c* the muscles of the tentacula, *d* the lophophore, and *e* its retractile muscles.

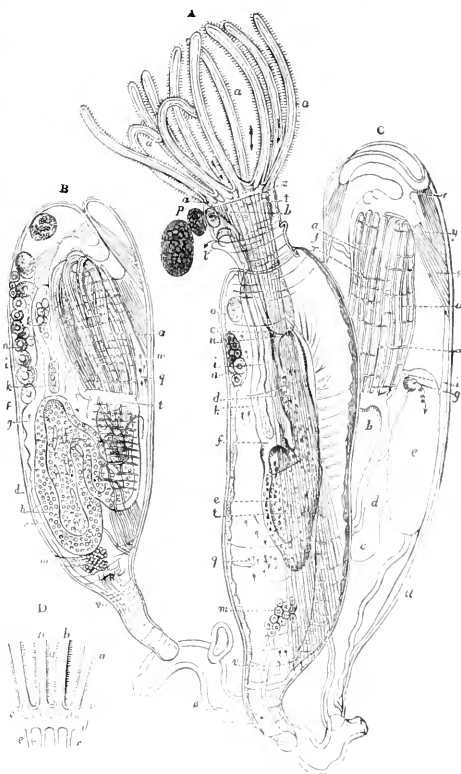

FIG. 687.—Structure of *Laqueola repens* (Van Beneden). A, polypide expanded; B, polypide retracted; C, another view of the same, with the visceral apparatus in outline, that the manner in which it is doubled on itself, with the tentacular crown and muscular system, may be more distinctly seen: *a a*, tentacula; *b*, pharynx; *c*, pharyngeal valve; *d*, oesophagus; *e*, stomach; *f*, its pyloric orifice; *g*, cilia on its inner surface; *h*, biliary follicles lodged in its wall; *i*, intestine; *k*, particles of excrementitious matter; *l*, anal orifice; *m*, testis; *n*, ovary; *o*, ova lying loose in the perivisceral cavity; *p*, outlet for their discharge; *q*, spermatozoa in the perivisceral cavity; *r, s, t, u, v, w, x*, muscles. D, portion of the lophophore more enlarged: *a a*, tentacula; *b b*, their internal canals; *c*, their muscles; *d*, lophophore; *e*, its retracter muscles.

surrounded by a circle of tubular tentacles, which are clothed by vibratile cilia; these tentacles, in the species we are considering, vary from ten to twelve in number, but in some other instances they are more numerous. By the ciliary investment of the tentacles the Polyzoa are at once distinguishable from those hydroid polypes to which they bear a superficial resemblance, and with which they were at one time confounded; and accordingly, while still ranked among zöophytes, they were characterised as *ciliobrachiæ*. The tentacula are seated upon an annular disc, which is termed the *lophophore*, and which forms the roof of the visceral or perigastric cavity; and this cavity extends itself into the interior of the tentacula,¹ through perforations in the lophophore, as is shown at D, fig. 687, representing a portion of the tentacular circle on a larger scale. *a a* being the tentacula, *b b* their internal canals, *c* the muscles of the tentacula, *d* the lophophore, and *e* its retractile muscles.

¹ This communication between the tentacular and visceral cavities is denied by Dr. Vigélius, who has recently made a careful search for it.

and some other Polyzoa a muscular stomach or gizzard for the trituration of the food intervenes between the œsophagus and the true digestive stomach.) The walls of the stomach, *k*, have considerable thickness, and the epithelial cells which line them seem to have the character of a rudimentary digestive gland. This, however, is more obvious in some other members of the group. The stomach is lined, especially at its upper part, with vibratile cilia, as seen at *c, g*; and by the action of these the food is kept in a state of constant agitation during the digestive process. From the upper part of the stomach, which is (as it were) doubled upon itself, the intestine (*i*) opens, by a pyloric orifice, *f*, which is furnished with a regular valve; within the intestine are seen at *h* particles of excrementitious matter which are discharged by the anal orifice at *l*. No special circulating apparatus here exists; but the liquid which fills the cavity that surrounds the viscera contains the nutritive matter which has been prepared by the digestive operation, and which has transuded through the walls of the alimentary canal; a few corpuscles of irregular size are seen to float in it. No other respiratory organs exist than the tentacula, into whose cavity the nutritive fluid is probably sent from the perivisceral cavity for aëration by the current of water that is continually flowing over them.

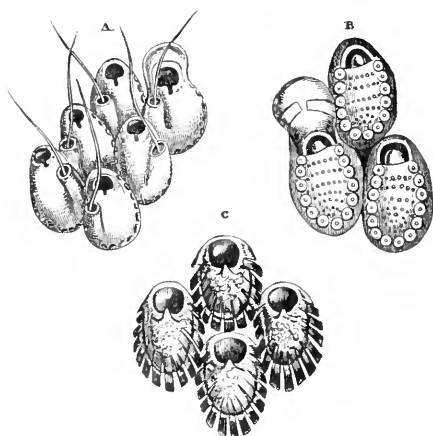

FIG. 688.—Cells of Polyzoa: A, *Mastigophora Hyndmanni*; B, *Cribrilina figularis*; C, *Umbonula verrucosa*.

The production of *gemmæ* or buds may take place either from the bodies of the polypides themselves, which is what always happens when the cells are in mutual apposition, or from the connecting stem or 'stolon,' where the cells are distinct one from the other, as in *Laguncula*. In the latter case there is first seen a bud-like protuberance of the horny external integument, into which the soft membranous lining prolongs itself: the cavity thus formed, however, is not to become (as in *Hydra* and its allies) the stomach of the new zöoid, but it constitutes the chamber surrounding the digestive viscera, which organs have their origin in a thickening of the lining membrane that projects from one side of the cavity into its interior, and gradually shapes itself into the alimentary canal with its tentacular appendages. Of the production of *gemmæ* from the polypides themselves the best examples are furnished by the *Flustra* and their allies. From a single cell of the *Flustra* five such buds may be sent off, which develop themselves

into new polypides around it; and these in their turn produce buds from their unattached margins, so as rapidly to augment the number of cells. To this extension there seems no definite limit, and it often happens that the cells in the central portion of the leaf-like expansion of a Flustra are devoid of contents and have lost their vitality, whilst the edges are in a state of active growth.¹ Independently of their propagation by gemmation, the Polyzoa have a true sexual generation, the sexes, however, being usually, if not invariably, united in the same polypides. The sperm-cells are developed in a glandular body, the testis, *m*, which lies beneath the base of the stomach, or they are developed from large portions of the inner surface of the body-wall; when mature they rupture, and set free the spermatozoa, *q q*, which swim freely in the liquid of the visceral cavity. The ova, on the other hand, are formed in an ovarium, *n*, which is lodged in the membrane lining the tegumentary sheath near its outlet or is placed near the end of the cæcal process of the stomach; the ova, having escaped from this into the visceral cavity, as at *o*, are fertilised by the spermatozoa which they there meet with, and are finally discharged by an outlet at *p*, beneath the tentacular circle.

These creatures possess a considerable number of muscles, by which their bodies may be projected from their sheaths, or drawn within them; of these muscles, *r, s, t, u, v, w, x*, the direction and points of attachment sufficiently indicate the uses; they are for the most part *retractors*, serving to draw in and double up the body, to fold together the circle of tentacula, and to close the aperture of the sheath, when the animal has been completely withdrawn into its interior. The *projection* and *expansion* of the animal, on the contrary, appear to be chiefly accomplished by a general pressure upon the sheath, which will tend to force out all that can be expelled from it. The tentacles themselves are furnished with distinct muscular fibres, by which their separate movements seem to be produced. At the base of the tentacular circle, just above the anal orifice, is a small body (seen at *A, a*), which is a nervous ganglion; as yet no branches have been distinctly seen to be connected with it in this species: but its character is less doubtful in some other Polyzoa. Besides the independent movements of the individual polypides, other movements may be observed, which are performed by so many of them simultaneously as to indicate the existence of some connecting agency: and such connecting agency, it is affirmed by Dr. Fritz Müller,² is furnished by what he terms a 'colonial nervous system.' In a *Serialaria* having a branching polyzoary that spreads itself on seaweeds over a space of three or four inches, he states that a nervous ganglion may be distinguished at the origin of each branch, and another ganglion at the origin of each polypide-bud, all these ganglia being connected together, not merely by principal trunks.

¹ For further details consult Haddon 'On Budding in Polyzoa,' *Quart. Journ. Microsc. Sci.* xxiii. p. 516. Embryonic fission has been observed by Harmer in *Crisia* and *Lichenopora*.

² See his memoir in *Wiegmann's Archiv*, 1860, p. 311, translated in *Quart. Journ. of Microsc. Sci.* n.s. vol. i. 1861, p. 300; Rev. T. Hincks's 'Note on the Movements of the Vibracula in *Caberea borjii*, and on the supposed common Nervous System in the Polyzoa,' *Quart. Journ. Microsc. Sci.* xviii. p. 7.

but also by plexuses of nerve-fibres, which may be distinctly made out with the aid of chromic acid in the cylindrical joints of the polyzoary. His views, however, are not now accepted, observers of great histological experience maintaining that what he regards as nerve-fibres are only connective tissue.

Of all the Polyzoa of our own coasts the *Membraniporida*, or 'sea-mats' (*Flustra Membranipora*), are the most common; these present flat expanded surfaces resembling in form those of many seaweeds (for which they are often mistaken), but exhibiting, when viewed with even a low magnifying power, a most beautiful network, which at once indicates their real character. The cells are generally arranged on both sides, and it was calculated by Dr. Grant that as a single square inch of an ordinary *Flustra* contains 1,800 such cells, and as an average specimen presents about ten square inches of surface, it will consist of no fewer than 18,000 polypides. The want of transparency in the cell-wall, however, and the infrequency with which the animal projects its body far beyond the mouth of the cell, render the species of this genus less favourable subjects for microscopic examination than are those of the *Bowerbankia*, a polyzoon with a trailing stem and separated cells like those of *Laguncula*, which is very commonly found clustering around the base of masses of *Flustra*. It was in this that many of the details of the organisation of the interesting group we are considering were first studied by Dr. A. Farre, who discovered it in 1837, and subjected it to a far more minute examination than any polyzoon had previously received;¹ and it is one of the best adapted of all the marine forms yet known for the display of the beauties and wonders of this type of organisation. The *Aleyonidium*, however, is one of the most remarkable of all the marine forms for the comparatively large size of the tentacular crowns, these, when expanded, being very distinctly visible to the naked eye, and presenting a spectacle of the greatest beauty when viewed under a sufficient magnifying power. The polyzoary of this genus has a spongy aspect and texture, very much resembling that of certain Aleyonian zoöphytes, for which it might readily be mistaken when its contained animals are all withdrawn into their cells; when these are expanded, however, the aspect of the two is altogether different, as the minute plumose tufts which then issue from the surface of the *Aleyonidium*, making it look as if it were covered with the most delicate downy film, are in striking contrast with the larger solid-looking polypes of the *Aleyonium*. The opacity of the polyzoary of the *Aleyonidium* renders it quite unsuitable for the examination of anything more than the tentacular crown and the oesophagus which it surmounts, the stomach and the remainder of the visceral apparatus being always retained within the cell. It furnishes, however, a most beautiful object for the binocular microscope, when mounted with all its polypides expanded.² Several of the fresh-water Polyzoa are peculiarly interesting subjects for microscopic examination, alike

¹ See his memoir 'On the Minute Structure of some of the Higher Forms of Polypi,' in the *Phil. Trans.* for 1837, p. 387.

² Mr. J. Lomas has detected calcareous spicules in *Aleyonidium gelatinosum*, and finds that they are more abundant in older than in younger colonies. See *Proceedings of the Liverpool Geological Society*, v. p. 241.

on account of the remarkable distinctness with which the various parts of their organisation may be seen and the very beautiful manner in which their ciliated tentacula are arranged upon a deeply crescentic or horseshoe-shaped *lophophore*. By this peculiarity the fresh-water Polyzoa are distinguished from the marine: and they, with the marine *Rhabdopleura*, may be further distinguished by the possession of an epistome, or moveable process above the mouth, whence Professor Allman calls them the *Phylactolamata*, as compared with the others, which are *Gymnolamata*, or have no epistome. The cells of the *Phylactolamata* are for the most part lodged in a sort of gelatinous substratum which spreads over the leaves of aquatic plants, sometimes forming masses of considerable size: but in the very curious and beautiful *Cristatella* the polyzoary is unattached, so as to be capable of moving freely through the water.¹

In the marine Polyzoa, constituting by far the most numerous division of the class, the anus opens either outside (Ectoprocta) or within (Entoprocta) the circlet of tentacles: the former comprise three groups:—I. *Cheilostomata*, in which the mouth of the cell is *sub-terminal*, or not quite at its extremity (fig. 688), is somewhat crescentic in form, and is furnished with a movable (generally membranous) lip, which closes it when the animal retreats. This includes a large part of the species that most abound on our own coast, notwithstanding their wide differences in form and habit. Thus the polyzoaries of some (as *Flustra*) are horny and flexible, whilst those of others (as *Eschara* and *Retepora*) are so penetrated with calcareous matter as to be quite rigid; some grow as independent plant-like structures (as *Bugula* and *Gemellaria*), whilst others, having a like arborescent form, creep over the surfaces of rocks or stones (as *Hippothoa*); and others, again, have their cells in close apposition, and form crusts which possess no definite figure (as is the case with *Lepralia* and *Membranipora*). II. The second order, *Cyclostomata*, consists of those Polyzoa which have the mouth at the *termination* of tubular calcareous cells, without any movable appendage or lip (fig. 689). This includes a comparatively small number of genera, of which *Crisia* and *Tubulipora* contain the largest proportion of the species that occur on our own coasts. III. The distinguishing character of the third order, *Tenostomata*, is derived from the presence of a comb-like circular fringe of bristles, connected by a delicate membrane, around the mouth of the cell, when the animal is projected from it, this fringe being drawn in when the animal is retracted. The polyzoaries of this group are very various in character, the cells being sometimes horny and separate (as in *Favrella* and *Bowerbankia*), sometimes fleshy and coalescent (as in *Alcyonidium*). IV. In the *Entoprocta*, which are represented by *Loxosoma* and *Pedicellina*, and are doubtless the most archaic of the true Polyzoa, the lophophore is produced upwards on the back of the tentacles, uniting them at their base in a sort of muscular calyx, and giving to the animal when expanded somewhat the form of an inverted bell, like

¹ See Professor Allman's beautiful *Monograph of the British Fresh-water Polyzoa*, published by the Ray Society, 1857; and J. Jullien, 'Monographie des Bryozoaires d'eau douce,' *Bull. Soc. Zool. de France*, x. p. 91.

that of *Vorticella* (fig. 593). As the Polyzoa altogether resemble hydroid zoöphytes in their habits, and are found in the same localities, it is not requisite to add anything to what has already been said respecting the collection, examination, and mounting of this very interesting class of objects.¹

A large proportion of the *Cheilostomata* are furnished with very peculiar motile appendages, which are of two kinds, *avicularia* and *vibracula*. The avicularia or 'bird's head processes,' so named from the striking resemblance they present to the head and jaws of a bird (fig. 689, B), are generally, when highly differentiated, 'sessile' upon the angles or margins of the cells, that is, are attached at once to them without the intervention of a stalk, as at A, being either 'projecting' or 'immersed;' but in the genera *Bugula* and *Bicellaria*, where they are present at all, they are 'pedunculate,' or mounted on foot-stalks (B). Under one form or the other, they are wanting in but few of the genera belonging to this order; and their presence or absence furnishes valuable characters for the discrimination of species. Each avicularium has two 'mandibles,' of which one is fixed, like the upper jaw of a bird, the other movable, like its lower jaw; the latter is opened and closed

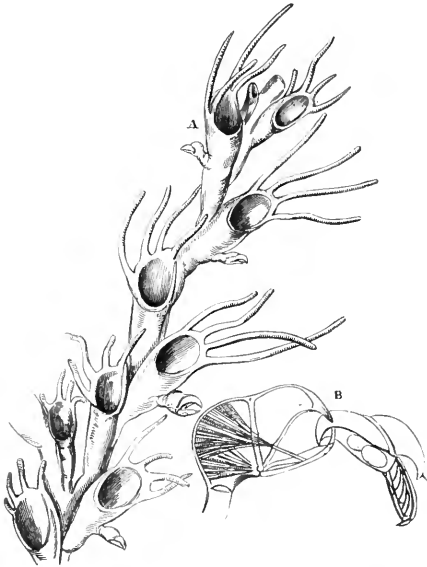

FIG. 689.—A, portion of *Bicellaria ciliata*, enlarged; B, one of the 'bird's head' processes of *Bugula avicularia*, more highly magnified, and seen in the act of grasping another.

by two sets of muscles which are seen in the interior of the 'head,' and between them is a peculiar body, furnished with a pencil of bristles, which is probably a

¹ For a more detailed account of the structure and classification of the marine Polyzoa see Professor Van Beneden's 'Recherches sur les Bryozoaires de la côte d'Ostende' in *Mém. de l'Acad. Roy. de Bruxelles*, tom. xvii.; Mr. G. Busk's *Catalogue of the Marine Polyzoa in the Collection of the British Museum*; Mr. Hincks's *British Marine Polyzoa*, 1880; and Nitsche, 'Beiträge zur Kenntniss der Bryozoen,' in *Zeitschrift f. wiss. Zool.* Bde. xx, xxi, xxiv. Of the more important recent publications we may note Mr. Busk's Reports on the Polyzoa of the *Challenger* voyage; Mr. Harmer, 'On the Structure and Development of *Leorosoma*' and 'On the Life-history of *Pedicellina*,' in vols. xxv. and xxvi. of the *Quart. Journ. of Microsc. Sci.*; J. Barrois, 'Recherches sur l'Embryologie des Bryozoaires,' Lille, 1877, and other memoirs; W. J. Vigelius, 'Morphologische Untersuchungen über *Flystra Membranaco-truncata*,' *Biolog. Centralblatt*, iii. p. 705, and *Bijdragen tot de Dierkunde*, xi. For a general account see Professor Ray Lankester's article 'Polyzoa,' in the 9th edition of the *Encyclopædia Britannica*, and Dr. Harmer's work already referred to.

tactile organ, being brought forwards when the mouth is open, so that the bristles project beyond it, and being drawn back when the mandible closes. The avicularia keep up a continual snapping action during the life of the polyzoary; and they may often be observed to lay hold of minute worms or other bodies, sometimes even closing upon the beaks of adjacent organs of the same kind, as shown at B. In the pedunculate forms, besides the snapping action, there is a continual rhythmical nodding of the head upon the stalk; and few spectacles are more curious than a portion of the polyzoary of *Bagula avicularia* (a very common British species) in a state of active vitality, when viewed under a power sufficiently low to allow a number of these bodies to be in sight at once. It is still very doubtful what is their precise function in the economy of the animal—whether it is to retain within the reach of the ciliary current bodies that may serve as food, or whether it is, like the Pedicellariæ of Echini, to remove extraneous particles that may be in contact with the surface of the polyzoary. The latter would seem to be the function of the *vibracula*, which are long bristle-shaped organs (fig. 688. A), each one springing at its base out of a sort of cup that contains muscles by which it is kept in almost constant motion, sweeping slowly and carefully over the surface of the polyzoary, and removing what might be injurious to the delicate inhabitants of the cells when their tentacles are protruded.¹

Tunicata.—The zoological position of the Tunicata, which has long been a subject of great discussion, appears to be now approximately settled; the study of their development has shown that they are provided with a notochord, and that their nervous system follows the course which is characteristic of what are often called *Vertebrata*, but should better be called *Chordata*. As the notochord is always restricted to the hinder part of the body, the Tunicata may be called Urochordata. In all (except, perhaps, *Appendicularia*) there are distinct signs of degeneration. They have been named Tunicata from the inclosure of their bodies in a 'tunic,' which is sometimes leathery or even cartilaginous in its texture, and which sometimes includes calcareous spicules, whose forms are often very beautiful. They are often found to resemble the Polyzoa in their tendency to produce composite structures by gemmation; but in their habits they are for the most part very inactive, exhibiting scarcely anything comparable to those rapid movements of expansion and retraction which it is so interesting to watch among the Polyzoa; whilst, with the exception of the *Salpida* and other floating species which are chiefly found in seas warmer than those that surround our coast, and the curious *Appendicularia* to be presently noticed, they are rooted to one spot during all but the earliest period of their lives. The larger forms of the *Ascidian* group, which constitutes the bulk of the class, are always solitary; not propagating by gemmation, except in the case of the Clavelinidae. Although of special importance

¹ See Mr. G. Busk's 'Remarks on the Structure and Function of the Avicularian and Vibracular Organs of Polyzoa' in *Trans. Microsc. Soc.* ser. ii. vol. ii. 1854, p. 26; and Mr. A. W. Waters, 'On the use of the Avicularian Mandible in the Determination of the Cheilostomatous Bryozoa,' *Journ. Roy. Microsc. Soc.* (2), v. p. 774.

to the comparative anatomist and the zoologist, this group does not afford much to interest the ordinary microscopist, except in the peculiar actions of its respiratory and circulatory apparatus. In common with the composite forms of the group, the solitary Ascidians have a large branchial sac, with fissured walls, resembling that shown in figs. 690, B. and 692: into this sac water is admitted by the oral orifice, and a large proportion of it is caused to pass through the fissures, by the agency of the cilia with which they are fringed, into a surrounding chamber, whence it is expelled through the atriopore, or opening of the mantle. This action may be distinctly watched through the external walls in the smaller and more transparent species; and not even the ciliary action of the tentacles of the Polyzoa affords a more beautiful spectacle. It is peculiarly remarkable in one species that occurs on our own coasts, the *Corella parallelogramma*,¹ in which the wall of the branchial sac is divided into a number of areolæ, each of them shaped into a shallow funnel: and round one of these funnels each branchial fissure makes two or three turns of a spiral. When the cilia of all these spiral fissures are in active movement at once, the effect is most singular. Another most remarkable phenomenon presented throughout the group, and well seen in the solitary Ascidian just referred to, is the *alternation* in the direction of the circulation. The heart, which lies at the bottom of the branchial sac, has its one end connected with the principal trunk leading to the body, and the other with that leading to the branchial sac. At one time it will be seen that the blood flows *from* the respiratory apparatus to the end of the heart in which its trunk terminates, which then contracts so as to drive it through the systemic trunk *to* the body at large; but after this course has been maintained for a time the heart ceases to pulsate for a moment or two, and the course is reversed, the blood flowing *into* the heart *from* the body generally, and being propelled *to* the branchial sac. After this reversed course has continued for some time another pause occurs, and the first course is resumed. The length of time intervening between the changes does not seem by any means constant. It is usually stated at from half a minute to two minutes in the composite forms; but in the solitary *Corella parallelogramma* (a species very common in Lamlash Bay, Arran), the Author has repeatedly observed an interval of from five to fifteen minutes, and in some instances he has seen the circulation go on for half an hour, or even longer, without change—always, however, reversing at last.

The *compound Ascidians* are very commonly found adherent to seaweeds, zoöphytes, and stones between the tide-marks: and they present objects of great interest to the microscopist, since the small size and transparency of their bodies when they are detached from the mass in which they are imbedded not only enable their structure to be clearly discerned without dissection, but allow many of their living actions to be watched. Of these we have a characteristic example in *Amaroucium proliferum*, of which the form of the com-

¹ See Alder in *Ann. of Nat. Hist.* ser. iii. vol. xi. 1863, p. 157; and Hancock in *Journ. Linn. Soc.* ix. p. 333.

posite mass and the anatomy of a single individual are displayed in fig. 690. Its clusters appear almost completely inanimate, exhibiting no very obvious movements when irritated; but if they be placed when fresh in sea-water a slight pouting of the orifices will soon be perceptible, and a constant and energetic series of currents will be found to enter by one set and to be ejected by the other, indicating that all the machinery of active life is going on within these apathetic bodies. In the family *Polyclinida* to which this genus belongs the body is elongated, and may be divided into three regions: the thorax (A), which is chiefly occupied by the respiratory sac: the abdomen (B), which contains the digestive apparatus; and the post-abdomen (C), in which the heart and generative organs are lodged. At the summit of the thorax is seen the oral orifice, *c*, which leads to the branchial sac *e*; this is perforated by an immense number of slits, which allow part of the water to pass into the space between the branchial sac and the muscular mantle. At *k* is seen the

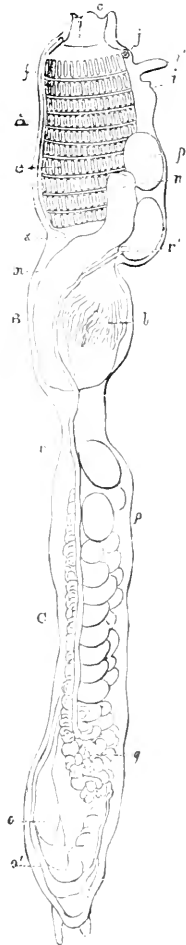

FIG. 690.—Compound mass of *Amaroucium proliferum* with the anatomy of a single zooid: A, thorax; B, abdomen; C, post-abdomen: *c*, oral orifice; *e*, branchial sac; *f*, thoracic blood-vessel; *i*, atriopore; *i'*, projection overhanging it; *j*, nervous ganglion; *k*, oesophagus; *l*, stomach surrounded by digestive tubuli; *m*, intestine; *n*, anus opening into the cloaca formed by the mantle; *o*, heart; *o'*, pericardium; *p*, ovarium; *p'*, egg ready to escape; *q*, testis; *r*, spermatic canal; *r'*, termination of this canal in the cloaca.

oesophagus, which is continuous with the lower part of the pharyngeal cavity; this leads to the stomach, *l*, which is surrounded by glandular follicles; and from this passes off the intestine, *m*, which terminates at *n* in the vent. A current of water is continually

drawn in through the mouth by the action of the cilia of the branchial sac and of the alimentary canal; a part of this current passes through the fissures of the branchial sac into the peribranchial cavity, and thence into the cloaca; whilst another portion, entering the stomach by an aperture at the bottom of the pharyngeal sac, passes through the alimentary canal, giving up any nutritive materials it may contain, and carrying away with it any excrementitious matter to be discharged; and this having met the respiratory current in the cloaca, the two mingled currents pass forth together by the atrial orifice, *i*. The long post-abdomen is principally occupied by the large ovarium, *p*, which contains ova in various stages of development. These, when matured and set free, find their way into the cloaca, where two large ova are seen (one marked *p* and the other immediately below it) waiting for expulsion. In this position they receive the fertilising material from the testis, *q*, which discharges its products by the long spermatic canal, *r*, that opens into the cloaca, *r*. At the very bottom of the post-abdomen we find the heart, *o*, inclosed in its pericardium, *o'*. In the group we are now considering a number of such animals are imbedded together in a sort of gelatinous mass, and covered with an integument common to them all; the composition of this gelatinous substance is remarkable as including cellulose, which generally ranks as a vegetable product. The mode in which new individuals are developed in this mass is by the extension of *stolons* or creeping stems from the bases of those previously existing; and from each of these stolons several buds may be put forth, every one of which may evolve itself into the likeness of the stock from which it proceeded, and may in its turn increase and multiply after the same fashion.

In the family of Didemnians the post-abdomen is absent, the heart and generative apparatus being placed by the side of the intestine in the abdominal portion of the body. The zöoids are frequently arranged in star-shaped clusters, their anal orifices being all directed towards a common vent which occupies the centre. This shortening is still more remarkable, however, in the family of Botryllians, whose beautiful stellate gelatinous incrustations are extremely common upon seaweeds and submerged rocks (fig. 691). The anatomy of these animals is very similar to that of the *Amaroucium* already described; with this exception, that the body exhibits no distinction of cavities, all the organs being brought together in one, which must be considered as thoracic. In this respect there is an evident approximation towards the solitary species.¹

This approximation is still closer, however, in the 'social' Ascidi-ans, or *Clavellinida*, in which the general plan of structure is nearly the same, but the zöoids are simply connected by their stolons instead of being included in a common investment; so that their relation to each other is very nearly the same as that of the poly-

¹ For more special information respecting the *compound Ascidi-ans* see especially the admirable monograph of Professor Milne-Edwards on that group; Mr. Lister's memoir, 'On the Structure and Functions of Tubular and Cellular Polypi, and of Ascidiæ,' in the *Phil. Trans.* 1834; and the article 'Tunicata,' by Professor T. Rupert Jones, in the *Cyclopædia of Anatomy and Physiology*. More recent authorities are cited on p. 918.

pides of *Laguncula*, the chief difference being that a regular circulation takes place through the stolon in the one case, such as has no existence in the other. A better opportunity of studying the living actions of the Ascidians can scarcely be found than that which is afforded by the genus *Perophora*, first discovered by Mr. Lister, which occurs not unfrequently on the south coast of England and in the Irish Sea, living attached to seaweeds, and looking like an assemblage of minute globules of jelly, dotted with orange and brown, and linked by a silvery winding thread. The isolation of the body of each zóoid from that of its fellows, and the extreme transparency of its tunics, not only enable the movements of fluid within the body to be distinctly discerned, but also allow the action of the cilia that border the slits of the respiratory sac to be clearly made out. This sac is perforated with four rows of narrow oval openings, through which a portion of the water that enters its oral orifice escapes

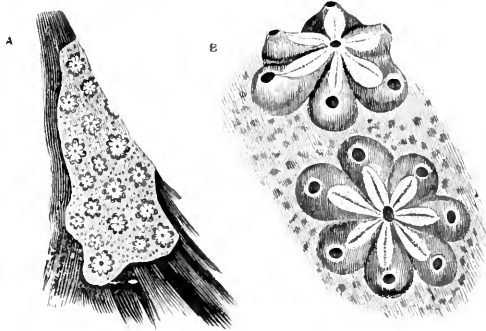

FIG. 691.—*Botryllus violaceus*: A, cluster on the surface of a Fucus; B, portion of the same enlarged.

into the space between the sac and the mantle, and is thus discharged immediately by the atrial funnel. Whatever little particles, animate or inanimate, the current of water brings flow into the sac unless stopped at its entrance by the tentacles, which do not appear fastidious. The particles which are admitted usually lodge somewhere on the sides of the sac, and then travel horizontally until they arrive at that part of it down which the current proceeds to the entrance of the stomach, which is situated at the bottom of the sac. Minute animals are often swallowed alive, and have been observed darting about in the cavity for some days, without any apparent injury either to themselves or to the creature which incloses them. In general, however, particles which are unsuited for reception into the stomach are rejected by the sudden contraction of the mantle (or muscular tunic), the atriopore being at the same time closed, so that they are forced out by a powerful current through the oral orifice. The curious alternation of the circulation that is characteristic of the class generally may be particularly well studied in *Perophora*. The creeping stalk that connects the individuals of

any group contains two distinct canals, which send off branches into each peduncle. One of these branches terminates in the heart, which is nothing more than a contractile dilatation of the principal trunk; this trunk subdivides into vessels (or rather *sinuses*, which are mere channels not having proper walls of their own), of which some ramify over the respiratory sac, branching off at each of the passages between the oval slits, whilst others are first distributed to the stomach and intestine, and to the soft surface of the mantle. All

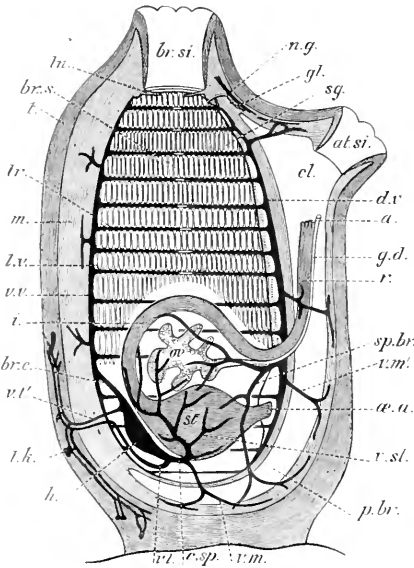

FIG. 692. — Diagrammatic longitudinal section of *Ascidia* showing the heart, the blood-vessels, the branchial sac, the alimentary canal, &c. from the left side: *br.si.*, branchial siphon; *at.si.*, atrial siphon; *t.*, test; *m.*, mantle; *br.s.*, branchial sac; *p.br.*, peribranchial cavity; *cl.*, cloaca; *n.g.*, nerve ganglion; *lu.*, tentacle; *gl.*, neural gland; *a.a.*, oesophageal aperture; *st.*, stomach; *i.*, intestine; *r.*, rectum; *a.*, anus; *o.v.*, genital organs; *g.d.*, genital ducts; *h.*, heart; *c.sp.*, cardio-splanchnic vessel; *v.t.*, vessel to the test; *t.k.*, terminal knob on vessel in test; *v.t.*, vessel from the test; *v.sl.*, vessel to the stomach &c.; *v.m.*, vessel to the mantle; *v.m.*, vessel from the mantle; *d.v.*, dorsal vessel; *tr.*, transverse vessel of branchial sac; *l.v.*, fine longitudinal vessel of branchial sac; *sg.*, stigmata of branchial sac; *v.v.*, ventral vessel; *br.c.*, branchio-cardiac vessel; *sp.br.*, splanchno-branchial vessel. (After Prof. Herdman.)

these reunite so as to form a trunk, which passes to the peduncle and constitutes the returning branch. Although the circulation in the different bodies is brought into connection by the common stem, yet that of each is independent of the rest, continuing when the current through its own foot-stalk is interrupted by a ligature; and the stream which returns from the branchial sac and the viscera is then poured into the posterior part of the heart instead of entering the peduncle.

The *development* of the Ascidians, the early stages of which are observable whilst the ova are still within the cloaca of the parent, presents some phenomena of much interest to the microscopist which alone can be noticed here. After the ordinary repeated segmentation of the yolk, whereby a 'mulberry mass' is produced, a sort of ring is seen encircling its central portion; but this soon shows itself as a tapering tail-like prolongation from one side of the yolk, which gradually becomes more and more detached from it, save at the part from which it springs. Either whilst the egg is still within

the cloaca, or soon after it has escaped from the vent, its envelope bursts, and the larva escapes, and in this condition it presents very

much the appearance of a tadpole, the tail being straightened out, and propelling the body freely through the water by its lateral strokes. The centre of the body is occupied by a mass of liquid yolk, and this is continued into the interior of three prolongations which extend themselves from the opposite extremity, each terminating in a sort of sucker. After swimming about for some hours with an active wriggling movement, the larva attaches itself to some solid body by means of one of these suckers; if disturbed from its position, it at first swims about as before; but it soon completely loses its activity, and becomes permanently attached; and important changes manifest themselves in its interior. The organs and tissues which constitute the chief part of the future animal are gradually drawn back, so that the whole of it is concentrated into one mass; and the tail, now consisting only of the gelatinous envelope, is either detached entire from the body by the contraction of the connecting portion, or withers, and is thrown off gradually in shreds. The shaping of the internal organs out of the yolk mass takes place very rapidly, so that by the end of the second day of the sedentary state the outlines of the branchial sac and of the stomach and intestine may be traced, no external orifices, however, being as yet visible. The pulsation of the heart is first seen on the third day, and the formation of the branchial and anal orifices takes place on the fourth, after which the ciliary currents are immediately established through the branchial sac and alimentary canal. The embryonic development of other Ascidians, solitary as well as composite, takes place on a plan essentially the same as the foregoing, a free tadpole-like larva being always produced in the first instance with the curious exception of some species of *Molgula*.¹

This larval condition is represented in a very curious adult free-swimming form, termed *Appendicularia*, which is frequently to be taken with the tow-net on our own coasts. This animal has an oval or flask-like body, which in large specimens attains the length of one-fifth of an inch, but which is often not more than one-fourth or one-fifth of that size. It is furnished with a tail-like appendage three or four times its own length, broad, flattened, and rounded at its extremity; and by the powerful vibrations of this appendage it is propelled rapidly through the water. The structure of the body differs greatly from that of the Ascidians, its plan being much simpler; in particular, the pharyngeal sac is entirely destitute of ciliated branchial fissures opening into a surrounding cavity; but two canals,

¹ The study of the development of *Ascidians* derived a new interest and importance from the discovery, made by Kowalevsky in 1867, that their free-swimming larvæ present a most striking parallelism to vertebrate embryos, in exhibiting the beginnings of a spinal marrow and a notochord; thus bridging over the gulf that was supposed to separate them from Invertebrata, and (when taken in connection with the curious Ascidian affinities of *Amphioxus*, the lowest vertebrate at present known) affording strong reason for belief in the derivation of the vertebrate and tunicate types from a common original. See his memoir 'Entwicklungsgeschichte der einfachen Ascidiën' in *Mém. St. Pétersb. Acad. Sci.* tom. x. 1867, and the abstract of it in *Quart. Journ. Microsc. Sci.* x. n.s. 1870, p. 59; also Professor Haeckel's *History of Creation*, ii. pp. 152, 200. Further information will be found in chap. ii. of vol. ii. of the late Professor Balfour's *Comparative Embryology*, and an application of the facts of development to the philosophy of the subject in Professor Ray Lankester's *Degeneration* (London, 1880).

one on either side of the entrance to the stomach, are prolonged from it to the external surface; and by the action of the long cilia with which these are furnished, in conjunction with the cilia of the branchial sac, a current of water is maintained through its cavity. From the observations of Huxley, however, it appears that the direction of this current is by no means constant; since, although it usually enters by the mouth and passes out by the ciliated canals, it sometimes enters by the latter and passes out by the former. The caudal appendage has a central axis (notochord), above and below which is a ribbon-like layer of muscular fibres; a nervous cord, studded at intervals with minute ganglia, may be traced along its whole length. By Mertens, one of the early observers of this animal, it was said to be furnished with a peculiar gelatinous envelope or *Haus* (house), very easily detached from the body, and capable of being re-formed after having been lost. Notwithstanding the great numbers of specimens which have been studied by Müller, Huxley, Leuckart, and Gegenbaur, none of these excellent observers has met with this appendage; but it has been since seen by Allman, who describes it as an egg-shaped gelatinous mass, in which the body is imbedded, the tail alone being free; whilst from either side of the central plane there radiates a kind of double fan, which seems to be formed by a semicircular membranous lamina folded upon itself. It was surmised by Allman, with much probability, that this curious appendage is 'nidamental,' having reference to the development and protection of the young; but on this point further observations are much needed; and any microscopist who may meet with *Appendicularia* furnished with its 'house' should do all he can to determine its structure and its relations to the body of the animal.¹

¹ For details in respect to the structure of *Appendicularia*, see Huxley in *Phil. Trans.* for 1851, and in *Quart. Journ. of Microsc. Sci.* vol. iv. 1856, p. 181; also Allman in the same journal, vol. vii. 1859, p. 86; Gegenbaur in *Siebold und Kölliker's Zeitschrift*, Bd. vi. 1855, p. 406; Leuckart's *Zöologische Untersuchungen*, Heft ii. 1854; Fol's 'Etudes sur les Appendiculaires' in *Archiv. Zool. expér.* tom. i. 1872, p. 57; the three memoirs by H. Lolmann published in 1896. For the *Tunicata* generally, see Professor T. Rupert Jones in vol. iv. of the *Cyclop. of Anatomy and Physiology*; Professor Herdman's article, 'Tunicata,' in the 9th edition of the *Encyclopædia Britannica*; Mr. Alder's 'Observations on the British Tunicata' in *Ann. of Nat. Hist.* ser. iv. vol. xi. 1863, p. 153; and Mr. Hancock's memoir 'On the Anatomy and Physiology of the Tunicata' in the *Journal of the Linnean Society*, vol. ix. p. 309. Great additions to our knowledge have been made by Professor Herdman, whose reports on the forms collected by H.M.S. *Challenger* should be consulted, and by Professors Van Beneden and Julien (see especially their memoirs in the *Archives de Biologie*). See also Roule, 'Recherches sur les Ascidies simples des côtes de Provence,' *Ann. Museum Marselles*, ii.; Seeliger, 'Die Entwicklungsgeschichte der Socialen Ascidien,' *Jenaische Zeitschr.* xviii. p. 528; Salensky, 'Nene Untersuchungen über die embryonale Entwicklung der Salpen,' *Mith. Zool. Stat. Neapel*, iv. pp. 90, 327; and Ullman, 'Die Arten des Gattung *Doliolum* im Golfe von Neapel,' in the *Fauna und Flora des Golfes von Neapel*, x. The above titles by no means exhaust the list of recent important memoirs on *Tunicata*, but the researches of Caullery, Metcalf, Pizon, and Seeliger are beyond the scope of this work. The last-named has commenced a systematic account of the group in Bronn's *Thierreich*.

CHAPTER XVIII

MOLLUSCA AND BRACHIOPODA

THE various forms of 'shell-fish,' with their 'naked' or shell-less allies, furnish a great abundance of objects of interest to the microscopist, of which, however, the greater part may be grouped under three heads—namely (1) the structure of the *shell*, which is most interesting in the CONCHIFERA (OR LAMELLIBRANCHIATA) and BRACHIOPODA, in both of which classes the shells are 'bivalve,' while the animals differ from each other essentially in general plan of structure; (2) the structure of the *tongue* or *palate* of the GASTROPODA, most of which have 'univalve' shells, others, however, being 'naked;' (3) the *developmental history* of the embryo, for the study of which certain of the Gastropods present the greatest facilities. These three subjects, therefore, will be first treated of systematically, and a few miscellaneous facts of interest will be subjoined.

Shells of Mollusca.—These investments were formerly regarded as mere inorganic exudations, composed of calcareous particles, cemented together by animal glue; microscopic examination, however, has shown that they possess a definite *structure*, and that this structure presents certain very remarkable variations in some of the groups of which the molluscous series is composed. We shall first describe that which may be regarded as the characteristic structure of the ordinary bivalves, taking as a type the group of *Margaritaceæ*, which includes the *Melœgrina* or 'pearl oyster' and its allies, the common *Pinna* ranking amongst the latter. In all these shells we readily distinguish the existence of two distinct layers: an *external*, of a brownish-yellow colour; and an *internal*, which has a pearly or 'nacreous' aspect, and is commonly of a lighter hue.

The structure of the *outer* layer may be conveniently studied in the shell of *Pinna*, in which it commonly projects beyond the inner, and there often forms laminae sufficiently thin and transparent to exhibit its general characters without any artificial reduction. If a small portion of such a lamina be examined with a low magnifying power by transmitted light, each of its surfaces will present very much the appearance of a honeycomb; whilst its broken edge exhibits an aspect which is evidently fibrous to the eye, but which, when examined under the microscope with reflected light, resembles that of an assemblage of segments of basaltic columns (fig. 696). This outer layer is thus seen to be composed of a vast number of *prisms*, having a tolerably uniform size, and usually presenting an approach

to the hexagonal shape. These are arranged perpendicularly (or nearly so) to the surface of the lamina of the shell; so that its thickness is formed by their length, and its two surfaces by their extremities. A more satisfactory view of these prisms is obtained by grinding down a lamina until it possesses a high degree of transparency, the

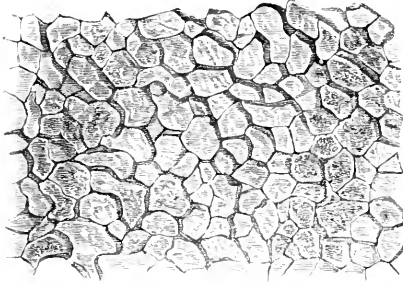

FIG. 693.—Section of shell of *Pinna*, taken transversely to the direction of its prism.

prisms being then seen (fig. 693) to be themselves composed of a very homogeneous substance, but to be separated by definite and strongly marked lines of division. When such a lamina is submitted to the action of dilute acid, so as to dissolve away the carbonate of lime, a tolerably firm and consistent membrane is left, which exhibits the prismatic structure just as perfectly as did the original shell (fig. 694), its hexagonal divisions bearing a strong resemblance to the walls of the cells of the pith or bark of a plant. By making a section of the shell perpendicularly to its surface, we obtain a view of the prisms cut in the direction of their length (fig. 695); these are frequently seen to be marked by delicate transverse striae (fig. 696) closely resembling those observable on the prisms of the enamel of teeth, to which this kind of shell-structure may be considered as bearing a very close resemblance, except as regards the mineralising ingredient.

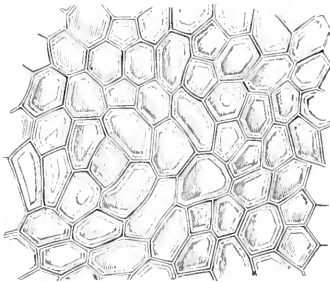

FIG. 694.—Membranous basis of the same.

If a similar section be decalcified by dilute acid, the membranous residuum will exhibit the same resemblance to the walls of prismatic cells viewed longitudinally, and will be seen to be more or less regularly marked by the transverse striae just alluded to. It sometimes happens in recent but still more commonly in fossil shells, that the decay of the animal membrane leaves the contained prisms without any connecting medium; as they are then quite isolated, they can be readily detached one from another; and each one may be observed to be marked by the like striations, which, when a sufficiently high magnifying power is used, are seen to be minute grooves, apparently resulting from a thickening of the intermediate wall in those situations. These appearances seem best accounted for by supposing that each is lengthened by successive

additions at its base, the lines of junction of which correspond with the transverse striation; and this view corresponds well with the fact that the shell-membrane not infrequently shows a tendency to split into thin laminae along the lines of striation, whilst we occasionally meet with an excessively thin natural lamina lying between the thicker prismatic layers, with one of which it would have probably coalesced but for some accidental cause which preserved its distinctness. That the prisms are not formed in their entire length at once, but that they are progressively lengthened and consolidated at their lower extremities, would appear also from the fact that where the shell presents a deep colour (as in *Pinna nigripina*) this colour is usually disposed in distinct strata, the outer portion of each layer being the part most deeply tinged, whilst the inner extremities of the prisms are almost colourless.



FIG. 695.—Section of the shell of *Pinna* in the direction of its prisms.

This 'prismatic' arrangement of the carbonate of lime in the shells of *Pinna* and its allies has been long familiar to conchologists, and regarded by them as the result of crystallisation. When

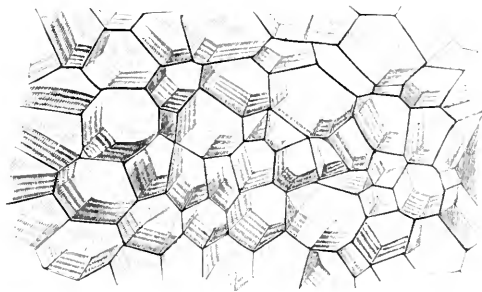

FIG. 696.—Oblique section of prismatic shell-substance.

it was first more minutely investigated by Mr. Bowerbank¹ and the Author,² and was shown to be connected with a similar arrangement in the membranous residuum left after the decalcification of the shell-substance by acid, microscopists generally³ agreed to regard it as a 'calcareous epidermis,' the long prismatic cells being supposed to be formed by the coalescence of the epidermic cells in piles, and giving

¹ 'On the Structure of the Shells of Molluscos and Conchiferous Animals,' in *Trans. Microsc. Soc.* ser. i. vol. i. 1844, p. 123.

² 'On the Microscopic Structure of Shells' in *Reports of British Association for 1844 and 1847.*

³ See Mr. Quekett's *Histological Catalogue of the College of Surgeons' Museum* and his *Lectures on Histology*, vol. ii.

their shape to the deposit of carbonate of lime formed within them. The progress of inquiry, however, has led to an important modification of this interpretation, the Author being now disposed to agree with Huxley¹ in the belief that the entire thickness of the shell is formed as an *excretion* from the surface of the epidermis, and that the horny layer which in ordinary shells forms their external envelope or 'periostracum,'² being here thrown out at the same time with the calcifying material, is converted into the likeness of a cellular membrane by the pressure of the prisms that are formed by crystallisation at regular distances in the midst of it. The peculiar conditions under which calcareous concretions form themselves in an organic matrix have been carefully studied by Mr. Rainey and Dr. W. M. Ord, of whose researches some account will be given hereafter.

The *internal* layer of the shells of the *Margaritaceæ* and some other families has a 'nacreous' or iridescent lustre, which depends (as Sir D. Brewster has shown³) upon the striation of its surface with a series of grooved lines, which usually run nearly parallel to each other (fig. 697). As these lines are not obliterated by any amount of polishing, it is obvious that their presence depends upon something peculiar in the texture of this substance, and not upon any mere superficial arrangement. When a piece of the nacre (commonly known as 'mother-of-pearl') of the *Meleagrina* or 'pearl-oyster' is carefully examined, it becomes evident that the lines are produced by the cropping out of laminae of shell situated more or less obliquely to the plane of the surface. The greater the *dip* of these laminae, the closer will their edges be; whilst the less the angle which they make with the surface, the wider will be the interval between the lines. When the section passes for any distance in the plane of a lamina, no lines will present themselves on that space. And thus the appearance of a section of nacre is such as to have been aptly compared by Sir J. Herschel to the surface of a smoothed deal board, in which the woody layers are cut perpendicularly to their surface in one part, and nearly in their plane in another. Sir D. Brewster (*loc. cit.*) appears to have supposed that nacre consists of a multitude of layers of carbonate of lime alternating with animal membrane, and that the presence of the grooved lines on the most highly polished surface is due to the wearing away of the edges of the animal laminae, whilst those of the hard calcareous laminae stand out. If each line upon the nacreous surface, however, indicates a distinct layer of shell-substance, a very thin section of 'mother-of-pearl' ought to contain many hundred laminae, in accordance with the number of lines upon its surface, these being frequently no more than $\frac{1}{7500}$ th of an inch apart. But when the nacre is treated with dilute acid, so as to dissolve its cal-

¹ See his article, 'Tegumentary Organs,' in *Cyclopædia of Anatomy and Physiology*, supplementary volume, pp. 489-492.

² The *periostracum* is the yellowish-brown membrane covering the surface of many shells, which is often (but erroneously) termed their *epidermis*.

³ *Phil. Trans.* 1814, p. 397.—The late Mr. Barton (of the Mint) succeeded in producing an artificial iridescence on metallic buttons by drawing closely approximating lines with a diamond point upon the surface of the steel die by which they were struck.

nacreous portion, no such repetition of membranous layers is to be found; on the contrary, if the piece of nacre be the product of one act of shell formation, there is but a single layer of membrane. This layer, however, is found to present a more or less folded or plaited arrangement, and the lineation of the nacreous surface may perhaps be thus accounted for. A similar arrangement is found in *pearls*, which are rounded concretions projecting from the inner surface of the shell of *Meleagrina*, and possessing a nacreous structure corresponding to that of 'mother-of-pearl.' Such concretions are found in many other shells, especially the fresh-water mussels, *Unio* and *Anodon*; but these are usually less remarkable for their pearly lustre; and, when formed at the edge of the valves, they may be partly or even entirely made up of the prismatic substance of the external layer, and may be consequently altogether destitute of the pearly character.

In all the genera of the *Margaritacea* we find the external layer

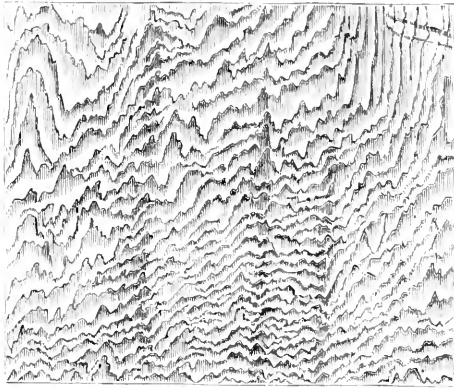

FIG. 697.—Section of nacreous lining of shell of *Meleagrina margaritifera* (pearl-oyster).

of the shell prismatic, and of considerable thickness, the internal layer being nacreous. But it is only in the shells of a few families of bivalves that the combination of organic with mineral components is seen in the same distinct form; and these families are for the most part nearly allied to *Pinna*. In the *Unionidae* (or 'fresh-water mussels') nearly the whole thickness of the shell is made up of the internal or 'nacreous' layer; but a uniform stratum of prismatic substance is always found between the nacre and the periostracum, really constituting the inner layer of the latter, the outer being simply horny. In the *Ostreaceae* (or oyster tribe), also, the greater part of the thickness of the shell is composed of a 'sub-nacreous' substance, representing the inner layer of the shells of *Margaritacea*, its successively formed laminae, however, having very little adhesion to each other; and every one of these laminae is bordered at its free edge by a layer of the prismatic substance distinguished by its

brownish-yellow colour. In these and some other cases a distinct membranous residuum is left after the decalcification of the prismatic layer by dilute acid; and this is most tenacious and substantial where (as in the *Margaritaceæ*) there is no proper periostracum. Generally speaking, a thin prismatic layer may be detected upon the external surface of bivalve shells, where this has been protected by a periostracum, or has been prevented in any other manner from undergoing abrasion; thus it is found pretty generally in *Chama*, *Trigonia*, and *Solen*, and occasionally in *Anomia* and *Pecten*.

In many other instances, however, nothing like a cellular structure can be distinctly seen in the delicate membrane left after decalcification; and in such cases the animal basis bears but a very small proportion to the calcareous substance, and the shell is usually extremely hard. This hardness appears to depend upon the mineral

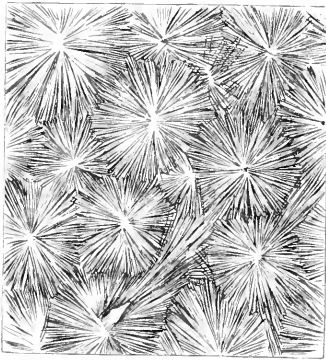

FIG. 698.—Section of hinge-tooth of *Mya arenaria*.

arrangement of the carbonate of lime; for whilst in the *prismatic* and ordinary *nacreous* layer this has the crystalline condition of *calcite*, it can be shown in the hard shell of *Pholas* to have the arrangement of *aragonite*, the difference between the two being made evident by polarised light. A very curious appearance is presented by a section of the large hinge-tooth of *Mya arenaria* (fig. 698), in which the carbonate of lime seems to be deposited in nodules that possess a crystalline structure resembling that of the mineral termed *warellite*. Approaches to

this curious arrangement are seen in many other shells.

There are several bivalve shells which almost entirely consist of what may be termed a *sub-nacreous* substance, their polished surfaces being marked by lines, but these lines being destitute of that regularity of arrangement which is necessary to produce the iridescent lustre. This is the case, for example, with most of the *Pectinida* (or scallop tribe), also with some of the *Mytilacea* (or mussel tribe), and with the common *Oyster*. In the internal layer of by far the greater number of bivalve shells, however, there is not the least approach to the nacreous aspect; nor is there anything that can be described as definite structure; and the residuum left after its decalcification is usually a structureless 'basement membrane.'

The ordinary account of the mode of growth of the shells of bivalve Mollusca—that they are progressively enlarged by the deposition of new laminae, each of which is in contact with the internal surface of the preceding, and extends beyond it—does not express the whole truth; for it takes no account of the fact that most shells are composed of two layers of very different texture, and does not

specify whether *both* these layers are thus formed by the entire surface of the 'mantle' whenever the shell has to be extended, or whether only *one* is produced. An examination of fig. 699 will clearly show the mode in which the operation is effected. This figure represents a section of one of the valves of *Unio occidentis*, taken perpendicularly to its surface, and passing from the margin or lip (at the left hand of the figure) towards the hinge (which would be at some distance beyond the right). This section brings into view the two substances of which the shell is composed, traversing the outer or prismatic layer in the direction of the length of its prisms, and passing through the nacreous lining in such a manner as to bring into view its numerous laminae, separated by the lines *aa'*, *bb'*, *cc'*, &c. These lines evidently indicate the successive formations of this layer, and it may be easily shown by tracing them towards the hinge on the one side and towards the margin on the other, that at every enlargement of the shell its whole interior is lined by a new nacreous lamina in immediate contact with that which preceded it.

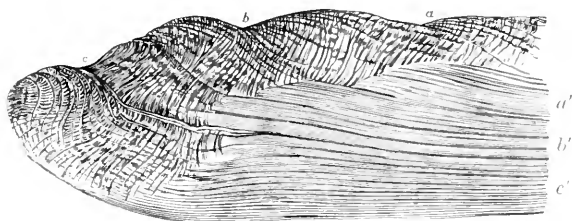

FIG. 699.—Vertical section of the lip of one of the valves of the shell of *Unio*: *a*, *b*, *c*, successive formations of the outer prismatic layer; *a'*, *b'*, *c'*, the same of the inner nacreous layer.

The number of such laminae, therefore, in the oldest part of the shell indicates the number of enlargements which it has undergone. The outer or prismatic layer of the growing shell, on the other hand, is only formed where the new structure projects beyond the margin of the old; and thus we do not find one layer of it overlapping another except at the lines of junction of two distinct formations. When the shell has attained its full dimensions, however, new laminae of both layers still continue to be added, and thus the lip becomes thickened by successive formations of prismatic structure, each being applied to the inner surface of the preceding, instead of to its free margin. A like arrangement may be well seen in the *Oyster*, with this difference, that the successive layers have but a comparatively slight adhesion to each other.¹

The shells of *Terebratulæ* and of most other **Brachiopods** are distinguished by peculiarities of structure which differentiate them from those of the Mollusca. When thin sections of them are microscopically examined, they exhibit the appearance of long flattened prisms (fig. 700. *A*, *b*), which are arranged with such obliquity

¹ The most important recent work on the shells of *Lamellibranchs* is that of the lately deceased F. Bernard; see *Bull. Soc. Géol. France*, vols. xxiii. and xxiv.

that their rounded extremities crop out upon the inner surface of the shell in an imbricated (tile-like) manner (*a*). All true *Terebratulida*, both recent and fossil, exhibit another very remarkable peculiarity; namely, the *perforation* of the shell by a large number of canals,

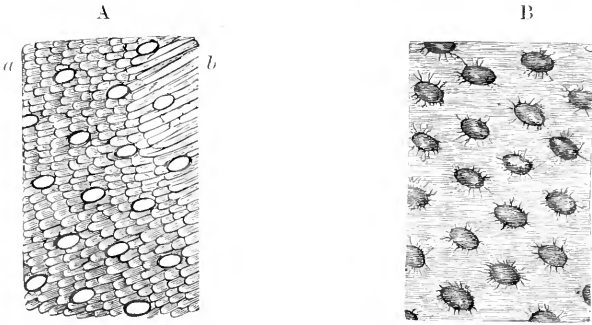
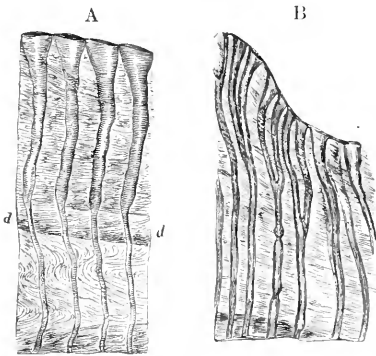

FIG. 700.—A, internal surface, *a*, and oblique section, *b*, of shell of *Waldheimia australis*; B, external surface of the same.

which generally pass nearly perpendicularly from one surface to the other (as is shown in vertical sections, fig. 701), and terminate internally by open orifices (fig. 700. A), whilst externally they are covered by the periostracum (B). Their diameter is greatest towards the external surface, where they sometimes expand suddenly, so as to become trumpet-shaped: and it is usually narrowed rather suddenly when, as sometimes happens, a new internal layer is formed as a lining to the preceding (fig. 701. A, *d d*).

Hence the diameter of these canals, as shown in different transverse sections of one and the same shell, will vary according to the part of its thickness which the section happens to traverse. The shells of different species of perforated *Brachiopods*, however, present very striking diversities in the size and closeness of their canals, as shown by sections taken in corresponding parts; three examples of this kind are given for the sake of comparison in figs. 702-704. These canals are occupied in the living state by tubular prolongations of the mantle, whose interior is filled with a fluid containing minute cells and granules, which, from its corresponding in appearance with the fluid contained in the great sinuses of the mantle, may perhaps



701.—Vertical sections of shell of *Waldheimia australis*, showing at A the canals opening by large trumpet-shaped orifices on the outer surface, and contracting at *d, d* into narrow tubes; and showing at B a bifurcation of the canals.

striking diversities in the size and closeness of their canals, as shown by sections taken in corresponding parts; three examples of this kind are given for the sake of comparison in figs. 702-704. These canals are occupied in the living state by tubular prolongations of the mantle, whose interior is filled with a fluid containing minute cells and granules, which, from its corresponding in appearance with the fluid contained in the great sinuses of the mantle, may perhaps

be considered to be the animal's blood. Of their special function in the economy of the animal it is difficult to form any probable idea; but it is interesting to remark (in connection with the hypothesis of a relationship between Brachiopods and Polyzoa) that they seem to have their parallel in extensions of the perivisceral cavity of many species of *Flustra*, *Eschara*, *Lepralia*, &c., into passages excavated in the walls of the cells of the polyzoary. Professor Sollas¹ finds in the centre of these prolongations an axial fibre which can be traced backwards to the nerve-cells of the mantle; at the distal end is a terminal cell which is connected by a fibril with the axial fibre, and is covered externally by a transparent chitinous layer: save for the absence (or the unproved presence) of pigment cells we should be justified in regarding the processes as organs which are sensitive to luminous impressions.

In the family *Rhynchonellidae*, which is represented by only six recent species, but which contains a very large proportion of

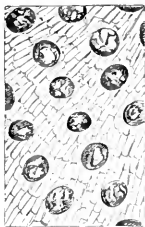

FIG. 702.

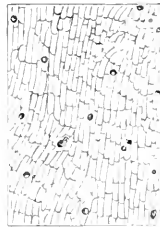

FIG. 703.

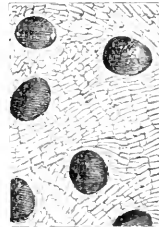

FIG. 704.

- FIG. 702.—Horizontal section of shell of *Terebratulula bullata* (fossil, Oolite).
 FIG. 703. " " *Megerlia lima* (fossil, Chalk).
 FIG. 704. " " *Spiriferina rostrata* (Triassic).

fossil Brachiopods, these canals are almost entirely absent: so that the uniformity of their presence in the *Terebratulidae*, and their general absence in the *Rhynchonellidae*, supply a character of great value in the discrimination of the fossil shells belonging to these two groups respectively. Great caution is necessary, however, in applying this test: *mere surface markings cannot be relied on*; and no statement on this point is worthy of reliance which is not based on a microscopic examination of thin sections of the shell. In the families *Spiriferidae* and *Strophomenidae*, on the other hand, some species possess the perforations, whilst others are destitute of them; so that their presence or absence *there* serves only to mark out subordinate groups. This, however, is what holds good in regard to characters of almost every description in other departments of natural history; a character which is of fundamental importance from its close relation to the general plan of organisation in one group being, from its want of constancy, of far less account in another.²

¹ *Proc. Roy. Dublin Soc.* v. 318.

² For a particular account of the Author's researches on this group see his memoir on the subject, forming part of the introduction of Mr. Davidson's *Monograph of the*

There is not by any means the same amount of diversity in the structure of the shell in the class of *Gastropods*, a certain typical plan of construction being common to by far the greater number of them. The small proportion of animal matter contained in most of these shells is a very marked feature in their character, and it serves to render other features indistinct, since the residuum left after the removal of the calcareous matter is usually so imperfect as to give no clue whatever to the explanation of the appearances shown by sections. Nevertheless, the structure of these shells is by no means homogeneous, but always exhibits indications, more or less clear, of a definite arrangement. The 'porcellanous' shells are composed of three layers, all presenting the same kind of structure, but each differing from the others in the mode in which this is disposed. For each layer is made up of an assemblage of thin laminae placed side by side, which separate one from another, apparently in the planes of rhomboidal cleavage, when the shell is fractured; and, as was first pointed out by Mr. Bowerbank, each of these laminae consists of a series of elongated spicules (considered by him as prismatic cells filled with carbonate of lime) lying side by side in close apposition; and these series are disposed alternately in contrary directions, so as to intersect each other nearly at right angles, though still lying in parallel planes. The direction of the planes is different, however, in the three layers of the shell, bearing the same relation to each other as have those three sides of a cube which meet each other at the same angle; and by this arrangement, which is better seen in the fractured edge of the *Cyprea* or any similar shell than in thin sections, the strength of the shell is greatly augmented. A similar arrangement, obviously answering the same purpose, has been shown by the late Sir John Tomes to exist in the enamel of the teeth of Rodentia, and by Professor Rolleston in that of the elephant.

The principal departures from this plan of structure are seen in *Patella*, *Chiton*, *Haliotis*, *Turbo* and its allies, and in the 'naked' *Gastropods*, many of which last, both terrestrial and marine, have some rudiment of a shell. Thus in the common slug, *Limax rufus*, a thin oval plate of calcareous texture is found imbedded in the shield-like fold of the mantle covering the fore part of its back; and if this be examined in an early stage of its growth it is found to consist of an aggregation of minute calcareous nodules, generally somewhat hexagonal in form, and sometimes quite transparent, whilst in other instances it presents an appearance closely resembling that delineated in fig. 698. In the epidermis of the mantle of some species of *Doris*, on the other hand, we find long calcareous spicules, generally lying in parallel directions, but not in contact with each other, giving firmness to the whole of its dorsal portion; and these are sometimes covered with small tubercles, like the spicules of

British Fossil Brachiopoda, published by the Paleontographical Society. A very remarkable example of the importance of the presence or absence of the perforations in distinguishing shells whose internal structure shows them to be generically different, whilst from their external conformation they would be supposed to be not only generically but specifically identical, will be found in the *Ann. Nat. Hist.* ser. iii. vol. xx. 1867, p. 68.

Gorgonia. They may be separated from the soft tissue in which they are imbedded by means of caustic potash; and when treated with dilute acid, whereby the calcareous matter is dissolved away, an organic basis is left, retaining in some degree the form of the original spicule. This basis seems to be a cell in the earliest stage of its formation, being an isolated particle of protoplasm without wall or cavity, and the close correspondence between the appearance presented by thin sections of various univalve shells, and the forms of the spicules of *Doris*, seems to justify the conclusion that even the most compact shells of this group are constructed out of the like elements, in a state of closer aggregation and more definite arrangement, with the occasional occurrence of a layer of more spheroidal bodies of the same kind, like those forming the vestigial shell of *Limax*.

The structure of shells generally is best examined by making *sections* in different planes as nearly parallel as may be possible to the surfaces of the shell, and other sections at right angles to these; the former may be designated as *horizontal*, the latter as *vertical*. Nothing need here be added to the full directions for making such sections which have already been given. Many of them are beautiful and interesting objects for the polariscope. Much valuable information may also be derived from the examination of the surfaces presented by *fracture*. The membranous residua left after the decalcification of the shell by dilute acid may be mounted in weak spirit or in Goadby's solution.

The animals composing the class of *Cephalopoda* (cuttle-fish and nautilus tribe) are for the most part without shells; and the structure of the few that we meet with in the genera *Nautilus*, *Argonauta* ('paper nautilus'), and *Spirula* does not present any peculiarities that need here detain us. The rudimentary shell or *scpiostaire* of the common cuttle-fish, however, which is frequently spoken of as the 'cuttle-fish bone,' exhibits a very beautiful and remarkable structure, such as causes sections of it to be very interesting microscopic objects. The outer shelly portion of this body consists of horny layers, alternating with calcified layers, in which last may be seen an hexagonal arrangement somewhat corresponding with that shown in fig. 698. The soft friable substance that occupies the hollow of this boat-shaped shell is formed of a number of delicate calcareous plates running across it from one side to the other in parallel directions, but separated by intervals several times wider than the thickness of the plates; and these intervals are in great part filled up by what appear to be fibres or slender pillars passing from one plate or floor to another. A more careful examination shows, however, that, instead of a large number of detached pillars, there exists a comparatively small number of very thin sinuous laminae, which pass from one surface to the other, winding and doubling upon themselves, so that each lamina occupies a considerable space. Their precise arrangement is best seen by examining the parallel plates, after the sinuous laminae have been detached from them, the lines of junction being distinctly indicated upon these. By this arrangement each layer is most effectually supported by those with which

it is connected above and below, and the sinuosity of the thin intervening laminae, answering exactly the same purpose as the 'corrugation' given to iron plates for the sake of diminishing their flexibility, adds greatly to the strength of this curious texture, which is at the same time lightened by the large amount of open space between the parallel plates that intervenes among the sinuosities of the laminae. The best method of examining this structure is to make sections of it with a sharp knife in various directions, taking care that the sections are no thicker than is requisite for holding together; these may be mounted on a black ground as opaque objects, or in Canada balsam as transparent objects, under which last aspect they furnish very beautiful objects for the polariscope.

Palate of Cephaloporous Molluscs.—The organ which is sometimes referred to under this designation, and sometimes

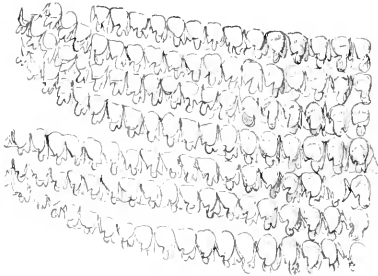

FIG. 705.—Portion of the left half of the palate of *Helix hortensis*, the rows of teeth near the edge separated from each other to show their form.

as the 'tongue,' is one of a very singular nature, and cannot be likened to either the tongue or the palate of higher animals; it is best to call it by its distinctive name 'odontophore.' For it is a tube that passes backwards and downwards beneath the mouth, closed at its hinder end, whilst in front it opens obliquely upon the floor of the mouth, being (as it were) slit up and spread out so as to form a nearly flat surface.

On the interior of the tube, as well as on the flat expansion of it, we find numerous transverse rows of minute teeth, which are set upon flattened plates, each principal tooth sometimes having a basal plate of its own, whilst in other instances one plate carries several teeth. Of the former arrangement we have an example in the palate of many terrestrial Gastropods, such as the snail (*Helix*) and slug (*Limax*), in which the number of plates in each row is very considerable (figs. 705, 706), amounting to 180 in the large garden slug (*Limax maximus*); whilst the latter prevails in many marine Gastropods, such as the common whelk (*Buccinum undatum*), the palate of which has only three plates in each row, one bearing the small central teeth, and the two others the large lateral teeth (fig. 709). The length of the palatal tube and the number of rows of teeth vary greatly in different species. Generally speaking, the tube of the terrestrial Gastropods is short, and is contained entirely within the nearly globular head; but the rows of teeth being closely set together are usually very numerous, there being frequently more than 100, and in some species as many as 160 or 170; so that the total number of teeth may mount up, as in *Helix pomatia*, to 21,000, and in *Limax maximus* to 26,800. The trans-

verse rows are usually more or less curved, as shown in fig. 706, whilst the longitudinal rows are quite straight, and the curvature takes its departure on each side from a central longitudinal row, the teeth of which are symmetrical, whilst those of the lateral portions of each transverse row present a modification of that symmetry, the prominences on the *inner* side of each tooth being suppressed, whilst those on the outer side are increased; this modification may be observed to augment in degree as we pass from the central line towards the edges.

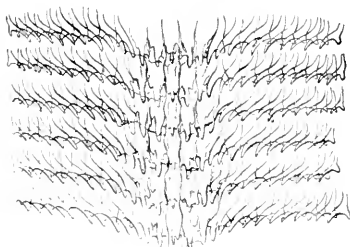

FIG. 706.—Palate of *Hyalinia cellaria*.

The palatal tube of the marine Gastropods is generally longer, and its teeth larger, and in many instances it extends far beyond the head, which may, indeed, contain but a small part of it. Thus in a common limpet (*Patella*) we find the principal part of the tube to lie folded up, but perfectly free, in the abdominal cavity, between the greatly elongated intestine and the muscular foot; and in some species its length is twice or even three times as great as that of the entire animal. In a large proportion of cases these palates exhibit a very marked separation between the central

and the lateral portions (figs. 707, 708), the teeth of the central band being frequently small and smooth at their edges, whilst those of the lateral are large and serrated. The palate of *Trochus zizyphinus*, represented in fig. 707, is one of the most beautiful examples of this form, not only the large teeth of the lateral bands, but the delicate leaf-like teeth of the central portion having their edges minutely serrated. A yet more complex type, however, is found in the palate of *Haliotis*, in which there is a central band of teeth having nearly straight edges instead of points; then, on each side, a lateral band consisting of large teeth shaped like those

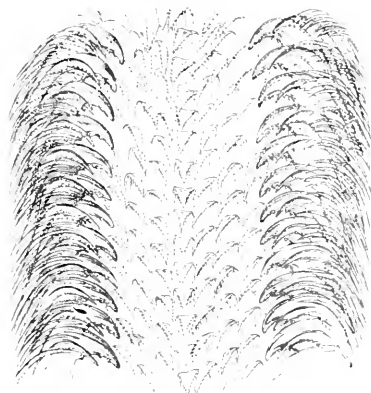

FIG. 707.—Palate of *Trochus zizyphinus*.

of the shark; and beyond this, again, another lateral band on either side, composed of several rows of smaller teeth. Very curious differences also present themselves among the different species of the same genus. Thus in *Doris pilosa* the central band is almost entirely wanting, and each lateral band is formed of a single row of very large hooked teeth, set obliquely like those of the lateral band in fig. 707; whilst in *Doris tuberculata* the central band is the

part most developed, and contains a number of rows of conical teeth, standing almost perpendicularly, like those of a barrow (fig. 708).

Many other varieties might be described did space permit; but we must be content with adding that the form and arrangement of the teeth of these 'palates' afford characters of great value in classification, as was first pointed out by Professor Lovén (of Stockholm) in 1847, and has been since very strongly urged by Dr. J. E. Gray, who considers that the structure of these organs is one of the best guides to the natural affinities of the species, genera, and families of this group, since any important alteration in the form or position of the teeth must be accompanied by some corresponding peculiarity in the habits and food of the animal.¹ Hence a systematic examination and delineation of the structure and arrangement of these organs, by the aid of the microscope and camera lucida, would be of the greatest service to this department of natural history. The short thick tube

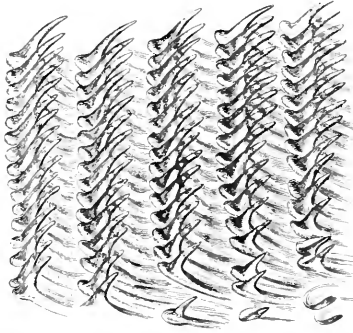

FIG. 708.—Palate of *Doris tuberculata*.

of *Limax* and other terrestrial Gastropods appears adapted for the trituration of the food previously to its passing into the oesophagus; for in these animals we find the roof of the mouth furnished with a large strong horny plate, against which the flat end of the tongue can work. On the other hand, the flattened portion of the palate of *Buccinum* (whelk) and its allies is used by these animals as a file, with which they bore holes through the shells of the molluscs that serve as their prey; this

they are enabled to effect by everting that part of the proboscis-shaped mouth whose floor is formed by the flattened part of the tube, which is thus brought to the exterior, and by giving a kind of sawing motion to the organ by means of the alternate action of two pairs of muscles—a protractor and a retractor—which put forth and draw back a pair of cartilages whereon the tongue is supported, and also elevate and depress its teeth. The use of the long blind tubular part of the palate in these Gastropods is that of a 'cavity of reserve,' from which a new toothed surface may be continually supplied as the old one is worn away—somewhat as the front teeth of the rodents are constantly being regenerated from the surface of the pulps which occupy their hollow conical bases—as fast as they are rubbed down at their edges, or as a nail is constantly being worn away at its free end, and fashioned anew in its 'bed.'

The preparation of these palates for the microscope can, of course, be only accomplished by carefully dissecting them from their attachments within the head; and it will be also necessary to remove the membrane that forms the sheath of the tube, when this is thick

¹ *Ann. Nat. Hist.*, ser. ii, vol. x, 1852, p. 413.

enough to interfere with its transparence. The tube itself should be slit up with a pair of fine scissors through its entire length, and should be so opened out that its expanded surface may be a continuation of that which forms the floor of the mouth. The mode of mounting it will depend upon the manner in which it is to be viewed. For the ordinary purposes of microscopic examination no method is so good as mounting in fluid, either weak spirit or Goadby's solution answering very well. But many of these palates, especially those of the marine Gastropods, become most beautiful objects for the polariscope when they are mounted in Canada balsam, the form and arrangement of the teeth being very strongly brought out by it (fig. 709), and a gorgeous play of colours being exhibited when a selenite plate is placed behind the object, and the analysing prism is made to rotate.¹

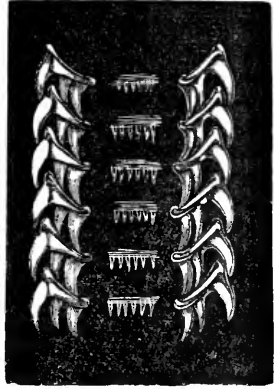

FIG. 709.—Palate of *Buccinum undatum* as seen under polarised light.

Development of Molluscs.—Leaving to the scientific embryologist the large field of study that lies open to him in this direction,² the ordinary microscopist will find much to interest him in the observation of certain special phenomena of which a general account will be here given. Attached to the gills of fresh-water mussels (*Unio* and *Anodon*) there are often found in the spring or early summer minute bodies which, when first observed, were described as parasites, under the name of *Glochidia*, but are now known to be their own progeny in an early phase of development. When they are expelled from between the valves of their parent, they attach themselves in a peculiar manner to the fins and gills of fresh-water fish. In this stage of the existence of the young *Anodon*, its valves are provided with curious barbed or serrated hooks (fig. 710, A), and are continually snapping together, until they have inserted their hooks into the skin of the fish, which seems so to retain the barbs as to prevent the reopening of the valves. In this stage of its existence no internal organ is definitely formed, except the strong 'adductor' muscle (*aad*) which draws the valves together, and the long, slender byssus-filament (*by*) which makes its appearance while the embryo is still within the egg-membrane, lying coiled up between the lateral lobes. The hollow of each valve is filled with a soft granular-looking mass, in which are to be distinguished what are perhaps the rudiments of the

¹ For additional details on the organisation of the palate and teeth of the Gastropod molluscs, see Mr. W. Thomson in *Cyclop. Anat. and Physiol.* vol. iv. pp. 1142, 1143, and in *Ann. Nat. Hist.* ser. ii. vol. vii. p. 86; Professor Troschel, *Das Gebiss der Schnecken*, Berlin, 1856-79; A. Rücker, 'Ueber die Bildung der Radula bei *Helix pomatia*,' *Bericht oberhess. Gesellsch. Giessen*, xxii. p. 209; P. Geddes, 'On the Mechanism of the Odontophore in certain Molluscs,' *Trans. Zool. Soc.* x. p. 485.

² See Balfour's *Comparative Embryology*, vol. i. chap. ix. More recent text-books of embryology, such as that of Professor Korschelt and Heider, need not here be specifically cited.

branchiæ and of oral tentacles; but their nature can only be certainly determined by further observation, which is rendered difficult by the opacity of the valves. By keeping a supply of fish, however, with these embryos attached, the entire history of the development of the fresh-water mussel may be worked out.¹

In certain members of the class *Gastropoda* the history of embryonic development presents numerous phenomena of great interest. The eggs (save among the terrestrial species) are usually deposited in aggregate masses, each inclosed in a common protective envelope or *nidamentum*. The nature of this envelope, however, varies greatly; thus, in the common *Limnæus stagnalis*, or 'water-snail,' of our ponds and ditches it is nothing else than a mass of soft jelly, about the size of a sixpence, in which from fifty to sixty eggs are imbedded, and which is attached to the leaves or stems of aquatic plants; in the *Buccinum undatum*, or common whelk, it is a membranous case,

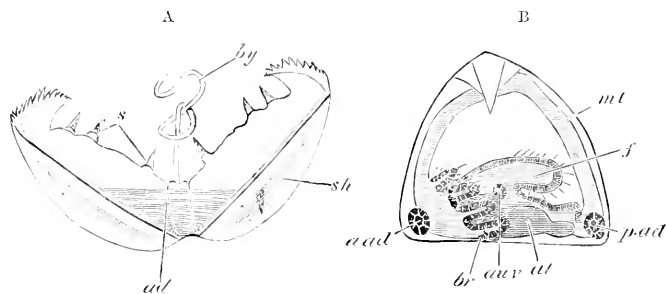

FIG. 710.—A, Glochidium immediately after it is hatched: *ad*, adductor; *sh*, shell; *by*, byssus-cord; *s*, sense-organs. B, the same after it has been on the fish for some weeks: *br*, branchiæ; *aur*, auditory sac; *f*, food; *aad* and *pad*, anterior and posterior adductors; *al*, mesenteron; *mt*, mantle.

connected with a considerable number of similar cases by short stalks, so as to form large globular masses which may often be picked up on our shores, especially between April and June; in the *Purpura lapillus*, or 'rock-whelk,' it is a little flask-shaped capsule, having a firm horny wall, which is attached by a short stem to the surface of rocks between tide marks, great numbers being often found standing erect side by side; whilst in the Nudibranchiate order generally (consisting of the *Doris*, *Eolis*, and other 'sea-slugs') it forms a long tube with a membranous wall, in which immense numbers of eggs (even half a million or more) are packed closely together in the midst of a jelly-like substance, this tube being disposed in coils of various forms, which are usually attached to seaweeds or zöophytes. The course of development, in the first and last of these instances, may be readily observed from the very earliest period down

¹ See the Rev. W. Houghton, 'On the Parasitic Nature of the Fry of the *Anodonta cygnea*,' in *Quart. Journ. Microsc. Sci.* n.s. vol. ii. 1861, p. 162, and especially Balfour, *op. cit.* pp. 220-223. On the embryonal byssus-gland of *Anodonta*, see J. Carrière, *Zöolog. Anzeig.* vii. p. 41.

to that of the emersion of the embryo, owing to the extreme transparency of the nidamentum and of the egg-membranes themselves. The first change which will be noticed by the ordinary observer is the 'segmentation' of the yolk-mass, which divides itself (after the manner of a cell undergoing binary subdivision) into two parts, each of these two into two others, and so on until a *morula*, or mulberry-like mass of minute yolk-segments, is produced (fig. 711. A-F), which is converted by 'invagination' into a 'gastrula,' whose form

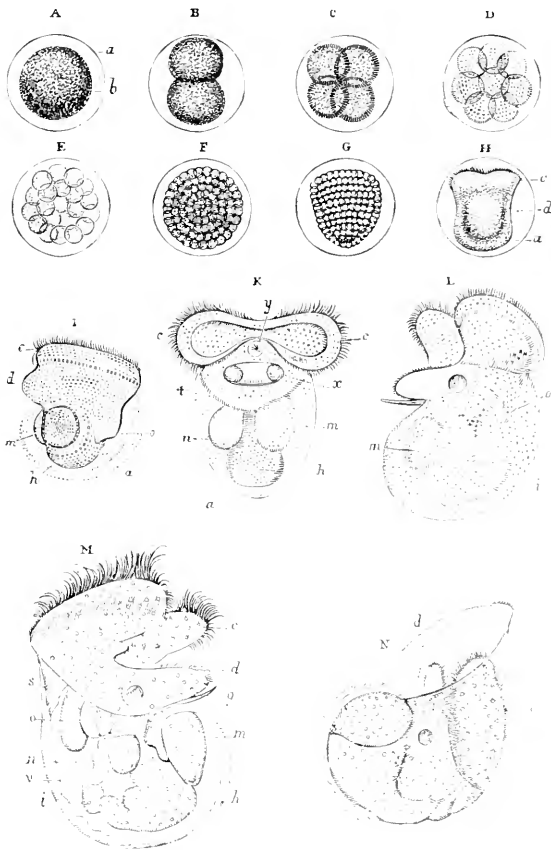

FIG. 711.—Embryonic development of *Doris balamellata*: A, ovum, consisting of enveloping membrane, *a*, and yolk, *b*; B, C, D, E, F, successive stages of segmentation of yolk; G, first marking out of the shape of the embryo; H, embryo on the eighth day; I, the same on the ninth day; K, the same on the twelfth day, seen on the left side at L; M, still more advanced embryo, seen at N as retracted within its shell: *a*, position of shell-gland; *c, c*, ciliated lobes; *d*, foot; *g*, hard plate or operculum attached to it; *h*, stomach; *i*, intestine; *m, n*, masses (glandular?) at the sides of the oesophagus; *o*, heart (?); *s*, retractor muscle (?); *t*, situation of funnel; *v*, membrane enveloping the body; *x*, auditory vesicles; *y*, mouth.

is shown at G. This 'gastrula' soon begins to exhibit a very curious alternating rotation within the egg, two or three turns being made in one direction, and the same number in a reverse direction: this movement is due to the cilia fringing a sort of fold of the ectoderm termed the *velum*, which afterwards usually gives origin to a pair of large ciliated lobes (H-L, *c*) resembling those of Rotifers. The velum is so little developed in *Limnaeus*, however, that its existence was commonly overlooked until recognised by Professor Ray Lankester,¹ who also has been able to distinguish its fringe of minute cilia. This, however, has only a transitory existence; and the later rotation of the embryo, which presents a very curious spectacle when a number of ova are viewed at once under a low magnifying power, is due to the action of the cilia fringing the head and foot.

A separation is usually seen at an early period between the anterior or 'cephalic' portion, and the posterior or 'visceral' portion, of the embryonic mass, and the development of the former advances with the greater activity. One of the first changes which are seen in it consists in its extension into a sort of fin-like membrane on either side, the edges of which are fringed with long cilia (fig. 711, H-L, *c*), whose movements may be clearly distinguished whilst the embryo is still shut up within the egg; at a very early period may also be discerned the 'auditory vesicles' (K, *x*) or rudimentary organs of hearing, which scarcely attain any higher development in these creatures during the whole of life; and from the immediate neighbourhood of these is put forth a projection, which is afterwards to be evolved into the 'foot' or muscular disc of the animal. While these organs are making their appearance, the shell is being formed on the surface of the posterior portion, appearing first as a thin covering over its hinder part and gradually extending itself until it becomes large enough to inclose the embryo completely, when this contracts itself. The ciliated lobes are best seen in the embryos of Nudibranchs; and the fact of the universal presence of a shell in the embryos of that group is of peculiar interest, as it is destined to be cast off very soon after they enter upon active life. These embryos may be seen to move about, as freely as the narrowness of their prison permits, for some time previous to their emersion; and when set free by the rupture of the egg-cases they swim forth with great activity by the action of their ciliated lobes—these, like the 'wheels' of Rotifera, serving also to bring food to the mouth, which is at that time unprovided with the reducing apparatus subsequently found in it. The same is true of the embryo of *Limnaeus*, save that its swimming movements are less active, in consequence of the non-development of the ciliated lobes; and the currents produced by the cilia that fringe the head and the orifice of the respiratory sac seem to have reference chiefly to the provision of supplies of food and of aerated water for respira-

¹ See his valuable 'Observations on the Development of *Limnaeus stagnalis* and on the early stages of other Mollusca' in *Quart. Journ. Microsc. Sci.* October 1874; and 'On the Developmental History of the Mollusca,' *Phil. Trans.* 1875. See also Lereboullet, 'Recherches sur le Développement du *Limnée*,' in *Ann. des Sci. Nat. Zool.* 4^e série, tom. xviii, p. 47.

tion. The disappearance of the cilia has been observed by Mr. Hogg to be coincident with the development of the teeth to a degree sufficient to enable the young water-snail to crop its vegetable food; and he has further ascertained that if the growing animal be kept in fresh water alone for some time, without vegetable matter of any kind, the gastric teeth are very imperfectly developed, and the cilia are still retained.¹

A very curious modification of the ordinary plan of development is presented in *Purpura lapillus*, and it is probable that something of the same kind exists also in *Buccinum*, as well as in other Gastropods of the same extensive order (*Pectinibranchiata*). Each of the capsules already described contains from 500 to 600 egg-like bodies (fig. 712, A) imbedded in a viscid gelatinous substance; but only from twelve to thirty embryos usually attain complete development, and it is obvious, from the large comparative size which these attain (fig. 713, B), that each of them must include an amount of substance equal to that of a great number of the bodies originally found within the capsule. The explanation of this fact (long since noticed by Dr. J. E. Gray in regard to *Buccinum*) seems to be as follows. Of those 500 or 600 egg-like bodies, only a small part are fertile *ova*, the remainder being unfertilised eggs, the yolk material of which serves for the nutrition of the embryos in the later stages of their intracapsular life. The distinction between them manifests itself at a very early period, even in the first segmentation; for, while the latter

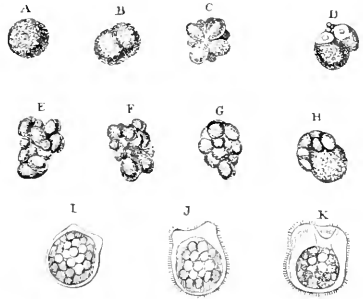

FIG. 712.—Early stages of embryonic development of *Purpura lapillus*: A, egg-like spherule; B, C, E, F, G, successive stages of segmentation of yolk-spherules; D, H, I, J, K, successive stages of development of early embryos.

divide into two equal hemispheres (fig. 712, B), the fertilised *ova* divide into a larger and a smaller segment (D); in the cleft between these are seen the minute 'directive vesicles,' which appear to be always double, although from being seen 'end on,' only one may be visible; and near these is generally to be seen a clear space in each segment. The difference is still more strongly marked in the subsequent divisions; for whilst the cleavage of the infertile eggs goes on irregularly, so as to divide each into from fourteen to twenty segments, having no definiteness of arrangement (C, E, F, G), that of the fertile *ova* takes place in such a manner as to mark out the distinction already alluded to between the 'cephalic' and the 'visceral' portions of the mass (H), and the evolution of the former into distinct organs very speedily commences. In the first instance a narrow transparent border is seen around the whole embryonic mass, which is broader at the cephalic portion (I); next,

¹ See *Trans. Microsc. Soc.* ser. ii. vol. ii. 1854, p. 93.

this border is fringed with short cilia, and the cephalic extension into two lobes begins to show itself; and then between the lobes a large mouth is formed, opening through a short wide œsophagus, the interior of which is ciliated, into the visceral cavity, occupied as yet only by the yolk-particles originally belonging to the ovum (K).

Whilst these developmental changes are taking place in the embryo, the whole aggregate of segments formed by the yolk-cleavage of the infertile eggs coalesces into one mass, as shown at A, fig. 713; and the embryos are often, in the first instance, so completely buried within this as only to be discoverable by tearing its portions asunder; but some of them may commonly be found upon its exterior, and those contained in one capsule very commonly exhibit the different

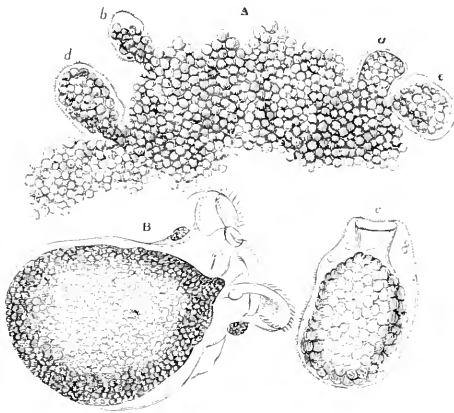

FIG. 713.—Later stages of embryonic development of *Purpura lapillus*. A, conglomerate mass of vitelline segments, to which were attached the embryos *a*, *b*, *c*, *d*, *e*. B, full-sized embryo in more advanced stage of development.

stages of development represented in fig. 712, H-K. After a short time, however, it becomes apparent that the most advanced embryos are beginning to swallow the yolk segments of the conglomerate mass, and capsules will not unfrequently be met with in which embryos of various sizes, as *a*, *b*, *c*, *d*, *e* (fig. 713, A), are projecting from its surface, their difference of size not being accompanied by advance in development, but merely depending upon the amount of this supplemental yolk which the embryos have respectively gulped down. For during the time in which they are engaged in appropriating this additional supply of nutriment, although they increase in size, yet they scarcely exhibit any other change; so that the large embryo, fig. 713, *e*, is not apparently more advanced, as regards the formation of its organs, than the small embryo, fig. 712, K. So soon as this operation has been completed, however, and the embryo has attained its full bulk, the evolution of its organs takes place very rapidly; the

ciliated lobes are much more highly developed, being extended in a long sinuous margin, so as almost to remind the observer of the 'wheels' of Rotifera, and being furnished with very long cilia (fig. 713, B); the auditory vesicles, the tentacula, the eyes, and the foot successively make their appearance; a curious rhythmically contractile vesicle is seen, just beneath the edge of the shell in the region of the neck, which may, perhaps, serve as a temporary heart; a little later the real heart may be seen pulsating beneath the dorsal part of the shell; and the mass of yolk-segments of which the body is made up gradually shapes itself into the various organs of digestion, respiration, &c., during the evolution of which (and while they are as yet far from complete) the capsule thins away at its summit and the embryos make their escape from it.¹

It happens not unfrequently that one of the embryos which a capsule contains does not acquire its 'supplemental' yolk in the manner now described, and can only proceed in its development as far as its original yolk will afford it material; and thus, at the time when the other embryos have attained their full size and maturity, a strange-looking creature, consisting of two large ciliated lobes with scarcely the rudiment of a body, may be seen in active motion among them. This may happen, indeed, not only to one, but to several embryos within the same capsule, especially if their number should be considerable; for it sometimes appears as if there were not food enough for all, so that, whilst some attain their full dimensions and complete development, others remain of unusually small size, without being deficient in any of their organs; and others, again, are more or less completely abortive—the supply of supplemental yolk which they have obtained having been too small for the development of their viscera, although it may have afforded what was needed for that of the ciliated lobes, eyes, tentacles, auditory vesicles, and even the foot—or, on the other hand, no additional supply whatever having been acquired by them, so that their development has been arrested at a still earlier stage. These phenomena are of so remarkable a character that they furnish an abundant source of interest to any microscopist who may happen to be spending the months of August and September in a locality in which the *Purpura* abounds; since, by opening a sufficient number of capsules, no difficulty need be experienced in arriving at all the facts which have been noticed in this brief summary.² It is much to be desired that such microscopists

¹ The Author thinks it worth while to mention the method which he has found most convenient for examining the contents of the egg-capsules of *Purpura*, as he believes that it may be advantageously adopted in many other cases. This consists in cutting off the two ends of the capsule (taking care not to cut far into its cavity), and in then forcing a jet of water through it by inserting the end of a fine-pointed syringe into one of the orifices thus made, so as to drive the contents of the capsule before it through the other. These should be received into a shallow cell and first examined under the simple microscope. For some further observations on the development of *Purpura*, see Professor Haddon, 'Notes on the Development of the Mollusca,' *Quart. Journ. Microsc. Sci.* xxii. p. 367.

² Fuller details on this subject will be found in the Author's account of his researches in *Trans. Microsc. Soc.* ser. ii. vol. iii. 1855, p. 17. His account of the process was called in question by MM. Koren and Danielssen, who had previously given an entirely different version of it, but was fully confirmed by the observations of Dr. Dyster. See *Ann. Nat. Hist.* ser. ii. vol. xx. 1857, p. 16. The independent

as possess the requisite opportunity would apply themselves to the study of the corresponding history in other Pectinibranchiate Gastropods, with a view of determining how far the plan now described prevails through the order. And now that these molluscs have been brought not only to live, but to breed, in artificial aquaria, it may be anticipated that a great addition to our knowledge of this part of their life-history will ere long be made.

Ciliary Motion on Gills.—There is no object that is better suited to exhibit the general phenomena of ciliary motion than a portion of the gill of some bivalve mollusc. The *Oyster* will answer the purpose sufficiently well; but the cilia are much larger on the gills of the *Mussel* (*Mytilus*),¹ as they are also on those of the *Anodon* or common ‘fresh-water mussel’ of our ponds and streams. Nothing more is necessary than to detach a small portion of one of the ribbon-like bands which will be seen running parallel with the edge of each of the valves when the shell is opened, and to place this, with a little of the liquor contained within the shell, upon a slip of glass—taking care to spread it out sufficiently with needles to separate the bars of which it is composed, since it is on the edges of these, and round their knobbed extremities, that the ciliary movement presents itself—and then covering it with a thin glass disc. Or it will be convenient to place the object in the aquatic box, which will enable the observer to subject it to any degree of pressure that he may find convenient. A magnifying power of about 120 diameters is amply sufficient to afford a general view of this spectacle; but a much greater amplification is needed to bring into view the peculiar mode in which the stroke of each cilium is made. Few spectacles are more striking to the unprepared mind than the exhibition of such wonderful activity as will then become apparent in a body which to all ordinary observation is so inert. This activity serves a double purpose; for it not only drives a continual current of water over the surface of the gills themselves, so as to effect the aëration of the blood, but also directs a portion of this current to the mouth, so as to supply the digestive apparatus with the aliment afforded by the *Diatomaceæ*, *Infusoria*, &c. which it carries in with it.

Organs of Sense of Molluscs.—Some of the minuter and more rudimentary forms of the special organs of sight, hearing, and touch which the molluscan series presents are very interesting objects of microscopic examination. Thus, just within the margin of each valve of *Pecten*, we see (when we observe the animal in its living state under water) a row of minute circular points of great brilliancy, each surrounded by a dark ring: these are the eyes with which this creature is provided, and by which its peculiarly active movements are directed. Each of them, when their structure is carefully examined, is found to be protected by a sclerotic coat with a transparent

observations of M. Claparède on the development of *Neritina fluvialtilis* (Müller's *Archiv*, 1857, p. 109, and abstract in *Ann. of Nat. Hist.* ser. ii. vol. xx. 1857, p. 196) showed the mode of development in that species to be the same in all essential particulars as that of *Parpura*. The subject has again been recently studied with great minuteness by Selenka, *Niederländisches Archiv für Zoologie*, Bd. i. July 1862.

¹ This shellfish may be obtained, not merely at the seaside, but likewise at the shops of the fishmongers who supply the humbler classes, even in Midland towns.

cornea in front, and to possess a coloured iris (having a pupil) that is continuous with a layer of pigment lining the sclerotic, a crystalline lens and vitreous body, and a retinal expansion proceeding from an optic nerve which passes to each eye from the trunk that runs along the margin of the mantle.¹ Professor H. N. Moseley made the interesting discovery that many of the *Chitonidae* are provided with a large number of minute eyes on the exposed areas of the outer surfaces of their shells: as the fibres of the optic nerve are directed to the rods from behind these eyes are of the ordinary invertebrate type, and differ therein from the just mentioned eyes of *Pecten*, or those which are found on the back of *Onchidium*, which resemble the vertebrate retina in having the optic fibres inserted into the front aspect of the layer of rods.² Eyes of still higher organisation are borne upon the head of most Gastropod molluscs, generally at the base of one of the pairs of tentacles, but sometimes, as in the *Suaia* and *Slug*, at the points of these organs. In the latter case the tentacles are furnished with a very peculiar provision for the protection of the eyes: for when the extremity of either of them is touched it is drawn back into the basal part of the organ, much as the finger of a glove may be pushed back into the palm. The retraction of the tentacle is accomplished by a strong muscular band, which arises within the head and proceeds to the extremity of the tentacles; whilst its protrusion is effected by the agency of the circular bands with which the tubular wall of the tentacle is itself furnished, the inverted portion being (as it were) squeezed out by the contraction of the lower part into which it has been drawn back. The structure of the eyes and the curious provision just described may easily be examined by snipping off one of the eye-bearing tentacles with a pair of scissors. None but the Cephalopod molluscs have distinct organs of hearing; but rudiments of such organs may be found in most Gastropods (fig. 711, K. *v.*), attached to some part of the nervous collar that surrounds the œsophagus, and even in many bivalves, in connection with the nervous ganglion imbedded in the base of the foot. These 'auditory vesicles,' as they are termed, are minute sacculi, each of which contains a fluid, wherein are suspended a number of minute calcareous particles (named *otoliths*, or ear-stones), which are kept in a state of continual movement by the action of cilia lining the vesicles. This 'wonderful spectacle,' as it was truly designated by its discoverer Siebold, may be brought into view without any dissection by submitting the head of any small and not very thick-skinned Gastropod, or the young of the larger forms, to gentle compression under the microscope and transmitting a strong light through it. The very early appearance of the auditory vesicles in the embryo Gastropod has been already alluded to. Those who have the opportunity of examining young specimens of the common *Pecten* will find it extremely interesting to watch the action of the

¹ See Mr. S. J. Hickson on 'The Eye of *Pecten*' in *Quart. Journ. Microsc. Sci.* vol. xx. n.s. 1880, p. 443, and K. E. Schreiner, 'Die Augen bei *Pecten* und *Lima*,' *Bergens Mus. Aarbog*, 1896, no. 1.

² See Professor Moseley 'On the Presence of Eyes in the Shells of certain *Chitonidae* and on the Structure of these Organs,' in *Quart. Journ. Microsc. Sci.* xxv. p. 37.

very delicate tentacles which they have the power of putting forth from the margin of their mantle, the animal being confined in a shallow cell, or in the zöophyte trough; and if the observer should be fortunate enough to obtain a specimen so young that the valves are quite transparent, he will find the spectacle presented by the ciliary movement of the gills, as well as the active play of the foot (of which the adult can make no such use), to be worthy of more than a cursory glance.¹

Chromatophores of Cephalopods.—Almost any species of cuttlefish (*Sepia*) or squid (*Loligo*) will afford the opportunity of examining the very curious provision which their skin contains for changing its hue. This consists in the presence of numerous large ‘pigment-cells,’ containing colouring matter of various tints, the prevailing colour, however, being that of the fluid of the ink-bag. These pigment-cells may present very different forms, being sometimes nearly globular, whilst at other times they are flattened and extended into radiating prolongations; and, by the peculiar contractility with which they are endowed, they can pass from one to the other of these conditions, so as to spread their coloured contents over a comparatively large surface, or to limit them within a comparatively small area. Very commonly there are different layers of these pigment-cells, their contents having different hues in each layer; and thus a great variety of coloration may be given by the alteration in the form of the cells of which one or another layer is made up. It is curious that the changes in the hue of the skin appear to be influenced, as in the case of the chameleon, by the colour of the surface with which it may be in proximity. The alternate contractions and extensions of these pigment-cells, or *chromatophores*, may be easily observed in a piece of skin detached from the living animal and viewed as a transparent object, since they will continue for some time if the skin be placed in sea-water. And they may also be well seen in the embryo cuttlefish, which will sometimes be found in a state of sufficient advancement in the grape-like eggs of these animals attached to sea-weeds, zöophytes, &c. The eggs of the small cuttlefish termed the *Sepiola*, which is very common on our southern coasts, are imbedded, like those of the *Doris*, in gelatinous masses which are attached to seaweeds, zöophytes, &c.; and their embryos, when near maturity, are extremely beautiful and interesting objects, being sufficiently transparent to allow the action of the heart to be distinguished, as well as to show most advantageously the changes incessantly occurring in the form and hue of the ‘chromatophores.’²

¹ Much valuable information concerning the sensory organs of molluscs will be found in Dr. H. Simroth's memoir, ‘Ueber die Sinneswerkzeuge unserer einheimischen Weichthiere,’ *Zeitschr. für wiss. Zöol.* xxvi. p. 227.

² For further information regarding the chromatophores see an essay by Dr. Klemensiewicz in the *Sitzungsberichte* of the Vienna Academy, vol. lxxviii. p. 7, and Krukenberg, *Vergl. physiol. Studien*, 1880.

The following works and memoirs on the Mollusca generally may be consulted by the student: S. P. Woodward, *A Manual of the Mollusca*, 3rd ed. London, 1875; Keferstein, in Bronn's *Klassen und Ordnungen des Thierreichs*; the article ‘Mollusca,’ by Professor Ray Lankester, in the 9th edition of the *Encyclopædia Britannica*; M. P. Fischer's *Manuel de Conchyliologie*, Paris, 1881-87; and the Rev. A. H. Cooke's volume in the *Cambridge Natural History*; as well as the numerous reports on the Mollusca collected by H.M.S. *Challenger*.

CHAPTER XIX

WORMS

UNDER the general designation of Worms many naturalists still group a number of Metazoa, which differ considerably among themselves, and exhibit on the one hand very simple, and on the other somewhat complex plans of organisation; the assemblage is, indeed, hardly anything else than a zoological lumber-room, from which, with the progress of research, group after group may be expected to be removed. Among others there are included in it the *Entozoa* or intestinal worms, the *Rotifera* or wheel-animalcules, *Turbellaria*, and *Annulata*, each of which furnishes many objects for microscopic examination that are of the highest scientific interest. As our business, however, is less with the professed morphologist than with the general inquirer into the minute wonders and beauties of Nature, we shall pass over these classes (the *Rotifera* having been already treated of in detail, Chapter XIII) with only a notice of such points as are likely to be specially deserving the attention of observers of the latter order.

Entozoa.—This term is one which has been applied to such worms as are parasitic within the bodies of other animals, and which obtain their nutriment by the absorption of the juices of these, thus bearing a striking analogy to the parasitic Fungi.¹ The most remarkable feature in their structure consists in the entire absence or the extremely low development of their nutritive system, and the extraordinary development of their reproductive apparatus. Thus in the common *Tenia* ('tape-worm'), which may be taken as the type of the Cestoid group, there is neither mouth nor stomach, the so-called 'head' being merely an organ for attachment, whilst the segments of the 'body' contain repetitions of a complex generative apparatus, the male and female sexual organs being so united in each as to enable it to fertilise and bring to maturity its own very numerous eggs; and the chief connection between these segments is established by two pairs of longitudinal canals, which appear to represent the 'water-vascular system,' whose simplest condition has been noticed in the wheel-animalcule. Few among the striking results of microscopic inquiry have been more curious than the elucidation of the real nature of the bodies formerly denominated *cystic* Entozoa, which

¹ The most important work on human entozoic parasites is that by Professor Leuckart, *Die menschlichen Parasiten*, of which a second edition is now in course of publication; of this the first portion has been translated into English by Mr. W. E. Hoyle.

had been previously ranked as a distinct group. These are not found, like the preceding, in the cavity of the alimentary canal of the animals they infest, but always occur in the substance of solid organs, such as the glands, muscles, &c. They present themselves to the eye as bags or vesicles of various sizes, sometimes occurring singly, sometimes in groups; but upon careful examination each vesicle is found to bear upon some part a 'head' furnished with hooklets and suckers; and this may be either single, as in *Cysticercus* (the entozöon whose presence gives to pork what is known as the 'measly' disorder), or multiple, as in *Coenurus*, which is developed in the brain, chiefly of sheep, where it gives rise to the disorder known as 'the staggers.' Now, in none of these cystic forms has any generative apparatus ever been discovered, and hence they are obviously to be considered as imperfect animals. The close resemblance between the 'heads' of certain *Cysticerci* and that of certain *Tenia* first suggested that the two might be different states of the same animal; and experiments made by those who have devoted themselves to the working out of this curious subject have led to the assured conclusion that the cystic Entozoa are nothing else than cestoid worms, whose development has been modified by the peculiarity of their position, the large bag being formed by a sort of dropsical accumulation of fluid when the young are evolved in the midst of solid tissues; whilst the very same bodies, conveyed into the alimentary canal of some carnivorous animal which has fed upon the flesh infested with them, begin to bud forth the generative segments, the long succession of which, united end to end, gives to the entire series a band-like aspect.

Other forms of Entozoa belong to the *Nematoid* or thread-like order—of which the common *Ascaris* may be taken as a type; one species of this (the *A. lumbricoides* or 'round worm') is a common parasite in the small intestine of man, while another (the *Oxyuris vermicularis* or 'thread-worm') is found rather in the lower bowel—and they are much less profoundly degraded in their organisation; they have a distinct alimentary canal, which commences with a mouth at the anterior extremity of the body, and which terminates by an anal orifice near the other extremity; and they also possess a regular arrangement of circular and longitudinal muscular fibres by which the body can be shortened, elongated, or bent in any direction. The smaller Nematode worms, by some or other of which almost every vertebrated animal is infested, are so transparent that every part of their internal organisation may be made out, especially with the assistance of the compressor, without any dissection; and the study of the structure and actions of their generative apparatus has yielded many very interesting results, especially in regard to the first formation of the ova, the mode of their fertilisation, and the history of their subsequent development.¹ Some of the worms belonging to this group are not parasitic in the bodies of other animals, but live in the midst of dead or decomposing vegetable matter. Others, such as *Gordius* or the 'hair-worm,' are parasitic for the greater part of

¹ See particularly the various recent memoirs of Van Beneden and of Boveri, based on a study of *Ascaris megalocephala*.

their existence, but leave their host for the purpose of maturing their generative products; in these later stages the *Gordius* is frequently found in large knot-like masses (whence its name) in the water or mud of the pools inhabited by the insects in which the earlier stages were passed. The *Anguillulae* are little eel-like worms, of which one species, *A. fluviatilis*, is very often found in fresh water amongst *Desmidiæ*, *Confervæ*, &c., also in wet moss and moist earth, and sometimes also in the alimentary canals of snails, frogs, fishes, insects, and larger worms; whilst an allied species, *Tylenchus tritici*, is met with in the ears of wheat affected with the blight termed the 'cockle'; another, the *A. glutinis* (*A. aceti*), is found in sour paste, and was often found in stale vinegar, until the more complete removal of mucilage and the addition of sulphuric acid, in the course of the manufacture, rendered this liquid a less favourable 'habitat' for these little creatures. A writhing mass of any of these species of 'eels' is one of the most curious spectacles which the microscopist can exhibit to the unscientific observer; and the capability which they all possess (in common with Rotifers and Tardigrades) of revival after desiccation, at a very remote interval, enables him to command the spectacle at any time. A grain of wheat within which these worms (often erroneously called *Vibriones*) are being developed gradually assumes the appearance of a black peppercorn; and if it be divided the interior will be found almost completely filled with a dense white cottony mass, occupying the place of the flour, and leaving merely a small place for a little glutinous matter. The cottony substance seems to the eye to consist of bundles of fine fibres closely packed together; but on taking out a small portion, and putting it under the microscope with a little water under a thin glass cover, it will be found after a short time (if not immediately) to be a wriggling mass of life, the apparent fibres being really *Anguillulae* or 'eels' of the microscopist. If the seeds be soaked in water for a couple of hours before they are laid open, the eels will be found in a state of activity from the first; their movements, however, are by no means so energetic as those of the *A. glutinis*, or 'paste eel.' This last frequently makes its appearance spontaneously in the midst of paste that is turning sour; but the best means of securing a supply for any occasion consists in allowing a portion of any mass of paste in which they may present themselves to dry up, and then, laying this by so long as it may not be wanted, to introduce it into a mass of fresh paste, which if it be kept warm and moist will be found after a few days to swarm with these curious little creatures.

Besides the foregoing orders of Entozoa, the *Trematode* group, which is more closely allied to the *Cestoda* than to the Nematodes, must be named; of this the *Distoma hepaticum*, or 'flake,' found in the livers of sheep affected with the 'rot,' is a typical example. Into the details of the structure of this animal, which has the general form of a sole, there is no occasion for us here to enter; it is remarkable, however, for the branching form of its digestive cavity, which extends throughout almost the entire body, very much as in the allied *Planaria* (fig. 714); and also for the curious

phenomena of its development, several distinct forms being passed through between one sexual generation and another. These have been especially studied in the Distoma, which infests *Paludina*, the ova of which are not developed into the likeness of their parents, but into minute worm-like bodies, which seem to be little else than masses of cells inclosed in a contractile integument, no formed organs being found in them; these cells, in their turn, are developed into independent larvæ, which escape from their containing cyst in the condition of free ciliated animalcules; in this condition they remain for some time, and then imbed themselves in the mucus that covers the tail of the mollusc, in which they undergo a gradual development into true Distomata; and having thus acquired their perfect form, they penetrate the soft integument, and take up their habitation in the interior of the body. Thus a considerable number of Distomata may be produced from a single ovum by a process of cell-multiplication in an early stage of its development. In some instances the free ciliated larvæ are provided with pigment-spots or rudimentary optic organs, although these organs are wanting in the fully developed Distoma, the peculiar 'habitat' of which would render them useless.¹

Turbellaria.—This group of animals, which is distinguished by the presence of cilia over the entire surface of the body, contains forms which are among the simplest of those in which the Metazoic organisation obtains. It deserves special notice here chiefly on account of the frequency with which the worms of the Planarian tribe present themselves among collections both of marine and of fresh-water animals (particular species inhabiting either locality) and on account of the curious organisation which many of these possess. Most of the members of this tribe have elongated, flattened bodies, and move by a sort of gliding or crawling action over the surfaces of aquatic plants and animals. Some of the smaller kinds are sufficiently transparent to allow of their internal structure being seen by transmitted light, especially when they are slightly compressed; and the opposite figure (fig. 714) displays the general conformation of their principal organs as thus shown. The body has the flattened sole-like shape of the Trematode Entozoa; its mouth, which is situated at a considerable distance from the anterior extremity of the body, is surrounded by a circular sucker that is applied to the living surface from which the animal draws its nutriment; and the buccal cavity (*b*) opens into a short œsophagus (*c*) which leads at once to the cavity of the stomach. This cavity does not give origin to any intestinal tube, nor is it provided with any second orifice; but a large number of ramifying canals are prolonged from it, which carry its contents into every part of the body. This seems to render unnecessary any system of vessels for the circulation of nutritive fluid; and the two principal trunks, with connecting and ramifying branches, which may be observed in them may be

¹ On the development and life-history of the 'Liver-fluke' see Professor A. P. Thomas, *Quart. Journ. Microsc. Sci.* xxiii. p. 1; and R. Leuckart, *Archiv für Naturgesch.* xlviii. p. 80. On its anatomy, see Dr. F. Sommer, *Zeitschr. für wiss. Zööl.* xxxiv.

regarded in the light of a gastro-vascular system, the function of which is not only digestive, but also circulatory. Both sets of sexual organs are combined in the same individuals, though the congress of two, each impregnating the ova of the other, seems to be generally necessary. The ovaria, as in the Entozoa, extend through a large part of the body, their ramifications proceeding from the two oviducts (*k, k*), which have a dilatation (*l*) at their point of junction. The *Planaria*¹ do not multiply by eggs alone; for they occasionally undergo spontaneous fission in a transverse direction, each segment becoming a perfect animal; and an artificial division into two or even more parts may be practised with a like result. In fact, the power of the *Planaria* to reproduce portions which have been removed seems but little inferior to that of the *Hydra*; a circumstance which is peculiarly remarkable when the much higher character of their organisation is borne in mind. They possess a distinct pair of nervous ganglia (*f, f*), from which branches proceed to various parts of the body; and in the neighbourhood of these are usually to be observed a number (varying from two to forty) of *ocelli* or rudimentary eyes, each having its refracting body or crystalline lens, its pigment-layer, its nerve-bulb, and its cornea-like bulging of the skin. The integument of many of these animals is furnished with cells containing rods or spindles which are very possibly comparable to the 'thread-cells' of zoöphytes.²

Annulata.—This class includes all the higher kinds of worm-like animals, the greater part of which are marine, though there is one well-marked group the members of which inhabit fresh water or live

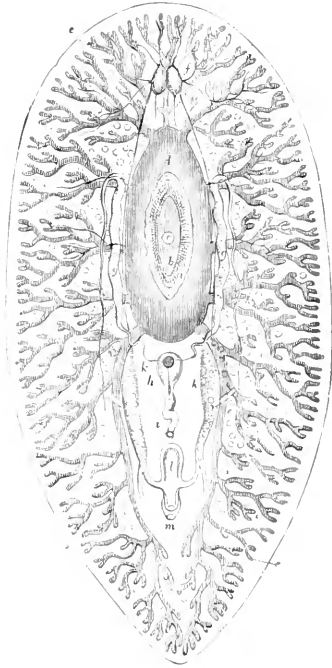

FIG. 714.—Structure of *Polyclis levigatus* (a Planarian worm): *a*, mouth, surrounded by its circular sucker; *b*, buccal cavity; *c*, oesophageal orifice; *d*, stomach; *e*, ramifications of gastric canals; *f*, cephalic ganglia and their nervous filaments; *g, g*, testes; *h*, vesicula seminalis; *i*, male genital canal; *k, k*, oviducts; *l*, dilatation at their point of junction; *m*, female genital orifice.

¹ See Balfour's *Comparative Embryology*, vol. i. pp. 159-162.

² For further information regarding the *Turbellaria* consult Dr. L. Graff's article on Planarians in the 9th edition of the *Encyclopædia Britannica*, and his magnificent *Monographie der Turbellariiden*, Leipzig, 1882; A. Lang, *Die Polycladen*, Leipzig, 1884; P. Hallez, *Contributions à l'histoire naturelle des Turbellariés*, Lille, 1879. On transverse fission, see Bell, *Journ. Roy. Microsc. Soc.* (2), vi. p. 1107.

on land. The body in this class is usually elongated and nearly always presents a well-marked segmental division, the segments being for the most part similar and equal to each other, except at the two extremities; though in some, as the leech and its allies,

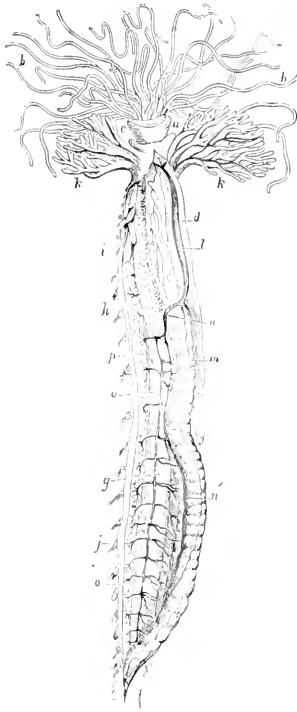

FIG. 715.—Circulating apparatus of *Terebella conchilega*: *a*, labial ring; *b, b*, tentacles; *c*, first segment of the trunk; *d*, skin of the back; *e*, pharynx; *f*, intestine; *g*, longitudinal muscles of the inferior surface of the body; *h*, glandular organ; *i*, organs of generation; *j*, feet; *k, k*, branchiae; *l*, dorsal vessel acting as a respiratory heart; *m*, dorso-intestinal vessel; *n*, venous sinus surrounding cesophagus; *n'*, inferior intestinal vessel; *o, o*, ventral trunk; *p*, lateral vascular branches.

a system of proper vessels that communicates with a central propelling organ, and not only carries the fluid away from this, but also brings it back again. In *Terebella* we find a distinct provision for the

the segmental division is very indistinctly seen, on account of the general softness of the integument. A large portion of the marine Annelids have special respiratory appendages, into which the fluids of the body are sent for aëration, and these are situated upon the head (fig. 715) in those species which (like the *Serpula*, *Terebella*, *Sabelaria*, &c.) have their bodies inclosed by tubes, either formed of a shelly substance produced from their own surface, or built up by the agglutination of grains of sand, fragments of shell, &c.;¹ whilst they are distributed along the two sides of the body in such as swim freely through the water, or crawl over the surfaces of rocks, as is the case with the *Nereida*, or simply bury themselves in the sand, as the *Arenicola* or 'lob-worm.' In these respiratory appendages the circulation of the fluids may be distinctly seen by microscopic examination; and these fluids are of two kinds: first, a colourless fluid, containing numerous cell-like corpuscles, which can be seen in the smaller and more transparent species to occupy the space that intervenes between the outer surface of the alimentary canal and the inner wall of the body, and to pass from this into canals which often ramify extensively in the respiratory organs, but are never furnished with a returning series of passages; and second, a fluid which is usually red, contains few floating particles, and is inclosed in

¹ For an interesting account of the formation of these tubes see Mr. A. T. Watson's paper in *Journ. Roy. Micr. Soc.* 1890, p. 685.

aëration of both fluids; for the first is transmitted to the tendril-like tentacles which surround the mouth (fig. 715, *b, b*), whilst the second circulates through the beautiful arborescent gill-tufts (*k, k*) situated just behind the head. The former are covered with cilia, the action of which continually renews the stratum of water in contact with them, whilst the latter are destitute of these organs; and this seems to be the general fact as to the several appendages to which these two fluids are respectively sent for aëration, the nature of their distribution varying greatly in the different members of the class. In the observation of the beautiful spectacle presented by the respiratory circulation of the various kinds of Annulates which swarm on most of our shores, and in the examination of what is going on in the interior of their bodies (where this is rendered possible by their transparency), the microscopist will find a most fertile source of interesting occupation; and he may easily, with care and patience, make many valuable additions to our present stock of knowledge on these points. There are many of these marine worms in which the appendages of various kinds put forth from the sides of their bodies furnish very beautiful microscopic objects; as do also the different forms of teeth, jaws, &c. with which the mouth is commonly armed in the free or non-tubicolar species, which are eminently carnivorous.

The early history of their development is extremely curious; for many come forth from the egg in a condition very little more advanced than the ciliated gemmules of polypes, consisting of a globular mass of untransformed cells, certain parts of whose surface are covered with cilia, which ordinarily become arranged in one or more definite rings; in a few hours, however, this embryonic mass elongates, and the indications of a segmental division become apparent, the head being (as it were) marked off in front, whilst behind this is a large segment thickly covered with cilia, then a narrower and non-ciliated segment, and lastly the caudal or tail segment, which is furnished with cilia. A little later a new segment is seen to be interposed in front of the caudal, and the dark internal granular mass shapes itself into the outline of an alimentary canal.¹ The number of segments progressively increases by the interposition of new ones between the caudal and its preceding segments; the various internal organs become more and more distinct, eye-spots make their appearance, little bristly appendages are put forth from the segments, and the animal gradually assumes the likeness of its parent; a few days being passed by the tubicolar kinds, however, in the actively

¹ A most curious transformation once occurred within the Author's experience in the larva of an Annelid, which was furnished with a broad collar or disc fringed with very long cilia, and showed merely an appearance of segmentation in its hinder part; for in the course of a few minutes, during which it was not under observation, this larva assumed the ordinary form of a marine worm three or four times its previous length, and the ciliated disc entirely disappeared. An accident unfortunately prevented the more minute examination of this worm, which the Author would have otherwise made; but he may state that he is certain that there was no fallacy as to the fact above stated, this larva having been placed by itself in a cell, on purpose that it might be carefully studied, and having been only laid aside for a short time whilst other selections were being made from the same gathering of the tow-net.

moving condition, before they settle down to the formation of a tube.¹

To carry out any systematic observations on the embryonic development of Annulata the eggs should be searched for in the situations which these animals haunt; but in places where Annulata abound free-swimming larvae are often to be obtained at the same time and in the same manner as small Medusæ; and there is probably no part of our coasts off which some very curious forms may not be met with. The following may be specially mentioned as departing widely from the ordinary type, and as in themselves extremely beautiful objects: The *Actinotrocha*, which is now known

to be the young stage of the Gephyrean worm *Phoronis* (fig. 716), bears a strong resemblance in many particulars to the 'bipinnarian' larva of a starfish, having an elongated body, with a series of ciliated tentacles (*d*) symmetrically arranged; these tentacles, however, proceed from a sort of disc which somewhat resembles the 'lophophore' of certain Polyzoa. The mouth (*e*) is concealed by a broad but pointed hood or 'epistome' (*a*), which sometimes closes down upon the tentacular disc, but is sometimes raised and extended forwards. The nearly cylindrical body terminates abruptly at the other extremity, where the anal orifice of the intestine (*b*) is surrounded by a circle of very large cilia. This animal swims with great activity, sometimes by the tentacular cilia, sometimes by the anal circle, sometimes by both combined; and besides its movement of progression it frequently doubles itself together, so as to bring the anal extremity and the epistome almost into contact. It is so transparent that the whole of its alimentary canal may be



FIG. 716.—*Actinotrocha branchiata*: *a*, epistome or hood; *b*, anus; *c*, stomach; *d*, ciliated tentacles; *e*, mouth.

as distinctly seen as that of Laguncula; and, as in that polyzoon, the alimentary masses often to be seen within the stomach (*c*) are kept in a continual whirling movement by the agency of cilia, with which its walls are clothed.² An even more extraordinary departure from the ordinary type is presented by the larva which has received the name *Pilidium* (fig. 717), its shape being that of a helmet, the

¹ For further information on this subject see Balfour's *Comparative Embryology*, vol. i. chap. xii. and the memoirs there cited.

² 'Ueber *Pilidium* und *Actinotrocha*' in Müller's *Archiv*, 1858, p. 293. For more recent observations upon the latter creature, see Balfour's *Comparative Embryology*, vol. i. pp. 299-302; and a paper on 'The Origin and Significance of the Metamorphosis of *Actinotrocha*,' by Mr. E. B. Wilson (of Baltimore), in *Quart. Journ. Microsc. Sci.*, April 1881.

plume of which is replaced by a single long bristle-like appendage that is in continual motion, its point moving round and round in a circle. This curious organism, first noticed by Johannes Müller, has been since ascertained to be the larva of some species of the Nemertine worms, which belong to the division *Auopla*, a group in which there are no stylets to the proboscis.¹

Among the animals captured by the tow-net the marine zoölogist will not be unlikely to meet with a worm which,

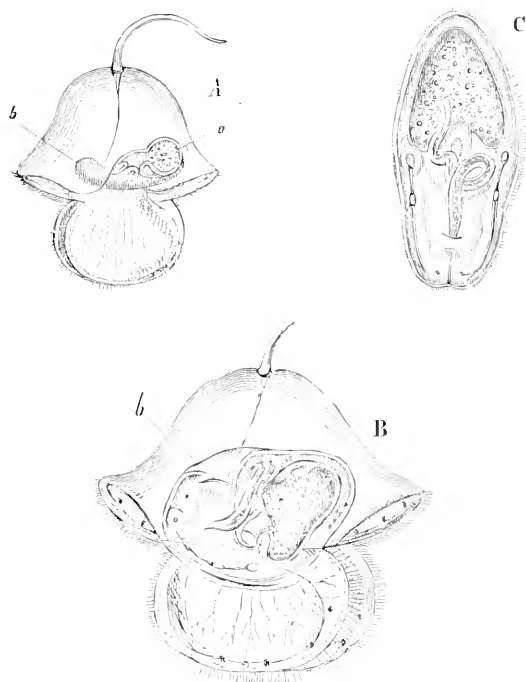

FIG. 717.—*Pilidium gyrans*. A, young, showing at *a* the alimentary canal, and at *b* the rudiment of the Nemertid; B, more advanced stage of the same; C, newly freed Nemertid.

although by no means microscopic in its dimensions, is an admirable subject for microscopic observation, owing to the extreme transparency of its entire body, which is such as to render it difficult to be distinguished when swimming in a glass jar except by a very favourable light. This is the *Tomopteris*, so named from the division of the lateral portions of its body into a succession of wing-like segments (fig. 718, B), each of them carrying at its extremity a pair of pinnules, by the movements of which it is rapidly propelled through the water. The full-grown animal, which measures nearly

¹ See especially Leuckart and Pagenstecher's 'Untersuchungen über niedere Seethiere' in Müller's *Archiv*, 1853, p. 569; and Balfour, *op. cit.* p. 165. The Author has frequently met with *Pilidium* in Lamash Bay.

an inch in length, has first a curious pair of 'frontal horns' projecting laterally from the head, so as to give the animal the appear-

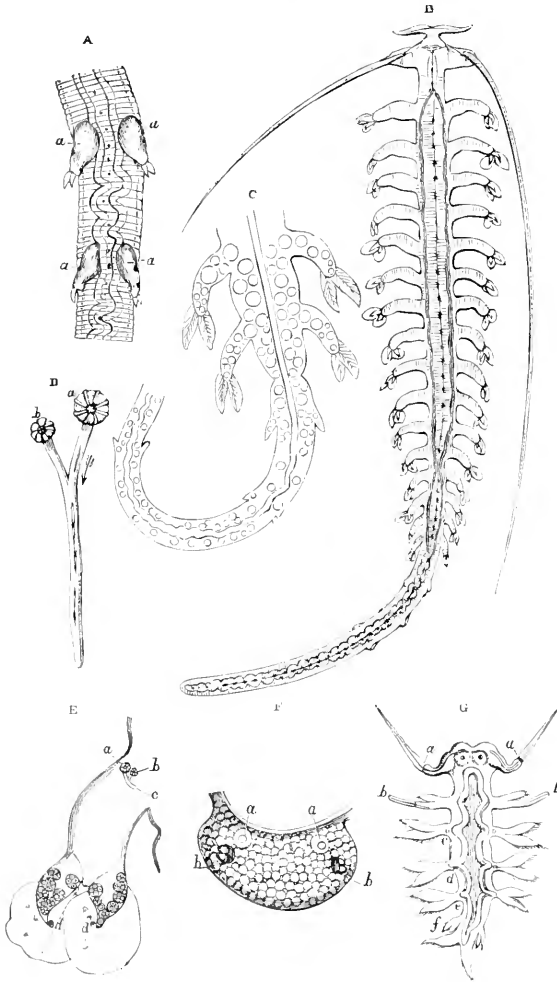

FIG. 718.—Structure and development of *Tomopteris onisciformis*: A, portion of caudal prolongations, containing the spermatic sacs, *a a*; B, adult male specimen; C, hinder part of adult female specimen, more enlarged, showing ova, lying freely in the perivisceral cavity and its caudal prolongation; D, ciliated canal, commencing externally in the larger and smaller rosette-like discs, *a, b*; E, one of the pinnulated segments, showing the position of the ciliated canal, *c*, and its rosette-like discs, *a, b*; showing also the incipient development of the ova, *d*, at the extremity of the segment; F, cephalic ganglion, with its pair of auditory (?) vesicles, *a a*, and its two ocelli, *b b*; G, very young *Tomopteris*, showing at *a a* the larval antennae; *b b*, the incipient long antennae of the adult; *c, d, e, f*, four pairs of succeeding pinnulated segments, followed by bifid tail.

ance of a 'hammer-headed' shark; behind these there is a pair of very long antennæ, in each of which we distinguish a rigid bristle-like stem or *seta*, inclosed in a soft sheath, and moved at its base by a set of muscles contained within the lateral protuberances at the head. Behind these are about sixteen pairs of the ordinary pinnulated segments, of which the hinder ones are much smaller than those in front, gradually lessening in size until they become almost rudimentary; and where these cease the body is continued onwards into a tail-like prolongation, the length of which varies greatly according as it is contracted or extended. This prolongation, however, bears four or five pairs of very minute appendages, and the intestine is continued to its very extremity, so that it is really to be regarded as a continuation of the body. In the head we find, between the origins of the antennæ, a ganglionic mass, the component cells of which may be clearly distinguished under a sufficient magnifying power, as shown at F; seated upon this are two pigment-spots (*b, b*), each bearing a double pellucid lens-like body, which are obviously rudimentary eyes; whilst imbedded in its anterior portion are two peculiar nucleated vesicles, *a, a*, which are probably the rudiments of some other sensory organs. On the under side of the head is situated the mouth, which, like that of many other Annelids, is furnished with a sort of proboscis that can be either projected or drawn in; a short œsophagus leads to an elongated stomach, which, when distended with fluid, occupies the whole cavity of the central portion of the body, as shown in fig. B, but which is sometimes so empty and contracted as to be like a mere cord, as shown in fig. C. In the caudal appendage, however, it is always narrowed into an intestinal canal; this, when the appendage is in an extended state, as at C, is nearly straight; but when the appendage is contracted, as seen at B, it is thrown into convolutions. The perivisceral cavity is occupied by fluid, in which some minute corpuscles may be distinguished; and these are kept in motion by cilia which clothe some parts of the outer surface of the alimentary canal and line some part of the wall of the body. No other more special apparatus, either for the circulation or for the aëration of the nutrient fluid, exists in this curious worm, unless we are to regard as subservient to the respiratory function the ciliated canal which may be observed in each of the lateral appendages except the five anterior pairs. This canal commences by two orifices at the base of the segment, as shown at fig. E, *b*, and on a larger scale at fig. D; each of these orifices (D, *a, b*) is surrounded by a sort of rosette, and the rosette of the larger one (*a*) is furnished with radiating ciliated ridges. The two branches incline towards each other, and unite into a single canal that runs along for some distance in the wall of the body, and then terminates in the perivisceral cavity, and the direction of the motion of the cilia which line it is from without inwards.

The reproduction and developmental history of this Annelid present many points of great interest. The sexes appear to be distinct, ova being found in some individuals and spermatozoa in others. The development of the ova commences in certain 'germ-

cells' situated within the extremities of the pinnulated segments, where they project inwards from the wall of the body; these, when set free, float in the fluid of the perivisceral cavity and multiply themselves by self-division; and it is only after their number has thus been considerably augmented that they begin to increase in size and to assume the characteristic appearance of ova. In this stage they usually fill the perivisceral cavity, not only of the body, but of its caudal extension, as shown at C; and they escape from it through transverse fissures which form in the outer wall of the body at the third and fourth segments. The male reproductive organs, on the other hand, are limited to the caudal prolongation, where the sperm-cells are developed within the pinnulated appendages, as the germ-cells of the female are within the appendages of the body. Instead of being set free, however, into the perivisceral cavity, they are retained within a saccular envelope forming a testis (A, *a*, *a*) which fills up the whole cavity of each appendage; and within this the spermatozoa may be observed, when mature, in active movement. They make their escape externally by a passage that seems to communicate with the smaller of the two just mentioned rosettes; but they also appear to escape into the perivisceral cavity by an aperture that forms itself when the spermatozoa are mature. Whether the ova are fertilised while yet within the body of the female by the entrance of spermatozoa through the ciliated canals, or after they have made their escape from it, has not yet been ascertained. Of the earliest stages of embryonic development nothing whatever is yet known; but it has been ascertained that the animal passes through a larval form, which differs from the adult not merely in the number of the segments of the body (which successively augment by additions at the posterior extremity), but also in that of the antennæ. At G is represented the earliest larva hitherto met with, enlarged as much as ten times in proportion to the adult at B; and here we see that the head is destitute of the frontal horns, but carries a pair of setigerous antennæ, *a*, *a*, behind which there are five pairs of bifid appendages, *b*, *c*, *d*, *e*, *f*, in the first of which, *b*, one of the pinnules is furnished with a *seta*. In more advanced larvæ having eight or ten segments this is developed into a second pair of antennæ resembling the first; and the animal in this stage has been described as a distinct species, *T. quadricornis*. At a more advanced age, however, the second pair attains the enormous development shown at B, and the first or larval antennæ disappear, the setigerous portions separating at a sort of joint (G, *a*, *a*), whilst the basal projections are absorbed into the general wall of the body. This beautiful creature has been met with on so many parts of our coast that it cannot be considered at all uncommon, and the microscopist can scarcely have a more pleasing object for study.¹ Its elegant form, its crystal clearness, and its sprightly, graceful movements render it attractive even to the unscientific

¹ See the memoirs of the Author and M. Claparède in vol. xxii. of the *Linnean Transactions* and the authorities there referred to; also a memoir by Dr. F. Vějdovsky in *Zeitschrift f. Wiss. Zool.* Bd. xxxi. 1878.

observer ; whilst it is of special interest to the morphologist as one of the simplest examples yet known of the Annelid type.

To one phenomenon of the greatest interest presented by various small marine Annelids the attention of the microscopist should be specially directed ; this is their *luminosity*, which is not a steady glow like that of the glow-worm or fire-fly, but a series of vivid scintillations (strongly resembling those produced by an electric discharge through a tube spotted with tinfoil), that pass along a considerable number of segments, lasting for an instant only, but capable of being repeatedly excited by any irritation applied to the body of the animal. These scintillations may be discerned under the microscope, even in separate segments, when they are subjected to the irritation of a needle-point or a gentle pressure ; and it has been ascertained by the careful observations of M. de Quatrefages that they are given out by the muscular fibres in the act of contraction.¹

Among the fresh-water Annelids those most interesting to the microscopist are the worms of the *Nais* tribe, which are common in our rivers and ponds, living chiefly amidst the mud at the bottom, and especially among the roots of aquatic plants. Being blood-red in colour, they give to the surface of the mud, when they protrude themselves from it in large numbers and keep the protruded portion of their bodies in constant undulation, a very peculiar appearance ; but if disturbed they withdraw themselves suddenly and completely. These worms, from the extreme transparency of their bodies, present peculiar facilities for microscopic examination, and especially for the study of the internal circulation of the red liquid commonly considered as blood. There are here no external respiratory organs, and the thinness of the general integument appears to supply all needful facility for the aëration of the fluids. One large vascular trunk (dorsal) may be seen lying above the intestinal canal, and another (ventral) beneath it, and each of these enters a contractile dilatation, or heart-like organ, situated just behind the head. The fluid moves forwards in the dorsal trunk as far as the heart, which it enters and dilates ; and when this contracts it propels the fluid partly to the head and partly to the ventral heart, which is distended by it. The ventral heart, contracting in its turn, sends the blood backwards along the ventral trunk to the tail, whence it passes towards the head as before. In this circulation the stream branches off from each of the principal trunks into numerous vessels proceeding to different parts of the body, which then return into the other trunk ; and there is a peculiar set of vascular coils, hanging down in the perivisceral cavity that contains the corpusculated liquid representing the true blood, which seem specially destined to convey to it the aërating influence received by the red fluid in its circuit, thus acting (so to speak) like internal gills. The Naiad worms have been observed to undergo spontaneous division during the summer months, a new head and its organs being formed for the posterior segment behind the line of constriction before its separation from

¹ See his memoirs on the Annelida of La Manche in *Ann. des Sci. Nat.* ser. ii. Zool. tom. xix. and ser. iii. Zool. tom. xiv. ; and Professor McIntosh in *Nature*, xxxii. p. 478.

the anterior.¹ In the Leech tribe the dental apparatus with which the mouth is furnished is one of the most curious among their points of minute structure, and the common 'medicinal' leech affords one of the most interesting examples of it. What is commonly termed the 'bite' of the leech is really a saw-cut, or rather a combination of three saw-cuts, radiating from a common centre. If the mouth of the leech be examined with a hand-magnifier, or even with the naked eye, it will be seen to be a triangular aperture in the midst of a sucking disc, and on turning back the lips of that aperture three little white ridges are brought into view. Each of these is the convex edge of a horny semicircle, strengthened by a deposit of carbonate of lime which is bordered by a row of eighty or ninety minute hard and sharp teeth; whilst the straight border of the semicircle is imbedded in the muscular substance of the disc, by the action of which it is made to move backwards and forwards in a saw-like manner, so that the teeth are enabled to cut into the skin to which the suckorial disc has affixed itself.²

¹ See Professor A. G. Bourne, 'On Budding in the Oligochaeta,' *Report Brit. Assoc.* 1885, p. 1096.

² Among the various sources of information as to the anatomy and physiology of the Annelids the following may be specially mentioned: the 'Histoire Naturelle des Annelés Marins et d'Eau douce' of M. de Quatrefages, forming part of the *Suites à Buffon*; the successive admirable monographs of the late Professor Ed. Claparède, *Recherches Anatomiques sur les Annélides, Turbellariés, Opalines et Grégarines, observés dans les Hébrides*, Geneva, 1861; *Recherches Anatomiques sur les Oligochètes*, Geneva, 1862; *Beobachtungen über Anatomie und Entwicklungsgeschichte wirbelloser Thiere an der Küste von Normandie*, Leipzig, 1863; and *Les Annélides Chétopodes du Golfe de Naples*, Geneva, 1868-70; the monograph of Dr. Ehlers, *Die Borstwürmer (Annelida Chetopoda)*, 1864-68. With the exception of Professor McIntosh's article in the *Encyclopædia Britannica*, and the various articles on 'Worms' in the *Cambridge Natural History*, which can be warmly commended to the student, most of the recent papers on Annelids have dealt with small groups only, but of these a very large number has appeared. For the descriptions of new forms the memoirs of Grube, McIntosh, and St. Joseph are especially to be consulted; Hatschek, Kleinenberg, and Salensky have written the most important contributions to our knowledge of development; Benham, Bergh, Bourne, Eisig, Meyer, Perrier, and Whitman have, among others, added to our knowledge of their anatomy and morphology.

CHAPTER XX

CRUSTACEA

PASSING to the division of Arthropods, in which the body is furnished with distinctly articulated or jointed limbs, some of which are always modified to serve as mouth-organs, we come first to the class of *Crustacea*, which ordinarily includes (when used in its most comprehensive sense) all those animals belonging to this group which are fitted for aquatic respiration, though the king-crab (*Limulus*) seems to have closer relations to the scorpions, and the Pycnogonids to the spiders. It thus comprehends a very extensive range of forms; for although we are accustomed to think of the crab, lobster, cray-fish, and other well-known species of the order *Decapoda* (ten-footed) as its typical examples, yet all these belong to the highest of its many orders; and among the lower are many of a far simpler structure, not a few which would not be recognised as belonging to the class at all were it not for the information given by the study of their development as to their real nature, which is far more apparent in their early than it is in their adult condition. Many of the inferior kinds of Crustacea are so minute and transparent that their whole structure may be made out by the aid of the microscope without any preparation: this is the case, indeed, with nearly the whole group of *Entomostraca*, and with the larval forms even of the *crab*, and its allies; and we shall give our first attention to these, afterwards noticing such points in the structure of the larger kinds as are likely to be of general interest.

A curious example of the reduction of an elevated type to a very simple form is presented by the group of *Pycnogonida*, or nobody crabs, some of the members of which may be found by attentive search in almost every locality where seaweeds abound, it being their habit to crawl (or rather to sprawl) over the surfaces of these, and probably to imbibe as food the gelatinous substance with which they are invested.¹ The general form of their bodies (fig. 719) usually reminds us of that of some of the long-legged crabs, the abdomen being almost or altogether deficient, whilst the head is very small, and fused (as it were) into the thorax; so that the last-named region, with the members attached to it, constitutes nearly the whole bulk of the animal. The head is extended in front into

¹ It is remarkable that very large forms of this group, sometimes extending to more than twelve inches across, have been brought up from great depths of the sea.

a proboscis-like projection, at the extremity of which is the narrow orifice of the mouth, which draws in the semi-fluid aliment. Instead of being furnished (as in the higher crustaceans) with two pairs of antennæ and numerous pairs of 'foot-jaws,' it has but a single pair of either; it also bears four minute *ocelli*, or rudimentary eyes, set at a little distance from each other on a sort of tubercle. From the thorax proceed four pairs of legs, each composed of several joints, and terminated by a hooked claw; and by these members the animal drags itself slowly along, instead of walking actively upon them like a crab. The mouth leads to a very narrow œsophagus (*a*), which passes back to the central stomach (*b*) situated in the

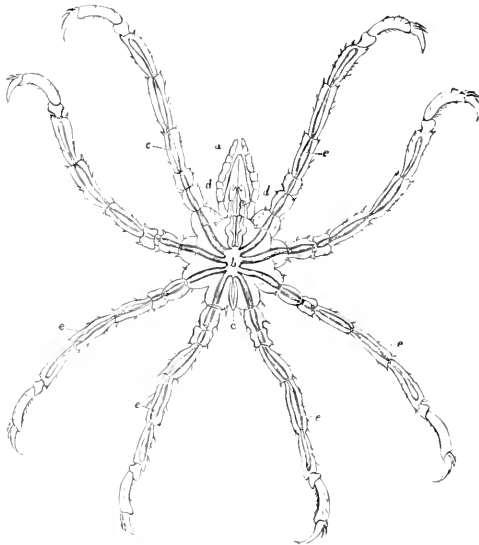

FIG. 719.—*Ammothea pyenogonoides*: *a*, narrow œsophagus; *b*, stomach; *c*, intestine; *d*, digestive caeca of the foot-jaws; *e, e*, digestive caeca of the legs.

midst of the thorax, from the hinder end of which a narrow intestine (*c*) passes off, to terminate at the posterior extremity of the body. From the central stomach five pairs of caecal prolongations radiate, one pair (*d*) entering the foot-jaws, the other four (*e, e*) penetrating the legs, and passing along them as far as the last joint but one; and those extensions are covered with a layer of brownish-yellow granules, which are probably to be regarded as a digestive gland. The stomach and its caecal prolongations are continually executing peristaltic movements of a very curious kind; for they contract and dilate with an irregular alternation, so that a flux and reflux of their contents is constantly taking place between the central portion and its radiating extensions. The perivisceral space between the widely extended stomach and the walls of the body and

limbs is occupied by a transparent liquid, in which are seen floating a number of minute transparent corpuscles of irregular size; and this fluid, which represents the blood, is kept in continual motion, not only by the general movements of the animal, but also by the actions of the digestive apparatus; since, whenever the cæcum of any one of the legs undergoes dilatation, a part of the circumambient liquid will be pressed out from the cavity of that limb, either into the thorax or into some other limb whose stomach is contracting. The fluid must obtain its aëration through the general surface of the body, as there are no special organs of respiration. The nervous system consists of a single ganglion in the head (formed by the coalescence of a pair), and of another in the thorax (formed by the coalescence of four pairs), with which the cephalic ganglion is connected in the usual mode, namely, by two nervous cords which diverge from each other to embrace the œsophagus. In the study of the very curious phenomena exhibited by the digestive apparatus, as well as of the various points of internal conformation which have been described, the achromatic condenser will be found useful, even with the 1-inch, $\frac{2}{3}$ -inch, or $\frac{1}{2}$ -inch objectives; for the imperfect transparency of the bodies of these animals renders it of importance to drive a large quantity of light through them, and to give to this light such a quantity as shall sharply define the internal organs.¹

Entomostraca.—This group of crustaceans, many of the existing members of which are of such minute size as to be only just visible to the naked eye, is distinguished by the fact that they never have more than three pairs of their appendages converted into mouth-organs, nor possess any appendage on such segments as may lie behind the generative orifices. The segments into which the body is divided are frequently very numerous, and are for the most part similar to each other; but there is a marked difference in regard to the appendages which they bear, and to the mode in which these minister to the locomotion of the animals. For in what have been called the *Lophypopoda*, or 'bristly-footed' tribe, a small number of legs not exceeding five pairs have their function limited to locomotion, the respiratory organs being attached to the parts in the neighbourhood of the mouth; whilst in the *Branchiopoda*, or 'gill-footed' tribe, the members (known as 'fin-feet') serve both for locomotion and for respiration, and the number of these is commonly large, being in *Apus* as many as sixty pairs. The character of their movements differs accordingly; for whilst all the members of the first-named tribe dart through the water in a succession of jerks, so as to have acquired the common name of 'water-fleas,' those among the latter which possess a great

¹ Certain points of resemblance borne by *Pycnogonida* to spiders make the careful study of their development a matter of special interest and importance, as there is some reason to regard them rather as *Arachnida* adapted to a marine habitat than as Crustacea. See Balfour's *Comparative Embryology*, pp. 448, 449, and the authorities there referred to. The most recent additions to the literature of the Pycnogonids are Dr. A. Dohrn's *Die Pantapoden des Golfes von Neapel* &c., Leipzig, 1881; Dr. P. P. C. Hoek's 'Report on the Pycnogonida of the *Challenger*,' 1881, and his 'Nouvelle Etude sur les Pycnogonides,' in *Archives de Zool. Expér.* ix. p. 445; and Professor G. O. Sars's report in the *Zöology of the Norwegian North Sea Expedition*.

number of 'fin-feet' swim with an easy gliding movement, sometimes on their back alone (as is the case with *Branchipus*) and sometimes with equal facility on the back, belly, or sides (as is done by *Artemia salina*, the 'brine-shrimp'). Some of the most common forms of both tribes will now be briefly noticed.

The first group contains two orders, of which the first, *Ostracoda*, is distinguished by the complete inclosure of the body in a bivalve shell, by the small number of legs, and by the absence of an external egg-sac. One of the best known examples is the little *Cypris*, which is a common inhabitant of pools and streams; this may be recognised by its possession of two pairs of antennæ, the first having numerous joints with a pencil-like tuft of filaments, and projecting forwards from the front of the head, whilst the second has more the shape of legs, and is directed downwards, and by the limitation of its legs to two pairs, of which the posterior does not make its appearance outside the shell, being bent upwards to give support to the ovaries. The valves are generally opened widely enough to allow the greater part of both pairs of antennæ and of the front pair of legs to pass out between them; but when the animals are alarmed, they draw these members within the shell, and close the valves firmly. They are very lively creatures, being almost constantly seen in motion, either swimming by the united action of their foot-like antennæ and legs, or walking upon plants and other solid bodies floating in the water. Nearly allied to the preceding is *Cythere*, whose body is furnished with three pairs of legs, all projecting out of the shell, and whose superior antennæ are destitute of the filamentous brush; this genus is almost entirely marine, and some species of it may almost invariably be met with in little pools among the rocks between the tide-marks, creeping about (but not swimming) amongst *Conferva* and *Corallines*. There is abundant evidence of the former existence of Crustacea of larger size than any now existing, for in certain fresh-water strata, both of the Secondary and Tertiary series, we find layers, sometimes of great extent and thickness, which are almost entirely composed of the fossilised shells of *Cyprides*; whilst in certain parts of the chalk, which was a marine deposit, the remains of bivalve shells resembling those of *Cythere* present themselves in such abundance as to form a considerable part of its substance.¹

In the order *Copepoda* there is a jointed shell forming a kind of buckler or carapace that almost entirely incloses the head and thorax, an opening being left beneath, through which the appendages project; and there are five pairs of legs, mostly adapted for swimming, the fifth pair, however, being rudimentary in the genus *Cyclops*, the commonest example of the group. This genus receives its name from possessing only a single eye, or rather a single cluster of ocelli; which character, however, it has in common with the two genera already named, as well as with *Daphnia*, and with many other Entomostraca. It contains numerous species, some of which belong

¹ On the recent British Ostracoda see the monograph by G. S. Brady in vol. xxvi. of the *Transactions of the Linnean Society* of London; compare also Zenker, 'Monographie der Ostracoden,' *Archiv für Naturg.* xx. 1854. Claus has an essay on the development of *Cypris*, Marburg, 1868; see also Dr. Brady's 'Challenger Report.'

to the fresh water, whilst others are marine. The fresh-water species often abound in the muddiest and most stagnant pools, as well as in the clearest springs. Of the marine species some are to be found in the localities in which the *Cythere* is most abundant, whilst others inhabit the open ocean, and must be collected by the tow-net. The body of the *Cyclops* is soft and gelatinous, and it is composed of two distinct parts, a thorax (fig. 720, *a*) and an abdomen (*b*), of which the latter, being comparatively slender, is commonly considered as a tail, though traversed by the intestine, which terminates near its extremity. The head, which coalesces with the thorax, bears one very large pair of antennæ (*c*), possessing numerous articulations and furnished with bristly appendages, and another small pair (*d*): it is also furnished with a pair of mandibles or true jaws and with two pairs of 'maxillæ,' of which the hinder pair is the longer and more abundantly supplied with bristles. The legs (*e*) are all beset with plumose tufts, as is also the tail (*f, f*) which is borne at the extremity of the abdomen. On either side of the abdomen of the female, there is often to be seen an egg-capsule (B); within which the ova, after being fertilised, undergo the earlier stages of their development. The *Cyclops* is a very active creature, and strikes the water in swimming, not merely with its legs and tail but also with its antennæ. The rapidly repeated movements of its feet-jaws serve to create a whirlpool in the surrounding water, by which minute animals of various kinds, and even its own young, are brought to its mouth to be devoured.¹

The tribe of *Branchiopoda* is divided also into two groups, of which the *Cladocera* present the nearest approach to the preceding, having a bivalve carapace, no more than from four to six pairs of legs, two pairs of antennæ, of which one is large and branched and adapted for swimming, and a single eye. The commonest form of

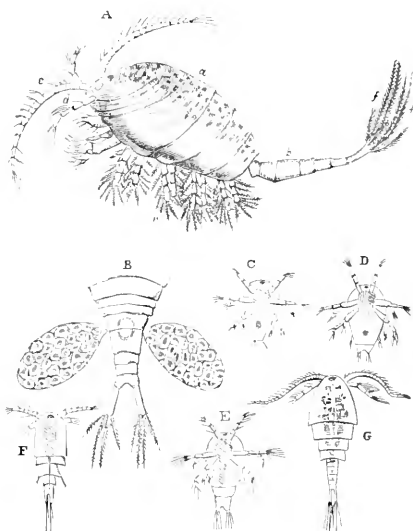

FIG. 720.—A, female of *Cyclops quadricornis*: *a*, body; *b*, tail; *c*, antenna; *d*, antennule; *e*, feet; *f, f*, plumose setae of tail. B, tail, with external egg-sacs. C, D, E, F, G, successive stages of development of young.

¹ See for British forms Professor G. S. Brady's *Monograph of the free and semi-parasitic Copepoda of the British Islands*, published by the Ray Society, 1878-80, and Mr. I. C. Thompson's accounts of those collected near the Isle of Man, published by the Liverpool Biological Society.

this is the *Daphnia pulex*, which is sometimes called the 'arborescent water-flea,' from the branching form of its antennæ. It is very abundant in many ponds and ditches, coming to the surface in the mornings and evenings and in cloudy weather, but seeking the depths of the water during the heat of the day. It swims by taking short springs; and feeds on minute particles of vegetable substances, but does not, however, reject animal matter when offered. Some of the peculiar phenomena of its reproduction will be presently described.

The other group, *Phyllopoda*, includes those Branchiopoda whose body is divided into a great number of segments, nearly all of which are furnished with leaflike appendages, or 'fin-feet.' The two families which this group includes, however, differ considerably in their conformation; for in that of which the genera *Apus* and *Nebalia*¹ are representatives, the body is inclosed in a shell, either shield-like or bivalve, and the feet are generally very numerous; whilst in that which contains *Branchipus* and *Artemia*, the body is entirely unprotected, and the number of pairs of feet does not exceed eleven. The *Apus canceriformis*, which is an animal of comparatively large size, its entire length being about $2\frac{1}{2}$ inches, is an inhabitant of stagnant waters; but although occasionally very abundant in particular pools, or ditches, it is not to be met with nearly so commonly as the Entomostraca already noticed; in this country, indeed, it is exceedingly rare. It is recognised by its large oval carapace, which covers the head and body like a shield; by the nearly cylindrical form of its body, which is composed of thirty articulations, and by the large number of its appendages, which amount to about sixty pairs. The number of joints in these is so great that in a single individual they may be safely estimated at not less than two millions. These organs, however, are for the most part small; and the instruments chiefly used by the animal for locomotion are the first pair of feet, which are very much elongated (bearing such a resemblance to the principal antennæ of other Entomostraca as to be commonly ranked in the same light), and are distinguished as *rami* or oars. With these they can swim freely in any position; but when the rami are at rest, and the animal floats idly on the water, its fin-feet may be seen in incessant motion, causing a sort of whirlpool in the water, and bringing to the mouth the minute animals (chiefly the smaller Entomostraca inhabiting the same localities) that serve for its food. The *Branchipus stagnalis* has a slender, cylindrical, and very transparent body, of nearly an inch in length, furnished with eleven pairs of fin-feet, but is destitute of any protecting envelope: its head is furnished with a pair of very curious prehensile organs, which are really modified antennæ, whence it has received the name of *Cheirocephalus*; but

¹ Professor Claus has pointed out the relations of *Nebalia* to the Malacostraca, or higher division of the Crustacea, and has suggested for the group which they represent the name of *Leptostraca*. See the *Zeitschr. für wiss. Zöol.* 1872, p. 323; Claus, *Untersuchungen zur Erforschung der genealogischen Grundlage des Crustaceen-Systems*, Wien, 1876, as well as 'Ueber den Organismus der Nebaliiden und die systematische Stellung der Leptostraken,' in *Arch. Zöol. Inst. Wien.* viii. (1889), pp. 1-148, 15 pls.; but a different view is taken by Professor G. O. Sars in his Report on the *Challenger* Phyllocarida.

these are not used by it for the seizure of prey, as the food of this animal is vegetable, but to clasp the female in the act of copulation. The *Branchipus* or *Cheirocephalus* is certainly the most beautiful and elegant of all the Entomostraca, being rendered extremely attractive to the view by 'the uninterrupted undulatory wavy motion of its graceful branchial feet, slightly tinged as they are with a light reddish hue, the brilliant mixture of transparent bluish-green and bright red of its prehensile antennæ, and its bright red tail with the beautiful plumose setæ springing from it.' Unfortunately, however, it is a very rare animal in this country. The *Artemia salina*, or 'brine-shrimp,' is an animal of very similar organisation, and almost equally beautiful in its appearance and movements, but of smaller size, its body being about half an inch in length. Its 'habitat' is very peculiar, for it is only found in the salt-pans or brine-pits in which sea-water is undergoing concentration (as at Lymington); and in these situations it is sometimes so abundant as to communicate a red tinge to the liquid.

Some of the most interesting points in the history of the Entomostraca lie in the peculiar mode in which their generative function is performed, and in their tenacity of life when desiccated, in which last respect they correspond with many Rotifers. By this provision they escape being completely exterminated, as they might otherwise soon be, by the drying up of the pools, ditches, and other small collections of water which constitute their usual habitats. We do not, of course, imply that the adult animals can bear a *complete* desiccation, although they will preserve their vitality in mud that holds the smallest quantity of moisture; but their eggs are more tenacious of life, and there is ample evidence that these will become fertile on being moistened, after having remained for a long time in the condition of fine dust. Most Entomostraca, too, are killed by severe cold, and thus the whole race of adults perishes every winter; but their eggs seem unaffected by the lowest temperature, and thus continue the species, which would be otherwise exterminated. Again, we frequently meet in this group with that *agamie* reproduction which we have seen to prevail so extensively among the lower forms. In many species there is a double mode of multiplication, the sexual and the non-sexual. The former takes place at certain seasons only, the males (which are often so different in conformation from the females that they would not be supposed to belong to the same species if they were not seen in actual congress) disappearing entirely at other times. The latter, on the other hand, continues at all periods of the year, so long as warmth and food are supplied, and is repeated many times so as to give origin to as many successive 'broods.' Further, a single act of impregnation may serve to fertilise, not merely the ova which are then mature or nearly so, but all those subsequently produced by the same female, which are deposited at considerable intervals. In these two modes the multiplication of these little creatures is carried on with great rapidity, the young animal speedily coming to maturity and beginning to propagate, so that, according to the computation of Jurine, founded upon data ascertained by actual observation, a

single fertilised female of the common *Cyclops quadricornis* may be the progenitor in one year of 4,442,189,120 young.¹

The eggs of some Entomostraca are deposited freely in the water, or are carefully attached in clusters to aquatic plants; but they are more frequently carried for some time by the parent in special receptacles developed from the posterior part of the body; and in many cases they are retained there until the young are ready to come forth, so that these animals may be said to be ovo-viviparous. In *Daphnia* the eggs are received into a large cavity between the back of the animal and its shell, and there the young undergo almost their whole development, so as to come forth in a form nearly resembling that of their parent. Soon after their birth a moult or exuviation of the shell takes place, and the egg-coverings are cast off with it. In a very short time afterwards another brood of eggs is seen in the cavity and the same process is repeated, the shell being again exuviated after the young have been brought to maturity. At certain times, however, the *Daphnia* may be seen with a dark opaque substance within the back of the shell, which has been called the *ephippium*, from its resemblance to a saddle. This, when carefully examined, is found to be of dense texture, and to be composed of a mass of hexagonal cells; and it contains two oval bodies, each consisting of an ovum covered with a horny casing, enveloped in a capsule which opens like a bivalve shell. From the observations of Sir J. Lubbock,² it appears that the ephippium is really only an altered portion of the carapace, its outer valve being a part of the outer layer of the epidermis, and its inner valve the corresponding part of the inner layer. The development of the ephippial eggs takes place at the posterior part of the ovaries, and is accompanied by the formation of a greenish-brown mass of granules; and from this situation the eggs pass into the receptacle formed by the new carapace, where they become included between the two layers of the ephippium. This is cast off, in process of time, with the rest of the skin, from which, however, it soon becomes detached; and it continues to envelope the eggs, generally floating on the surface of the water until they are hatched with the returning warmth of spring. This curious provision obviously affords protection to the eggs which are to endure the severity of winter cold; and an approach to it may be seen in the remarkable firmness of the envelopes of the 'winter eggs' of some Rotifera. There seems a strong probability, from the observations of Sir J. Lubbock (now Lord Avebury), that the 'ephippial' eggs are true sexual products, since males are to be found at the time when the ephippia are developed; whilst it is certain that the ordinary eggs can be produced non-sexually, and that the young which spring from them can multiply the race in like manner. The young which are produced from the ephippial eggs seem to have the same power of continuing the

¹ For an interesting account of the parthenogenetic development of *Apus* and its allies see the sixth of Von Siebold's *Beiträge zur Parthenogenesis der Arthropoden* (Leipzig, 1871).

² 'An account of the two Methods of Reproduction in *Daphnia*, and of the Structure of the Ehippium,' in *Phil. Trans.* 1857, p. 79. 'On the 'summer-egg' of *Daphnia* see Lebedinsky, *Zool. Anzeig.* xiv. p. 149.

race by non-sexual reproduction as the young developed under ordinary circumstances.

In most Entomostraca the young at the time of their emersion from the egg differ considerably from the parent, especially in having only the thoracic portion of the body as yet developed, and in possessing but a small number of locomotor appendages (see fig. 720, C-G); the visual organs, too, are frequently wanting at first. The process of development, however, takes place with great rapidity, the animal at each successive moult (which process is very commonly repeated at intervals of a day or two) presenting some new parts, and becoming more and more like its parent, which it very early resembles in its power of multiplication, the female laying eggs before she has attained her own full size. Even when the Entomostraca have attained their full growth, they continue to exuviate their shell at short intervals during the whole of life: and this repeated moulting seems to prevent the animal from being injured, or its movements obstructed, by the overgrowth of parasitic animalcules and confervæ, weak and sickly individuals being frequently seen to be so covered with such parasites that their motion and life are soon arrested, apparently because they have not strength to cast off and renew their envelopes. The process of development appears to depend in some degree upon the influence of light, being retarded when the animals are secluded from it; but its rate is still more influenced by heat; and this appears also to be the chief agent that regulates the time which elapses between the moultings of the adult, these, in *Daphnia*, taking place at intervals of two days in warm summer weather, whilst several days intervene between them when the weather is colder. The cast shell carries with it the sheaths not only of the limbs and plumes, but of the most delicate hairs and setæ which are attached to them. If the animal have previously sustained the loss of a limb, it is generally renewed at the next moult, as in higher Crustacea.¹

Forming part of the entomostracous group is the tribe of *suctorial* Crustacea,² which for the most part live as parasites upon the exterior of other animals (especially fish), whose juices they imbibe by means of the peculiar proboscis-like organ which takes in them the place of the jaws of other crustaceans; whilst other appendages, representing the foot-jaws, are furnished with hooks, by which these parasites attach themselves to the animals from whose juices they derive their nutriment. Many of the suctorial Crustacea bear a strong resemblance, even in their adult condition, to other Entomostraca; but more commonly it is between the earlier forms of the two that the resemblance is the closest, most of the *Suctorii* undergoing such extraordinary changes in their

¹ For a systematic and detailed account of this group Dr. Baird's *Natural History of the British Entomostraca*, published by the Ray Society in 1849, must still be recommended. The numerous essays by Professor Claus should also be consulted.

² It is now generally recognised that these should be placed with the *Copepoda*, which may be divided into the *Eucopepoda* and the *Branchiura*; the former are divisible into the *Gnathostomata*, most of which are non-parasitic, and have been already described under *Copepoda*, and the *Siphonostomata*, of which *Lernæa* is an example.

progress towards the adult condition that, if their complete forms were alone attended to, they might be excluded from the class altogether, as was (in fact) done by many earlier zöologists. Of the suctorial crustacea which form the group *Branchiura* may be specially mentioned the *Argulus foliaceus*, which attaches itself to the surface of the bodies of fresh-water fish, such as the stickleback, and is commonly known under the name of the 'fish-louse.' This animal has its body covered with a large firm oval shield, which does not extend, however, over the posterior part of the abdomen. The mouth is armed with a pair of styliform mandibles; and on each side of the proboscis there is a large, short, cylindrical appendage, terminated by a curious sort of sucking-disc, with another pair of longer jointed members, terminated by prehensile hooks. These two pairs of appendages, which are probably to be considered as representing the foot-jaws, are followed by four pairs of legs, which, like those of the branchiopods, are chiefly adapted for swimming; and the tail, also, is a kind of swimmeret. This little animal can leave the fish upon which it feeds, and then swims freely in the water, usually in a straight line, but frequently and suddenly changing its direction, and sometimes turning over and over several times in succession. The stomach is remarkable for the large caecal prolongations which it sends out on either side, immediately beneath the shell; for these subdivide and ramify in such a manner that they are distributed almost as minutely as the caecal prolongations of the stomach of the *Planaria* (fig. 714). The proper alimentary canal, however, is continued backwards from the central cavity of the stomach, as an intestinal tube, which terminates in an anal orifice at the extremity of the abdomen. A far more remarkable departure from the typical form of the class is shown in the *Lernaea*, which is found attached to the gills of fishes. This creature has a long suctorial proboscis; a short thorax, to which is attached a single pair of legs, which meet at their extremities, where they bear a sucker which helps to give attachment to the parasite; a large abdomen; and a pair of pendent egg-sacs. In its adult condition it buries its anterior portion in the soft tissue of the animal it infests, and appears to have little or no power of changing its place. But the young, when they come forth from the egg, are as active as the young of *Cyclops* (fig. 720. C. D), which they much resemble; and only attain the adult form after a series of metamorphoses, in which they cast off their locomotive members and eyes. It is curious that the original form is retained with comparatively slight change by the males, which increase but little in size, and are so unlike the females that no one would suppose the two to belong to the same family, much less to the same species, but for the study of their development.¹

From the parasitic suctorial Crustacea the transition is not

¹ As the group of suctorial Crustacea is interesting rather to the professed naturalist than to the amateur microscopist, even an outline view of it would be unsuitable to the present work; and the Author would refer such of his readers as may desire to study it to the excellent treatise by Dr. Baird already referred to. Of the numerous recent essays and memoirs those of Professor Claus should by all means be consulted. Mr. P. W. Bassett-Smith, Staff-surgeon R.N., has in the last few years published several interesting papers.

really so abrupt as it might at first sight appear to the group of *Cirripedia*, consisting of the *barnacles* and their allies; for these, like many of the *Suctorioria*, are fixed to one spot during the adult portion of their lives, but come into the world in a condition that bears a strong resemblance to the early state of many other Crustacea. The departure from the ordinary crustacean type in the adults is, in fact, so great that it is not surprising that zoölogists in general should have ranked them in a distinct class, their superficial resemblance to the Mollusca, indeed, having caused most systematists to place them in that series, until due weight was given to those structural features which mark their 'articulated' character. We must limit ourselves, in our notice of this group, to that very remarkable part of their history, the microscopic study of which has contributed most essentially to the elucidation

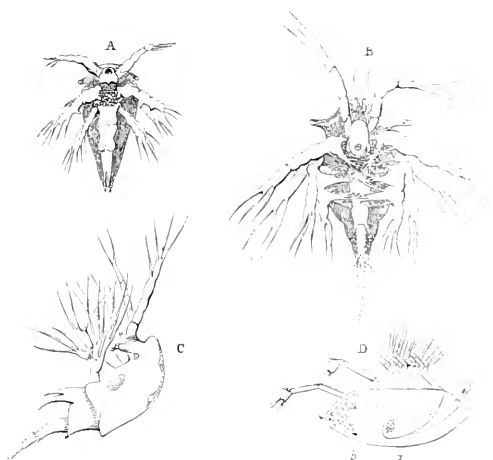

FIG. 721.—Development of *Balanus balanoides*: A, earliest form; B, larva after second moult; C, side view of the same; D, stage immediately preceding the loss of activity; a, stomach (?); b, nucleus of future attachment (?).

of their real nature. The observations of Mr. J. V. Thompson,¹ with the extensions and rectifications which they have subsequently received from others (especially Mr. Spence Bate² and Mr. Darwin³), show that there is no essential difference between the early forms of the *sessile* Cirripeds (*Balanida* or 'acorn-shells') and of the *pedunculated* (*Lepadida* or 'barnacles'); for both are active little animals (fig. 721, A), possessing three pairs of legs and a pair of compound eyes, and having the body covered with an expanded carapace, like that of many entomostracous crustaceans, so as in no

¹ *Zöological Researches*, No. IV. 1830, and *Phil. Trans.* 1835, p. 355.

² 'On the Development of the Cirripedia' in *Ann. Nat. Hist.* ser. ii. vol. viii. 1851, p. 324.

³ *Monograph of the Sub-Class Cirripedia*, published by the Ray Society.

essential particular to differ from the larva of *Cyclops* (fig. 720, C). After going through a series of metamorphoses, one stage of which is represented in fig. 721, B, C, these larvæ come to present a form, D, which reminds us strongly of that of *Daphnia*, the body being inclosed in a shell composed of two valves, which are united along the back, whilst they are free along their lower margin, where they separate for the protrusion of a large and strong anterior pair of prehensile limbs, provided with an adhesive sucker and hooks, and of six pairs of posterior legs adapted for swimming. This bivalve shell, with the members of both kinds, is subsequently thrown off; the animal then attaches itself by its *head*, a portion of which, in the barnacle, becomes excessively elongated into the 'peduncle' of attachment, whilst in *Balanus* it expands into a broad disc of adhesion; the first thoracic segment sends backwards a prolongation which arches over the rest of the body, so as completely to inclose it, and of which the exterior layer is consolidated into the 'multi-valve' shell; whilst from the other thoracic segments are evolved the six pairs of *cirri*, from whose peculiar character the name of the group is derived. These are long, slender, many-jointed, tendril-like appendages, fringed with delicate filaments covered with cilia, whose action serves both to bring food to the mouth and to maintain aërating currents in the water. The balani are peculiarly interesting objects in the aquarium on account of the pumping action of their beautiful feathery appendages, which may be watched through a tank microscope; and their cast skins, often collected by the tow-net, are well worth mounting.¹

Malacostraca.—The chief points of interest to the microscopist in the more highly organised forms of Crustacea are furnished by the structure of the exoskeleton, and by the phenomena of *metamorphosis*, both which may be best studied in the commonest kinds. The exoskeleton of the *Decapods* in its most complete form consists of three strata, viz. 1, a horny structureless layer covering the exterior; 2, an areolated stratum; and 3, a laminated tubular substance. The innermost and even the middle layers, however, may be altogether wanting; thus, in the larval forms known as *Phyllosomata* or 'glass-crabs,' the envelope is formed by the transparent horny layer alone; and in many of the small crabs belonging to the genus *Portunus* the whole substance of the carapace beneath the horny investment presents the areolated structure. It is in the large thick-shelled crabs that we find the three layers most differentiated. Thus in the common *Cancer pagurus* we may easily separate the structureless horny covering after a short maceration in dilute acid; the areolated layer, in which the pigmentary matter of the coloured parts of the shell is chiefly contained, may be easily brought into view by grinding away from the *inner* side as flat a piece as can be selected, having first cemented the outer surface to the glass slide, and by examining this with a magnifying power of 250 diameters, driving a strong light through it with the achromatic condenser;

¹ Valuable details as to the structure of this group will be found in Dr. P. P. C. Hoek's report on the Cirripeds collected by H.M.S. *Challenger*. Compare, also, M. Nussbaum, *Anatomische Studien*, Bonn, 1890.

whilst the tubular structure of the thick inner layer may be readily demonstrated by means of sections parallel and perpendicular to its surface. This structure, which resembles that of *dentine*, save that the tubuli do not branch, but remain of the same size through their whole course, may be particularly well seen in the black extremity of the claw, which (apparently from some peculiarity in the molecular arrangement of its mineral particles) is much denser than the rest of the shell, the former having almost the semi-transparence of ivory, whilst the latter has a chalky opacity. In a transverse section of the claw the tubuli may be seen to radiate from the central cavity towards the surface, so as very strongly to resemble their arrangement in a tooth; and the resemblance is still further increased by the presence, at tolerably regular intervals, of minute sinuosities corresponding with the laminations of the shell, which seem, like the 'secondary curvatures' of the dentinal tubuli, to indicate successive stages in the calcification of the animal basis. In thin sections of the areolated layer it may be seen that the apparent walls of the areole are merely translucent spaces from which the tubuli are absent, their orifices being abundant in the intervening spaces.¹ The tubular layer rises up through the pigmentary layer of the crab's shell in little papillary elevations, which seem to be concretionary nodules; and it is from the deficiency of the pigmentary layer at these parts that the coloured portion of the shell derives its minutely speckled appearance. Many departures from this type are presented by the different species of decapods: thus in the prawns there are large stellate pigment-spots resembling those of frogs, the colours of which are often in remarkable conformity with those of the bottom of the rock-pools frequented by these creatures; whilst in the shrimps there is seldom any distinct trace of the areolated layer, and the calcareous portion of the skeleton is disposed in the form of concentric rings, which seem to be the result of the concretionary aggregation of the calcifying deposit.²

It is a very curious circumstance that a strongly marked difference exists between crustaceans that are otherwise very closely allied in regard to the degree of change to which their young are subject in their progress towards the adult condition. For, whilst the common crab, lobster, spiny lobster, prawn, and shrimp undergo a regular metamorphosis, the young of the crayfish and some land-crabs come forth from the egg in a form which corresponds in all essential particulars with that of their parents. Generally speaking, a strong resemblance exists among the young of all the species of decapods which undergo a metamorphosis, whether they are afterwards to belong to the *macrurous* (long-tailed) or to the *brachyurous* (short-tailed) division of the group; and the forms

¹ The Author is now quite satisfied of the correctness of the interpretation put by Professor Huxley (see his article, 'Tegumentary Organs,' in the *Cyclop. Anat. and Phys.* vol. v. p. 487), and by Professor W. C. Williamson ('On some Histological Features in the Shells of Crustacea' in *Quart. Journ. Microsc. Sci.* vol. viii. 1860, p. 38) upon the appearances which he formerly described (*Report of British Association* for 1847, p. 128) as indicating a cellular structure in this layer.

² Consult Braun, 'Ueber die histologischen Vorgänge bei der Häutung von *Astacus fluviatilis*,' *Arbeit. Zool. Inst. Würzburg*, ii. p. 121.

of these larvæ are so peculiar, and so entirely different from any of those into which they are ultimately to be developed, that they were considered as belonging to a distinct genus, *Zoëa*, until their real nature was first ascertained by Mr. J. V. Thompson. Thus, in the earliest state of *Carcinus maenas* (small edible crab), we see the head and thorax, which form the principal bulk of the body, included within a large carapace or shield (fig. 722, A) furnished with a long projecting spine, beneath which the fin-feet are put forth; whilst the abdominal segments, narrowed and prolonged, carry at the end a flattened tail-fin, by the strokes of which upon the water the propulsion of the animal is chiefly effected. Its condition is hence comparable, in almost all essential particulars, to that of *Cyclops*. In the case of the lobster, prawn, and other 'macrurous' species, the metamorphosis chiefly consists in the separation of the locomotor and respiratory organs, true legs being developed from the thoracic segments for the former, and true gills (concealed within a special chamber formed by an extension of the carapace beneath the

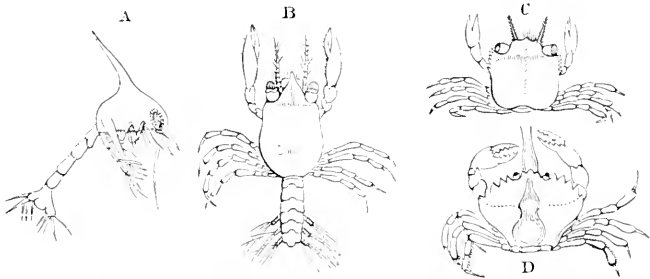

FIG. 722.—Metamorphosis of *Carcinus maenas*: A, first or *Zoëa* stage; B, second or *Megalopa* stage; C, third stage, in which it begins to assume the adult form; D, perfect form.

body) for the latter: while the abdominal segments increase in size and become furnished with appendages (false feet) of their own. In the crabs, or 'brachyurous' species, on the other hand, the alteration is much greater: for, besides the change first noticed in the thoracic members and respiratory organs, the thoracic region becomes much more developed at the expense of the abdominal, as seen at B, in which stage the larva is remarkable for the large size of its eyes, and hence received the name of *Megalopa*, when it was supposed to be a distinct type. In the next stage, C, we find the abdominal portion reduced to an almost rudimentary condition, and bent under the body: the thoracic limbs are more completely adapted for walking, save the first pair, which are developed into *chela* or pincers: and the little creature entirely loses the active swimming habits which it originally possessed, and takes on the mode of life peculiar to the adult.¹

In collecting minute Crustacea the ring-net should be used for

¹ On the metamorphoses of Crustacea and Cirripedia, see especially the *Untersuchungen über Crustaceen* of Professor Claus, Vienna, 1876. A number of

the fresh-water species, and the tow-net for the marine. In localities favourable for the latter the same 'gathering' will often contain multitudes of various species of Entomostraca, accompanied perhaps by the larvæ of higher Crustacea, echinoderm larvæ, annelid larvæ, and the smaller *Medusa*. The water containing these should be put into a large glass jar, freely exposed to the light; and, after a little practice, the eye will become so far habituated to the general appearance and modes of movement of these different forms of animal life as to be able to distinguish them one from the other. In selecting any specimen for microscopic examination the dipping-tube will be found invaluable. The collector will frequently find *Megalopa* larvæ, recognisable by the brightness of their two black eye-spots, on the surface of floating leaves of *Zostera*. The study of the metamorphosis will be best prosecuted, however, by obtaining the fertilised eggs, which are carried about by the females, and watching the history of their products. For preserving specimens, whether of Entomostraca or of larvæ of the higher Crustacea, the Author would recommend sterilised glycerin-jelly as the best medium.

interesting facts and speculations on the Crustacea will be found in F. Müller's *Facts and Arguments for Darwin* (London, 1869). The work of Reichenbach on the Development of the Crayfish is contained in vol. xxix. of the *Zeitschr. f. wiss. Zöol.* p. 123, 1877, and vol. xiv. of the *Abhandl. Senckenberg. Naturf. Gesells.* 1886. See also the essay, by W. K. Brooks, On the Development of *Lucifer*, in *Phil. Trans.* 1882, p. 57. Mr. F. H. Herrick's memoir on the American Lobster (*Bull. U.S. Fish. Comm.* xv. [1895]) contains matter of much interest. Professor Sars's fully illustrated monograph of the Crustacea of Norway is being steadily and rapidly published.

CHAPTER XXI

INSECTS AND ARACHNIDA

THERE is no class in the whole animal kingdom which affords to the microscopist such a wonderful variety of interesting objects, and such facilities for obtaining an almost endless succession of novelties, as that of insects. For in the first place, the number of different kinds that may be brought together (at the proper time) with extremely little trouble far surpasses that which any other group of animals can supply to the most painstaking collector; then, again, each specimen will afford to him who knows how to employ his materials a considerable number of microscopic objects of very different kinds; and thirdly, although some of these objects require much care and dexterity in their preparation, a large proportion may be got out, examined, and mounted with very little skill or trouble. Take, for example, the common house-fly; its *eyes* may be easily mounted, one as a transparent, the other as an opaque object; its *antennæ*, although not such beautiful objects as those of many other Diptera, are still well worth examination; its *tongue* or 'proboscis' is a peculiarly interesting object, though requiring some care in its preparation; its *spiracles*, which may be easily cut out from the sides of its body, have a very curious structure; its alimentary canal affords a very good example of the minute distribution of the *tracheæ*; its *wing*, examined in a living specimen newly come forth from the pupa state, exhibits the circulation of the blood in the 'nervures,' and when dead shows a most beautiful play of iridescent colours, and a remarkable areolation of surface, when examined by light reflected from its surface at a particular angle; its *foot* has a very peculiar conformation, which is doubtless connected with its singular power of walking over smooth surfaces in direct opposition to the force of gravity, while the structure and physiology of its *sexual* apparatus, with the history of its development and metamorphoses, would of itself suffice to occupy the whole time of an observer who should desire thoroughly to work it out, not only for months, but for years.¹ Hence, in treating of this department in such a work as the present, the Author labours under the *embarras des richesses*; for, to enter into such a description of the parts of the structure of insects most interesting to the microscopist as should

¹ See Mr. Lowne's valuable treatise on *The Anatomy and Physiology of the Blow-fly*, 1870; second edition 1891-4.

be at all comparable in fulness with the accounts which it has been thought desirable to give of other classes would swell out the volume to an inconvenient bulk; and no course seems open but to limit the treatment of the subject to a notice of the *kinds* of objects which are likely to prove most generally interesting, with a few illustrations that may serve to make the descriptions more clear, and with an enumeration of some of the sources whence a variety of specimens of each class may be most readily obtained. And this limitation is the less to be regretted, since there already exist in our language numerous elementary treatises on entomology, wherein the general structure of insects is fully explained, and the conformation of their minute parts as seen with the microscope is adequately illustrated.¹

A considerable number of the smaller insects—especially those belonging to the orders *Coleoptera* (beetles), *Neuroptera* (dragon-fly, May-fly, &c.), *Hymenoptera* (bee, wasp, &c.), and *Diptera* (two-winged flies)—may be mounted entire as opaque objects for low magnifying powers, care being taken to spread out their legs, wings, &c., so as adequately to display them, which may be accomplished, even after they have dried in other positions, by softening them by steeping them in hot water, or, where this is objectionable, by exposing them to steam. Directions on this point, applicable to small and large insects alike, may be found in various text-books of entomology. There are some, however, whose translucence allows them to be viewed as transparent objects, and these are either to be mounted in Canada balsam or in Dean's medium, glycerin jelly, or Farrant's gum, according to the degree in which the horny opacity of their integument requires the assistance of the balsam to facilitate the transmission of light through it, or the softness and delicacy of their textures render an aqueous medium more desirable. Thus an ordinary *flea* or *bug* will best be mounted in balsam: but the various parasites of the *louse* kind, with some or other of which almost every kind of animal is affected, should be set up in some of the 'media.' Some of the aquatic larvæ of the *Diptera* and *Neuroptera*, which are so transparent that their whole internal organisation can be made out without dissection, are very beautiful and interesting objects when examined in the living state, especially because they allow the circulation of the blood and the action of the dorsal vessel to be discerned. Among these there is none preferable to the larva of the *Ephemera marginata* (day-fly), which is distinguished by the possession of a number of beautiful appendages on its body and tail, and is, moreover, an extremely common inhabitant of our ponds and streams. This insect passes two or even three years in its larval state, and during this time it repeatedly throws off its skin; the cast skin, when perfect, is an object of extreme beauty, since, as it formed a complete sheath to the various appendages of the body and tail, it continues to exhibit their outlines with the utmost delicacy; and by keeping these larvæ

¹ An excellent introduction to the study of insects will be found in *The Structure and Life-history of the Cockroach*, by L. C. Miall and A. Denny (London, 1886). See also Dr. D. Sharp in the *Cambridge Natural History*.

in an aquarium, and by mounting the entire series of their cast skins, a record is preserved of the successive changes they undergo. Much care is necessary, however, to extend them upon slides in consequence of their extreme fragility; and the best plan is to place the slip of glass under the skin whilst it is floating on water, and to lift the object out upon the slide. Thin *sections* of insects, caterpillars, &c., which bring the internal parts into view in their normal relations, may be cut with the microtome by first soaking the body (as suggested by Dr. Halifax) in thick gum-mucilage, which passes into its substance, and gives support to its tissues, and then inclosing it in a casing of melted paraffin made to fit the cavity of the section-instrument.

Structure of the Integument.—In treating of these separate parts of the organisation of insects which furnish the most interesting objects of microscopic study we may most appropriately commence with their integument and its appendages (scales, hairs, &c.). The body and members are closely invested by a hardened skin, which acts as their skeleton, and affords points of attachment to the muscles by which their several parts are moved, being soft and flexible, however, at the joints. This skin is usually more or less horny in its texture, and is consolidated by the animal substance termed *chitine*, as well as in some cases by a small quantity of mineral matter. It is in the Coleoptera that it attains its greatest development, the ‘dermo-skeleton’ of many beetles being so firm as not only to confer upon them an extraordinary power of passive resistance, but also to enable them to put forth enormous force by the action of the powerful muscles which are attached to it. The outer layer of this dermo-skeleton is continuous, the cells which secrete it lying beneath the parallel laminae of which it is made up; on the surface the chitinous cuticle may be seen to be marked out into a number of polygonal (usually hexagonal) areas which correspond to the subjacent secreting cells. Of this we have a very good example in the *superficial* layers (fig. 737. B) of the thin horny lamellae or blades which constitute the terminal portion of the antenna of the cockchafer, this layer being easily distinguished from the intermediate portion (A) of the lamina by careful focussing. In many beetles the hexagonal areolation of the surface is distinguishable when the light is reflected from it at a particular angle, even when not discernible in transparent sections. The integument of the common *red ant* exhibits the hexagonal cellular arrangement very distinctly throughout; and the broad flat expansion of the leg of the *Cyabro* (‘sand wasp’) affords another beautiful example of a distinctly cellular arrangement of the outer layer of the integument. The inner layer, however, which constitutes the principal part of the thickness of the horny casing of the beetle tribe, seldom exhibits any distinct organisation, though it may be usually separated into several lamellae, which are sometimes traversed by tubes that pass into them from the inner surface, and extend towards the outer without reaching it.

Tegumentary Appendages—The surface of the insects is often beset, and is sometimes completely covered, with *appendages* having

either the form of broad flat scales or that of hairs more or less approaching the cylindrical shape, or some form intermediate between the two. The *scaly* investment is most complete among the *Lepidoptera* (butterfly and moth tribe), the distinguishing character of the insects of this order being derived from the presence of a regular layer of scales upon each side of their large membranous wings. It is to the peculiar coloration of the scales that the various hues and figures are due, by which these wings are so commonly distinguished, all the scales on one patch (for example) being green, those of another red, and so on; for the subjacent membrane remains perfectly transparent and colourless when the scales have been brushed off from its surface. Each scale seems to be composed of two or more membranous lamellæ, often with an intervening deposit of pigment, on which, especially in *Lepidoptera*, their colour depends. Certain scales, however, especially in the beetle tribe, have a metallic lustre, and exhibit brilliant colours that vary with the mode in which the light glances from them; and this 'iridescence,' which is specially noteworthy in the scales of the *Curculio imperialis* ('diamond beetle'), seems to be a purely optical effect, depending either (like the prismatic hues of a soap-bubble) on the extreme thinness of the membranous lamellæ, or (like those of 'mother-of-pearl') on a lineation of surface produced by their corrugation. Each scale is furnished at one end with a sort of handle or 'pedicle' (figs. 723, 724), by which it is fitted into a minute socket attached to the surface of the insect; and on the wings of *Lepidoptera* these sockets are so arranged that the scales lie in very regular rows, each row overlapping a portion of the next, so as to give to their surface, when sufficiently magnified, very much the appearance of being *tiled* like the roof of a house. Such an arrangement is said to be 'imbricated.' The forms of these scales are often very curious, and frequently differ a good deal on the several parts of the wings and of the body of the same individual, being usually more expanded on the former and narrower and more hairlike on the latter. A peculiar type of scale, which has been distinguished by the designation *plumule*, is met with among the *Pierida*, one of the principal families of the diurnal *Lepidoptera*. The 'plumules' are not flat, but cylindrical or bellows-shaped, and are hollow; they are attached to the wing by a bulb at the end of a thin elastic peduncle that differs in length in different species, and proceeds from the broader, not from the narrower end of the scale; whilst the free extremity usually tapers off and ends in a kind of brush, though sometimes it is broad and has its edge fringed with minute filaments. These 'plumules,' which are peculiar to the males, are found on the upper surface of the wings, partly between and partly under the ordinary scales. They seem to be represented among the *Lycanida* by the 'battledore' scales to be presently described.¹

The peculiar markings exhibited by many of the scales very early attracted the attention of opticians engaged in the application of

¹ See Mr. Watson's memoirs 'On the Scales of Battledore Butterflies,' in *Monthly Microscopical Journal*, ii. pp. 73, 314.

achromatism to the microscope; for, as the clearness and strength with which they could be shown were found to depend on the degree to which the angular aperture of an objective could be opened without sacrifice of perfect correction for spherical and chromatic aberration, such scales proved very serviceable as 'tests.' The Author can well remember the time when those of the *Morpho Menelaus* (fig. 723), the ordinary and 'battledore' scales of the *Polyommatus Argus* (figs. 724, 725), and the scales of the *Lepisma saccharina* (fig. 726), which are now only used for testing objects of *low* or *medium* power, were the recognised tests for objects of *high* power; while the exhibition of alternating light and dark bands on a *Podura* scale was regarded as a first-rate performance. It is easy for anyone possessed of a good apochromatic objective of 6 mm. ($\frac{1}{2}$ inch) to obtain all the characteristic features of the scale; but

the determination of the method of construction of the scale and the proper interpretation of the 'markings' is a matter that the wise microscopist will prefer to relegate to the days when the apertures of our best present lenses will be looked upon comparatively as we now look upon the earliest achromatic objectives. No one can give a fairly comprehensive and satisfactory suggestion of the true nature of the *Podura* scale, and yet on no *one* object has microscopy lavished so much labour for so many years.

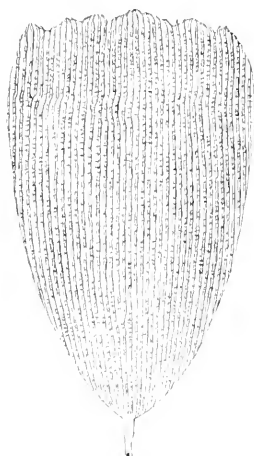

FIG. 723.—Scale of *Morpho Menelaus*.

The easier test scales are furnished by the *Lepidoptera* (butterflies and moths), and among the most beautiful of these, both for colour and for regularity of marking, are those of the *Morpho Menelaus* (fig. 723). These are of a rich blue tint, and exhibit strong longitudinal striae, which seem due to

ribbed elevations of one of the superficial layers. There is also an appearance of transverse striation, which cannot be seen at all with an inferior objective, but becomes very decided with a good objective of medium focus; and this is found, when submitted to the test of a high power and good illumination, to depend upon the presence of transverse thickenings or corrugations (fig. 723), probably on the internal surface of one of the membranes. The large scales of the *Polyommatus Argus* ('azure blue' butterfly) resemble those of the *Menelaus* in form and structure, but are more delicately marked (fig. 724). Their ribs are more nearly parallel than those of the *Menelaus* scale, and do not show the same transverse striation. When one of these scales lies partly over another, the effect of the optical intersection of the two sets of ribs at an oblique angle is to produce a set of interrupted striations (*b*), very much resembling those of the *Podura* scale. The same butterfly furnishes smaller scales, which are com-

monly termed the 'battledore' scales, from their resemblance in form to that object (fig. 724, *a*). These scales, which occur in the males of several genera of the family *Lycanidae*, and present a considerable variety of shape,¹ are marked by narrow longitudinal ribbings, which at intervals seem to expand into rounded or oval elevations that give to the scales a dotted appearance (fig. 725); at the lower part of the scale, however, these dots are wanting. Dr. Anthony describes and figures them as elevated bodies, somewhat resembling dumb-bells or shirt-studs, ranged along the ribs, and standing out from the general surface.² Other good observers, however, whilst recognising the stud-like bodies described by Dr. Anthony, regard them as not projecting from the external surface of the scale, but as interposed between its two lamellæ;³ and this view seems to the Author to be more conformable than Dr. Anthony's to general probability.

The more difficult 'test scales' are furnished by little wingless insects ranked together by Latreille in the order *Thysanura*, but

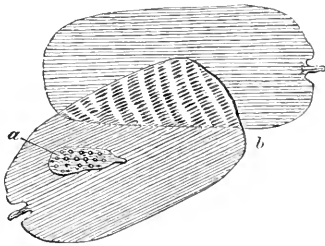

FIG. 724.—Scales of *Polyommatus Argus* (azure blüe): *a*, battledore scale; *b*, interference striae.



FIG. 725.—Battledore scale of *Polyommatus Argus* (azure blue).

now separated by Sir John Lubbock,⁴ on account of important differences in internal structure, into the two groups *Collembola* and true *Thysanura*. Of the former of these the *Lepismida* constitute the typical family; and the scale of the common *Lepisma saccharina*, or 'sugar-louse,'⁵ very early attracted the attention of

¹ See Watson, *loc. cit.*

² 'The Markings on the Battledore Scales of some of the *Lepidoptera*' in *Monthly Microscopical Journal*, vol. vii. 1872, pp. 1, 250.

³ See 'Proceedings of the Microscopical Society,' *op. cit.* p. 278.

⁴ See his *Monograph of the Collembola and Thysanura*, published by the Ray Society, 1872.

⁵ This insect may be found in most old houses, frequenting damp warm cupboards, and especially such as contain sweets; it may be readily caught in a small pill-box, which should have a few pinholes in the lid; and if a drop of chloroform be put over the holes the imate will soon become insensible, and may be then turned out upon a piece of clean paper, and some of its scales transferred to a slip of glass by simply pressing this gently on its body.

microscopists on account of its beautiful shell-like sculpture. When viewed under a low magnifying power it presents a beautiful 'watered-silk' appearance, which, with higher amplification, is found to depend (as Mr. R. Beck first pointed out)¹ upon the intersection of two sets of striæ, representing the different structural arrangements of its two superficial membranes. One of its surfaces (since ascertained by Mr. Joseph Beck² to be the *under* or attached surface of the scale) is raised, either by corrugation or thickening, into a series of strongly marked longitudinal ribs, which run nearly *parallel* from one end of the scale to the other, and are particularly distinct at its margins and at its free extremity; whilst the other

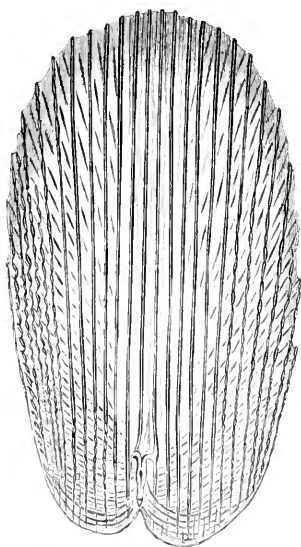

FIG. 726.—Scale of *Lepisma saccharinum*.

surface (the free or *outer*, according to Mr. J. Beck) presents a set of less definite corrugations, *radiating* from the pedicle, where they are strongest, towards the sides and free extremity of the scale, and therefore crossing the parallel ribs at angles more or less acute (fig. 726). It was further pointed out by Mr. R. Beck that the intersection of these two sets of corrugations at different angles produces most curious effects upon the appearances which optically represent them. For where the diverging ribs cross the longitudinal ribs very obliquely, as they do near the free extremity of the scale, the longitudinal ribs seem broken up into a series of 'exclamation markings,' like those of the *Podura*; but where the crossing is transverse or nearly so, as at the sides of the scale, an appearance is presented as of successions of large bright beads. The conclusion drawn by the Messrs. Beck, that these interrupted appearances are 'produced by two sets of uninterrupted lines on different surfaces,' has been confirmed by the careful investigations of Mr. Moorhouse.³ The minute beaded structure observed by Dr. Royston-Pigott⁴ alike in the ribs and in the intervening spaces may now be certainly regarded as an optical effect of diffraction. In the scale of a type nearly allied to *Lepisma*, the *Machilis polyptoda*, the very distinct ribbing (fig. 727) is produced by the corrugation of the under membranous lamina alone, the upper or exposed lamina being smooth, with the exception of slight undulations near the pedicle, and the cross-markings being due to structure between the superposed

¹ *The Achromatic Microscope*, p. 50.

² See his appendix to Sir John Lubbock's *Monograph*.

³ *Monthly Microscopical Journal*, vol. xi. 1874, p. 13, and vol. xviii. 1877, p. 31.

⁴ *Ibid.* vol. ix. 1873, p. 63.

membranes, probably a deposit on the interior surface of one or both of them.¹

Although the *Poduridae* and *Lepismidae* now rank as distinct families, yet they approximate sufficiently in general organisation, as well as in habits, to justify the expectation that their scales would be framed upon the same plan. The *Poduridae* are found amidst the sawdust of wine-cellars, in garden tool-houses, or near decaying wood, and derive their popular name of 'spring-tails' from the possession by many of them of a curious caudal appendage by which they can leap like fleas. This is particularly well developed in the species now designated *Lepilocyrtus curvicolis*, which furnishes what are ordinarily known as 'Podura' scales.

'When full grown and unrubbed,' says Sir John Lubbock, 'this species is very beautiful, and reflects the most gorgeous metallic tints.' Its scales are of different sizes and of different degrees of strength of marking (fig. 728, A, B), and are therefore by no means of uniform value as tests.

The general appearance of their surface, under a power not sufficient to resolve their markings, is that of watered silk, light and dark bands passing across it with wavy irregularity; but a well-corrected objective of very moderate aperture now suffices to resolve every dark band into a row of distinct 'exclamation marks.' A certain longitudinal continuity may be traced between the 'exclamation marks' in the ordinary test scale; but this is much more apparent in other scales from the same species (fig. 729), as well as in the scales of various allied types, which were carefully studied by the late Mr. R. Beck.² In certain other types, indeed, the scales have very distinct longitudinal parallel ribs, sometimes with regularly disposed cross-bars; these ribs, being confined to one surface only (that which is in contact with the body), are not subject to any such interference with their optical continuity as has been shown to occur in *Lepisma*; but more or less distinct indications of radiating corrugations often present themselves. The appearance of the interrupted 'exclamation marks' Mr. J. Beck considers to be due 'to irregular corrugations of the outer surface of the under membrane, to slight undulations on the outer surface of the upper membrane, and to structure between the superposed membranes.' It has, indeed, been stated by Mr. Joseph

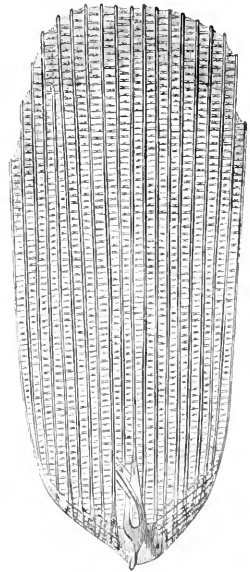

FIG. 727. —Scale of *Machilis polyppoda*.

¹ See Mr. Joseph Beck in Sir J. Lubbock's *Monograph*, p. 255.

² *Trans. Microsc. Soc.* n.s. vol. x. 1862, p. 83. See also Mr. Joseph Beck, in the appendix to Sir John Lubbock's *Monograph*, and in *Monthly Microscopical Journal*, iv. p. 253.

Beck that the scales of a lepidopterous insect belonging to the genus *Mormo*, which under a low power present the watered-silk appearance seen in the *Podura* scale, under a $\frac{1}{2}$ in. obj. show the 'exclamation markings,' whilst under a $\frac{1}{10}$ in. obj. they exhibit distinct ribs from pedicle to apex, thus showing in one scale how the appearances run from one into the other.¹

The *hairs* of many insects, and still more of their larvæ, are very interesting objects for the microscope on account of their branched or tufted conformation, this being particularly remarkable in those with which the common hairy caterpillars are so abundantly beset. Some of these afford very good tests for the perfect correction of objectives. Thus the hair of the *bee* is pretty sure to exhibit

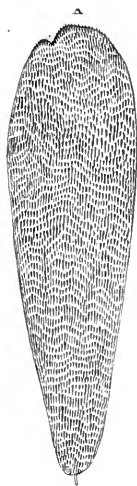

FIG. 728.—Test scales of *Lepidocyrtus curvicolis*: A, large strongly marked scale; B, small scale, more faintly marked.



FIG. 729.—Ordinary scale of *Lepidocyrtus curvicolis*.

strong prismatic colours if the chromatic aberration should not have been exactly neutralised; and that of the larva of a *Dermestes* (commonly, but erroneously, termed the 'bacon-beetle') was once thought a very good test of defining power, and is still useful for this purpose. It has a cylindrical shaft (fig. 730, B) with closely set whorls of spiny protuberances, four or five on each whorl; the highest of these whorls is composed of mere knobby spines; and the hair is surmounted by a curious circle of six or seven large filaments, attached by their pointed ends to its shaft, whilst at their free extremities they dilate into knobs. An approach to this structure is seen in the hairs of certain *Myriopods* (centipedes, galley-worms, &c.), of which an example is shown in fig. 730, A; but a beautiful photo-

¹ *Journ. Roy. Microsc. Soc.* vol. ii. 1879, p. 810. On the subject generally Dr. A. Spuler's 'Beitrag zur Kenntniss des feineren Baues . . . der Flügelbedeckung der Schmetterlinge,' in *Zool. Jahrb. Anat.* viii. should be consulted.

micrograph of the hair of *Polyxenus lagurus*, of the family *Polydesmida* (order *Chilognatha*), is given in fig. 6 of the frontispiece. This is one of the finest test objects for medium powers. Other minute forms of this class are most beautiful objects under the binocular microscope on account of the remarkable structure and regular arrangement of their hairs.

In examining the integument of insects and its appendages parts of the surface may be viewed either by reflected or transmitted light, according to their degree of transparency and the nature of their covering. The beetle and butterfly tribes furnish the greater number of the specimens suitable to be viewed as *opaque* objects; and nothing is easier than to mount portions of the *elytra* of the former (usually the most showy parts of their bodies), or of the wings of the latter, in the manner described in Chapter VII. The tribe of *Curculionida*, in which the surface is beset with scales having the most varied and lustrous hues, is distinguished among *Coleoptera* for the brilliancy of the objects it affords, the most remarkable in this respect being the well-known *Curculio imperialis*, or 'diamond beetle' of South America, parts of whose *elytra*, when properly illuminated and looked at with a low power, show like clusters of jewels flashing against a dark velvet ground. In many of the British *Curculionida*, which are smaller and far less brilliant, the scales lie at the bottom of little depressions of the surface; and if the *elytra* of the diamond beetle be carefully examined, it will be found that each of the clusters of scales which are arranged upon it in rows seems to rise out of a deep pit which sinks in by its side. The transition from scales to hairs is extremely well seen by comparing the different parts of the surface of the diamond beetle with each other. The beauty and brilliancy of many objects of this kind are increased by mounting them in cells in Canada balsam, even though they are to be viewed with reflected light; other objects, however, are rendered less attractive by this treatment; and in order to ascertain whether it is likely to improve or to deteriorate the specimen, it is a good plan first to test some other portion of the body having scales of the same kind by touching it with turpentine, and then to mount the part selected as an object, either in balsam or dry, according as the turpentine increases or diminishes the brilliancy of the scales on the spot to which it was applied. Portions of the wings of *Lepidoptera* are best mounted as opaque objects without any other preparation than gumming them flat down to the disc of the wooden slide, care being taken to avoid disturbing the arrangement of the scales and to keep the objects, when mounted, as secluded as possible from dust. In selecting such

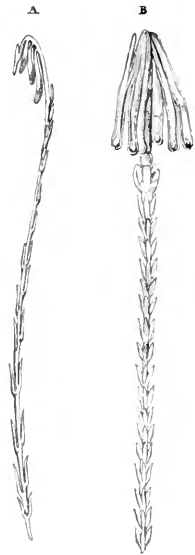

FIG. 730.—A, hair of *Myricopod*; B, hair of *Dermestes*.

portions it is well to choose those which have the brightest and the most contrasted colours, exotic butterflies being in this respect usually preferable to British; and before attaching them to their slides care should be taken to ascertain in what position, with the arrangement of light ordinarily used, they are seen to the best advantage, and to fix them there accordingly. Whenever portions of the integument of insects are to be viewed as *transparent* objects, for the display of their intimate structure, they should be mounted in Canada balsam, after soaking for some time in turpentine, since this substance has a peculiar effect in increasing their translucence. Not only the horny cases of perfect insects of various orders, but also of those of their pupæ, are worthy of this kind of study; and objects of great beauty (such as the chrysalis case of the emperor moth), as well as of scientific interest, are sure to reward such as may prosecute it with any assiduity. Further information may often be gained by softening such parts in potash and viewing them in fluid. The

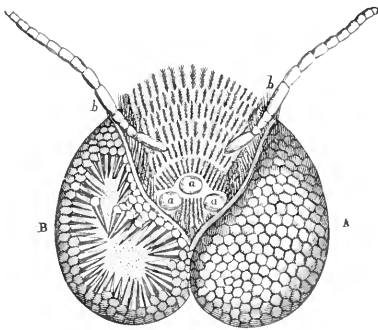

FIG. 731.—Head and compound eyes of the bee, showing the ocellites *in situ* on one side, A, and displaced on the other, B; a, a, a, stemmata; b, b, antennæ.

scales of the wings of Lepidoptera &c. are best transferred to the slide by simply pressing a portion of the wing either upon the slip of glass or upon the cover; if none should adhere the glass may first be gently breathed on. Some of them are best seen when examined 'dry,' whilst others are more clear when mounted in fluid; and for the determination of their exact structure it is well to have recourse to both these methods. Hairs, on the other hand, are best mounted in balsam.

Parts of the Head.—The *eyes* of insects, situated upon the upper and outer part of the head, are usually very conspicuous organs, and are frequently so large as to touch each other in front (fig. 731). We find in their structure a remarkable example of that multiplication of similar parts which seems to be the predominating 'idea' in the conformation of articulated animals; for each of the large protuberant bodies which we designate as *an eye* is really a 'compound' eye, made up of many hundred or even many thousand minute conical *ocelli* (B). Approaches to this structure are seen in Entomostraca; but the number of 'ocellites' thus grouped together is usually small. In the higher Crustacea, however, the 'ocelli' are very numerous; and their compound eyes are constructed upon the same general plan as those of insects, though their shape and position are often very peculiar. The individual ocelli are at once recognised when the 'compound eyes' are examined under even a low magnifying power by the 'faceted' appearance of the surface (fig. 731, A), which is marked out by very regular divisions either into hexagons

or squares; each facet is the 'corneule' of a separate ocellite, and has a convexity of its own; hence, by counting the facets, we can ascertain the number of ocelli in each 'compound eye.' In the two eyes of the common fly there are as many as 4,000; in those of the cabbage-butterfly there are about 17,000; in the dragon-fly 24,000; and in the Mordella beetle 25,000. The structure of the arthropod eye is best explained by a comparative account of the various stages of complication which it presents. In various larvæ the cuticular layer is modified to form a single lens, behind which are simple, separate, elongated hypodermic cells, some of which are continuous with fine branches of the optic nerve; these may be called retinal cells. The next stage in complication is seen when these last combine to form groups, 'retinule;': the sensitive cells may become divided into two regions, an outer one, which is 'vitreous' and refractive in function, while the inner part remains sensitive; the corneal surface may become broken up into a number of facets, each of which corresponds to one of the 'pyramids' so formed, and within the retinula there may be differentiated a rhabdom (see fig. 733) formed by the nerve-rod.

After traversing the pyramids the rays reach the extremities of the fibres of the optic nerve, which are surrounded, like the pyramid, by pigmentary substance. Thus the rays which have passed through the several 'corneules' are prevented from mixing with each other; and no rays, save those which pass in the axes of the pyramids, can reach the fibres of the optic nerve. Hence, it is evident that, as no two ocelli on the same side (fig. 731) have exactly the same axis, no two can receive their rays from the same point of an object; and thus, as each compound eye is immovably fixed upon the head, the combined action of the entire aggregate will probably afford but

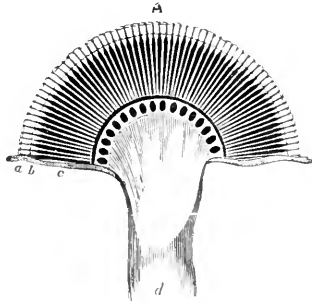

FIG. 732.—Diagram of a section of the composite eye of *Melolontha vulgaris* (cockchafer): *a*, facets of the cornea; *b*, transparent pyramids surrounded with pigment; *c*, fibres of the optic nerve; *d*, trunk of the optic nerve.

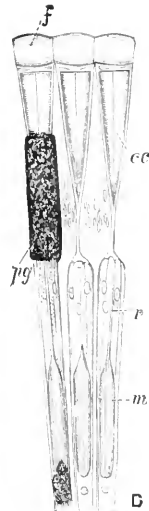

FIG. 733.—Part of the compound eye of *Phryganica*; the retinal cells are seen to be united into a retinula (*r*) which is differentiated into a rhabdom (*m*) posteriorly; *cc*, crystalline cone; *f*, facet of compound eye; *pg*, pigment. (After Grenacher.)

a single image, resembling that which we obtain by means of our single eyes. This judgment has received a confirmation as unexpected as it is complete and beautiful. The subject of the real nature of compound vision can be considered no longer a matter of doubt. We have as complete evidence of its character as we have of that of vision by vertebrate eyes. It is to Professor S. Exner, of Vienna, that we are indebted for the striking though simple results. He has been engaged for years on cognate researches, and has at length succeeded in taking a photo-micrograph of the image presented at the back of a compound insect eye in precisely the same manner as a similar photograph might be taken with the retina removed at the back of the eye of one of the higher vertebrates.

The demonstration was satisfactorily made, and the present Editor is indebted for a knowledge of the following details to the courtesy of a private communication from Professor Exner.

The general result of the researches on the subject is presented in fig. 734, which is the image at the back of the compound eye

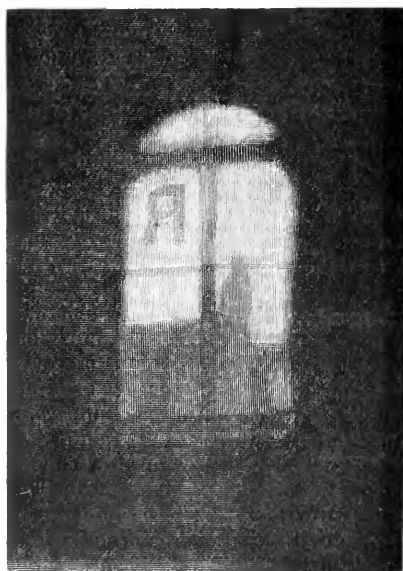

FIG. 734.—Image of a window with the letter R on one of its panes, and a church beyond, taken through the compound eye of *Lampyris splendida*, and magnified 120 diams.

of *Lampyris splendida* (fire-fly), in the position in which it would be portrayed upon the retina, but magnified 120 diameters. On to the window pane a letter R cut out in black was fixed; the distance of the window from the eye was 225 cm., while the distance of the church from the window through which it is seen in the magnified image was 135 paces.

The result is unmistakable; there may appear to be some matters of interest still needing interpretation, but these are explained in the monograph by Exner, giving the complete details of the method he adopted and the mathematical explanation of the results he obtained. The rectitude of the image and the reversion of the R are certainly noteworthy; and as a contribution to our knowledge of the physiology

of sight in insects and other animals with compound eyes, the importance of the result obtained by the ingenuity and skill of Professor Exner is great, giving us a new start on solid ground. The mathematics of the question are fully discussed by Exner in a memoir, to

which the student must be referred for complete information.¹ The kind of image formed by the compound eye has long been a matter of discussion amongst physiologists.²

The process of taking the photo-micrograph copied in fig. 734 was this: The eye of the *Lampyris* was carefully dissected out from the head, the retina and pigment removed with a fine camel-hair pencil, and the back of the eye immersed in a mixture of glycerin and water, possessing a refractive index of 1.346; this was already known to be the refractive index of the blood of the *Lampyris*. The whole was placed upon an ordinary cover-glass, this being fixed by its edges to a slide or object-carrier with a circular aperture cut in it, as in fig. 735. *C*: *a* is the slide with an aperture less in diameter

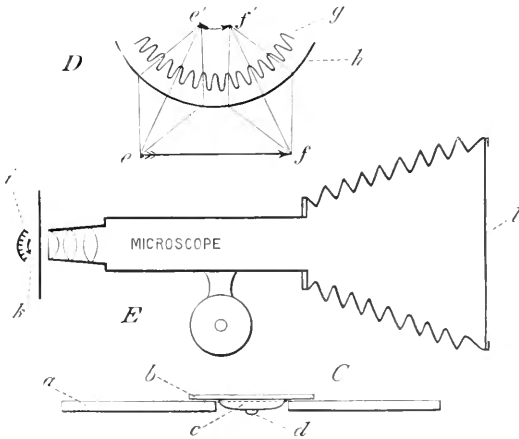

FIG. 735.—Diagrammatic illustration of the method by which the image in fig. 734 was photo-micrographed.

than the cover-glass *b* cut through it; *c* is the fluid-medium of $n=1.346$ in which the back parts of the eye are immersed, thus fulfilling the conditions of living sight, while the cornea with its lenses is shown at *d*, being, as in the normal state, in air. If the eye

¹ *Sitzungsber. Akad. Wissensch. Wien*, Bd. xxviii. (1889), pp. 13, 143; also *Die Physiologie der facettirten Augen von Krebsen und Insecten* (Leipzig und Wien, 1891).

² A critical history of the discussion will be found in Chapter VII. of Sir J. Lubbock's *Senses of Animals* (London, 1888), and in Dr. D. Sharp's Annual Address to the Entomological Society of London, 1888 (1889). See also Mr. A. Mallock in *Proc. Roy. Soc. Lond.* vol. iv. p. 85. The question of the physiology of the compound eye of Arthropods has given rise to much discussion. For further details as to its structure consult Grenacher's great work, *Untersuchungen über das Sehorgan der Arthropoden* &c. (Göttingen, 1879); Carrière, *Die Sehorgane der Thiere* &c. (Munich and Leipzig, 1885); Hickson, 'The Eye and Optic Tract of Insects,' *Quart. Journ. Microsc. Sci.* xxv. p. 215; Lankester and Bonne, 'The Minute Structure of the Lateral and Central Eyes of Scorpio and Limulus,' *Quart. Journ. Microsc. Sci.* xxiii. p. 177; Lowne, 'On the Compound Vision and the Morphology of the Eye in Insects,' *Trans. Linn. Soc.* (2), ii. p. 389; Patten, 'Eyes of Molluscs and Arthropods,' *Mitth. Zool. Stat. Neapel*, vi.

be now examined with a microscope (the C of Zeiss was employed), the 'lenses' will be distinctly seen, but if the focus be readjusted to the focal plane of the image in the eye this image will be seen and magnified. This will be understood from D (fig. 735), where e, f represent the image, h the cornea with its 'lenses', $g, e'-f'$ being the image of the object thrown upon the position from which the retina has been removed, and which is now made the focal plane of the objective employed.

It was this image ($e'-f'$) which was photographed in the ordinary manner with a Zeiss photo-micrographic apparatus and the C object-glass. The manner in which this was done is seen diagrammatically at E (fig. 735), where i indicates the cornea of the eye exposed to air, k the image thrown through the 'lenses' as a unified picture at the focal point of the microscope, and l is the sensitised plate on which the image was photographed. This piece of admirable research and its clear results have a value not only physiological but philosophical.

Although the structure already described may be considered as typical of the eyes of insects, yet there are various departures from it (most of them slight) in the different members of the class. Thus in some cases the posterior surface of each 'corneule' is concave; and a space is left between it and the iris-like diaphragm, which seems to be occupied by a watery fluid or 'aqueous humour.' In other instances, again, this space is occupied by a double-convex body, which seems to represent the 'crystalline lens,' and this body is sometimes found behind the iris, the number of ocelli being reduced, and each one being larger, so that the cluster presents more resemblance to that of spiders, &c. Besides their 'compound' eyes, insects usually possess a small number of 'simple' eyes (termed *ocelli* or *stemmata*) seated upon the top of the head (fig. 731, *a, a, a*). Each of these consists of a single very convex corneule, to the back of which proceeds a bundle of rods that are in connection with fibrils of the optic nerve. Such ocelli are the only visual organs of the larvæ of insects that undergo complete metamorphosis, the 'compound' eyes being only developed towards the end of the pupa stage.

Various modes of preparing and mounting the eyes of insects may be adopted, according to the manner wherein they are to be viewed. For the observation of their external faceted surface by reflected light it is better to lay down the entire head, so as to present a front face or a side face, according to the position of the eyes, the former giving a view of *both* eyes when they approach each other so as nearly or quite to meet (as in fig. 731), whilst the latter will best display *one* when the eyes are situated more at the sides of the head. For the minuter examination of the 'corneules,' however, these must be separated from the hemispheroidal mass whose exterior they form by prolonged maceration, and the pigment must be carefully washed away by means of a fine camel-hair brush from the inner or posterior surface. In flattening them out upon the glass slide one of two things must necessarily happen: either the margin must tear when the central portion is pressed

down to a level, or, the margin remaining entire, the central portion must be thrown into plaits, so that its corneules overlap one another. As the latter condition interferes with the examination of the structure much more than the former does, it should be avoided by making a number of slits in the margin of the convex membrane before it is flattened out. Vertical sections, adapted to demonstrate the structure of the ocelli and their relations to the optic nerve, can be only made when the insect is fresh or has been preserved in strong spirit. Mr. Lowie recommends that the head should be hardened in a 2 per cent. solution of chromic acid, and then imbedded in cacao butter; the sections must be cut *very* thin, and should be mounted in Canada balsam. The following are some of the insects whose eyes are best adapted for microscopic preparations; *Coleoptera*, Cicindela, Dytiscus, Melolontha (cockchafer), Lucanus (stag-beetle); *Orthoptera*, Acheta (house and field crickets), Locusta; *Hemiptera*, Notonecta (boat-fly); *Neuroptera*, Libellula (dragon-fly), Agrion; *Hymenoptera*, Vespidae (wasps) and Apidae (bees) of all kinds; *Lepidoptera*, Vanessa (various species of), Sphinx ligustri (privet hawk-moth), Bombyx (silkworm moth and its allies); *Diptera*, Tabanus (gad-fly), Asilus, Eristalis (drone-fly), Tipula (cramelfly), Musca (house-fly), and many others.

The *antennæ*, which are the two jointed appendages arising from the upper part of the head of insects (fig. 731, *b b*), present a most wonderful variety of conformation in the several tribes of insects, often differing considerably in the several species of one genus, and even in the two sexes of the same species. Hence the characters which they afford are extremely useful in classification, especially since their structure must almost necessarily be in some way related to the habits and general economy of the creatures to which they belong, although our imperfect acquaintance with their function may prevent us from clearly discerning this relation. Thus among the



FIG. 736.—Antenna of *Melolontha* (cockchafer).

Coleoptera we find one large family, including the glow-worm, fire-fly, skip-jack &c., distinguished by the toothed or serrated form of the antennæ, and hence called *Serricornia*; in another, of which the burying-beetle is the type, the antennæ are terminated by a club-shaped enlargement, so that these beetles are termed *Clavicornia*; in another, again, of which the *Hydrophilus*, or large water-beetle,

is an example, the antennæ are never longer, and are commonly shorter, than one of the pairs of palpi, whence the name of *Palpicornia* is given to this group; in the very large family that includes the *Lucani*, or stag-beetles, with the *Scarabæi*, of which the cockchafer is the commonest example, the antennæ terminate in a set of leaflike appendages, which are sometimes arranged like a fan or the leaves of an open book (fig. 736), are sometimes parallel to each other like the teeth of a comb, and sometimes fold one over the other, thence giving the name *Lamellicornia*; whilst another large family is distinguished by the appellation *Longicornia*, from the great length of the antennæ, which are at least as long as the body, and often longer. Among the *Lepidoptera*, again, the conformation of the antennæ frequently enables us at once to distinguish the group to which any specimen belongs. As every treatise on entomology contains figures and descriptions of the principal types of conformation of these organs, there is no occasion here to dwell upon them longer than to specify such as are most interesting to the microscopist: *Coleoptera*, *Brachinus*, *Calathus*, *Harpalus*, *Dytiscus*, *Staphylinus*, *Philonthus*, *Elater*, *Lampyris*, *Silpha*, *Hydrophilus*, *Aphodius*, *Melolontha*, *Cetonia*, *Curculio*, *Necrophorus*; *Orthoptera*, *Forficula* (earwig), *Blatta* (cockroach); *Lepidoptera*, *Sphingidæ* (hawk-moths), and *Noctuidæ* (moths) of various kinds, the large 'plumed' antennæ of the latter being peculiarly beautiful objects under a low magnifying power; *Diptera*, *Culicidæ* (gnats of various kinds), *Tipulidæ* (crane-flies and midges), *Tabanus*, *Eristalis*, and *Muscidæ* (flies of various kinds). All the larger antennæ, when not mounted 'dry' as opaque objects, should be put up in balsam, after being soaked for some time in turpentine; but the small feathery antennæ of gnats and midges are so liable to distortion when thus mounted that it is better to set them up in fluid, the head with its pair of antennæ being thus preserved together when not too

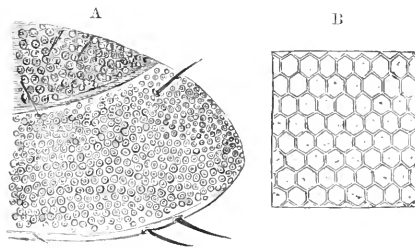

FIG. 737.—Minute structure of leaflike expansions of antenna of *Melolontha*: A, their internal layer; B, their superficial layer.

large. A curious set of organs is to be discovered in the antennæ of many insects, which have been supposed to constitute collectively an apparatus for hearing. Each consists of a cavity hollowed out in the horny integument, sometimes nearly spherical, sometimes flask-shaped, and sometimes prolonged into numerous extensions formed by the folding of its lining membrane; the mouth of the cavity seems to be normally closed in by a continuation of this membrane, though its presence cannot always be satisfactorily determined; whilst to its deepest part a nerve-fibre may be traced. The expanded lamellæ of the antennæ of *Melolontha* present a great display of these cavities, which are indicated in fig. 737, A, by the

small circles that beset almost their entire area; their form, which is very peculiar, can here be only made out by vertical sections; but in many of the smaller antennæ, such as those of the bee, the cavities can be seen sidewise without any other trouble than that of bleaching the specimen to render it more transparent.¹

The next point in the organisation of insects to which the attention of the microscopist may be directed is the structure of the *mouth*. Here, again, we find almost infinite varieties in the details of conformation; but these may be for the most part reduced to a small number of types or plans, which are characteristic of the different orders of insects. It is among the *Coleoptera*, or beetles, that we find the several parts of which the mouth is composed in their most distinct form; for, although some of these parts are much more highly developed in other insects, other parts may be so much altered or so little developed as to be scarcely recognisable. The *Coleoptera* present the typical conformation of the *mandibulate* mouth, which is adapted for the prehension and division of solid substances; and this consists of the following parts: 1. a pair of jaws, termed *mandibles*, frequently furnished with powerful teeth, opening *laterally* on either side of the mouth, and serving as the chief instruments of manducation; 2. a second pair of jaws, termed *maxilla*, smaller and weaker than the preceding, beneath which they are placed, and serving to hold the food, and to convey it to the back of the mouth; 3. an upper lip, or *labrum*; 4. a lower lip or *labium*; 5. one or two pairs of small jointed appendages, termed *palpi*, attached to the maxilla, and hence called *maxillary palpi*; 6. a pair of *labial palpi*. The labium² is often composed of several distinct parts, its basal portion being distinguished as the *mentum* or chin, and its anterior portion being sometimes considerably prolonged forwards, so as to form an organ which is properly designated the *ligula*, but which is more commonly known as the 'tongue,' though not really entitled to that designation, the real *tongue* being a soft and projecting organ which forms the floor of the mouth, and which is only found as a distinct part in a comparatively small number of insects, as the cricket. This *ligula* is extremely developed in the *fly* kind, in which it forms the chief part of what is commonly called the 'proboscis' (fig. 739);³

¹ See the memoir of Dr. Hicks, 'On a new Structure in the Antennæ of Insects,' in *Trans. Linn. Soc.* xxii. p. 147; and his 'Further Remarks' at p. 383 of the same volume. See also the memoir of M. Lespès, 'Sur l'Appareil auditif des Insectes,' in *Ann. des Sci. Nat.* sér. iv. Zool. tom. ix. p. 258; and that of M. Claparède, 'Sur les prétendus Organes auditifs des Coléoptères lamellicornes et autres Insectes,' in *Ann. des Sci. Nat.* sér. iv. Zool. tom. x. p. 236. Dr. Hicks lays great stress on the 'bleaching process' as essential to success in this investigation, and he gives the following directions for performing it: Take of chlorate of potass a drachm, and of water a drachm and a half; mix these in a small wide bottle containing about an ounce; wait five minutes and then add about a drachm and a half of strong hydrochloric acid. Chlorine is thus slowly developed, and the mixture will retain its bleaching power for some time. For an account of Herr F. Ruland's observations see *Journ. Roy. Micr. Soc.* 1888, p. 723.

² The labium and the labial palps are morphologically, a second pair of maxilla which have undergone more or less fusion of the basal parts along the median line.

³ The representation given in the figure is taken from one of the ordinary preparations of the fly's proboscis, which is made by slitting it open, flattening it out, and mounting it in balsam. For representations of the true relative positions of the different parts of this wonderful organ, and for minute descriptions of them, the

and it also forms the 'tongue' of the *bee* and its allies (fig. 738). The ligula of the common fly presents a curious modification of the ordinary tracheal structure, the purpose of which is not apparent; for instead of its tracheæ being kept pervious, after the usual fashion, by the winding of a continuous spiral fibre through their interior, the fibre is broken into rings, and these rings do not surround the whole tube, but are terminated by a set of arches that pass from one to another (fig. 739, B).¹ In the *Diptera*, or two-winged flies generally, the labrum, maxillæ, mandibles, and the internal tongue (where it exists) are converted into delicate lancet-shaped organs termed *setæ*, which, when closed together, are received into

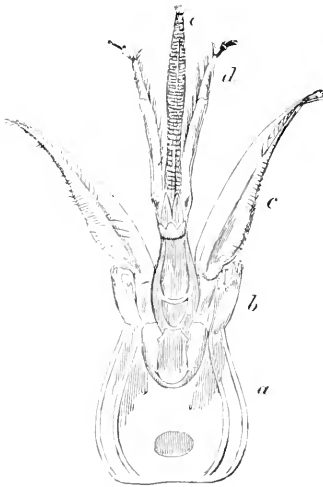

FIG. 738.—Parts of the mouth of *Apis mellifica* (honey-bee): *a*, mentum; *b*, mandibles; *c*, maxillæ; *d*, labial palpi; *e*, ligula, or prolonged labium, commonly termed the 'tongue.'

a hollow on the upper side of the labium (fig. 739), but which are capable of being used to make punctures in the skin of animals or the epidermis of plants, whence the juices may be drawn forth by the proboscis. Frequently, however, two or more of these organs may be wanting, so that their number is reduced from six to four, three, or two. In the *Hymenoptera* (bee and wasp tribe) the labrum and the mandibles (fig. 738, *b*) much resemble those of mandibulate insects, and are used for corresponding purposes; the maxillæ (*c*) are greatly elongated, and form, when closed, a tubular sheath for the *ligula*, or 'tongue,' through which the honey is drawn up; the labial palpi (*d*) also are greatly developed, and fold together, like the maxillæ, so as to form an inner sheath for the 'tongue;' while the 'ligula' itself (*e*) is a

long tapering muscular organ, marked by an immense number of short annular divisions, and densely covered over its own length with long hairs. It is not tubular, as some have stated, but is solid; when actively employed in taking food it is extended to a

reader is referred to Mr. Suffolk's memoir, 'On the Proboscis of the Blow fly,' in *Monthly Microsc. Journ.* i. p. 331, and to Mr. Lowrie's treatise on *The Anatomy and Physiology of the Blow-fly*.

¹ According to Dr. Anthony (*Monthly Microscopical Journ.* vol. xi. p. 242), these 'pseudo-tracheæ' are suctorial organs, which can take in liquid alike at their extremities and through the whole length of the fissure caused by the interruption of the rings, the edges of this fissure being formed by the alternating series of 'ear-like appendages' connected with the terminal 'arches,' the closing together of which converts the pseudo-tracheæ into a complete tube. Dr. Anthony considers each of these ear-like appendages to be a minute sucker, 'either for the adhesion of the fleshy tongue, or for the imbibition of fluids, or perhaps for both purposes.' The point is well worthy of further investigation.

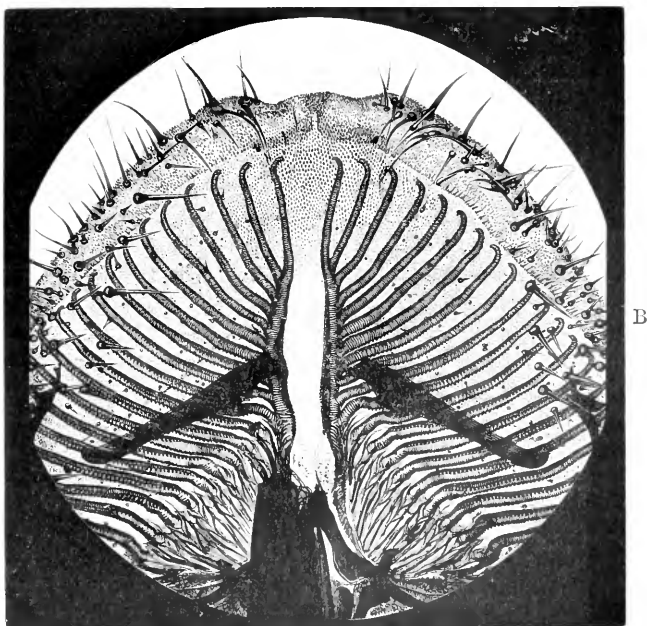
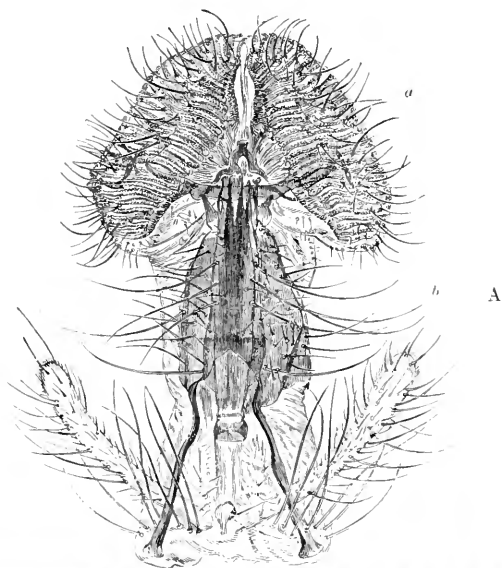

FIG. 739.—A, tongue of common fly: *a*, lobes of ligula; *b*, portion inclosing the lancets, formed by the metamorphosis of the maxillæ; *c*, maxillary palpi. B, a portion of some of the pseudo-tracheæ more highly magnified.

great distance beyond the other parts of the mouth; but when at rest it is closely packed up and concealed between the maxillæ. 'The manner,' says Mr. Newport, 'in which the honey is obtained when the organ is plunged into it at the bottom of a flower is by "lapping," or a constant succession of short and quick extensions and contractions of the organ, which occasion the fluid to accumulate upon it and to ascend along its upper surface, until it reaches the orifice of the tube formed by the approximation of the maxillæ above, and of the labial palpi and this part of the ligula below.'

By the plan of conformation just described we are led to that which prevails among the *Lepidoptera*, or butterfly tribe, which, being pre-eminently adapted for suction, is termed the *haustellate* mouth. In these insects the labium and mandibles are reduced to three minute triangular plates; whilst the maxillæ are immensely elongated, and are united together along the median line to form

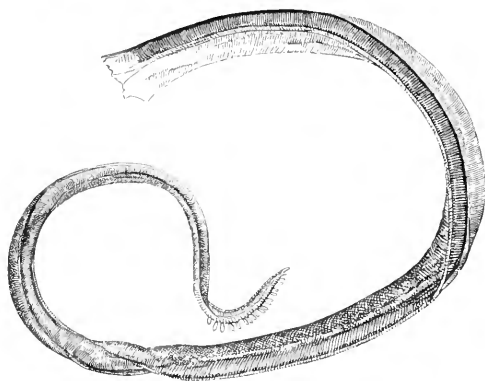

FIG. 740.—Haustellum (proboscis) of *Vanessa*.

the *haustellum*, or true 'proboscis,' which contains a tube formed by the junction of the two grooves that are channelled out along their mutually applied surfaces, and which serves to pump up the juices of deep cup-shaped flowers, into which the size of their wings prevents these insects from entering. The

length of this haustellum varies greatly: thus in such *Lepidoptera* as take no food in their perfect state it is a very insignificant organ; in some of the white hawk-moths, which hover over blossoms without alighting, it is nearly two inches in length, and in most butterflies and moths it is about as long as the body itself; in *Amphonyx*, one of the *Sphingidae*, it is more than nine inches long, or about three times the length of the body. This haustellum, which, when not in use, is coiled up in a spiral beneath the mouth, is an extremely beautiful microscopic object, owing to the peculiar banded arrangement it exhibits (fig. 740), which is probably due to the disposition of its muscles. In many instances the two halves may be seen to be locked together by a set of hooked teeth, which are inserted into little depressions between the teeth of the opposite side. Each half, moreover, may be ascertained to contain a trachea or air-tube, and it is probable, from the observations of Mr. Newport, that the sucking up of the juices of a flower through the proboscis (which is accomplished with great rapidity) is effected by the agency of the respiratory apparatus. The proboscis of many butterflies is furnished, for some distance from

its extremity, with a double row of small projecting barrel-shaped bodies (shown in fig. 740), which are surmised by Mr. Newport (whose opinion is confirmed by the kindred inquiries of Dr. Hicks) to be organs of taste. Numerous other modifications of the structure of the mouth, existing in the different tribes of insects, are well worthy of the careful study of the microscopist; but as detailed descriptions of most of these will be found in every systematic treatise on entomology, the foregoing general account of the principal types must suffice.

Parts of the Body.—The conformation of the several divisions of the *alimentary canal* presents such a multitude of diversities, not only in different tribes of insects, but in different states of the same individual, that it would be utterly vain to attempt here to give even a general idea of it, more especially as it is a subject of far less interest to the ordinary microscopist than to the professed anatomist. Hence we shall only stop to mention that the ‘muscular gizzard,’ in which the oesophagus very commonly terminates, is often lined by several rows of strong horny teeth for the reduction of the food, which furnish very beautiful objects, especially for the binocular. These are particularly developed among the grasshoppers, crickets, and locusts, the nature of whose food causes them to require powerful instruments for its reduction.¹

The *circulation of blood* may be distinctly watched in many of the more transparent larvæ, and may sometimes be observed in the perfect insect. It is kept up by a ‘dorsal vessel’ (so named from the position it always occupies along the middle of the back in the thoracic and abdominal regions), which really consists of a succession of muscular contractile cavities, one for each segment, opening one into another from behind forwards, so as to form a continuous trunk divided by valvular partitions. In many larvæ, however, these partitions are very indistinct; and the walls of the ‘dorsal vessel’ are so thin and transparent that it can with difficulty be made out, a limitation of the light by the diaphragm being often necessary. The blood which moves through this trunk, and which is distributed by it to the body, is a transparent and nearly colourless fluid, carrying with it a number of ‘oat-shaped’ corpuscles, by the motion of which its flow can be followed.² The current enters the ‘dorsal vessel’ at its posterior extremity, and is propelled forwards by the contractions of the successive chambers, being prevented from moving in the opposite direction by the valves between the chambers, which only open forwards. Arrived at the anterior extremity of the ‘dorsal vessel,’ the blood is distributed in three principal channels: a central one, namely, passing to the head, and a lateral one to either side, descending so as to approach the lower surface of the body. It is from the two lateral currents that the secondary streams diverge, which pass into the legs and wings, and then return back to the main stream; and it is from these also that in the larvæ

¹ The student who desires to carry further the study of the digestive apparatus should consult Professor Plateau’s memoir, ‘Recherches sur les Phénomènes de la Digestion chez les Insectes,’ *Mém. Acad. Roy. de Belgique*, xli.

² On the blood-tissue of insects consult Mr. W. M. Wheeler in vol. vi. of the American journal *Psyche*.

of the *Ephemera marginata* (day-fly), the extreme transparency of which renders it one of the best of all subjects for the observation of insect circulation, the smaller currents diverge into the gill-like appendages with which the body is furnished. The blood-currents seem rather to pass through channels excavated among the tissues than through vessels with distinct walls. In many aquatic larvæ, especially those of the *Culicida* (gnat tribe), the body is almost entirely occupied by the visceral cavity; and the blood may be seen to move backwards in the space that surrounds the alimentary canal, which here serves the purpose of the channels usually excavated through the solid tissues, and which freely communicates at each end with the dorsal vessel. This condition strongly resembles that found in many Annulata.¹

The circulation may be easily seen in the wings of many insects in their *pupa* state, especially in those of the Neuroptera (such as dragon-flies and day-flies), which pass this part of their lives under water in a condition of activity, the pupa of *Agrion puella*, one of the smaller dragon-flies, being a particularly favourable subject for such observations. Each of the 'nervures' of the wings contains a 'trachea' or air-tube, which branches off from the tracheal system of the body: and it is in a space around the trachea that the blood may be seen to move when the hard framework of the nervure itself is not too opaque. The same may be seen, however, in the wings of pupæ of bees, butterflies, &c., which remain shut up motionless in their cases: for this condition of apparent torpor is one of great activity of their nutritive system, those organs, especially, which are peculiar to the perfect insect being then in a state of rapid growth, and having a vigorous circulation of blood through them. In certain insects of nearly every order a movement of fluid may be seen in the wings for some little time after their last metamorphosis: but this movement soon ceases and the wings dry up. The common fly is as good a subject for this observation as can be easily found: it must be caught within a few hours or days of its first appearance; and the circulation may be most conveniently brought into view by inclosing it (without water) in the aquatic box, and pressing down the cover sufficiently to keep the body at rest without doing it any injury.

The *respiratory apparatus* of insects affords a very interesting series of microscopic objects: for, with great uniformity in its general plan, there is almost infinite variety in its details. The aëration of the blood in this class is provided for, not by the transmission of the fluid to any special organ representing the *lung* of a vertebrated animal or the *gill* of a mollusc, but by the introduction of air into every part of the body, through a system of minutely distributed *tracheæ*, or air-tubes, which penetrate even the smallest and most delicate organs. Thus, as we have seen, they pass into the *haustellum*, or 'proboscis,' of the butterfly, and they are minutely

¹ See the memoirs on *Carethra planticornis*, by Professor Rymer Jones, in *Trans. Microsc. Soc.*, n.s., vol. xi., 1867, p. 99; by Professor E. Ray Lankester, in the *Popular Science Review* for October 1865; and by Dr. A. Weismann, in *Zeitschr. f. wiss. Zool.*, Bd. xvi., p. 45. On the circulatory system of insects consult Graber, 'Ueber den pulsatorischen Apparat der Insecten,' *Arch. für mikr. Anat.*, ix., p. 129.

distributed in the elongated *labium* or 'tongue' of the fly (fig. 739). Their general distribution is shown in fig. 741, where we see two long trunks (*f*) passing from one end of the body to the other, and connected with each other by a transverse canal in every segment; these trunks communicate, on the one hand, by short wide passages with the 'stigmata,' 'spiracles,' or 'breathing pores' (*g*), through which the air enters and is discharged: whilst they give off branches

which divide again and again into ramifications of extreme minuteness. They usually communicate also with a pair of air-sacs (*h*) which is situated in the thorax; but the size of these (which are only found in the perfect insect, no trace of them existing in the larvæ) varies greatly in different tribes, being usually greatest in those insects which (like the bee) can sustain the longest and most powerful flight, and least in such as habitually live upon the ground or upon the surface of the water. The structure of the air-tubes reminds us of that of the 'spiral vessels' of plants, which seemed destined (in part at least) to perform a similar office: for within the membrane that forms their outer wall an elastic fibre winds round and round, so as to form a spiral closely resembling in its position and functions the spiral wire spring of flexible gas pipes: within this, again, however,

there is another membranous wall to the air-tubes, so that the spire winds between their inner and outer coats. When a portion of one of the great trunks with some of the principal branches of the tracheal system has been dissected out, and so pressed in mounting that the sides of the tubes are flattened against each other (as has happened in the specimen represented in fig. 742), the spire forms two layers which are brought into close apposition, and a very beautiful appearance, resembling that of watered silk, is produced

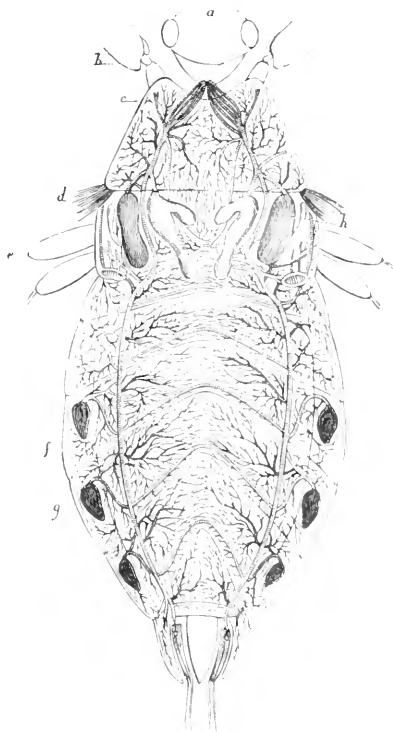

FIG. 741.—Tracheal system of *Nepa* (water-scorpion): *a*, head; *b*, first pair of legs; *c*, first segment of thorax; *d*, second pair of wings; *e*, second pair of legs; *f*, tracheal trunk; *g*, one of the stigmata; *h*, air-sac.

by the crossing of the two sets of fibres, of which one overlies the other. That this appearance, however, is altogether an optical illusion may be easily demonstrated by carefully following the course of any one of the fibres, which will be found to be perfectly regular.

The 'stigmata' or 'spiracles' through which the air enters the tracheal system are generally visible on the exterior of the

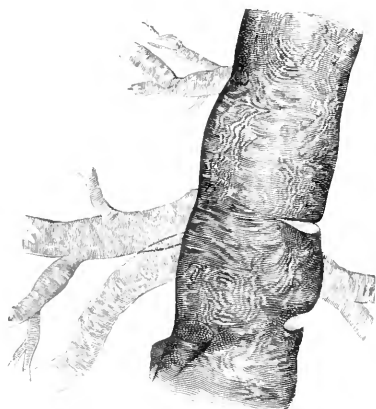

FIG. 742.—Portion of a large trachea of *Dytiscus*, with some of its principal branches.

body of the insect (especially on the abdominal segments) as a series of pores along each margin of the under surface. In most larvae, nearly every segment is provided with a pair, but in the perfect insect several of them remain closed, especially in the thoracic region, so that their number is often considerably reduced. The structure of the spiracles varies greatly in regard to complexity in different insects: and even where the general plan is the same the details of conformation are peculiar, so that perhaps in scarcely any two species are they alike. Generally speaking, they are furnished with some kind of sieve at their entrance by which particles of dust, soot, &c., which would otherwise enter the air-passages, are filtered out: and this sieve may be formed by

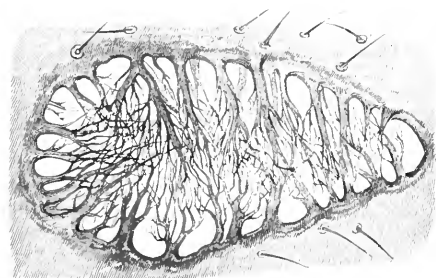

FIG. 743.—Spiracle of common fly.

the interlacement of the branches of minute arborescent growths from the border of the spiracle, as in the common fly (fig. 743), or in the *Dytiscus*: or it may be a membrane perforated with minute holes, and supported upon a framework of bars that is prolonged in like manner from the thickened margin of the aperture (fig. 744), as in the larvae of the *Melolontha* (cockchafer). Not unfrequently the centre of the aperture is occupied by an impervious disc, from which radii proceed to its margin, as is well seen in the spiracle of *Tipula* (crane-fly).¹ In those aquatic larvae which breathe air we often find one

¹ Consult Landois and Thiele, 'Der Tracheenverschluss bei den Insecten,' *Zeitschrift f. wiss. Zool.* xvii. p. 187.

of the insect (especially on the abdominal segments) as a series of pores along each margin of the under surface. In most larvae, nearly every segment is provided with a pair, but in the perfect insect several of them remain closed, especially in the thoracic region, so that their number is often considerably reduced. The structure of the spiracles varies greatly in regard to complexity in different insects: and even where the general plan is the same the details of conformation are peculiar, so that

perhaps in scarcely any two species are they alike. Generally speaking, they are furnished with some kind of sieve at their entrance by which particles of dust, soot, &c., which would otherwise enter the air-passages, are filtered out: and this sieve may be formed by the interlacement of the branches of minute arborescent growths from the border of the spiracle, as in the common fly (fig. 743), or in the *Dytiscus*: or it may be a membrane perforated with minute holes, and supported upon a framework of bars that is prolonged in like manner from the thickened margin of the aperture (fig. 744), as in the larvae of the

of the spiracles of the last segment of the abdomen prolonged into a tube, the mouth of which remains at the surface while the body is immersed; the larvæ of the *gnat* tribe may frequently be observed in this position.

There are many aquatic larvæ, however, which have an entirely different provision for respiration, being furnished with external leaf-like or brush-like appendages into which the tracheæ are prolonged, so that by absorbing air from the water that bathes them they may convey this into the interior of the body. We cannot have a better example of this than is afforded by the larva of the common *Ephemera* (day-fly), the body of which is furnished with a set of branchial appendages resembling the 'fin-feet' of branchiopods, whilst the three-pronged tail also is fringed with clusters of delicate hairs which appear to minister to the same function. In the larva of the *Libellula* (dragon-fly) the extension of the surface for aquatic respiration takes place within the termination of the intestine, the lining membrane of which is folded into an immense number of plaits, each containing a minutely ramified system of tracheæ: the water slowly drawn in through the anus for bathing this surface is ejected with such violence that the body is impelled in the opposite direction; and the air taken up by its tracheæ is carried through the system of air-tubes of which they form part into the remotest organs. This apparatus is a peculiarly interesting object for the microscope on account of the extraordinarily rich distribution of the tracheæ in the intestinal folds.

The main trunks of the tracheal system, with their principal ramifications, may generally be got out with little difficulty by laying open the body of an insect or larva under water in a dissecting trough, and removing the whole visceral mass, taking care to leave as many as possible of the branches, which will be seen proceeding to this from the two great longitudinal tracheæ, to whose position these branches will serve as a guide. Mr. Quekett recommended the following as the most simple method of obtaining a perfect system of tracheal tubes from a larva. A small opening having been made in its body, this is to be placed in strong acetic acid, which will soften or decompose all the viscera; and the tracheæ may then be well washed with the syringe, and removed from the body with the greatest facility, by cutting away the connections of the main tubes with the spiracles by means of fine-pointed scissors. In order to mount them they should be floated upon the slide, on which they should then be laid out in the position best adapted for displaying them. If they are to be mounted in Canada balsam they should be allowed to dry upon the slide, and should then be treated in the usual way; but their natural appearance is best preserved

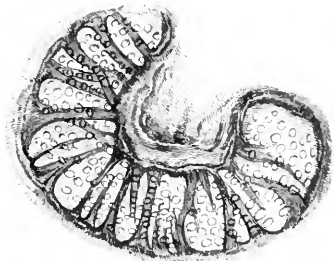

FIG. 744.—Spiracle of larva of *cockchafer*.

by mounting them in fluid (weak spirit or Goadby's solution), using a shallow cell to prevent pressure. The finer ramifications of the tracheal system may generally be seen particularly well in the membranous wall of the stomach or intestine; and this, having been laid out and dried upon the glass, may be mounted in balsam so as to keep the tracheæ full of air (whereby they are much better displayed), if care be taken to use balsam that has been previously thickened, to drop this on the object without liquefying it more than is absolutely necessary, and to heat the slide and the cover (the heat may be advantageously applied directly to the cover after it has been put on by turning over the slide so that its upper face shall look downward) only to such a degree as to allow the balsam to spread and the cover to be pressed down. The spiracles are easily dissected out by means of a pointed knife or a pair of fine scissors; they should be mounted in glycerin jelly when their texture is soft, and in balsam when the integument is hard and horny.

Wings.—These organs are essentially composed of an extension of the external membranous layer of the integument over a framework formed by prolongations of the inner horny layer, within which prolongations tracheæ are nearly always to be found, whilst they also include channels through which blood circulates during the growth of the wing and for a short time after its completion. This is the simple structure presented to us in the wings of *Neuroptera* (dragon-flies, &c.), *Hymenoptera* (bees and wasps), *Diptera* (two-winged flies), and also of many *Homoptera* (*Cicada* and *Aphides*); and the principal interest of these wings as microscopic objects lies in the distribution of their 'veins' or 'nervures' (for by both names are the ramifications of their skeleton known) and in certain points of accessory structure. The venation of the wings is most beautiful in the smaller Neuroptera, since it is the distinguishing feature of this order that the veins, after subdividing, reunite again, so as to form a close network; whilst in the Hymenoptera and Diptera such reunions are rare, especially towards the margins of the wings, and the areolæ are much larger. Although the membrane of which these wings are composed appears perfectly homogeneous when viewed by transmitted light, even with a high magnifying power, yet when viewed by light reflected obliquely from their surfaces an appearance of cellular areolation is often discernible; this is well seen in the common fly, in which each of these areolæ has a hair in its centre. In order to make this observation, as well as to bring out the very beautiful iridescent hues which the wings of many minute insects (as the *Aphides*) exhibit when thus viewed, it is convenient to hold the wing in the stage-forceps for the sake of giving it every variety of inclination; and when that position has been found which best displays its most interesting features, it should be set up as nearly as possible in the same. For this purpose it should be mounted on an opaque slide, but instead of being laid down upon its surface the wing should be raised a little above it, its 'stalk' being held in the proper position by a little cone of soft wax, in the apex of which it may be imbedded. The wings of most Hymenoptera are remarkable for the peculiar apparatus by which

those of the same side are connected together, so as to constitute in flight but one large wing; this consists of a row of curved hooklets on the anterior margin of the posterior wing, which lay hold of the thickened and doubled down posterior edge of the anterior wing. These hooklets are sufficiently apparent in the wings of the common bee, when examined with even a low magnifying power; but they are seen better in the wasp, and better still in the hornet. The peculiar scaly covering of the wings of the Lepidoptera has already been noticed; but it may here be added that the entire wings of many of the smaller and commoner insects of this order, such as the *Tineidae* or 'clothes-moths,' form very beautiful opaque objects for low powers, the most beautiful of all being the divided wings of the *Pissipennis* or 'plumed moths,' especially those of the genus *Pterophorus*.¹

There are many insects, however, in which the wings are more or less consolidated by the interposition of a layer of horny substance between the two layers of membrane. This plan of structure is most fully carried out in the *Coleoptera* (beetles), whose anterior wings are metamorphosed into *elytra* or 'wing-cases;' and it is upon these that the brilliant hues by which the integument of many of these insects is distinguished are most strikingly displayed. In the anterior wings of the *Forficulidae*, or earwig tribe, the cellular structure may often be readily distinguished when they are viewed by transmitted light, especially after having been mounted in Canada balsam. The anterior wings of the *Orthoptera* (grasshoppers, crickets, &c.), although not by any means so solidified as those of *Coleoptera*, contain a good deal of horny matter; they are usually rendered sufficiently transparent, however, by Canada balsam to be viewed with transmitted light; and many of them are so coloured as to be very showy objects (as are also the posterior fan-like wings) for the electric or gas microscope, although their large size and the absence of any minute structure prevent them from affording much interest to the ordinary microscopist. We must not omit to mention, however, the curious sound-producing apparatus which is possessed by most insects of this order, and especially by the common *house-cricket*. This consists of the 'tympanum,' or drum, which is a space on each of the upper wings, scarcely crossed by veins, but bounded externally by a large dark vein provided with three or four longitudinal ridges; and of the 'file' or 'bow,' which is a transverse horny ridge in front of the tympanum, furnished with numerous teeth; and it is believed that the sound is produced by the rubbing of the two bows across each other, while its intensity is increased by the sound-board action of the tympanum. The wings of the *Fulgoridae* (lantern-flies) have much the same texture as those of the *Orthoptera*, and possess about the same value as microscopic objects, differing considerably from the purely membranous wings of the *Cicada* and *Aphides*, which are associated with them in the order *Homoptera*. In the order *Hemiptera*, to which belong various kinds

¹ Compare the recently published memoir by M. Baer, 'Ueber Bau und Farben der Flügelschuppen bei Tagfaltern,' in *Zeitschr. f. wiss. Zool.* lxx. (1898), pp. 50-65, as also M. von Länden on the development of the markings, pp. 1-50 of the same volume.

of land and water insects that have a suctorial mouth resembling that of the common bug, the wings of the anterior pair are usually of parchmenty consistence, though membranous near their tips, and are often so richly coloured as to become very beautiful objects when mounted in balsam and viewed by transmitted light; this is the case especially with the terrestrial vegetable-feeding kinds, such as the *Pentatoma* and its allies, some of the tropical forms of which rival the most brilliant of the beetles. The British species are by no means so interesting, and the aquatic kinds, which, next to the bed-bugs, are the most common, always have a dull brown or almost black hue; even among these last, however, of which the *Notonecta* (water-boatman) and the *Nepa* (water-scorpion) are well-known examples, the wings are beautifully variegated by differences in the depth of that hue. The *halteres* of the Diptera, which are the representatives of the posterior wings, have been shown by Dr. J. B. Hicks to present a very curious structure, which is found also in the elytra of Coleoptera and in many other situations, consisting in a multitude of vesicular projections of the superficial membrane, to each of which there proceeds a nervous filament, that comes to it through an aperture in the tegumentary wall on which it is seated. Various considerations are stated by Dr. Hicks which lead him to the belief that this apparatus, when developed in the neighbourhood of the spiracles or breathing pores, essentially ministers to the sense of *smell*, whilst, when developed upon the palpi and other organs in the neighbourhood of the mouth, it ministers to the sense of *taste*.¹

Feet.—Although the feet of insects are formed pretty much on one general plan, yet that plan is subject to considerable modifications in accordance with the habits of life of different species. The entire limb usually consists of five divisions, namely, the *coxa* or hip, the *trochanter*, the *femur* or thigh, the *tibia* or shank, and the *tarsus* or foot; and this last part is made up of several successive joints. The typical number of these joints seems to be *five*,² but that number is subject to reduction; and the vast order Coleoptera is subdivided into primary groups, according as the tarsus consists of *five*, *four*, or *three* segments. The last joint of the tarsus is usually furnished with a pair of strong hooks or claws (figs. 745, 746); and these are often serrated (that is, furnished with saw-like teeth), especially near the base. The under surface of the other joints is frequently beset with tufts of hairs, which are arranged in various modes, sometimes forming a complete 'sole': this is especially the case in the family *Curculionida*; a pair of the feet of the 'diamond beetle' mounted so that one shows the upper surface made resplendent by its jewel-like scales, and the other the hairy cushion beneath, is a very interesting object. In many insects, especially of the fly kind, the foot is furnished with a pair of membranous expansions

¹ See his memoir, 'On a new Organ in Insects,' in *Journ. Linn. Soc.* vol. i. 1856, p. 136; his 'Further Remarks on the Organs found on the Bases of the Halteres and Wings of Insects,' in *Trans. Linn. Soc.* xxii. p. 111; and his memoir, 'On certain Sensory Organs in Insects hitherto undescribed,' in *Trans. Linn. Soc.* xxiii. p. 189. Compare also the interesting memoir of Weinland, in *Zeitschr. f. wiss. Zool.* li. (1850), pp. 35-160, 5 pls.

² See, however, Professor Huxley (*Anat. of Invertebrate Animals*, p. 348), who, regarding the 'pulvillus' of the cockroach as a joint, finds the number to be six.

termed *pulvilli* (fig. 745); and these are beset with numerous hairs, each of which has a minute disc at its extremity. This structure is evidently connected with the power which these insects possess of walking over smooth surfaces in opposition to the force of gravity; yet there is still considerable uncertainty as to the precise mode in which it ministers to this faculty. Some believe that the discs act as suckers, the insect being held up by the pressure of the air against their upper surface when a vacuum is formed beneath; whilst others maintain that the adhesion is the result of the secretion of a viscid liquid from the under side of the foot. The careful observations of Mr. Hepworth have led him to a conclusion which seems in harmony with all the facts of the case—namely, that each hair is a tube conveying a liquid from a glandular sacculus situated in the tarsus, and that when the disc is applied to a surface the pouring forth of this liquid serves to make its adhesion perfect. That this adhesion is not produced by atmospheric pressure alone is proved by the fact that the feet of flies continue to hold on to the interior of an exhausted receiver; whilst, on the other hand, that the feet pour forth a secreted fluid is evidenced by the marks left by their attachment on a clean surface of glass. Although, when all the hairs have the strain put upon them equally, the adhesion of their discs suffices to support the insect, yet each row may be detached separately by the gradual raising of the tarsus and *pulvilli*, as when we remove a piece of adhesive plaster by lifting it from the edge or corner. Flies are

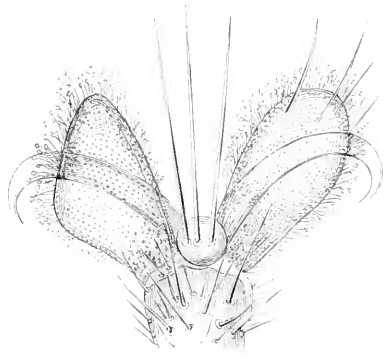

FIG. 745.—Foot of fly.

often found adherent to window-panes in the autumn, their reduced strength not being sufficient to enable them to detach their tarsi.¹ A similar apparatus on a far larger scale presents itself on the foot of the *Dytiscus* (fig. 746, A). The first joints of the tarsus of this insect are widely expanded, so as to form a nearly circular plate, and this is provided with a very remarkable apparatus of suckers, of which one disc (*a*) is extremely large, and is furnished with strong radiating fibres; a second (*b*) is a smaller one formed on the same plan (a third, of the like kind, being often present); whilst the greater number are comparatively small tubular club-shaped bodies, each having a very delicate membranous sucker at its extremity, as shown on a larger scale at B. These all have essentially the same

¹ See Mr. Hepworth's communications to the *Quart. Journ. Microsc. Sci.* vol. ii. 1854, p. 158, and vol. iii. 1855, p. 312. See also Mr. Tuffen West's memoir 'On the Foot of the Fly,' in *Trans. Linn. Soc.* xxii. p. 393; Mr. Lowne's *Anatomy of the Blow-fly*; H. Dewitz in *Zöologischer Anzeiger*, vi. p. 273; and G. Simmermacher in *Zeitschr. f. wiss. Zool.* xl. p. 481.

structure, the large suckers being furnished, like the hairs of the fly's foot, with secreting sacculi, which pour forth fluid through the tubular footstalks that carry the discs, whose adhesion is thus secured; whilst the small suckers form the connecting link between the larger suckers and the hairs of many beetles, especially *Curetonioides*.¹ The leg and foot of the *Dytiscus*, if mounted without compression, furnish a peculiarly beautiful object for the binocular microscope. The feet of caterpillars differ considerably from those of perfect insects. Those of the first three segments, which are afterwards to be replaced by true legs, are furnished with strong horny claws; but each of those of the other segments, which are termed 'pro-legs,' is composed of a circular series of comparatively slender curved hooklets, by which the caterpillar is enabled to cling to the minute roughness of the surface of the leaves, &c., on which it feeds. This structure is well seen in the pro-legs of the common silkworm.

Stings and Ovipositors.—The insects of the order Hymenoptera are all distinguished by the prolongation of the antepenultimate and

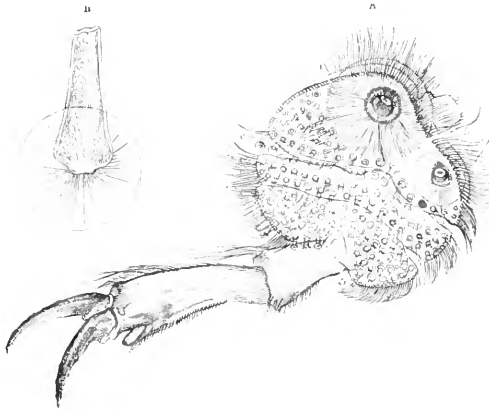

FIG. 746.—A, foot of *Dytiscus*, showing its apparatus of suckers: *a*, *b*, large suckers; *c*, ordinary suckers. B, one of the ordinary suckers more highly magnified.

penultimate segments of the abdomen (the eighth and ninth abdominal segments of the larva) into a peculiar organ, which in one division of the order is a 'sting,' and in the other is an 'ovipositor,' or instrument for the deposition of the eggs, which is usually also provided with the means of boring a hole for their reception. The former group consists of the bees, wasps, ants, &c.; the latter of the saw-flies, gall-flies, ichneumon-flies, &c. These two sets of instruments are not so unlike in structure as they are in function.² The

¹ See Mr. Lownc, 'On the so-called Suckers of *Dytiscus* and the Pulvilli of Insects,' in *Monthly Microsc. Journ.* v. p. 267.

² See Kraepelin, 'Untersuchungen über den Bau, Mechanismus und Entwicklungsgeschichte der bienenartigen Thiere,' in *Zeitschr. f. Wiss. Zööl.* xxiii, p. 289; Dewitz, 'Ueber Bau und Entwicklung des Stachels und der Legescheide,' *op. cit.*

'sting' is usually formed of a pair of darts, beset with barbed teeth at their points, and furnished at their roots with powerful muscles, whereby they can be caused to project from their sheath, which is a horny case formed by the prolongation of the integument of the last segment, slit into two halves, which separate to allow the protrusion of the sting; whilst the peculiar 'venom' of the sting is due to the ejection, by the same muscular action, of a poisonous liquid, from a bag situated near the root of the sting, which passes down a canal excavated between the darts, so as to be inserted into the puncture which they make. The stings of the common bee, wasp, and hornet may all be made to display this structure without much difficulty in the dissection. The 'ovipositor' of such insects as deposit their eggs in holes ready-made, or in soft animal or vegetable substances (as is the case with the *Ichneumonidae*), is simply a long tube, which is inclosed, like the sting, in a cleft sheath. In the gall-flies (*Cynipidae*) the extremity of the ovipositor has a toothed edge, so as to act as a kind of saw whereby harder substances may be penetrated; and thus an aperture is made in the leaf, stalk, or bud of the plant or tree infested by the particular species, in which the egg is deposited, together with a drop of fluid that has a peculiarly irritating effect upon the vegetable tissues, occasioning the production of the 'galls,' which are new growths that serve not only to protect the larvæ, but also to afford them nutriment. The oak is infested by several species of these insects, which deposit their eggs in different parts of its fabric; and some of the small 'galls' which are often found upon the surface of oak-leaves are extremely beautiful objects for the lower powers of the microscope. In the *Tenthredinida*, or 'saw-flies,' and in their allies, the *Siricida*, the ovipositor is furnished with a still more powerful apparatus for penetration, by means of which some of these insects can bore into hard timber. This consists of a pair of 'saws' which are not unlike the 'stings' of bees, &c., but are broader and toothed for a greater length, and are made to slide along a firm piece that supports each blade, like the 'back' of a carpenter's 'tenon-saw'; they are worked alternately (one being protruded while the other is drawn back) with great rapidity; but when not in use they lie in a fissure beneath a sort of arch formed by the terminal segment of the body. When a slit has been made by the working of the saws they are withdrawn into this sheath; the ovipositor is then protruded from the end of the abdomen (the body of the insect being curved downwards), and, being guided into the slit by a pair of small hairy feelers, there deposits an egg.¹ Many other insects, especially of the order *Diptera*, have very prolonged ovipositors, by means of which they can insert their eggs into the integuments of animals or into other situations in which the larvæ will obtain appropriate nutriment. A remarkable example

xxv. p. 174; and 'Ueber Bau und Entwicklung des Stachels der Ameisen,' *op. cit.* xxviii. p. 527.

¹ The above is the account of the process given by Mr. J. W. Gooch, who has informed the Author that he has repeatedly verified the statement formerly made by him (*Science Gossip*, Feb. 1, 1873), that the eggs are deposited, not, as originally stated by Réaumur, by means of a tube formed by the coaptation of the saws, but through a separate ovipositor, protruded when the saws have been withdrawn.

of this is furnished by the gad-fly (*Tabanus*), whose ovipositor is composed of several joints, capable of being drawn together or extended like those of a telescope, and is terminated by boring instruments; and the egg being conveyed by its means, not only *into* but *through* the integument of the ox, so as to be imbedded in the tissue beneath, a peculiar kind of inflammation is set up there, which (as in the analogous case of the gall-fly) forms a nidus appropriate both to the protection and to the nutrition of the larva. Other insects which deposit their eggs in the ground, such as the *locusts*, have their ovipositors so shaped as to answer for digging holes for their reception. The preparations which serve to display the fore-

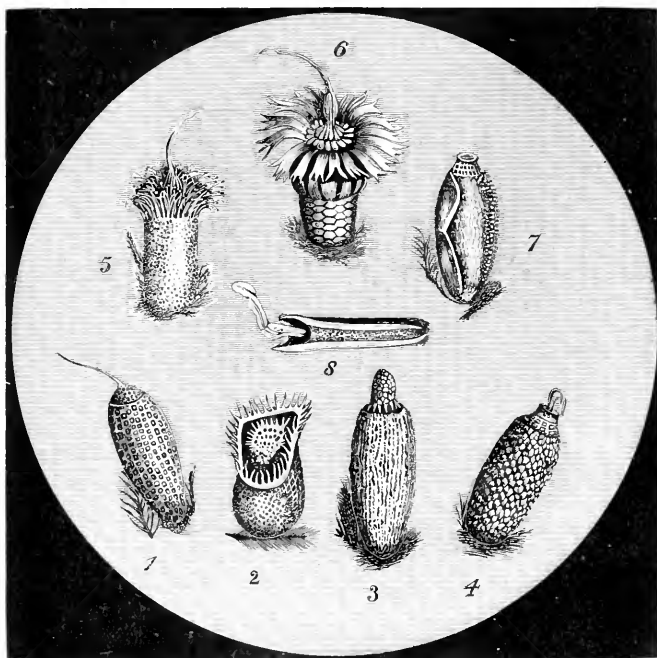

FIG. 747.—Various eggs, chiefly of the *Mallophaga* (Anoplura).

going parts are best seen when mounted in balsam, save in the case of the muscles and poison-apparatus of the sting, which are better preserved in fluid or in glycerin jelly.

The sexual organs of insects furnish numerous objects of extreme interest to the anatomist and physiologist; but as an account of them would be unsuitable to the present work, a reference to a copious source of information respecting one of their most curious features, and to a list of the species that afford good illustrations, must here suffice.¹ The *eggs* of not only the class *Insecta*, but of

¹ See the memoirs of M. Lacaze-Duthiers, 'Sur l'Armure Génitale des Insectes,' in *Ann. des Sci. Nat.* sér. iii. Zool. tomes xii. xiv. xvii. xviii. xix.; and M. Ch. Robin's

many of the minuter forms of the class *Arachnida*, as for example the *Acarina*, or mites and ticks, present to those who are in search of objects of beauty a wide and most interesting field. In fig. 747 we give a group of eggs, all but the central form being eggs or organisms of this order. It is thus with the eggs of many insects; they are objects of great beauty, on account of the regularity of their form and the symmetry of the markings on their surface (fig. 748). The most interesting belong for the most part to the order *Lepidoptera*; and there are few among these that are not worth examination. some of the commonest (such as those of the cabbage butterfly.

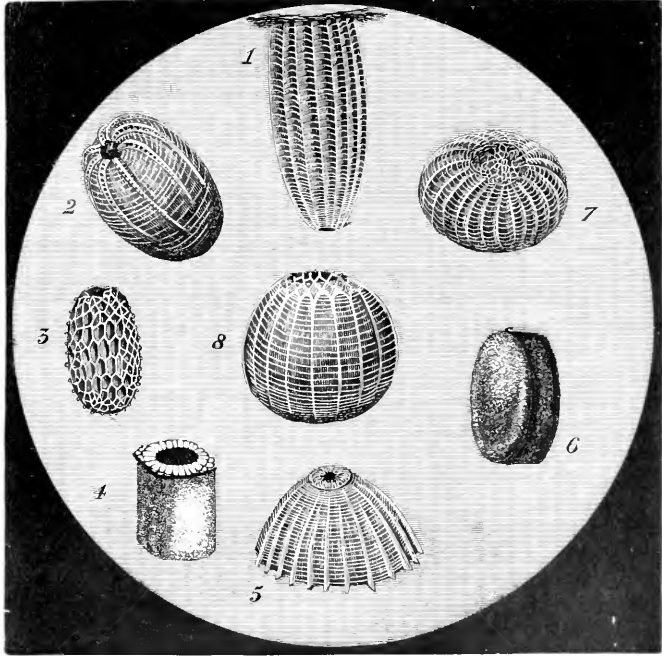

FIG. 748.—Eggs of butterflies and moths.

which are found covering large patches of the leaves of that plant) being as remarkable as any. Those of the puss-moth (*Cerura vinula*), the privet hawk-moth (*Sphinx ligustri*), the small tortoise-shell butterfly (*Vanessa urticae*), the meadow-brown butterfly (*Hipparchia janira*), the brimstone-moth (*Rumia crataegata*), and the silkworm (*Bombyx mori*) may be particularly specified; and, from other orders, those of the cockroach (*Blatta orientalis*), field-cricket (*Acheta campestris*), water-scorpion (*Nepa ranastra*), bug (*Cimex lectularius*), cow-dung fly (*Scatophaga stercoraria*), and blow-fly

Mémoire sur les Objets qui peuvent être conservés en Préparations microscopiques (Paris, 1856), which is peculiarly full in the enumeration of the objects of interest afforded by the class of Insects.

(*Musca vomitoria*).¹ In order to preserve these eggs they should be mounted in fluid in a cell, since they will otherwise dry up, and may lose their shape. They are very good objects for securing some of the best binocular effects.

The remarkable mode of reproduction that exists among the *Aphides* must not pass unnoticed here, from its curious connection with the non-sexual reproduction of *Entomostraca* and *Rotifera*, as also of *Hydra* and *Zöophytes* generally, all of which fall specially, most of them exclusively, under the observation of the microscopist. The *Aphides*, which may be seen in the spring and early summer, and which are commonly, but not always, wingless, are all of one sex, and give birth to a brood of similar *Aphides*, which come into the world alive, and before long go through a like process of multiplication. As many as from seven to ten successive broods may thus be produced in the course of a single season; so that from a single *Aphis* it has been calculated that no fewer than ten thousand million millions may be evolved within that period. In the latter part of the year, however, some of these viviparous *Aphides* attain their full development into males and females; and these perform the true generative process, whose products are eggs, which, when hatched in the succeeding spring, give origin to a new viviparous brood that repeat the curious life-history of their predecessors. It appears from the observations of Huxley² that the broods of viviparous *Aphides* originate in ova which are not to be distinguished from those deposited by the perfect winged female. Nevertheless, this non-sexual or *agamie* reproduction must be considered analogous rather to the 'gemmation' of other animals and plants than to their sexual 'generation;' for it is favoured, like the gemmation of *Hydra*, by warmth and copious sustenance, so that by appropriate treatment the viviparous reproduction may be caused to continue (as it would seem) indefinitely, without any recurrence to the sexual process. Further, it seems now certain that this mode of reproduction is not at all peculiar to the *Aphides*, but that many other insects ordinarily multiply by 'agamie' propagation, the production of males and the performance of the true generative act being only an occasional phenomenon; and the researches of Professor Siebold have led him to conclude that even in the ordinary economy of the hive-bee the same double mode of reproduction occurs. The queen, who is the only perfect female in the hive, after impregnation by one of the drones (or males) deposits eggs in the 'royal' cells, which are in due time developed into young queens; others in the drone cells, which become drones; and others in the ordinary cells, which become workers or neuters. It has long been known that these last are really undeveloped females, which, under certain conditions, might become queens; and it has been observed by bee keepers that worker-bees, in common with virgin or unimpregnated queens, occasionally lay

¹ Compare R. Leuckart in *Archiv f. Anat.* 1853, p. 90, 'Ueber die Micropyle und den feinem Bau der Schalenhaut bei den Insecteneiern,' and A. Brandt, *Ueber das Ei und seine Bildungsstätte*, Leipzig, 1878.

² 'On the Agamic Reproduction and Morphology of *Aphis*' in *Trans. Linn. Soc.* xxii. p. 193. For observations on American *Aphides* see various papers by Mr. C. M. Wood in *Pusché* and other American journals.

eggs from which eggs none but drones are ever produced. From careful microscopic examination of the drone eggs laid even by impregnated queens, Siebold drew the conclusion that they have not received the fertilising influence of the male fluid, which is communicated to the queen-eggs and worker-eggs alone; so that the products of sexual generation are always female, the males being developed from these by a process which is essentially one of gemination.¹

The embryonic development of insects is a study of peculiar interest from the fact that it may be considered as divided (at least in such as undergo a 'complete metamorphosis') into two stages that are separated by the whole active life of the larva—that, namely, by which the larva is produced within the egg, and that by which the imago or perfect insect is produced within the body of the pupa. Various circumstances combine, however, to render the study a very difficult one; so that it is not one to be taken up by the inexperienced microscopist. The following summary of the history of the process in the common blow-fly, however, will probably be acceptable. A *gastrula* with two membranous lamellæ having been evolved in the first instance, the outer lamellæ very rapidly shapes itself into the form of the larva, and shows a well-marked segmental division. The alimentary canal, in like manner, shapes itself from the inner lamellæ, at first being straight and very capacious, including the whole yolk, but gradually becoming narrow and tortuous as additional layers of cells are developed between the two primitive lamellæ, from which the other internal organs are evolved. When the larva comes forth from the egg it still contains the remains of the yolk; it soon begins, however, to feed voraciously; and in no long period it grows to many thousand times its original weight, without making any essential progress in development, but simply accumulating material for future use. An adequate store of nutriment (analogous to the 'supplemental yolk' of *Purpura*) having thus been laid up within the body of the larva, it resumes (so to speak) its embryonic development, its passage into the pupa state, from which the imago is to come forth, involving a degeneration of all the larval tissues; whilst the tissues and organs of the imago are redeveloped from cells which originate from the disintegrated parts of the larva, under conditions similar to those appertaining to the formation of the embryonic tissues from the yolk. The development of the segments of the head and body in insects generally proceeds from the corresponding larval segments; but, according to Dr. Weismann, there is a marked exception in the case of the *Diptera* and other insects whose larvæ are unfurnished with legs, their head and thorax being newly formed from 'imaginal discs,' which adhere to the nerves and tracheæ of the anterior extremity of the larva;² and, strange as this assertion may seem,

¹ See Professor Siebold's memoir, *On The Parthenogenesis in Moths and Bees*, translated by W. S. Dallas (London, 1857); and his *Beiträge zur Parthenogenesis der Arthropoden* (Leipzig, 1871).

² See his 'Entwickelung der Dipteren' in *Zeitschrift f. Wiss. Zool.* xiii. and xiv.; Mr. Lowne's *Anatomy of the Blow-fly* (1st ed.), pp. 6-9, 113-121; and A. Kowalevsky, 'Beiträge zur Kenntnis der Nachembryonalen-Entwickelung der Musciden,' *Zeitschr. f. Wiss. Zool.* xlv. p. 542.

it has been confirmed by the subsequent investigations of Mr. Lowne.¹

The *Arachnida*, or scorpions and pseudo-scorpions, and the *Ara-neida* or spiders, present much that is of interest even to the unscientific who use the microscope only for pleasure. The general remarks which have been made in regard to insects are equally applicable to these, but have special application in that group known as the *Acarina*, consisting of the *mites* and *ticks*. Some of these are parasitic, and are popularly associated with the wingless parasitic insects, to which they bear a strong general resemblance, save in having *eight* legs instead of *six*. The *Acarina* are the true 'mites;' they generally have the legs adapted for walking, and some of them are of active habits. The common cheese-mite, as seen by the naked eye, is familiar to every one; yet few who have not seen it under a microscope have any idea of its real conformation and movements; and a cluster of them, cut out of the cheese they infest, and placed under a magnifying power sufficiently low to enable a large number to be seen at once, is one of the most amusing objects that can be shown to the young. There are many other species, which closely resemble the cheese-mite in structure and habits, but which feed upon different substances; and some of these are extremely destructive.

The *Acarina* are the smallest of the *Arthropoda*, and are specially well fitted for microscopical examination; indeed, with the exception of the *Ixodida* (including the *Argosina*), which attain a substantial size, particularly in tropical countries, but little can be learnt respecting them without such aid: as far as is at present known, other mites are not larger in hot countries than in Europe. Many species make beautiful objects for the microscope, and may be well preserved, the hard-bodied specimens in balsam without heat or pressure, the soft-bodied in glycerin or glycerin jelly: e.g. the nymphs of *Leiosoma palmacinctum*, *Tegeocranus cepheiformis*, *T. dentatus*, and the adults of *Glyciphagus plumiger* and *G. palmifer* are admirable. They are all British, and are found respectively on lichen at the Land's End, on the fallen bark and needles of fir-trees, on fallen oak-wood, in the fodder in stables, and on cellar-walls. Many of the *Trombidida* and *Hydrachnida* also are very beautiful; and the *Dermaleichi*, especially the males, and such creatures as *Myobia*, *Listrophorus*, &c., are extremely curious. With the exception of the *Phytoptida*, all *Acarina* in the adult stage have eight legs and the constriction between cephalo-thorax and abdomen is far less marked than in insects and spiders—in many genera it is wholly lost. The sexes are distinct and often very different from each other: the reproduction is oviparous or ovo-viviparous—possibly in rare and exceptional instances viviparous. The ova are usually elliptical or oval; in those which have a hard shell a curious stage known as the 'deutovium' exists: as the egg increases in size the shell splits into two symmetrical halves, which remain attached to the lining membrane, but are widely separated, the

¹ Reference should be made to Professor Bütschli's observations in *Morphol. Jahrbuch*, xiv. p. 170, and Dr. Voeltzkow's paper in *Arbeit. Zool. Zool. Inst. Würzburg*, ix. p. 1.

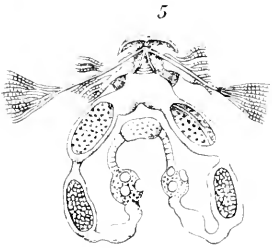
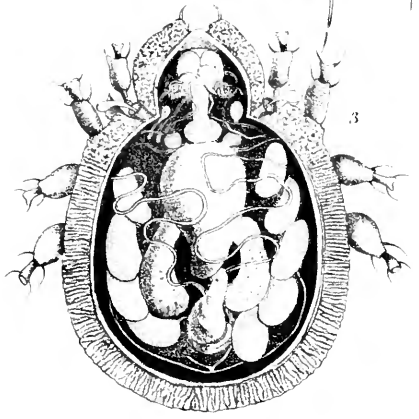
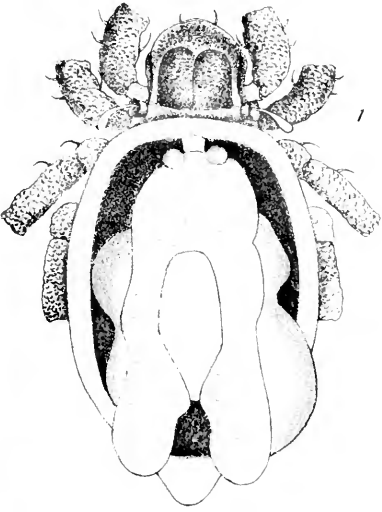
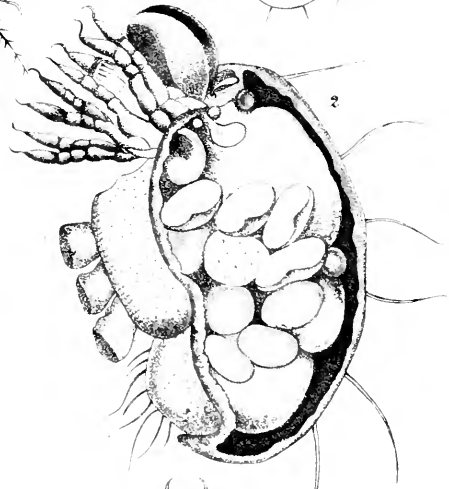
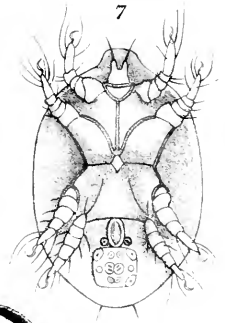
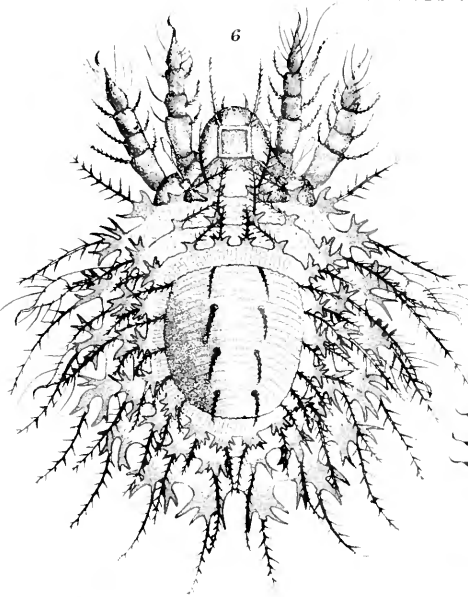

membrane becoming the external covering in the space left. The eggs of the so-called stone-mite (*Petrobia lapidum*) are discoidal and sculptured; they occasionally appear in countless numbers over a large space of ground in a single night, making the place look whitewashed; they have been mistaken for fungi and called *Crategium pyriforme*; they are good microscopical objects. The larvæ of all *Acarina*, except *Phytoptus* and possibly *Dermanyssus*, are hexapod; the fourth pair of legs is absent. The nymphal stage is usually the principal period of growth; occasionally, however, it is wanting. The nymph is an active chrysalis, as in the *Orthoptera*; it usually undergoes several ecdyses. In many species of the *Oribatida* the whole skin is not cast, but splits round the edge of the body, and the dorso-abdominal portion remains attached to the new skin; often it has a row of elegant spines or hairs round its edge; thus after two or three ecdyses these spines form concentric rings on the notogaster (Plate XXI, fig. 2). In the *Trombidiiidæ*, *Tyroglyphi*, &c. the nymphs usually greatly resemble the adults; in the *Oribatida* they are often totally different, and every intermediate stage occurs. The change from nymph to adult is usually preceded by an inert period.

The number and variety of the families, and the differences in the external form and internal anatomy, are so great and so endless that it is impossible here to do more than indicate a few leading features and refer to a few examples of interest. The caput is, of course, fused with the thorax, but sometimes a constriction at the base of the rostrum gives a false appearance of there being a distinct head. The trophi are extremely different in the respective families, or even genera. In the more highly organised of the *Gamasidæ* almost all the parts which exist in the most elaborate insect-mouths except the labial palpi may be found; they are well described by M. Mégnin.¹ A large oral tube is formed by the ankylosed maxillæ and probably upper lip and lingua. Up the centre of this tube the mandibles pass freely; they are very long and chelate; the first joint is simply cylindrical; the second similar, but having the fixed chela at its distal end; the third is the movable chela. They are capable of being projected far beyond the body, or of being withdrawn wholly within it, the muscles which withdraw them often arising from quite the posterior end of the body. These mandibles are different in the two sexes, and those of the male often have most remarkable appendages. One of the best examples is that of *Gamasus terribilis*, a species found in moles' nests by Mr. Michael. Professor Canestrini, of Padua, also has figured some very singular forms. In the *Oribatidæ*, *Tetranychus*, the *Sarcoptidæ*, &c. the mandibles are also chelate, but of two joints only, shorter, more powerful, and not capable of such great protrusion. In the *Hydrachnidæ*, *Trombidiiidæ*, &c. the mandible is not chelate, but the terminal joint shuts back like a clasp-knife, as in the poison-fangs of spiders. Other forms of mandible are found. The maxillæ are large toothed crushing organs in the *Oribatidæ*; they are very

¹ *Journ. de l'Anat. et de la Physiol.* Robin, May 1876.

strongly developed in *Hoplophora*, which is a wood-boring creature. In other families they are more commonly joined, forming a maxillary lip with a flexible edge for sucking purposes. The maxillary palpi vary greatly; in the *Sarcoptidae*, *Myobia*, &c. they are ankylosed to the lip; in the *Phytopti* Nalepa is of opinion that they are needle-like piercing organs, but these may well be the maxillæ. In some predatory forms, as *Cheyletus*, *Trombidium*, &c., they assume great importance, being the raptorial organs; in the first they are extremely large and powerful and work horizontally; they are provided with a number of long chitinous spines and comb-like appendages of a very singular character. In *Trombidium* the ultimate joint is articulated at the base of, or part of the way down, the penultimate, forming a species of chela. In *Blella* the palpi are long thin organs, carried upward and backward, and have the appearance of antennæ. The joints of the legs are from three (*Demodex*) to seven (some *Trombidiidae* and *Gamasidae*); five is the most usual number. They are terminated by a sucker as in the *Sarcoptidae*, where it is often very large; or by a claw or claws, or both together. In some parasitic species the claws are developed in a special manner for holding the hairs of the host; thus *Myobia* has the claw of the first leg flattened out so as to form a broad lamina, which curls round the hair and presses it against a chitinous peg on the tarsus; *Myocoptes* has a similar arrangement on the third leg. Both these genera contain species which are parasites of the mouse, and easily obtained. In the *Oribatidae*, *Tyroglyphi*, &c. the legs are all strictly walking organs; but in *Cheyletus*, most *Gamasidae*, &c. the first pair are tactile, and not used in locomotion. The legs generally correspond on the two sides of the body, but in *Freyana heteropus*, an extraordinary parasite of the cormorant discovered by Mr. Michael (Plate XXII, fig. 3), the second leg of the male is developed to a much greater extent on one side than on the other, and is supported by a different sternal skeleton on the two sides; the strangest fact is that it is not always the same side that is thus developed; it is usually the left, but occasionally the right. The integument of the *Acarina* is almost always soft in the immature forms; in the adults it is hard and chitinised in the *Oribatidae* and most *Gamasidae*; partly so in the *Leodidae*; and usually soft in most other families, and often minutely striated. The hairs and other appendages of the integument of a similar nature are often very characteristic and extraordinary. In the nymph of *Leiosoma palmaticinctum* they are large scale-like processes of a Japanese-fan shape, which entirely cover up and conceal the body of the creature; a leaf-like form is also common. In *Glyciphagus plumiger* they are elegant plumes; in some *Sarcoptidae*, e.g. *Symbiotes tripilis*, some of the simple setiform hairs are three times the length of the body; in the *Trombidiidae* the body-hairs are often extremely fanciful. The setiform hairs are the principal organs of touch, those on the front legs being specially important. So sensitive are they that *Cheyletus* and some *Gamasids*, which are predatory and capture such active creatures as *Thysanarida*, are entirely eyeless, and trust to the tactile sense only. Haller was of opinion that certain specialised

2

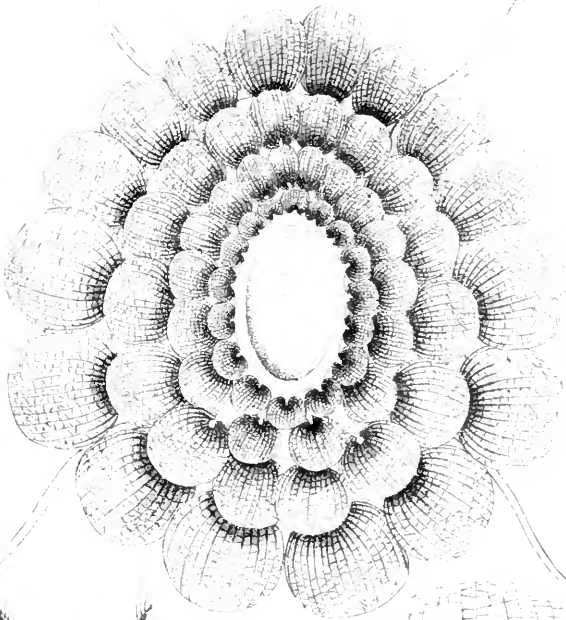

3



4



5

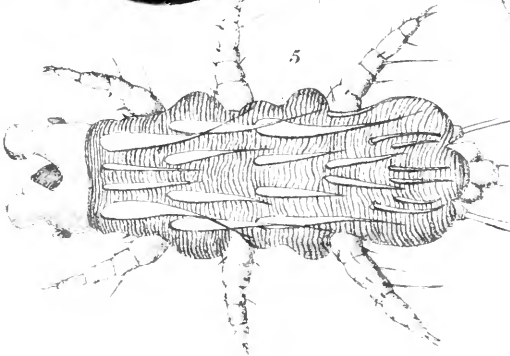

hairs had an auditory function. In the *Ixodidae* a singular drum-like structure in the first leg has been considered by Haller and others to be the hearing organ: while in the *Oribatidae* that organ appears to be located in the pseudo-stigmata, two paired organs at the side of the cephalo-thorax which were long taken for true stigmata. The *Gamasida*, *Oribatida*, *Tyroglyphida*, *Sarcoptida*, &c. are entirely without special organs of vision. The *Hydrachnida* have two pairs of simple eyes, each pair being so close together as to look like a single eye. The *Trombidiiida* mostly have simple eyes, the number and position of which vary with the species. As to internal anatomy it should be noted that there is almost endless variety. The alimentary canal most commonly consists of a long thin œsophagus, provided with distensor muscles on each side, so as to make it a sucking organ; it usually passes right through or close under the great ganglion known as the brain: in some species, as *Damaeus geniculatus*, the œsophagus is followed by a large pro-ventriculus, but this is not usual; it more commonly leads directly into the ventriculus, which generally is a principal viscus, and in most families furnished with more or less glandular caecal appendages, not numerous, but often very large, occasionally larger than the organ itself. A valve in many cases separates the ventriculus from the hind-gut, which is commonly divided into what may be called colon and rectum. In the *Gamasida* a single very large Malpighian vessel on each side of the body enters between the two last-named divisions of the alimentary canal. These vessels run right along the side of the body, and strong pulsation may be seen in them. In the *Oribatida* they are absent, their function being apparently performed by supercoxal glands. The *Tyroglyphida*, *Sarcoptida*, *Phytoptida*, &c. are without special respiratory organs; the *Oribatida* and some *Tropoda* have simple unbranched tracheæ, much in the same condition as those of *Peripatus*. The other *Gamasida*, the *Trombidiiida*, *Cheyletida*, *Ixodida*, &c. usually have branched tracheæ, like insects; air-sacs are occasionally found, but not anything like the tracheal lungs or gills (so called) of spiders and scorpions. The principal nerve-centre is much concentrated, and consists usually of either a large supra-œsophageal and smaller subœsophageal ganglion joined by commissures; or, more frequently, the whole forms one mass which is pierced by the œsophagus, which may be pulled out, leaving a neat round hole: the nerves, of course, radiate from this mass, but there is not space here to describe their course. A pulsating organ of the nature of the dorsal vessel of insects, but much shorter, and with only one or two pairs of ostia, has been detected in some *Gamasida*, and in *Ixodes*, first by Kramer and afterwards by Winkler and Claus; it has a median aorta running forward; it is best seen in life in young specimens still transparent; it lies at the rear of the ventriculus, near the dorsal surface. Nothing of the nature of a heart has yet been discovered in other *Acarina*. The reproductive organs are, perhaps, most frequently of the 'ring' type, well known in the *Arachnida*; thus in female *Oribatida* they consist of a central ovary, with an oviduct springing from near each end, in which the

eggs are matured; the oviducts both terminate in an unpaired vagina, whence the eggs pass into a long, membranous, extensible ovipositor, often wrinkled or striated with singular fineness and beauty. The external aperture is closed by chitinous folding doors. A more or less similar arrangement may be found in most *Gamasida*, *Hydrachnida*, &c., but without the ovipositor. Spermathecae are often found in the *Gamasida*, *Tyroglyphida*, &c., and accessory glands frequently accompany the vagina in almost all families. The male system varies greatly, but is frequently constructed on similar lines, preserving somewhat of the 'ring' form.

The principal families into which the *Acarina* are divided are as follows:—

The *Gamasida*, which in the adult stage are mostly provided with a hard chitinous cuticle in all parts of the body. They are mostly predatory, but the females and young are often parasitic. *Pteroptus* and *Dermanyssus*, however, are more leathery in texture, and are parasitic during their whole lives, the former on bats, the latter on birds. This family have the true stigmata, one on each side of the ventral surface, usually between the second and third pairs of legs; these do not communicate directly with the external air, but have a long tubular peritreme in the chitin of the ventral surface, often very elaborate in form, and emerging to the air usually between the first and second legs. This is highly characteristic of the family.

The *Ixodida*, or ticks, most of which are probably primarily vegetable feeders, but will, when opportunity offers, attach themselves to animals by sinking their long serrated rostral projection into the skin, have a single ventral stigma on each side, communicating directly with the air by a large cullender-plate, which is an interesting microscopical object. The males have the dorsal surface of the abdomen almost entirely covered by a chitinous plate, which is much smaller in the females; but the leathery portion of the abdomen in that sex is capable of great distension for the purpose of permitting the suction of animal juices. The *Argasida* must be included in this group; their tenacity of life and power of existing without food are marvellous; their bite is severe, but the terrible stories told of the results of the bite of the Persian *Argas* have not been supported on investigation.

The *Oribatida* are mostly wholly chitinised, the chitin being very hard and brittle. The stigmata are in the acetabula of the legs. The pseudo-stigmata (hearing organs) of this family have been before referred to. *Oribatida* are vegetable feeders, living in moss, lichen, fungus, dead wood, under bark of trees, &c., and some few species on aquatic plants. They are widely distributed from the arctic regions to the equatorial. *Hoplophora* has the power of withdrawing the legs wholly within the carapace, and then shutting down the cephalo-thorax against the abdomen, so as to close the opening, when it appears like a chitinous ball; from this power it has been called the 'box-mite.' The sexes have not any external difference.

The *Trombidida* are a large and varied group, mostly predatory

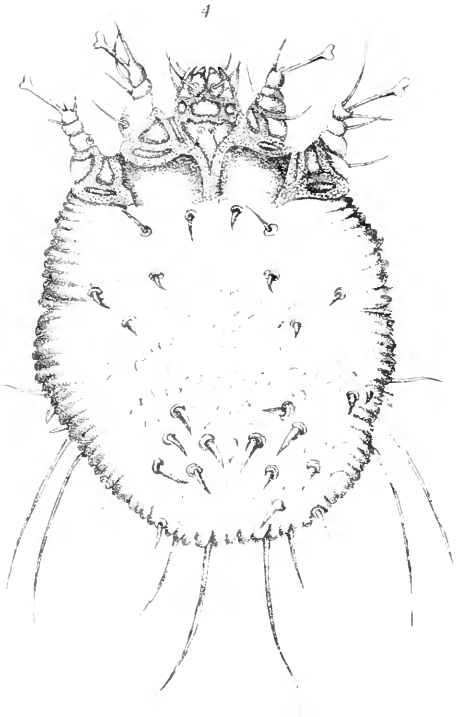
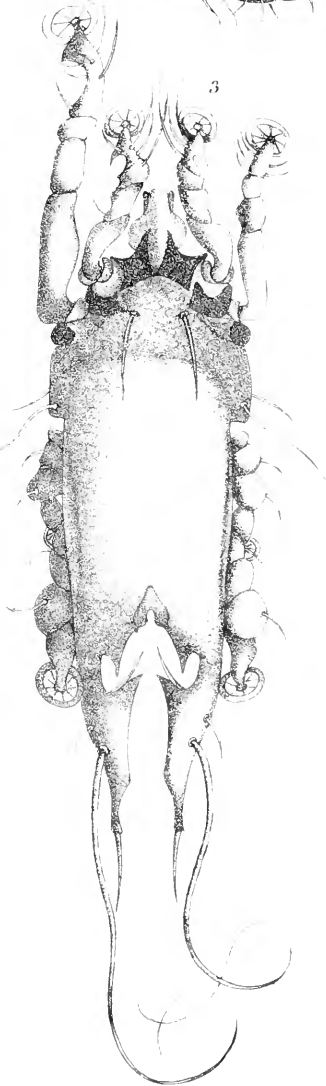
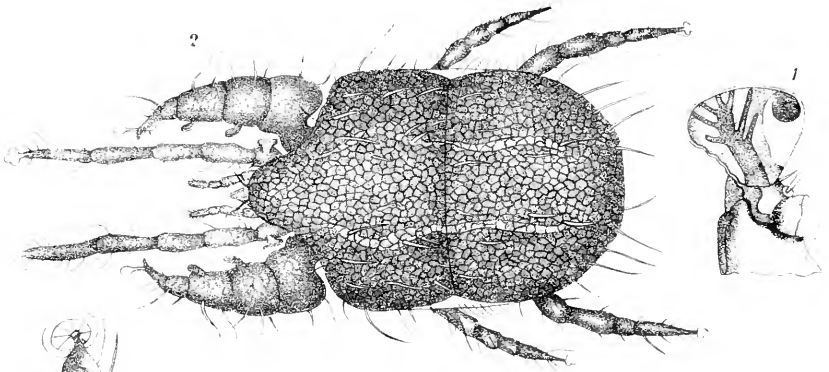

and with soft, often velvety skins, frequently of scarlet and other brilliant colours. The large *Trombidium holosericum* is a well-known microscopical object. The *Tetranych*i are usually included in this family; they are, however, rather doubtful members; they are the 'red-spiders' of our greenhouses, much dreaded by horticulturists. Each foot is provided with about four singular hairs with round knobs at the end. *Bryobia* is an allied genus found in great numbers on ivy &c. in gardens and is a beautiful object. The hexapod larvae of several species of *Trombidium* often attach themselves temporarily to the skin of animals, including man, and produce intolerable itching. They were supposed by the earlier Acarologists to be all one species, and to be adult, and to form a distinct family; they were called *Leptus autumnalis*, and are known in England as the 'harvest-bug,' and in France as the *rouget*. The *Bdellidæ* are also included in this family; some authors also include the *Cheyleti*, which, however, seem to need a separate family, having many curious characters, including the dorsal position of the male organs.

The *Hydrachnidæ*, or water-mites, as well as the *Trombidiidæ*, have the two stigmata in the rostrum; the legs are swimming organs, the sexes often very different; they live in fresh water and are often parasitic in their immature, but not in the adult stages. They are mostly soft-bodied and often of brilliant colours.

The *Limnocaridæ* are sometimes treated as a sub-family of the *Hydrachnidæ*, but are crawling, not swimming creatures, and are found in fresh water; but the *Halicaridæ*, which either constitute a sub-family of, or are closely associated with them, are marine, and are much found among *Hydrozoa*, on which they probably prey.

The parasitic *Myobiidæ* are by some included in the *Cheyletidæ*; the differences, however, are very considerable. They are the last tracheate family.

The *Tyroglyphidæ* are the cheese-mite family; they are far the most destructive of all *Acarina*, swarming in countless numbers and devouring hay, cheese, drugs, growing plants and roots, &c.; the genus *Glyciphagus* contains many singular and interesting forms, as *G. platygaster* and *G. Krameri*, found in moles' nests. It is in this family that the curious hypopial stage exists; some of the individuals of some species, instead of following the ordinary life-history, are changed at one ecdysis into a totally different-looking creature, with a highly chitinised cuticle and rudimentary mouth-organs, which can endure draught and other unfavourable circumstances which would kill the ordinary form. They attain the same adult stage as other individuals. The *Hypopus* is provided with adhesive suckers whereby it attaches itself temporarily to other creatures, and this serves for the distribution of the species.

The *Tarsonemidæ* are minute creatures, some leaf-miners, some parasitic on bees &c.

The *Sarcoptidæ* are divided into two great sub-families, the *Sarcoptina*, or itch-mites, of which the well-known *Sarcoptes scabiei* of man (Plate XXII, fig. 4) is the type, and the *Analyesina*, or bird-parasite mites; all have soft bodies with finely striated cuticles. *Sarcoptes*

scabiei is a minute creature of almost circular form, the female of which burrows under the epidermis, causing the disease. The mite is found at the end of the burrow, not in the pustule at its commencement. The first two pairs of legs and the third leg of the male are terminated by suckers, the other legs by long bristles. The male is smaller than the female. The *Analgesinae* (*Dermaleichi*) are a very large and curious group; the males often differ greatly from the females, and the skin is often greatly strengthened by chitinous plates and structures. The species are not always parasitic on one bird only; often the same species may be found on numerous birds, while several species frequently live on the same bird; they are not usually supposed to be injurious to the birds; they are found on the feathers.

The *Phytoptidae* are extremely minute creatures living in galls which they form on the leaves and twigs of numerous trees and plants; they are elongated in form with the two hind pairs of legs abortive; there is but little variety among them. Slightly resembling them in general form, but very different in other respects, is *Demodex folliculorum*, which is found in the sebaceous follicles of the human skin, particularly the nose. Those follicles, which are enlarged and whitish with a terminal exterior black spot, may be forced out by pressure, and the *Acarus* will often be found within. Similar parasites exist on the dog and pig.

There are numerous other curious and interesting forms which cannot be included in any of the families mentioned above.

The number of objects furnished to the microscopist by the spider tribe is very large from a biological point of view, although mere objects of microscopical interest popularly are not so numerous as in insects. Their eyes exhibit a condition intermediate between that of insects and crustaceans and that of vertebrata, for they are simple like the 'stigmata' of the former, usually number from six to eight, are sometimes clustered together in one mass, but more frequently disposed separately; while they present a decided approach in internal structure to the type characteristic of the visual organs of the latter.

The structure of the mouth is always mandibulate, and is less complicated than that of the mandibulate insects. The respiratory apparatus is not tracheal, as in insects and some *Acarina*, but is constructed upon a very different plan, for the 'stigmata,' which are usually four in number on each side, open upon a like number of respiratory sacculi, each of which contains a series of leaf-like folds of its lining membrane upon which the blood is distributed so as to afford a large surface to the air.

In the structure of the limbs, the principal point worthy of notice is the peculiar appendage with which they usually terminate, for the strong claws, with a pair of which the last joint of the foot is furnished, have their edges cut into comb-like teeth, which appear to be used by the animal as cleansing instruments, and in many cases for the manipulation of the silk of their snares. But a feature deserving study by the microscopist is the physical cause of the exquisite sensitiveness of these 'feet.' By resting these upon a

trap-line of silk carried to her den, she can, by a veritable telegraphy, discover instantly, not only the fact that there is prey upon her snare, but the exact spot in the web of the snare in which that prey is entangled. In the same way, by seizing certain tightly stretched threads communicating with the main lines of the snare, she can discover in an instant the presence and position of her prey, though far beyond the reach of vision.

The most characteristic and interesting part in the special organisation of the spider is the 'spinning apparatus,' by means of which its often elaborately constructed webs are produced. These consist of 'spinnerets' on the exterior of the body and glandular organs lying within the abdomen; it is by them that the silk from which all the elements of the snare are produced is secreted.

Of these glands there are two pairs which are sac-like in form, with a coiled tube opening directly on the spinnerets: there are three pairs, of a convoluted appearance, opening on the hinder spinnerets; and there are three of a sinuous tubular form opening on the hinder and middle spinnerets. Beyond these there are respectively 200 and 400 smaller glands, which open on the front, middle, and hinder spinnerets. They all terminate in tubes of great delicacy, through which the silk is drawn at the will of the spinster; and, while the scaffolding or framework of the web of *Epeira* is double and hardens rapidly in air (fig. 750, A), those which lie across the polygons of the scaffolding are studied at regular intervals with viscid globules, as seen in fig. 750, B; and it is to these viscid globules that the peculiarly adhesive character of the web is due.

The usual number of the spinnerets is six. They are little teat-like processes crowned with silk tubes. They are movable at the will of the spider, and can be erected or depressed, and one, many, or all of the tubes crowning a spinneret may be caused to exude and have drawn from it or them the silk as the spider determines. There can be no doubt that there is a difference in the silk secreted by different glands, and its appropriate employment is a part of the skill of the spider.

It is certain that the silken threads of a snare are of two kinds;

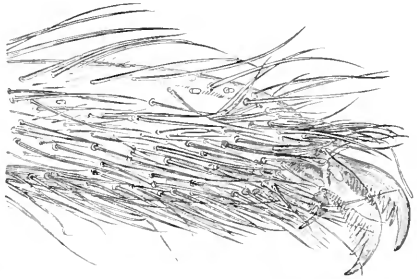

FIG. 749.—Foot, with comb-like claws, of the common spider (*Epeira*).



FIG. 750.—Ordinary thread (A) and viscid thread (B) of the common spider.

(1) that which rapidly hardens on contact with the air, and which is employed in the construction of the framework of the snare; and (2) a viscid silk with which the entangling meshes by which prey is caught are put in. The latter present beautiful objects for popular observation, because the thread has strung upon it, as it were, innumerable pearl-like globules in which the viscosity remains. These beads are produced after the thread is drawn out by a special vibratory action set up in the thread by the spider.

The eggs of spiders are not objects of special optical interest, but they afford opportunities for good embryological work,¹ and the habits of spiders offer a good scope for industrious study in the field.²

¹ See the work of Kishinouyi in *Journ. Coll. Sci. Imp. Univ. Japan*, vol. iv.

² See particularly McCook's *American Spiders and their Spinning Work*, Philadelphia, 1889 and 1890, and the various papers of Mr. and Mrs. Peckham in the American journals.

CHAPTER XXII

VERTEBRATED ANIMALS

WE are now arrived at the highest division of the animal kingdom, in which the bodily fabric attains its greatest development, not only as to completeness, but also as to size; and it is in most striking contrast with the class we have been last considering. Since not only the entire bodies of vertebrated animals, but, generally speaking, the smallest of their integral parts, are far too large to be viewed as microscopic objects, we can study their structure only by a separate examination of their component elements; and it seems, therefore, to be a most appropriate course to give under this head a sketch of the microscopic characters of those *primary tissues* of which their fabric is made up, and which, although they may be traced with more or less distinctness in the lower tribes of animals, attain their most complete development in this group.¹

Although there would at first sight appear but little in common between the simple bodies of those humble Protozoa which constitute the lowest types of the animal series, and the complex fabric of man or other vertebrates, yet it seems certain that in the latter, as in the former, the process of 'formation' is essentially carried on by the instrumentality of *protoplasmic substance*, universally diffused through it in such a manner as to bear a close resemblance to the pseudopodial network of the rhizopod; whilst the *tissues* produced by its agency lie, as it were, on the outside of this, bearing the same kind of relation to it as the foraminiferal shell does to the sarcodic substance which fills its cavities and extends itself over its surface. For, as was first pointed out by Dr. Beale,² the smallest living 'elementary part' of every organised

¹ This sketch is intended, not for the professional student, but only for the amateur microscopist who wishes to gain some general idea of the elementary structure of his own body and of that of vertebrate animals generally. Those who wish to go more deeply into the inquiry are referred to the following. The translation of Stricker's *Manual of Histology*, published by the New Sydenham Society; the translation of the 4th edition of Professor Frey's *Histology and Histo-Chemistry of Man*; the 'General Anatomy' of the 10th edition of *Quain's Anatomy*, 1893, by Professor Schäfer; and the *Atlas of Histology*, by Dr. Klein and Mr. Noble Smith.

² Professor Beale's views are most systematically expounded in his lectures *On the Structure of the Simple Tissues of the Human Body*, 1861; in his *How to work with the Microscope*, 5th edition, 1880; and in the introductory portion of his new

fabric is composed of organic matter in two states: the protoplasmic (which he termed *germinal matter*), possessing the power of selecting pabulum from the blood, and of transforming this either into the material of its own extension or into some product which it elaborates; whilst the other, which may be termed *formed material*, may present every gradation of character from a mere inorganic deposit to a highly organised structure, but is in every case altogether incapable of self-increase. A very definite line of demarcation can be generally drawn between these two substances by the careful use of the staining process; but there are many instances in which there is the same gradation between the one and the other as we have formerly noticed between the 'endosarc' and the 'ectosarc' of the *Amaba*. Thus it is on the protoplasmic component that the existence of every form of animal organisation essentially depends; since it serves as the instrument by which the nutrient material furnished by the blood is converted into the several forms of tissue. Like the sarcodic substance of the rhizopods, it seems capable of indefinite extension; and it may divide and subdivide into independent portions, each of which may act as the instrument of formation of an 'elementary part.' Two principal forms of such elementary parts present themselves in the fabric of the higher animals, viz. *cells* and *fibres* (which are modified cells); and it will be desirable to give a brief notice of these before proceeding to describe those more complex tissues which are the products of a higher elaboration.

The *cells* of which a few animal tissues are essentially composed consist, in some cases, of the same parts as the typical cell of the plant, viz. a definite 'cell-wall,' inclosing 'cell-contents' and a 'nucleus,' which is the seat of its formative activity. It is of such cells, retaining more or less of their characteristic spheroidal shape, that every mass of *fat*, whether large or small, is chiefly made up. In a large number of cases the cell shows itself in a somewhat different form, the 'elementary part' being a corpuscle of protoplasm of which the exterior has undergone a slight consolidation, like that which constitutes the 'primordial utricle' of the vegetable cell or the 'ectosarc' of the *Amaba*, but in which there is no proper distinction between 'cell-wall' and 'cell-contents.' This condition, which is characteristically exhibited by the nearly globular *colourless corpuscles* of the blood, appears to be common to all cells in the incipient stage of their formation, and the progress of their development consists in the gradual *differentiation* of their parts, the 'cell-wall' becoming distinctly separated from the 'cell-contents,' and these from the 'nucleus,' and the original protoplasm being very

edition of Todd and Bowman's *Physiological Anatomy*, 1867. The principal results of the inquiries of German histologists on this point are well stated in a paper by Dr. Duffin on 'Protoplasm, and the Part it plays in the Actions of Living Beings' in *Quart. Journ. Microsc. Sci.* n.s. vol. iii. 1863, p. 251. The Author feels it necessary, however, to express his dissent from Professor Beale's views in one important particular, viz. his denial of 'vital' endowments to the 'formed material' of any of the tissues; since it seems to him illogical to designate contractile muscular fibre (for example) as 'dead,' merely because it has not the power of self-reparation.

commonly replaced more or less completely by some special product (such as fat in the cells of adipose tissue, or hæmoglobin in the red corpuscles of the blood), in which cases the nucleus often disappears altogether. In the earlier stages of cell-development multiplication takes place with great activity by a duplicative subdivision that corresponds in all essential particulars with that of the plant-cell, as is well seen in cartilage, a section of which will often exhibit in one view the successive stages of the process.¹ Whether 'free' cell-multiplication ever takes place in the higher animals is at present uncertain.

A large part of the fabric of the higher animals is made up of *fibrous* tissues, which serve to bind together the other components, and which, when consolidated by calcareous deposit, constitute the substance of the skeleton. In these the relation of the 'germinal matter' and the 'formed material' presents itself under an aspect which seems at first sight very different from that just described. A careful examination, however, of those 'connective tissue corpuscles' that have long been distinguished in the midst of the fibres of which these tissues are made up, shows that they are the equivalents of the corpuscles of 'germinal matter,' which in the previous instance came to constitute cell-nuclei, and that the fibres hold the same relation to them that the 'walls' and 'contents' of cells do to their germinal corpuscles. The transition from the one type to the other is well seen in fibro-cartilage, in which the so-called 'inter-cellular substance' is often as fibrous as tendon. The difference between the two types, in fact, seems essentially to consist in this, that, whilst the segments of 'germinal matter' which form the cell-nuclei in cartilage and in other cellular tissues are completely isolated from each other, each being completely surrounded by the product of its own elaborating action, those which form the 'connective-tissue corpuscles' are connected together by radiating prolongations that pass between the fibres, so as to form a continuous network closely resembling that formed by the pseudopodia of the rhizopod. Of this we have a most beautiful example in bone; for whilst its solid substance may be considered as connective tissue solidified by calcareous deposit, the 'lacunæ' and 'canaliculi' which are excavated in it (fig. 752) give lodgment to a set of radiating corpuscles closely resembling those just described; and these are centres of 'germinal matter,' which appear to have an active share in the formation and subsequent nutrition of the osseous texture. In dentine (or tooth-substance) we seem to have another

¹ Great attention has lately been given by many able observers to the changes which take place in the *nucleus* before and during its cleavage. A full account of these is contained in Professor Strassburger's *Zellbildung und Zelltheilung*, 1880. See also Dr. Klein's 'Observations on the Structure of Cells and Nuclei' in *Quart. Journ. Microsc. Sci.* n.s. vol. xviii. 1878, p. 315, and vol. xix. 1879, pp. 125, 404; and chap. xlv. of his *Atlas of Histology*. The numerous essays of Flemming, in the *Archiv f. mikr. Anat.* from 1875 to 1890; Gruber, on the Nucleus of Protozoa, in vol. xl. of the *Zeitschr. f. Wiss. Zool.*; and Carnoy, in *La Cellule*, may be studied by those who desire to carry further the history of the cell. A remarkable series of observations have followed the publication of Professor E. van Beneden's work on the egg of *Ascaris megalocephala* in *Bull. Acad. Roy. Sci. Belg.* xiv. pp. 215-95.

form of the same thing, the walls of its 'tubuli' and the 'inter-tubular substance' being the 'formed material' that is produced from thread-like prolongations of 'germinal matter' issuing from its pulp, and continuing during the life of the tooth to occupy its tubes; just as in the *Foraminifera* we have seen a minutely tubular structure to be formed around the individual threads of sarcode which proceeded from the body of the contained animal. It may now be asserted, indeed, that the bodies of even the highest animals are everywhere penetrated by that protoplasmic substance of which those of the lowest and simplest are entirely composed; and that this substance, which forms a continuous network through almost every portion of the fabric, is the main instrument of the formation, nutrition, and reparation of the more specialised or differentiated tissues. As it is the purpose of this work, not to instruct the professional student in histology (or the science of the tissues), but to supply scientific information of general interest to the ordinary microscopist, no attempt will here be made to do more than describe the most important of those distinctive characters which the principal tissues present when subjected to microscopic examination; and as it is of no essential consequence what order is adopted, we may conveniently begin with the structure of the *skeleton*,¹ which gives support and protection to the softer parts of the fabric.

Bone.—The microscopic characters of osseous tissue may sometimes be seen in a very thin natural plate of bone, such as in that forming the scapula (shoulder-blade) of a mouse; but they are displayed more perfectly by artificial sections, the details of the arrangement being dependent upon the nature of the specimen selected and the direction in which the section is made. Thus when the shaft of a 'long' bone of a bird or mammal is cut across in the middle of its length, we find it to consist of a hollow cylinder of dense bone, surrounding a cavity which is occupied by an oily marrow; but if the section be made nearer its extremity we find the outside wall gradually becoming thinner, whilst the interior, instead of forming one large cavity, is divided into a vast number of small chambers, partially divided by a sort of 'lattice work' of osseous fibres, but communicating with each other and with the cavity of the shaft, and filled like it with marrow. In the bones of reptiles and fishes, on the other hand, this 'cancellated' structure usually extends throughout the shaft, which is not so completely differentiated into solid bone and medullary cavity as it is in the higher Vertebrata. In the most developed kinds of 'flat' bones, again, such as those of the head, we find the two surfaces to be composed of dense plates of bone, with a 'cancellated' structure between them: whilst in the less perfect type presented to us in the lower Vertebrata, the whole thickness is usually more or less 'cancellated,' that is, divided up into minute medullary cavities. When we examine, under a low magnifying power, a *longitudinal* section of a long bone, or a section

¹ This term is used in its most general sense, as including not only the proper internal skeleton, but also the hard parts protecting the exterior of the body, which form the *dermal* skeleton.

of a flat bone *parallel* to its surface, we find it traversed by numerous canals, termed *Haversian* after their discoverer Havers, which are in connection with the central cavity, and are filled like it with marrow. In the shafts of 'long' bones these canals usually run in the direction of their length, but are connected here and there by cross-branches; whilst in the flat bones they form an irregular network. On applying a higher magnifying power to a thin *transverse* section of a long bone we observe that each of the canals whose orifices present themselves in the field of view (fig. 751) is the centre of a rod of bony tissue (1), usually more or less circular in its form, which is arranged around it in concentric rings, resembling those of an exogenous stem. These rings are marked out and divided by circles of little dark spots, which, when closely examined (2), are seen to be minute flattened cavities excavated in the solid substance of the bone, from the two flat sides of which pass forth a number of extremely minute tubules, one set extending inwards, or in the direction of the centre of the system of rings, and the other outwards, or in the direction of its circumference; and by the inosculation of the tubules (or *canaliculi*) of the different rings with each other a continuous communication is established between the central Haversian canal and the outermost part of the bony rod that surrounds it, which doubtless ministers to the nutrition of



FIG. 751.—Minute structure of bone as seen in transverse section: 1, a rod surrounding an Haversian canal, 3, showing the concentric arrangement of the lamellae; 2, the same, with the lacunae and canaliculi; 4, portion of the lamellae parallel with the external surface.

the texture. Blood-vessels are traceable into the Haversian canals, but the 'canaliculi' are far too minute to carry blood-corpuscles; they are occupied, however, in the living bone by threads of protoplasmic substance, which bring the segments of 'germinal matter' contained in the lacunae into communication with the walls of the blood-vessels.

The minute cavities or *lacunae* from which the canaliculi proceed (fig. 752) are highly characteristic of true osseous tissue, being never deficient in the minutest parts of the bones of the higher Vertebrata, although those of fishes are occasionally destitute of them. The dark appearance which they present in sections of a dried bone is not due to opacity, but is simply an optical effect, dependent (like the blackness of air-bubbles in liquids) upon the dispersion of the rays by the highly refracting substance that surrounds them. The size and form of the lacunae differ considerably in the several classes of Vertebrata, and even in some instances in the orders, so that it is often possible to determine the group to which a bone belonged by the

microscopic examination of even a minute fragment of it. The following are the average dimensions of the lacunæ, in characteristic examples drawn from four principal divisions, expressed in fractions of an inch:—

	<i>Long Diameter</i>	<i>Short Diameter</i>
Man . . .	1-1440 to 1-2400	1-4000 to 1-8000
Ostrich . .	1-1333 „ 1-2250	1-5425 „ 1-9650
Turtle . . .	1-375 „ 1-1150	1-4500 „ 1-5840
Conger-eel .	1-550 „ 1-1135	1-4500 „ 1-8000

The lacunæ of *birds* are thus distinguished from those of *mammals* by their somewhat greater length and smaller breadth, but they differ still more in the remarkable tortuosity of their canaliculi, which wind backwards and forwards in a very irregular manner. There is an extraordinary increase in length in the lacunæ of *reptiles*, without a corresponding increase in breadth; and this is also seen in some *fishes*, though in general the lacunæ of the latter

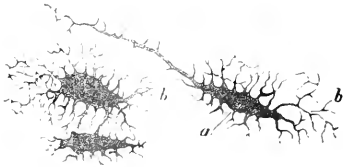

FIG. 752.—Lacunæ of osseous substance: a, central cavity; b, its ramifications.

are remarkable for their angularity of form and the fewness of their radiations, as shown in fig. 753, which represents the lacunæ and canaliculi in the bony scale of the *Lepidosteus* ('bony pike' of the North American lakes and rivers), with which the bones of its internal skeleton perfectly agree in structure. The dimensions of the lacunæ in any bone do not bear any relation to the size of the animal

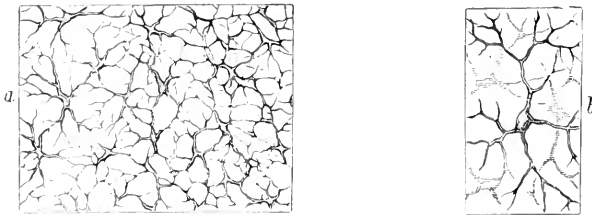

FIG. 753.—Section of the bony scale of *Lepidosteus*: a, showing the regular distribution of the lacunæ and of the connecting canaliculi; b, small portion more highly magnified.

to which it belonged; thus there is little or no perceptible difference between their size in the enormous extinct *Iguanodon* and in the smallest lizard now inhabiting the earth. But they bear a close relation to the size of the blood-corpuscles in the several classes; and this relation is particularly obvious in the 'perennibranchiate' *Batrachia*, the extraordinarily large size of whose blood-corpuscles will be presently noticed.

	<i>Long Diameter</i>	<i>Short Diameter</i>
Proteus . . .	1-570 to 1-980	1-885 to 1-1200
Siren . . .	1-290 „ 1-480	1-540 „ 1-975
Menopoma . . .	1-450 „ 1-700	1-1300 „ 1-2100
Lepidosiren . . .	1-375 „ 1-494	1-980 „ 1-2200
Pterodactyle . . .	1-445 „ 1-1185	1-4000 „ 1-5225 ¹

In preparing sections of bone it is important to avoid the penetration of the Canada balsam into the interior of the lacunæ and canaliculi, since when these are filled by it they become almost invisible. Hence it is preferable not to employ this cement at all, except it may be in the first instance, but to rub down the section beneath the finger, guarding its surface with a slice of cork or a slip of gutta-percha, and to give it such a polish that it may be seen to advantage even when mounted dry. As the polishing, however, occupies much time, the benefit which is derived from covering the surfaces of the specimen with Canada balsam may be obtained without the injury resulting from the penetration of the balsam into its interior, by adopting the following method. A quantity of balsam proportioned to the size of the specimen is to be spread upon a glass slip, and to be rendered stiffer by boiling, until it becomes nearly solid when cold; the same is to be done to the thin glass cover; next, the specimen being placed on the balsamed surface of the slide, and being overlain by the balsamed cover, such a degree of warmth is to be applied as will suffice to liquefy the balsam without causing it to flow freely, and the glass cover is then to be quickly pressed down, and the slide to be rapidly cooled, so as to give as little time as possible for the penetration of the liquefied balsam into the lacunar system. The same method may be employed in making sections of teeth.² The study of the *ossein* or organic basis of bone should be pursued by macerating a fresh bone in dilute nitro-hydrochloric acid, then steeping it for some time in pure water, and tearing thin shreds from the residual substance, which will be found to consist of an imperfectly fibrillated material, allied in its essential constitution to the 'white fibrous' tissue.

Teeth.—The intimate structure of the teeth in the several classes and orders of Vertebrata presents differences which are no less remarkable than those of their external form, arrangement, and succession. It will obviously be impossible here to do more than sketch some of the most important of these varieties. The principal part of the substance of all teeth is made up of a solid tissue that has been appropriately termed *dentine*. In sharks as in many other fishes the general structure of this dentine is extremely similar to that of bone, the tooth being traversed by numerous canals, which are continuous with the Haversian canals of the subjacent bone, and receive blood-vessels from them (fig. 754), while each of these canals

¹ See Professor J. Quekett's memoir on this subject in the *Trans. Microsc. Soc.* ser. i. vol. ii.; and his more ample illustration of it in the *Illustrated Catalogue of the Histological Collection in the Museum of the Royal College of Surgeons*, vol. ii.

² Some useful hints on the mode of making these preparations will be found in the *Quart. Journ. Microsc. Sci.* vol. vii. 1859, p. 258.

is surrounded by a system of tubuli (fig. 755), which radiate into the surrounding solid substance. These tubuli, however, do not enter lacunæ, nor is there any concentric annular arrangement around the medullary canals; but each system of tubuli is continued onwards, through its own division of the tooth, the individual tubes sometimes giving off lateral branches, whilst in other instances their trunks bifurcate. This arrangement is peculiarly well displayed, when sections of teeth constructed upon this type are viewed as opaque objects (fig. 756). In the teeth of the higher Vertebrata, however, we usually find the centre excavated into a single cavity (fig. 757), and the remainder destitute of vascular canals; but there are intermediate cases (as in the teeth of the great fossil sloths) in which the inner portion of the dentine is traversed by prolongations of this cavity, conveying blood-vessels, which do not pass into the exterior

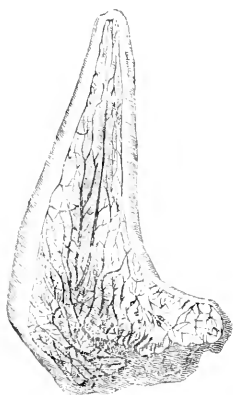

FIG. 754.—Perpendicular section of tooth of *Lamna*, moderately enlarged, showing network of medullary canals.

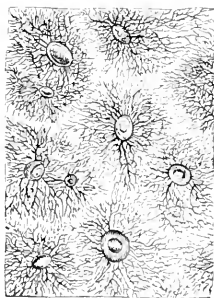

FIG. 755.—Transverse section of portion of tooth of *Pristis*, more highly magnified, showing orifices of medullary canals, with systems of radiating and inosculating tubuli.

layers. The tubuli of the 'non-vascular' dentine, which exists by itself in the teeth of nearly all mammalia, and which in the elephant is known as 'ivory,' all radiate from the central cavity, and pass towards the surface of the tooth in a nearly parallel course. Their diameter at their largest part averages $\frac{1}{10000}$ th of an inch; their smallest branches are immeasurably fine. The tubuli in their course present greater and lesser undulations; the former are few in number, but the latter are numerous; and as they occur at the same part of the course of several contiguous tubes they give rise to the appearance of lines concentric with the centre of radiation. These 'secondary curvatures' probably indicate in dentine, as in the crab's shell, successive stages of calcification. The tubuli are occupied, during the life of the tooth, by delicate threads of protoplasmic substance, extending into them from the central pulp.

Two other substances, one of them harder and the other softer

than dentine, are frequently found associated with it; the former is termed *enamel*, and the latter *cementum* or *crusta petrosa*. The *enamel* is composed of long prisms, closely resembling those of the 'prismatic' shell-substance formerly described, but on a far more minute scale, the diameter of the prisms not being more in man than $\frac{1}{5660}$ th of an inch. The length of the prisms corresponds with the thickness of the layer of enamel; and the two surfaces of this layer present the ends of the prisms, the form of which usually approaches the hexagonal. The course of the enamel prisms is more or less wavy, and they are marked by numerous transverse striæ, resembling those of the prismatic shell-substance, and probably originating in the same cause—the coalescence of a series of shorter prisms to form the lengthened prism. In man and in carnivorous animals the enamel covers the crown of the tooth only, with a simple cap or superficial layer of tolerably uniform thickness (fig. 757, *a*), which follows the surface of the dentine in all its inequalities; and its component prisms are directed at right angles to that surface, their inner extremities resting in slight but regular depressions on the exterior of the dentine. In the teeth of many herbivorous animals, however, the enamel forms (with the cementum) a series of vertical plates which dip down into the substance of the dentine, and present their edges alternately with it at the grinding surface of the tooth; and there is in such teeth no continuous layer of enamel over the crown. This arrangement provides by the unequal wear of these three substances (of which the enamel is the hardest, and the cementum the softest) for the constant maintenance of a rough surface, adapted to triturate the tough vegetable substances on which these animals feed. Though the enamel is not always present, it has been shown by Mr. Charles Tomes that the germ from which it is formed always appears

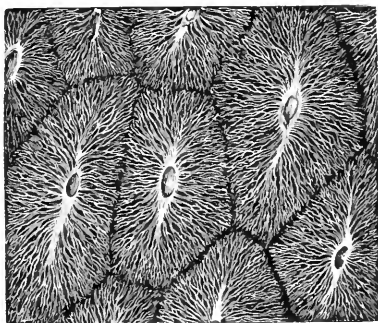

FIG. 756.—Transverse section of tooth of *Myliobates* (eagle ray), viewed as an opaque object.

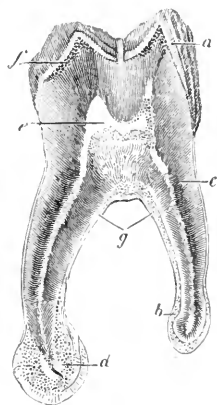

FIG. 757.—Vertical section of human molar tooth: *a*, enamel; *b*, cementum or crusta petrosa; *c*, dentine or ivory; *d*, osseous excrescence arising from hypertrophy of cementum; *e*, pulp-cavity; *f*, osseous lacuna at outer part of dentine.

Though the enamel is not always present, it has been shown by Mr. Charles Tomes that the germ from which it is formed always appears

in the embryonic tooth; and he has further shown that it is much more frequently present than used to be supposed. The *cementum*, or *crusta petrosa*, has the characters of true bone, possessing its distinctive stellate lacunæ and radiating canaliculi. Where it exists in small amount we do not find it traversed by medullary canals; but, like dentine, it is occasionally furnished with them, and thus resembles bone in every particular. These medullary canals enter its substance from the exterior of the tooth, and consequently pass towards those which radiate from the central cavity in the direction of the surface of the dentine, where this possesses a similar vascularity, as was remarkably the case in the teeth of the great extinct *Megatherium*. In the human tooth, however, the cementum has no such vascularity, but forms a thin layer (fig. 757, *b*), which envelopes the root of the tooth commencing near the termination of the cap of enamel. In the teeth of many herbivorous mammals it dips down with the enamel to form the vertical plates of the interior of the tooth; and in the teeth of the Edentata, as well as of many reptiles and fishes, it forms a thick continuous envelope over the whole surface, until worn away at the crown.¹

Dermal Skeleton.—The skin of fishes, of a few amphibians, of most reptiles, and of few mammals, is strengthened by plates of a horny, cartilaginous, bony, or even enamel-like texture, which are sometimes fitted together at their edges, so as to form a continuous box-like envelope; whilst more commonly they are so arranged as partially to overlie one another, like the tiles on a roof; and it is in this latter case that they are usually known as *scales*. Although we are accustomed to associate in our minds the ‘scales’ of fishes with those of reptiles, yet essentially different structures have been

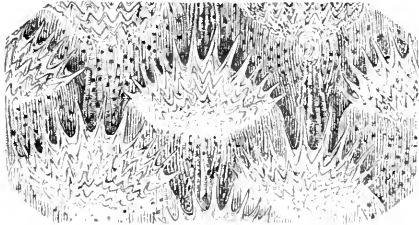

FIG. 758.—Portion of skin of sole, viewed as an opaque object.

included under this name, those of the former and of many of the latter being developed in the *substance* of the true skin (with a layer of which, in addition to the epidermis, they are always covered), and bearing a resemblance to cartilage and bone in their texture and composition; whilst others, such as the scales of snakes or the tortoise-shell, are formed upon the *surface* of the true skin, and are

to be considered as analogous to nails, hoofs, &c. and other ‘epidermic appendages.’ In nearly all the existing fishes the scales are flexible, being but little consolidated by calcareous deposit; and in some species they are so thin and transparent that, as they do not project obliquely from the surface of the skin, they can only be detected by raising the superficial layer of the skin and searching

¹ The student is recommended to consult Mr. C. S. Tomes’s *Manual of Dental Anatomy, Human and Comparative*.

beneath it, or by tearing off the entire thickness of the skin and looking for them near its under surface. This is the case, for example, with the common *eel*, and with the *cicparous blenny*; of either of which fish the skin is a very interesting object when dried and mounted in Canada balsam, the scales being seen imbedded in its substance, whilst its outer surface is studded with pigment-cells. Generally speaking, however, the posterior extremity of each scale projects obliquely from the general surface, carrying before it the thin membrane that incloses it, which is studded with pigment-cells; and a portion of the skin of almost any fish, but especially of such as have scales of the *ctenoid* kind (that is, furnished at their posterior extremities with comb-like teeth, fig. 759), when dried with its scales *in situ*, is a very beautiful opaque object for the low powers of the microscope (fig. 758), especially with the binocular arrangement. Care must be taken, however, that the light is made to glance upon it in the most advantageous manner, since the brilliance with which it is reflected from the comb-like projections entirely depends upon the angle at which it falls upon them. The only appearance of structure exhibited by the thin flat scale of the *eel*, when examined microscopically, is the presence of a layer of isolated spheroidal transparent bodies, imbedded in a plate of like transparency; these, from the researches of Professor W. C. Williamson¹ upon other scales, appear not to be cells (as they might readily be supposed to be), but concretions of carbonate of lime. When the scale of the *eel* is examined by polarised light its surface exhibits a beautiful St. Andrew's cross; and if a plate of selenite is placed behind it, and the analysing prism be made to revolve, a remarkable play of colours is presented.

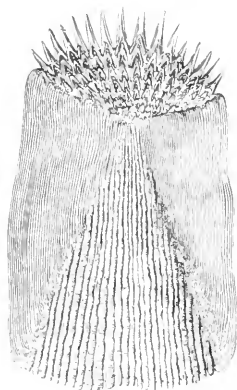

FIG. 759.—Scale of sole, viewed as a transparent object.

In studying the structure of the more highly developed scales, we may take as an illustration that of the *carp*, in which two very distinct layers can be made out by a vertical section, with a third but incomplete layer interposed between them. The outer layer is composed of several concentric laminae of a structureless transparent substance like that of cartilage; the outermost of these laminae is the smallest, and the size of the plates increases progressively from without inwards, so that their margins appear on the surface as a series of concentric lines; and their surfaces are thrown into ridges and furrows, which commonly have a radiating direction. The inner layer is composed of numerous laminae of a fibrous

¹ See his elaborate memoirs, 'On the Microscopic Structure of the Scales and Dermal Teeth of some Ganoid and Placoid Fish,' in *Phil. Trans.* 1849; and 'Investigations into the Structure and Development of the Scales and Bones of Fishes,' in *Phil. Trans.* 1851.

structure, the fibres of each lamina being inclined at various angles to those of the lamina above and below it. Between these two layers is interposed a stratum of calcareous concretions, resembling those of the scale of the eel; these are sometimes globular or spheroidal, but more commonly 'lenticular,' that is, having the form of a double convex lens. The scales which resemble those of the carp in having a form more or less circular, and in being destitute of comb-like prolongations, are called *cycloid*; and such are the characters of those of the salmon, herring, roach, &c. The structure of the *ctenoid* scales (fig. 759), which we find in the sole, perch, pike, &c., does not differ essentially from that of the *cycloid*, save as to the projection of the comb-like teeth from the posterior margin; and it does not appear that the strongly marked division which Professor Agassiz has attempted to establish between the 'cycloid' and the 'ctenoid' orders of fishes, on the basis of this difference, is in harmony with their general organisation. Scales of every kind may become consolidated to a considerable extent by the calcification of their soft substance; but they never present any approach to the true bony structure, such as is shown in the two orders to be next adverted to.

In the *ganoid* scales, on the other hand, the whole substance of the scale is composed of a material which is essentially bony in its nature, its intimate structure being always comparable to that of one or other of the varieties which present themselves in the bones of the vertebrate skeleton, and being very frequently identical with that of the bones of the same fish, as is the case with the *Lepidosteus* (fig. 753), one of the few existing representatives of this order, which, in former ages of the earth's history, comprehended a large number of important families. Their name (from *γάρος*, splendour) is bestowed on account of the smoothness, hardness, and high polish of the outer surface of the scales, which are due to the presence of a peculiar layer that has been likened to the enamel of teeth. The scales of this order are for the most part angular in their form, and are arranged in regular rows, the posterior edges of each slightly overlapping the anterior ones of the next, so as to form a very complete defensive armour to the body. The scales of the *placoid* type, which characterise the existing sharks and rays, with their fossil allies, are irregular in their shape, and very commonly do not come into mutual contact, but are separately imbedded in the skin, projecting from its surface under various forms. In the rays each scale usually consists of a flattened plate of a rounded shape, with a hard spine projecting from its centre; in the sharks (to which tribe belongs the 'dog-fish' of our own coast) the scales have more of the shape of teeth. This resemblance is not confined to external form; for their intimate structure strongly resembles that of dentine, their dense substance being traversed by tubuli, which extend from their centre to their circumference in minute ramifications, without any trace of osseous lacunae. These tooth-like scales are often so small as to be invisible to the naked eye; but they are well seen by drying a piece of the skin to which they are attached, and mounting it in Canada balsam; and they are most brilliantly shown by the assistance of polarised light.

A like structure is found to exist in the 'spiny rays' of the dorsal fin, which, also, are parts of the dermal skeleton; and these rays usually have a central cavity filled with medulla, from which the tubuli radiate towards the circumference. This structure is very well seen in thin sections of the fossil 'spiny rays,' which, with the teeth and scales, are often the sole relics of the vast multitudes of sharks that must have swarmed in the ancient seas, their cartilaginous internal skeletons having entirely decayed away. In making sections of bony scales, spiny rays, &c. the method must be followed which has been already detailed under the head of bone.¹

The *scales* of reptiles, the *feathers* of birds, and the *hairs, hoofs, nails, claws, and horns* (when not bony) of mammals are all *epidermic* appendages; that is, they are produced upon the surface, not within the substance of the true skin, and are allied in structure to the epidermis, being essentially composed of aggregations of cells filled with horny matter and frequently much altered in form. This structure may generally be made out in horns, nails, &c. with little difficulty by treating thin sections of them with a dilute solution of soda, which after a short time causes the cells that had been flattened into scales to resume their globular form. The most interesting modifications of this structure are presented to us in hairs and in feathers; which forms of clothing are very similar to each other in their essential nature, and are developed in the same manner—viz. by an increased production of epidermic cells at the bottom of a flask-shaped follicle, which is formed in the substance of the true skin, and which is supplied with abundance of blood by a special distribution of vessels to its walls. When a hair is pulled out 'by its root,' its base exhibits a bulbous enlargement, of which the exterior is tolerably firm, whilst its interior is occupied by a softer substance, which is known as the 'pulp;' and it is to the continual augmentation of this pulp in the deeper part of the follicle, and to its conversion into the peculiar substance of the hair when it has been pushed upwards to its narrow neck, that the growth of the hair is due. The same is true of feathers, the stems of which are but hairs on a larger scale; for the 'quill' is the part contained within the follicle answering to the 'bulb' of the hair; and whilst the outer part of this is converted into the peculiarly solid horny substance forming the 'barrel' of the quill, its interior is occupied, during the whole period of the growth of the feather, with the soft pulp, only the shrivelled remains of which, however, are found within it after the quill has ceased to grow.

Although the *hairs* of different mammals differ greatly in the appearances they present, we may generally distinguish in them two elementary parts—viz. a *cortical* or investing substance, of a dense horny texture, and a *medullary* or pith-like substance, usually of a much softer texture, occupying the interior. The former can

¹ For further information regarding the scales of fishes, see the papers by O. Hertwig in vol. viii. of the *Jenaische Zeitschrift*, and vols. ii. and v. of the *Morpholog. Jahrbuch*. A condensed summary of our knowledge, from the more recent standpoint, will be found in Dean's *Fishes, Living and Fossil* (New York, 1895), pp. 23-6.

sometimes be distinctly made out to consist of flattened scales arranged in an imbricated manner, as in some of the hairs of the sable (fig. 760); whilst in the same hairs, the medullary substance is composed of large spheroidal cells. In the musk deer, on the other hand, the cortical substance is nearly undistinguishable, and



FIG. 760.—Hair of sable, showing large rounded cells in its interior, covered by imbricated scales or flattened cells.

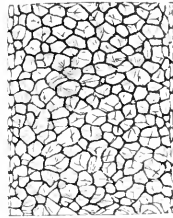

FIG. 761.—Hair of musk-deer, consisting almost entirely of polygonal cells.

almost the entire hair seems made up of thin-walled polygonal cells (fig. 761). The hair of the reindeer, though much larger, has a very similar structure; and its cells, except near the root, are occupied with hair alone, so as to seem black by transmitted light, except when penetrated by the fluid in which they are mounted. In the hair of the mouse, squirrel, and other small rodents (fig. 762. A, B),

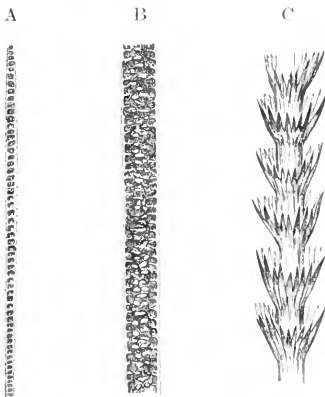

FIG. 762.—A, small hair of squirrel; B, large hair of squirrel; C, hair of Indian bat.

the cortical substance forms a tube, which we see crossed at intervals by partitions that are sometimes complete, sometimes only partial: these are the walls of the single or double line of cells, of which the medullary substance is made up. The hairs of the bat tribe are commonly distinguished by the projections on their surface, which are formed by extensions of the component scales of the cortical substance: these are particularly well seen in the hairs of one of the Indian species, which has a set of whorls of long narrow leaflets (so to speak) arranged at

regular intervals on its stem (C). In the hair of the peccary (fig. 763) the cortical envelope sends inwards a set of radial prolongations, the interspaces of which are occupied by the polygonal cells of the medullary substance; and this, on a larger scale, is the structure of the 'quills' of the porcupine, the radiating partitions of which, when seen through the more transparent parts of the cortical sheath, give to

the surface of the latter a fluted appearance. The hair of the ornithorhynchus is a very curious object; for whilst the lower part of it resembles the fine hair of the mouse or squirrel, this thins away and then dilates again into a very thick fibre, having a central portion composed of polygonal cells, inclosed in a flattened sheath of a brown fibrous substance.

The structure of the *human* hair is in certain respects peculiar. When its outer surface is examined, it is seen to be traversed by irregular lines (fig. 764, A), which are most strongly marked in fetal hairs; and these are the indications of the imbricated arrangement of the flattened cells or scales which form the cuticular layer. This layer, as is shown by transverse sections (C, D), is a very thin and transparent cylinder; and it incloses the peculiar fibrous substance that constitutes the principal part of the shaft of the hair. The constituent fibres of the substance, which are marked out by the delicate striæ that may be traced in longitudinal sections of the hair (B), may be separated from each other by crushing the hair, especially after it has been macerated for some time in sulphuric acid; and each of them, when completely isolated from its fellows, is found to be a long spindle-shaped cell. In the axis of this fibrous cylinder there is very commonly a band which is formed of spheroidal

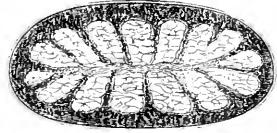

FIG. 763.—Transverse section of hair of peccary.

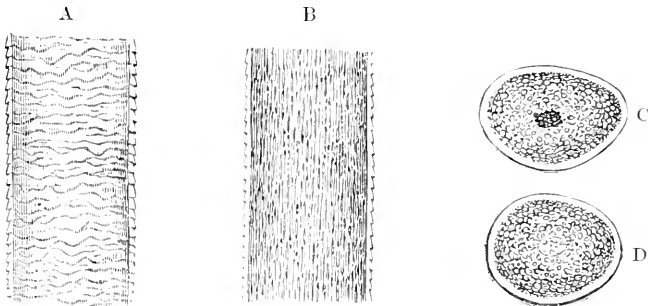

FIG. 764.—Structure of human hair: A, external surface of the shaft, showing the transverse striæ and jagged boundary caused by the imbrications of the cuticular layer; B, longitudinal section of the shaft, showing the fibrous character of the cortical substance, and the arrangement of the pigmentary matter; C, transverse section, showing the distinction between the cuticular envelope, the cylinder of cortical substance, and the medullary centre; D, another transverse section, showing deficiency of the central cellular substance.

cells; but this 'medullary' substance is usually deficient in the fine hairs scattered over the general surface of the body, and is not always present in those of the head. The hue of the hair is due partly to the presence of pigmentary granules, either collected into patches or diffused through its substance, but partly also to the existence of a multitude of minute air-spaces, which cause it to

appear dark by transmitted and white by reflected light. The cells of the medullary axis in particular are very commonly found to contain air, giving it the black appearance shown at C. The difference between the blackness of pigment and that of air-spaces may be readily determined by attending to the characters of the latter as already laid down, and by watching the effects of the penetration of oil of turpentine or other liquids, which do not alter the appearance of pigment spots, but obliterate all the markings produced by air-spaces, these returning again as the hair dries. In mounting hairs as microscopic preparations they should in the first instance be cleansed of all their fatty matter by maceration in ether, and they may then be put up either in weak spirit or in Canada balsam, as may be thought preferable, the former menstruum being well adapted to display the characters of the finer and more transparent hairs, while the latter allow the light to penetrate more readily through the coarser and more opaque. Transverse sections of hairs are best made by glueing or gumming several together and then putting them into the microtome; those of human hair may be easily obtained, however, by shaving a second time, very closely, a part of the surface over which the razor has already passed more lightly, and by picking out from the lather, and carefully washing, the sections thus taken off.¹

The stems of *feathers* exhibit the same kind of structure as hairs, their cortical portion being the horny sheath that envelopes the shaft, and their medullary portion being the pith-like substance which that sheath includes. In small feathers this may usually be made very plain by mounting them in Canada balsam; in large feathers, however, the texture is sometimes so altered by the drying up of the pith (the cells of which are always found to be occupied by air alone) that the cellular structure cannot be demonstrated save by boiling thin slices in a dilute solution of potass, and not always even then. In small feathers, especially such as have a downy character, the cellular structure is very distinctly seen in the lateral *barbs*, which are sometimes found to be composed of single files of pear-shaped cells, laid end to end; but in larger feathers it is usually necessary to increase the transparency of the barbs, especially when these are thick and but little pervious to light, either by soaking them in turpentine, mounting them in Canada balsam, or boiling them in a weak solution of potass. In feathers which are destined to strike the air with great force in the act of flight, we find each barb fringed on either side with slender flattened filaments or 'barbules;' the barbules of the distal side of each barb are furnished on their attached half with curved hooks, whilst those of the proximal side have thick turned-up edges in their median portion; as the two sets of barbules that spring from two adjacent barbs cross each other at an angle, and as each hooked barbule of one locks into the thickened edge of several barbules of the other, the barbs are connected very firmly, in a mode very similar to that

¹ On the minute structure of hair, consult Grimm's *Atlas der menschlichen und tierischen Haare* (Lahr, 1881, 4to, with a preface by W. Waldeyer).

in which the anterior and posterior wings of certain hymenopterous insects are locked together. Feathers or portions of feathers of birds distinguished by the splendour of their plumage are very good objects for low magnifying powers when illuminated on an opaque ground; but care must be taken that the light falls upon them at the angle necessary to produce their most brilliant reflection into the axis of the microscope; since feathers which exhibit the most splendid metallic lustre to an observer at one point may seem very dull to the eye of another in a different position. The small feathers of humming-birds, portions of the feathers of the peacock, and others of a like kind, are well worthy of examination; and the scientific microscopist, who is but little attracted by mere gorgeousness, may well apply himself to the discovery of the peculiar structure which imparts to these objects their most remarkable character.¹

Sections of *horns, hoofs, claws*, and other like modifications of epidermic structure—which can be easily made by the microtome, the substance to be cut having been softened, if necessary, by soaking in warm water—do not in general afford any very interesting features when viewed in the ordinary mode; but there are no objects on which polarised light produces more remarkable effects, or which display a more beautiful variety of colours when a plate of selenite is placed behind them and the analysing prism is made to rotate. A

curious modification of the ordinary structure of the horn is presented in the appendage borne by the rhinoceros upon its snout, which in many points resembles a bundle of hairs, its substance being arranged in minute cylinders around a number of separate centres, which have probably been formed by independent papillæ (fig. 765). When transverse sections of these cylinders are viewed by polarised light, each of them is seen to be marked by a cross,

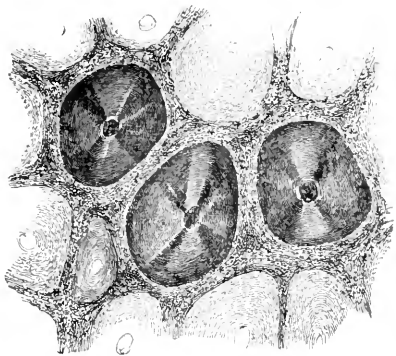

FIG. 765.—Transverse section of horn of rhinoceros viewed by polarised light.

and the light and shadow of this cross are replaced by contrasted colours when the selenite plate is interposed. The substance commonly but erroneously termed *whalebone*, which is formed from the surface of the membrane that lines the mouth of the whale, and has no relation to its true bony skeleton, is almost identical in structure with rhinoceros-horn, and is similarly affected by polarised light. The central portion of each of its component threads, like the medullary

¹ See R. S. Wray, 'On the Structure of the Barbs, Barbules, and Barbicels of a typical Pennaceous Feather,' in the *Ibis* for 1887, p. 420.

substance of hairs, contains cells that have been so little altered as to be easily recognised; and the outer or cortical portion also may be shown to have a like structure by macerating it in a solution of potass and then in water. Sections of any of the horny tissues are best mounted in Canada balsam.

Blood.—Carrying our microscopic survey, now, to the elementary parts of which those softer tissues are made up that are subservient to the active life of the body rather than to its merely mechanical requirements, we shall in the first place notice the isolated floating

cells contained in the blood, which are known as blood-corpuscles. These are of two kinds: the 'red' and the 'white' or 'colourless.' The *red* present, in every instance, the form of a flattened disc, which is circular in man and most mammalia (fig. 767), but is oval in birds, reptiles (fig. 766), and fishes, as also in a few mammalia (all belonging to the camel tribe). In the one form as in the other, these corpuscles seem to be flattened cells, the walls of which, however, are not distinctly differentiated from the ground substance they contain, as appears from the changes of form which they spontaneously undergo when kept by means of a 'warm stage' at a temperature of about 100° F., and from the effects of pressure in breaking them up. The red corpuscles in the blood of oviparous Vertebrata are distinguished by the presence of a

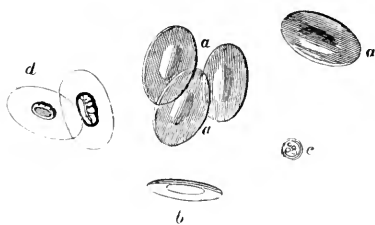

FIG. 766.—Red corpuscles of frog's blood: *aa*, their flattened face; *b*, particle turned nearly edgewise; *c*, colourless corpuscle; *d*, red corpuscles altered by diluted acetic acid.

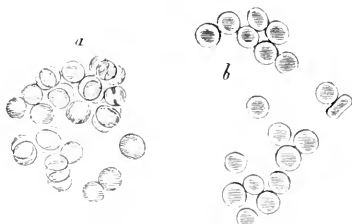

FIG. 767.—Red corpuscles of human blood, represented at *a*, as they are seen when rather within the focus of the microscope; and at *b*, as they appear when precisely in the focus.

central spot or *nucleus*; this is most distinctly brought into view by treating the blood-disks with acetic acid, which causes the nucleus to shrink and become more opaque, whilst rendering the remaining portion extremely transparent (fig. 766, *d*). By examining unaltered red corpuscles of the frog or newt under a sufficiently high magnifying power the nucleus is seen to be traversed by a network of filaments, which extends from it throughout the ground substance of the corpuscle, constituting an intracellular reticulation. The red corpuscles of the blood of mammalia, however, possess no distinguishable nucleus, the dark spot which is seen in their centre (fig. 767, *b*) being merely an effect of refraction, consequent upon the double concave form of the disc. When these corpuscles are treated with water, so that their form becomes first flat and then

double convex, the dark spot disappears; whilst, on the other hand, it is made more evident when the concavity is increased by the partial shrinkage of the corpuscles, which may be brought about by treating them with fluids of greater density than their own substance. When floating in a sufficiently thick stratum of blood drawn from the body, and placed under a cover-glass, the red corpuscles show a marked tendency to approach one another, adhering by their discoidal surfaces so as to present the aspect of a pile of coins; or, if the stratum be too thin to admit of this, partially overlapping, or simply adhering by their edges, which then become polygonal instead of circular. The size of the red corpuscles is not altogether uniform in the same blood; thus it varies in that of man from about the $\frac{1}{4000}$ th to the $\frac{1}{2800}$ th of an inch. But we generally find that there is an average size, which is pretty constantly maintained among the different individuals of the same species; that of man may be stated at about $\frac{1}{3200}$ th of an inch. The following table¹ exhibits

MAMMALS

Man	1-3200	Camel	1-3254, 1-5921
Dog	1-3542	Llama	1-3361, 1-6294
Whale	1-3099	Javan chevrotain	1-12325
Elephant	1-2745	Caucasian goat	1-7045
Mouse	1-3814	Two-toed sloth	1-2865

BIRDS

Golden eagle	1-1812, 1-3832	Ostrich	1-1649, 1-3000
Owl	1-1830, 1-3400	Cassowary	1-1455, 1-2800
Crow	1-1961, 1-4000	Heron	1-1913, 1-3491
Blue-tit	1-2313, 1-4128	Fowl	1-2102, 1-3466
Parrot	1-1898, 1-4000	Gull	1-2097, 1-4000

REPTILES AND BATRACHIA

Turtle	1-1231, 1-1882	Frog	1-1108, 1-1821
Crocodile	1-1231, 1-2286	Water-newt	1-8014, 1-1246
Green lizard	1-1555, 1-2743	Siren	1-420, 1-760
Slow-worm	1-1178, 1-2666	Proteus	1-400, 1-727
Viper	1-1274, 1-1800	Amphiuma	1-345, 1-561

FISHES

Perch	1-2099, 1-2824	Pike	1-2000, 1-3555
Carp	1-2142, 1-3429	Eel	1-1745, 1-2842
Gold-fish	1-1777, 1-2824	Gymnotus	1-1745, 1-2599

the average dimensions of some of the most interesting examples of the red corpuscles in the four classes of vertebrated animals, expressed in fractions of an inch. Where two measurements are given they are the long and the short diameters of the same corpuscles. (See also fig. 768.) Thus it appears that the *smallest* red corpuscles known are those of the Javan chevrotain (*Tragulus javanicus*), whilst the *largest* are those of that curious group of Batrachia (frog tribe) which

¹ These measurements are chiefly selected from those given by Mr. Gulliver in his edition of Hewson's *Works*, p. 236 *et seq.*

retain the gills through the whole of life; one of the oval blood-discs of the *Proteus*, being more than thirty times as long and seventeen times as broad as those of the musk-deer, would cover no fewer than 510 of them. Those of the *Amphiuma* are still larger.¹ According to the estimate of Vierordt, a cubic inch of human blood contains upwards of *eighty millions* of red corpuscles and nearly a *quarter of a million* of the colourless.

The *white* or 'colourless' corpuscles are more readily distinguished

in the blood of batrachians than in that of man, being in the former case of much smaller size, as well as having a circular outline (fig. 766, c): whilst in the latter their size and contour are so nearly the same that, as the red corpuscles themselves, when seen in a single layer, have but a very pale hue, the deficiency of colour does not sensibly mark their difference of nature. The proportion of *white* to *red* corpuscles being scarcely even greater (in a healthy man) than 1 to 250, and often as low as from one half to one quarter of that ratio, there are seldom many of them to be seen in the field at once; and these may be recognised rather by their isolation than their colour, especially if the glass cover be moved a little on the slide, so as to cause the red corpuscles to become aggregated into rows and irregular

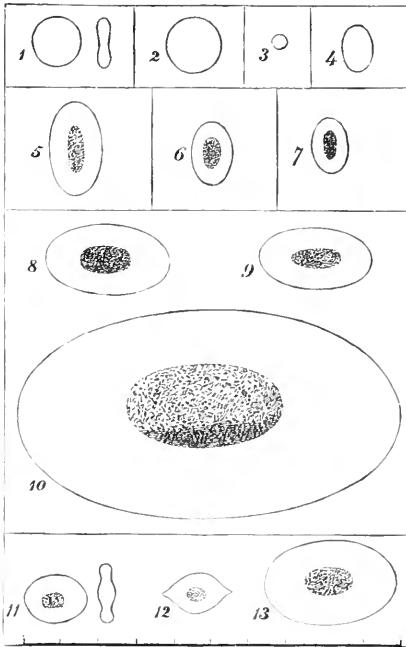

FIG. 768.—Comparative sizes of red blood corpuscles: 1, man; 2, elephant; 3, musk-deer; 4, dromedary; 5, ostrich; 6, pigeon; 7, humming-bird; 8, crocodile; 9, python; 10, proteus; 11, perch; 12, pike; 13, shark.

masses. It is remarkable that, notwithstanding the great variations in the sizes of the red corpuscles in different species of vertebrated animals, the size of the white is extremely constant throughout, their diameter being seldom much greater or less than $\frac{1}{50000}$ th of an inch in the warm-blooded classes and $\frac{1}{25000}$ th in reptiles. Their ordinary form is globular, but their aspect is subject to considerable variations, which seem to depend in great part upon their phase of development.

¹ A very interesting account of the 'Structure of the Red Corpuscles of the *Amphiuma tridactylum*' has been given by Dr. H. D. Schmidt, of New Orleans, in the *Journ. Roy. Microsc. Soc.* vol. i. 1879, pp. 57, 97.

Thus, in their early state, in which they seem to be identical with the corpuscles found floating in *chyle* and *lymph*, they seem to be nearly homogeneous particles of protoplasmic substance, but in their more advanced condition, according to Dr. Klein, their substance consists of a reticulation of very fine contractile protoplasmic fibres, termed the 'intracellular network,' in the meshes of which a hyaline interstitial material is included, and which is continuous with a similar network that can be discerned in the substance of the single or double nucleus when this comes into view after the withdrawal of these corpuscles from the body. In their living state, however, whilst circulating in the vessels, the white corpuscles, although clearly distinguishable in the slow-moving stratum in contact with their walls (the red corpuscles rushing rapidly through the centre of the tube), do not usually show a distinct nucleus. This may be readily brought into view by treating the corpuscles with water, which causes them to swell up, become granular, and at last disintegrate, with emission of granules which may have been previously seen in active molecular movement within the corpuscle. When the white corpuscles in a drop of freshly drawn blood are carefully watched for a short time, they may be observed to undergo changes of form, and even to move from place to place, after the manner of *Amoeba*. When thus moving they engulf particles which lie in their course—such as granules of vermilion that have been injected into the blood-vessels of the living animal—and afterwards eject these in the like fashion.¹ Such movements will continue for some time in the colourless corpuscles of cold-blooded animals, but still longer if they are kept in a temperature of about 75°. The movement will speedily come to an end, however, in the white corpuscles of man or other warm-blooded animals.

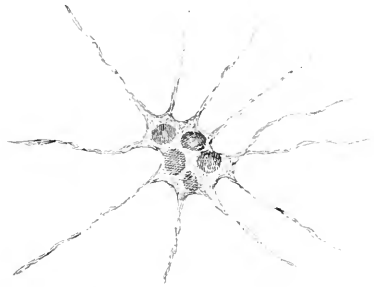

FIG. 769.—Altered white corpuscle of blood an hour after having been drawn from the finger.

¹ Metschnikoff has made the highly interesting and important observation that the immunity of certain animals to certain diseases appears to be due to the power that the white corpuscles possess of acting as 'phagocytes,' or eating the germs of the disease. Metschnikoff found that the virulent rods of the *Bacillus* of anthrax 'when introduced by inoculation into an animal liable to take the fever, such as a rodent, were absorbed by the blood-cells only in exceptional instances. They were readily absorbed by the blood-cells of animals not liable to the disease, as frogs and lizards, when the temperature was not artificially raised (fig. 770), and then disappeared inside the cells. . . . From all these data we must assume with Metschnikoff that the *Bacillus* is harmless because it is absorbed and destroyed by the blood-cells, and injurious because this does not happen; or at least that it becomes harmless if the destruction by the blood-cells takes place more rapidly, and to a greater extent than the growth and multiplication of the *Bacillus*, the converse being also true' (see A. de Bary, *On Bacteria*, English edition, p. 136). The importance of phagocytes is becoming more and more recognised by the pathologist.

unless the slide is kept on a warm stage at the temperature of about 100° F. A remarkable example of an extreme change of form in a white corpuscle of human blood is represented in fig. 769. Similar changes have been observed also in the corpuscles floating in the circulating fluid of the higher invertebrata, as the crab, which resemble the 'white' corpuscles of vertebrated blood, rather than its 'red' corpuscles—these last, in fact, being altogether peculiar to the circulating fluid of vertebrated animals.

In examining the blood microscopically it is, of course, important to obtain as thin a stratum of it as possible, so that the corpuscles may not overlies one another.

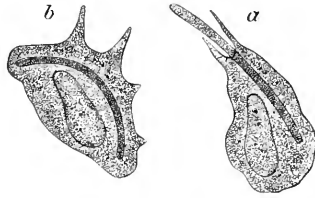

FIG. 770.—*a*, blood-cell of a frog in the act of engulfing a rod of *Bacillus anthracis*, observed in the living state in a drop of aqueous humour; *b*, the same a few minutes later. (After Metschnikoff; highly magnified.)

This is best accomplished by selecting a piece of thin glass of perfect flatness, and then, having received a small drop of blood upon a glass slide, to lay the thin glass cover *not upon* this, but with its edge just touching the edge of the drop: for the blood will then be drawn in by capillary attraction, so as to spread in a uniformly thin layer between the two glasses. Such thin films may be preserved in the liquid state by applying a cover glass and cementing it with gold-size before evaporation has taken place; but it

is preferable first to expose the drop to the vapour of osmic acid, and then to apply a drop of a weak solution of acetate of potass; after which a cover glass may be put on, and secured with gold-size in the usual way. It is far simpler, however, to allow such films to dry without any cover, and then merely to cover them for protection; and in this condition the general characters of the corpuscles can be very well made out, notwithstanding that they have in some degree been shrivelled by the desiccation they have undergone. This method is particularly serviceable as affording a fair means of comparison, when the assistance of the microscopist is sought in determining, for medico-legal purposes, the source of suspicious blood-stains, the average dimensions of the dried blood-corpuscle of the several domestic animals being sufficiently different from each other, and from those of man, to allow the nature of any specimen to be pronounced upon with a high degree of probability.¹

Simple Fibrous Tissues.—A very beautiful example of a tissue of this kind is furnished by the membrane of the common fowl's egg; which (as may be seen by examining an egg whose shell remains soft for want of consolidation by calcareous particles) consists of two principal layers, one serving as a basis of the shell itself, and the other forming that lining to it which is known as the *membrana*

¹ This is a matter which has given rise to much discussion among experts. See *Proc. Amer. Micr. Soc.* xiv. (1893), pp. 91-120

putaminis. The latter may be separated by careful tearing with needles and forceps, after prolonged maceration in water, into several matted lamellæ resembling that represented in fig. 771; and similar lamellæ may be readily obtained from the shell itself by dissolving

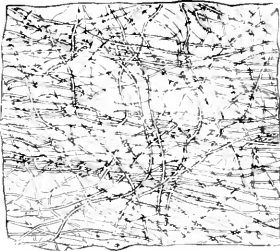

FIG. 771.—Fibrous membrane from egg-shell.



FIG. 772.—White fibrous tissue from ligament.

away its lime by dilute acid. The simply fibrous structures of the body generally, however, belong to one of two very definite kinds of tissue, the 'white' and the 'yellow,' whose appearance, composition, and properties are very different. The *white* fibrous tissue, though sometimes apparently composed of distinct fibres, more commonly presents the aspect of bands, usually of a flattened form, and attaining the breadth of $\frac{1}{3000}$ th of an inch, which are marked by numerous longitudinal streaks, but can seldom be torn up into minute fibres of determinate size. The fibres and bands are occasionally somewhat wavy in their direction; and they have a peculiar tendency to fall into undulations, when it is attempted to tear them apart from each other (fig. 772). This tissue is easily distinguished from the other by the effect of acetic acid, which swells it up and renders it transparent, at the same time bringing into view certain oval nuclear particles of 'germinal matter,' which are known as 'connective tissue corpuscles.' These are relatively much larger, and their connections more distinct, in the earlier stages of the formation of this tissue (fig. 773). It is perfectly inelastic; and we find it in such parts as tendons, ordinary ligaments, fibrous capsules, &c. whose function it is to resist tension without yielding to it. It constitutes, also, the organic basis or matrix of bone; for although the substance which is left when a bone has been macerated sufficiently long in dilute acid for all its mineral components to be



FIG. 773.—Portion of young tendon, showing the corpuscles of 'germinal matter,' with their stellate prolongations, interposed among its fibres.

removed is commonly designated as cartilage, this is shown by careful microscopic analysis not to be a correct description of it, since it does not show any of the characteristic structure of cartilage, but is capable of being torn into lamellæ, in which, if sufficiently thin, the ordinary structure of a fibrous membrane can be distinguished. The *yellow* fibrous tissue exists in the form of long, single, elastic, branching filaments, with a dark decided border; which are disposed to curl when not put on the stretch (fig. 774), and frequently anastomose, so as to form a network. They are for the most part between $\frac{1}{30000}$ th and $\frac{1}{100000}$ th of an inch in diameter; but they are often met with both larger and smaller. This tissue does not undergo any change when treated with acetic acid. It exists alone (that is, without any mixture of the white) in parts which require a peculiar elasticity, such as the middle coat of the arteries, the 'vocal cords,' the 'ligamentum nuchæ' of quadrupeds,



FIG. 774.—Yellow fibrous tissue from ligamentum nuchæ of calf.

the elastic ligament which holds together the valves of a bivalve shell, and that by which the claws of the feline tribe are retracted when not in use; and it enters largely into the composition of *areolar* or connective tissue.

The tissue formerly known to anatomists as 'cellular,' but now more properly designated *connective* or *areolar* tissue, consists of a network of minute fibres and bands which are

interwoven in every direction, so as to leave innumerable *areolæ* or little spaces that communicate freely with one another. Of these fibres some are of the 'yellow' or elastic kind, but the majority are composed of the 'white' fibrous tissue; and, as in that form of elementary structure, they frequently present the condition of broad flattened bands or membranous shreds in which no distinct fibrous arrangement is visible. The proportion of the two forms varies, according to the amount of elasticity, or of simple resisting power, which the endowments of the part may require. We find this tissue in a very large proportion of the bodies of higher animals; thus it binds together the ultimate muscular fibres into minute fasciculi, unites these fasciculi into larger ones, these again into still larger ones which are obvious to the eye, and these into the entire muscle; whilst it also forms the membranous divisions between distinct muscles. In like manner it unites the elements of nerves, glands, &c., binds together the fat-cells into minute masses (fig. 780), these into large ones, and so on; and in this way penetrates and forms part of all the softer organs of the body. But whilst the fibrous structures of which the 'formed tissue' is composed have a purely mechanical function, there is good reason to regard the 'connective

tissue corpuscles' which are everywhere dispersed among them, as having a most important function in the first production and subsequent maintenance of the more definitely organised portions of the fabric. In these corpuscles distinct *movements*, analogous to those of the sarcoodic extensions of rhizopods, have been recognised in transparent parts, such as the cornea of the eye and the tail of the young tadpole, by observations made on these parts whilst living. For the display of the characters of the fibrous tissues small and thin threads may be cut with the curved scissors from any part that affords them; and these must be torn asunder with needles under the simple microscope, until the fibres are separated to a degree sufficient to enable them to be examined to advantage under a higher magnifying power. The difference between the 'white' and the 'yellow' components of connective tissue is at once made apparent by the effect of acetic acid; whilst the 'connective tissue corpuscles' are best distinguished by the staining process, especially in the early stage of the formation of these tissues (fig. 773).

Skin; Mucous and Serous Membranes.

The skin, which forms the external envelope of the body, is divisible into two principal layers: the *cutis vera* or 'true skin,' which usually makes up by far the larger part of its thickness, and the 'cuticle,' 'scarf-skin,' or *epidermis*, which covers it. At the mouth, nostrils, and the other orifices of the open cavities and canals of the body, the skin passes into the membrane that lines these, which is distinguished as the *mucous* membrane, from the peculiar glairy secretion of mucus by which its surface is protected. But those great

closed cavities of the body which surround the heart, lungs, intestines, &c. are lined by membranes of a different kind: which, as they secrete only a thin serous fluid from their surfaces, are known as *serous* membranes. Both mucous and serous membranes consist, like the skin, of a cellular membranous basis, and of a thin cuticular layer, which, as it differs in many points from the epidermis, is distinguished as the epithelium. The substance of the 'true skin' and of the 'mucous' and 'serous' membranes is principally composed of the fibrous tissues last described; but the skin and the mucous membranes are very copiously supplied with blood-vessels and with glandulæ of various kinds; and in the skin we also find abundance of nerves and lymphatic vessels, as well as, in some parts, of hair-

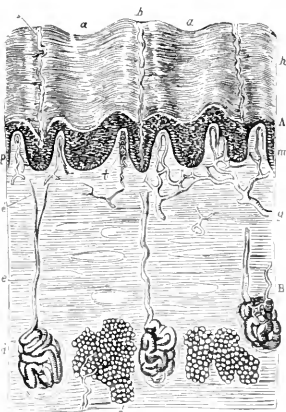

FIG. 775.—Vertical section of skin of finger: A, *epidermis*, the surface of which shows depressions *a a*, between the eminences *b b*, on which open the perspiratory ducts *s*; at *m* is seen the deeper layer of the epidermis, or stratum Malpighii. B, *cutis vera*, in which are imbedded the sweat-glands *d*, with their ducts *c*, and aggregations of fat cells *f*; *g*, arterial twig supplying the vascular papillæ *p*; *t*, one of the tactile papillæ with its nerve.

follicles. The general appearance ordinarily presented by a thin vertical section of the skin of a part furnished with numerous sensory *papillæ* is shown in fig. 775; where we see in the deeper layers of the *cutis vera* little clumps of fat-cells, *f*, and the sweat-glands, *dd*, whose ducts, *ee*, pass upwards: whilst on its surface we distinguish the *vascular papillæ*, *p*, supplied with loops of blood-vessels from the trunk, *g*, and a *tactile papilla*, *t*, with its nerve twig. The spaces between the papillæ are filled up by the soft 'Malpighian layer,' *m*, of the epidermis, *A*, in which its colouring matter is chiefly contained, whilst this is covered by the horny layer, *h*, which is traversed by the spirally twisted continuations of the perspiratory ducts, opening at *s* upon the surface, which presents alternating depressions, *a*, and elevations, *b*. The distribution of the blood-vessels in the skin and mucous membranes, which is one of the most interesting features in their structure, and which is intimately connected with their several functions, will come under our notice hereafter. In serous membranes, on the other hand, whose function is simply protective, the supply of blood-vessels is more scanty.

Epidermic and Epithelial Cell-layers.—The epidermis or 'cuticle' covers the whole exterior of the body as a thin semitransparent pellicle, which is shown by microscopic examination to consist of a series of layers of cells that are continually wearing off at the external surface, and being renewed at the surface of the true skin; so that the newest and deepest layers gradually become the oldest and most superficial, and are at last thrown off by slow desquamation. In their progress from the internal to the external surface of the

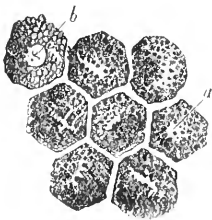

FIG. 776.—Cells from the *pigmentation nigrum* of the eye: *a*, pigmentary granules concealing the nucleus; *b*, the nucleus.

epidermis the cells undergo a series of well-marked changes. When we examine the innermost layer, we find it soft and granular, consisting of nucleated cells which are flatter in the upper than the lower strata, which make up the layer. This was formerly considered as a distinct tissue, and was supposed to be the peculiar seat of the colour of the skin; it received the designation of Malpighian layer or *rete mucosum*. The change in form is accompanied by a change in the chemical composition of the tissue, which seems to be due to the metamorphosis of the contents of the cells into a

horny substance identical with that of which hair, horn, nails, hoofs, &c. are composed. Mingled with the epidermic cells we find others which secrete colouring matter instead of horn; these, which are termed 'pigment-cells,' are especially to be noticed in the epidermis of the negro and other dark races, and are most distinguishable in the Malpighian layer, their colour appearing to fade as they pass towards the surface. The most remarkable development of pigment-cells in the higher animals, however, is on the inner surface of the choroid coat of the eye, where they have a very regular arrangement, and form several layers, known as

the *pigmentum nigrum*. When examined separately these cells are found to have a polygonal form (fig. 776, *a*), and to have a distinct nucleus (*b*) in their interior. The black colour is due to the accumulation, within each cell, of a number of flat rounded or oval granules, of extreme minuteness, which exhibit an active movement when set free from the cell, and even whilst inclosed within it. The pigment-cells are not always, however, of this simply rounded or polygonal form; they sometimes present remarkable stellate prolongations, under which form they are well seen in the skin of the frog (fig. 791, *c c*). The gradual formation of these prolongations may be traced in the pigment-cells of the tadpole during its metamorphosis (fig. 777). Similar varieties of form are to be met with in the pigmentary cells of fishes and small crustacea, which also present a great variety of hues; and these seem to take the colour of the bottom over which the animal may live, so as to serve the better for its concealment.

The structure of the epidermis may be examined in a variety of ways. If it be removed by maceration from the true skin, the cellular nature of its under surface is at once recognised, when it is subjected to a magnifying power of 200 or 300 diameters, by light transmitted through it, with this surface uppermost; and if the epidermis be that of a negro or any other dark-skinned race, the pigment cells will be very distinctly seen. This under-surface of the epidermis is not flat but is excavated into pits and channels for the reception of the papillary elevations of the true skin; an arrangement which is shown on a large scale in the thick cuticular covering of the dog's foot, the subjacent papillæ being large enough to be distinctly seen (when injected) with the naked eye. The cellular nature of the newly forming layers is best seen by examining a little of the soft film that is found upon the surface of the true skin, after the more consistent layers of the cuticle have been raised by a blister. The alteration which the cells of the external layers have undergone tends to obscure their character; but if any fragment of epidermis be macerated for a little time in a weak solution of soda or potass, its dry scales become softened, and are filled out by imbibition into rounded or polygonal cells. The same mode of treatment enables us to make out the cellular structure in warts and corns, which are epidermic growths from the surface of papillæ enlarged by hypertrophy.

The *epithelium* may be designated as a delicate cuticle, covering all the free *internal* surfaces of the body, and thus lining all its cavities, canals, &c. Save in the mouth and other parts in which it approximates to the ordinary cuticle, both in locality and in



FIG. 777. — Pigment-cells from tail of tadpole: *a a*, simple forms of recent origin; *b b*, more complex forms subsequently assumed.

nature, its cells (fig. 778) usually form but a single layer; and are so deficient in tenacity of mutual adhesion that they cannot be detached in the form of a continuous membrane. Their shape varies greatly. Sometimes they are broad, flat, and scale-like, and their edges approximate closely to each other, so as to form what is termed a 'pavement' or 'tessellated' epithelium: such cells are observable on the web of a frog's foot or on the tail of a tadpole; for, though covering an external surface, the soft moist cuticle of these parts has all the characters of an epithelium. In other cases the cells have more of the form of cylinders, standing erect side by side, one extremity of each cylinder forming part of the free surface, whilst the other rests upon the membrane to which it serves as a covering. If the cylinders be closely pressed together, their form is changed into prisms: and such epithelium is often known as 'prismatic.' On the other hand, if the surface on which it rests be convex, the bases or lower ends of the cylinders become smaller than

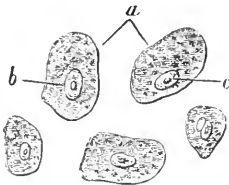

FIG. 778.—Detached epithelium-cells: *a*, with nuclei *b*, and nucleoli *c*, from mucous membrane of the mouth.

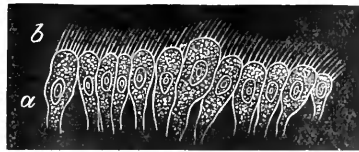

FIG. 779.—Ciliated epithelium: *a*, nucleated cells resting on their smaller extremities; *b*, cilia.

their free extremities; and thus each has the form of a truncated cone rather than of a cylinder, and such epithelium (of which that covering the *villi* of the intestine is a peculiarly good example) is termed 'conical.' But between these primary forms of epithelial cells there are several intermediate gradations; and one often passes almost insensibly into the other. Any of these forms of epithelium may be furnished with *cilia*; but these appendages are more commonly found attached to the elongated than to the flattened forms of epithelial cells (fig. 779). Ciliated epithelium is found upon the lining membrane of the air-passages in all air-breathing Vertebrata; and it also presents itself in many other situations, in which a propulsive power is needed to prevent an accumulation of mucous or other secretions. Owing to the very slight attachment that usually exists between the epithelium and the membranous surface whereon it lies, there is usually no difficulty whatever in examining it, nothing more being necessary than to scrape the surface of the membrane with a knife and to add a little water to what has been thus removed. The ciliary action will generally be found to persist for some hours or even days after death if the animal has been previously in full vigour; and the cells that bear the cilia, when detached from each other, will

swim freely about in water. If the thin fluid that is copiously discharged from the nose in the first stage of an ordinary 'cold in the head' be subjected to microscopic examination, it will commonly be found to contain a great number of ciliated epithelium-cells, which have been thrown off from the lining membrane of the nasal passages.

Fat.—One of the best examples which the bodies of higher animals afford, of a tissue composed of an aggregation of cells, is presented by fat, the cells of which are distinguished by their power of drawing into themselves oleaginous matter from the blood. Fat-cells are sometimes dispersed in the interspaces of areolar tissue; whilst in other cases they are aggregated in distinct masses, constituting the proper adipose substance. The individual fat-cells always present a nearly spherical or spheroidal form; sometimes, however, when they are closely pressed together, they become somewhat polyhedral, from the flattening of their walls against each other (fig. 780). Their intervals are traversed by a minute network of blood-vessels (fig. 795), from which they derive their secretion; and it is probably by the constant moistening of their walls with a *watery* fluid, that their contents are retained without the least transudation, although these are quite fluid at the temperature of the living body. Fat-cells, when filled with their characteristic contents, have the peculiar appearance which has been already described as appertaining to oil-globules, being very bright in their centre, and very dark towards their margin, in consequence of their high refractive power; but if, as often happens in preparations that have been long mounted, the oily contents should have escaped, they then look like any other cells of the same form. Although the fatty matter which fills these cells (consisting of a solution of stearine or margarine in oleine) is liquid at the ordinary temperature of the body of a warm-blooded animal, yet its harder portion sometimes crystallises on cooling, the crystals shooting from a centre, so as to form a star-shaped cluster. Osmic acid has been found by Dr. B. Solger to separate a more fluid central portion from a firmer peripheral part. In examining the structure of adipose tissue it is desirable, where practicable, to have recourse to some specimen in which the fat-cells lie in single layers, and in which they can be observed without disturbing or laying them open; such a condition is found, for example, in the mesentery of the mouse; and it is also occasionally met with in the fat-deposits which present themselves at intervals in the connective tissues of the muscles, joints, &c. Small collections of fat-cells exist in the deeper layers of the true skin, and are brought into view by vertical sections of it (fig. 775. *f*). And the structure of large masses of fat may be examined by thin sections, these being placed under water

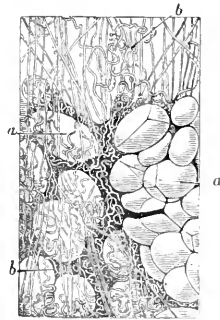

FIG. 780.—Areolar and adipose tissue: *a a*, fat-cells; *b b*, fibres of areolar tissue.

in thin cells, so as to take off the pressure of the glass cover from their surface, which would cause the escape of the oil-particles. No method of mounting (so far as the Author is aware) is successful in causing these cells permanently to retain their contents.

Cartilage.—In the ordinary forms of cartilage, also, we have an example of a tissue obviously composed of cells; but these are commonly separated from each other by an ‘intercellular substance,’ which is so closely adherent to the outer walls of the cells as not to be separable from them. The thickness of this substance differs greatly in different kinds of cartilage, and even in different stages of the growth of any one. Thus in the cartilage of the external ear of a bat or mouse (fig. 781), the cells are packed as closely together as are those of an ordinary

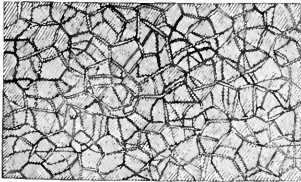

FIG. 781.—Cellular cartilage of mouse's ear.

vegetable parenchyma; and this seems to be the early condition of most cartilages that are afterwards to present a different aspect. In the ordinary cartilages, however, that cover the extremities of the bones, so as to form smooth surfaces for the working of the joints, the amount of intercellular substance is usually considerable; and the cartilage-cells are commonly found imbedded there in clusters of two, three, or four (fig. 782), which are evidently formed by a process of ‘binary subdivision.’ The substance of these

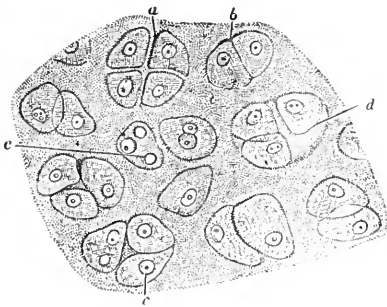

FIG. 782.—Section of the branchial cartilage of tadpole: *a*, group of four cells, separating from each other; *b*, pair of cells in apposition; *c c*, nuclei of cartilage-cells; *d*, cavity containing three cells (the fourth probably behind).

cellular cartilages is entirely destitute of blood-vessels, being nourished solely by imbibition from the blood brought to the membrane covering their surface. Hence they may be compared, in regard to their grade of organisation, with the larger alga, which consist, like them, of aggregations of cells held together by intercellular substance, without vessels of any kind, and are nourished by imbibition through their whole surface. There are many cases, however, in which the structureless intercellular substance is replaced

by bundles of fibres, sometimes elastic, but more commonly non-elastic; such combinations, which are termed *fibro-cartilages*, are interposed in certain joints, wherein tension as well as pressure has to be resisted; as, for example, between the vertebrae of the spinal column and the bones of the pelvis. In examining the structure of cartilage nothing more is necessary than to make very thin

sections, preferably with the microtome. These sections may be mounted in weak spirit, Goadby's solution, or glycerin-jelly; but in whatever way they are mounted, they undergo a gradual change by lapse of time, which renders them less fit to display the characteristic features of their structure.

Structure of the Glands.—The various secretions of the body (as saliva, bile, urine, &c.) are formed by the instrumentality of organs termed glands; which are, for the most part, constructed on one fundamental type, whatever be the nature of their product. The simplest idea of a gland is that which we gain from an examination of the 'follicles' or little bags imbedded in the wall of the stomach, some of which secrete mucus for the protection of its surface and other gastric juice. These little bags are filled with cells of a spheroidal form, which may be considered as constituting their epithelial lining; these cells, in the progress of their development, draw into themselves from the blood the constituents of the particular product they are to secrete; and they then seem to deliver it up, either by the bursting or by the melting away of their walls, so that this product may be poured forth from the mouth of the bag into the cavity in which it is wanted. The organ which is generally, though by no means accurately, called the liver presents this condition in the lowest animals wherein it is found. In many Polyzoa, compound Tunicata, and Annulata the cells of this organ can be seen to occupy follicles in the walls of the stomach; in insects these follicles are few in number, but are immensely elongated, so as to form tubes which lie loosely within the abdominal cavity, frequently making many convolutions within it, and discharge their contents into the commencement of the intestinal canal; whilst in the higher Mollusca, and in Crustacea, the follicles are vastly multiplied in number, and are connected with the ramifications of gland-ducts, like grapes upon the stalks of their bunch, so as to form a distinct mass which now becomes known as the liver. The examination of

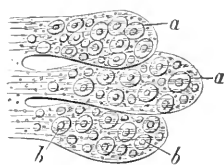

FIG. 783.—Ultimate follicles of mammary gland, with their secreting cells *a a*, containing nuclei *b b*.

the tubes of this organ in the insect, or of the follicles of the crab, which may be accomplished with the utmost facility, is well adapted to give an idea of the essential nature of glandular structure. Among vertebrated animals the salivary glands, the pancreas (sweetbreads), and the mammary glands are well adapted to display the follicular structure (fig. 783), nothing more being necessary than to make sections of these organs thin enough to be viewed as transparent objects. The kidneys of vertebrated animals are made up of elongated tubes, which are straight, and are lined with a pavement-epithelium in the inner or 'medullary' portion of the kidney, whilst they are convoluted and filled with a spheroidal epithelium in the outer or 'cortical.' Certain flask-shaped dilata-tions of these tubes include curious little knots of blood-vessels, which are known as the 'Malpighian bodies' of the kidney; these

are well displayed in injected preparations. For such a full and complete investigation of the structure of these organs as the anatomist and physiologist require, various methods must be put in practice which this is not the place to detail. It is perfectly easy to demonstrate the cellular nature of the substance of the liver by simply scraping a portion of its cut surface, since a number of its cells will then be detached. The general arrangement of the cells in the lobules may be displayed by means of sections thin enough to be transparent; whilst the arrangement of the blood-vessels can only be shown by means of injections. Fragments of the tubules of the kidney, sometimes having the Malpighian capsules in connection with them, may also be detached by scraping its cut surface; but the true relations of these parts can only be shown by thin transparent sections, and by injections of the blood-vessels and tubuli. The simple follicles contained in the walls of the stomach are brought into view by vertical sections; but they may be still better examined by leaving small portions of the lining membrane for a few days in dilute nitric acid (one part to four of water), whereby the fibrous tissue will be so softened that the clusters of glandular epithelium lining the follicles (which are but very little altered) will be readily separated.

Muscular Tissue.—Although we are accustomed to speak of this tissue as consisting of ‘fibres,’ yet the ultimate structure of the ‘muscular fibre’ is very different from that of the ‘simple fibrous tissues’ already described. When we examine an ordinary muscle (or piece of ‘flesh’) with the naked eye, we observe that it

is made up of a number of *fasciculi* or bundles of fibres (fig. 784), which are arranged side by side with great regularity, in the direction in which the muscle is to act, and are united by connective tissue. These fasciculi may be separated into smaller parts, which appear like simple fibres; but when these are examined by the microscope, they are found to be themselves fasciculi, composed of minuter fibres bound together by delicate filaments of connective tissue. By carefully separating these we may obtain the ultimate muscular fibre. This fibre exists under two forms, the *striated* and the *non striated*. The former is chiefly distinguished by the transversely striated appearance which it presents (fig. 785), and which is due to an alternation of light and dark spaces along its whole extent; the breadth and distance of these striae vary, however, in different fibres,



FIG. 784. — Fasciculus of striated muscular fibre, showing at *a* the transverse striae, and at *b* its junction with the tendon.

and even in different parts of the same fibre, according to their state of contraction or relaxation. Longitudinal striae are also frequently visible, which are due to a partial separation between the component fibrille into which the fibre may be broken up. When a fibre of this kind is more closely examined, it is seen to be inclosed within a delicate tubular sheath, which is quite distinct on

the one hand from the connective tissue that binds the fibres into fasciculi, and equally distinct from the internal substance of the fibre. This membranous tube, which is termed the *sarcolemma*, is not perforated by capillary vessels, which therefore lie *outside* the ultimate elements of the muscular substance; whether it is penetrated by the ultimate fibres of nerves is a point not yet certainly ascertained. The diameter of the fibres varies greatly in different kinds of vertebrated animals. Its average is greater in reptiles and fishes than in birds and mammals, and its extremes also are wider; thus its dimensions vary in the frog from $\frac{1}{1000}$ th to $\frac{1}{1000}$ th of an inch, and in the skate from $\frac{1}{65}$ th to $\frac{1}{300}$ th; whilst in the human subject the average is about $\frac{1}{400}$ th of an inch, and the extremes about $\frac{1}{200}$ th and $\frac{1}{600}$ th.

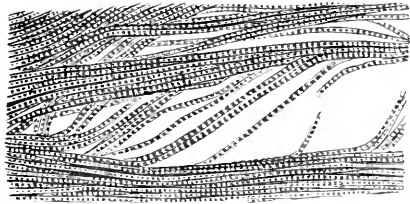

FIG. 785.—Striated muscular fibre, separating into fibrillae.

The substance of the fibre, when broken up by 'teasing' with needles, is found to consist of very minute fibrillae, which, when examined under a magnifying power of from 250 to 400 diameters, are seen to present a slightly beaded form, and to show the same alternation of light and dark spaces as when the fibrillae are united into fibres or into small bundles (fig. 785). The dark and light spaces are usually of nearly equal length; each light space is divided by a transverse line, called 'Dobie's line,' while each dark space is crossed by a lighter band, known as 'Hensen's stripe.' It has been generally supposed that these markings indicate differences in the *composition* of the fibre; but Professor J. B. Hayercraft has revived an idea, which originated with Mr. Bowman, that they are the optical expressions of its *shape*. The borders of the striated fibre (he truly states) present wavy margins, indicative of a transverse ridging and furrowing, the whole fibre (or a single fibril) thus consisting of a succession of convex bead-like projections with intermediate concave depressions. When the *axis* of the fibre is in true focus, Dobie's line, D (fig. 786), crosses the deepest part of the concavity, while Hensen's stripe, H, crosses the most projecting part of the convexity, and it can be shown, both theoretically and experimentally, that this alternation of lights and shades will be produced by the passage of light through a similarly shaped homogeneous rod of any transparent substance. If, on the

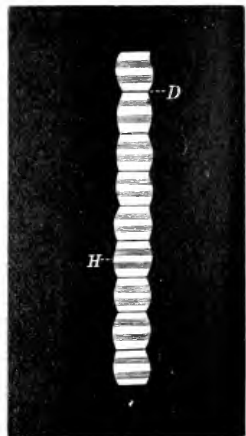

FIG. 786.—Diagram of striated fibrilla.

other hand, the *surface* of the fibre be brought into focus, the convex ribbings appear light and intervening depressions dark, which is the aspect originally represented by Bowman. The appearances are the same in the extended and contracted states of the fibre; with the exception that the alternation of light and dark striæ is closer in the contracted state, while the breadth (representing the thickness) of the fibre is correspondingly increased.¹ It is well none the less in the present state of our knowledge to refrain from conclusions as to the absolute structure of the striated fibrillæ. It ranges itself, from the modern microscopist's point of view, with other striated objects, and will require the possession of lenses of a N.A. twice or thrice that of those which are now within our reach. There is no immediate prospect of these, it is true; but they cannot be considered impossible by the student of the past history of microscopy.

In the examination of muscular tissue a small portion may be cut out with the curved scissors; this should be torn up into its component fibres; and these, if possible, should be separated into their fibrillæ by dissection with a pair of needles under the simple microscope. The general characters of the *striated* fibre are admirably shown in the large fibres of the frog; and by selecting a portion in which these fibres spread themselves out to unite with a broad tendinous expansion, they may often be found so well displayed in a single layer as not only to exhibit all their characters without any dissection, but also to show their mode of connection with the 'simple fibrous' tissue of which that expansion is formed. As the ordinary characters of the fibre are but little altered by boiling, recourse may be had to this process for their more ready separation, especially in the case of the tongue. Dr. Beale recommends glycerin for the preparation, and glycerin media for the preservation, of objects of this class; and states that the alternation of light and dark spaces in the fibrillæ is rendered more distinct by such treatment. The fibrillæ are often more readily separable when the muscle has been macerated in a weak solution of chromic acid. The shape of the fibres can only be properly seen in cross-sections; and these are best made by the freezing microtome. Striated fibres, separable with great facility into their component fibrillæ, are readily obtainable from the limbs of crustacea and of insects; and their presence is also readily distinguishable in the bodies of worms, even of very low organisation; so that it may be regarded as characteristic of the articulated series generally. On the other hand, the molluscous classes are, for the most part, distinguished by the non-striation of their fibre; there are, however, some exceptions, such as the muscles of the odontophore in the snail and the powerful adductor muscle of *Pecten*. Its presence seems related to energy and rapidity of movement, the non-striated presenting itself where the movements are slower and feebler in their character.

The 'smooth' or *non-striated* form of muscular fibre, which is

¹ *Quart. Journ. Microsc. Sci.* n.s. xxi. p. 307. More recent views will be found in Mr. C. F. Marshall's paper in vol. xxviii. of the same journal, and in the memoirs cited by him. The subject is one which will doubtless long occupy the attention of the histologist.

especially found in the walls of the stomach, intestines, bladder, and other similar parts, is composed of flattened bands whose diameter is usually between $\frac{1}{2000}$ th and $\frac{1}{3000}$ th of an inch ; and these bands are collected into fasciuli, which do not lie parallel with each other, but cross and interlace. By macerating a portion of such muscular substance, however, in dilute nitric acid (about one part of ordinary acid to three parts of water) for two or three days, it is found that the bands just mentioned may be easily separated into elongated fusiform cells, not unlike 'woody fibre' in shape (fig. 787, *a a*) ; each distinguished, for the most part, by the presence of a long staff-shaped nucleus, *b*, brought into view by the action of acetic acid. *c*. These cells, in which the distinction between cell-wall and cell-contents can by no means be clearly seen, are composed of a soft yellow substance often containing small pale granules, and sometimes yellow globules of fatty matter. In the coats of the blood-vessels are found

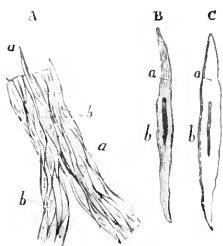

FIG. 787.—Structure of non-striated muscular fibre: A, portion of tissue showing fusiform cells *a a*, with elongated nuclei *b b*; B, a single cell isolated and more highly magnified; C, a similar cell treated with acetic acid.



FIG. 788.—Ganglion-cells and nerve-fibres from a ganglion of lamprey.

cells having the same general characters, but shorter and wider in form ; and although some of these approach very closely in their general appearance to epithelium-cells, yet they seem to have quite a different nature, being distinguished by their elongated nuclei, as well as by their contractile endowments.

Nerve-substance.—Wherever a distinct nervous system can be made out, it is found to consist of two very different forms of tissue, namely, the *cellular*, which are the essential components of the ganglionic centres, and the *fibrous*, of which the connecting trunks consist. The typical form of the nerve-cells or 'ganglion-globules' may be regarded as globular ; but they often present an extension into one or more long processes, which give them a 'caudate' or 'stellate' aspect. These processes have been traced into continuity, in some instances, with the axis-cylinders of nerve-tubes (fig. 788) ; whilst in other cases they seem to imosculate with those of other

vesicles. The cells, which do not seem to possess a definite cell-wall, are, for the most part, composed of a finely granular substance, which extends into their prolongations; and in the midst of this is usually to be seen a large well-defined nucleus. They also generally contain pigment-granules, which give them a reddish or yellowish-brown colour, and thus impart to collections of ganglionic cells in the warm-blooded Vertebrata that peculiar hue which causes them to be known as the *cineritious* or *grey* matter, but which is commonly absent among the lower animals. Each of the tubular nerve-fibres, on the other hand, of which the trunks are made up, consists, in its fully developed form, of a delicate membranous sheath, within which is a hollow cylinder of a material known as the 'white substance of Schwann,' whose outer and inner boundaries are marked out by two distinct lines, giving to each margin of the nerve-tube what is described as a 'double contour.' The contents of the membranous envelope are very soft, yielding to slight pressure; and they are so quickly altered by the contact of water or of any liquids which are foreign to their nature that their characters can only be properly

judged of when they are quite fresh. The centre or axis of the tube is then found to be occupied by a transparent substance which is known as the 'axis cylinder;' and there is reason to believe that this last, which is a protoplasmic substance, is the *essential* component of the nerve-fibre, while the function of the hollow cylinder that surrounds it, which is composed of a combination of fat and albuminous matter, is simply protective. The diameter of the nerve-tubes differs in different nerves, being sometimes as great as $\frac{1}{1500}$ th of an inch, and as small in other instances as $\frac{1}{12000}$ th. In many of the lower invertebrata, such as *Medusa* and *Camatule*, we seem fully justified by physiological evidence in regarding as nerves certain protoplasmic

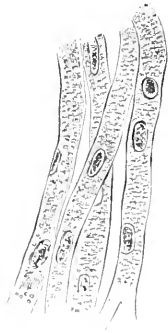

FIG. 789.—Gelatinous nerve-fibres, from olfactory nerve.

fibres which do not possess the characteristic structure of 'nerve-tubes,' and fibres destitute of the 'double contour' are found also in certain parts of the body of even the highest vertebrates. These fibres, which are known as 'gelatinous,' are considerably smaller than the preceding, and do not exhibit any differentiation of parts (fig. 789). They are flattened, soft, and homogeneous in their appearance, and contain numerous nuclear particles which are brought into view by acetic acid. They can sometimes be seen to be continuous with the axis-cylinders of the ordinary fibres, and also with the radiating prolongations of the ganglion-cells; so that their nervous character, which has been questioned by some anatomists, seems established beyond doubt.

The ultimate distribution of the nerve-fibres is a subject on which there has been great divergence of opinion, and one which can only be successfully investigated by observers of great experience.

The Author believes that it may be stated as a general fact, that in both the motor and the sensory nerve-tubes, as they approach their terminations in the muscles and in the skin respectively, the protoplasmic axis-cylinder is continued beyond its envelopes, often then breaking up into very minute fibrillæ, which inosculate with each other, so as to form a network closely resembling that formed by the pseudopodial threads of Rhizopods. Recent observers have described the fibrillæ of motor nerves as terminating in 'motorial end-plates' seated upon or in the muscular fibres; and these seem analogous to the little 'islets' of sarcodic substance into which those threads often dilate. Where the skin is specially endowed with tactile sensibility we find a special *papillary apparatus*, which in the skin may be readily made out in thin vertical sections treated with solution of soda (fig. 790). It was formerly supposed that all the cutaneous papillæ are furnished with nerve-fibres, and minister to sensation; but it is now known that a large proportion (at any rate) of those that are furnished with loops of blood-vessels (figs. 775, p. 798), being destitute of nerve-fibres, must have for their special office the production of epidermis; whilst those which, possessing nerve-fibres, have sensory functions, are usually destitute of blood-vessels. The greater part of the interior of each sensory papilla (fig. 790, *c c*) of the skin is occupied by a peculiar 'axile body,' which seems to be merely a bundle of ordinary connective tissue, whereon the nerve-fibre appears to terminate. The nerve-fibres are more readily seen, however, in the 'fungiform' papillæ of the tongue, to each of which several of them proceed; these bodies, which are very transparent, may be well seen by snipping off minute portions of the tongue of the frog; or by snipping off the papillæ themselves from the surface of the living human tongue, which can be readily done by a dexterous use of the curved scissors, with no more pain than the prick of a pin would give. The transparency of these papillæ also is increased by treating them with a weak solution of soda. Nerve-fibres have also been found to terminate on sensory surfaces in minute 'end-bulbs' of spheroidal shape and about $\frac{1}{600}$ th of an inch in diameter, each of them being composed of a simple outer capsule of connective tissue, filled with clear soft matter, in the midst of which the nerve-fibre, after losing its dark border, ends in a knob. The 'Pacinian corpuscles,' which are best seen in the mesentery of the cat, and are from $\frac{1}{15}$ th to $\frac{1}{10}$ th of

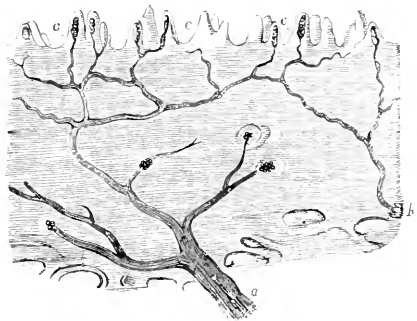

FIG. 790.—Vertical section of skin of finger, showing the branches of the cutaneous nerves, *a*, *b*, inosculating to form a plexus, of which the ultimate fibres pass into the cutaneous papillæ, *c c*.

an inch long, seem to be more developed forms of these 'end-bulbs.'

For the sake of obtaining a general acquaintance with the microscopic characters of these principal forms of nerve-substance, it is best to have recourse to minute nerves and ganglia. The small nerves which are found between the skin and the muscles of the back of the frog, and which become apparent when the former is being stripped off, are extremely suitable for this purpose; but they are best seen in the *Hyla* or 'tree-frog,' which is recommended by Dr. Beale as being much superior to the common frog for the general purposes of minute histological investigation. If it be wished to examine the natural appearance of the nerve-fibres, no other fluid should be used than a little blood-serum; but if they be treated with strong acetic acid, a contraction of their tubes takes place, by which the axis-cylinders are forced out from their cut extremities, so as to be made more apparent than they can be in any other way. On the other hand, by immersion of the tissue in a dilute solution of chromic acid (about one part of the solid crystals to two hundred of water), the nerve-fibres are rendered firmer and more distinct. Again, the axis-cylinders are brought into distinct view by the staining process, being dyed much more quickly than their envelopes; and they may thus be readily made out by reflected light in transverse sections of nerves that have been thus treated. The *gelatinous* fibres are found in the greatest abundance in the sympathetic nerves; and their characters may be best studied in the smaller branches of that system. So for the examination of the ganglionic cells, and of their relation to the nerve-tubes, it is better to take some minute ganglion as a whole (such as one of the sympathetic ganglia of the frog, mouse, or other small animal) than to dissect the larger ganglionic masses, whose structure can only be successfully studied by such as are proficient in this kind of investigation. The nerves of the orbit of the eyes of fishes, with the ophthalmic ganglion and its branches, which may be very readily got at in the skate, and of which the components may be separated without much difficulty, form one of the most convenient objects for the demonstration of the principal forms of nerve-tissue, and especially for the connection of nerve-fibres and ganglion-cells. For minute inquiries, however, into the ultimate distribution of the nerve-fibres in muscles and sense-organs, certain special methods must be followed, and very high magnifying powers must be employed. Those who desire to follow out this inquiry should acquaint themselves with the methods which have been found most successful in the hands of the able histologists who have devoted themselves to it.¹

Circulation of the Blood.—One of the most interesting spectacles that the microscopist can enjoy is that which is furnished by the

¹ For further information regarding the nervous system the memoir of F. Nansen on 'The Structure and Combination of the Histological Elements of the Central Nervous System' in Bergen's *Museum Aarsberetning* for 1886 (1887), p. 29, should be consulted. An excellent summary of the more valuable modern methods of staining nerve-fibres and cells was given in 1892 to the Royal Microscopical Society by Dr. C. E. Beevor. See their *Journal*, 1892, p. 897.

circulation of the blood in the *capillary* blood-vessels which distribute the fluid through the tissues it nourishes. This, of course, can only be observed in such parts of animal bodies as are sufficiently thin and transparent to allow of the transmission of light through them, without any disturbance of their ordinary structure; and the number of these is very limited. The web of the frog's foot is perhaps the most suitable for ordinary purposes, more especially since this animal is to be easily obtained in almost every locality; and the following is the simple arrangement preferred by the Author: A piece of thin cork is to be obtained, about nine inches long and three inches wide (such pieces are prepared by cork-cutters, as soles), and a hole about $\frac{3}{8}$ ths of an inch in diameter is to be cut at about the middle of its length, in such a position that, when the cork is secured upon the stage, this aperture may correspond with the axis of the microscope. The body of the frog is then to be folded in a piece of wet calico, one leg being left free, in such a manner as to confine its movements, but not to press too tightly upon its body; and being then laid down near one end of the cork-plate, the free leg is to be extended, so that the foot can be laid over the central aperture. The spreading out of the foot over the aperture is to be accomplished either by passing pins through the edge of the web into the cork beneath, or by tying the ends of the toes with threads to pins stuck into the cork at a small distance from the aperture; the former method is by far the least troublesome, and it may be doubted whether it is really the source of more suffering to the animal than the latter, the confinement being obviously that which is most felt. A few turns of tape, carried *loosely* around the calico bag, the projecting leg, and the cork, serve to prevent any sudden start; and when all is secure, the cork-plate is to be laid down upon the stage of the microscope, where a few more turns of the tape will serve to keep it in place. The web being moistened with water (a precaution which should be repeated as often as the membrane exhibits the least appearance of dryness) and an adequate light being reflected through the web from the mirror, this wonderful spectacle is brought into view on the adjustment of the focus (a power of from 75 to 100 diameters being the most suitable for ordinary purposes), provided that no obstacle to the movement of the blood be produced by undue pressure upon the body or leg of the animal. It will not unfrequently be found, however, that the current of blood is nearly or altogether stagnant for a time; this seems occasionally due to the animal's alarm at its new position, which weakens or suspends the action of its heart, the movement recommencing again after the lapse of a few minutes, although no change has been made in any of the external conditions. But if the movement should not renew itself, the tape which passes over the body should be slackened; and if this does not produce the desired effect, the calico envelope also must be loosened. When everything has once been properly adjusted, the animal will often lie for hours without moving, or will only give an occasional twitch; and even this may be avoided by previously subjecting it to the influence of ether or chloroform, which may be renewed from time to time whilst it is under observation.

The movement of the blood will be distinctly seen by that of its corpuscles (fig. 791), which course after one another through the network of capillaries that intervenes between the smallest arteries and the smallest veins; in those tubes which pass most directly from the veins to the arteries the current is always in the same direction; but in those which pass across between these it may not unfrequently be seen that the direction of the movement changes from time to time. The larger vessels with which the capillaries are seen to be connected are almost always *veins*, as may be known from the direction of the flow of blood in them from the branches (*b b*) towards their trunks (*a*); the *arteries*, whose ultimate subdivisions discharge themselves into the capillary network, are for the most part restricted to the immediate borders of the toes. When a power of 200 or 250 diameters is employed, the visible area is of course greatly reduced; but the individual vessels and their contents

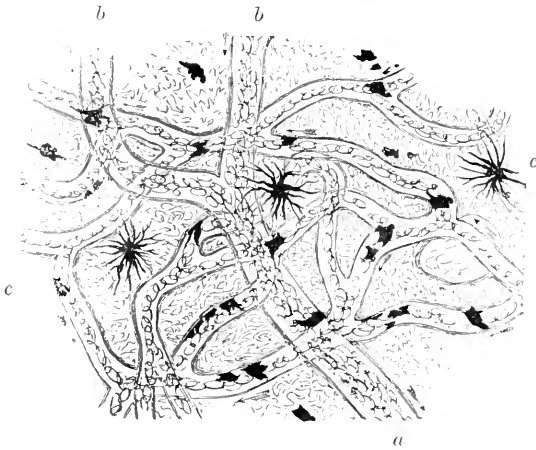

FIG. 791. —Capillary circulation in a portion of the web of a frog's foot: *a*, trunk of vein; *b*, *b*, its branches; *c*, *c*, pigment-cells.

are much more plainly seen: and it may then be observed that whilst the 'red' corpuscles flow at a very rapid rate along the centre of each tube, the 'white' corpuscles, which are occasionally discernible, move slowly in the clear stream near its margin.

The circulation may also be displayed in the *tongue* of the frog by laying the animal (previously chloroformed) on its back, with its head close to the hole in the cork-plate, and, after securing the body in this position, drawing out the tongue with the forceps and fixing it on the other side of the hole with pins. So, again, the circulation may be examined in the *lungs*—where it affords a spectacle of singular beauty—or in the *mesentery* of the living frog by laying open its body and drawing forth either organ, the animal having previously been made insensible by chloroform. The *tadpole* of the frog, when sufficiently young, furnishes a good display of the capillary circulation in its tail: and the difficulty of keeping it quiet during

the observation may be overcome by gradually mixing some warm water with that in which it is swimming until it becomes motionless; this usually happens when it has been raised to a temperature of between 100° and 110° Fabr.; and, notwithstanding that the muscles of the body are thrown into a state of spasmodic rigidity by this treatment, the heart continues to pulsate, and the circulation is maintained.¹ The *larva of the water-nert*, when it can be obtained, furnishes a most beautiful display of the circulation, both in its external gills and in its delicate feet. It may be inclosed in a large aquatic box or in a shallow cell, gentle pressure being made upon its body, so as to confine its movements without stopping the heart's action. The circulation may also be seen in the tails of small fish, such as the *minnow* or the *stickleback*, by confining these animals in tubes, or in shallow cells, or in a large aquatic box; but although the extreme transparency of these parts adapts them well for this purpose in one respect, yet the comparative scantiness of their blood-vessels prevents them from being as suitable as the frog's web in another not less important particular. One of the most beautiful of all displays of the circulation, however, is that which may be seen upon the *yolk-bag* of young fish (such as the salmon or trout) soon after they have been hatched; and as it is their habit to remain almost entirely motionless at this stage of their existence, the observation can be made with the greatest facility by means of the zoöphyte-trough. The store of yolk which the yolk-bag supplies for the nutrition of the embryo not being exhausted in the fish (as it is in the bird) previously to the hatching of the egg, this bag hangs down from the belly of the little creature on its emersion, and continues to do so until its contents have been absorbed into the body, which does not take place for some little time afterwards. And the blood is distributed over it in copious streams, partly that it may draw into itself fresh nutritive material, and partly that it may be subjected to the aërating influence of the surrounding water.

The tadpole serves, moreover, for the display, under proper management, not only of the capillary, but of the *general* circulation; and if this be studied under the binocular microscope, the observer not only enjoys the gratification of witnessing a most wonderful spectacle, but may also obtain a more accurate notion of the relations of the different parts of the circulating system than is otherwise possible. The tadpole, as every naturalist is aware, is essentially a fish in the early period of its existence, breathing by gills alone, and having its circulating apparatus arranged accordingly; but as its limbs are developed, and its tail becomes relatively shortened, its lungs are gradually evolved in preparation for its terrestrial life, and the course of the blood is considerably changed. In the tadpole as it comes forth from the egg the gills are *external*, forming a pair of fringes hanging at the sides of the head (fig. 792. 1) and at the bases of these, concealed by opercula or gill-flaps

¹ A special form of live-box for the observation of living tadpoles &c., contrived by Prof. F. E. Schulze, is described and figured in the *Quart. Journ. Microsc. Sci.* n.s. vol. vii. 1867, p. 261.

resembling those of fishes, are seen the rudiments of the *internal* gills, which soon begin to be developed in the stead of the preceding.

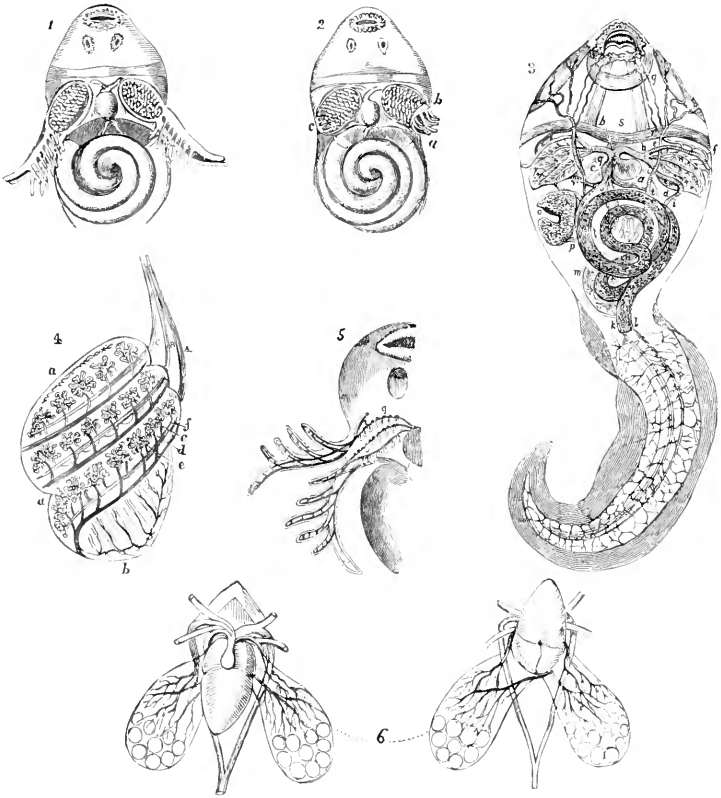

FIG. 792.—Circulation in the tadpole.

1. Anterior portion of young tadpole, showing the external gills, with the incipient tufts of the internal gills, and the pair of minute tubes between the heart and the spirally coiled intestine, which are the rudiments of the future lungs.

2. More advanced tadpole, in which the external gills have almost disappeared: *a*, remnant of external gills on the left side; *b*, operculum; *c*, remnant of external gill on the right side, turned in.

3. Advanced tadpole, showing the course of the general circulation: *a*, heart; *b*, branchial arteries; *c*, pericardium; *d*, internal gill; *e*, first or cephalic trunk; *f*, branch to lip; *g*, branches to head; *h*, second or branchial trunk; *i*, third trunk, uniting with its fellow to form the abdominal aorta, which is continued as the caudal artery, *k*, to the extremity of the tail; *l*, caudal vein; *m*, kidney; *n*, vena cava; *o*, liver; *p*, vena portæ; *q*, sinus venosus, receiving the jugular vein, *r*, and the abdominal veins, *t*, *u*, as also the branchial vein, *v*.

4. The branchial circulation on a larger scale: *A*, *B*, *C*, three primary branches of the branchial artery; *a*, cartilaginous arches; *b*, additional framework; *c*, *e*, twigs of branchial artery; *d*, *f*, rootlets of branchial vein.

5. Origin of the vessels of the internal gills, *g*, from the roots of those of the external.

6. The heart, systemic arteries, pulmonary arteries and veins, and lungs, in the adult frog, the heart being turned up in the right-hand figure, to show the junction of the pulmonary veins and their entrance into the left auricle.

The *external* gills reach their highest development on the fourth or fifth day after emersion; and they then wither so rapidly (whilst being at the same time drawn in by the growth of the animal) that by the end of the first week only a remnant of the right gill can be seen under the edge of the operculum (2, *c*), though the left gill (*b*) is somewhat later in its disappearance. Concurrently with this change the *internal* gills are undergoing rapid development; and the beautiful arrangement of their vascular tufts, which originate from the roots of the arteries of the external gills, as seen at *g*, 5, is shown in 4. It is requisite that the tadpole subjected to observation should not be so far advanced as to have lost its early transparency of skin; and it is further essential to the tracing out of the course of the abdominal vessels that the creature should have been kept without food for some days, so that the intestine may empty itself. This starving process reduces the quantity of red corpuscles, and thus renders the blood paler; but this, although it makes the smaller branches less obvious, brings the circulation in the larger trunks into more distinct view. 'Placing the tadpole on his back,' says Mr. Whitney, 'we look, as through a pane of glass, into the chamber of the chest. Before us is the beating heart, a bulbous-looking cavity, formed of the most delicate transparent tissues, through which are seen the globules of the blood, perpetually, but alternately, entering by one orifice and leaving it by another.' The heart (fig. 792, 3, *a*) appears to be slung, as it were, between two arms or branches, extending right and left. From these trunks (*b*) the main arteries arise. The heart is inclosed within an envelope or pericardium (*c*), which is, perhaps, the most delicate, and is, certainly, the most elegant structure in the creature's organism. Its extreme fineness makes it often elude the eye under the single microscope, but under the binocular its form is distinctly revealed. Then it is seen as a canopy or tent, inclosing the heart, but of such extreme tenuity that its *folds* are really the means by which its existence is recognised. Passing along the course of the great vessels to the right and left of the heart, the eye is arrested by a large oval body (*d*) of a more complicated structure and dazzling appearance. This is the internal gill, which in the tadpole is a cavity formed of most delicate transparent tissue, traversed by certain arteries, and lined by a crimson network of blood-vessels, the interlacing of which, with their rapid currents and dancing globules, forms one of the most beautiful and dazzling exhibitions of vascularity.' Of the three arterial trunks which arise on each side from the *truncus arteriosus*, *b*, the first, or *cephalic*, *e*, is distributed entirely to the head, running first along the upper edge of the gill, and giving off a branch, *f*, to the thick fringed lip which surrounds the mouth: after which it suddenly curves upwards and backwards, so as to reach the upper surface of the head, where it dips between the eye and the brain. The second main trunk, *h*, seems to be chiefly distributed to the gill, although it freely communicates by a network of vessels both with the first or cephalic and with the third or abdominal trunk. The latter also enters the gill and gives off branches; but it continues its course as a large trunk, bending downwards and curving towards

the spine, where it meets its fellow to form the *abdominal aorta*, *i*, which, after giving off branches to the abdominal viscera, is continued as the *caudal artery*, *k*, to the extremity of the tail. The blood is returned from the tail by the *caudal vein*, *l*, which is gradually increased in size by its successive tributaries as it passes towards the abdominal cavity; here it approaches the kidney, *m*, and sends off a branch which incloses that organ on one side, while the main trunk continues its course on the other, receiving tributaries from the kidney as it passes. The venous blood returned from the abdominal viscera, on the other hand, is collected into a trunk, *p*, known as the *portal vein*, which distributes it through the substance of the liver, *o*, as in man; and after traversing that organ it is discharged by numerous fine channels, which converge towards the great abdominal trunk, or *vena cava*, *n*, as it passes in close proximity to the liver, onwards to the *sinus venosus*, *q*, or rudimentary auricle of the heart. This also receives the *jugular vein*, *r*, from the head, which first, however, passes downwards in front of the gill close to its inner edge, and meets a vein *t*, coming up from the abdomen, after which it turns abruptly in the direction of the heart. Two other abdominal veins, *u*, meet and pour their blood direct into the sinus venosus; and into this cavity is also poured the aërated blood returned from the gill by the *branchial vein*, *v*, of which only the one on the right side can be distinguished. The lungs may be detected in a rudimentary state, even in the very young tadpole, being in that stage a pair of minute tubular sacs, united at the upper extremities, and lying behind the intestine and close to the spine. They may be best brought into view by immersing the tadpole for a few days in a weak solution of chromic acid, which renders the tissue friable, so that the parts that conceal them may be more readily peeled away. Their gradual enlargement may be traced during the period of the tadpole's transparence: but they can only be brought into view by dissection when the metamorphosis has been completed. The following are Mr. Whitney's directions for displaying the circulation in these organs: 'Put the young frog into a wineglass and drop on him a single drop of chloroform. This suffices to extinguish sensibility. Then lay him on the back on a piece of cork and fix him with small pins passed through the web of each foot. Remove the skin of the abdomen with a fine pair of sharp scissors and forceps. Turn aside the intestines from the *left* side, and thus expose the left lung, which may now be seen as a glistening transparent sac containing air-bubbles. With a fine camel-hair pencil the lung may now be turned out, so as to enable the operator to see a large part of it by *transmitted* light. Unpin the frog and place him on a slip of glass, and then transmit the light through the everted portion of lung. Remember that the lung is very elastic, and is emptied and collapsed by very slight pressure. Therefore, to succeed with this experiment, the lung should be touched as little as possible, and in the lightest manner, with the brush. If the heart is acting feebly you will see simply a transparent sac, shaped according to the quantity of air-bubbles it may happen to contain, but void of red vascularity and circulation. But

should the operator succeed in getting the lung well placed, full of air, and have the heart still beating vigorously, he will see before him a brilliant picture of crimson network, alive with the dance and dazzle of blood-globules, in rapid chase of one another through the delicate and living lace-work which lines the chamber of the lung.' The position of the lungs in relation to the heart and the great vascular trunks is shown in fig. 792, c.

Injected Preparations.—Next to the circulation of the blood in the living body, the varied distribution of the capillaries in its several organs, as shown by means of 'injections' of colouring matter thrown into their principal vessels, is one of the most interesting subjects of microscopic examination. The art of making successful preparations of this kind is one in which perfection can usually be attained only by long practice and by attention to a great number of minute particulars; and better specimens may be obtained, therefore, from those who have made it a business to produce them

than are likely to be prepared by amateurs for themselves. For this reason no account of the process will be here offered, the minute details which need to be attended to, in order to attain successful

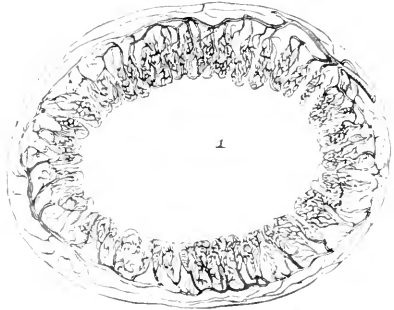

FIG. 793.—Transverse section of small intestine of rat, showing the villi *in situ*.

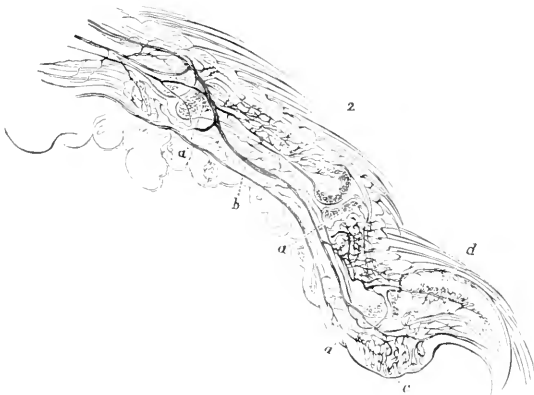

FIG. 794.—Section of the toe of a mouse: *a, a, a*, tarsal bones; *b*, digital artery; *c*, vascular loops in the papillae forming the thick epidermic cushion on the under surface; *d*, distribution of vessels in the matrix of the claw.

results, being readily accessible elsewhere to such as desire to put it in practice.¹

¹ See especially the article 'Injection' in the *Micrographic Dictionary*; M.

Many anatomical parts, when well injected and mounted, become objects of both interest and instruction. This is the case with the *villi of the intestine*, seen in fig. 793, which presents a transverse section, in which they are seen *in situ*. A thin section of the toe of a mouse (fig. 794) is another illustration of the effectiveness of this mode of preparation.

A relation may generally be traced between the disposition of the capillary vessels and the functions they subserve; but that relation is obviously, so to speak, of a mechanical kind, the arrange-

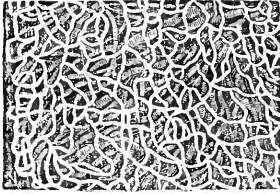

FIG. 795.—Capillary network around fat-cells.

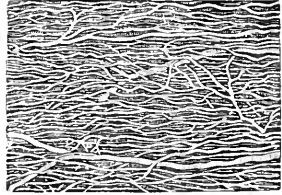

FIG. 796.—Capillary network of muscle.

ment of the vessels not in any way determining the function, but merely administering to it, like the arrangement of water or gas pipes in a manufactory. Thus, in fig. 795, we see that the capillaries of adipose substance are disposed in a network with rounded meshes, so as to distribute the blood among the fat-cells; whilst in fig. 796 we see the meshes enormously elongated, so as to permit the muscular fibres to lie in them. Again, in fig. 797, we observe the disposition of the capillaries around the orifices of the follicles

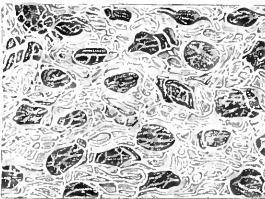

FIG. 797.—Distribution of capillaries in mucous membrane.

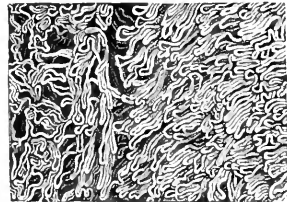

FIG. 798.—Distribution of capillaries in skin of finger.

of a mucous membrane; whilst in fig. 798 we see the looped arrangement which exists in the papillary surface of the skin, and which is subservient to the nutrition of the epidermis and to the activity of the sensory nerves.

In no part of the circulating apparatus, however, does the disposition of the capillaries present more points of interest than it does in the respiratory organs. In bony fishes the respiratory surface

Robin's work, *Du Microscope et des Injections*; Prof. H. Frey's treatise, *Das Mikroskop und die mikroskopische Technik*; Dr. Beale's *How to work with the Microscope*; the *Handbook to the Physiological Laboratory*; and Rutherford's and Schäfer's treatises on *Practical Histology*.

is formed by an outward extension into fringes of *gills*, each of which consists of an arch with straight laminae hanging down from it, and every one of these laminae (fig. 799) is furnished with a double row of leaflets, which is most minutely supplied with blood-vessels, their network (as seen at A) being so close that its meshes (indicated by the dots in the figure) cover less space than the vessels themselves. The gills of fish are not ciliated on their surface, like those of molluscs and of the larva of the water-newt, the necessity for such a mode of renewing the fluid in contact with them being superseded by the muscular apparatus with which their gill-chamber is furnished. But in batrachians and reptiles the respiratory surface is formed by the walls of an internal cavity, that of the *lungs*: these organs, however, are constructed on a plan very different from that which they present in higher Vertebrata, the great extension of surface which is effected in the latter by the minute subdivision of the cavity not being here necessary. In the frog (for example) the cavity of each lung is undivided; its walls, which are thin and membranous at the lower part, there present a simple smooth expanse; and it is only at the upper part, where the extensions of the tracheal cartilage form a network over the interior, that its surface is depressed into sacculi whose lining is crowded with blood-vessels (fig. 800). In this manner a set of air-cells is formed in the thickness of the upper wall of the lung, which communicate with the general cavity, and very much increase the surface over which the blood comes into relation with the air; but each air-cell has a capillary network of its own, which lies on one side against its wall, so as only to be exposed to the air on its free surface. In the elongated lung of the snake the same

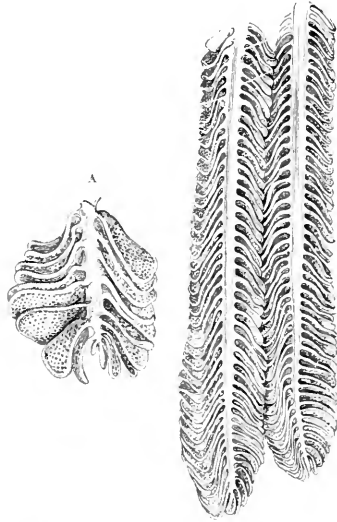

FIG. 799.—Two branchial processes of the gill of the eel, showing the branchial lamella: A, portion of one of these processes enlarged, showing the capillary network of the lamellæ.

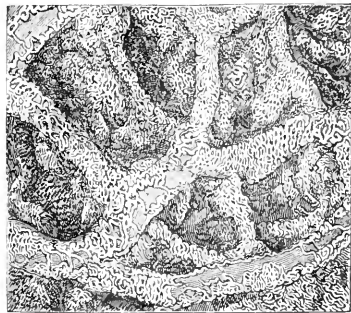

FIG. 800.—Interior of upper part of lung of frog.

general arrangement prevails; but the cartilaginous reticulation of its upper part projects much farther into the cavity, and incloses in its meshes (which are usually square, or nearly so) several layers of air-cells, which communicate, one through another, with the general cavity. The structure of the lungs of birds presents us with an arrangement of a very different kind, the purpose of which is to expose a very large amount of capillary surface to the influence of the air. The entire mass of each lung may be considered as subdivided into an immense number of 'lobules' or 'lunglets' (fig. 801, B), each of

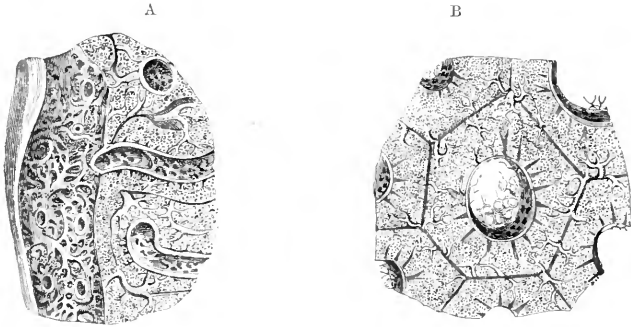

FIG. 801.—Interior structure of lung of fowl, as displayed by a section, A passing in the direction of a bronchial tube, and by another section B cutting it across.

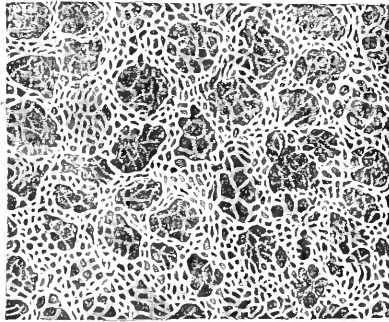

FIG. 802.—Arrangement of the capillaries on the walls of the air-cells of the human lung.

which has its own bronchial tube (or subdivision of the windpipe) and its own system of blood-vessels, which have very little communication with those of other lobules. Each lobule has a central cavity, which closely resembles that of a frog's lung in miniature, having its walls strengthened by a network of cartilage derived from the bronchial tube, A, in the interspaces of which are openings leading to sacculi in their substance. But each of these cavities is surrounded by a solid plexus of blood-vessels, which does not seem to be covered by any limiting membrane, but which admits air from the

central cavity freely between its meshes ; and thus its capillaries are in immediate relation with air on all sides—a provision that is obviously very favourable to the complete and rapid aëration of the blood they contain.¹ In the lung of man and mammals, again, the plan of structure differs from the foregoing, though the general effect of it is the same. For its whole interior is divided up into minute air-cells, which freely communicate with each other, and with the ultimate ramifications of the air-tubes into which the trachea subdivides ; and the network of blood-vessels (fig. 802) is so disposed in the partitions between these cavities that the blood is exposed to the air on both sides. It has been calculated that the number of these air-cells grouped around the termination of each air-tube in man is not less than eighteen thousand, and that the total number in the entire lung is *six hundred millions*.

¹ On the respiratory organs of birds, see Campana, *La Respiration des Oiseaux*, Paris, 1875.

CHAPTER XXIII

APPLICATION OF THE MICROSCOPE TO GEOLOGICAL INVESTIGATION

THE utility of the microscope is by no means limited to the determination of the structure and actions of the organised beings at present living on the surface of the earth; for a vast amount of information is afforded by its means to the geological inquirer, not only with regard to the essential nature and composition of the rock-masses of which its crust is composed, but also with regard to the minute characters of the many vegetable and animal remains that are intombed therein.

The systematic employment of the instrument in petrographical research dates from 1858, when Dr. H. C. Sorby, F.R.S., published his classical paper 'On the Microscopical Structure of Crystals, indicating the Origin of Minerals and Rocks.'¹ The observations in this paper were based upon the microscopical examination of thin sections of rocks and minerals; still, although Dr. Sorby was the first to apply this manner of investigation to such objects, the first to suggest and arrange the method of preparing thin sections appears to have been William Nicol. A description of his method is given by H. Witham (1831).² Previous to 1858 only those minerals could be examined microscopically which possessed the necessary degree of transparency, whilst rocks were largely closed secrets. Nevertheless Cordier (in 1815) was able to determine the constituent minerals of many rocks by the study of the powder under the microscope: a procedure which Fleurian de Bellevue had previously recommended in 1800, and which is still found valuable for certain purposes. Seven years before Dr. Sorby's paper appeared, the German scholar Oschatz exhibited a series of thin sections of minerals and rocks and drew attention to their important bearing upon structural studies, but the collection was regarded more as a curiosity than as a scientific achievement.³

That paper, however, gave an enormous impetus to geological research, and this, in the hands of English and German students, led to the growth of a 'micro-petrology.'

In order to examine minerals and rocks, sections must be prepared thin enough to permit of the use of transmitted light; for

¹ *Quart. Journ. Geol. Soc.* vol. xiv. 1858, pp. 453-500.

² *Observations on Fossil Vegetables*, Edinburgh and London, 1831.

³ The history of the application of the microscope to geology has been sketched by F. Zirkel in his paper *Die Einführung des Mikroskops in das mineralogisch-geologische Studium*, Leipzig, 1881.

this purpose they should be from about $\frac{1}{100}$ th to $\frac{1}{1000}$ th of an inch thick.

A chip about an inch square is struck or cut off the specimen to be studied. One surface of this is then ground down on a flat cast-iron plate with emery and water. This grinding may be done either by hand or by means of a machine specially constructed for this purpose (Chap. VII).¹ The former method will be described here. When a smooth surface is at last obtained the specimen is well washed with water and then polished upon a slab of plate glass with the finest flour emery and water. When all inequalities are thus removed the fragment is again well cleansed from all adhering emery.

The next process is to cement it with Canada balsam upon a slab of glass about two inches square and about an eighth of an inch in thickness. The Canada balsam is first heated over a spirit lamp in an iron spoon, care being taken not to allow it to burn. This is the most difficult part of the whole process, and only experience can teach how long the balsam must be heated in order to possess, on cooling, the necessary hardness. If it be heated too long it will crack upon cooling. The right point appears to be that in which large air-bubbles force themselves through the viscous mass.

A small quantity of the warm balsam is poured upon the slab of glass, and the smooth surface of the rock-fragment, being pressed into the balsam, is held down upon the glass till the balsam hardens. The slab is then examined from its under side to see that no air-bubbles have been included between the glass and the stone. Should they be present in any quantity, the whole process must be repeated. When the balsam has quite hardened, the other side of the fragment is ground down with coarse emery and water on the iron plate. Upon the section commencing to become transparent, the grinding with the coarse emery must cease. The stone is then thoroughly cleansed with water, and the final grinding is conducted upon the plate-glass slab with flour emery and water.

The slide is then placed under a stream of water in order to remove all traces of the emery powder from the minute pores of the rock. This is now the time to employ chemical tests to the component minerals, if such a course be deemed advisable. If the rock is of a fragile nature, it is well to mount the section as it is; but in most cases it is possible by delicate manipulation to remove it to a mounting more suited to optical work. This transference is effected

¹ F. G. Cottell (61 Camden Road, N.W.), T. Riley (18 Barnfoot Avenue, Fulham, S.W.), and J. Rhodes, Museum of Geology, Jernyn Street, S.W., prepare good sections; and the principal petrological opticians can generally recommend efficient operators. Voigt and Hochgesang (Göttingen, Rothe Str. 13) and R. Fuess (Berlin, S.W., 108 Alte Jacob Str.) do also most excellent work. German craftsmen are more skilful in overcoming difficulties (*e.g.* with soft rocks) than English, and can make thinner slices. Hence, it is better to send specimens to Germany when thinness is desired; but when the size of the slice is important, to have the work done in England. In a very thin slice the colour phenomena are less conspicuous, so that reduction in thickness beyond a certain limit is not all gain; but in rocks of an opaque character, or in the study of very minute structures, it is hardly possible to err on the side of thinness, and slices 'made in Germany' are much the better. If a student is purchasing ready-made specimens from a dealer, he will find the following rough test useful. Look through the slice at a window with a clear sky beyond; it is too thick when the bar cannot be distinctly seen.

by the application of a gentle heat to the slab until the balsam becomes liquefied, when the section can be pushed with a piece of wire on to a suitable slide of glass. Obviously a drop of balsam should be poured upon the latter before the section is transferred. The slide is then warmed until the balsam becomes liquid, when the superfluous quantity is drawn over the upper surface of the section. When the section is completely covered with the balsam, a thin clean cover-glass is held for a moment over the spirit flame and laid upon the section. Gentle pressure is then applied to the surface to bring it close down to the section and to remove all air-bubbles. The slide is then allowed to become quite hard, when it may be cleansed with turpentine or alcohol and ether.

Very porous rocks must first be treated with Canada balsam, in order to give them the consistency necessary for the preparation of thin sections. Isolated mineral grains and sands can be mounted by means of Canada balsam dissolved in chloroform. The slide must not be heated, but evaporation allowed to take place. Another method is described by Thoulet;¹ whilst very soft or decomposed rocks should be mounted according to Wichmann's proposal.²

In the application of the microscope to petrological and mineralogical research the employment of polarised light is constantly required, and various means and appliances are needful for its most advantageous application, which are not required by the ordinary microscopist. Considerable pains have been bestowed by both English and Continental makers to fulfil the requirements, and good instruments are now plentiful.³

An instrument designed by Mr. Allan Dick has been brought out by Messrs. J. Swift and Son. As this combines all that experience has led petrologists to consider desirable for mineralogical and petrological investigation, a brief account of it is subjoined. It is specially adapted to the study of the optical properties of minerals generally, and particularly to that of the thin plates of minerals seen in ordinary sections of rocks prepared for microscopical examination. The microscope is shown in fig. 803, but since the engraving was made one or two improvements as to matters of detail have been introduced.⁴

The eyepiece tube is slotted at E to receive the micrometer scale (shown detached at F), and to the tube is hinged the analyser B', which is capable of independent rotation in the usual manner. Upon the eyepiece tube is mounted a toothed wheel, which gears into another toothed wheel mounted on one end of a rod formed of pinion wire. The stage, in the newest forms, is fitted with a scale of rectangular divisions inserted to act as a finder, and with a roller object-clip (patented by the makers) in place of the usual sliding bar. Below the stage, which has neither sliding nor rotatory movements,

¹ *Annales de Chimie et de Physique* (5), xx. pp. 362-432.

² Tschermak's *Mineralogische und Petrogr. Mitt.* Bd. v. 1882, p. 33.

³ Mr. J. Swift, of Tottenham Court Road, Mr. Watson, of Holborn, London, and Messrs. Henry Crouch, Limited, make suitable instruments. Those constructed by Zeiss, of Jena; Nachet, of Paris; Voigt and Hochgesang, of Göttingen; Puess, of Berlin; and Hartnack, of Potsdam, can also be recommended.

⁴ The instrument is protected by letters patent.

is mounted the polariser, B, capable of independent rotation like the analyser, and upon the tube of the polariser is mounted a toothed

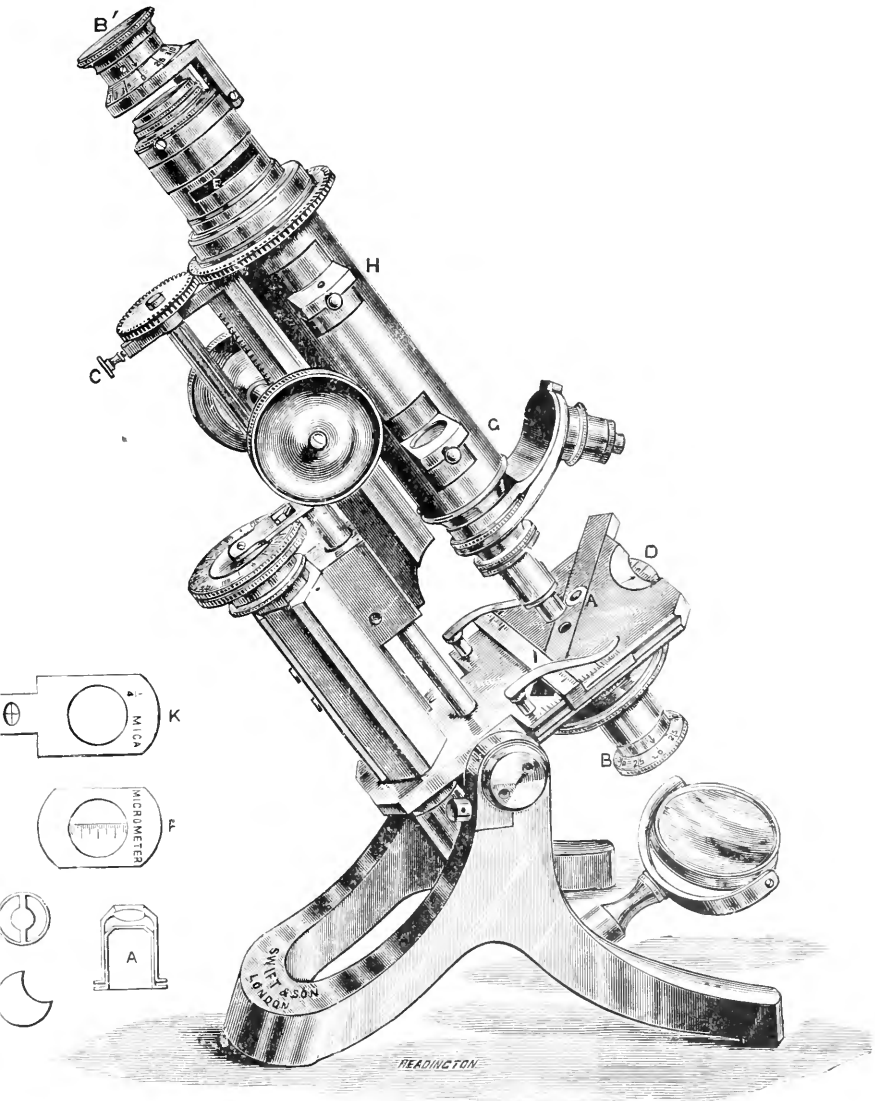

FIG. 803.—Swift's petrological microscope.

wheel of the same size as that upon the analyser; this wheel gears into a wheel carried by a tube which forms a telescopic extension of

the pinion wire, the object being to allow of the raising or lowering of the body of the microscope for focussing. The analyser and the polariser may thus be rotated synchronously without disconnecting their toothed wheels. The polariser, in the latest form of the instrument, is mounted on a crank arm, so that, if not required, it may be thrown out of the axis of the stand. Now, in the microscopes usually constructed for petrological work the rotation of a small crystal on the stage between the polarising and the analysing prisms is liable to put it out of position in regard to the cross-threads in the eyepiece, as the centring of the objective is scarcely ever so perfect as not to produce *some* displacement; and, if the centring be adjusted so as to be perfect for one objective, it is likely to be faulty for another. (By a small crystal is meant a crystal under the $\frac{1}{1000}$ th of an inch in diameter, and of such thickness as one finds at the edges of petrological sections.) Hence, by the arrangement described above, centring is dispensed with, and the object is made to rotate between the two prisms of the polarising apparatus without changing its position beneath the objective. To a petrologist who is accustomed to a rotating stage and fixed cross-wires, a familiar section appears strange when first looked at on a fixed stage with movable cross-wires, but after a few hours' work with the instrument the feeling of strangeness passes and that of the solid advantage of a perfect centring remains.

On the polariser tube, above the toothed wheel and below the stage, is fitted a goniometer, D, which, in combination with crossed lines in the eyepiece, will permit of the measurement of the angles of crystals without necessitating the shifting of the object when once adjusted in the field. C is a set screw by which the polarising apparatus and goniometer may be fixed in any desired position. Both the analysing and polarising prisms are divided to every 45° , a spring catch marking the extinction point. The opening between the upper lens of the eyepiece and the analysing prism B' (fig. 803) is for the purpose of placing such plates as the $\frac{1}{2}$ -undulation plate K in position.

The great value of the instrument is in the facility with which studies in convergent light can be performed. G is a slide fitted with a double convex lens which may be used for showing the optical figures of crystals, and H is a similar slide carrying a lens and a diaphragm of small aperture used for showing optical pictures in minute crystals. The polariser is fitted with two convergent lenses, which work in conjunction with the lens A on the slide of the stage, when great convergence is required. This slide may be pushed in without disturbing the object upon the stage. The achromatic condenser, A, shown at the foot of the figure, also works in conjunction with the sliding lens, A, when the highest angular aperture is required.¹

¹ In the latest made instruments a new achromatic convergent system is introduced over the polariser. It gives a N.A. of 1.00, and an aplanatic cone 0.92. When used as an immersion condenser, these are increased respectively to 1.12 and 1.05. It is fitted with an iris diaphragm placed above the polarising prism. A milled collar actuates the focussing of the lower portion of the condenser. The fine adjustment is the differential-screw form, which is sufficiently delicate and accurate to determine the refractive index of minerals by the difference between the foci taken

When convergent light is required the slide on the stage and either G or H are pushed in, and the eyepiece covered with the analyser B'. The optical figures of the crystal then appear with almost ideal clearness. If this simple method is compared with that previously in use, the superiority of the instrument will be immediately recognised. It is in fact the most perfect petrological microscope yet issued, and is one which will suit equally the mineralogical and petrological student.

The microscopical investigation of rock sections has almost revolutionised petrology. Although the geologist has no difficulty in determining by his unaided eye with the use of simple chemical tests the mineral components of rocks of coarse texture, the case is different with those of extremely fine grain; still more with such as present an apparently homogeneous, compact, or glassy character. The study reveals facts of the most striking significance, and welcome light has been thrown upon the question of the order and method of formation of rock constituents.¹

The material which issues from a volcano during an eruption is rarely in a state of complete fusion. In most cases it contains crystals and parts of crystals which have formed before the arrival of the fluid mass at the surface of the earth. Such crystals are usually of large size and can generally be recognised with the naked eye. But sometimes these have undergone other changes before the final consolidation of the rock. They may have been formed under high pressure, for the pressure lowers the melting-point of most substances. Accordingly, as the pressure is relieved upon the lava getting at or near the surface, the crystals which are floating in the fused mass at the time are liable to become corroded or redissolved. Again, some subterranean change may produce a distinct rise in the temperature of the mass, or an access of heated water may increase the solvent power of the molten portion. Instances of corrosion from one or more of these causes are numerous. The quartzes of the quartz-

through the substance and its outside measure, the milled head being divided to 50, and each division equalling one thousandth of a millimetre. A wheel of small apertures is fitted to the upper Bertrand lens of the microscope for the purpose of showing optical pictures in minute crystals of various sizes.

¹ The reader is referred to the following works treating of the microscopical characters of minerals and rocks:—F. Fouqué et Michel Lévy, *Minéralogie micrographique*, Paris, 1878; E. Hussak, *Anleitung zum Bestimmen der gesteinsbildenden Mineralien*, Leipzig, 1885; E. Kalkowsky, *Elemente der Lithologie*, Heidelberg, 1886; A. V. Lasaulx, *Elemente der Petrographie*, Bonn, 1875, and *Einführung in die Gesteinslehre*, Breslau, 1886 (also edition in French); Lévy et Lacroix, *Les Minéraux des Roches*, Paris, 1888; F. H. Rosenbusch, *Mikroskopische Physiographie*, 2nd edition, vol. i. 'Die Mineralien' (translated into English by Iddings), vol. ii. 'Die mässigen Gesteine'; *Hilfstabellen zur mikroskopischen Mineralbestimmung in Gesteinen* (translated into English by F. H. Hatch); and *Elemente der Gesteinlehre*, 1898; F. Rutley, *The Study of Rocks*, 3rd edition, 1884, and *Rock-forming Minerals*, 1888; J. J. H. Teall, *British Petrography*, 1888; F. Zirkel, *Lehrbuch der Petrographie*, 2 vols. 2nd edition, 1893; *Basaltgesteine*, Bonn, 1870; *Die mikroskopische Beschaffenheit der Mineralien und Gesteine*, Leipzig, 1873; *Microscopical Petrography* (U.S. Geol. Exploration of 40th parallel), Washington, 1876; A. Harker, *Petrology for Students*, 1895 (1st edition). The English student will find much valuable information and useful directions in G. A. J. Cole's *Aids to Practical Geology*. But the literature is now so voluminous that it is practically impossible to give anything like a complete list; for important papers will be found in almost every periodical dealing with geology, among which those published in the United States must not be forgotten.

porphyries have this corroded appearance; whilst the porphyritic constituents of the basic rocks (hornblende, olivine, &c.) not infrequently show the same alteration (*vide* fig. 804; the dotted line marks the original outline). In the case of the hornblende the dissolved portions usually give rise to the formation of small grains of augite and magnetite, which are then found encircling the 'mother-crystal.' Biotite is somewhat similarly affected, and sometimes the whole crystal in either mineral may be rendered almost opaque by the separation of minute grains of magnetite.

The movement of the igneous mass may cause fracture of the crystals owing to strain or to mutual pressure. The pieces of such broken crystals may often be found in one and the same section, sometimes at no great distance from each other. As the magma solidifies, a further development of crystals occurs. The products of this period constitute the 'ground-mass' of the rock and are usually small in size, the microscope being frequently required for their detection and determination.

A glass is sometimes produced in the last stage of consolidation.

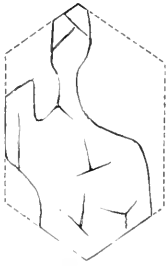

FIG. 804.—Corroded olivine in basalt of Kilimanjaro, East Africa.

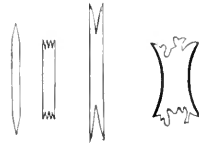

FIG. 805.—Microlites. (After Zirkel.)

and appears as a base or 'setting' to the previously formed minerals. This, however, is usually studded by minute mineral products endeavouring to crystallise under unfavourable circumstances. Generally speaking, these products are present in two stages of development. The less perfectly developed forms of these are known as *crystallites*. They occur in a variety of forms—hair-like, spherical, &c.—and the smaller forms appear to be optically inactive. In some instances, such as those termed 'globulites,' they may be minute segregations of a glassy nature; in others crystalline aggregates, in which from the extreme minuteness of the constituents and their mutual interference the usual tests fail; in other cases they may be designated embryonic crystals.

The bodies belonging to the higher stage of development are called *microlites* or *microliths* (fig. 805). They differ from the crystallites in possessing the internal structure of true crystals and in acting on polarised light. The position of the microlites with reference to each other or to the large crystals is frequently an indicator of the movements of the original fluid mass. When streams of microlites are seen lying with their long axes in one direction, this direction is

equivalent to that of the flow, and where such streams encounter large crystals they sweep round them in graceful curves: this appearance in a rock is known as fluxion-structure.

In certain glassy rocks microlites are collected into more or less spherical masses, exhibiting a radial structure, called spherulites; commonly these are not bigger than a pea, but sometimes they are one or two inches in diameter; they are then less regular in shape and structure and are often named for distinction pyromerides. Chemical analysis often shows that they differ slightly in composition from the base. Crystalline rocks also sometimes exhibit a similar structure, e.g. the orbicular diorite of Corsica. A spherulitic structure can be produced in a compact rock by subsequent heating, short of melting, and many glassy rocks in lapse of time become 'devitrified' by setting up an obscure confused crystalline structure.¹

Masses of molten material may, however, consolidate at a considerable depth beneath the surface of the earth; in such cases the distinction between the first and second periods of crystallisation is not generally so well marked.

A crystal is, in one respect, like an organism—it is affected by its environment. The crystal modifies its surroundings, and is in turn modified by them; there is action and reaction between it and its environment. This remarkable property of all crystalline bodies is well shown by the microscope. Crystals are constantly found built up of different layers or zones of material slightly unlike in their optical characters, and thus dissimilar in chemical constitution. This is the so-called zonal structure, and is common in the feldspars and augites—in short, in nearly all minerals which admit of isomorphic replacement in their constituents (fig. 806). Its presence in the case of the augites is often indicated by a difference in colour. This structure may be experimentally produced by placing an artificial crystal in a solution of a substance isomorphic with that of the crystal.

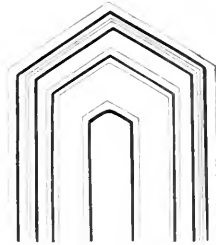

FIG. 806.—Augite showing zonal structure. (After Zirkel.)

The microscope has rendered another great service, inasmuch as it has enabled the petrologist to draw conclusions as to the physical condition of the fused mass or *magma* at the time crystallisation commenced. All chemists are aware that when crystals are deposited from solutions at ordinary temperatures they usually contain small cavities full of the mother-liquor. Now, the growth of crystals in igneous rocks is exactly analogous to that in a supersaturated saline solution. Portions of the fused mass become entangled, which on cooling remain in a glassy condition, or 'become stony,' so as to produce what may be called glass- or stone-cavities.² When formed

¹ This subject is discussed in *Quart. Journ. Geol. Soc.* 1885 (Presidential address).

² Sorby, *Quart. Journ. Geol. Soc.* 1858, p. 242.

The first section of the document discusses the early years of the nation, focusing on the challenges faced by the young republic as it sought to establish a stable government and economy.

The second section details the political and social changes that shaped the nation's identity, including the expansion of westward and the role of the federal government in managing these territories.

The third section covers the period of industrialization and the rise of the middle class, highlighting the impact of technological advancements and the changing social landscape.

The fourth section addresses the Civil War and its profound impact on the nation, including the struggle for freedom and the redefinition of the country's political and social structure.

The fifth section explores the Reconstruction era and the challenges of rebuilding the South, as well as the continued efforts to secure civil rights for all citizens.

The final section discusses the late 19th and early 20th centuries, focusing on the rise of imperialism, the Progressive Era, and the nation's emergence as a global power.

salt slowly evaporating. Restoration of the broken angles first takes place: then deposition goes on over the whole exposed surface, in perfect optical and crystalline continuity, so as to change a broken fragment into a definite crystal. A similar process frequently takes place in limestones which are not absolutely pure.¹ Sometimes this secondary deposit is carried so far on the grains of a clean sandstone that the interstices are completely filled up and the rock is converted into a quartzite.

By the microscopical examination of volcanic dust or ashes it is possible to determine the constitution of the igneous mass whose eruption gave rise to such material. Thus the ashes and dust which fell at various places after the great Krakatoa eruption in 1883 were found to belong to an acid lava, a pyroxene andesite.²

Further, glacial boulders can be satisfactorily identified with rocks *in situ* by a microscopical examination of their thin sections. Thus Norwegian rocks have been shown to occur as boulders in the Eastern Counties, while Swedish and Finnish rocks are common in the drift of North Germany and Saxony.



FIG. 108.—Sandstone (A) with thin, wavy deposit (B) deposited on the surface. After Dr. Scott.

We now come to the discussion of the metamorphism to which all rock-masses are liable. The metamorphism caused by atmospheric agencies results in decomposition and disintegration. The constituents are, of course, very differently affected, but rapidity of disintegration demands the decomposition of one of the principal constituents. Such a constituent is felspar, which decomposes under the influence of water charged with carbonic acid into kaolin; while the products of the decomposition of non-aluminous minerals are

carbonates, ferric oxide, and quartz. The minute accessory constituents, such as the titanium oxides, are not affected by these agencies, and hence are to be found in all clays and sands.³ At greater depths from the surface disintegration is replaced by the formation of new, especially hydrous, minerals. Thus serpentine is formed from olivine, and sometimes from suitable varieties of augite or hornblende; chlorite from biotite; epidote from suitable minerals, and so on.

Thermal waters charged with various substances are common in all volcanic districts and play their part in the metamorphosis of rocks. In this way a volcanic rock may become silicified through the percolation of such solutions: and microscopical examination has

¹ F. Weidemann, *Quart. Jour. Geol. Soc.*, vol. 8, p. 157, 1852, p. 177.

² See J. Murray and A. Renard, 'Volcanic Ashes and Cosmic Dust' in *Nature*, 1884, vol. 33, p. 187; also J. W. Judd, Krakatoa Report, published by the Royal Society.

³ V. M. Hutchins, however, is of opinion that rutile is produced as a secondary mineral in certain states, though he would not dispute its occurrence as a primary mineral. *Min.*, 1890, p. 264. A series of papers bearing on the subject of rutile has been published since that date in the same periodical are all worthy of reference.

shown that in portions of the Roche Castle rock, in Pembrokeshire, the porphyritic feldspars have been replaced by quartz. The tourmaline, gilbertite, and other minerals often found at or near the junction of granite and sedimentaries (e.g. in parts of Cornwall and Devon) are probably results of hydrothermal metamorphism, and in this way many metallic ores may be deposited; while the conversion of peridotites into serpentines, sandstones into quartzites (not to mention other instances), are results of the action of water, probably with some slight increase of pressure and temperature.

The intrusion of an igneous rock generally has an important influence on the structure and mineralogical composition of the surrounding mass, portions of which it can include and partially dissolve (contact-metamorphism). Sections from the junction of an igneous rock with one of sedimentary origin are highly interesting. The metamorphism is found to consist largely in the development of new minerals, such as chloritoid, andalusite, kyanite, and chlorite, also garnets, staurolite, &c.; the first and third of these appear to form most readily, andalusite after a time replacing chloritoid; and the last three require high temperatures. Gradually the original sedimentary structure disappears from a rock affected by contact-metamorphism, and one that is crystalline is set up, and whatever has characters of its own. Limestone becomes a calc-schist, fossils disappearing, and minerals such as chloritoid, kyanite, &c., are formed from impurities. Occasionally the heat is so intense as to fuse at least the matrix of sandstones into a vitreous glass.

The microscope has also proved most useful in studying questions relating to dynamic metamorphism, that is to the effects of pressure. The deformation of an element has sometimes been so great as to obliterate, partially or even completely, the original structure of the rock. The intense pressures must produce a considerable increase of temperature and increase the solubility of the elements, and thus the constituents of the rock are best regarded as having been melted at a late stage, and subsequently crystallized. It is well known that many gneisses and schists, though not so highly metamorphosed as crushing or shearing from igneous rocks, are gneisses, and are probably wholly or partly solid from a melt. In the case of some of the gneisses of the felspar, the formation of orthopyroxene and hornblende, and the partial effects of diagenesis, in the gneisses, may be studied under the microscope, and in the latter case the conversion of augite into hornblende. This is a very important question, and one more than any other, and even, perhaps, more difficult to study and distinguish. These questions are not, however, of a general or extended practical interest, but are engaged in at least fifteen papers, and are too difficult and technical to be discussed in a book of this character, although to say that nearly all the papers and other articles in this volume would be important chapters in books on the subject of metamorphism is justified.

See also *Journal of the Geological Society*, vol. lxxv, p. 111.

¹ *Journal of the Geological Society*, vol. lxxv, p. 111, 112, 113.

² A more complete and detailed account of the subject of dynamic metamorphism, and of the effects of pressure, will be found in the *Journal of the Geological Society*, vol. lxxv, p. 111, 112, 113.

The optical methods now in use enable the petrologist to determine the constituents of rock-masses with great success. The colour of the mineral in transmitted light, the crystallographic outlines, the direction of the cleavage planes, the polarisation tints, the position of the axes of elasticity, as also of the optical axes, all these, with other minor properties, render his determinations of real value. In certain cases pleochroism is a valuable test; this is well developed in such minerals as hornblende, biotite, tourmaline, &c.

Very important service has been rendered by the microscope in the study of the phenomena known as optical anomalies. There exist a large number of minerals which show in thin sections optical properties which do not agree with those of the crystal system to which they belong. Experiment has proved that compression, strain, or other mechanical distortion, may cause amorphous bodies, like glass, and crystals belonging to the regular system to become double-refracting, and a uniaxial crystal becomes biaxial by the application of pressure at right angles to its optical axis.

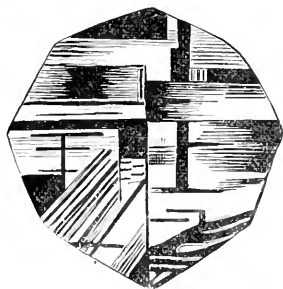

FIG. 809. —Leucite showing twin-striation under crossed nicols. (After Zirkel.)

Mention may well be made here of the anomalies presented by the mineral leucite, which is a most important constituent of the lavas of Vesuvius and the neighbourhood of Rome. It crystallises apparently in icositetrahedra (fig. 809), and thus to belong to the regular system it should remain dark under crossed nicols, that is, be isotropic. The small crystals certainly behave in this manner, but the large ones display more or less double refraction with decided traces of twin-lamellæ (fig. 809). This anomaly was for a long time inexplicable, till Klein showed¹ that such crystals revert when heated to 500° C. to a condition of perfect isotropy, which property they again lose upon becoming cool. The conclusion to be drawn from his classical investigation is that the leucite originally crystallised in the regular system and that its present optical condition is owing to molecular change due to strains set up as the temperature falls during and after solidification. It is worthy of notice that MM. Fouqué and Michel Lévy have synthetically produced a leucite rock, the leucites of which possessed the optical anomalies described above.

The relation between optical characters and chemical constitution has received some degree of attention, and in the case of the felspar group has been accurately determined. Only the 'quantitative' portion of the subject can be dealt with here, and we must abstain from the discussion of those minerals whose microscopical appearance leads the trained petrologist to draw *qualitative* conclusions. By employing convergent light, a slice of a mineral, cut in the right direction, can be examined and an 'optical picture' obtained.

¹ For a description of the so called 'Erhitzungs-Mikroskop,' see Groth's *Physikalische Krystallographie*, Leipzig, 1885, p. 631.

Inferences may be drawn from the presence or absence of this on the surface of easiest cleavage in a flake. In a slice from a rock the minerals may be cut in any direction, and are often too small for proper study; nevertheless important inferences may be drawn from the shadows seen to sweep over them as the stage is rotated between crossed nicols.¹ Even if only parallel rays be used, with the ordinary apparatus, minerals often may be identified with practical certainty from their optical characters. Minerals of the regular system, like colloids, being isotropic,² produce no effect on the polarised rays, and thus remain dark between crossed nicols. So do all slices cut from a uniaxial mineral perpendicular to the principal axis (that of symmetry), for they are isotropic to light passing in that direction. The same property exists in all biaxial minerals in two directions (called the optic axes). But in passing through slices cut in any other directions from doubly refracting minerals, the polarised ray is divided into two rays, vibrating in directions perpendicular to each other and coincident with three lines called the axes of elasticity, i.e. the directions of greatest, least, and mean elasticity. When the slice is turned into such a position that two of these correspond with the vibration planes of the crossed nicols, it becomes dark. If extinction (of light) occurs parallel with the trace of a pinacoid or prism face (or with a corresponding cleavage plane) in a section through the vertical axis, or with the trace of the former in a section perpendicular to it, this is called 'straight extinction,' but if not, it is said to be oblique. Thus in a uniaxial crystal every slice cut parallel with the principal axis gives straight extinction. In the orthorhombic system, the axes of elasticity correspond with the crystallographic axes, so minerals belonging to it also extinguish straight. In the monoclinic system the orthodiagonal axis is an axis of elasticity, hence the extinction angle is at a maximum in clinodiagonal sections, and is zero in the zone containing the ortho- and basal pinacoids. In the triclinic system there is no relation between the two sets of axes. Of this system, however, oscillatory twinning, producing alternately banded colours, is a frequent characteristic. Measurements of the extinction angle are of much value for distinctive purposes. Thus a rhombic pyroxene can at once be distinguished from a monoclinic by its straight extinction.³ Again the maximum extinction angle in a hornblende falls short of 20° ; in an augite it may exceed 40° . The magnitude of this angle is affected by changes in the chemical composition of a mineral: for instance, it is very small in soda-hornblendes, such as glaucophane and riebeckite. It varies in the felspar group, and is very useful in distinguishing the several species.⁴ But as the minerals in a rock-section seldom chance to lie in the right positions for accurate measurement, better

¹ See for a full account of this, with illustrations, F. Fouqué and M. Lévy, *Minéralogie Micrographique*, 1879, pp. 101-3. Also F. Rutley, *Rock-forming Minerals*, p. 84.

² That is, having the ether equally elastic in all directions.

³ Obviously, more than one observation is needed, because, as intimated above, a monoclinic mineral, if cut in certain directions, also gives straight extinction.

⁴ Lévy, *Détermination des Felspaths* (1894) p. 31. Summaries of results will be found in Rutley, *Rock-forming Minerals*, pp. 204, 221, and Cole, *Aids in Practical Geology* (see 'Felspar' for the references).

results are generally obtained by crushing up a small fragment of the rock itself and mounting a few selected flakes, which can readily be arranged for examination. Indeed, the study of a little powdered rock is often valuable as an adjunct to that of a section, and when we have some special purpose in view, or specimens do not promise to be interesting, it may even obviate the necessity of cutting slices.

The researches of the late Max Schuster have established the important fact that in the normal plagioclase feldspars, which may be considered as isomorphous mixtures of albite ($\text{Na}_2(\text{Al}_2)\text{Si}_6\text{O}_{16}$) and anorthite ($\text{Ca}(\text{Al}_2)\text{Si}_2\text{O}_8$), the optical and chemical characters stand in the closest possible relations to each other. Hence, given the extinction angle on a known surface, the chemical constitution is known and, roughly speaking, the specific gravity.

Another optical test of importance is the refractive index of a mineral. The methods of measuring this are described in most of the larger text-books, but much—often enough for all practical purposes—can be done in a rough and ready way. For instance, minerals with a high refractive index, such as diamond, garnet, zircon, appear to stand out conspicuously on the slide. When they occur in sand or the powder of a rock this is even more marked, and internal reflection due to the large critical angle gives to the grain a strong dark outline. Again, if a mineral with a high refractive index be in apposition (as in a slice from a rock) with another having a lower one, or with Canada balsam, and a quarter-inch objective be used (with a plane reflector) and focussed on the top of the first mineral, a thin bright line is seen just within its edge; but when the focus is changed to the bottom, this appears without the edge.

The importance of pleochroism has been already mentioned. It is not seen in colourless minerals, or in slices so cut as to be isotropic in the plane at right angles to the path of the transmitted beam. In augite it is generally weak, though visible in some green varieties; but in hornblende strong, especially in certain varieties. Glaucophane exhibits a violet blue and a reddish purple; riebeckite turns almost black; biotite, chlorite, amblystegite, and tourmaline show it well, but in iolite it can be seen only in thick slices. The student should note the results as the polarised beam vibrates parallel with each axis of elasticity; these facts, however, as a rule, are more important to the petrographer than to the petrologist, and the latter will not find it worth his while to spend time in determining them.

The polarisation tints of a mineral, i.e. those seen with crossed nicols, depend to some extent on the thickness of the slices, as has been already stated, but they are often variable even in the same mineral. Hence, though, as a rule, the student will find each species gives a certain group of tints in the order of the chromatic scale, he must be prepared for abnormalities. For instance, quartz, when it occurs in a granite, usually gives high tints, but in a trachyte they are rather low. At first the student must be cautious in drawing inferences from polarisation tints, but after a certain amount of practice he may do this with more confidence, though he will rely more on the 'quality' than on the 'quantity' of the colour. For instance, though both augite and olivine usually afford rich colours, an

experienced eye can generally tell the difference, for the latter appears more diaphanous than the former. In petrology, as in medicine, a cautious empiricism, which signifies experience concentrated and regulated by common sense, is sometimes even more valuable than any amount of printed rules.

On this account the student may be glad to have a few general directions as to the best method of studying a rock slice. First, look at it with a rather strong pocket lens, especially if it be crystalline or fragmental, so as to get a good idea of its general structure, which is sometimes less easily seen under the microscope, because the field of view at any one time is small, and high magnification may make it 'hard to see the wood for the trees.' Then place it on the stage and examine first with transmitted, next with reflected light. The former shows what minerals are colourless, and the natural tints of the coloured, bringing out well slight differences of structure, especially any due to incipient decomposition.¹ The latter enables him to distinguish the opaque minerals, e.g. pyrite from magnetite, sometimes the latter from other iron oxides; to identify native iron, awaruite, and gold; perhaps also graphite, but it is better to verify the last by powdering a little of the rock, when the streak is easily obtained. Sometimes we are helped in distinguishing even transparent minerals by the different way in which they reflect light. Next, put on the polariser and examine pleochroism; and lastly, insert the analyser, for the general study of the tints produced and especially of the extinction angles of certain of the minerals. When a mineral gives very low polarisation tints, especially in the case of certain aggregates, or we are searching for a glassy base in a slice crowded with microliths, we may be helped by inserting a selenite or quartz plate (better just below the slide) to obtain a coloured field,² for the eye can be more sure of a difference of tint than of a very faint glimmer of light.

In dealing with rocks apparently clastic we have to determine whether the structure is original, or has been superinduced (by crushing or shearing); also what amount of mineral change has subsequently occurred, and of what this is significant—investigations which, though of the highest interest, are often by no means easy, so that the most experienced worker may occasionally be baffled. One final piece of advice: before adopting a conclusion, look at it all round, to see how it fits in with previously acquired knowledge and the probabilities in the particular case.

The micro-spectroscope has not at present been so much used by petrologists as it might have been. It has been employed by Professor Orville Derby in the determination of the presence of monazite in Brazilian sands.³ This mineral contains a large percentage of didymium, and accordingly gives the bands

¹ Holes in the slice and bubbles in the balsam, which often perplex beginners, are now most readily detected. Also a mineral of easy cleavage is sometimes slightly ruptured in the grinding, producing diffraction tints (as in calcite). These, between crossed nicols, might be mistaken for oscillatory twinning; but at the present stage their true nature is obvious.

² This method can also be used to enhance a weak pleochroism.

³ *American Journal of Science*, vol. xxxvii. 1889, p. 109.

characteristic of that element. The test afforded by studying the colour of the flame when a small fragment is acted upon by the blow-pipe is often valuable—but this, of course, hardly forms part of microscopy.¹

The discovery of the presence of foreign inclusions in all minerals has led to a remarkable revolution in mineral-chemistry. In earlier days it was customary to analyse a mineral without questioning its purity. Hence the early analyses and the formulae developed therefrom express the actual constitution *plus* the inclusions. Methods have now been invented by which the foreign matter can be removed. Advantage is taken of the difference that is usual between the specific gravity of the mineral and that of its inclusions, the so-called 'heavy solutions' being employed for the separation.² Most satisfactory results have been obtained by such means. In cases where the greatest accuracy is necessary, the apparatus designed by Dr. P. Mann had better be employed.³ It is well microscopically to examine the isolated substance before executing the analysis, for the optical test with polarised light is so sensitive as to detect the smallest impurities. Also, in the case of ordinary bulk analyses of rocks, it is advisable to follow the same course, as by doing so one is often enabled to make a qualitative analysis with the microscope alone.

A valuable adjunct to petrology is to be found in micro-chemistry.⁴ Instances sometimes occur where a mineral cannot be satisfactorily determined by its optical characters, and in such cases micro-chemical methods are resorted to. Let us suppose it is desirable to see whether any of the rock-components are silicates containing soda and soluble in acids. The cover-glass is accordingly removed and the balsam dissolved in alcohol. A weak solution of hydrochloric acid is then poured over the surface, when, if soluble silicates are present, gelatinisation will take place. Upon allowing the gelatinous mass to evaporate little squares of salt will form if such a silicate is present. Sometimes colouring substances may be used for the same purpose. By the treatment of a slide with nitric acid a silicate like nepheline becomes porous and permeable to anilin blue, fuchsin, &c. In the case of nepheline the colouring matter cannot be washed out, and hence 'staining' proves a delicate test.

Where such a course is possible, minute pieces of the questionable minerals should be isolated and treated singly. There are two

¹ It was suggested by Professor Szabó and is well described in G. A. J. Cole, *Aids in Practical Geology*, Part ii. ch. viii.

² For their mode of preparation see Rosenbusch, *Mikroskopische Physiographie*, p. 206 *et seq.* (English edition by Iddings.)

³ *Neues Jahrbuch für Mineralogie*, &c. Bd. ii. 1884, p. 172.

⁴ The following works can be consulted on this subject: E. Borický, *Elemente einer neneu-chemisch-mikroskopischen Mineral- und Gesteinsanalyse*, Prague, 1877; F. H. Belrems, *Mikrochemische Methoden zur Mineralanalyse*, Amsterdam, 1881; Haushofer, *Mikroskopische Reactionen*, Braunschweig, 1885; Klement et Renard, *Réactions microchimiques à cristaux*, &c., Bruxelles, 1886; Rosenbusch, *Mikroskopische Physiographie*, vol. i. 1885, pp. 195-238 (English edition by Iddings); F. Ratley, *Rock-forming Minerals*, London, 1888. A useful summary of a number of microchemical investigations is given by C. A. McMahon, *Mineralog. Magazine*, vol. x. p. 79.

methods in use for testing such particles micro-chemically. The first is that proposed by Boricky, who employed pure hydro-flu-silicic acid (H_2SiF_6), which attacks almost all rock-forming minerals. The mineral particle is placed upon a glass object-holder protected from the action of the acid by a covering of Canada balsam, and the acid allowed to attack the mineral. After evaporation an examination under the microscope reveals the presence of delicate crystals of the silico-fluorides of the metals present in the mineral. The nature of the crystals may then be determined microscopically.

The second method is that proposed by Behrens, and mostly follows the usual method of chemical analysis. The isolated particle is heated in a small platinum crucible with ammonium fluoride, the mass then evaporated with sulphuric acid and dissolved in hot water. A small quantity of the solution is then evaporated and examined. If calcium is present in the mineral small crystals of gypsum will form. Other quantities are treated with the ordinary reagents. The crystalline products, which are the result, can be identified by optical methods. It is possible by Behrens's tests to detect the presence of 0.0005 mgr. CaO in a grain.

In all cases it is advisable to protect the objective during the microscopical examination with a thin sheet of white mica.

The microscope has always played an important part in the science of **Palæontology**. The great work on 'Micro-geology,' published in 1855 by Professor Ehrenberg, testifies to the influence it had, even at that period, upon research of this nature.

The result of the microscopic examination of lignite or fossilised wood and of ordinary coal is a good example of the value of the instrument in this interesting department. Specimens of fossil wood in a state of more or less complete preservation are found in numerous strata of very different ages. Generally speaking, it is only when the wood is found to have been penetrated by silica that its organic structure is well preserved; but instances occur every now and then in which penetration by carbonate of lime has proved equally favourable. In either case transparent sections are needed for the full display of the organisation. Occasionally, however, it has happened that the infiltration has filled the cavities of the cells and vessels, without consolidating their walls; and as the latter have undergone decay without being replaced by any cementing material, the lignite, thus composed of the internal 'casts' of the woody tissues, is very friable, its fibres separating from each other like those of asbestos; and laminae split asunder with a knife, or isolated fibres separated by rubbing down between the fingers, exhibit the characters of the woody structure extremely well when mounted in Canada balsam. Generally speaking, the lignites of the Tertiary strata present a tolerably close resemblance to the woods of the existing period: thus the ordinary structure of dicotyledonous and monocotyledonous stems may be discovered in such lignites in the utmost perfection; and the peculiar modification presented by coniferous wood is also most distinctly exhibited. As we go back, however, through the strata to the Secondary period, we more and more rarely meet with the ordinary dicotyledonous structure; and the lignites of

the earliest deposits of these series are, almost universally, either gymnosperms¹ or palms.

Descending into the palaeozoic series, we are presented in the vast coal formations of our own and other countries with an extraordinary proof of the prevalence of a most luxuriant vegetation in a comparatively early period of the world's history. The determination of the characters of the *Ferns*, *Sigillariae*, *Lepidodendra*, *Calamites*, and other kinds of vegetation whose forms are preserved in the shales or sandstones that are interposed between the strata of coal, has been hitherto chiefly based on their external characters; since it is seldom that these specimens present any such traces of minute internal structure as can be subjected to microscopic elucidation. But persevering search has brought to light numerous examples of coal-plants whose internal structure is sufficiently well preserved to allow of its being studied microscopically; and the careful researches of Professor W. C. Williamson have shown that they formed a series of connecting links between Cryptogamia and flowering plants, being obviously allied to *Equisetaceae*, *Lycopodiaceae*, &c., in the character of their fructification, whilst their stem-structure foreshadowed both the 'endogenous' and 'exogenous' types of the latter.² Notwithstanding the general absence of any definite form in the masses of decomposed vegetable matter of which coal itself consists, the traces of structure revealed by the microscope are often sufficient—especially in the ordinary 'bituminous' coal—not only to determine its vegetable origin, but in some cases to justify the botanist in assigning the character of the vegetation from which it must have been derived; and even where the stems and leaves are represented by nothing else than a structureless mass of black carbonaceous matter, there are found diffused through this a multitude of minute resinoid yellowish-brown granules, which are sometimes aggregated in clusters and inclosed in sacculi; and these may now be pretty certainly affirmed to represent the *spores*, while the sacculi represent the *sporangia*, of gigantic *Lycopodiaceae* of the Carboniferous flora.³

Lime-secreting algae are now known to have often played an important part in the formation of calcareous rocks. Those organisms called coccoliths and rhabdoliths, which though so minute are important constituents in chalk and some other limestones, are referred to these plants (! to the class *Floridæ*), and a tiny tubular organism named Girvanella which occurs in various palaeozoic and later limestones is now generally regarded as an alga. According to Mr. E. Wethered⁴ it plays an important part in the formation of pisolitic and oolitic grains. Moreover calcareous algae, such as Lithothamnion, are sometimes important constituents in Tertiary limestones, as for instance in the Leitha-

¹ Under this head are included the *Cycadeæ*, along with the ordinary *Coniferae*, or pine and fir tribe.

² See his memoirs on the coal-plants published in the volumes of the *Phil. Trans.*, which are now being continued by Dr. D. H. Scott.

³ For notes upon methods to be employed in making preparations of coal, see Rutley, *Study of Rocks*, 1884, p. 71.

⁴ *Quart. Journ. Geol. Soc.* xlvi. (1890), p. 270, xlviii. p. 377, xlix. p. 236.

kalk of Europe. They have also been identified in rocks of Secondary and even of Palæozoic age. It is an admitted rule in geological science that the past history of the earth is to be interpreted, so far as may be found possible, by the study of the changes which are still going on. Thus, when we meet with an extensive stratum of fossilised *Diatomacea* in what is now dry land, we can entertain no doubt that this silicious deposit originally accumulated either at the bottom of a fresh-water lake or beneath the waters of the ocean; just as such deposits are formed at the present time by the production and death of successive generations of these bodies, whose indestructible casings accumulate in the lapse of ages, so as to form layers whose thickness is only limited by the time during which this process has been in action. In like manner, when we meet with a limestone rock entirely composed of the calcareous shells of Foraminifera, some of them entire, others broken up into minute particles (as in the case of the *Fusulina* limestone of the Carboniferous period, and the *Nummulitic* limestone of the Eocene), we interpret the phenomenon by the fact that the dredgings obtained from certain parts of the ocean-bottom consist almost entirely of remains of existing Foraminifera, in which entire shells, the animals of which may be yet alive, are mingled with the *débris* of others that have been reduced to a fragmentary state. Such a deposit, consisting chiefly of *Orbitolites*, is at present in process of formation on certain parts of the shores of Australia, as Dr. Carpenter was informed by Mr. J. Beete Jukes, thus affording the exact parallel to the stratum of *Orbitolites* (belonging, as his own investigations have led him to believe, to the very same species) that forms part of the 'calcaire grossier' of the Paris basin. So in the fine white mud which is brought up from almost every part of the sea-bottom of the Levant, where it forms a stratum that is continually undergoing a slow but steady increase in thickness, the microscopic researches of Professor W. C. Williamson¹ have shown, not only that it contains multitudes of minute remains of living organisms, both animal and vegetable, but that it is entirely or almost wholly composed of such remains. Amongst these are about twenty-six species of Diatomacea (silicious), eight species of Foraminifera (calcareous), and a miscellaneous group of objects (fig. 810), consisting of calcareous and silicious spicules of sponges and *Gorgonias*, and fragments of the calcareous skeletons of echinoderms and molluscs. A collection of forms strongly resembling that of the Levant mud, with the exception of the silicious Diatomacea, is found in many parts of the 'calcaire grossier' of the Paris basin, as well as in other extensive deposits of the same early Tertiary period.

It is, however, in regard to the great chalk formation that the information afforded by the microscope has been most valuable. Mention has already been made of the fact that a large proportion of the North Atlantic sea-bed has been found to be covered with an 'ooze' chiefly formed of the shells of *Globigerina*; and this fact, first determined by the examination of the small quantities brought up by the sounding apparatus, has been fully confirmed by the results of

¹ *Memoirs of the Manchester Literary and Philosophical Society*, vol. vii.

the more recent explorations of the deep-sea with the dredge; which, bringing up half a ton of this deposit at once, has shown that it is not a mere surface-film, but an enormous mass whose thickness cannot be even guessed at. 'Under the microscope,' says Professor Wyville Thomson¹ of a sample of 1½ cwt. obtained by the dredge from a depth of nearly three miles, 'the surface-layer was found to consist chiefly

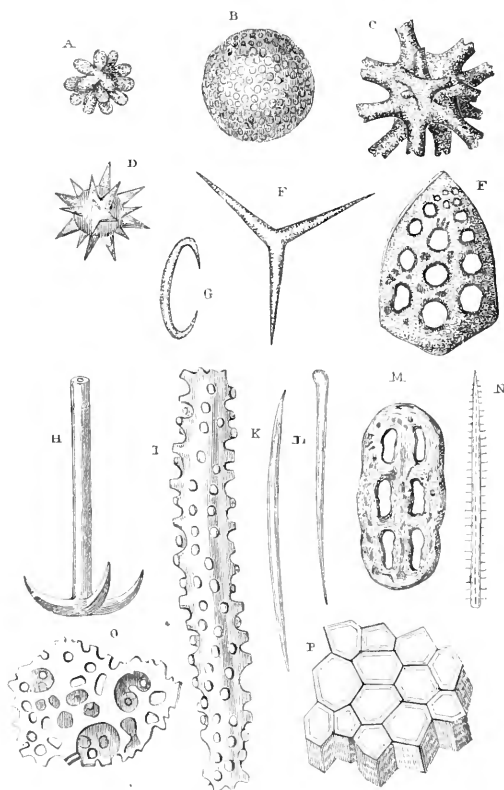

FIG. 810.—Microscopic organisms in Levant mud: A, C, D, silicious spicules of *Tethya*; B, H, spicules of *Geodia*; E, calcareous spicule of *Grantia*; F, G, M, O, portions of calcareous skeleton of *Echinodermata*; I, calcareous spicule of *Gorgonia*; K, L, N, silicious spicules of sponges; P, portion of prismatic layer of shell of *Pinna*.

of entire shells of *Globigerina bulloides*, large and small, and of fragments of such shells mixed with a quantity of amorphous calcareous matter in fine particles, a little fine sand, and many spicules, portions of spicules, and shells of *Radiolaria*, a few spicules of sponges, and a few frustules of diatoms. Below the surface-layer the sediment becomes gradually more compact, and a slight grey colour, due probably

¹ *The Depths of the Sea*, p. 410. See also *Voyage of Challenger*, ch. iii., and *Challenger Reports*, especially *Deep Sea Deposits* (Murray and Renard.)

to the decomposing organic matter, becomes more pronounced, while perfect shells of *Globigerina* almost disappear, fragments become smaller, and calcareous mud, structureless, and in a fine state of division, is in greatly preponderating proportion. One can have no doubt, on examining this sediment, that it is formed in the main by the accumulation and disintegration of the shells of *Globigerina*: the shells fresh, whole, and living in the surface-layer of the deposit; and in the lower layers dead, and gradually crumbling down by the decomposition of their organic cement, and by the pressure of the layers above.' This white calcareous mud also contains in large amount the 'coccoliths' and 'cocospheres' formerly mentioned. Now the resemblance which this *Globigerina*-mud, when dried, bears

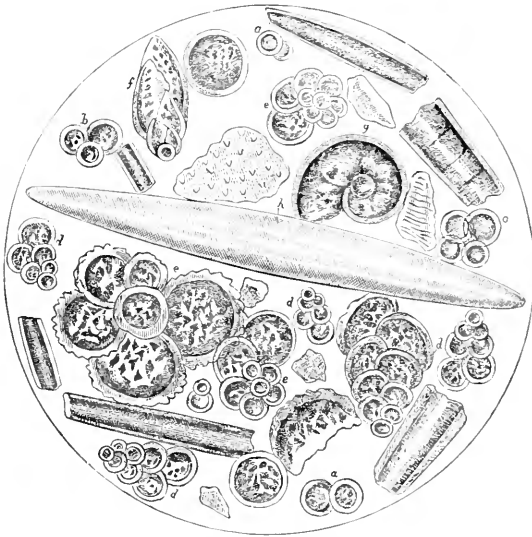

FIG. 811.—Microscopic organisms in chalk from Gravesend: *a*, *b*, *c*, *d*, *Tertularia globulosa*; *e*, *e*, *e*, *Rotalia aspera*; *f*, *Tertularia aculeata*; *g*, *Planularia hexas*; *h*, *Navicula*.

to chalk is so close as at once to suggest the similar origin of the latter; and this is fully confirmed by microscopic examination. For many samples of it consist in great part of the minuter kinds of Foraminifera, especially *Globigerina*, whose shells are imbedded in a mass of apparently amorphous particles, many of which, nevertheless, present indications of being the disintegrated fragments of similar shells, or of larger calcareous organisms. In the chalk of some localities the disintegrated prisms of *Pinna*, or of other large shells of the like structure (as *Inoceramus*), form the great bulk of the recognisable components; whilst in other cases, again, the chief part is made up of the shells of *Cytherina*, a marine form of entomostracous crustacean. Different specimens of chalk vary greatly in

the proportion which not only the distinctly organic remains bear to the amorphous residuum, but also the different kinds of the former bear to each other; and this is quite what might be anticipated when we remember how one or another tribe of animals predominates in the several parts of a large area; but it may be fairly concluded, from what has been already stated of the amorphous component of the *Globigerina*-mud, that the amorphous constituent of chalk likewise is the disintegrated residuum of foraminiferal shells, or at any rate of some small calcareous organism. But, further, the *Globigerina*-mud now in process of formation is in some places literally crowded with sponges having a complete silicious skeleton; and some of them bear such an extraordinarily close resemblance, alike in structure

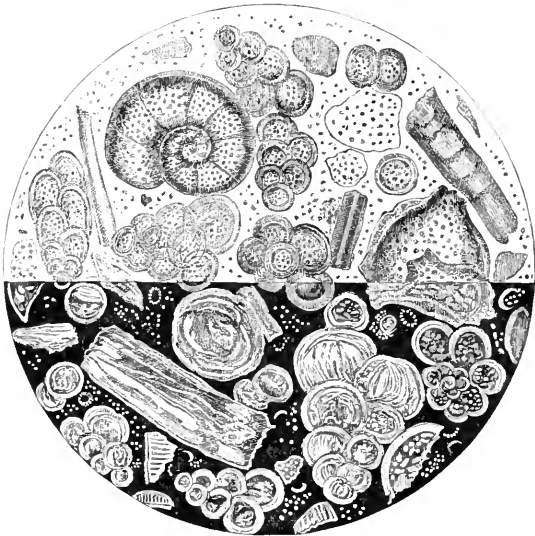

FIG. 812. —Microscopic organisms (chiefly *foraminifera*) in chalk from Meudon, seen partly as opaque, and partly as transparent objects.

and in external form, to the *Ventriculites* which are well known as chalk fossils, as to leave no reasonable doubt that these also were silicious sponges living on the bottom of the cretaceous sea. Finally (as was first pointed out by Dr. Sorby) the coccoliths and coccospheres at present found on the sea-bottom are often to be discovered by the microscopic examination of chalk.¹ All these correspondences show that the formation of chalk took place under conditions essentially similar to those under which the deposit of *Globigerina*-mud is being formed over the Atlantic sea-bed at the present time.

In examining chalk or other similar mixed aggregations, whose

¹ 'On the Organic Origin of the so-called "Crystalloids" of Chalk' in *Ann. Nat. Hist.* ser. iii. vol. viii. 1861, pp. 193-200. Murray and Renard, *Deep Sea Deposits* (*Challenger Reports*), p. 257.

component particles are easily separable from each other, it is desirable to separate, with as little trouble as possible, the larger and more definitely organised bodies from the minute amorphous particles; and the mode of doing this will depend upon whether we are operating upon the large or upon the small scale. If the former, a quantity of soft chalk should be rubbed to powder with water by means of a soft brush; and this water should then be proceeded with according to the method of levigation already directed for separating the *Diatomacea*. It will usually be found that the first deposits contain the larger Foraminifera, fragments of shell, &c., and that the smaller Foraminifera and sponge-spicules fall next, the fine amorphous particles remaining diffused through the water after it has been standing for some time, so that they may be poured away. The organisms thus separated should be dried and mounted in Canada balsam. If the smaller scale of preparation be preferred, as much chalk scraped fine as will lie on the point of a knife is to be laid on a drop of water on the glass slide, and allowed to remain there for a few seconds; the water, with any particles still floating on it, should then be removed; and the sediment left on the glass should be dried and mounted in balsam. For examining the structure of flints such chips as may be obtained with a hammer will commonly serve very well, a clear translucent flint being first selected, and the chips that are obtained being soaked for a short time in turpentine (which increases their transparency); those which show organic structure, whether sponge-tissue or xanthidia, are to be selected and mounted in Canada balsam. The most perfect specimens of sponge-structure, however, are only to be obtained by slicing and polishing.

The study of thin slices of flint and chert during late years has thrown much light on their origin and on the structure of fossil sponges. Spicules are often found to be extremely abundant as in the chert (Upper Greensand) from the quarry by Ventnor station (Isle of Wight), where they can be detected by the naked eye. The radiolaria from the Tertiary marl of Barbadoes have long been known to microscopists, but these organisms more recently have been detected in cherts. In Britain such cherts have been described from the Ordovician rocks of Mullion Island, Cornwall, and of south Scotland, and the Carboniferous of south-west England.¹

There are various other deposits, of less extent and importance than the great chalk-formation, which are, like it, composed in great part of microscopic organisms, chiefly minute Foraminifera;² and the presence of these may be largely recognised, by the assistance of the microscope, in sections of calcareous rocks of various dates, whose other materials were fragments of corals, crinoid-stems, or the shells of molluscs. In the formation of the Coralline Crag (Tertiary) of the eastern coast of England, polyzoaries had the greatest share; but

¹ On the former subject see G. J. Hinde, *British Museum Catalogue of Fossil Sponges*; on the latter, the same, *Quart. Journ. Geol. Soc.* vols. xlv. xlix. li.

² For illustrations of fossil foraminifera, see Carpenter, *Introduction to Study of Foraminifera* (Ray Society), and the publications of the Palæontographical Society; *Crag Foraminifera* (T. Rupert Jones, &c.); *Carboniferous and Permian Foraminifera* (H. B. Brady). The series also contains volumes upon the *Crag Polyzoa* and various small *Entomostraca* of different ages.

the Tertiary limestone of which Paris is chiefly built consists almost exclusively of the shells of *Miliolida*, and is thus known as miliolite (millet-seed) limestone. In the vast stratum of nummulitic limestone which was formed in the earlier part of the Tertiary period the microscope enables us to see that the matrix in which the large entire nummulites are imbedded is itself composed of comminuted fragments and young shells of the same, together with minuter Foraminifera. Similar organisms, with fragments of crinoids, mollusca, coral, &c., are doubtfully present in the Jurassic limestones in this country, in those of Secondary age generally in Europe, as well as in the Carboniferous and other Palæozoic limestones; in fact, wherever subsequent changes have not rendered the structure of the original constituents indistinguishable. Thus in the great plains of Russia there are certain bands of limestone of this epoch, varying in thickness from fifteen inches to five feet, and frequently repeated through a vertical depth of two hundred feet over very wide areas, which are almost entirely composed of the extinct genus *Fossilium*. Again, those parts of the Carboniferous Limestone of Ireland which have undergone least disturbance can be plainly shown by the examination of microscopic sections, to consist of the remains of *Fossilium*, *Polypora*, fragments of corals, &c. And where, as not infrequently happens, beds of this limestone are separated by clay seams, these are found to be loaded with numerous various kinds, particularly *Fossilium*, of which the specimen has come down to the present time, and the beautiful *Polyporites* known as *blue-wards*.

Mention has been already made of Professor Ehrenberg's very remarkable discovery of the minute, but in the proportion (to say the least) of the number, which present themselves in various stratified deposits, from the Silurian period to the Tertiary era, and in the marl of the Upper Greensands, composed of the casts of the interior of minute shells of *Fossilium* and *Miliolina*, the shells themselves having entirely disappeared. The mineral material of these casts, as it were, may be the silinders and their communicating passages, it has as yet not been shown to be indistinct ramifications, the arrangement of the interior of the shells. The precise number of these deposits presents great variety in spots, of the existing series extending to the Age of the *Keokuk*; the type of Great Hope, where the *Keokuk* has been found with a green sand which contains a large number of these minute casts, and is particularly rich in the casts of *Fossilium*.

It is to be observed, however, that the silinders of the *Keokuk* are not of the same size, the size of which varies rapidly from the base to the top, and the structure presents a gradual transition from the simple cylindrical form to a form which is more or less flattened, and in which the silinders are not so distinct as in the cylindrical form. It is to be observed, also, that the silinders of these casts are not of the same size, the size of which varies rapidly from the base to the top, and the structure presents a gradual transition from the simple cylindrical form to a form which is more or less flattened, and in which the silinders are not so distinct as in the cylindrical form.

The researches of Professor Quekett on the minute structure of *bone*¹ have shown that from the average size and form of the lacunæ, their disposition in regard to each other and to the Haversian canals, and the number and course of the canaliculi, the nature of even a minute fragment of bone may often be determined with a considerable approach to certainty, as in the following examples, among many which might be cited:—Dr. Falconer, the distinguished investigator of the fossil remains of the Himalayan region, and the discoverer of the gigantic fossil tortoise of the Sivalik hills, having met with certain small bones about which he was doubtful, placed them for minute examination in the hands of Professor Quekett, who informed him, on microscopic evidence, that they might certainly be pronounced reptilian, and probably belonged to an animal of the tortoise tribe; and this determination was fully borne out by other evidence, which led Dr. Falconer to conclude that they were toe-bones of his great tortoise. Some fragments of bone were found, many years since, in a chalk-pit, which were considered by Professor Owen to have formed part of the wing-bones of a long-winged sea-bird allied to the albatross. This determination, founded solely on considerations derived from the very imperfectly preserved external forms of these fragments, was called in question by some other palæontologists, who thought it more probable that these bones belonged to a large species of the extinct genus *Pterodactylus*, a flying lizard whose wing was extended upon a single immensely prolonged digit. No species of pterodactyle, however, at all comparable to this in dimensions, was at that time known: and the characters furnished by the configuration of the bones not being in any degree decisive, the question would have long remained unsettled had not an appeal been made to the microscopic test. This appeal was so decisive, by showing that the minute structure of the bone in question corresponded exactly with that of pterodactyle bone, and differed essentially from that of every known bird, that no one who placed much reliance upon that evidence could entertain the slightest doubt on the matter. By Professor Owen, however, the validity of that determination was questioned, and the bone was still maintained to be that of a bird, until the question was finally set at rest, and the value of the microscopic test triumphantly confirmed, by the discovery of undoubted pterodactyle bones of corresponding and even of greater dimensions in the same and other chalk quarries.

The microscopic examination of the sediments now in course of deposition on various parts of the great oceanic area, and especially of the large number of samples brought up in the 'Challenger' soundings, has led to this very remarkable conclusion—that the detritus resulting from the degradation of continental land-masses is not carried far from their shores, being entirely absent from the bottom of the ocean-basins. The sediments there found were not of organic origin, but mainly consist of volcanic *débris* and of clay that seems to have been produced by the disintegration of masses of very

¹ See his memoir on the 'Comparative Structure of Bone' in the *Trans. Microsc. Soc.*, ser. i. vol. ii.; and the *Catalogue of the Histological Museum of the Roy. Coll. of Surgeons*, vol. ii.

vesicular lava, which, after long floating and dispersion by surface-drift or ocean-currents, have become water-logged and have sunk to the bottom. As no ordinary silicious sand is found anywhere save in the neighbourhood of continents and continental islands, and as almost all oceanic islands are either of volcanic origin or coral atolls, this almost universal absence of any trace of submerged continental land over the great oceanic area affords strong confirmation to the belief that the sedimentary rocks which form the existing land were deposited in the neighbourhood of pre-existing land, whose degradation furnished their materials; and suggests that the original disposition of the great continental and oceanic areas was not very different from what it now is.¹ Further, the microscopic examination of these oceanic sediments reveals the presence of extremely minute particles, which seem to correspond in composition to meteorites, and which there is strong reason for regarding as 'cosmic dust' pervading the interplanetary spaces. Thus the application of the microscope to the study of these deposits brings us in contact with the greatest questions not only of terrestrial, but also of cosmical physics, and furnishes evidence of the highest value for their solution.

¹ See Sir A. Geikie on 'Geographical Evolution,' *Proc. Roy. Geog. Soc.* July 1879; and for detailed results 'Preliminary Report of Cruise of "Challenger"' (Wyville-Thomson), *Proc. Roy. Soc.* vol. xxiv. (1876) p. 463, and 'Challenger' Reports (Murray and Renard), *Deep Sea Deposits*, p. 327.

CHAPTER XXIV

*MICROCRYSTALLISATION. OPTICAL PROPERTIES OF CRYSTALS.
MOLECULAR COALESCENCE. MICRO-CHEMICAL ANALYSIS.*

ALTHOUGH by far the most numerous and most important applications of the microscope were formerly those by which the structure and actions of organised beings are made known to us, yet the increased attention which has been paid during recent years to the use of the microscope in elucidating the internal structure of crystalline substances, whether of natural or artificial origin, has made this instrument as indispensable to the crystallographer and the mineralogist as it formerly was to the physiologist. Solid substances are almost invariably found in nature or obtained as laboratory products in the form of individual fragments, each bounded by plane surfaces which are inclined at such angles that the whole figure is possessed of a greater or lesser degree of geometrical symmetry. Such solid bodies are termed crystals, and, although formerly the regularity of external shape constituted the only available means of recognising them, it is now demonstrated that the external form is only the result of the so-called *homogeneous* internal structure of the crystal. This homogeneity of structure consists in the arrangement of the smallest characteristic particles or units of the structure being the same about every unit of the structure. The different kinds of possible homogeneous arrangements of points in space have been investigated by Bravais, Sohncke, and others,¹ and on classifying them according to their symmetry they fall into thirty-two classes identical with the thirty-two known crystalline systems. These thirty-two types of structure differ in their symmetry, and this difference is expressed in the symmetry of the external form; the external form, however, is very liable to distortion, in consequence of a lack of uniformity in the conditions prevailing during the growth of the crystal, and so is at best but an untrustworthy guide to the symmetry of the internal structure. The optical properties of the solid structure, also themselves expressions of the symmetry, and consequently of the crystalline system, are not disturbed by casual influences to nearly so great an extent as is the regular external form: the symmetrical variation of the optical properties of crystalline structures in accordance with the symmetry

¹ See A. Schoenflies, *Krystallsysteme und Krystalstruktur*, Leipzig, 1891.

of arrangement of the structural units gives rise to the phenomena of double refraction, circular polarisation, pleochroism, &c., observed with crystalline bodies. The important results to be anticipated from the microscopic examination of crystalline preparations such as rock sections, etc., was pointed out by H. C. Sorby in 1858; the microscopic methods as at present applied to pure crystallography have been fully described by P. Groth¹ and by Th. Liebisch,² whilst their applicability to the identification of the crystalline constituents of rocks has been exhaustively treated by H. Rosenbusch.³

The study of crystalline materials in such minute crystals as are appropriate subjects for observation by the microscope is not only a very interesting application of its powers, but is capable of affording some valuable hints to the designer. This is particularly the case with crystals of *snow*, which belong to one of the 'hexagonal systems,' the basis of every figure being a hexagon of six rays; for these rays 'become incrustated with an endless variety of secondary formations of the same kind, some consisting of thin laminae alone, others of solid but translucent prisms heaped one upon another, and others gorgeously combining laminae and prisms in the richest profusion,'⁴ the angles by which these figures are bounded being invariably 60° or 120° . Beautiful arborescent forms are not unfrequently produced by the peculiar mode of aggregation of individual crystals; of this we have often an example on a large scale on a frosted window; but microscopic crystallisations sometimes present the same curious phenomenon (fig. 814). Avanturine, lapis lazuli, crystallised silver, &c. make very good specimens; whilst thin sections of granite, gabbro, and other crystalline rocks, also of agate, aragonite, piedmontite, the zeolites, and other minerals, are very beautiful objects for the polariscope.



FIG. 814.—Crystallised silver.

The actual process of the *formation of crystals* may be watched under the microscope with the greatest facility, all that is necessary being to lay on a slip of glass, previously warmed, a saturated solution of the substance, and to incline the stage in a slight degree, so that the drop shall be thicker at its lower than at its upper edge. The crystallisation will speedily begin at the upper edge, where the proportion of liquid to solid is most quickly reduced by evaporation, and will gradually extend downwards. If it should go on too slowly,

¹ *Physikalische Krystallographie*, Leipzig, 1895.

² *Grundriss der physikalischen Krystallographie*, Leipzig, 1896.

³ *Microscopical Physiography of the Rock-making Minerals*, London, 1895.

⁴ Glaisher on 'Snow-crystals in 1855,' *Quart. Journ. Microsc. Sci.* vol. iii. 1855, p. 179. See also C. A. Hering, *Zeits. f. Kryst.* Bd. xiv. 1888, p. 250.

or should cease altogether, whilst a large proportion of the liquid still remains, the slide may be again warmed, so as to re-dissolve the part already solidified, after which the process will recommence with increased rapidity. This interesting spectacle may be watched under any microscope, but the instrument specially designed by O. Lehmann¹ is particularly adapted to studies of this kind. The degree of heat can be varied at will. The phenomena become far more striking, however, when the crystals, as they come into being, are made to stand out bright upon a dark ground, by the use of the spot lens, the paraboloid, or any other form of black-ground illumination; still more beautiful is the spectacle when the polarising apparatus is employed, so as to invest the crystals with the most gorgeous variety of hues.

By chemically precipitating crystalline products under the microscope we can obtain a still deeper insight into the crystallisation process. One of the earliest workers at this subject was Link,² who observed that precipitates first separate in the form of very minute *liquid* globules, and that these subsequently coagulate to form an undoubtedly crystalline precipitate. Later investigation of the subject by Frankenheim, and then by Vogelsang,³ led to the conclusion that during the passage of a substance from the dissolved to the crystalline state it passes through a whole series of intermediate stages. On allowing sulphur to crystallise very slowly from a carbon bisulphide solution thickened with Canada balsam, the liquid globules, which first separate gradually, solidify to small isotropic spheres termed *globulites*; these embryonic forms then coalesce, yielding regular aggregates known as *crystallites*. The latter subsequently arrange themselves in rows as *margarites*, several of which then amalgamate, forming *longulites*, and the process of aggregation proceeds until at last the *crystalloids*—the first product in which the structure of the crystal itself is traceable—are obtained. The separate existence of so many transition forms has been disputed, notably by Behrens;⁴ but their mention serves the purpose of indicating that the formation of crystalline bodies is really an operation of considerable complexity.

Upon the temperature maintained during crystallisation depends the size and arrangement of the crystals. Thus *santonin*, when crystallising rapidly on a very hot plate, forms large crystals radiating from centres without any undulations; when the heat is less considerable the crystals are smaller, and show concentric waves of very decided form (fig. 815); but when the slip of glass is cool the crystals are exceedingly minute. In the case of cupric sulphate, Mr. R. Thomas⁵ succeeded, by keeping the slide at a temperature of from 80° to 90°, in obtaining most singular and beautiful forms of *spiral* crystallisation, such as that represented in

¹ *Molekularphysik*, 2 vols. Leipzig, 1888 and 1889.

² *Pogg. Ann.* Bd. xlvi. 1839, p. 258.

³ *Die Krystalliten*, Bonn, 1875.

⁴ *Die Krystalliten*, Kiel, 1874.

⁵ See his paper 'On the Crystallisation at various temperatures of the Double Salt, Sulphate of Magnesia and Sulphate of Zinc,' in *Quart. Journ. Microsc. Sci.* n.s. vi. pp. 137, 177. See also H. N. Draper on 'Crystals for the Micro-polariscope,' in *Intellectual Observer*, vol. vi. 1865, p. 437.

fig. 816. Mr. Slack has shown that a great variety of spiral and curved forms can be obtained by dissolving metallic salts, or salicin, santonin, &c., in water containing 3 or 4 per cent. of colloid silica. The nature of the action that takes place may be understood by allowing a drop of the silica solution to dry upon a slide; the result of which will be the production of a complicated series of cracks, many of them curvilinear. When a group of crystals in formation tend to radiate from a centre, the contractions of the silica will often give them a tangential pull. Another action of the silica is to introduce a very slight curling with just enough elevation above the slide to exhibit fragments of Newton's rings, when it is illuminated with Powell and Lealand's modification of Professor

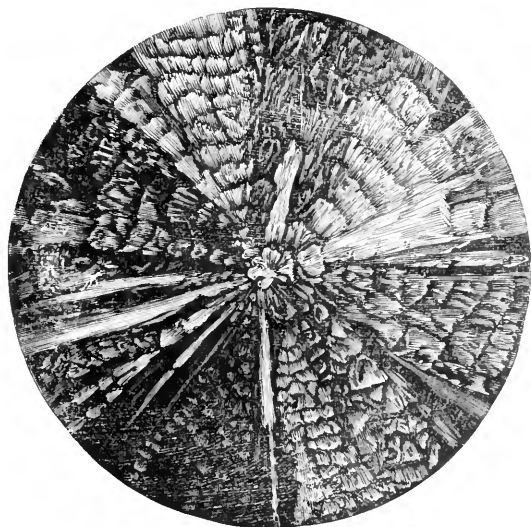

FIG. 815.—Radiating crystallisation of santonin.

Smith's dark-ground illuminator for high powers, and viewed with a $\frac{1}{8}$ th objective. With crystalline substances these actions add to the variety of colours to be obtained with the polariscope, the best slides exhibiting a series of tertiary tints.¹ Very interesting results may often be obtained from a mixture of two or more salts, and some of the double salts give forms of peculiar beauty. O. Lehmann has done excellent work in this department; but reference must be had to his previously mentioned work on 'Molekularphysik' for a description of the phenomena such mixtures exhibit. The following list specifies the salts and other substances whose crystalline forms are most interesting. When these are viewed with polarised light some of them exhibit a beautiful variety of colours of their own, whilst others require the interposition of the selenite plate for

¹ 'On the Employment of Colloid Silica in the preparation of Crystals for the Polariscope,' in *Monthly Microsc. Journ.* v. p. 50.

the development of colour. The substances marked *d* are distinguished by possessing the curious property termed *pleochroism*, which was first noticed by Dr. Wollaston and carefully investigated by Sir D. Brewster. This property, to which was previously applied the misnomer *dichroism*, consists in the exhibition by these crystals of colours varying with the direction in which they are examined: thus, the cube-shaped crystals of magnesium platinocyanide reflect light of a deep red colour from two parallel faces, whilst light of a vivid beetle-green is reflected from the other four faces. Pleochroism is only exhibited by doubly refracting substances, and is caused by the fact that the two plane polarised rays into which a ray passing into the crystal is decomposed, are absorbed selectively—that is to say, the crystalline medium absorbs light of certain colours from the one polarised ray, whilst absorbing quite differently coloured components from the second ray. Pleochroic substances are most easily

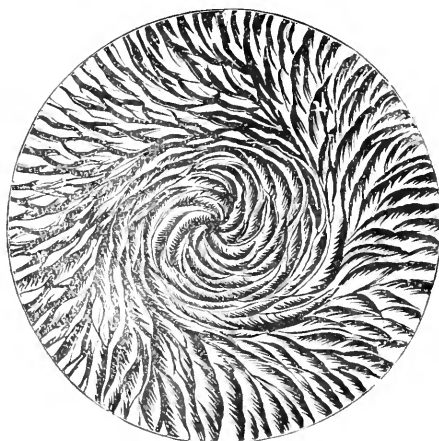

FIG. 816. —Spiral crystallisation of copper sulphate.

recognised by the fact that they change in colour when rotated on the microscope stage in plane polarised light—namely, when only *one* Nicol prism is interposed between the eye and the lamp. It not infrequently happens that a remarkably beautiful specimen of crystallisation develops itself which the observer desires to keep for display. In order to do this successfully, it is necessary to exclude the air; and Mr. Warrington recommends castor oil as the best preservative. A small quantity of this should be poured on the crystallised surface, a gentle warmth applied, and a thin glass cover then laid upon the drop and gradually pressed down; and after the superfluous oil has been removed from the margin a coat of gold-size or other varnish is to be applied. Although most of the objects furnished by vegetable and animal structures, which are advantageously shown by polarised light, have been already noticed in their appropriate places, it will be useful here to recapitulate the principal, with some additions.

Alum	Potassium Hydrogen Carbonate
Ammonium Borate Tartrate
.. Chloride	.. Iodide
.. Hydrogen Tartrate	.. Nitrate
.. Nitrate	.. Oxalate
.. Oxalate	.. Permanganate
.. Oxalurate	.. Sulphate
.. Phosphate	Quinidine
.. Platinoeyanide, <i>d</i>	Quinine Hydriodide
.. Sulphate	Salicin
.. Urate	Saligenin
Asparagine	Santonin
Aspartic Acid	Sodium Acetate
Barium Chloride	.. Borate (borax)
.. Nitrate	.. Carbonate
Bismuth Chloride
Boracic Acid	.. Nitrate
Cadmium Sulphate	.. Oxalate
Calcium Carbonate (from urine of horse)	.. Phosphate
Calcium Hydrogen Tartrate	.. Sulphate
.. Oxalate	.. Tartrate
Cholesterin	.. Urate
Chromic Ammonium Oxalate, <i>d</i>	Stearin
.. Oxalate	Strontium Nitrate
.. Potassium Oxalate, <i>d</i>	Sugar
.. .. Binoxalate	Tartaric Acid
Cinchonidine	Thallium Platinichloride
Citric Acid	Uranium Nitrate
Cobalt Chloride	Uric Acid
Cupric Acetate, <i>d</i>	Zinc Acetate
.. Ammonium Chloride	.. Sulphate
.. .. Sulphate	
.. Magnesium ..	<i>Vegetable</i>
.. Potassium ..	Cuticles, Hairs, and Scales, from Leaves
.. Nitrate	Fibres of Cotton and Flax
.. Sulphate	Raphides
Ferrous Cobalt Sulphate	Spiral cells and vessels
.. Sulphate	Starch-grains
Hippuric Acid	Wood, longitudinal sections of, mounted in balsam
Lead Phosphate, <i>d</i>	
Magnesium Ammonium Phosphate (from urine)	<i>Animal</i>
Magnesium Sulphate	Fibres and Spicules of Sponges
Manganese Acetate	Polypidoms of Hydrozoa
Mannitol	Spicules of Gorgoniae
Margarine	Polyzoaries
Mercuric Chloride	Tongues (Palates) of Gasteropods mounted in balsam
.. Cyanide	Cuttle-fish bone
Murexide	Scales of Fishes
Nickel Sulphate	Sections of Egg-shells
Oxalic Acid	.. Hairs
Potassium Arsenate	.. Quills
.. Carbonate	.. Horns
.. Chlorate	.. of Shells
.. Chromate	.. Skin
.. Dichromate	.. Teeth
.. Ferrieyanide	.. Tendon, longitudinal
.. Ferrocyanide	

Molecular Coalescence.—Remarkable modifications are shown

in the ordinary forms of crystallisable substances, when the aggregation of the inorganic particles takes place in the presence of certain kinds of organic matter; and a class of facts of great interest in their bearing upon the mode of formation of various calcified structures in the bodies of animals was brought to light by the ingenious researches of Mr. Rainey,¹ whose method of experimenting essentially consisted in bringing about a slow decomposition of the calcium salts contained in gum-arabic by the agency of potassium hydrogen carbonate. The result is the formation of spheroidal concretions of calcium carbonate, which progressively increase in diameter at the expense of an amorphous deposit which at first intervenes between them, two such spherules sometimes coalescing to produce 'dumb-bells,' whilst the coalescence of a larger number gives rise to the mulberry-like body shown in fig. 817, *b*. The particles of such composite spherules appear subsequently to undergo rearrangement according to a definite plan of which the stages are shown at *c* and *d*: and it is upon this plan that the further increase takes place, by which such larger con-

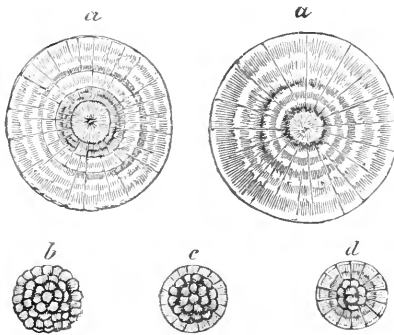

FIG. 817.—Artificial concretions of carbonate of lime.

cretions as are shown at *a*, *a* are gradually produced. The structure of these, especially when examined by polarised light, is found to correspond very closely with that of the small calculous concretions which are common in the urine of the horse, and which were at one time supposed to have a matrix of cellular structure. The small calcareous concretions termed *otoliths*, or ear-stones, found in the auditory sacs of fishes, present an arrangement of their particles essentially the same.

Similar concretionary spheroids have already been mentioned as occurring in the skin of the shrimp and other imperfectly calcified shells of Crustacea; they occur also in certain imperfect layers of the shells of Mollusca; and we have a very good example of them in the outer layer of the envelope of what is commonly known as a 'soft egg,' or an 'egg without shell,' the calcareous deposit in the fibrous matting already described being here insufficient to solidify it. In the external layer of an ordinary egg-shell, on the other hand, the concretions have enlarged themselves by the progressive accretion of calcareous particles, so as to form a continuous layer, which consists of a series of polygonal plates resembling those of a tessellated pavement. In the solid 'shells' of the eggs of the

¹ See his treatise 'On the Mode of Formation of the Shells of Animals, of Bone, and of several other structures, by a process of Molecular Coalescence, demonstrable in certain artificially formed products,' 1858; and his 'Further Experiments and Observations' in *Quart. Journ. Microsc. Sci.* n.s. vol. i. 1861, p. 23.

ostrich and cassowary this concretionary layer is of considerable thickness; and vertical as well as horizontal sections of it are very interesting objects, showing also beautiful effects of colour under polarised light. And from the researches of Professor W. C. Williamson on the scales of fishes, there can be no doubt that much of the calcareous deposit which they contain is formed upon the same plan.

This line of inquiry has been contemporaneously pursued by Professor Harting, of Utrecht, who, working on a plan fundamentally the same as that of Mr. Rainey (viz. the slow precipitation of insoluble calcium salts in the presence of an organic 'colloid'), has not only confirmed but greatly extended his results, showing that with *animal* colloids (such as egg-albumen, blood-serum, or a solution of gelatine) a much greater variety of forms may be thus produced, many of them having a strong resemblance to calcareous structures hitherto known only as occurring in the bodies of animals of various classes. The mode of experimenting usually followed by Professor Harting was to cover the hollow of an ordinary porcelain plate with a layer of the organic liquid to the depth of from 0.4 to 0.6 of an inch, and then to immerse in the border of the liquid, but at diametrically opposite points, the solid salts intended to act on one another by double decomposition, such as calcium chloride, nitrate, or acetate, and potassium or sodium carbonate; so that, being very gradually dissolved, the two substances may come slowly to act upon each other, and may throw down their precipitate in the midst of the 'colloid.' The whole is then covered with a plate of glass, and left for some days in a state of perfect tranquillity; when there begins to appear at various spots on the surface minute points reflecting light, which gradually increase and coalesce, so as to form a crust that comes to adhere to the border of the plate; whilst another portion of the precipitate subsides, and covers the bottom of the plate. Round the two spots where the salts are placed in the first instance the calcareous deposits have a different character: so that in the same experiment several very distinct products are generally obtained, each in some particular spot. The length of time requisite is found to vary with the temperature, being generally from two to eight weeks. By the introduction of such a colouring matter as madder, logwood, or carmine, the concretions take the hue of the one employed. When these concretions are treated with dilute acid, so that their calcareous particles are wholly dissolved out, there is found to remain a basis substance which preserves the form of each; this, which consists of the 'colloid' somewhat modified, is termed by Harting *calco-globuline*. Besides the globular concretions with the peculiar concentric and radiating arrangement obtained by Mr. Rainey (fig. 817), Professor Harting obtained a great variety of forms bearing some resemblance to the following: 1. The 'discoliths' and 'cyatholiths' of Huxley. 2. The tuberculated 'spicules' of *Alcyonaria*, and the very similar spicules in the mantle of some species of *Doris*. 3. Lamellæ of 'prismatic shell-substance,' which are very closely imitated by crusts formed of flattened polyhedra, found on the surface of the 'colloid.' 4. The spheroidal concretions which form a sort of rudimentary shell within

the body of *Limax*. 5. The sinuous lamellæ which intervene between the parallel plates of the 'sépiostaire' of the *cuttle-fish*, the imitation of this being singularly exact. 6. The calcareous concretions that give solidity to the 'shell' of the bird's egg, the semblance of which Professor Harting was able to produce *in situ* by dissolving away the calcareous component of the egg-shell by dilute acid, then immersing the entire egg in a concentrated solution of calcium chloride, and transferring it thence to a concentrated solution of potassium carbonate, with which, in some cases, a little sodium phosphate was mixed.¹ Other forms of remarkable regularity and definiteness, differing entirely from anything that ordinary crystallisation would produce, but not known to have their parallels in living bodies, have been obtained by Professor Harting. Looking to the relations between the calcareous deposits in the scales of fishes and those by which bones and teeth are solidified, it can scarcely be doubted that the principle of 'molecular coalescence' is applicable to the latter, as well as to the former; and that an extension and variation of this method of experimenting would throw much light on the process of ossification and tooth formation. The connection of these results with the work of Vogelsang (p. 1096) on globulites and other embryonic crystalline forms is obvious. The inquiry has been further prosecuted by Dr. W. M. Ord, with express reference to the formation of urinary and other calculi.²

Micro-chemical Analysis.—The methods which serve for the qualitative analysis of chemical substances, and which are based upon the reactions shown by such substances when treated with solutions of various reagents, have been applied by numbers of workers to the identification of the constituents of a material by the aid of chemical reactions, the results of which are traced upon the microscope stage. Thus a very complete scheme has been worked out by H. Behrens for the detection of the constituents of inorganic compounds,³ and a somewhat similar, although naturally less comprehensive, scheme has been given by the same author for the identification of organic compounds.⁴ The analytical methods are intended primarily to serve for identifying the components of a material available only in small quantities; but in many cases the micro-chemical method is more rapidly applied, and is more accurate in its results, than the ordinary processes of qualitative analysis. In applying the microscope for this purpose the substance to be examined is placed upon a watch-glass or glass slide, either in the solid state or in the form of a solution; the various crystalline forms which make their appearance as a result of the addition of different reagents are then noted, and from the information thus obtained a knowledge of the constituents of the original substance is deduced. A very important application of micro-chemical analysis

¹ See Prof. Harting's *Recherches de Morphologie synthétique sur la production artificielle de quelques Formations Calcaires Inorganiques*, publiées par l'Académie Royale Néerlandaise des Sciences, Amsterdam, 1872; and *Quart. Journ. Microsc. Sci.* xiii. p. 118.

² See his treatise *On the Influence of Colloids upon Crystalline Form and Cohesion*, London, 1879.

³ *Anleitung zur mikrochemischen Analyse*, Hamburg, 1895.

⁴ *Mikrochemischen Analyse der organischen Verbindungen*, Hamburg, 1895.

has been made in connection with the detection of poisons, and by a judicious combination of microscopical with chemical research, the application of reagents may be made effectual for the detection of poisonous or other substances in quantities far more minute than have been previously supposed to be recognisable. Thus it is stated by Dr. Wornley¹ that micro-chemical analysis enables us by a very few minutes' labour to recognise with unerring certainty the reaction of the $\frac{1}{1000000}$ th part of a grain of either hydrocyanic acid, mercury, or arsenic; and that in many other instances we can easily detect by its means the presence of very minute quantities of substances, the true nature of which could only be otherwise determined in comparatively large quantity, and by considerable labour. This inquiry may be prosecuted, however, not only by the application of ordinary chemical tests under the microscope, but also by the use of other means of recognition which the use of the microscope affords. Thus it has been shown that by the careful sublimation of arsenic and arsenious acid, the sublimate being deposited upon small discs of thin glass, these are distinctly recognisable by the forms they present under the microscope (especially the binocular) in extremely minute quantities; and that the same method of procedure may be applied to the volatile elements, mercury, cadmium, selenium, tellurium, and some of their compounds, and to some other volatile bodies, as sal-ammoniac, camphor, and sulphur. The method of sublimation was afterwards extended to the vegetable alkaloids, such as morphine, strychnine, veratrine,² &c. And subsequently it was shown that the same method could be further extended to such animal products as the constituents of the blood and of urine, and to volatile and decomposable organic substances generally. By the careful prosecution of micro-chemical inquiry, especially with the aid of the spectroscope (where possible), the detection of poisons and other substances in very minute quantity can be accomplished with a facility and certainty such as were formerly scarcely conceivable.

¹ *Micro-chemistry of Poisons*, New York, 1857.

² See Wynter Blyth, *Poisons, their Effects and Detection*, London, 1895.

APPENDICES AND TABLES

USEFUL TO THE MICROSCOPIST

APPENDIX A

TABLE OF NATURAL SINES

°	0'	15'= $\frac{1}{4}$ °	30'= $\frac{1}{2}$ °	45'= $\frac{3}{4}$ °	°	0'	15'= $\frac{1}{4}$ °	30'= $\frac{1}{2}$ °	45'= $\frac{3}{4}$ °
0	·0000	·0044	·0087	·0131	46	·7193	·7224	·7254	·7284
1	·0175	·0218	·0262	·0305	47	·7314	·7343	·7373	·7402
2	·0349	·0393	·0436	·0480	48	·7431	·7461	·7490	·7518
3	·0523	·0567	·0610	·0654	49	·7547	·7576	·7604	·7632
4	·0698	·0741	·0785	·0828	50	·7660	·7688	·7716	·7744
5	·0872	·0915	·0958	·1002	51	·7771	·7799	·7826	·7853
6	·1045	·1089	·1132	·1175	52	·7880	·7907	·7934	·7960
7	·1219	·1262	·1305	·1349	53	·7986	·8013	·8039	·8064
8	·1392	·1435	·1478	·1521	54	·8090	·8116	·8141	·8166
9	·1564	·1607	·1650	·1693	55	·8192	·8216	·8241	·8266
10	·1736	·1779	·1822	·1865	56	·8290	·8315	·8339	·8363
11	·1908	·1951	·1994	·2036	57	·8387	·8410	·8434	·8457
12	·2079	·2122	·2164	·2207	58	·8480	·8504	·8526	·8549
13	·2250	·2292	·2334	·2377	59	·8572	·8594	·8616	·8638
14	·2419	·2462	·2504	·2546	60	·8660	·8682	·8704	·8725
15	·2588	·2630	·2672	·2714	61	·8746	·8767	·8788	·8809
16	·2756	·2798	·2840	·2882	62	·8829	·8850	·8870	·8890
17	·2924	·2965	·3007	·3049	63	·8910	·8930	·8949	·8969
18	·3090	·3132	·3173	·3214	64	·8988	·9007	·9026	·9045
19	·3256	·3297	·3338	·3379	65	·9063	·9081	·9100	·9118
20	·3420	·3461	·3502	·3543	66	·9135	·9153	·9171	·9188
21	·3584	·3624	·3665	·3706	67	·9205	·9222	·9239	·9255
22	·3746	·3786	·3827	·3867	68	·9272	·9288	·9304	·9320
23	·3907	·3947	·3987	·4027	69	·9336	·9351	·9367	·9382
24	·4067	·4107	·4147	·4187	70	·9397	·9412	·9426	·9441
25	·4226	·4266	·4305	·4344	71	·9455	·9469	·9483	·9497
26	·4384	·4423	·4462	·4501	72	·9511	·9524	·9537	·9550
27	·4540	·4579	·4617	·4656	73	·9563	·9576	·9588	·9600
28	·4695	·4733	·4772	·4810	74	·9613	·9625	·9636	·9648
29	·4848	·4886	·4924	·4962	75	·9659	·9670	·9681	·9692
30	·5000	·5038	·5075	·5113	76	·9703	·9713	·9724	·9734
31	·5150	·5188	·5225	·5262	77	·9744	·9753	·9763	·9772
32	·5299	·5336	·5373	·5410	78	·9781	·9790	·9799	·9808
33	·5446	·5483	·5519	·5556	79	·9816	·9825	·9833	·9840
34	·5592	·5628	·5664	·5700	80	·9848	·9856	·9863	·9870
35	·5736	·5771	·5807	·5842	81	·9877	·9884	·9890	·9897
36	·5878	·5913	·5948	·5983	82	·9903	·9909	·9914	·9920
37	·6018	·6053	·6088	·6122	83	·9925	·9931	·9936	·9941
38	·6157	·6191	·6225	·6259	84	·9945	·9950	·9954	·9958
39	·6293	·6327	·6361	·6394	85	·9962	·9966	·9969	·9973
40	·6428	·6461	·6494	·6528	86	·9976	·9979	·9981	·9984
41	·6561	·6593	·6626	·6659	87	·9986	·9988	·9990	·9992
42	·6691	·6724	·6756	·6788	88	·9994	·9995	·9997	·9998
43	·6820	·6852	·6884	·6915	89	·9998	·9999	1·0000	1·0000
44	·6947	·6978	·7009	·7040	90	1·0000			
45	·7071	·7102	·7133	·7163					

Note.—The sine of any given angle is the length of the perpendicular opposite the given angle in a right-angled triangle which contains the given angle divided by the length of the hypotenuse. The above table is constructed on the principle that the hypotenuse is always equal to unity, by which means the fraction is got rid of, as the denominator may be left out. Thus,

$$\sin 30^\circ = \frac{\text{perpendicular}}{\text{hypotenuse}} = \frac{1}{2} = .5.$$

APPENDIX B

TABLE OF REFRACTIVE INDICES

Substance	Refractive Index	$\frac{\mu-1}{\delta \mu}$
Water	μ D 1.334	54.7
Saliva	μ E 1.339	—
Sea-water	μ E 1.343	—
Human blood	μ E 1.354	—
Alum (sat. sol.)	μ D 1.457	—
Ether (60° Fahr.)	μ D 1.357	84.9
Albumen	μ D 1.350	—
Absolute Alcohol	μ D 1.364	58.6
Oil of Ambergris	μ E 1.368	—
Salt (sat. sol.)	μ E 1.375	—
Fluor Spar	μ D 1.4338	97.3
Diatom Silex	μ D 1.434	—
Spermaceti	μ D 1.503	—
Bees-wax	μ D 1.553	—
Oil of Olives (sp. gr. 0.913)	μ D 1.476	54.7
Borax	μ D 1.515	60.6
Naphtha	μ E 1.475	—
Oil of Turpentine (sp. gr. .885)	μ D 1.474	46.5
Oil of Linseed (sp. gr. .932)	μ D 1.485	—
Castor Oil	μ D 1.490	—
Chloride of Tin	μ D 1.503	—
Oil of Cinnamon	μ D 1.619	14.3
Oil of Cedar	μ D 1.510	—
Gum Arabic	μ E 1.512	—
Dammar	μ D 1.520	—
Oil of Cloves	μ D 1.533	—
Sugar	μ D 1.535	—
Felspar	μ D 1.764	—
Cedrene	μ D 1.539	—
Canada Balsam	μ D 1.526	41.5
Oil of Fennel	μ D 1.544	—
Rock Crystal	μ D 1.545	70.0
Rock Salt (sp. gr. 2.143)	μ D 1.555	—
Nitro-benzene	μ D 1.558	—
Styrax	μ D 1.582	—
Meta-cinnamene	μ D 1.597	29.8
Quinidine	μ D 1.602	24.1
Benzylaniline	μ D 1.611	—
Methyldiphenylamine	μ D 1.616	—
Balsam of Tolu	μ E 1.618	—
Bisulphide of Carbon	μ D 1.630	18.3
Oil of Cassia	μ D 1.578	17.0
Quinoline	μ D 1.633	—
Tourmalin (ordinary ray)	μ D 1.668	—
Kreasote	μ D 1.538	29.9
Petroleum	μ D 1.457	15.3
Phenyl-thiocarbimide	μ D 1.654	18.7
Iceland Spar (ordinary ray)	μ D 1.657	49.0

Substance	Refractive Index	$\frac{\mu-1}{\delta \mu}$
Monobromonaphthalene	μ_D 1.658	19.9
Piperine and Balsam	μ_D 1.657	—
Naphthyl-phenyl-ketone	μ_D 1.669	17.6
Bromide of Antimony (approximately)	μ_D 1.680	—
Piperine	μ_D 1.681	9.88
Methylene di-iodide	μ_D 1.743	21.2
Sulphur in methylene di-iodide	μ_D 1.778	—
Zircon	μ_D 1.950	—
Carbonate of Lead	μ_D 1.81 to 2.08	—
Borate of Lead	μ_A 1.866	—
Phosphorus in methylene di-iodide (equal weights)	μ_D 1.944	17.1
Sulphur (melted)	μ_E 2.148	—
Phosphorus	μ_D 2.224	—
Diamond (sp. gr. 3.4)	μ_D 2.47	—
Chromate of Lead	μ_D 2.50 to 2.97	—
Realgar (artificial)	μ_E 2.549	—

Glass

Substance	Refractive Index	$\frac{\mu-1}{\delta \mu}$	
Crown	μ_D 1.51 to 1.56	59.0 to 46.0	
Plate	μ_D 1.516	—	
Extra Light Flint	μ_D 1.541	49.2	
Light Flint	μ_D 1.574	41.0	
Dense Flint	μ_D 1.622	36.5	
Extra Dense Fluid	μ_D 1.650	34.2	
Double Extra Dense Flint	μ_D 1.710	30.0	
Jena Glass {	Boro-silicate Crown	μ_D 1.51	64.0
	Phosphate Crown	μ_D 1.51 to 1.56	70.0 to 67.0
	Barium Silicate Crown	μ_D 1.54 ,, 1.60	59.0 ,, 55.0
	Boro-silicate Flint	μ_D 1.55 ,, 1.57	49.0 ,, 47.0
	Borate Flint	μ_D 1.55 ,, 1.68	55.0 ,, 33.0
	Barium Phosphate Crown	μ_D 1.58	65.2
	Very heavy Silicate Flint	μ_D 1.963	19.7
Glass of Antimony	μ_D 2.216	—	

The extraordinary dispersion of the alkaloid Piperine will be noticed. Its refractive index is *less* than that of Chance's Double Extra Dense Flint, yet Piperine has *three times* its dispersion.

APPENDIX C

TABLE OF ENGLISH MEASURES AND WEIGHTS, WITH THEIR METRICAL EQUIVALENTS

The following are calculated from the values of the metre, determined in 1896, and the kilogramme in 1883, by the order of the Board of Trade.

LENGTH

Inch	= 2·539998 Centimetres.
Foot = 12 inches	= 3·047997 Decimetres.
Yard = 3 feet	= ·914399 Metre.
Fathom = 2 yards	= 1·828798 „
Pole = 5½ yards	= 5·029196 Metres.
Chain = 4 poles	= 2·011678 Decametres.
Furlong = 10 chains	= 2·011678 Hectometres.
Statute Mile = 8 furlongs = 5,280 feet	= 1·609343 Kilometre.
Geographical Mile = 6,087·23 feet	= 1·855386 „
Knot = 6,080 feet	= 1·853182 „

SUPERFICIES

Square Inch	= 6·45159 Square Centimetres.
„	= ·00645 Milliare.
„ Foot = 144 Sq. Inches	= ·92903 „
„ Yard = 9 „ Feet	= 8·36126 Milliaries.
„	= ·83613 Centiare.
Perch = 30¼ „ Yards	= 2·52928 Deciares.
Rood = 40 Perches	= 10·11712 Ares.
Acre = 4 Roods	= 40·46849 „
Square Mile	= 258·99836 Hectares.

VOLUME

Cubic Inch	= 16·387 Cubic Centimetres.
„ Foot	= 1728 Cubic Inches = 2·83168 Centisteres.
„ Yard	= 27 „ Feet = 7·64553 Decisteres.

CAPACITY

Apothecaries'

Minim, \mathfrak{m}	= ·05919 Cubic Centimetre or Millilitre.
Drachm, $\mathfrak{f}\bar{\mathfrak{s}}$ = 60 \mathfrak{m}	= 3·5515 „ Centimetres or Millilitres.
Ounce, $\mathfrak{f}\bar{\mathfrak{s}}$ = 8 $\mathfrak{f}\bar{\mathfrak{s}}$	= 28·4123 „ „ = 2·84123 Centilitres.
Pint, O	= 20 $\mathfrak{f}\bar{\mathfrak{s}}$ = 568·245 „ „ = 5·68245 Decilitres.
Gallon, C	= 8 O = 4·54596 „ Decimetres, Millisteres, or Litres.

Imperial

Gill	= 142·061 Cubic Centimetres = 1·42061 Decilitre.
Pint	= 4 gills = 568·245 „ „ = 5·68245 Decilitres.
Quart	= 2 pints = 1·13649 „ Decimetre, Millistere, or Litre.
Gallon	= 4 quarts = 4·54596 „ Decimetres, Millisteres, or Litres.
Peck	= 2 gallons = 9·09193 „ „ „
Bushel	= 4 pecks = 3·63677 Decalitre.
Quarter	= 8 bushels = 2·90942 Hectolitres.

WEIGHT

Apothecaries'

Grain, gr.	= 6·479892	Centigrammes.
Scruple, ℥	= 20 gr. = 1·29598	Gramme.
Drachm, ℥	= 3 ℥ = 60 gr. = 3·88794	Grammes.
Ounce, ℥	= 8 ℥ = 480 gr. = 3·11035	Decagrammes.

Avoirdupois

Grain, gr.	= 6·479892	Centigrammes.
Drachm, dr.	= 27·34375 gr. = 1·77185	Gramme.
Ounce, oz.	= 16 dr. = 437·5 gr. = 2·83495	Decagrammes.
Pound, lb.	= 16 oz. = 7000 gr. = 4·5359243	Hectogrammes.
Stone, st.	= 14 lb.	= 6·35029 Kilogrammes.
Quarter, qr.	= 28 lb.	= 12·70059 "
Hundredweight, cwt. = 4 qr.	= 50·80235 = 50802	Quintal.
Ton	= 20 cwt.	= 1·01605 Tonne.

1 lb. Avoirdupois = ·822857 lb. Troy or Apothecaries'.

1 lb. Troy or Apothecaries = 1·21527 lb. Avoirdupois.

TABLE OF METRIC MEASURES AND WEIGHTS, WITH THEIR ENGLISH EQUIVALENTS

The metre was originally intended to be the $\frac{1}{10000000}$ th part of the distance from the pole of the earth to the equator, measured along a certain meridian, but owing to an error its length is too short. The metre is therefore the length of a definite standard in Paris.

LENGTH

Micron, i.e. μ	= $\frac{1}{10000}$ Millimetre	= ·00003937	Inch.
Millimetre	= $\frac{1}{10}$ Centimetre	= ·03937	"
Centimetre	= $\frac{1}{10}$ Decimetre	= ·39370	"
Decimetre	= $\frac{1}{10}$ Metre	= 3·93701	Inches.
METRE	= Unit	= 3·28684	Feet.
		= 1·093614	Yard.
Decametre	= 10 Metres	= 1·98839	Pole.
Hectometre	= 10 Decametres	= 4·97097	Chains.
Kilometre	= 10 Hectometres	= 4·97097	Furlongs.
		= ·6213716	Statute Mile.
		= ·5389714	Geographical Mile.
		= ·5396124	Knot.

SUPERFICIES

Milliare	= 10 Sq. Decimetres = 1·07639	Sq. Ft. = 155·0006	Sq. In.
Centiare	= 1 " Metre = 1·19599	Square Yard.	
Deciare	= 10 " Metres = 11·95992	" Yards.	
Are = Unit	= 1 " Decametre = 119·59921	" "	
Hectare	= 1 " Hectometre = 2·47106	Acres.	

VOLUME

Millistere	= 1 Cubic Decimetre = 61·0239	Cubic Inches.
Centistere	= 10 " Decimetres = 610·239	" "
Decistere	= 100 " " " = 3·531476	" Feet.
Stere = Unit	= 1 " Metre = 1·30795	" Yard.
Decastere	= 10 " Metres = 13·07954	" Yards.
Hectostere	= 10 Decasteres = 130·7954	" "

CAPACITY

Millilitre = Cubic Centimetre	=	·007039	Impr. Gill.
Centilitre = 10 Cubic Centimetres	=	·07039	„ „
Decilitre = 100 „ „	=	·7039	„ „
Litre . = Millistere	=	1·7598	„ Pint.
Decalitre = 10 Litres	=	2·19975	„ Gals.
Hectolitre = 10 Decalitres	=	2·74969	„ Bush.
Kilolitre = 10 Hectolitres = 1 Stere = 1 Cubic Metre	=	3·43712	„ Qrs.

WEIGHT

		<i>Avoirdupois</i>	
Milligramme = $\frac{1}{10}$ Centigramme	=	·01543	Grain.
Centigramme = $\frac{1}{10}$ Decigramme	=	·15432	„
Decigramme = $\frac{1}{10}$ Gramme	=	1·54324	„
Gramme . . = Unit	=	15·432356	Grains.
Decagramme = 10 Grammes	=	5·64383	dr.
Hectogramme = 10 Decagrammes	=	3·5274	oz.
Kilogramme = 10 Hectogrammes	=	2·204622	lb.
Myriagramme = 10 Kilogrammes	=	22·04622	„
Quintal . . = 10 Myriagrammes	=	1·96841	cwt.
Tonneau . . = 10 Quintals	=	·98421	ton.

The legal equivalent of the metre is 39·37079 inches, and of the kilogramme 15432·34874 grains. In the above tables the values obtained in 1883 and 1896 by the order of the Board of Trade have been adopted as being the more accurate. In 1893 the metre was measured by Rogers, who found it equal to 39·370155 inches.

Weights can be more accurately compared than either lengths or capacities. The actual weight of the standard kilogramme in Paris is 15432·35639 grains, and the English avoirdupois pound is equal to 453·5924277 grammes.

CONVERSION OF BRITISH AND METRIC MEASURES

Computed by Mr. E. M. Nelson from the New Coefficient obtained by Order of the Board of Trade in 1896.

LINEAL.

Metric into British.

μ	ins.	mm.	ins.	mm.	ins.
1	·000039	1	·039370	51	2·007876
2	·000079	2	·078740	52	2·047246
3	·000118	3	·118110	53	2·086616
4	·000157	4	·157480	54	2·125986
5	·000197	5	·196851	55	2·165356
6	·000236	6	·236221	56	2·204726
7	·000276	7	·275591	57	2·244096
8	·000315	8	·314961	58	2·283467
9	·000354	9	·354331	59	2·322837
10	·000394	10	·393701	60	2·362207
11	·000433	11	·433071	61	2·401577
12	·000472	12	·472441	62	2·440947
13	·000512	13	·511811	63	2·480317
14	·000551	14	·551182	64	2·519687
15	·000591	15	·590552	65	2·559057
16	·000630	16	·629922	66	2·598427
17	·000669	17	·669292	67	2·637798
18	·000709	18	·708662	68	2·677168
19	·000748	19	·748032	69	2·716538
20	·000787	20	·787402	70	2·755908
21	·000827	21	·826772	71	2·795278
22	·000866	22	·866142	72	2·834648
23	·000906	23	·905513	73	2·874018
24	·000945	24	·944883	74	2·913388
25	·000984	25	·984253	75	2·952758
26	·001024	26	1·023623	76	2·992129
27	·001063	27	1·062993	77	3·031499
28	·001102	28	1·102363	78	3·070869
29	·001142	29	1·141733	79	3·110239
30	·001181	30	1·181103	80	3·149609
31	·001220	31	1·220473	81	3·188979
32	·001260	32	1·259844	82	3·228349
33	·001299	33	1·299214	83	3·267719
34	·001339	34	1·338584	84	3·307089
35	·001378	35	1·377954	85	3·346459
36	·001417	36	1·417324	86	3·385829
37	·001457	37	1·456694	87	3·425199
38	·001496	38	1·496064	88	3·464570
39	·001535	39	1·535434	89	3·503940
40	·001575	40	1·574805	90	3·543310
41	·001614	41	1·614175	91	3·582680
42	·001654	42	1·653545	92	3·622050
43	·001693	43	1·692915	93	3·661420
44	·001732	44	1·732285	94	3·700791
45	·001772	45	1·771655	95	3·740161
46	·001811	46	1·811025	96	3·779531
47	·001850	47	1·850395	97	3·818901
48	·001890	48	1·889765	98	3·858271
49	·001929	49	1·929136	99	3·897641
50	·001969	50	1·968506		
60	·002362				
70	·002756				
80	·003150				
90	·003543				
100	·003937				
200	·007874				
300	·011811				
400	·015748				
500	·019685				
600	·023622				
700	·027559				
800	·031496				
900	·035433				
1000	(= 1 mm.)				
			decim.		ins.
			1		3·9370113
			2		7·8740226
			3		11·8110339
			4		15·7480452
			5		19·6850565
			6		23·6220678
			7		27·5590791
			8		31·4960904
			9		35·4331017
			1 metre		3·2808428 ft.
					1·09361425 yd.

British into Metric.

in.	mm.	in.	mm.	in.	mm.
1	25·399978	$\frac{1}{11}$	2·309089	$\frac{1}{85}$	·298823
2	50·799956	$\frac{1}{12}$	2·116665	$\frac{1}{90}$	·282222
3	76·199934	$\frac{5}{12}$	10·583324	$\frac{1}{95}$	·267368
4	101·599912	$\frac{1}{13}$	14·816654	$\frac{1}{100}$	·254000
5	126·999890	$\frac{11}{13}$	23·283313	$\frac{1}{150}$	·169333
6	152·399868	$\frac{1}{14}$	1·953844	$\frac{1}{200}$	·127000
7	177·799846	$\frac{1}{15}$	1·814284	$\frac{1}{250}$	·101600
8	203·199824	$\frac{1}{16}$	1·693332	$\frac{1}{300}$	·084667
9	228·599802	$\frac{1}{16}$	1·587499	$\frac{1}{350}$	·072571
10	253·999780	$\frac{5}{16}$	4·762496	$\frac{1}{400}$	·063500
11	279·399758	$\frac{5}{16}$	7·937493	$\frac{1}{450}$	·056444
1 ft.	304·799736	$\frac{7}{16}$	11·112490	$\frac{1}{500}$	·050800
1 yd.	914·399208	$\frac{9}{16}$	14·287487	$\frac{1}{550}$	·046182
		$\frac{10}{16}$	17·462485	$\frac{1}{600}$	·042333
in.	mm.	$\frac{13}{16}$	20·637482	$\frac{1}{650}$	·039077
$\frac{1}{2}$	12·699989	$\frac{15}{16}$	23·812479	$\frac{1}{700}$	·036286
$\frac{3}{4}$	8·466659	$\frac{1}{17}$	1·494116	$\frac{1}{750}$	·033867
$\frac{1}{4}$	16·933319	$\frac{1}{18}$	1·411110	$\frac{1}{800}$	·031750
$\frac{1}{8}$	6·349994	$\frac{1}{19}$	1·336841	$\frac{1}{850}$	·029882
$\frac{1}{16}$	19·049983	$\frac{1}{20}$	1·269999	$\frac{1}{900}$	·028222
$\frac{1}{32}$	5·079996	$\frac{1}{21}$	1·209523	$\frac{1}{950}$	·026737
$\frac{1}{64}$	10·159991	$\frac{1}{22}$	1·154544		
$\frac{1}{128}$	15·239987	$\frac{1}{23}$	1·104347	in.	μ
$\frac{1}{256}$	20·319982	$\frac{1}{24}$	1·058332	$\frac{1}{1000}$	25·399978
$\frac{1}{512}$	4·233330	$\frac{1}{25}$	1·015999	$\frac{1}{2000}$	12·699989
$\frac{1}{1024}$	21·166648	$\frac{1}{30}$	·846666	$\frac{1}{3000}$	8·466659
$\frac{1}{2048}$	3·628568	$\frac{1}{35}$	·725714	$\frac{1}{4000}$	6·349994
$\frac{1}{4096}$	3·174997	$\frac{1}{40}$	·634999	$\frac{1}{5000}$	5·079996
$\frac{1}{8192}$	9·524992	$\frac{1}{45}$	·564444	$\frac{1}{6000}$	4·233330
$\frac{1}{16384}$	15·874986	$\frac{1}{50}$	·508000	$\frac{1}{7000}$	3·628568
$\frac{1}{32768}$	22·224980	$\frac{1}{55}$	·461818	$\frac{1}{8000}$	3·174997
$\frac{1}{65536}$	2·822220	$\frac{1}{60}$	·423333	$\frac{1}{9000}$	2·822220
$\frac{1}{131072}$	2·539998	$\frac{1}{65}$	·390769	$\frac{1}{10000}$	2·539998
$\frac{1}{262144}$	7·619993	$\frac{1}{70}$	·362857	$\frac{1}{15000}$	1·693332
$\frac{1}{524288}$	17·779985	$\frac{1}{75}$	·338666	$\frac{1}{20000}$	1·269999
$\frac{1}{1048576}$	22·859980	$\frac{1}{80}$	·317500	$\frac{1}{25000}$	1·015999

TABLE FOR THE CONVERSION OF FRACTIONAL PARTS OF AN ENGLISH INCH INTO METRICAL LINEAR MEASURE.

1 ÷	mm.	1 ÷	Micra.	1 ÷	Micra.	1 ÷	Micra.
2	12.70	33	770	66	385	99	256
3	8.47	34	747	67	379	100	254
4	6.35	35	726	68	374	105	242
5	5.08	36	706	69	368	110	231
6	4.23	37	686	70	363	115	221
7	3.63	38	668	71	358	120	212
8	3.17	39	651	72	353	125	203
9	2.82	40	635	73	348	130	195
10	2.54	41	619	74	343	135	188
11	2.31	42	605	75	339	140	181
12	2.12	43	591	76	334	145	175
13	1.95	44	577	77	330	150	169
14	1.81	45	564	78	326	155	164
15	1.69	46	552	79	321	160	159
16	1.59	47	540	80	317	165	154
17	1.49	48	529	81	314	170	149
18	1.41	49	518	82	310	175	145
19	1.34	50	508	83	306	180	141
20	1.27	51	498	84	302	185	137
21	1.21	52	488	85	299	190	134
22	1.15	53	479	86	295	195	130
23	1.10	54	470	87	292	200	127
24	1.06	55	462	88	289	205	124
25	1.02	56	454	89	285	210	121
		57	445	90	282	215	118
	Micra.	58	438	91	279	220	115
26	977	59	430	92	276	225	113
27	941	60	423	93	273	230	110
28	907	61	416	94	270	235	108
29	876	62	410	95	267	240	106
30	847	63	403	96	265	245	104
31	819	64	397	97	262	250	102
32	794	65	391	98	259		

Lines per inch	Lines in mm.	Lines per inch	Lines in mm.	Fractions of an inch	μ
5,000	197	200,000	7,874	1-5,000th	5.08
10,000	394	210,000	8,268	10,000	2.54
15,000	591	220,000	8,661	20,000	1.27
20,000	787	230,000	9,055	30,000	.847
25,000	984	240,000	9,449	40,000	.635
30,000	1,181	250,000	9,843	50,000	.508
35,000	1,378	260,000	10,236	60,000	.423
40,000	1,575	270,000	10,630	70,000	.363
45,000	1,772	280,000	11,024	80,000	.317
50,000	1,968	290,000	11,417	90,000	.282
55,000	2,165	300,000	11,811	100,000	.254
60,000	2,362	350,000	13,780	110,000	.231
65,000	2,559	400,000	15,748	120,000	.212
70,000	2,756	450,000	17,717	130,000	.195
75,000	2,953	500,000	19,685	140,000	.181
80,000	3,150			150,000	.169
85,000	3,346	25,399.98	1	160,000	.159
90,000	3,543	50,800	2	170,000	.149
95,000	3,740	76,200	3	180,000	.141
100,000	3,937	101,600	4	190,000	.134
110,000	4,331	127,000	5	200,000	.127
120,000	4,724	152,400	6	250,000	.1016
130,000	5,118	177,800	7	300,000	.0847
140,000	5,512	203,200	8	350,000	.0726
150,000	5,906	228,600	9	400,000	.0635
160,000	6,299	254,000	10	450,000	.0564
170,000	6,693			500,000	.0508
180,000	7,087				
190,000	7,480				

It is often necessary in the examination of a photo-micrograph of diatomic or other periodic structures to determine at what rate per inch or per mm. the structure is in the original object, the amplification of the photo-micrograph being known.

Example: In a photo-micrograph of a diatom amplified 735 diams. 12 dots can be counted in $\cdot 3$ of an inch. At what rate per inch is the structure in the diatom?

$$(1) \quad \frac{\text{magnifying power} \times \text{number counted}}{\text{space counted}};$$

$$\frac{735 \times 12}{\cdot 3 \text{ inch}} = 29,400 \text{ per inch.}$$

(2) If the answer is required in rate per mm., the space in which the number is counted being in inches as before, then, because 1 inch = 25.4 mm.

$$\frac{735 \times 12}{\cdot 3 \text{ inch} \times 25.4} = 1157.5 \text{ per mm.}$$

(3) Suppose a rule divided in mm. is used to determine the space in which the number on the photo-micrograph is counted, and the rate per inch is required; if twelve dots can be counted in 7 mm., then, because 1 inch = 25.4 mm.

$$\frac{735 \times 12 \times 25.4}{7 \text{ mm.}} = 32,004 \text{ per inch.}$$

APPENDIX D

COMPARISON OF THE SCALES OF FAHRENHEIT'S, THE
CENTIGRADE, AND RÉAUMUR'S THERMOMETERS

THESE three thermometers are graduated so that the range of temperature between the freezing and boiling points of water is divided by Fahrenheit's scale into 180° (from 32° to 212°), by the Centigrade into 100° (from 0° to 100°), and by that of Réaumur into 80° (from 0° to 80°) portions or degrees. Hence we derive the following equivalents:—

A degree of Fahrenheit is equal to $\frac{5}{9}$ of the Centigrade, or to $\frac{4}{5}$ of Réaumur's; a degree of the Centigrade is equal to $1\cdot8$ of Fahrenheit's, or to $\frac{9}{5}$ of Réaumur's; and a degree of Réaumur's is equal to $2\cdot25$ of Fahrenheit's, or to $1\cdot25$ of the Centigrade.

To convert degrees of Fahrenheit into the Centigrade or Réaumur's, subtract 32 and multiply the remainder by $\frac{5}{9}$ for the Centigrade, or $\frac{4}{5}$ for Réaumur's.

To convert degrees of the Centigrade or Réaumur's into Fahrenheit's, multiply the Centigrade by $\frac{9}{5}$, or Réaumur's by $\frac{9}{4}$, as the case may be, and add 32 to the product.

EXAMPLE

Let F, C, and R = the number of degrees Fahrenheit, Centigrade, and Réaumur respectively. Then

$$F = \frac{9C}{5} + 32; \quad F = \frac{9R}{4} + 32;$$

$$C = \frac{5(F - 32)}{9}; \quad C = \frac{5R}{4},$$

$$R = \frac{4(F - 32)}{9}; \quad R = \frac{4C}{5};$$

$$F = C + R + 32.$$

This last formula is of use, because in England thermometers are usually graduated in Fahrenheit and Centigrade. Réaumur may be found by inspection by subtracting the Centigrade from the Fahrenheit and taking 32 from the remainder. On the Continent thermometers are generally graduated in Réaumur and Centigrade. Fahrenheit can be found by adding Réaumur and Centigrade and 32.—Example: If the thermometer reads 8 Réaumur and 10 Centigrade, the Fahrenheit will be

$$8 + 10 + 32 = 50 \text{ F.}$$

APPENDIX E

OPTICAL FORMULÆ

To find C, the optical centre of a lens: Let A and B be the vertices, let the radius of the curve A = r, and that of B = s, t = thickness of the lens and μ the refractive index. Then

$$AC = \frac{rt}{r-s}; \quad BC = \frac{st}{r-s} \quad \dots \dots \dots (i)$$

Example explaining the method of treating the signs: First, it should be particularly noticed that all curves which are convex to the left hand have positive radii, and those turned the other way negative radii.

In a biconvex let r = 2, s = -3, and t = 1; then by (i)

$$AC = \frac{2 \times 1}{2 - (-3)} = \frac{2}{2+3} = \frac{2}{5}; \quad BC = \frac{-3 \times 1}{2 - (-3)} = \frac{-3}{2+3} = -\frac{3}{5}.$$

The point C is measured, therefore, to the right hand from A, and to the left from B. In a plano-concave let r = -2, s = ∞, and t = 1; then

$$AC = \frac{-2 \times 1}{-2 - \infty} = 0; \quad BC = \frac{\infty \times 1}{-2 - \infty} = \frac{\infty}{-\infty} = -1 \quad \dots (i)$$

c is therefore coincident with A.

The principal points D and E may be found thus:

$$AD = \frac{1}{\mu} \cdot \frac{rt}{r-s}; \quad BE = \frac{1}{\mu} \cdot \frac{st}{r-s} \quad \dots \dots \dots (ii)$$

Example: In a meniscus r = -3, s = -2, t = 1/4, and μ = 3/2; concavities facing the left hand.

$$AD = \frac{1}{\frac{3}{2}} \cdot \frac{-3 \cdot \frac{1}{4}}{-3 - (-2)} = \frac{2}{3} \cdot \frac{-\frac{3}{4}}{-3+2} = \frac{2}{3} \cdot \frac{-3}{-1} = \frac{2}{3} \cdot 3 = 2 \quad (ii)$$

D is measured 2 inch to the right from A.

$$BE = \frac{1}{\frac{3}{2}} \cdot \frac{-2 \cdot \frac{1}{4}}{-3 - (-2)} = \frac{2}{3} \cdot \frac{-\frac{1}{2}}{-3+2} = \frac{2}{3} \cdot \frac{1}{2} = \frac{1}{3} \quad \dots (ii)$$

E is measured 1/3 inch to the right from B.

If the meniscus is turned round so that its convexities face the left hand, r = 2, s = 3, t = 1/4, μ = 3/2;

$$AD = \frac{1}{\frac{3}{2}} \cdot \frac{2 \cdot \frac{1}{4}}{2-3} = \frac{2}{3} \cdot \frac{1}{2} \cdot -1 = -\frac{1}{3} \quad \dots \dots (ii)$$

Similarly BE = -1/2. Both are therefore measured to the left. The

formulæ (ii) are approximations, sufficiently accurate for general practical purposes, but in cases of importance the following, longer but more accurate, formulæ should be used :

$$A D = \frac{r t}{\mu (r - s) - t (\mu - 1)}; \quad B E = \frac{s t}{\mu (r - s) - t (\mu - 1)} \dots \dots \dots (iii)$$

Plano-convex Lens.—Let f = the principal focal point and y = the semi-aperture ; then if parallel rays are incident on A, the plane side of the lens, $r = \infty$, and by (ii) $B E = 0$. The principal point is therefore at the vertex B, and the focal length

$$B f = \frac{-s}{\mu - 1}; \quad E f = B f \dots \dots \dots (iv)$$

The spherical aberration

$$\delta f = -\frac{1}{2} \left(\frac{\mu}{\mu - 1} \right)^2 \frac{y^2}{f} \dots \dots \dots (v)$$

Thus when $\mu = \frac{3}{2}$,

$$\delta f = -4.5 \frac{y^2}{f} \dots \dots \dots (v)$$

If the parallel rays are incident on the convex side A, $s = \infty$, $B E = -\frac{t}{\mu}$ (ii), and the focal length

$$B f = \frac{r}{\mu - 1} - \frac{t}{\mu} \dots \dots \dots (vi). \quad E f = \frac{r}{\mu - 1} \dots \dots \dots (vii)$$

The spherical¹ aberration

$$\delta f = -\frac{\mu^2(\mu - 2) + 2}{2\mu(\mu - 1)^2} \cdot \frac{y^2}{f} \dots \dots \dots (viii)$$

When $\mu = 1.516$ (plate glass)

$$\delta f = -1.1 \frac{y^2}{f} \dots \dots \dots (viii)$$

When $\mu = 1.62$ (flint glass)

$$\delta f = -.8042 \frac{y^2}{f} \dots \dots \dots (viii)$$

To find the radius of a plano-convex lens, the ref. index and focus $E f$ being given :

$$r = f(\mu - 1) \dots \dots \dots (vii)$$

To find the radius of a plano-convex lens, the ref. index, the thickness, and the focus $B f$ being given :

$$r = \frac{(\mu - 1)(\mu f + t)}{\mu} \dots \dots \dots (vi)$$

A plano-concave lens follows a plano-convex ; f will be negative, which shows that the focus is virtual. Concaves being thin, t is usually neglected.

Equi-convex and equi-concave generally :

$$B f = \frac{r}{2(\mu - 1)} \dots \dots \dots (ix)$$

Equi-convex more accurately :

¹ Heath's *Geometrical Optics*, 1887.

Equi-convex more accurately:

$$Bf = \frac{r}{2(\mu - 1)} - \frac{t}{4\mu} \dots \dots \dots (x)$$

Spherical¹ aberration

$$\delta f = -\frac{4\mu^2(\mu - 1) - \mu + 2}{8\mu(\mu - 1)^2} \cdot \frac{y^2}{f} \dots \dots \dots (xi)$$

In an equi-convex lens when $\mu = 1.516$

$$\delta f = -1.618 \frac{y^2}{f} \dots \dots \dots (xi)$$

To find the radius of either an equi-convex or equi-concave lens, generally, the ref. index and the focus Bf being given:

$$r = 2(\mu - 1)f \dots \dots \dots (ix)$$

To find the radius of an equi-convex lens, the ref. index, the thickness, and the focus Bf being given:

$$r = \frac{(\mu - 1)(4\mu f + t)}{2\mu} \dots \dots \dots (x)$$

Bi-convex and bi-concave, generally:

$$Ef = \frac{1}{\mu - 1} \cdot \frac{rs}{s - r} \dots \dots \dots (xii)$$

Correction for thickness:

$$-\frac{t(\mu - 1)^2 f^2}{\mu t^2} \dots \dots \dots (xiii)$$

Bi-concave t may be neglected $Bf = Ef$ practically.

Bi-convex more accurately, and converging and diverging menisci:

$$Bf = \frac{s \left\{ (\mu - 1) \frac{t}{\mu} - r \right\}}{(\mu - 1) \left\{ r - s - (\mu - 1) \frac{t}{\mu} \right\}} \dots \dots \dots (xiv)$$

When the light is travelling from right to left

$$Af' = \frac{r \left\{ (\mu - 1) \frac{t}{\mu} + s \right\}}{(\mu - 1) \left\{ r - s - (\mu - 1) \frac{t}{\mu} \right\}} \dots \dots \dots (xiv)$$

Spherical aberration:

$$\delta f = -\frac{\mu - 1}{2\mu^2} \left\{ \frac{1}{r^3} + \left(\frac{\mu + 1}{f} - \frac{1}{s} \right) \left(\frac{1}{f} - \frac{1}{s} \right)^2 \right\} \cdot f^3 \cdot \frac{y^2}{f} \dots \dots (xv)$$

Example: Let $r = 2, s = -3, t = 1,$ and $\mu = \frac{3}{2}$; then by (xiv)

¹ Heath's *Geometrical Optics*, 1887.

$$Bf = \frac{-3 \left\{ \left(\frac{3}{2} - 1 \right) \frac{1}{\frac{5}{3}} - 2 \right\}}{\left(\frac{3}{2} - 1 \right) \left\{ 2 - (-3) - \left(\frac{3}{2} - 1 \right) \frac{1}{\frac{5}{3}} \right\}} = \frac{-3 \left(\frac{1}{2} \cdot \frac{2}{3} - 2 \right)}{1 \left(2 + 3 - \frac{1}{2} \cdot \frac{2}{3} \right)}$$

$$= \frac{-3 \times -\frac{5}{3}}{\frac{1}{2} \cdot \frac{14}{3}} = \frac{5}{\frac{7}{3}} = 2\frac{1}{7} \dots \dots \dots \text{(xiv)}$$

Similarly $Af = -2\frac{2}{7} \dots \dots \dots \text{(xiv)}$

By (xii) and (xiii) $Bf = \frac{12}{5} - \frac{1 \times \frac{1}{4} \times 144}{\frac{3}{2} \times 4} = \frac{12}{5} - \frac{6}{25} = 2\frac{4}{25}$

This is larger by $\frac{1}{58}$ inch than the result obtained by (xiv).
The following is an example worthy of note. Suppose

$$r - s < t \text{ and } > (\mu - 1) \frac{t}{\mu}$$

Thus let $r = 5\frac{1}{2}$, $s = 5$, $t = 1$, $\mu = \frac{3}{2}$.

Then by (xiv) $Bf = \frac{5 \left(\frac{1}{3} - \frac{11}{2} \right)}{1 \left(\frac{1}{2} - \frac{1}{3} \right)} = \frac{-155}{\frac{1}{12}} = -310$.

It will be observed that, although this meniscus is thickest in the middle, it has, however, a large negative focus.

The principal points of a sphere are at its centre.

The focus of a sphere, measured from the centre :

$$Ef = \frac{\mu r}{2(\mu - 1)} \dots \dots \dots \text{(xvi)}$$

The focus of a sphere measured from its surface :

$$Bf = \frac{r(2 - \mu)}{2(\mu - 1)} \dots \dots \dots \text{(xvi)}$$

The focus of a hemisphere measured from the plane surface, the light being incident on the convex surface :

$$Bf = \frac{r}{\mu(\mu - 1)} \dots \dots \dots \text{(vi)}$$

But when the light is incident on the plane surface, the lens being turned round :

$$Bf = \frac{-s}{\mu - 1} \dots \dots \dots \text{(iv)}$$

When $\mu = 1.5$ the focus of a sphere measured from the surface = $\frac{1}{2}$ the radius.

The focus of a hemisphere measured from the plane side = $1\frac{1}{3}$ the radius, and when measured from the convex side the focus = 2 radii.

In a cylindrical lens the principal points cross over.

To find the radii r and s of a crossed lens of minimum aberration for parallel rays :

$$r = \frac{2(\mu - 1)(\mu + 2)}{\mu(2\mu + 1)}f; \quad s = \frac{2(\mu - 1)(\mu + 2)}{\mu(2\mu - 1) - 4}f \quad \dots \dots \dots \text{(xvii)}$$

For boro-silicate glass $\mu = 1.51$; $r = .5898f$; and $s = -.3769f$; (xvii)

$$\delta f = -1.042 \frac{y^2}{f} \quad \dots \dots \dots \text{(xv)}$$

For flint glass $\mu = 1.62$; $r = .653f$; and $s = -12.06f$; (xvii)

$$\delta f = -.798 \frac{y^2}{f} \quad \dots \dots \dots \text{(xv)}$$

Critical angle.—Let θ be the critical angle for a ray passing out of a denser medium into a rarer one.

Then $\sin \theta = \frac{1}{\mu} \quad \dots \dots \dots \text{(xviii)}$

When $\mu = 1.333$, $\theta = 48^\circ 36\frac{1}{2}'$; $\mu = \frac{3}{2}$, $\theta = 41^\circ 48\frac{1}{2}'$; $\mu = 1.52$ $\theta = 41^\circ 8\frac{1}{4}'$;
 $\mu = 1.62$, $\theta = 38^\circ 7'$.

Let f be the principal focus, and p the distance from the object to the optical centre of the lens. p' = the distance from the optical centre of the lens to the conjugate image.

Then $p' = \frac{pf}{p-f}$; $p = \frac{p'f}{p'-f}$; $f = \frac{pp'}{p+p'}$ (xix)

Let v be the distance from the object to f , and w be the distance from f on the other side of the lens to the conjugate image.

Then $v = p - f$; $w = p' - f$; $p = v + f$; $p' = w + f$; and $vw = f^2$; $v = \frac{f^2}{w}$
 $w = \frac{f^2}{v}$ (xx)

If o be the size of the object and i the size of its conjugate image

$$i = \frac{ow}{f} = \frac{of}{v} = \frac{op'}{p} = \frac{of}{p-f} = \frac{o(p'-f)}{f};$$

$$o = \frac{iv}{f} = \frac{if}{w} = \frac{ip}{p'} = \frac{if}{p'-f} = \frac{i(p-f)}{f};$$

$$p = \frac{op'}{i} = \frac{f(i+o)}{i}; \quad p' = \frac{ip}{o} = \frac{f(i+o)}{o};$$

$$v = \frac{of}{i}; \quad w = \frac{if}{o}; \quad f = \frac{ip}{i+o} = \frac{op'}{i+o} = \frac{ow}{i} \quad \dots \dots \dots \text{(xxi)}$$

Examples: With an objective of $\frac{1}{2}$ -inch focus it is required to project an image of a diatom .03 long, so that it may be 1.5 inch on the screen, what must be the distance of the screen from the optical centre of the lens?

$$p' = \frac{f(i+o)}{o} = \frac{.5(1.5 + .03)}{.03} = 25.5.$$

Therefore $p' = 25\frac{1}{2}$ inches, the distance required (xxi)

Conversely, if the image of a diatom projected by a $\frac{1}{4}$ -inch objective measures 2 inches on the screen at $40\frac{1}{4}$ inches from the optic centre what is the size of the diatom?

$$o = \frac{if}{p'-f} = \frac{2 \times \frac{1}{4}}{40\frac{1}{4} - \frac{1}{4}} = \frac{1}{80} = .0125 \quad \dots \dots \dots \text{(xxi)}$$

the size of the diatom required.

The last formula of (xxi) is very convenient for finding the focus of an objective; w must, of course, be large in proportion to the focus; o may be a stage micrometer.

As the posterior focus, f , is in ordinary microscope objectives of 1-inch focus and upwards, near the back lens, the distance w may be measured from there.

Example: The image of .01 inch on a stage micrometer projected by an objective is 2.4 inches on a screen, distant 5 feet from the back lens; required the focus of the objective.

$$f = \frac{o w}{i} = \frac{.01 \times 60}{2.4} = \frac{.6}{2.4} = \frac{1}{4} \dots \dots \dots \text{(xxi)}$$

To find F, the equivalent focus of two lenses in contact:

$$F = \frac{f f'}{f + f'} \dots \dots \dots \text{(xxii)}$$

where f is the focus of one lens and f' that of the second.

Example: It is required to make a combination of two plano-convex lenses, the focus of one lens, f , being twice f' , that of the other, and whose combined focus $F = .6$, $\mu = \frac{3}{2}$; find their radii (see figs. 4, 6, 8, and 9).

Then $f = 2f'$.

$$F = \frac{2 f' f'}{2 f' + f'} = \frac{2 f'^2}{3 f'} = \frac{2 f'}{3};$$

$$f' = \frac{3 F}{2} = \frac{1.8}{2} = .9; \text{ and } f = 2 f' = 1.8 \dots \dots \dots \text{(xxii)}$$

$$r = (\mu - 1) f' = \left(\frac{3}{2} - 1\right) 1.8 = .9; \text{ similarly } r' = .45 \dots \dots \dots \text{(vii)}$$

The focus for three lenses follows that for two, thus:

$$F = \frac{f f' f''}{f f'' + f f' + f' f''} \dots \dots \dots \text{(xxii)}$$

which may be written $\frac{1}{F} = \sum \frac{1}{f}$.

To find F, the equivalent focus of two lenses, not in contact, generally, F to be measured from the last principal point (E') of the second lens; Let d = the distance between the lenses:

$$F = \frac{f'(f-d)}{f+f'-d} \dots \dots \dots \text{(xxiii)}$$

More accurately, let D E be the principal points of the first lens and D' E' those of the second, A B and A' B' being the respective vertices, d the distance from E to D'; then G and G', the principal points of the combination, are:

$$G = D + \frac{d f}{f + f' - d} \dots \dots \dots \text{(xxiv)}$$

$$G' = E' - \frac{d f'}{f + f' - d} \dots \dots \dots \text{(xxv)}$$

and

$$F = \frac{f f'}{f + f' - d} \dots \dots \dots \text{(xxvi)}$$

F is measured from one of the principal points of the combination. An example will be of interest. Let parallel rays fall on the convex face of the field lens of a Huyghenian eyepiece; find their focus.

Let f , the focus of the field lens = 3, and that of the eye lens $f' = 1$;

$\mu = \frac{3}{2}$, and the distance between the surfaces, that is $BA' = 1.8$; t the thickness of the field lens = $\frac{3}{10}$; and t' that of the eye lens = $\frac{3}{20}$; $AD = 0$

(ii); $BE = -\frac{t}{\mu} = -.2$ (ii). Similarly $A'D' = 0$; $B'E' = -\frac{t'}{\mu} = -\frac{1}{10}$ (ii); $d = EB + BA' = .2 + 1.8 = 2$. Now

$$G' = E' - \frac{2 \times 1}{3 + 1 - 2} = E' - 1 \dots \dots \dots (xxv)$$

$$F = \frac{3 \times 1}{3 + 1 - 2} = \frac{3}{2} \dots \dots \dots (xxvi)$$

We see, therefore, that the equivalent focus is $1\frac{1}{2}$ inch, but the principal point G' , from which the focus is measured, is 1 inch to the left from E' ; therefore the focal point is $\frac{1}{2}$ inch to the right from E' . Now as E' is $\frac{1}{10}$ inch to the left of B , the plane surface of the eye lens, it follows that F , the focal point, is $\frac{1}{10}$ inch to the right of the plane surface of the eye lens. If this problem is worked by the simpler formula (xxiii), the answer will be .44 from the plane surface of the eye lens; this is only an error of .04 in excess.

This explains 'the microscope objective of 10-ft. focus.'

The equivalent focus of the objective was 10 ft., but the principal point G' from which that focus was measured was 9 ft. $11\frac{1}{2}$ inches from the objective, which would give $\frac{1}{2}$ inch as the working distance of the lens. The objective in question has a double convex back lens and a plano-concave front; a small decrease in the distance between the lenses, such as a $\frac{1}{10}$ inch, has the effect of causing the principal point G' to recede many feet, and of causing a great increase in the equivalent focus.

With regard to the tube length, which is equal to d in (xxvi), the position of the principal points of a combination plays an important part. Suppose the Huyghenian eyepiece, in the preceding example, were mounted as an objective; the tube length would have to be measured from the first principal point of the eyepiece, wherever that might be, to the second principal point of the objective, which in the example before us is

$$G = D + \frac{2 \times 3}{3 + 1 - 2} = D + 3 \dots \dots \dots (xxiv)$$

G is therefore measured 3 inches to the right from the point D ; D is, as we have seen, coincident with A , the convex vertex of the field lens. So anyone measuring the tube length from the field lens, which is the posterior lens of our supposed objective, or from the middle of the combination, would be $1\frac{1}{2}$ or 3 inches in error. The correct point from which the measurement should be made lies one inch in front of the eye lens, which is the front lens of our supposed objective.

The importance of this cannot be over-estimated, as the optical tube length has a direct bearing on the power. If Q = the distance of vision (say 10 inches), M = the magnifying power, F = the equivalent focus of the eyepiece, F' = the equivalent focus of the objective, O = Prof. Abbé's 'Optical Tube length,' viz. the denominator in the fraction in formula (xxvi); then

$$M = \frac{OQ}{FF'} \dots \dots \dots (xxvii)$$

If ϕ = the focal length of the entire microscope, N.A. = the numerical aperture, and ϵ = the diameter of the eye-spot, then

$$\phi = \frac{Q}{M} = \frac{FF'}{O} \dots \dots \dots (xxviii)^1$$

¹ *Journal R.M.S.*

$$\epsilon = 2 \text{ (N.A.) } \phi; \quad \text{N.A.} = \frac{\epsilon}{2\phi} \dots \dots \dots \text{ (xxix)}^1$$

If λ = the number of waves per inch of light of a given colour, L the limit of resolving power of any objective with an illuminating beam of maximum obliquity is

$$L = 2\lambda \text{ (N.A.)} \dots \dots \dots \text{ (xxx)}$$

But with a solid $\frac{3}{4}$ axial cone and white light the resolving limit is equal to the N.A. multiplied by 70,000. When Gifford's screen is used, or photography employed, the limit is raised to the N.A. multiplied by 80,000.

The aberration for non-parallel rays.—It is a little more troublesome to find the aberration of rays other than parallel, but if the following instructions are carefully attended to the problem merely becomes the simplification of a vulgar fraction. Let P and P' be the distances of the point and its image from the lens. First find a , by either (xxxi) or (xxxii):

$$a = \frac{2f}{P} - 1 \dots \dots \dots \text{ (xxxi)}; \quad a = 1 - \frac{2f}{P'} \dots \dots \dots \text{ (xxxii)}$$

Next find x by (xxxiii) or (xxxiv):

$$x = \frac{2(\mu - 1)f}{r} - 1 \dots \dots \text{ (xxxiii)}; \quad x = 1 + \frac{2(\mu - 1)f}{s} \dots \dots \text{ (xxxiv)}$$

Then find ω by (xxxv):

$$\omega = \frac{1}{8\mu(\mu - 1)f^3} \left\{ \frac{\mu + 2}{\mu - 1} x^2 + 4(\mu + 1)ax + (3\mu + 2)(\mu - 1)a^2 + \frac{\mu^3}{\mu - 1} \right\} \text{ (xxxv)}$$

$$\frac{1}{P'} = \frac{1}{f} - \frac{1}{P} + \frac{1}{\mu} (x - a)^2 \frac{t}{4f^2} + \omega y^2 \dots \dots \text{ (xxxvi)}$$

$$\text{The aberration } \delta P' = -\omega P'^2 y^2 \dots \dots \text{ (xxxvii)}$$

To find the aberration of two lenses in contact. Let Q and Q' be the object and its conjugate at the second lens, f' be the focus of the second lens, and F the focus of the combination; then $P' = -Q$.

$$\frac{1}{P'} = \frac{1}{f} - \frac{1}{P} \dots \dots \text{ (xix)}; \quad \frac{1}{Q'} = \frac{1}{f'} + \frac{1}{Q} \dots \dots \text{ (xix)}$$

$$\text{for the first lens, } \frac{1}{P'} = \frac{1}{f} - \frac{1}{P} + \omega y^2 \dots \dots \text{ (xxxvi)}$$

$$\text{for the second lens, } \frac{1}{Q'} = \frac{1}{f'} + \frac{1}{Q} + \omega' y^2 \dots \dots \text{ (xxxvi)}$$

$$\text{for both lenses, } \frac{1}{Q'} = \frac{1}{f} + \frac{1}{f'} - \frac{1}{P} + (\omega + \omega') y^2 \dots \text{ (xxxviii)}$$

$$\text{Therefore, for } n \text{ lenses, } \frac{1}{Q^n} = \Sigma \frac{1}{f} - \frac{1}{P} + \Sigma \omega y^2 \dots \text{ (xxxviii)}$$

$$\text{The aberration } \delta Q' = -\Sigma \omega Q'^2 y^2 \text{ and } \delta P = -\Sigma \omega F^2 y^2 \dots \text{ (xxxix)}$$

Example: Two plano-convex lenses of equal foci have their convex surfaces in contact (fig. 7); find the aberration for parallel rays. Then

$$\mu = \frac{3}{2}; \quad f = f'; \quad F = \frac{f}{2} \dots \dots \dots \text{ (xxii)}$$

For the first lens $r = \infty$; therefore $x = -1$ (xxxiii); $P = \infty$; therefore $a = -1$ (xxxi); and $\omega = \frac{9}{2f^3} \dots \dots \dots \text{ (xxxv)}$

For the second lens $s = \infty$; therefore $x = 1$ (xxxiv); $\frac{1}{Q} = -\frac{1}{f}$; there-

¹ *Journal R.M.S.*

fore $a = -3$ (xxxix); $\omega' = \frac{13}{6f^3}$ (xxxv); $\omega + \omega' = \Sigma \omega = \frac{20}{3f^3}$;

$f = 2F$ (xxii); therefore $\Sigma \omega = \frac{20}{24F^3}$;

$\delta F = -\frac{20 F^2 y^2}{24 F^3} = -\frac{5}{6} \cdot \frac{y^2}{F}$ (xxxix)

This is half the aberration of an equi-convex lens (fig. 1) of the same focal length as the combination where

$\delta f = -\frac{5}{3} \cdot \frac{y^2}{f}$ (xi)

If the front lens of the combination be turned round so that its convex surface faces the incident light the aberration is

$\delta F = -\frac{5}{12} \cdot \frac{y^2}{F}$ (xxxix)

or half what it was before (fig. 5).

This is nearly a third of the aberration of a plano-convex in the best position (fig. 2), which is

$\delta f = -\frac{7}{6} \cdot \frac{y^2}{f}$ (viii)

The following figures pictorially illustrate spherical aberration in single lenses and in various combinations of two plano-convex lenses, all having the same focus F , the same aperture, and the same refractive index $\frac{3}{2}$. The dot nearer the lens is the focal point for the marginal, and that farther away the focal point for the central rays; the distance between the dots is the spherical aberration δF .



FIG. 1.



FIG. 2.



FIG. 3.

Fig. 1. An equi-convex, $r = F$;

$\delta F = -1.6 \frac{y^2}{F} = -.173$ (xi)

Fig. 2. A plano-convex, $r = \frac{F}{2}$;

$\delta F = -1.16 \frac{y^2}{F} = -.121$ (viii)

Fig. 3. A crossed convex, $r = \frac{7}{12} F$; $s = -\frac{7}{2} F$ (xvii)

$\delta F = -1.07 \frac{y^2}{F} = -.111$ (xv)

Fig. 7. A combination of two planos with their convex faces in contact, the focus f of the first lens being equal to f' , that of the second.

The focus of the combination $F = \frac{f}{2}$ (xxii)

$\delta F = -.833 \frac{y^2}{F} = -.087$ (xxxix)

Fig. 4. The same, only $2f = f'$;

$\delta F = -1.611 \frac{y^2}{F} = -.168$ (xxxix)

Fig. 6. The same, only $f = 2f'$;

$$\delta F = -\cdot 5 \frac{y^2}{F} = -\cdot 052 \dots \dots \dots (\text{xxxix})$$

Fig. 5. The first lens inverted, $f = f'$;

$$\delta F = -\cdot 416 \frac{y^2}{F} = -\cdot 043 \dots \dots \dots (\text{xxxix})$$

Fig. 8. The same, only $2f = f'$;

$$\delta F = -\cdot 623 \frac{y^2}{F} = -\cdot 065 \dots \dots \dots (\text{xxxix})$$

Fig. 9. The same, only $f = 2f'$;

$$\delta F = -\cdot 376 \frac{y^2}{F} = -\cdot 039 \dots \dots \dots (\text{xxxix})$$



FIG. 4.



FIG. 5.



FIG. 6.



FIG. 7.



FIG. 8.



FIG. 9.

We see, therefore, that with the same focal length F the aberration of fig. 1 is the greatest, and that of fig. 9 the least. We also see in the combinations that by decreasing up to a certain point the focus of the first lens the aberration is increased, and *vice versa*. The best form of a combination of plate glass, $\mu = 1\cdot 516$, for parallel rays similar in arrangement to fig. 9 is when $f = \frac{5}{3} f'$.

The Aplanatic Meniscus.—A spherical refracting surface has two aplanatic foci, such that if converging rays, which have their focus at P' , meet a convex spherical refracting surface, whose centre of curvature is r , and if the distance between the points P' and $r = \mu r$, then those rays will be refracted aplanatically to some other point, say P , which will lie on the same side of the surface as P' . This fact is of great service, because it enables an aplanatic meniscus to be constructed; thus, if we make r the radius of the curve A , we can make s , the radius of the curve B , a radius from the point P . If, then, P is a radiant, the light travelling from left to right will pass through the curve B without refraction, because P is the centre of the curve B . The light will then pass on unchanged to the curve A , and will by it be refracted aplanatically, as if it had come from P' . P will be negative and P' positive.

The formulæ for finding r and P' when P is given are :

$$r = -\frac{\mu P}{\mu + 1}; \quad P' = -\mu P \dots \dots \dots (\text{xI})$$

and those for finding r and P when P' is given are :

$$r = \frac{P'}{\mu + 1}; \quad P = -\frac{P'}{\mu} \dots \dots \dots (\text{xli})$$

An excellent combination, suitable for a bull's-eye, can be made of boro-silicate glass, refractive index 1.51, $\nu = 64.0$

- 1st lens¹ crossed $r = + 2.359$ } diameter 2.1
 $s = + 15.078$ }
- 2nd lens¹ meniscus $r = + 1.280$ } diameter 1.8
 $s = - 3.434$ }

Distance between lenses, .05; equivalent focus, 2.0; back focus, 1.55; total aberration, -.103; clear aperture, 2.0; angle, 62°. This combination is eminently suitable for photo-micrography, and for those cases where a bull's-eye is necessary.

A simpler form of bull's-eye can be made of two planos, using the same glass; see fig. 9, p. 1128.

- 1st lens, radius +3.0, diameter 2.1
- 2nd ,, ,, +1.8 ,, 1.9
- Distance between lenses, .05; equivalent focus, 2.1.

To find the radii r and s of a lens which will refract light from a point p to point p' with minimum aberration.

$$f = \frac{p' p'}{p + p'}; \quad p' = \frac{p f}{p - f} \quad \dots \quad \text{(xix)}; \quad K = \frac{p + p'}{(\mu - 1)p'} \quad \dots \quad \text{(xlii)}$$

$$r = \frac{2(\mu + 2)p}{\mu(2\mu + 1)K - 4(\mu + 1)} \quad \dots \quad \text{(xliii)}; \quad s = \frac{p r}{p - r K} \quad \dots \quad \text{(xliv)}$$

Let β be the coefficient of $\frac{y^2}{f}$ in formulæ v, viii, xi, and xv, then for parallel rays in each particular case the lateral aberration = $\frac{y^3}{f^2} \beta \dots \text{(xlv)}$

$$\text{Diameter of least circle of aberration} = \frac{1}{2} \frac{y^3}{f^2} \beta \dots \dots \dots \text{(xlvi)}$$

$$\text{Distance of least circle of aberration from focus} = -\frac{3}{4} \frac{y^2}{f} \beta \dots \text{(xlvii)}$$

When the rays are not parallel

$$\text{(xlv)} = \omega p' y^3 \quad \text{(xlvi)} = \frac{1}{2} \omega p' y^3 \quad \text{(xlvii)} = -\frac{3}{4} \omega p'^2 y^2$$

It is interesting to note that $\frac{y^2}{f} = 2(\mu - 1)t \dots \dots \dots \text{(xlviii)}$

Therefore, when $\mu = \frac{3}{2}$, $\frac{y^2}{f} = t$.

To find m , the magnifying power of simple lenses or magnifying glasses. Let d be the *least* distance of distinct vision apart from the lens, and f be the principal or focal focus of the lens. Then, when the eye is held close to the lens,

$$m = 1 + \frac{d}{f} \dots \dots \dots \text{(xlix)}$$

When the eye is held at the back principal focus of the lens, subtract one from this quantity. For real images projected upon a screen, the distance of the screen being d , subtract two.

It may be of interest to note that formula (xix) on this page may be used to determine the focus of spectacles required to bring the abnormal focus

¹ In this formula the convention used with regard to the signs is that of manufacturing opticians, and not that employed in the rest of the appendix.

of either a presbyopic or myopic person to a normal focus. Make p the abnormal, and p' the normal focus; then f will be the focus of the spectacles required.

In both cases p is a negative quantity, because it is on the same side of the lens as p' ; it is usual to make p' 10 or 12 inches.

Achromatism

Let μ be the refractive index of a mean ray (D line nearly) for a certain material, μ_v that for a blue ray, and μ_r that for a red ray; the dispersive power of the material is $\frac{\mu_v - \mu_r}{\mu - 1}$; this is usually written $\frac{\delta \mu}{\mu - 1}$, or ω . The formula for achromatism is

$$\frac{\delta \mu}{\mu - 1} \cdot \frac{1}{f} + \frac{\delta \mu'}{\mu' - 1} \cdot \frac{1}{f'} = 0;$$

that is,
$$\frac{\omega}{f} + \frac{\omega'}{f'} = 0 \dots \dots \dots (l)$$

The foci of the two lenses are therefore directly as their dispersive powers, and the focus of one will be negative.

An achromatic effect, which is not achromatism in the strict meaning of the term, can be obtained with two lenses of the same kind of glass by making d the distance between the lenses:

$$d = \frac{p(f + f')}{2p - f} \dots \dots \dots (li)$$

If p is large, f in the denominator may be neglected; this will make d half the sum of the foci, which is the formula for both the Huyghenian and Ramsden eyepieces; but when $p = f$, d is the sum of the foci.

Formulae relating to Spherical Mirrors

Let p = one focus, p' = its conjugate, f = principal focus, and r = radius of curvature; then in concave mirrors

$$p = \frac{pr}{2p - r}; \quad p' = \frac{pf}{p - f}; \quad f = \frac{pp'}{p + p'}; \quad f = \frac{r}{2};$$

$$r = \frac{2pp'}{p + p'}; \quad r = 2f; \quad \frac{p}{p'} = \frac{p - f}{f} \dots \dots \dots (xix)$$

To find p interchange p and p' .

If o is the size of an object, and i the size of its image, and v the distance of the image from the principal focal point, then

$$i = \frac{op'}{p}; \quad i = \frac{of}{v} \dots \dots \dots (xxi)$$

In convex mirrors prefix a negative sign, thus: $r = -2f$, and so on with the other formulæ.

The formulæ for mirrors may be derived from those of lenses by substituting -1 for μ ; thus $r = -2f$ (vii).

Let y = the semi-aperture; then the spherical aberration

$$\delta f = -\frac{1}{8} \cdot \frac{y^2}{f} \dots \dots \dots (v) \text{ or } (viii)$$

A mirror to be aplanatic for parallel rays must have a parabolic curve.

A mirror to reflect rays diverging from a point p , so that they may converge aplanatically to another point p' , must be elliptical, having p and p' for its foci.

Formulae relating to Prisms

Let ι = the refracting angle of the prism, ϕ the angle of incidence on the first surface, ϕ' the angle of refraction at the first surface, ψ the angle of incidence in the prism at the second surface, and ψ' the angle of refraction on emergence; then the total deviation

$$D = \phi + \psi' - \iota; \quad \phi' + \psi = \iota. \quad \dots \dots \dots \text{(lii)}$$

When the ray passes through the prism symmetrically the deviation is at a minimum: $\phi = \psi'$, $\phi' = \psi = \frac{\iota}{2}$, and

$$\mu = \frac{\sin \frac{\iota + D}{2}}{\sin \frac{\iota}{2}} \quad \dots \dots \dots \text{(liii)}$$

by which formula the refractive indices of media can be found, because both ι and D are capable of accurate measurement.

Formulae relating to Conic Sections

Ellipse.—Let A = major axis; a = minor axis. Then

$$\text{Focus} = \frac{A - \sqrt{A^2 - a^2}}{2} \quad \dots \dots \dots \text{(liv)}$$

Parabola.—Let A = height; $a = \frac{1}{2}$ base. Then

$$\text{Focus} = \frac{a^2}{4A} \quad \dots \dots \dots \text{(lv)}$$

Hyperbola.—Let A = major axis; a = minor axis. Then

$$\text{Focus} = \frac{\sqrt{A^2 + a^2} - A}{2} \quad \dots \dots \dots \text{(lvi)}$$

Works consulted:—Coddington, Camb. 1830; Parkinson, Camb.; 'Encyclopædia Britannica'; 'Journal R.M.S.'; Heath, Camb. 1887, &c. It will be seen that several of the formulæ have been entirely reset, while some appear now for the first time.

APPENDIX F

EXAMPLES USEFUL TO THE MICROSCOPIST

Square $\frac{1}{8}$ inch	=	10.08061	square millimetres.
„ $\frac{1}{10}$ „	=	6.45159	„ „
„ $\frac{1}{12}$ „	=	4.48027	„ „
„ $\frac{1}{100}$ „	=	.06452	„ „
		= 64515.9	„ μ
„ $\frac{1}{1000}$ „	=	645.159	„ „

Square centimetre	=	15.50006	square $\frac{1}{10}$ inch.
„ millimetre	=	15.50006	„ $\frac{1}{100}$ „
„ 100 μ	=	15.50006	„ $\frac{1}{1000}$ „
„ 10 μ	=	.15500	„ „ „
„ μ	=	.00155	„ „ „

Multiples of the above may be found by multiplying the values given by the square of the multiplier.

Thus, square $\frac{1}{10}$ inch = $\frac{1}{10} \times 4$; the square of 4 = $4 \times 4 = 16$, and $6.45159 \times 16 = 103.2254$ square millimetres, the answer required.

Cubic $\frac{1}{8}$ inch	=	32.00589	cubic millimetres.
„ $\frac{1}{10}$ „	=	16.38702	„ „
„ $\frac{1}{12}$ „	=	9.48323	„ „
„ $\frac{1}{100}$ „	=	.01639	„ „
„ $\frac{1}{1000}$ „	=	16387.02	„ μ

Cubic centimetre	=	61.0239	cubic $\frac{1}{10}$ inch.
„ millimetre	=	61.0239	„ $\frac{1}{100}$ „
„ 100 μ	=	61.0239	„ $\frac{1}{1000}$ „
„ 10 μ	=	.061023	„ „ „
„ μ	=	.000061023	„ „ „

Multiples of the above may be found by multiplying the values given by the cube of the multiplier.

Thus, 2 cubic millimetres; 2 cubed = $2 \times 2 \times 2 = 8$, and $61.0239 \times 8 = 488.1912$ cubic $\frac{1}{10}$ inch, the answer required.

Areas of Circles

$\frac{1}{8}$ inch diameter = 1.92718	sq. $\frac{1}{10}$ inch =	7.91726	sq. millimetres
$\frac{1}{10}$ „ „ = .78539816	„ „ „ =	5.06706	„ „
$\frac{1}{12}$ „ „ = .545415	„ „ „ =	3.51879	„ „
$\frac{1}{100}$ „ „ = .78540	„ $\frac{1}{100}$ „ =	.05067	„ „
		= 50670.6	„ μ
$\frac{1}{1000}$ „ „ = .78540	„ $\frac{1}{1000}$ „ =	506.7	„ „
1 millimetre diam. = .78539816	sq. mm. =	12.17372	sq. $\frac{1}{100}$ inch.
100 μ = 7854.0	„ μ =	12.17372	„ $\frac{1}{1000}$ „
10 μ = 78.54	„ „ =	.12174	„ „ „
μ = .7854	„ „ =	.0012174	„ „ „

Multiples of any of the above may be obtained in the same manner as in the preceding example.

Thus, if the diameter of the circle = $\frac{3}{100}$ inch, then the square of 3 being 9 and $.7854 \times 9 = 7.0686$ sq. $\frac{1}{100}$ inch and $.05067 \times 9 = .45603$ sq. millimetre, is the area required.

Volumes of Spheres

$\frac{1}{8}$	in. diameter	=	1.02266	cubic	$\frac{1}{100}$	inch =	16.75835	cubic millimetres.
$\frac{1}{10}$	" "	=	.52360	"	"	" =	8.58024	" "
$\frac{1}{12}$	" "	=	.30301	"	"	" =	4.96543	" "
$\frac{1}{100}$	" "	=	.52360	"	$\frac{1}{100}$	" =	.00858	" "
$\frac{1}{1000}$	" "	=	.52360	"	$\frac{1}{1000}$	" =	8580.24	" μ
1 mm. diam.		=	.52360	cubic mm. =	31.952	cubic	$\frac{1}{100}$	inch.
100 μ "		=	523600.0	"	μ	=	31.952	" $\frac{1}{1000}$ "
10 μ "		=	523.60	"	"	=	.03195	" "
μ "		=	.52360	"	"	=	.00003195	" "

Multiples of any of the above follow the preceding example of cubic measures. Thus, if the diameter of the sphere = 30 μ , then the cube of 3 being 27 and $523.6 \div 27 = 14137.2$ cubic μ and $.03195 \times 27 = .86265$ cubic $\frac{1}{1000}$ inch, is the volume required.

APPENDIX G

USEFUL NUMBERS AND FORMULÆ

Paris line = .088813783 inch.

Cubic foot of water weighs 62.2786 lb. avoirdupois at 62° Fahr.

Cubic inch of water weighs 252.286 grs. at 62° Fahr.

Gallon of water weighs 10 lb. avoirdupois at 62° Fahr.

1 gallon = 277.27384 cubic inches.

Cubic foot of sea water weighs 63.96 lb.

Weight of sea water = 1.027 weight of fresh water.

1 inch of rainfall = 100 tons per acre.

Pressure of water in lb. per sq. inch = .433 head of water.

Expansion of water between 32° Fahr. and 212° Fahr. = .04775.

Dip of horizon (including refraction) in nautical miles = 1.16 $\sqrt{\text{height}}$.

Marks on hand lead-line for sea soundings 1, 2, and 3 fathoms, 1, 2, and 3 tags of leather respectively; 5 and 15 fathoms white rag; 7 and 17 fathoms red rag; 10 fathoms leather with hole in it; 13 fathoms blue rag; 20 fathoms 2 knots; 30 fathoms 3 knots, &c. A small knot is placed at intermediate 5 fathoms after 20 fathoms—viz. at 25, 35, 45, &c.

Pressure of wind in lb. per sq. foot = 0.002288 (velocity in feet per second)².

Areas and Volumes

Area of triangle = base $\times \frac{1}{2}$ perpendicular.

Volume of wedge = area of base $\times \frac{1}{3}$ perpendicular height.

Volume of cone or pyramid = area of base $\times \frac{1}{3}$ perpendicular height.

Surface of side of cone = circumference of base $\times \frac{1}{2}$ length of side.

Area of parabola = base $\times \frac{2}{3}$ height.

Velocity of light = 186,377 statute miles per second.¹

Wave-length of yellow light = $\frac{1}{43100}$ inch.

Number of vibrations per second 508,961,293,000,000.

Falling Bodies

S, space fallen in feet; V, velocity in feet per second; $g = 32.2$; t , time in seconds.

$$S = \frac{g t^2}{2}; \quad V = \sqrt{2 g S}. \quad \sqrt{S} = 8.025 \sqrt{t}.$$

Arithmetical Progression

A, first term; B, last term; S, sum; d , difference between terms; n , number of terms.

¹ Latest determination by Prof. Newcomb, of Washington.

$$A = B - d(n-1). \quad B = A + d(n-1). \quad S = (A+B) \frac{n}{2}.$$

Geometrical Progression

m , multiplier or divisor.

$$A = \frac{B}{m^{(n-1)}}. \quad B = A m^{(n-1)}. \quad S = \frac{B m - A}{m - 1}.$$

Properties of Circles and Spheres etc.

$$\begin{aligned} \pi &= 3.141592653589793 + & \log \pi &= 0.4971498727 \\ \pi^2 &= 9.8696 & \sqrt{\pi} &= 1.77245 & \frac{1}{\pi} &= .31831 \\ \frac{1}{\pi^2} &= .10132 & \frac{1}{\sqrt{\pi}} &= .56419 & \frac{\pi}{4} &= .785398 \\ \frac{\pi}{6} &= .5236 & \sqrt{2} &= 1.41421 & \sqrt{2}g &= 8.02496 \end{aligned}$$

Circumference, C . Area, A . Radius, r . Diameter, d . Volume, V . Surface, S .

$$C = 2\pi r = \pi d. \quad A = \pi r^2. \quad S = \pi d^2. \quad V = \frac{\pi d^3}{6}. \quad d = \frac{C}{\pi}.$$

$$\text{Area of sector of circle} = \frac{\text{degrees in arc} \times \text{area of circle}}{360}.$$

Length of arc = number of degrees $\times .017453 r$.

Unit of circular measure = $57^{\circ}.29578$.

Side of square of equal area to a circle = $r \sqrt{\pi}$.

Side of inscribed square = $r \sqrt{2}$.

Area of ellipse = $\frac{1}{2}$ major axis $\times \frac{1}{2}$ minor axis $\times \pi$.

Volume of spheroid = polar axis \times (equatorial axis)² $\cdot \frac{\pi}{6}$.

Number of Threads per inch in Whitworth's Standard Screws

Sizes	$\frac{1}{32}$.	.	No. of threads	150	Sizes	$\frac{1}{4}$.	.	No. of threads	20
..	$\frac{1}{16}$	80	..	$\frac{1}{8}$	18
..	$\frac{3}{32}$	60	..	$\frac{3}{16}$	16
..	$\frac{1}{8}$	40	..	$\frac{1}{4}$	14
..	$\frac{5}{32}$	32	..	$\frac{1}{2}$	12
..	$\frac{3}{16}$	24	..	$\frac{3}{8}$	11

Convenient Approximations for rapid Calculations

6 knots = 7 miles, more correctly 13 knots = 15 miles.

8 kilometres = 5 50 kilometres = 31 ..

1 metre = 3 ft. $3\frac{1}{3}$ in. 32 metres = 35 yards.

5 centimetres = 2 inches 33 centimetres = 13 inches.

3 millimetres = $\frac{1}{8}$ inch 5 millimetres = $\frac{1}{5}$ inch.

1 pole = 5 metres ; 1 furlong = 2 hectometres.

$5\mu = \frac{1}{1000}$ inch ; $\frac{1}{1000}$ inch = $\frac{1}{4}$ mm. ; $\frac{1}{1000000}$ inch = $\frac{1}{4}$ μ .

2 are = 239 sq. yds ; 1 rood = 10 are ; 2 acres = 81 are ; 100 hectare = 247 acres ; 3 cubic yards = 23 decisteres ; 1 decastere = 13 cubic yards ; 2 decilitres = 7 $f \frac{3}{5}$ (ounces) ; 4 litres = 7 pints ; 2 grammes = 31 grains ;

4 grammes = 1 5 (drachm) (apothecaries); 7 grammes = 4 dr. (drachms) (avoirdupois).

5 kilogrammes = 11 lb. (avoirdupois).

50 kilogrammes = 1 cwt.

Nobert's 19 Band Test Plate

Band	Lines per inch	Band	Lines per inch
1	11259.5	15	90076.1
5	33778.5	19	112595.1
10	61927.3		

Difference between each band = 5629.75.

Nobert's last 20 Band Test Plate

Band	Lines per inch	Band	Lines per inch
1	11259.5	15	168892.7
5	56297.6	20	225190.3
10	112595.1		

Difference between each band = 11259.5.

Convenient Formula for Lantern Projection or Enlargement and Reduction.

Let D be the distance of the screen, and d the distance of the object from the optical centre of the lens, F the equivalent focus of the lens. M the magnifying power or 'number of times' for enlargement or reduction, then —

$$D = F(M + 1); \quad d = F + \frac{F}{M} = \frac{D}{M}; \quad F = \frac{D}{M + 1}; \quad M = \frac{D - F}{F};$$

Example: It is required to project by a lens of 6 inches equivalent focus a slide having a 3-inch mask so that it may give a 10-ft. disc, what must be the distance of the screen? Here M the magnification will be 40 times. $D = F(M + 1) = 6(40 + 1) = 246$ inches = $20\frac{1}{2}$ feet.

Note, in a double combination the optical centre may be assumed to be half way between the lenses. To reduce, interchange the object and the screen.

Royal Microscopical Society's Gauges

Substage	1.527	inch	=	38.786	mm.
Eyepieces, No. 1	.9173	..	=	23.300	..
.. .. 2	1.04	..	=	26.416	..
.. .. 3	1.27	..	=	32.258	..
.. .. 4	1.41	..	=	35.814	..

For the screw of the objective and nose-piece the Society supply, at cost price, a sizing die and plug, also screw chasers. They do not, however, supply standard screw gauges. Full particulars regarding the screw will be found in the 'R.M.S. Journal,' 1896, p. 389.

INDEX

ABB

A

- Abbe (Prof.), on amplifying power of lens, 26; on homogeneous immersion, 28; on improvement of optical glass, 32; on classification of eye-pieces, 34; on principle of microscopic vision, 43, 44, 45; on definition of aperture, 44; on aperture, 48 *note*; on radiation, 57; on angle of aperture, 60, 61, 62; on diffraction, 63-75; on 'intercostal points,' 73; on 'penetration,' 82; on over-amplification, 90; on stereoscopic vision, 90, 94; on 'aplanatic system,' 94; on orthoscopic effect, 95; on Ramsden's circles, 106; on solid cones of light, 418
- his stereoscopic eye-piece, 102; camera lucida, 281-284; apertometer, 307, 390-396; chromatic condenser, 308-309; achromatic condenser, 311-312, 385; condenser, iris-diaphragm fitted to, 312; diffraction theory and homogeneous immersion, 364; compensation eye-piece, 378; method of testing object-glasses, 384-387; test plate, 387-390; experiments in diffraction phenomena, 434
- Aberration, 19; positive, 21, 360 *note*; negative, 21, 27, 360 *note*; chromatic, 31; spherical, 31, 301, 306, 388; errors of spherical and chromatic, corrected by Ross, 357
- Abies balsamea*, 443
- Abiogenesis, 761
- Abraham's prism, 401
- Absorption or dioptrical image, 64
- and diffraction images due to diffraction, 65 *note*
- of light rays, Angström's law, 323
- bands, 323-327
- Abstriction of spores, 633
- Acatepha*, sexual zooids of polypes, 862; relationship to hydroids, 872; development of, 874; medusan phase of, 877
- Acanthometra siphicantha*, 850; *echinoides*, 852
- Acanthometrina*, 846, 852; central capsule of, 852
- Acarina*, eggs of, 1004-1006; anatomy of,

ACT

- 1009-1012; larvæ of, 1009; nymph of, 1009; integument of, 1010; legs of, 1010; eyes of, 1011; classification of, 1012
- Accommodation, of the eye, 88; depth, 89
- Acetabularia*, 563; pileus of, 563
- Acetic acid, as a test for nuclei, 517
- Acheta*, 987
- *campestris*, eggs of, 1005
- Achlya*, zoöspores of, 564; oöspores of, 565; zoösporanges of, 640
- *prolifera*, 563 and *note*, 563
- Achnantheæ*, characters of, 615
- Achnanthes*, frustules of, 588, 615; stipe of, 588, 615; 'stauros' of, 616; structure of frustule, 615
- Achnanthes longipes*, 615
- Achromatic, comparison of, with chromatic and apochromatic lenses, 368
- condenser, Abbe's, 260, 308-312, 314; Powell and Lealand's, 301, 311; for observation of pycnogonids, 959
- doublet, Fraunhofer's, 148; meniscus, 376
- lenses, Charles's, 148; Marzoli's, 353; Selligüe's, 354
- objectives, 19, 32; Tully's, 354; Wenhams's, 361, 362; cover slips for use with, 439
- oil condenser, Powell and Lealand's, 310, 311
- Achromatism, 17, 19, 150; in photomicrography, 34; rise of, 147; inaugurated, 365; imperfect, causing yellowness, 417
- Acineta*, 783
- 'Acinetiform young' of *Ciliata*, 782 *note*
- Acinetina*, 783; food of, 783
- 'Acorn' monad, 759
- 'Acorn-shells,' 967
- Actinia*, reproduction from fragments, 863
- *candida*, thread-cells of, 879
- *crassicornis*, thread-cells of, 879
- Actinocyclus*, 588, 610, 620
- Actinomma inermis*, 850, 851
- Actinophrys*, 846
- form of *Microgromia*, 736
- *sol*, 737-742
- Actinoptychus*, 588, 610, 611

ACT

- Actinosphaerium Eichornii*, 741
Actinotrocha, 950
 ACTINOZOA, 863, 877-883
 Actius, on myopy, 118
 Actuarius, on myopy, 118
 Adams' variable microscope, 142; non-achromatic microscope, 148
 'Adder's tongue' fern, 679; sporanges of, 675
 Adipose substance, 1045
 Adjusting objectives, Ross's, 357, 360
 Adjustment, coarse, 159-162; Swift's diagonal rack, 161; Nelson's stepped rack, 161; Wale's, 224-226
 — fine, 162-175
 — — Ross's, 153, 155, 175; to Pritchard's microscope, 153; Watson's long lever, 162, 172, 175; 'Continental' type, 162; Swift's vertical side lever, 162, 173, 174; Campbell's differential screw, 164, 165, 175, 230; Zeiss's, 166, 175; Reichert's new lever, 171, 175; Powell's, 174; short side lever, 174; speeds of, 175; to the sub-stage, Nelson's, 185; for Powell and Lealand's sub-stage, 186
 — screw collar, 360
 Æcidiospore generation of *Puccinia*, 637
Æcidium berberidis, relation to *Puccinia*, 637
 — *tussilaginis*, 638
Æthaliium septicum, plasmode of, 634
Agaricus, 647
 — *campestris*, 648
 Agate, 1095
Agave, leaf of, 686; raphides of, 696
Agrion, 987
 — *pulchellum*, wing of, as test for definition, 426
 — *puella*, pupa of, 994; wing of, 994
 Air-angle, 50, 78
 Air-bubbles, microscopic appearance of, 429, 430
 Air-chamber of leaves, 716
 Ale of *Surirella*, 606
 'Alar prolongations' in *Fusulina*, 826; in *Nummulites*, 827, 831; of *Calcarina*, 830
 Albite, 1080
 Albuminous substances, tests for, 516, 517
 Albumum, 704, 708
 Alcohol, as solvent for resins, &c., 517; as hardening agent, 484
Aleyonaria, 877, 879; spines of, initiated, 1101
 Aleyonian, resembled by polyzoan, 908
Aleyonidium, 908; polyzoary of, 909
 — *gelatinosum*, calcareous spicules in, 908 note
Aleyonium digitatum, 879; spicules of, 880
 Alder, on branchial sac of *Corella*, 912 note
 Alexander, on myopy and presbyopia, 118

ANA

- ALGÆ, preparation of, 514; included under general term of 'thallophytes,' 540; symbiotic in radiolarians, 848
 — lime secreting, 1084
 Algal constituents of lichens, 650
 Alkaloids, micro-chemical examination of, 1103
 Allman's experiments on luminosity of *Noctiluca*, 769
 Allman, on *Polyzoa*, 909; on the 'Haus' of *Appendicularia*, 918; on *Myriothela*, 863 note
 Aloe, raphides of, 696
 Alternation of generations in *Batrachospermum*, 575; in *Fungi*, 634; in ferns, 680; in *Medusæ*, 877
Althea rosea, pollen-grains, 721
Alveolina, 804; resembled by *Loftusia*, 818; resembled by *Fusulina*, 825
Amaranthaceæ, pollen-grains, 721
Amaranthus hypochondriacus, seeds of, 724
Amaroucium proliferum, as example of compound ascidian, 912
 Amici suggests oil for immersion lenses, 29
 Amici's invention of immersion system, 27; horizontal microscope, 148; camera lucida, 279; objectives, 355; triple-back objectives, 361; water-immersion objectives, 362; oil-immersion objectives, 364
Ammodiscus, 814
Ammonothea pyenogonoides, 958
Amœba, 733, 742-747, 1018
Amœba-phase of *Monas*, 756
Amœba proteus, 742
 — *radiosa*, experiments on, 743
Amœbæ, cells of sponges resembling, 855
 Amœboid phase of *Tetramitus*, 761
 Amphibians, plates in skin of, 1026
Amphioxus, affinities with ascidians, 917 note
Amphiplenra pellucida, with oblique illumination, 59, 75; resolution of, 85; markings measured, 274; markings on, 592
Amphistegina, 827; internal cast of, 841
Amphitetras, 614
Amphiuma, red blood-corpuscle of, 1036
Amphonyx, haustellium of, 992
 Amplification, 88-90
 — linear, 26, 39; of images, 45
 Ampullaceous sacs of sponges, 856, 857
Anabana, 548
Anacharis, 528
 — *alsinastrum*, cyclosis in, 689; habitat, 690
Anagallis, raphides of, 696; seeds of, 724
 — *arvensis*, petals of, 719
 Anal plate of *Antedon*, 903
Analgisur, 1013, 1014
 Analyser, 318
 Analysing nose-piece, 294

ANA

Analysis, micro-chemical, 1102; method of, 1102
Anaraphideæ, 599
 Anchor-like plates of *Synapta*, 895
 Andalusite, 1077
 Androspore of *Cedogonium*, 572
 Anemones, 863. See ACTINOZOA
 Anemophilous flowers, 722
Anethum graveolens, seeds of, 724
 Angle, extinction, 1079
 — of incidence, 3; of refraction, 3; of aperture, 61
 Angles of aperture, air, balsam, oil, water, 83-87
 Angström's law for the absorption of light rays, 323
Anguillula aceti, 945
 — *fluviatilis*, 945
 — *glutinis*, 945
Anguillula, 945
 Angular aperture, 395
 — — of dry objective, 391; of oil immersion, 391
 — — of aperture, resolution dependent on, 44
 — — of water immersion, 391
 Angular distribution of rays, 56; grip, 61; semi-aperture, 77
Angulifera, characters of, 613
 Animal kingdom, two divisions of, 727
 Animalcule cage, 346
 Animalcules, 753. See ROTIFERA, *Infusoria*, RHIZOPODA, &c.
 Animals and plants, differences between, 530
 Anisochele of sponges, 860
Anisouema, 765
 Annual layers in trees, 704
 Annular cell, Weber's, 350
 — ducts of Phanerogams, 698
 — illumination and false images, 419
 — illumination for examining perforated membrane of diatom, 419
 Annulata (Annelids), larvae of, collecting, 529; marine, 947; appendages of, 949; jaws of, 949; development of, 949; eggs of, 950; fresh-water, 955; luminosity of, 955; bibliography, 956; 'liver' of, 1047
 Annulus of sporange of fern, 676
Anodon, pearls in, 923; glochidia of, 933; for observation of ciliary motion, 940
Anomia, prismatic layer in, 924
Anopla (Nemertines), 951
Anoplaphrya circularis, 774
 Anorthite, 1080
Antedon, food of, 771; pentacrinoid larva of, 900-902; pseudembryo of, 903
 Antennæ of insects, 987; preparation of, 988, 989 note
 Antherid of *Vaucheria*, 563; of *Chara*, 577, 578; of *Fucaceæ*, 627, 628; of *Floridææ*, 631; of *Peronosporææ*, 638; of *Marchantia*, 665, 667; of mosses, 670; of *Sphagnaceæ*, 673; of ferns, 677; tapetal cells in, 678

APU

Antherozoids, 536, 540; of *Volvox*, 555; of *Vaucheria*, 563; of *Sphaeroplea*, 572; of *Cedogonium*, 572; of *Batrachospermum*, 574; of *Chara*, 579; of *Phæosporææ*, 627; of *Fucaceæ*, 628; of ferns, 678; of *Rhizocarpeæ*, 681
 Anthers, 719
 Anthony (Dr.), on pseudo-tracheæ of fly's proboscis, 990 note
Anthophysa, 765
Antirrhinum majus, seed of, 724
 Apertometer, 195, 390; Abbe's, 307, 394; Tolles', 390; use of, 394
 Aperture, in microscopic objectives, 33, 42-50, 60; how obtained, 45; Abbe on definition of, 45, 48 note
 — angular, 49 note, 53, 395
 — numerical, theoretical maximum of, 30
 — numerical, 49 note, 53, 76, 390; for dry objective, 50; for oil immersion, 50; for water immersion, 50
 — numerical, of Zeiss's apochromatic series of objectives, 371
 — of objective, 390
 — relation of, to power, 82, 83, 363; ascertained by vertical illumination, 338
 — table, Royston-Pigott's, 30
 — numerical, table of, 84-87
 Apertures, relative, 49
Aphanizomenon, 548
Aphanocapsa, 547
Aphids, wings of, 998, 999; agamic reproduction in, 1006
Aphidius, antennæ of, 988
Apidae, 987
Apis mellifica, mouth-parts of, 990
 Aplanatic system, 20, 23
 — objective use of, 21
 — cone, 307
 — aperture, 309, 315
 — foci, Lister's discovery, 355
 Apochromatic objectives, 19, 30, 33, 35, 80, 258; advantages of, 33, 34; objective, Zeiss's, 365-371; dry, 368; comparison of, with chromatic and achromatic lenses, 368; homogeneous objectives, value of, in study of monads, 762; objective, use with various test scales, 976
 — condenser, Powell and Lealand's, 302
 Apochromatism, 366, 369
Apocynaceæ, laticiferous tissue of, 695
 Apogamy in ferns, 680
 Apospory in ferns, 680
 Apothecæ of lichens, 650, 651
 Apparent creation of structure, 68
Appendicularia, 911, 917; pharyngeal sac of, 917; tail of, 917; notochord, 918; 'Haus' of, 918
 Apple, raphides in bark of, 696
 Apposition, growth by, 533
 — mode of growth of starch, 695
Apus, 959, 962; parthenogenesis of, 964 note
 — *cancriformis*, carapace of, 962

AQU

Aquarium microscopes, 266-269; J. W. Stephenson's, 267-268; Rousselet's, 268-269

Aquatic microscope, 147

ARACHNIDA, 1008

— eggs of, 1005; related to *Pycnogonida*, 959 *note*; reproductive organs of, 1011

Arachnoïdiscus, 588, 612

Arachnosphaera obligacantha, 850, 852

Aragonite, 1095

— in shell of *Pholas*, 924

Aralia papyrifera, parenchyme of, 687

Araneida, 1008

Arcella, 746

Archegones of *Vaucheria*, 563; of *Chara*, 577, 578; of *Marchantia*, 665, 668; of mosses, 670, 671; of *Sphagnaceæ*, 673; of ferns, 677, 678; of *Lycopodiæ*, 681; of *Rhizocarpeæ*, 681

Archer, on amœbiform phase of *Stephanosphaera*, 557 *note*; on desmids, 579 *note*; classification of, 585; on *Clathralina*, 742 *note*

Archeria Boltoni, 730

Arctium, stem of, 709

Arcyria flava, sporanges of, 635

Arenaceæ, 810-814

Arenaceous character of *Textularinia*, 823

— *Foraminifera*, varying size of particles in test of, 818

— test of *Foraminifera*, 810

Arenicola, 948

Areolæ of frustule of *Coccinodiscus*, 591

Areolar connective tissue, 1040, 1045

Argas, bite of, 1012

Argasidæ, 1012

Argonauta, 929

Argosina, 1008

Argulus foliaceus, 966

Aristolochia, stem of, 709

'Aristotle's lantern' of echinids, 890

Aristotle on myopy and presbyopia, 118

Arsenic, micro-chemical analysis of, 1103

Artemia, 962

— *salina*, movement of, 960; habitat of, 963

Arteries, 1056

Arthrodesmus incus, 568

АРТИРОДА, 957-1016; smallest of, 1008; eye of, 983

— limbs of *Pedalia* compared with those of, 792

Arthrosporous *Bacteria*, 657

Artificial light, 417

'Artificial lightning,' 682

Ascaris lumbricoides, 944

Asci of *Ascomycetes*, 642; of lichens, 650

Ascidians, diatoms in stomach of, 614, 623; solitary, 911; branchial sac of, 912, 913, 915; circulation in, 912, 915; compound, 912; cloaca of, 913; stolons of, 914; bibliography of, 914 *note*; social, 914; general structure of, 916; development of, 916; tadpole of, 917; affinities with *Amphioxus*, 917 *note*

Asclepiadææ, pollinium of, 722

BAC

Ascogone of *Ascomycetes*, 643; of lichens, 651

Ascomycetes, 642-645; as fungus-constituents of lichens, 651

Ascospores of *Ascomycetes*, 642; of lichens, 650

Asellus aquaticus, ciliated parasite in blood of, 774

Asilus, eye of, 987

Aspergillus, fermentation by, 647

Asphalte for cells, 446

— varnish, 443

Aspidisca, a phase in development of *Trichoda*, 781

Aspidium, indusium of, 675; sori of, 675

Asplanchna, in confinement, 528

Astasia, 545; mouth in, 765

Asteroïdææ, skeleton of, 891; spines of, 891; larva of, 897

Asterolampra, 595, 610

Asteromphalus, 610

Astromma, 849

Astrophyton, spines of, 891

Astrorhiza, 811, 815

Astrorhizida, 812

Athecata, 868

Athyrium Filix-femina, apospory in, 680

Atrium of *Noctiluca*, 766

Auditory vesicles of *Mollusca*, 941

Audouin, on 'muscardine,' 645

Augite, 1072; zonal structure in, 1073

Aulacodiscus, 612

— *Kittonii*, markings on, 591

— *Sturtii*, markings on, 592

Autofission of diatoms, 594

Auxospore, 594-601

Avanturine, 1095

Avicularia of *Polyzoa*, 910, 911

'Awns' of *Chaetocera*, 614

Axile body of tactile papilla, 1053

Axinella paradoxa, 858

Axis cylinders of nerve-tube, 1051, 1052

B

Bacillariacææ of Kützing, 587

Bacillaria paradoxa, movements of, 602, 606

Bacilli, form of, 653

Bacillus, 'granular spheres' of, 660 *note*

— *anthracis*, 656; spores live in absolute alcohol, 660

— *megaterium*, 655

— of anthrax, 1037 *note*

— of tuberculosis, modes of staining, 515, 516

— *subtilis*, 656, 657, 658; spores of, 660

'Bacon-beetle,' 980

Bacon (Roger), inventor of simple microscope, 126

Bacteria, use of large and small cones in examining, 421; photo-micrographs, 423; as test for definition, 426; staining, 514-516; (see *Schizomycetes*), 651; affinities to *Algae*, 651; to *Flagellata*,

BAC

- 651; to *Nostocaceæ*, 652; movements of, 652; mode of multiplication, 652; forms of, 653; classification of, 655; nutrition of, 658; flagella of, 659; germinating power of, 660; spores of, 660
- Bacteriastrum furcatum*, 614
- Bacteriology, 662
- Bacterium lineola*, compared with *Cercomonas*, 651
- *lineola*, 658
- *terno*, flagellum of, 72, 658; movement of, 653; zoöglea of, 659; germination of, 660
- Bailey, on internal casts of *Foraminifera*, 828 *note*
- Bailey's method of isolating diatoms, 624
- Baker, on Cuff's microscope, 142
- Baker's microscopes, 202, 218–221, 230, 246, 251; mechanical stage, 181; sub-stage, 188, 189; achromatic condenser, 306; fitting for condenser, 312
- lamp, 407
- Balanula*, 967
- Balanus balanoides*, 967; disc of, 968
- Balsam angle, 59, 78
- refractive index of, 77
- Banksia*, stomates of, 716
- Barbadoes earth, 846, 849
- Bark, 700, 702, 708
- Barker's Gregorin telescope, 145
- Bar movement, 262
- 'Barlow lens' applied to a microscope, 149
- Barnacles, 967. See *Cirripedia*
- Basals of *Antedon*, 901
- Basidiomycetes*, 647; as fungus constituent of lichens, 651
- Basidiospores of *Basidiomycetes*, 647; of *Hymenomycetes*, 647
- Basids of *Puccinia*, 637; of *Basidiomycetes*, 647
- Bast, 710
- Bat, parasite of, 1012; hair of, 1030; cartilage in ear of, 1046
- '*Bathybius*,' 747
- Batrachia*, red blood-corpuscles, 1035; lungs of, 1063
- Batrachospermeæ*, 574
- Batrachospermum moniliforme*, 575
- protoneme of, 575
- 'Battledore scale' of *Lycæniidæ*, 975
- Bausch and Lomb's microscopes, 212–214, 222, 239, 247, 252; mechanical stage, 183, 184; sub-stage, 212; chemical microscope, 263; camera lucida, 285; objectives, 375
- Bdella*, maxillary palps of, 1010
- Bdellidæ*, 1013
- Bdelloida*, 791
- Bead-moulds, 645
- Beale's camera, 279, 288; glycerin method of preserving, 520
- Beale, on organic structure, 1017
- Beck's microscopes, 228, 233; mechanical stage, 184; rotatory nose-piece, 291;

BIR

- condensers, 304, 305; side reflector, 333; vertical illuminator, 337; disc-holder, 339; compressor, 347; rings for locking coarse adjustment, 352; objectives, 375; lamp, 405–407; achromatic binocular magnifier, 456 *note*; disc-holder for examination of *Foraminifera*, 845
- Beck (R.), on markings of Podura scale, 978
- Bee, hairs of, 980; head of, 982; wing of, 994, 998; sting of, 1003
- Beeldsnyder's achromatic objective, 147
- Beetles. See *Coleoptera*
- Beggiatoa*, form of, 652, 653
- *alba*, 653–655
- Begonia*, seeds of, 724
- Behrens' method of analysing minerals, 1083; of micro-chemical analysis, 1102
- Bell (Jeffrey), on the spines of *Cularis*, 889
- Bell's cements, 443, 479
- Beneden (Ed. Van), on *Gregarina gigantea*, 749 *note*; on movement of gregarines, 750
- Benzol, uses of, 517
- Bergh, on *Flagellata*, 764
- 'Bergmehl,' 622
- Berkeleya*, 602
- Bermuda earth, 608, 611
- Beroë*, collecting, 529
- *Forskaliæ*, 881, 882
- *ovatus*, Eimer on, 882 *note*
- Bicellaria ciliata*, 910
- Biconvex lens, formulæ relating to, 21
- Biddulphia*, 612
- cyclosis in, 587; chains of, 588, 596; structure of frustule, 590 *note*
- Biddulphiææ*, character of, 612
- Biflagellate monad, 759
- Bignonia*, seed of, 724
- Bignoniaceæ*, winged seeds, 724
- Biloculina*, 802
- Binary subdivision of cell, 535, 536
- Binocular eye-piece, Tolles', 101; Abbe's, 102
- Binocular magnifier, Beck's achromatic, 456 *note*
- Binocular microscope, 61, 97
- — Riddell's, 96; Nachet's, 98; stereoscopic, Wenham's, 98; Stephenson's, 100; Stephenson's erecting, 100; stereoscopic, for study of opaque objects, 103; non-stereoscopic, 105; Powell and Lealand's high-power, 105, 106; Rousselet's portable, 245; Stephenson's for dissection, 248, 401, 456; spectrum microscope, 327
- Biology, 530
- 'Bipinnaria,' resemblance of *Actinotrocha* to, 956
- Bipinnaria asterigera*, 897
- Birch, pollen-grains of, 722
- BIRD, parasite of, 1012, 1014; lacuna in bone of, 1022; epidermic appendages of, 1029; red blood-corpuscles of, 1034, 1035; lungs of, 1064

BIR

- Bird's egg, concretions on shell imitated, 1102
 'Bird's head processes,' see *Avicularia*, 910
 Bismarck brown, 489
 Bivalves, structure of ligament in, 1040
 'Black dot,' Nelson's, 277
 'Bladderwrack,' 627
 Blanchard (R.), on *Sporozoa*, 749 note
Blatta, antennæ of, 988
 — *orientalis*, eggs of, 1005
 • Blenny, scales of, 1027
 Blood, colourless corpuscles, 1018; method of mounting, 1038; circulation of, 1054; flow of, 1055; micro-chemical examination, 1103
 — of insects, circulation of, 993, 994; of *Vertebrata*, 1034
 Blood-corpuscle, relation of size to that of bone lacuna, 1022
 Blood-corpuscles of *Vertebrata*, 1034
 Blowfly's maxillary palpus, hairs on, examination of, 422
 Blowfly, proboscis of, examination with apochromatic, 371; hairs on, as test for definition, 426
 — development of, 1007; 'imaginal discs' of, 1007
 'Blue mould,' 643
Bodo, 545
 Body of the microscope, 157
 'Bog-mosses,' 673
Boletus, 647
Bombyx, 987
 — *mori*, eggs of, 1005
 Bonannus's microscope, 132; his horizontal microscope, 133, 134; his compound condensers, 298, 299
 Bone, 1020; structure of, 1020-1023; preparation of, 1023; matrix of, 1039; decalcification of, 512
 Bones, fossilised, 1090-1092
 'Bony pike,' scale of, 1022
 Borax carmine, 490
 Bordered pits in the tracheïdes of conifers, 698, 703
 Bosovich, on chromatic dispersion, 42
 Botryllians, 914
Botryllus violaceus, 915
Botryocystis, 545
Botrytis bassiana, 645
 Botterill's growing slides, 340; his zoöphyte trough, 348
 Bouguet, on uniform radiation, 51
 Bowerbank, on sponge spicules, 859 note; on structure of molluscan shells, 921, 928
Bowerbankia, gizzard of, 905; stem of, 908; polyzoaries of, 909
 'Box-mite,' 1012
Brachinus, antennæ of, 988
Brachionus rubens, 787-790, 791; male of, 790
 BRANCHIOPODA, shells of, 919, 925-927; relation of shell to mantle, 926; affinities to *Polyzoa*, 927
 Brachyurous decapods, young of, 969

BÜT

- Brady (H. B.), on *Foraminifera*, 810; on arenaceous *Foraminifera*, 811; on affinity of *Carpenteria*, 823
 Brady and Carpenter, on fossil *Lituolæ*, 817
 'Brake-fern,' 675. See *Aspidium*
 Bran, 725
 Branchiæ of annelids, 948, 949
Branchiopoda, 959; divisions of, 961
Branchipus, movement of, 960
 — *stagnalis*, 962, 963
Branchiura, 965 note, 966
 Brandt (K.), on artificial division of *Actinosphaerium*, 741 note; on zoöxanthellæ, 848
 Braun, on *Pediastrum*, 567
 Brewster, his hand magnifier, 37; on modification of stereoscope, 91; on 'lens' from Sargon's palace, 119; his 'Treatise on the Microscope,' 120; on achromatic condensers, 299, 300
 Bright-line spectro-micrometer, 325
 Brightwell, on *Tricreatium*, 613 note; on *Chatoceera*, 614 note
 Brilliancy of image, 382
 'Brimstone moth,' eggs of, 1005
 Brine shrimp, 960, 963
 'Brittle stars,' 891. See *Ophiuroidea*
 Brooke's nose-piece, 291
 Brownian movement, experiments, 431, 432
 Browning's bright-line spectro-micrometer, 325
 Brücke lens, 38
 Brunswick black as a black 'ground,' 444; for cells, 446
Bryocæa, 673
Bryobia, 1013
 Bryony, cells of pollen-chambers, 720
Bryozoa, 904. See POLYZOÆ
Bryum intermedium, peristome of, 672
 Bubbles in cavities of crystals, 1074
Buccinum, 937
 — *undatum*, palate of, 930, 932, 933; nidamentum of, 934
 Buchner's experiment on spores of *Bacteria*, 660
 Buckthorn, stem of, 703
 Bug, mounting medium for, 973
Bugula, polyzoary of, 909
 — *avicularia*, 910, 911
 Built-up 'cells,' 419
 Bulbils of *Nitella*, 577
 Bulloch's modification of Zentmayer's microscope, 204
 Bull's-eye, 300; use of, 329-333, 407-420; with high power, 331; for use in study of saprophytic organisms, 333; Powell and Lealand's, 333
 Bull's-eye stand, 218
 Bundle-sheath, 711
 Burdock, stem of, 709
 Bütschli, on mouth of *Istasia*, 765; on *Vorticella*, 773 note
 — and Engelmann, on conjugating vorticellids, 782

BUT

CEL

Butterflies, wing of, 994
 Butterfly. See *Lepidoptera*

C

Cabbage-butterfly, eye of, 983; number of facets in, 983; eggs of, 1005
Caberea Boryi, vibracula of, 907 *note*
 Cabinet for slides, 523; arrangement of, 523
 Cactus, cells of pollen-chambers, 720
Cactus senilis, raphides of, 696; brittleness of, 696
Cacumaria crocea, development of, 900 *note*
Calamites, 1084
Calathus, antennæ of, 988
Calcarina, 825, 830; compared with *Eozoön*, 838
Calcspongia, spicules of, 859
 Calcite in shells, 924
 Calco-globuline, 1101
Callithamnion, 630
Calosanthus indica, winged seed of, 724
 Calotte diaphragms, 297
Calycanthus, bark of, 709
 Calycine monad, 760
 Calyces of hydroids, 868
 Calypter of mosses, 671
 Calyx of *Flagellata*, 764
 Cambium, 710
 — in Exogens, 697
 — layer, 708
 Cambridge rocking microtome, 469
 Camera lucida, 277; Soemmering's, 278; Wollaston's, 278; Amici's, 279; Nelson's, 279, 280; Beale's, 279, 288; Cooke's, 280, 281; Abbe's, 281-284; Swift's modification of Abbe's, 284; Bausch and Lomb's modification of Abbe's, 285; Schröder's, 285, 286
 Campani's microscope, 128; eye-piece, 376
Campanula, pollen-grain of, 721
Campanularia, 870
 — *gelatinosa*, 865
Campanulariida, 870; zoöphytic stage of, 877
 Campbell's differential screw, 162, 164, 165, 174, 202, 230
Campylodiscus, 587, 588, 595; movements of, 602; structure of frustule, 606
 — *clypeus*, 607
 — *spiralis*, cyclosis in, 587
 Canada balsam, 443
 — — capped jars for, 477; as mounting medium, 480, 521; as a preservative medium, 518; mode of preparation, 518; refractive index, 521; for mounting insects, 973
 Canal system of *Calcarina*, 825; of *Polystomella*, 827; of *Nummulites*, 827
 Canaliculi of bone, 1019, 1021
 Cancellated structure of bone, 1020
Cancer pagurus, skeleton of, 968

Canna, starch-grains of, 695
 Cannocchiale, 125
 Capacity of object-glass, 382
 Capillaries, 1056, 1062
 Capillitium of *Myzomycetes*, 636
 Capsule, central, of *Radiolaria*, 847
 — of mosses, 670; of *Purpura*, 934
 — silicious, of *Clathralina*, 742
 Carapace of *Copepoda*, 960; of *Cladocera*, 961
 Carbon bisulphide as a solvent for oils, &c., 517
 Carboniferous epoch, vegetation of, 681
 — limestone, 1090
Carchesium, collecting, 527
Carcinus mienas, metamorphosis of, 970
 Carnation, parenchyme of, 688
Carnivora, arrangement of enamel in, 1025
 Carp, scales of, 1027
 Carpenter (H. P.), on crinoids, 903 *note*
 Carpenter (W. B.), on stereoscopic vision, 90-93; on classification of *Foraminifera*, 799; on *Eozoön*, 838; on alternation of generation in *Medusa*, 877; on the so-called excretory pores of *Ctenophora*, 882 *note*; on development of *Antedon*, 903 *note*; on structure of molluscan shells, 921
Carpenteria, 822; mode of growth compared with *Eozoön*, 838
 — *raphidodendron*, 823
 Carpogone of *Florideæ*, 632; of *Ascomycetes*, 643
 Carpospores of *Florideæ*, 632
 Carrot, seeds of, 724
 Carter (H. J.), on affinity of *Carpenteria*, 823
 Cartilage, 1046; mounting, 1047
Carum carui, seeds of, 724
Caryophyllia, lamellæ of, 878
 — *Smithii*, thread-cell of, 879
Casuarilla, raphides of, 696
 Cassowary, egg-shell of, 1101
 Castracane, on beaded structure of diatoms, 593; on Pfitzer's auxospores, 595; on sporangial frustules of diatoms, 595; on reproduction of diatoms, 597; on diatoms, 598
 Cat, Pacinian corpuscles of, 1053
 Caterpillars, 'pro-legs' of, 1002; feet of, 1002
 Cathcart's freezing microtome, 474, 475
 Catoptric form of microscope, 145, 146
Caulerpa, 563
 Cauterisation by focussing the sun's rays (Pliny), 117
 Cedar, stem of, 705
 Cell, contents of, 533-535; binary subdivision of, 535
 Cell-division and nucleus, 1018, 1019 and *note*
 'Cell' of *Polyzoa*, 904
 Celloidin imbedding method, 503-506
 — staining and mounting, sections, 506
 Cell-sap, 534

CEL

- 'Cells' for examining *Infusoria*, &c., 349; for dry mounting, 445; of cement, 446; paraffin, 446; paper, 446; ring-cells, 446; of plate-glass, for zoöphytes, &c., 448; built up, 449; sunk, 449; mounting in, 482-484; of bone, 483; of tin, 483
- Cells of plants, 532; multi-nucleated, 534; primordial, 536; of vertebrates, 1018
- Cell-structure, Strasburger on, 537
- Cellular cartilage, 1046
— parenchyme, 688
- Cellulose, 533
— tests for, 516, 517; envelope of desmids, 580; in *Dinoflagellata*, 770; in zoöcytium of *Ophrydium*, 778
- Cell-wall, 533; mode of growth of, 533; apposition, 533; intussusception, 533
- Cell-wall of Phanerogams, 692
- Cement-cells, 446
- Cements, 442; liquid, 442; Bell's, 443, 479; Japanner's gold size, 443; Brunswick black, 444; glue and honey, 444; shellac, 444; Hollis's liquid glue, 444, 479; Venice turpentine, 444; marine glue, 445; Heller's porcelain, 521
- Cementum of teeth, 1025, 1026
- Centipedes. See *Myriopoda*
- Central capsule of *Radiolaria*, 734
- Centring, 382, 389
- Centring nose-piece, 293; as sub-stage, 230
- Centro-dorsal plate of *Antedon*, 902
- Cephalolithis sylvina*, 847
- Cephalophorous mollusca, palates of, 930-933
- CEPHALOPODA, 929
— organs of hearing in, 941; chromatophores of, 942
- Ceramiacea*, 630
- Ceraminum*, 630
- Ceratum*, 771
— *furca*, 771
— *tripos*, 771
- Ceratodus*, 1091
- Cercomonas typica*, compared with *Bacteria*, 651
- Cereals, seeds of, starch in, 694
- Cerura vinula*, eggs of, 1005
- Cestoid, 943
- Cetonia*, antennæ of, 988
- Chatocerca*, affinities of, 614
— 'awns' of, 614
— occurrence in marine animals, 614
- Chatoceros Wighamii*, 614
- Chaetophoraceæ*, 573
- 'Chaff-scales,' siliceous in, 715
- Chalk, microscopic constituents of, 1085, 1087; resemblance to *Globigerina* oöze, 1087; mode of preparation for examination, 1088
- Chama*, prismatic layer in, 924
- Chamberlets in *Foraminifera*, 798, 803, 804; of *Parkeria*, 817; in *Fusulina*, 825; of *Cycloclipeus*, 835
- Chamidae*, *Foraminifera* attached to shells of, 815

CHR

- Changes of form of white corpuscles, 1037
- Chantransia* and *Batrachospermum*, 575
- Chara*, 576, 669; antherozoids of, 667
- Characeæ*, 575-579
- Charles's achromatic lenses, 148
- Cheese-mite, 1008, 1013
- Cheilostomata*, characters of, 909; examples of, 910
- Cheirocephalus*, 962, 963
- Chemical tests for biological work, 516, 517
- Cherry-stone, section of, 693
- Chert, 1089
- Chérubin d'Orléans, his binocular microscope, 130, 131; his compound microscope, 130
- Chevalier, on Charles's achromatic lenses, 148
- Chevalier's combination of lenses, 38; achromatic microscope, 148, 150; modifications of Selligie's lenses, 354; objectives, Lister's note on, 354, 355
- Cheyleti*, 1013
- Cheyletida*, tracheæ of, 1011
- Cheyletus*, hairs of, 1010; legs of, 1010; mouth parts of, 1010
- Chickweed, petals of, 719
- Chicory, adulteration of, 725 note
- Chilodon*, mouth of, 774
— *encullulus*, binary division of, 777, 779
- Chilognatha*, 981
- Chirodota violacea*, 'wheels' of, 896
- Chitin, in test of *Arcella*, 746; of insects' skin, 974
- Chitinous substances, mounting, 481
- Chiton*, shell structure, 928; eyes on shells of, 941
- Chlamydomonas*, 545
- Chlamydomyxa*, affinity with *Mouerozou*, 727
- Chlamydospores*, of *Mucorini*, 641; of gregarines, 750
- Chloral hydrate as a preservative medium, 519
- Chloroform, uses of, 517
- Chlorophyll corpuscles, 534, 535
- Chlorosporææ*, 625
- CHORDATA, 911. See VERTEBRATA
- Choroid coat of eye, pigment-cells in, 1042
- Chromatic, comparison of, with achromatic and apochromatic lenses, 368
— aberration, 16, 17, 31
— condenser, Abbe's, 308, 309; 311, 312; 385
— Powell and Lealand's, 301-303
— correction, test for, 388
— dispersion, diminished by Huyghens' objective, 42
- Chromatophores of *Peridinium*, 770; of Cephalopods, 942
- Chromatoplasm, 537
- Chroococcaceæ*, characters of, 547
- Chroococcus*, 547; as gonid of lichen, 651
- Chroolepus*, as gonid of lichen, 651
- Chrysaora*, 874, 876; development of, 876

CHY

- Chyle, corpuscles in, 1037
Chytridiaceæ, 636
Cicada, wings of, 998, 999
Cichoriaceæ, pollen-grains of, 721
Cicindela, 987
Cidaris, spine of, 885, 888
 — *metularia*, mode of formation of spines in, 889
 Cienkowski, on decaying cells of *Nitella*, 579 *note*; on parasitic plasmode in *Nitella*, 579 *note*; on reproduction of *Noctiluca*, 769
 Cilia, 532, 1044; of *Infusoria*, 771; use of, in *Ciliata*, 773; of *Turbellaria*, 946
 Ciliary action, 772
 — motion on gills of *Mollusca*, 940
 — movement in protophytes, 535
Ciliata, 771–783; ciliary action of, 772, 774; ‘shield’ of, 773; lorica of, 773; myophan-layer, 773; trichocysts of, 773; ento-parasitic forms, 774; mouth of, 774; foot-stalk in, 774; impressionable organs of, 775; ‘eye-spots’ of, 775; food of, 775; artificial feeding, 776; contractile vesicles of, 776; multiplication of, 777; conjugation of, 777, 782; encystment of, 778–782; dispersion of, 781; desiccation of, 781; Stein on acinetiform young of, 782 *note*
 Ciliate *Infusoria*, general structure of, 754
 Ciliated epithelium, 1044
 Ciliobrachiate zoöphytes, 905
Cilio-flagellata, 770
 Cilium of *Noctiluca*, 766 *note*
Cimex lectularius, eggs of, 1005
Cinchona, raphides of, 696
Cinclidium arcticum, peristome of, 672
Cineraria, pollen-grains of, 722
 Cineritious matter, 1052
 Circulation in ascidians, 912, 915
 — of blood, 1054
 Circumambient chamber in *Orbitolites*, 806
 Cirrhi of *Cirripedia*, 968
Cirripedia, 967
Cladocera, 961
Cladococcus viminatis, 851
Cladonia furcata, 650
Cladophora glomerata, 574; cell division of, 569, 574
Cladorkiza inversa, 860
 Claparède and Lachmann, on *Lieberkuehnia*, 731; on ‘rolling’ movement of *Amaba*, 744
 Clark (James), on *Flagellata*, 764
 Clastic rocks, 1075
Clathrulina elegans, 742
 Clausius on emission of light, 54
Clavelinide, gemmation of, 911; stolons of, 914
Claviceps purpurea, 644
Clavicornia, antennæ of, 987
 Claws, 1029, 1033
 Clay, 1092
 Cleanliness, importance of, 522
Clematis, stem of, 702

COL

- ‘Closed’ bundles, 710
Closterium, cyclosis in, 581; ‘swarming of granules’ in, 581; binary division in, 582; two zygospores in, 584 *note*; zygospore of, 584; form of cell, 585
Clostridia, form of, 653
 ‘Clothes-moth,’ 999
 Clove-pink, seed of, 723
 ‘Club-mosses,’ 681
Clypeaster, spines of, 889
 Coal, ‘bituminous,’ 1084
 Coal-plants, 1083
 Coarse adjustment, 159; ‘stepped’ rack-work for, 161; arrangements for ‘locking,’ 352
Cobaea, testa of seeds of, 725
 — *scandens*, pollen-grains of, 721
Coccidia, 752
Coccidiidæ, 749
Coccidium oviforme, 752
 Cocoliths, 747–749; in chalk, 1084, 1088
Cocconeidæ, characters of, 614
Cocconeis, 615
Cocconeina, 602, 616
 — *fusidium*, 621
 Coccuspheres, 747–749; in chalk, 1088
 Cockchafer, antennæ of, 974. See *Melolontha*
 ‘Cockle’ in wheat, 945
 Cockroach. See *Blatta*
 Cocoa-nut, 725
 — shell of, 693
 Cocos-wood, 704
 Coddington lens, 37
Codium, 563
Codonella, silicious shell of, 773
Colosiga umbellata, fission of, 764; arborescent colonies of, 765
 COLLENERATA, 862–883; bibliography of, 883; permanent gastrula-stage of, 726
 — See ZOÖPHYTES
Coloplatana, 883
 Cœnosarc, of hydroids, 867, 870
Cœnurus, 944
 Cohn, on sexual generation of *Volvox*, 555; on movements in *Oscillatoria*, 548; on reproduction of *Sphaeroplea*, 570
Coleochactaceæ, 575; zoöspores of, 575; trichogyne of, 575
Coleochate, 575
Coleoptera, 973; dermo-skeleton of, 974; scales of, 975; elytra of, 981; eyes of, 983, 987; antennæ of, 987, 988; mouth-parts of, 989; wings of, 999; leg of, 1000
Collops, food of, 776
 Collar correction, 358
 Collared cells of sponges, 856
 ‘Collars’ of *Flagellata*, 764
 ‘Collateral’ bundles, 710
 Collection of microscopic objects, apparatus for, 526–529
Collembola, 977
Colletocema, 602
 Collins’s condenser with rotating sub-stage, 386
Collomia testa of seeds of, 725

COL

Collomia grandiflora, spiral fibres in seeds of, 693
Collozoa, 852
 Colonial *Acinetina*, 784
 Colonies, in *Codosiga*, 764; of Radiolarians, 849; of *Polyzoa*, 924
 Columel of *Sphagnaceae*, 674
Comatula, 900, 901; nerves of, 1052
 'Comb-bearers,' 881. See *Ctenophora*
 Commensalism, in lichens, 650
 Compensating eye-pieces, 34, 273, 378
Composita, laticiferous tissue of, 695
 Compound condenser, sub-stage, 134
 — microscope, construction of, 39; invention of, Govi on, 120
 Compression of light rays, 57
 Compressor, Rousset's, 346; Davis's, 347; Beck's, 347
 Compressorium, 346
 'Concentric' bundles, 710
 Conceptacles of *Fucaceae*, 627; of *Marchantia*, 666
Conchifera, shell of, 919
 Concretionary spheroids, 1100
 Condensers, 190, 298-316
 — Kellner eye-piece used as, 196; Gillett's, 204, 300; Hartsoecker's, 298; Bonamys's compound, 298, 299; Powell and Lealand's, 301, 302, 310; apochromatic, 302; Swift's, 302, 305; immersion, 303, 305; Watson's, 303, 304; Beck's, 304, 305; Zeiss's, 305, 308, 309; Baker's, 306; Webster's, 308; Abbe's, 308, 309; fittings for, 312-314; Swift's, for use with polariscope, 314
 — total aperture of, 307
 — tabular list of, 315
 — achromatic, 300, 304, 305, 306, 311; Brewster on, 299
 — chromatic, 308, 309, 311
 — compound, 134
 — cone of light with, 190
Conferva, 557
Confervaceae, 569, 570; binary division of, 569; zoöspores of, 570; resemblance of *Melosira* to, 608
Conferva, 945, 960
 Conical epithelium, 1044
 Conids, of *Ascomyctes*, 643; of *Basidiomyctes*, 647
Conifera, 684; woody cells of, 697
 Coniferous wood fossilised, 705, 1083
Conjugata, affinities of, 549
 Conjugate foci, 13; focus, 24; image, 24
 Conjugating cells, 540
 Conjugation, a sexual act, 537
 Conjugation of *Mesocarpus*, 549; of *Spirogyra*, 549; of *Ulothrix*, 557; of *Hydrodictyon*, 565; of *Desmidiaceae*, 584; of diatoms, 599; of *Phaeosporae*, 627; of *Myromyctes*, 634; of *Arceella*, 746; (zygosis) of *Gregarinae*, 751; of *Heteromita*, 760; of *Tetramitus*, 761; of *Noctiluca*, 769; of *Glenodinium*, 770; of *Podophrya*, 785; of *Ciliata*, 782; of *Vorticella*, 782

COS

Connective tissue, 1019; fibrous, 1038; corpuscles of, 1039, 1040; areolar, 1040
 Contact metamorphism, 1077
 Continental correctional collar, 359
 — microscopes, objections to, 162
 — model, 254-261; criticism on, 259
 Continuity of protoplasm, 538; in *Flori-dea*, 630
 Contractile vacuole in *Volvox*, 552
 — vesicle, of *Actinophrys*, 737; of *Microgromia*, 737; of *Amæba*, 743; of *Infusoria*, function of, 754; in *Flagellata*, 764; of *Paramecium*, 776; of *Ciliata*, 776; of *Stentor*, 777; of *Rotifera*, 789
 Convergence of light, 18
 Convergent light in petrology, 1070, 1078
 Conversion of relief in spectroscopy, 92
Convolutaceae, laticiferous tissue of, 695
Convolutus, pollen-grains, 721
Copepoda, 960; classification of, 965 note
Copeus cerberus, 791
 Copper sulphate, crystallisation of, 1096
 Coquilla-nut, 725
 — section of, 692
 Coralline crag, microscopic constituents of, 1089
 Corallines, 960
 — conceptacles of, 632; ostiole of, 632
 — (sertulariids), 870
 Corals, section of hard and soft parts, 510
 — red, 877; stony, 878; mushroom, 878
Corella parallelogramma, branchial sac of, 912
Corcopsis tinctoria, seeds of, 724
 Cork, 708
 Corky layer of bark, 708
 Cormophytic type, 668
 Cormorant, parasite of, 1010
 Cornicles of arthropod eyes, 983
 Corn-grains, husk of, 725
Cornuspira, 801, 803
 'Corpuscle' of gymnosperms, 685
 Corpuscles, white, 1037; change of form of, 1038; of connective tissue, 1039, 1041; of blood, flow of, 1056
 Corrected lenses, 382
 Correction collar, 21, 30, 50, 274; English, 357; Continental, 359
 Corroded crystals, 1071
 Corrosive sublimate, as a fixative, 484
Corynaetis Allmanni, thread-cell of, 879
Coscinodisceae, characters of, 608
Coscinodiscus, 588, 620
 — cyclosis in, 587; frustules of, 589, 590; markings on frustule of, 591; areole of, 591
 — *asteromphalus*, 591; for testing lenses, 389
 — *oculus iridis*, 609
 — *punctatus*, fossil, with embryonal form, 598
Cosmarium, division of, 582; form of cell, 585
 — *botrytis*, zygosporic of, 584
 Cosmic dust, 1033

COS

- Costæ of *Campylodiscus*, 607
 Cotyledons, 685
 Cover-glass, 439
 — consequence of using, 19; as section lifter, 478
 — tester, 440; Zeiss's, 440; Ross's, 440; Smith's (J. Ciceri), 441
 — varying thicknesses of, 439; with achromatic objectives, 439; cleaning them, 442
 Cox (J. D.), on structure of frustule in *Isthmia*, 590 note
 Crab, 957; metamorphosis, 969; blood-corpules of, 1038; 'liver' of, 1047
Crabro, leg of, 974
 Crane-fly. See *Tipula*
Craterium pyriforme, 1009
 Crayfish, 957; young of, 969
 Creation of structure by diaphragms, 68
Cribrilina figularis, 906
 Cricket, gizzard of, 993; wings of, 999; sound-producing apparatus, 999. See *Acheta*
Crinoidea, skeleton of, 892; larva of, 898
Crisia, 909
 Crisp (F.), on 'aperture,' 44; on radiation, 57; on collection of microscopes, 117
Cristatella, 909
Cristellaria, shell of, 798, 819
 Critical angle, 6, 7; image, 30, 299; images, 287; mode of obtaining, 409, 410
Crocus, pollen-grains of, 722
 Crouch's adapter for parabolic speculum, 333
 'Crow silk,' 569
 Crown glass, refractive index of, 5; composition of, 32
 Crusta petrosa of teeth, 1025, 1026
 CRUSTACEA, 957-971
 — larvæ of, collecting, 529
 CRUSTACEA, suctorial, 965
 — collecting, 970; preserving, 971; compound eyes of, 982; pigment-cells of, 1043; 'liver' of, 1047; concretionary, spheroids in shells of, 1100
 CRYPTOGAMIA, 530-683
 — preparation of, 514; structure of, 532-535; reproduction of, 535-549; literature, 683; passage to PHANEROGAMIA, 684 and note
Cryptoraphideæ, 599
 Crystalline forms, list of, for microscope, 1099
 Crystallisation, microscopic examination of, 1095-1098
 — effect of temperature on, 1096
 — preservation of specimens of, 1098
 Crystallisation, process of, 1096
 Crystallites, 1072, 1096
 — in glass cavities, 1074
 Crystalloids, 1096
 Crystals, corroded, 1071; in lava, 1071; zonal markings in, 1073; cavities in, 1073; inclusions in, 1074, 1075; micro-

CYP

- scopical structure of, 1075; optical properties and chemical constitution, 1078, 1079; as microscopic objects, 1094; of snow, 1095; as objects for polariscope, 1097
 Crystals, their homogeneous structure, 1094
 — — types of structure 1094
 — — optical properties, 1094
 — — variations in symmetry, 1094
Ctenaria ctenophora, 877 note
 Ctenoid scales, 1028
Ctenophora, 877, 881, 883; excretory pores of, 882 note
Ctenostomata, characters of, 909
Cucurbitaceæ, pollen-grains of, 721
 Cuff's micrometer, 142; microscope, 142
Culicidæ, antennæ of, 988; larvæ, blood of, 994
Curculio, antennæ of, 988
 — *imperialis*, scales of, 975; elytra of, 981
Curculionidæ, 981; foot of, 1000; suckers on, 1002
 Currant, parenchyme of fruit, 685; pollen-tubes of, 723
 Curvature of the field, 388
 'Cushion-star,' 891. See *Goniaster*
 Cuticle, 1041, 1042
 — of leaves, 713; of *Ciliata*, 773
 Cutin, 713
 Cutis vera, 1041
Cutleria, conjugation of, 627
 Cuttle-fish, 929, 942. See *Scpia*
 — 'sepiostaire' of, structure, 929; imitated, 1102
 'Cuttle-fish bone,' structure of, 929
Cyanea capillata, ephyrae of, 874, 875; scyphistoma of, 875; strobila, 875
Cyanthus minor, seed of, 724
 Cyatholiths, 748, 749; artificially produced, 1101
Cycadææ, 684
Cycas, raphides of, 696
Cyclammima cancellata, 816, 818
 Cyclical mode of growth in shell of *Foraminifera*, 798
Cycloclypens, 829; shell of, 798
 — compared with *Orbitolites*, 801, 835
 Cycloid scales, 1028
Cyclops, eye of, 960; larva, 968
 — *quadricornis*, 961; number of offspring of, 964
 Cyclosis, 534; in *Chara*, 576; in desmids, 581; in *Diatomaceæ*, 587; in Phanerogam cells, 688; in plant hairs, 690; in *Lieberkuehnia*, 732; in *Acinetina*, 783
Cyclostomata (Polyzoa), characters of, 909
Cydippe, collecting, 529
 — *pilvæus*, 882
Cymbella, 602
Cymbellæ, affinities of, 616
Cynipidæ, ovipositor of, 1003
Cypræa, shell of, 928
Cypris, 960

CYS

- Cyst, of *Protococcus*, 544, 551; of *Proto-myxa*, 728; of *Clathrulina*, 742; of gregarines, 751; of *Dallingeria*, 759; of *Polytoma*, 760
 Cystic *Entozoa*, relation to cestoids, 944
Cysticerus, relation to cestoids, 944
 Cystids of *Hymenomyces*, 648
 Cystocarp of *Floridæa*, 632; of *Batrachospermum*, 574
Cystopus candidus, 640
Cythere, 960, 961
Cytherina, shells of, in chalk, 1087
 Cytodes, contrasted with plastid, 727
 Cytoplasm, 537

D

- Dallinger and Drysdale's moist stage, 341; tripod, 402; on life-history of monads, 756-763; on effects of temperature on monads, 761
 Dallinger (W. H.), on *Navicula*, &c., as test objects, 600 *note*; on nucleus of monads, 762
 Dallinger's thermo-static stage, 344-346
Dallingeria Drysdali, life-history and structure of, 758; nucleus of, 762
 Dalyell (J. G.), on *Hydra tuba*, 874
Damaeus geniculatus, proventriculus of, 1011
 Dammar, as a preservative medium, 518; as a mounting medium, 521
 Dandelion, laticiferous tissue of, 695; pollen-grains of, 721
Daphnia, eye of, 960; eggs of, 964; ephippial eggs of, 964
Daphnia pulex, 962
 Darwin (Charles), on *Cirripedia*, 967
Datura, seeds of, 724
 Davis, on desiccation of *Rotifera*, 791 *note*
 Dawson (W.), on foraminiferal nature of *Eozoön*, 837
 'Day-fly.' See *Ephemera*.
 'Dead-man's toes,' 879. See *Alcyonium*
 Dean's medium for mounting insects, 973
 De Bary, on fungi, &c., 634 *note*; on potato-disease, 610; on alternation of generations in ferns, 680
 Decalcification, 512; of echinoderms, 512; of bones, 512; of teeth, 512; of *Foraminifera*, 513; of *Eozoön*, 513
Decapoda, 957; exoskeleton of, 968; macrurous, 969; brachyurous, 969
 Decomposition, produced by *Bacteria*, 661
 — of rock-masses, 1076
 Defining power, 425; tests for, 426
 Definition of image, 382
 Degeneration in *Tunicata*, 911
 Dehydration, 487
 Dellebarre's microscope, 114
Delphinium, seeds of, 724
Demodex, legs of, 1010
 — *folliculorum*, 1011

DIA

- De Monconys, his compound microscope, 128
Dendritina, a varietal form of *Peneroplis*, 803
Dendroilus, teeth of, 1091
Dendrosoma, 784
 Dentine, 1019, 1023-1026
 — resemblance of cuticle of crabs to, 969; in placoid scales, 1028
Deparia, indusium of, 675
 — *prolifera*, 676
 Depth of focus, 83, 89; of vision, 88, 89, 90; perception of, 94, 95
 Dermal skeleton of *Vertebrata*, 1026
Dermaleichi, 1008, 1014
Dermanyssus, 1012
 — larva of, 1009
Dermestes, hair of larva, 980
 Descartes' simple microscope with reflection, 126
 Desiccation of rotifers, 791
 Desiderata in a microscope, 261-263
 Desilicification, 513
 DESMIDIACEÆ, 549, 579-587; connection with *Pediatreea*, 566; sutural line of, 580; cellulose envelope, 580; mucilaginous sheath, 580; primordial utricle, 580; endochrome, 580; movements of, 580; cyclosis in, 581; binary division of, 582; sexual reproduction, 584; classification of, 585; habitat of, 586; mode of collecting, 586
 — Häntzsch's glycerin method of preserving, 520
Desmidiæa, 945
 — conjugation of, 584; zygospore of, 584
Desmidium, binary division, 582; filaments of, 583
 Desmids. See *Desmidiaceæ*
 Deutovium of *Acarina*, 1008
Deutzia scabra, stellate hairs of, 714; epiderm of, 715
 Development of *Hydra*, 866, 867; of hydroids, 868; of embryo in *Gastropoda*, 919; of molluscs, 933; of *Annelida*, 949; of *Tomopteris*, 953; of insects, 1007
 Deviation, 9
 'Diamond Beetle,' 975
Dianthus, seed of, 723
 — *caryophyllæus*, parenchyme of, 688
 Diaphragm, 261, 297, 306, 308, 310, 312, 313, 314
 — with two openings for double illumination, 104
 — Zeiss's iris, 297; calotte, 297; in eye-pieces, 376-379, 381; for use in testing object-glasses, 385, 386
 — in Tully's microscope, 119
Diatoma, 588; frustules of, 588, 605
 — *calgare*, chains of, 605
 DIATOMACEÆ, 549, 587-625
 — perforated membrane of, examined with annular illumination, 119; mode of examination of, 419; mounting, 481; silicious coat, refractive index of, 521; stipes of, 588; beaded appearance, 592;

DIA

markings of, 593; binary division of, 594-597; reproduction of, 594-601; plachromatic, 598; coccochromatic, 598; conjugation of, 599; zygospores of, 599; gonids of, 599; movements of, 601; classification of, 602; habits of, 619; habitats of, 620; distribution of, 621; fossil forms of, 622; used as food, 622; collecting, 622; cleaning, 623, 624 *note*; mounting, 624; as food of *Ciliata*, 775; in mud of Levant, 1085

Diatom-frustules in ooze, 1086

Diatomin, 587

Diatoms in stomach of ascidians, *Holothuria*, &c., 614, 623

Diatoms. *See* DIATOMACEÆ

Dichroism, 1098. *See* PLEOCHROISM

Dickiea, 602

Dicotyledonous stems, fossilised, 1083

DICOTYLEDONS, stem of medullary rays of, 702; epiderm of, 712

Dictyocalyx pumiceus, 861

Dictyochya fibula, 620

Dictyocysta, silicious shell of, 773

Dictyoloma peruviana, winged seed, 724

Dictyospyris clathrus, 847

Dictyota, cœspheres of, 627

Didemnians, 914

Didymium serpula, plasmode of, 635

Differential screw, Campbell's fine adjustment, 162, 164, 165, 174, 202, 230

Differential staining, 493

Differentiation of cell, 533

Diffugia, 746; test of, 746

Diffraction, 62

— Abbe's theory of, and homogeneous immersion, 363

— Fraunhofer's law, 57

— rays are image-forming, 59

— spectra, 28, 67; phenomena, 62, 64; image, 64, 72; experiments, 66-70; fan of isolated corpuscles, 72; problem, 73; pencil, 74, 75; hypothesis of Abbe, 74; fan, 75; theory, application of, 76, 78; bands, 277; phenomena, Abbe's experiments, 434; ghost, 435

Digestive vesicles of *Ciliata*, 776

Digitalis, seeds of, 724

Dimorphism in *Foraminifera*, 802

Dinobryon, 765

Dinoflagellata, 770

Dinomastigophora, 770 *note*

Dioptric investigations by Gauss, 106-110

Dioptrical image, 30, 72

Diorite, fluid inclusions in, 1074

Dipping tubes, 350

Diptera, 973; eyes of, 987; antennæ of, 988; mouth-parts of, 990; wings of, 998; ovipositor of, 1003; imaginal discs of, 1007

Direct division of nucleus, 538

'Directive vesicles' of egg of *Purpura*, 937

Disc-holder, Beck's, 339

DYT

Discida, 849

Discoliths, 748, 749; artificially produced, 1101

Discorbina, 824

— *globularis*, 798

Disintegration of rock-masses, 1076

Dispersion, 9, 17; in glass, 31

— and desiccation of encysted *Ciliata*, 781

Dispersive power, 2, 9, 18; of flint glass, 10

Dissecting apparatus, 455

— microscope, Greenough's binocular, 248; Stephenson's binocular, 248; Huxley's, 251; Zeiss's, 251, 253

Bausch and Lomb's, 252

Distance of projection of image, 26, 27

Distinct vision, 26

Distoma, life-history of, 946

— *hepaticum*, 945

Divergence of light, 18

Divini's compound microscope, 129

Division, binary, of cells, 535; of desmids, 582

— artificial, of *Actinosphaerium*, 741 *note*

— of naiads, 955

Dobie's line, 1049

Dog-fish, scales of, 1028

D'Orbigny, on plan of growth of *Foraminifera*, 799

Doris, spicules in mantle, 928, 929; nidamentum of, 934; eggs of, 942; spines of, imitated, 1101

— *bilamellata*, development of, 935-937

— *pilosa*, palate of, 931

— *tuberculata*, palate of, 931

Double illumination, Stephenson's method, 105

Doublet, Wollaston's, 36, 153

Dragmata, of sponges, 860

Dragon-flies, wings of, 998

Dragon-fly, facets in eyes of, 983

— *See* Libellula

Draparnaldia glomerata, 574

Draw-tube of microscope, 157

Drebbel's modification of Keplerian telescope, 121

Dredge, 528

Drepanidium ranarum, 752

Drone-fly. *See* *Eristalis*.

Dropping-bottle, 476; German, 477; expansion, 477

Drosera, glands of, 714; seeds of, 724

Dry-mounting, Smith's 'cells' for, 446

Ducts of Phanerogams, 698

Dudresnaya, fertilisation in, 632; fertilising tubes, 632

Dujardin, on 'sarcode,' 530 *note*

— separates *Amœba* from *Infusoria*, 733

Dunning's zoöphyte trough, 348

Duramen, 704

Dwarf-male of *Ædogonium*, 572

Dytiscus, eye of, 987; antennæ of, 988; spiracle of, 996; trachea of, 996; foot of, 1001, 1002

EAR

E

- Earth-stresses, 1077
 Earwig. See *Forficula*
Eccremocarpus scaber, winged seeds of, 724
 Echinoderm larvæ, collecting, 900; preparing, 900; mounting, 900
 — skeletons in mud of Levant, 1085
 ECHINODERMATA, larvæ of, collecting, 529
 — 884-903; skeleton of, 884, 891, 892, 894; spines of, 885-889, 891; pedicellariæ of, 889; teeth in, 890, 892; preparation of skeleton spines, &c., 892; internal skeleton, 894; larvæ of, 896
 Echinoderms, decalcification of, 512
Echinoides, skeleton of, 884; spines of, 885; pedicellariæ of, 889; larva of, 898; direct development in, 900 *note*
Echinometra, spine of, 886, 892; colour of spines, 888
Echinus, shell of, 885, 886; spines of, 885; teeth of, 890
 — *lividus*, coloured spines of, 887
Ectocarpus, 626
Ectocarpus siliculosus, conjugation of, 627
 Ectoderm, 726
 Ectoplasm, 535
Ectoprocta, 909
 Ectosarc, 534; in *Rhizopoda*, 733; experiments on, 743; of *Ciliata*, 773
Edentata, cement in teeth of, 1026
 Edible crab, metamorphosis of, 970
 Edwards (A. M.), on supposed 'swarm-spores' of *Amaba*, 744
 Eel, scales of, 1027
 'Egg without shell,' concretionary spheroids in, 1100
 Egg-capsule of *Cyclops*, 961
 Egg-sacs of *Lernæa*, 966
 Egg-shell membrane, 1038
 Eggs of *Sepiola*, *Doris*, 942; of *Acarina*, 1005; of insects, 1005
 Ehrenberg, on eye-spot in *Protococcus*, 543; on *Volvox*, 551; on structure of frustules, 590; on rapidity of reproduction of *Paramecium*, 777; on internal casts of *Foraminifera*, 827 *note*; on fossil *Radiolaria*, 854 *note*
Elaagnus, raphides in pith of, 696; peltate scales of, 714
 Elastic ligament of bivalves, structure of, 1040
Elaters, antennæ of, 988
 Elaters of *Marchantia*, 668; of *Equisetarva*, 680
Elatine, seeds of, 724
 Elder, pith of, 687
 Ellis's aquatic microscope, 147
 Elm, raphides of, 696
Elodea canadensis, cyclois in, 689
 Elytra of *Coleoptera*, 981, 999
 Embryo of Phanerogams, 723
 — cell of fern, development of, 679

EPI

- Embryo-sac, 685
 — of ovule in Phanerogams, 534; free-cell formation in, 536
 Emission of light, power of, 51, 54; unequal, 52
 Emitted light, unequal intensity of, 51
Empusa musca, 642
 Enamel of teeth, 1025
 — of teeth of *Echinus*, 891
 — on ganoid scales, 1028
Encephalartos, raphides of, 696
Enerinites, 892
 End-bulbs, 1053
 Endochrome, 533; of *Palmoglava*, 541; of *Spirogyra*, 550; of *Volvox*, 551, 552, 554; of desmids, 580
 Endosperm, 726
 Endogenous spores of *Macrorini*, 640
 — stems, 700-712
 Endogens, spiral vessels of, 698
Endonema, 602
 Endoplasm, 708
 Endoplasm, 533
 Endosarc, 533; in *Rhizopoda*, 733; of *Ciliata*, 773
 Endosperm, 685
 Endospores of mosses, 672; in ferns, 677; of *Volvox*, 556; of *Hymenomyces*, 648
 Endosporous *Bacteria*, 655
 Enoch's metallic ring for mounting, 482
 Entomophilous flowers, 722
Entomophthoræa, 642
Entomostraca, 957, 959-965; desiccation of, 963; agamic reproduction of, 963; eggs of, 964; development of, 965; eye of, 982; non-sexual reproduction, 1006
 — collecting, 529
 — *Rotifera* upon, 787
 Entomostracan eggs as food of *Ciliata*, 775
Entoprocta, 909
Entosphaerida, 850
Entozoa, 943
Eolis, nidamentum of, 934
Eozoon, 837; mounting, 481; mode of growth of, compared with that of *Polytrema*, 824; canal system compared with *Calcarina*, 825; affinities of, 838; intermediate skeleton, 839; mummuline layer, 839; internal cast of, 840; asbestiform layer, 841; pseudopodia of, 841; young of, 842
 — *canadense*, 837
 — decalcification, 513
Epira, foot of, 1015; silk threads of, 1015
Ephemera, branchiæ of larva, 997
 — *marginata*, larva of, 973; circulation of blood in larva of, 994
 Ephippial eggs of *Rotifera*, 790
 Ephyrae of *Cyanea*, 875; of *Chrysaora*, 876
 Epiblast, 726 *note*
 Epiderm of leaves, 712
 Epidermic appendages, 1029

EPI

Epidermis, 1041, 1042; method of examining, 1043
 Epidote, 1076
Epilobium, emission of pollen-tubes, 722
Epipactis, pollen-tubes of, 723
 Epiphloeum, 708
 Epispore of *Mucorini*, 642
 Epistome of *Polyzoa*, 909; of *Actinotrocha*, 950
Epistylis, collecting, 527
 Epithelium, 1043, 1044
Epithemia, conjugation of, 599; zygospores of, 599
 — *turgida*, 604
 Equiconcave lens, 22
 Equilucous zones of light, 368
Equisetacea, 680; in coal, 1084
Equisetum, spores and elaters of, 681; epiderm of, 715; silex in, 715
 Equitant leaves of *Iris*, &c., 717
 Erecting binocular, Stephenson's, 100
 — prism, Stephenson's, 101
 Ergot, 644
Erica, seeds of, 724
Eristalis, eye of, 987; antennae of, 988
 Error of centring, 389
Erythropis agilis, eye-spot of, 775
Eschara, calcareous polyzoaries of, 909; extension of perivisceral cavity, 927
 Ether as a solvent, 517
 Ether-freezing microtome, Hayes's, 472; Cathcart's, 474
Ethmosphera siphonophora, 850, 851
Eucalyptia vulgaris, 669
Eucopopoda, 965 note
Eucyrtidium elegans, 847, 852
 — *Mongolfieri*, 847
 — *tubulus*, 847
Eudorina, sexual process of, 557
Euglena, 545, 765
Euglypha alveolata, reproduction of, 746
 Euler's microscope, 148
 Euler on achromatic microscopes, 147
Eunotia, 604
Eunotice, characters of, 604
Euphorbiaceae, laticiferous tissue of, 695
Euphrasia, micropyle of, 723
Euptectella aspergillum, 860 note
Eupodiscea, characters of, 612
Eurotium repens, 643
 Evening primrose, emission of pollen-tubes, 722
 'Exclamation markings' on scales, 978
 Excretory organ of *Rotifera*, 789, 790
 Exner (S.), on the image in eye of *Lampyris*, 984
 Exogenous stems, 700
 — stem, structure of, 708
 — and endogenous stems contrasted, 709, 710
 Exogens, fibro-vascular bundles, 697, 698; medullary sheath of, 698; spiral vessels in, 698
 Exoskeleton of decapods, 968
 Exospores of mosses, 672; of ferns, 677; of *Hymenomyces*, 648

FER

Extinction, straight, 1079
 — angle, measurement of, 1079
 Extine of pollen-grains, 720; markings on, 720
 Eye, accommodation of, 88
 — of *Pecten*, 940; of *Onchidium*, 941; of slug, 941; of snail, 941; of arthropod, structure of, 983
 Eye-glass of compound microscope, 36, 39
 Eye-lens, 376
 Eye-piece, 375-381; Abbe's compensation, 40, 378; Huyghenian, 40; Kellner's, 42, 376; Ramsden's, 43, 378; Campani's, 376; Huyghens', 376; Nelson's new Huyghenian, 377; Watson's Holoscopic, 379
 — binocular, Tolles', 101; Abbe's, 102
 — Kellner's, as condenser, 196
 — micrometer, 271-277, 380; orthoscopic, 376; projection, 380, 381; index, 381; pointer in, 381; diaphragms in, 381
 — stereoscopic, Abbe's, 102
 Eye-pieces, classification of, by Abbe, 34; compensating, 34, 35, 378; negative, 376, 377; positive, 377; solid, 378; searcher, working, projection, 378
 Eyes on *Chiton* shells, 941
 — compound, of insects, 982, 983
 — compound, 982-987; simple, 982, 986; preparing, 986; mounting, 986

F

Faber, inventor of the name microscope 124, 125
 Falciform young of *Coccidia*, 752
 False images, 419
 Farrant's medium, 478, 520; for mounting insects, 973
 Farre (A.), on structure of *Polyzoa*, 908 note
Farrella, polyzoaries of, 909
 Fat, 1045
 Fat-cells, 1018, 1040, 1042, 1045; capillary network around, 1062
 Fats, solvents for, 517
 Feathers, 1029, 1032
 'Feather-star,' 900. See *Antedon*
 Feeding, mode of, in *Actinophrys*, 738; in sponges, 856
 Feet of insects, 1000-1002; of spiders, 1014
 Felspar, decomposition of, 1076, 1077
 Felspar rock, effect of dynamic metamorphism on, 1077
 Felspars, zonal structure in, 1073
 'Female' plants of *Polytrichum*, 671
 Fermentation of alcohol by yeast, 646; by *Penicillium*, *Mucor*, &c., 647
 — putrefactive, 661
 Fermentative action of *Fungi*, 532
 Ferns (see *Filices*), 674; in coal, 1084
 Fertilisation of Phanerogams, 722
 Fertilisation-tubes of *Peronosporae*, 638
 Fertilising tube of *Dudresnaya*, 632

FES

- Festuca pratensis*, paleæ of, 715
 Fibres and cells of Vertebrates, 1018, 1019
 Fibro-cartilage, 1019, 1046
 Fibro-vascular bundles, 697, 708, 710
 — of ferns, 674; in the 'veins' of leaves, 697; of Exogens, 697, 698; of Phanerogams, 700
 Fibrous tissues of Vertebrates, 1019
 — tissue, 1038; white, 1039, 1040; yellow, 1040
 Field of eye-pieces, 379
 Field-glass, 40
 Field-lens, 376; applied to eye-lens by de Monconys, 128, 376; by Hooke, 128, 376
 FILLICES, 674-680; stem, structure of, 674; fructification of, 675; prothallium of, 677; antherids of, 677; archegones of, 677; development of, 679; apospory in, 680; apogamy in, 680; alternation of generations in, 680
 'Filiferous capsules.' See Thread-cells
 Finder, 295; Maltwood's, 296
 Fine adjustment, 162-175
 — — applied to the stage by Powell, 155; by moving the whole body, 162; by simply moving the nose-piece, 162, 173; continental, 162-164; Campbell's differential screw, 164; Zeiss's, 166; Reichert's, 171; Watson's lever, 172; Swift's vertical side-lever, 173; Powell's, 174
 Fire-fly, antennæ of, 987
 'Fire-fly,' 984, 988. See *Lampyris*
 Fish, circulation in tail of, 1057; on yolk-sac, 1057
 'Fish-louse,' 966
 Fish-scales, concretions in, 1101
 Fishes, lacune in bone of, 1022; dentine of, 1023; cement of teeth in, 1026; plates in skin of, 1026; red blood-corpuscles of, 1034, 1035; pigment-cells of, 1043; muscle fibre of, 1049; gills of, 1063
 Fission in *Lieberkuehnia*, 733; of *Monas*, 756; of *Monosiga*, 764; of *Codosiga*, 764; of planarians, 947
Fissipennes, wings of, 999
 Fixation, 484-487
 Fixing agents: alcohol, 484; corrosive sublimate, 484; osmic acid, 485; picric acid, 485
 Flabella of *Licmophora*, 605
 Flagella, 532; of *Bacteria*, 652, 658, 659
Flagellata, 755-771
 — experiments on, 761; nucleus in, 762; karyokinesis in, 763; colonial forms, 764
 collared, resembling cells of sponges, 855
 Flagellate chambers of sponges, 856, 857
 Flagellum of *Noctiluca*, 766 note
 Flat bottle for collecting, 527
 Flatness of field, 425
 Flea, presumed auditory organ of, 422;

FOR

- hairs on pygidium of, as a test, 421
 mounting medium for, 973
 'Flesh,' 1048
 Flint, derivation of, 622
 — glass, refractive index of, 5; dispersive power of, 10; composition of, 32
 — implements found with *Orbitolina*, 824
 Flints, preparation of, 1089
 Floral envelope, 718
Florulæ, 630-632; affinities of, 630
Flosculariada, 791
 Floscules in confinement, 528
 'Flowering fern,' sporanges of, 676
 'Flowering plants,' 684. See PHANEROGAMIA
 Flowers, 718-723; Inman's method of preparation, 719
 'Flowers of tan,' 634
 Fluid inclusions in crystals, 1074
 'Fluke,' 945
 Fluorite lenses for apochromatic objective, 35, 366
Flustra, mode of growth in, 904; gemmation in, 906; number of polypides, 908; polyzoaries of, 909; extensions of perivisceral cavity in, 927
Flustrella concentrica, 847
 Fly, various instructive organs to be obtained from, 972; eye of, facets in, 983; proboscis of, 989; circulation in wing of, 994; spiracle of, 996; areole on wings of, 998; foot of, 1000
 Focal alteration and form of objects, 421
 — depth, 38
 — distances, by feeling, 177
 — length of a plano-convex lens, 15
 Focke on *Navicula* and *Savirella*, 602 note
 Focus, virtual conjugate, 14, 25; principal, 16; mean, 17; virtual, 22; conjugate, 24; depth of, 83, 89
 — of lenses, 13, 21, 22; chromatic, 16
 Focussing arrangements, 159-175
Fontinalis antipyretica, 671
 Food of *Hydra*, 685
Foraminifera, 733, 795-846
 — study of, by means of Beck's dish-holder, 339; examination of, 423; wooden slides for mounting, 450; method for sectionising, 508 note; decalcification of, 513; structure of, 795; chamberlets in, 798, 803, 804, 806; cyclical mode of growth in, 798; plans of growth, 798, 804; porcellanous shells, 799; vitreous shells, 799; tubulation of shell in, 799, 800; rotaline type, 800; nummuline type, 800; intermediate skeleton of, 801; canal system of, 801; *Porcellanica*, 801; fossilised forms of, 801, 804, 812, 824, 837; dimorphism in, 802; secondary septa in, 803; *Arenacea*, 810; sandy isomorphs, 814; nodosarine type, 815; *Vitrea*, 819; internal casts, 823, 827 note; nummuline series, 826; alar prolongations, 830, 831; interseptal

FOR

- canals, 830; marginal cord in, 830, 834;
collecting, 843; method of separating
from sand &c., 844; mounting, 845;
tubuli of, compared with those of den-
tine, 1020; in mud of Levant, 1085;
in rocks, 1085; internal casts of, 1090
- Forbes, on reproduction of *Sertulariida*,
870
- Forceps, 351
— slide, 453
— stage, 339
- Forficula*, antennæ of, 988
- Forficulidæ*, wings of, 999
- Form of objects and focal alteration,
421
- Formation of microscopic images, 43
- 'Formed material,' 1018; of fibrous
tissue, 1019; of dentine, 1020
- Fossil coniferous wood, 705, 1083
- crinoids, 892; echinids, 892
- *Cypridæ*, 960
- *Foraminifera*, 801, 824-826
- *Lituola*, 816
- *Radiolaria*, 846, 854 *note*
- *Saccaminina*, 812
- sponges, 1089
- wood, 705, 706
- Fossilised *Foraminifera* (*Eozoön*), 837
— wood, sections of, 712
- Fragilaria*, 605
- Fragulariæ*, characters of, 605
- Fragmentation of nucleus, 538
- Fraunhofer's law of diffraction, 57
- achromatic doublet, 148
- lines, 323-326
- Fredericella*, collecting, 528
- Free-cell formation, 535, 719
— — in embryo-sac, 534, 536
- Freezing apparatus for Thoma's (Jung's)
microtome, 467
— microtome, Hayes's, 472; Cathcart's,
474
— imbedding by, 505
- Fresnel, on Selligie and Adams's micro-
scope, 148; on range of magnification,
149
- Freyana heteropus*, legs of, 1010
- Fripp's method of testing object-glasses,
386
- Frog, blood corpuscles of, 1034, 1035;
muscle fibre of, 1049; papillæ on tongue
of, 1053; circulation in mesentery of,
1056; circulation in tongue of, 1056;
lung of, 1063
- Frog's bladder, histology of, as seen with
apochromatic, 372
— foot, epithelium of web of, 1044; cir-
culation in web of, 1055
- Fruond of *Phacosprea*, 626
- Fructification, gonidial, 541; sexual, 541
— of thallophytes, 540; of *Ascomycetes*,
642; of lichens, 649; of mosses, 670;
of ferns, 675; of *Equisetaceæ*, 680
- Frustules of *Diatomaceæ*, 588; shapes
of, 588, 589; structure of, 589, 590
note; girdle, 589; ostioles in, 590;
markings on, 591; character of, as basis

GEL

- of classification, 602; of *Coscinodiscus*,
609
- Fucaceæ*, 627; conceptacles of, 627
- Fuchsia*, pollen-grains of, 722
- Fucus*, 626
- Fucus platycarpus*, 627, 628
— *vesiculosus*, 629
- Fulgoridæ*, wings of, 999
- Funaria hygrometrica*, 669
— sporangium of, 671
- FUNGI, 540, 633-664
- preparation of, 514; zymotic action of,
532; alternation of generations in
classification of, 634; parasitic on in-
sects, 642
- Fungia*, lamellæ of, 878
- Fungiform papillæ, 1053
- Fungus-cellulose, 633
- Fusion in *Dallingeria*, 759
- Fuss's description of a microscope, 147
- Fusulina*, 825, 826, 1090
- Fusulina*-limestone, 825, 1085

G

- Gabbro, 1095
— fluid inclusions in, 1074
- Gad-fly, ovipositor of, 1004
— See *Tabanus*
- Gaillonella proceræ*, 621
— *granulata*, 621
— *biseriata*, 621
- Galileo, inventor of the compound micro-
scope, 120-125; Viviani's life of, 120;
his invention of compound microscope,
Wodderborn on, 121; his *occhialino*,
121, 124; his *occhiale*, 122, 124; his
microscope, 127
- 'Gall-flies,' ovipositor of, 1003
- Galley-worms. See *Myriopoda*
- Gamasidæ*, legs of, 1010; integument of,
1010; Malpighian vessel of, 1011;
heart of, 1011; tracheæ of, 1011; cha-
racters of, 1012; reproductive organs
of, 1012
- Gamasus terribilis*, mandibles of, 1009
- Ganglion-globules (cells), 1051
- Ganglionic cells, 1054
- Ganoid scales, 1028
- Garlic, raphides of, 696
- Garnets, 1077
- Gas bubbles in glass cavities, 1074
- Gaseous inclusions in crystals, 1075
- Gastropoda*, palates of, mounting, 481;
palate of, 919; development of, 919;
shell structure of, 928; embryonic
development of, 934-940; organs of
hearing in, 941
- Gastrula, 726; -stage in *Calenterata*,
726; formation of, 726 *note*; of zöo-
phytes, 862; of *Gastropoda*, 935; of
blowfly, 1007
- Gauss's optical investigations, 106-110;
his dioptric investigations, 106-110; his
system, practical example of, 111-116
- Gelatinous nerve-fibres, 1052
— — in sympathetic, 1054

GEM

- Gemellaria*, polyzoary of, 909
 Gemmæ of *Marchantia*, 666, 667; of *Salpingoeca*, 764; of *Suctorina*, 784; in *Foraminifera*, 798; of *Polyzoa*, 906
 Gemmation and shape of shell in *Foraminifera*, 796
 Gemmules of *Noctiluca*, 769; of sponges, 857
Gentiana, seeds of, 724
Geodia, spicules of, 859, 1086
 Gephyrean worm, 950
Geranium, glandular hairs of, 714; cells of pollen-chambers, 720; pollen-grains, 720
 Germ-cells of *Folvox*, 555; of *Marchantia*, 668; of mosses, 671; of ferns, 679; of *Phanerogams*, 685; of sponges, 857; of *Hydra*, 866
 'Germinal matter,' 1018; of fibrous tissue, 1019; of dentine, 1020
Gesneria, seeds of, 724
 Ghostly diffraction image, Nelson on, 72 note
 Gibbes (Heneage), on staining *Bacteria*, 515
 Gifford's screen, 321
 Gill (C. Houghton), on the 'dots' of *Navicula*, 593
 Gillett's condenser, 204, 300
 Gills of tadpole, 1057, 1059
Giraudia, conjugation of, 627
Girvanella, 1084
 'Gizzard' of insects, 993
 Glanders, 661
 Glands, structure of, 1047
 — of *Drosera*, 714
 Glass-cavities in crystals, 1074; gas bubbles in, 1074
 'Glass-crabs,' 968
 Glass inclusions in crystals, 1074
 — rings for cells, 446-448
Glaucium luteum, cyclosis in, 691
Glennodinium cinctum, conjugation of, 770
Globigerina, shell of, 798; mud, 811; pseudopodia of, 821; mode of life of, 821; Wyville Thomson's views on, 821; Carpenter's views on, 822
Globigerina bulloides, 820; in the 'ooze,' 1086
 — *conglobata*, 821
 — ooze, 820, 1085; resemblance to chalk, 1087
 — *rubra*, colour of, 799
 Globigerine shell, sandy isomorph of, 814
Globigerinida, 820
 Globule of *Chara*, 577, 578
 Globulites, 1096
 Glochidia of *Anodon*, 933
Glowcapsa, 547; as gonid of lichen, 651
 Glow-worm, 984; antennæ of, 988
 Glue and honey cement, 444
 Gluten of grass seeds, 725
 Glycerin, as preservative medium, 518, 520; Hüntzsch's method, 520; Beale's method, 520

GRE

- Glycerin-jelly, Lawrence's mounting in, 480, 519; solvent for CaCO_3 , 520; for mounting insects, 973; for mounting cartilage, 1047
Glyciphagus Kramerii, 1013
 — *palmitifer*, 1008
 — *platygaster*, 1013
 — *plumiger*, 1008; hairs of, 1010
Gnathostomata (Crustacean), 965 note
 Goadby's solution for mounting cartilage, 1047
 Goes (Dr.), on affinity of *Carpenteria*, 823
 Goette, on development of *Antedon*, 903
 Gold size, 443
Gomphonema, stipe of, 588, 616; movements of, 602; attacked by *Fampyrella*, 730
 — *geminatum*, 616; stipe of, 616
 — *gracile*, 621
Gomphonemæ, characters of, 616
Goniaster equestris, spines of, 891
 Gonidial cells, 541
 — fructification, 541
 — layer of lichens, 649
 Gonidiophores of *Peronosporæ*, 639
 Gonids, or non-sexual spores of Cryptogams, 541 note; of *Vaucheria*, 562; of *Podosphecia*, 597; of *Floridæ*, 631; of *Fungi*, 633; of *Peronosporæ*, 639
Goniocidaris florifera, spine of, 888
 Gonium, 545
 Gonotheceæ of *Campanulariida*, 870
 Gonozoid of hydroids, 868; of *Syncooryne*, 869; of *Tubularia*, 869
 Gonozoids of *Sertulariida*, 870
Gordius, 944, 945
Gorgia, spicules in, 929
 — *guttata*, spicules of, 880
Gorgia, 877; spicules of, in mud of Levant, 1085
 Goring (Dr.), on magnification of objects, 43
 'Gory dew,' due to *Palmella cruenta*, 558
 Govi, on invention of microscope by Galileo, 120
 Graduated rotary stage, 395
Grammatophora, chains of, 588, 607
 — *angulosa*, 620
 — *marina*, 607
Grammatophora parallela, 620
 — *serpentina*, 607
 — *subtilissima*, 607
 Granite, 1095
 — fluid inclusions in, 1074
Grantia, 857, 861; spicule of, 1086
 Grasses, nodes of, 701; silex in epiderm of, 715; paleæ of, 715; seed of, 725
 Grasshopper, gizzard of, 993; wings of, 999
 Green glass for softening light, 321, 417
 Greensands, microscopic constituents of, 1090
Gregarina, characters of, 749; movement of, 750
 — *gigantea*, in lobster, 749 note
 — *Sanuridis*, 751

GRE

HET

Gregarinula, 749
 Gregory (J. W.), on *Eozoön*, 843 *note*
 Gregory (W.), on species of diatoms, 600 *note*
 Greville, on *Spatangidium*, 610; on *Triceratium*, 613 *note*
 Grey matter, 1052
 Griffith's turn-table, 451
Griffithsia, 630
 Grinding sections of hard substances, 506
 Grindl's microscope, 132
Gromia, 734-736, 796
 — and *Arcella*, pseudopodia of, contrasted, 746
 Ground-mass of rocks, 1072
 Groundsel, pollen-grains of, 722
 Growing slides, Botterill's, 340; Maddox's, 341; Lewis's, 341
 Guard-cells, 715
 'Gulf-weed,' 630
 Gum and glycerin, 520; and syrup, as a preservative medium, 519
 — imbedding for vegetable substances, 514
 — arabic, formula, 445; for freezing, 505
 — resins, latex of, 695
 — styrax, as a mounting medium, 521; index of refraction, 521
Gyges, 545
Gymnochroa, 868
Gymnolæmata, 909
 Gymnosperms, fossilised, 1084
 — generative apparatus in, compared with Cryptogams, 684
Gypsina, 824

H

Haddon, on budding in *Polyzoa*, 907 *note*
 Haeckel (E.), on *Radiolaria*, 846; on Hydrozoön affinity of *Ctenophora*, 877 *note*
 — and Hertwig, on classification of radiolarians, 849 *note*
Hæmamebide, 752 and *note*
Hæmatococcus, red phase of *Proto-coccus*, 543
 — *sanguineus*, 558
 Hæmatoxylin, solutions, 491, 492
Hæmionitis, sori of, 675
Hæmosporidia, 749
 Haime (Jules), on development of *Trichoda*, 780
 'Hair-moss,' 671
 'Hair-worm,' 944
 Hairs of leaves, 714; of insects, 980; of *Acarina*, 1010; of mammals, 1029
Halicaride, 1013
Haliomma Humboldtii, 851
 — *hystrix*, 848
Haliotis (diatom), 613
 — (mollusc), shell structure of, 928; palate of, 931
Haliphysema, 814; sponge-spicules in, 822

Haller, on auditory organs of *Acarina*, 1010
 Halteres of *Diptera*, 1000
 Hand-magnifier, Brewster's, 37
 Hansging, on movement of *Oscillatoriaceæ*, 548
 Häntzsch's glycerin method for desmids, 520
Haplophragmium, 814
 — *globigeriniforme*, 813
 Hardening agents, 484-487; corrosive sublimate, 484; alcohol, 484; osmic acid, 485; picric acid, 485
 Hardy's flat bottle for collecting, 527
Harpalus, antennæ of, 988
 Harting, on Janssen's microscope, 120; his experiments on formation of concretions, 1101
 Hartnack, on immersion system, 27
 Hartnack's model, 256
 Hartsoeker's simple microscope, 134; his condenser, 134, 298
 'Hart's-tongue,' 675. See *Scolopendrium*
 'Harvest-bug,' 1013
 'Haus' of *Appendicularia*, 918
 Haustellate mouth, 992
 Haustellium, 992
 Haversian canals in bone, 1021
 Haycraft (J. B.), on structure of striated muscle fibre, 1049
 Hayes's ether freezing microtome, 472; minimum thickness of sections therewith, 473
 Hazel, peculiar stem of, 704; pollen-grains of, 722
 Hearing, organs of, in *Gastropoda*, 941; in *Cephalopoda*, 941
 Heart of ascidians, 912; of *Acarina*, 1011
 Heartsease, pollen-tubes of, 723
 'Heart-wood,' 704
 Heating-bath, Mayer's, 453
Heliopelta, 588, 611
Heliozoa, characters of, 734; examples of, 737-742
Helix pomatia, teeth of, 930
 — *hortensis*, palate of, 930
 Heller's porcelain cement, 521
 Helmholtz on aperture, 47
Hemiasler cavernosus, development of, 900 *note*
Hemiptera, eyes of, 987; wings of, 999; suctorial mouth of, 1000
 Hensen's stripe, 1049
Hepatica, 665; thalloid, 668; foliose, 668; elaters of, compared with spiral cells, &c., of pollen-chamber, 720
Herbivora, arrangement of enamel in teeth of, 1025; cement in teeth of, 1026
 Herring, scales of, 1028
 Herschel's doublet, 309
 Hertel's compound microscope, 137, 139
 Hertwig's research on *Microgromia*, 735 *note*; on *Actinia*, 877 *note*
Heterocentrotus, spine of, 885
 — *mammillatus*, spine of, 887
 Heterocysts of *Nostoc*, 549

HET

- Heteromita uncinata*, life-history of, 760
Heterostegina, 834
 Heurck (Van), on markings of diatoms, 593
Hexarthra, 792
 Hicks, on amœbiform phase of *Volvox*, 556; on preparation of insect antennæ, 989 *note*; on structure of halteres and elytra, 1000
Himantidium, 604
Hipparchia janira, eggs of, 1005
Hippopus, 613
Hippothena, 909
 Holland's triplet, 37
 Hollis's liquid glue, 44½
 Hollyhock, pollen-grains of, 721, 722
Holothuria botellus, plates of, 895
 — *edulis*, plates of, 895
 — *inhabilis*, plates of, 895
 — *vagabunda*, plates of, 895
Holothurie, diatoms in stomach of, 614, 623
Holothurioidea, skeleton of, 894; pharyngeal skeleton of, 895 *note*; plates in skin of, 895; preparation of calcareous plates, 896; abbreviated development in, 900 *note*
Hollenia Carpenteri, 861
Homocladia, 602
 Homogeneous, word first applied to lenses, 30
 — immersion, 364; Abbe's combination, 365
 — immersion lenses of Powell and Lealand, 30; of Zeiss, 29
 — objectives, value of, in study of monads, 762
 — system, 28
Homoptera, wings of, 998, 999
 Hood of mosses, 671
 Hoofs, 1029, 1033
 — sections of, mounting, 481; for polariscope, 481
 Hooke's adoption of field-lens to eye-lens, 128, 376
 — compound microscope, 128
 Hooked monad, 760
 Hooker (J. D.), on diatoms of antarctic circle, 621
 Hooklets on wings of *Hymenoptera*, 999
Hoplathora, 1012
 — maxille of, 1010
 Hormones of *Oscillatoria*, 547; of *Rivularia*, 548; of *Scytonema*, 548; of *Nostoc*, 549
Hormosira globulifera, 813, 815
Carpenteri, 815
 Hornblende, 1077
 — corroded crystals of, 1072; pleochroism in, 1078
 Hornet, wing of, 999; sting of, 1003
 Horns, 1029, 1033
 Horny substances, chemical treatment of, 517
 'Horse-tails,' 680. See *Equisetacea*
 Hosts of parasitic plants, 532
 House-fly. See *Musca*

HYP

- Hudson, on the functions of contractile vesicle of rotifers, 789 *note*
 Hudson and Gosse, on classification of rotifers, 790
 Human blood-corpuscles, 1034
 — hair, 1031
 Husk of corn-grains, 725
 Huxley, on the ectosarc of *Amœba*, 743 *note*; on coccoliths, 747; on *Bathybius*, 747; on *Collozoa*, 853 *note*; on structure of molluscan shells, 922; on pulvillus of cockroach, 1000 *note*; on agamic reproduction of *Aphis*, 1006
 Huxley's simple dissecting microscope, 251, 252
 Huyghenian eye-piece and spherical aberration, 42
 Hyacinth, raphides of, 696; cells of pollen-chambers, 720; pollen-grains of, 722
 Hyaline shells of *Foraminifera*, 799
Hyalinia cellaria, palate of, 931
Hyalodiscus subtilis, 608
 Hyaloplasm, 537
Hydra, collecting, 527; intracellular digestion in, 863; thread-cells of, 864; structure of, 864; reproduction of, 866; gemmation of, 866
 — *fusca*, 863, 865
 — *viridis*, 863, 867
 — *vulgaris*, 863
 'Hydra tuba' of *Chrysaora*, 874, 876
Hydrachnida, 1008; mandible of, 1009; eyes of, 1011; reproductive organs of, 1012; characters of, 1013
Hydrangea, number of stomates in, 716; seeds of, 724
Hydrodictyon, 557, 566
 — *reticulatum*, 565
Hydroidea, classification of, 868
 Hydroids, compound, 867; structure of, 867 *et seq.*; *Medusæ* of, 868; planule of, 868, 871; habitats of, 871; examination of, 871; mounting, 871; polariscope with, 872; preservation of, 872
Hydrophilus, antennæ of, 987, 988
Hydrozoa, 863-877
Hydrozoa and marine mites, 1013
Hyla, nerves of, 1054
Hymenium of *Ascomycetes*, 642; of *Basidiomycetes*, 647; of *Hymenomycetes*, 648
Hymenomycetes, 647; pileus of, 648; stipe of, 648
Hymenoptera, 973; eyes of, 987; mouth-parts of, 990; wings of, 998; sting of, 1002, 1003; ovipositor of, 1002, 1003
Hyoscyamus, spiral cells of pollen-chambers of, 720; seeds of, 724
Hypericum, seeds of, 724
 Hyphæ of fungi, 633
 Hypnosporæ of *Hydrodictyon*, 565
 Hypnosporæ, meaning of, 541 *note*
 Hypoblast, 726 *note*
 Hypopial stage of *Tyroglyphida*, 1013
Hypopus, 1013

ICE

I

- 'Ice-plant,' epiderm of, 714
Ichneumonidae, ovipositor of, 1003
 Illuminating power, 425
 — power of objectives, 54; compared with penetrating power, 393
 Illumination for dissection, 401
 — for opaque objects, 149
 — oblique, 190, 191, 388
 — of objects, Ross on, 300; monochromatic, 321-323; Gifford's screen for, 321; Meithe's filter for, 322; Nelson's apparatus for, 323; by reflection, 329-338; opaque, 329; from the open sky, 412; by diffused daylight, 412; for dark ground, 413; experiments in, 414; monochromatic, means of obtaining, 417, 418; annular, 419; colour, 423; double, objects for study with, 423; with small cones, as cause of errors in interpretation, 427
 Illuminator, oblique, 190; white cloud, 194; parabolic, 316-317; Swift's sub-stage, 319; Smith's vertical, 336; Powell and Lealand's, 337; Beck's, 337; for examination of metals, 337
 Image, real, 14 *note*; virtual, 14 *note*, 376; conjugate, 24; inverted conjugate, 24; absorption or dioptrical, 64; diffraction, 64; negative, 64; positive, 64; solid, 95; real object, 375; definition of, 382; formed by compound eye, 984, 985
 Images, by diffraction, dioptric and interference, 72
 Imaginal discs in larva of blowfly, 1007
 Imbedding processes, 495-506; paper trays for, 497; in paraffin, metal case for, 498; orienting bottle for, 499
 — — paraffin method, 499-503; in gum, 475, 505, 506; celloidin method, 503-505
 — by coagulation or freezing, 505, 506
 Immersion lenses and vertical illuminators, 337, 338
 — homogeneous, outcome of Abbe's theory of diffraction, 364
 — — water, Zeiss's, 370
 — — — Amici's, 362; Powell and Lealand's, 362, 364; Prazmowski and Hartnack's, 362; Tolles', 362
 — objectives, 28; examination of, 387
 — system, 27-29; invented by Amici, 27
 Imperfect achromatism, cause of yellowness, 417
 'Impressible organs' in *Ciliata*, 775
 Incidence, angle of, 3
 Incident ray, 2
 Incus of *Potifera*, 788
 Index eye-piece, 381
 — of visibility, 521
 Indian corn, epiderm of, 712; stomates of, 715
 Indirect division of nucleus, 538
 Indusium in ferns, 675

IRI

- Inflection of diverging rays, 62
Infusoria, 754-785; as food of *Actinophrys*, 739; Ehrenberg's work on, 753; ciliate, 754, 772; unicellular nature of, 755 *note*; character of, 772
 Infusorial earth, 607, 608, 611, 613, 617, 620-622; from Barbadoes, 846, 849
 Injected preparations, 1061
Inoceramus, portions of shell of, in chalk, 1087
 INSECTS, 972-1007
 — mounting media for, 973; integument of, 974; tegumentary appendages of, 974; scales of, 975-980; hairs of, 980; parts of head, 982; eyes, 982-987; antennae of, 987; mouth-parts of, 989; circulation of blood, 993; alimentary canal, 993; wings of, 994, 998-1000; tracheae of, 994; stigmata of, 995; sound-producing apparatus, 999; organ of smell, 1000; organ of taste, 1000; feet of, 1000-1002; stings of, 1002, 1003; ovipositors of, 1002, 1003; eggs of, 1004; agamic reproduction of, 1006; embryonic development of, 1007; 'liver' of, 1047
 — parasitic fungi in, 642, 645
 — parts of, wooden slides for mounting, 450
 Insect work, dark-ground illumination for, 423; polarised light for, 423
 Integument of insects, 974; of *Acarina*, 1010
 Integuments of ovule, 685
 Intensity of light, necessities for, 417
 Intercellular substance, 1019; in cartilage, 1046
 Intercostal points, Stephenson on, 73; not revelation of real structure, 73
 Interference, 62
 — image, 72
 Intermediate skeleton in *Fovaminifera*, 801; of *Globigerinida*, 820; of *Calcarina*, 825; of *Rotalia*, 825; of *Nannulites*, 826; of *Eozoön*, 839
 Internal casts of *Textularia*, 823; of *Rotalia*, 824; of *Eozoön*, 840; of wood, 1083; of shells in greensand, 1090
 Interpretation, errors of, 427
 'Interseptal canals' of *Calcarina*, 830
 Intestine, cells of villi in, 1044
 Intine of pollen-grains, 720
 Intracellular digestion in zoöphytes, 863
 Intussusception, 533
 — mode of growth of starch, 694
 Invagination, 726
 Invertebrata, blood corpuscles of, 1038
 Inverted conjugate image, 24
 Iodine, as a test for starch, &c., 516
Ipomœa purpurea, pollen-grains of, 721
 Iridescent scales of insects, 975
Iris, epiderm of, 712; leaves of, 717; cells of pollen-chambers, 720
 Iris-diaphragm, 297, 313; fitted to Abbe's condenser, 312
Iris germanica, epiderm and stomates of, 715, 716

IRR

- Irrationality of spectrum, 19, 365
 Isochelæ of sponges, 860
Isoetæ, 682
 Isotropism, 1079
Isthmia, chains and frustules of, 588, 612; structure of frustules, 590 *note*; division of, 596
 — *nervosa*, 613
 — areolations in, 592
 Italian reed, stem of, 699
 'Itch-mites,' 1013
 Ivory, 1024
Ixodes, heart of, 1011
Ixodula, 1008; integument of, 1010; auditory organ, 1011; tracheæ of, 1011; characters of, 1012

J

- Jackson's modification of Ross model, 199; his eye-piece micrometer, 276
 Janssen (H. and J.), inventors of first microscope, 120; their compound microscope, 120
 Jars, capped, for Canada balsam, 477
 Jelly-fish. See *Acalephæ* and *Medusa*
 Jones's compound microscope, 144, 145
Jungermannia, 668
 Jung's (Thoma's) microtome, 461-469

K

- Kaolin, 1076
 Karop, his fine adjustment to sub-stage, 187
 Karop and Nelson on fine structure of diatoms, 591 *note*
Karyokinæsis in monads, 763
 Kellner's eye-piece, 42, 376; as a condenser, 196
 Kent (Saville), on contractile vacuoles of *Volvox*, 552 *note*; on *Flagellata*, 764
 Keplerian telescope, Drebbel's modification as a microscope, 121
Keramosphæra Marrayi, 810 *note*
 Keratose network of sponges, 855; preparation of, 857
 Kidneys of *Vertebrata*, 1047
 King-crab, 957
 Kirchner, on the oöspores of *Volvox*, 556
 Klebahn, on formation of auxospores of diatoms, 601
 Klebs, on mucilaginous sheath of desmids, 580; on movement of desmids, 580
 — and Bütschli, on the 'cilia' of *Dinoflagellata*, 770
 Klein, on *Volvox*, 556 *note*
 Knife, special, for microtome, 462
 Koch's method of sectionising corals, 878
 Kowalevsky, on development of ascidians, 917 *note*
 Krukenberg, on digestion in sea-anemones, 863

LEG

- Kützing, on *Palmodictyon*, 559; on structure of frustules of diatoms, 590; his classification of diatoms, 603

L

- Labarraque's fluid for bleaching vegetable substance, 514
 Labels, permanent, 523
 Labyrinthic structure of *Cyclamina*, 816; of *Parkeria*, 818
Labyrinthodon, tooth of, 1091
 Lacunæ and canaliculi of bone, misinterpretation of, 428
 — of bone, 1019-1022; dimensions of, in various animals, 1022
 — relation of size to that of blood corpuscle, 1022
Lagenæ, 796, 819
Lagenida, 819
Laguncula, 906, 908, 950
 — stolon of, 904; polypides of, compared with *Clavellinida*, 914
 — *repens*, anatomy of, 904, 905
 'Lamellæ' of corals, 878
 — of *Hymenocystes*, 648
Lamellibranchiata, shell of, 919
Lamellicornia, antennæ of, 988
Laminaria, 626, 627
Laminariaceæ, 627
Lamna, tooth of, 1024
 Lamp, Nelson's, 404; Beck's 406; Baker's, 407
Lampyrus, antennæ of, 988
 — *splendidula*, photograph through eye of, 984
 Land-crab, young of, 969
 Lankester (E. Ray), on *Bacteria*, 652; on movement of gregarines, 750; on *Hæmaphysida*, 752 *note*; on intracellular digestion in *Limnocolidium*, 863
 Lantern-flies, wings of, 999
 Lapis lazuli, 1095
 Larva of *Echinodermata*, 896; of *Asteroidea*, 898; of *Echinoidea*, 898; of *Ophiuroidea*, 898; of *Crinoidea*, 900; of ascidians, 916; of fly, 1007; of *Acarina*, 1009
 Latex of Phanerogams, 695
Lathræa squamaria, embryo of, 723
 Laticiferous tubes, free-cell formation in, 534
 — tissue of Phanerogams, 695
 Laurentian rocks, 837, 842
 'Laver,' or green seaweed, 559
 Lawrence's glycerin jelly, 519
 Leaves, epiderm of, 712; internal structure of, 716; mode of preparation for examination of, 718
 Leech, 956
 Leeuwenhoek's simple microscope, 132
 Legg's method of selecting *Foraminifera*, 814
 Legs of insects, 1000, 1002; of *Acarina*, 1008, 1010

LEG

- Leguminosae*, seeds of, 685
Leiosoma palmacinctum, 1008; hairs of, 1010
 Leitz's microscopes, 206, 227
 — bull's eye, 330
 — objectives, 374
 Lens, spherical, 12; biconvex, 12, 13; plano-concave, 13; diverging meniscus, 13; plano-convex, 13, 15, 22, 37; converging meniscus, 13; biconcave, 13; plano-convex, focal length of, 15; crossed biconcave, 16; crossed biconvex, 16; equiconvex, 16, 22; Stanhope, 37; Coddington, 37; Brücke, 38
 — from Sargon's palace, 119
 — invention of, 119, 120
 — achromatic, Charles's, 148; Barlow's, 149
 Lenses, refraction by, 10, 25
 — homogeneous immersion, of Powell and Lealand, 30; of Zeiss, 29
 — fluorite; for apochromatic objectives, 35
 — combination of, 37
 — resolving power of, 64, 382; amplifying power of, 25, 26
 — testing by *Diatoms*, 389
Lepaulidae, 967
Lepidium, seeds of, 724
Lepidocyrtus curvicolis, scales of, 979
Lepidodendra, 682, 1084
Lepidoptera, scales of, 975, 976; wings of, 981, 999; scales of, mounting, 981, 982; eyes of, 987; antennae of, 988; mouth-parts, 992; eggs of, 1005
Lepidosteus, bony scale of, 1022, 1028
Lepidostrobi, 682
Lepisma saccharina, scales of, 976, 977
Lepismidae, 979
Lepuruli, 909; mode of growth in, 904; extension of perivisceral cavity of, 927
Leptodiscus (ally of *Nortiluca*), 769 *note*
Leptogonium scotinum, 649
Leptothrix, form of, 653
Leptus autumnalis, 1013
Lernæa, 965 *note*, 966
Lessonia, 627
 Lettuce, laticiferous tissue, 695
 Leucite, mineral inclusions in, 1075; anomalies in, 1078
 Lever of contact, Ross's, for testing covers, 440
Libellula, eye of, 983, 987; respiratory apparatus of larva, 997; wings of, 998
 Liber, or inner bark, 708
 LICHENS, 648-651; fungus-constituents of, 651
Licmophora, stipe of, 588, 604; flabella of, 605
 — *flabellata*, 588, 604
Licmophoræ, 616
 — characters of, 604; vittæ of, 604
Lieberkuehnia, movement of, 732
 — *paludosa*, 733
 — *Wagneri*, 731

LOM

- Lieberkühn's microscope, 139; his spectrum, 334-336
 'Ligamentum nuchæ,' structure of, 1040
 Light; refraction of, 2; recomposition of, by prisms, 18; convergence of, 18; path of, through compound microscope, 40; quantity of, 50, 51, 54; emission of, 51, 54; quantity of, and aperture, 54 *note*; cone of, 190; monochromatic, 321, 417, 418; intensity of, necessities for, 416
 — convergent, in petrology, 1070, 1078
 Lignified tissue, test for, 517
 Lignites, 1083
Lignum vite, wood of, 704
Lilac, pith of, 687
Lilium, experiments with pollen-grains of, 721
 'Lily-stars,' 900. See *Crinoidea*
Limax maximus, palate of, 930
 — shell of, imitated, 1102
 — *rufus*, shell structure of, 928
 Lime, raphides of, 696
 — secreting Algae, 1084
 Limestone, metamorphism of, 1077
 — rocks, 1084, 1085
Limnæus stagnalis, nidamentum of, 934; velum of, 936
Limnocaridae, characters of, 1013
Limnocharis, seeds of, 724
Limnocodium, intracellular digestion in, 863
 Limpet. See *Patella*
Limulus, 957
Linaria, seeds of, 724
 Lister's struts for support of body, 149; his influence on improvement of English achromatic object-glasses, 150; his zoophyte trough, 348; his discovery of two aplanatic foci, 355; his note on Chevalier's objectives, 355; his influence on microscopical optics, 356; his triple-front combination, 360
Listrophorus, 1008
Lithasteriscus radiatus, 620
 Lithistid sponges, spicules of, 859
Lithocyclus ocellus, 847
Lithothamnion, 1084
Lituola, 814
Lituolæ, large fossil forms of, 816
Lituolida, 814
 Live-box, 346
 Liver, 1047
 Liver-cells, 1048
 'Liverworts,' 665. See *Hepaticæ*
Lobosa, characters of, 734; examples of, 742-747
 Lobster, 957; metamorphosis of, 969
 'Lob-worm,' 948
 Loculi, of anthers, 720
 Locust, gizzard of, 993; ovipositors of, 1004
Locusta, eye of, 987
Loftusia, 818
Loligo, pigment-cells of, 942
 Lomas (J.), on calcareous spicules in *Aleyonidium*, 908 *note*

LON

- 'London Pride,' parenchyme of, 688
Longicornia, antennæ of, 988
 Longulites, 1096
 Lophophore of *Polyzoa*, 905, 950; of fresh-water *Polyzoa*, 909
Lophopus, collecting, 528
Lophospermum erubescens, winged seed of, 724
Lophypoda, 959
 Lorica of *Ciliata*, 773; of *Acineta*, 783; of *Rotifera*, 787
 Loup-holders, 248
 — for tank work, Steinheil's, 268
 Loups, Reichert's, 38; Steinheil's, 38, 378; Steinheil's aplanatic, 248; Zeiss's, 268
 Louse, mounting media for, 973
 Lovén, on classificatory value of palates in *Gastropoda*, 932
Loxosoma, lophophore of, 909
 Lubbock, on *Thysanura*, 977; on *Podura* scale, 979
Lucanus, eye of, 987; antennæ of, 988
 Luminosity of *Noctiluca*, 765; of *Ctenophora*, 883; of annelids, 955
 Lungs, circulation in, 1056, 1062-1065
Lychnis, seeds of, 724
Lychnocanium faleiferum, 847
 — *lucerna*, 847
Lycoperdon, 647; hymenium of, 647
Lycopodiaceæ, 681; in coal, 1084
Lycopodiææ, 681
Lymnæus, collecting, 527
 Lymph, corpuscles, 1037
 Lysigenous spores in Phanerogams, 688

M

- Maceration of vegetable tissues, 700; Schultz's method, 700
Machilis polypoda, scale of, 978
 Machines for cutting hard sections, 511, 512
Macrocystis, 627
 Macrospores of *Polytoma*, 760; of sponges, 857
 Macrurous *Decapoda*, young of, 969, 970
 Madder, cells of pollen-chambers, 720
 'Madre,' *Acanthometra*, occurring in, 852
 Madreporcs, 878
 Magma, 1073
 Magnetite, 1072
 Magnification, range of, of Selligüe's microscope, 149
 Magnifying power, testing of objectives, 425; determination of, 288
 Mahogany, size of ducts of, 699; stem of, 706
Malacostraca, 968
 'Male' plants of *Polytrichum*, 671
 Mallei of *Rotifera*, 788
 Mallow, pollen-grains of, 721, 722
 Malpighian vessel of *Gamasida*, 1011
 — layer of skin in mammals, 1042
 — bodies in vertebrate kidney, 1047
 Maltwood's finder, 296
Malva sylvestris, pollen-grains of, 721

MEC

- Malvaceæ*, pollen-grains of, 721
 MAMMALIA: lacunæ in bones of, 1022; plates in skin of, 1026; epidermic appendages of, 1029; red blood-corpuscles of, 1034, 1035; epidermis of, 1042; muscle fibre of, 1049; lungs of, 1065
 Mammary glands, 1047
 Man, arrangement of enamel in teeth of, 1025; cement in teeth of, 1026; hair of, 1031; muscle fibre of, 1049; lung of, 1065
 Mandibulate mouth, 989
 Manganese concretions, 1090
 'Mantle' and growth of shell in *Mollusca*, 925
Marchantia, 665-668; archegones of, 665, 668; stomates of, 666; elaters of, 668
 — *androgyne*, 665 note
 — *polymorpha*, 665-668
Margaritaceæ, 919; nacreous layer of, 922; prismatic layer of, 923
 Margarites, 1096
 'Marginal cord' of *Operculina*, 830
 — of *Nummulites*, 834
 Marine forms, collecting, 528
 — glue for forming 'cells,' 445
 — mites, 1013
 — work, tow-net for, 528; dredge for, 528; stick-net for, 529
 Marshall's compound microscope, 135, 136, 138, 139
Marsipella elongata, 813
 Martin's 'pocket' reflecting microscope, 140; his large microscope, 140; his improvements in optical and mechanical arrangements, 142; his achromatic microscope, 147; his reflecting microscope, 147; his achromatic objective, 147
 Marzoli's achromatic lenses, 353
Masonella, 811
 Mastax of *Rotifera*, 787
Mastigophora Hydnammii, 906
Mastogloia, stipe of, 588, 619; gelatinous sheath of, 588, 619; development of, 597; range of variation in, 618
 — *lancoolata*, 619
 — *Smithii*, 619
 Matthews's method of sectionising hard substances, 507
 Mayall, on history of microscope, 117; on Divini's microscope, 130
 Mayall's removable mechanical stage, 183
 Mayer's heating bath, 453
 'Meadow-brown,' eggs of, 1005
 'Measly pork,' due to *Cysticercus*, 944
 'Mechanical finger' for selecting diatoms, 625
 — movements of the stage in Lister's (Tully's) microscope, 149
 — stage, 175
 — — Turrell's, 176; Watson's, 177; Nelson's, 179, 181; Zeiss's, 179, 183; Swift's, 180; Allen's, 180; Mayall's removable, 183; Reichert's, 183; Bausch and Lomb's, 183, 184; Beck's, 184
 — — Continental, 179
 — tube-length of microscope, 158

MED

- Medullary rays, 705
 — in dicotyledons, 702
 'Medullary sheath' of Exogens, 698; of dicotyledons, 703
 Medusa of fresh-water, 863
Medusa, mounting, 448; of Hydroids, 868; naked-eyed, 868; development of, 874; alternation of generations in, 877; nerves of, 1052
 Medusoids, collecting, 529
Megalopa, 970
 Megalosccleres, 859
 Megasphere of certain *Foraminifera*, 802
 Megaspores of *Rhizocarpeæ*, 681; of carboniferous trees, 682; of *Isoeteæ*, 682; of *Selaginellæ*, 682
Megatherium, teeth of, 1026
Megatricha of Ehrenberg, a phase in development of *Suctorina*, 785; Badocock on, 785
 Megazoöspores of *Ulothrix*, 557; of *Ulva*, 561; of *Scenedesmus*, 566
Megerlia lina, shell of, 927
Melanosporæ, 625
Meleagrina, 919, 922
 — *margaritifera*, 923
Melicerta, collecting, 527; in confinement, 528
Melicertida, 791
Melolontha, eye of, 987; antennæ of, 988; spiracle of larva, 996
 — *vulgaris*, eye of, 983
Melosira, frustules of, 588, 594; auxospores of, 595, 600; sporules of, 597; zygospore of, 600
 — *ochracea*, 608
 — *subflexilis*, 594, 595
 — *varians*, 594, 595; endochrome of, 598
Melosirææ, characters of, 608; resemblance to *Confervaceæ*, 608
 Membrana putaminis, 1032
Membranipora, 908, 909
Membraniporidae, 908
 Mercury nitrate as a test for albuminous substances, 517
Meridica, 604, 616
 — characters of, 604
Meridion circulare, 588, 604
Merismopodia, 547
 'Mermoid's fingers,' 879. See *Alcyonium*
Mesembryanthemum, seeds of, 724
 — *crystallinum*, epiderm of, 714
Mesocarpus, conjugation of, 549; zygospore of, 550
 Mesogloea of *Hydra*, &c., 864 *note*
 Mesophleum, 708
 Metal case for imbedding, 498
 Metamorphism, dynamic, 1077
 Metamorphism of rock-masses, 1076, 1077; of limestones, 1090
 Metamorphosis of *Lernæa*, 966; of *Cirripedia*, 967; of *Malacostraca*, 969
 Metazoa, 727, 855

MIC

- Meteorites in oceanic sediments, 1093
 Metschnikoff, on acinetan character of *Erythrospis*, 775; on intracellular digestion, 863; on phagocytes, 1037 *note*
 Mica, 1077
 Michael's (A.) opalescent mirror, 194
Micrasterius denticulata, binary division of, 583; form of cell of, 585
 Micro-chemical analysis, 1102
 — method of, 1102
 Micro-chemistry in petrology, 1082, 1083; of poisons, 1103
Micrococci, form of, 653
 Microcysts of *Myxomycetes*, 636
Microgromia socialis, 735
 Microlites, 1072; in glass-cavities, 1074
 Micrometer, Cuff's, 142
 — use of, 274
 — eye-piece, 271
 — Nelson's new, 271, 272, 273; Zeiss's, 272; Jackson's, 276
 Micrometers, 270-277
 Micrometry by photo-micrography, 277
 Micon, a, 82 *note*, 460
 Micro-petrology, 1066
 'Microplasts' of *Bacterium rubescens*, 660 *note*
 Micropyle in ovule, 685; of *Euphrasia*, 723; in orchids, &c., 723
 Microsccleres, 859, 860
 Microscope, Mayall on the, 117; history and evolution of the, 117-269; invention of, 120; inventor of the name, 124; essentials in, 157-194; adjustments in, 159-175; stage of, 175-184; sub-stage of, 184-191; mirror of, 191-194; desiderata in, 261-263; preservation of, 436
 — Galileo's, 127; Campani's, 128; Pritchard's, with Continental fine adjustment, 153; Ross's 'Lister' model, 153; Powell's (H.), 155; James Smith's, 155
 — achromatic, Euler on, 147; Martin's, 147; Chevalier's, 148, 150; Selligüe's, 148; Sorby's, 149; Ross's early form of, 152
 — aquarium, 266-269
 — binocular, Riddell's, 97; Nachet's, 98; Wenham's stereoscopic, 98; Stephenson's, 100, 248, 455; Greenough's, 102, 250; Powell and Lealand's, 105; Chérubin d'Orléans', 130; Ross's, 196; Ross-Zentmayer's, 199; Rousselet's, 245; Sorby's spectrum, 327
 — chemical, Bausch and Lomb's, 263, 264
 — compound, 36, 39-42, 120, 125; construction of, 39; path of light through, 40; Rezzi on invention of, 125; Jansen's, 120; Hooke's, 128; de Moncony's, 128; Divini's, 129; Marshall's, 135; Hertel's, 139; Joblot's, 139; Culpeper and Scarlet's, 140; Martin's, 140; Adams's variable, 142, 148; Jones's, 144, 148
 — comparison of English and Continental models, 254-261

MIC

- Microscope, concentric, 191, 199
 — dissecting, Greenough's, 102, 250; Stephenson's binocular, 248; Baker's (Huxley's), 251; Bausch and Lomb's (Barnes), 252; Zeiss's, 253
 — horizontal, Bonamus's, 134; Amici's, 148
 — petrological, 1068
 — photographic, 257, 258
 — radial, 191, 199; Ross-Wenham's, 199
 — reflecting, Newton's, 132; Martin's, 140, 147; Smith's, 145
 — simple, 36, 126, 248; path of light through, 25; inventor of, 126; Bacon's, 126; Descartes', 126; Bonamus's, 132; Muschenbroek's, 132; Leeuwenhoek's, 132; Hartsoeker's, 134; Wilson's, 140
 — spectrum binocular, 327
 — three great types of, 174, 199
 Microscopes, for chemical purposes, 263, 264
 — for examination of metals, 264-266
 — modern, 194-269; Powell and Lealand's, 194, 218, 237; Ross's, 196, 230; Watson's, 199, 218, 224, 234, 237; Baker's, 202, 218, 230; Swift's, 203, 224, 228, 233, 1068; Leitz's, 206, 237; Reichert's, 206, 224, 241, 242, 264; Zeiss's, 206, 237, 250; Bausch and Lomb's, 212, 222, 239, 252, 263; Spencer Lens Company's, 214; Beck's, 228, 233
 — portable, 245-247; Powell and Lealand's, 245; Swift's, 245; Rousset's, 245; Baker's, 246; Bausch and Lomb's, 247
 Microscopic and macroscopic vision, 62
 — determination of geological formations, 1090
 — dissection, single lenses for, 38
 — investigation of rocks, &c., 1066
 — vision, principles of, 43
 Microscopical optics, principles of, 1
 Microscopist's work-table, 398-403
 Microscopy, definition of, 397
 Microsomes, 531, 537
 Micro-spectroscope, Sorby-Browning, 323-327; Swift's, 325 *note*; Hilger's, 325 *note*
 — method of using, 328; in petrology, 1083
 Microsphere of certain *Foraminifera*, 802
 Microspores of *Sphagnum*, 674; of *Rhizocarpea*, 681; in carboniferous trees, 682; of *Isoetes*, 682; of *Selaginella*, 682; of *Polytoma*, 760; of sponges, 857
 Microtome, 458-475; Ryder's, 401; simple, 458-460; Thoma's (Jung's), 461-469; freezing apparatus for, 467; Minot's, 472; Strasser's, 472; Gudden's, 472
 — Cambridge rocking, 469-472; advantages of, 472
 — freezing, Hayes's, 472; minimum thickness of sections with, 473; Cathcart's, 471

MON

- Microzoöspores of *Ulothrix*, 557; of *Ulva*, 561; of *Hydrodictyon*, 565
 'Mildew,' 637. See *Uredinea*
Miliola, shell of, 799; encrusted with sand, 810
Miliola, 802
Miliolida, 801; in limestone, 1090
Miliolina, 802
 Milioline *Foraminifera*, fossils of, 801
 Miliolite limestone, 1090
 Millepore, resemblance of *Polytoma* to, 824
 Millon's test for albuminous substances, 517
 Mineral nature of *Eozoön*, 843
 — sections, where to get made, 1067
 Minerals and rocks, bibliography of, 1071 *note*
 — optic axes of, 1079
 — refractive index of, 1080
 — chemical, spectroscopic and microscopic testing of, 1078-1083
 Mimow, circulation in tail of, 1057
 Mirror, 191-194
 — opalescent, as a substitute for polarising prism, 194
 — replaced by rectangular prism, 192
 Mites, 1008. See *Acarina*
 Möbius, on mineral nature of *Eozoön*, 843
 Mohl (Von), on protoplasm, 530 *note*
 Moist-stage, Dallinger and Drysdale's, 341-344
 Molecular coalescence, 1099-1102
Molgula, development of, 917
 MOLLUSCA, larvæ of, collecting, 529
 — shells of, 919; shell-structure of, 919-925; colour of shell, 921; mantle and shell-growth, 925; palate of, 930; development of, 933; ciliation of gills, 940; organs of sense in, 940; bibliography, 942; resemblance of barnacles to, 967; 'liver' of, 1047; muscle fibre of, 1050; internal casts of, 1090; concretionary spheroids in shells of, 1100
 Molluscan shells in mud of Levant, 1085
 Monad-form of *Microgromia*, 737
Monadina, life-histories of, 755-763; saprophytic, affinities of, 756; effect of temperature on, 761; nucleus in, 762
 Monads, 755. See *Monadina*
Monas, 575
 — *Dallingeri*, life-history of, 756
 — *lens*, 755
Monaxonida, spicules of, 859
 Monazite, 1081
 Monconys (De) devises microscope with field-lens, 128
Monerozoa, 727-733
Monocaulus, 871
 Monochromatic light, 321, 417, 431
 — illumination, means of obtaining, 417, 418
 MONOCOTYLEDONS, 700; stem of, 700; nodes of, 701; epiderm of, 712
 Monocotyledonous stem, fossilised, 1083
 Monocular, Powell and Lealand's, 194, 195

MON

- Monocystis agilis*, cyst of, 750
Monophyes, digestion in, 863 *note*
Monosiga, fission of, 764
 Monothalamous *Foraminifera*, 796
Monotropa, seeds of, 724
Moraceæ, laticiferous tissue of, 695
Mordella beetle, eye of, facets in, 983
Mormo, scales of, 980
Morpho Menelaus, scales of, 976
 Morula of higher animals compared with 'multicellular' *Protozoa*, 726
 Morula of *Gastropoda*, 935
 Moseley (H. N.), on skeleton of pharynx of holothurian, 895 *note*; on *Chiton's* eyes, 941
 Mosses, 669-674
 — capsules of, wooden slides for mounting, 450
 'Mother-of-pearl,' 922
 Moths. See *Lepidoptera*
 Motion, spiral, 433, 434
 Motor nerves, 1053
 Motorial end-plates, 1053
 'Moulds,' 640, 643
 Moults of *Entomostraca*, 964, 965
 'Mountain-flour,' 622
 Mounted objects, keeping, 523; labelling, 523; arrangement of, 524
 Mounting plate, 452
 — instrument, James Smith's, 454
 — thin sections, 477
 — in natural balsam, 480; in aqueous liquids, 481; in deep cells, 482
 — diatoms, 481, 624; *Ophiurida*, 481; *Polycystineæ*, 481; sponge-spicules, 481; chitinous substances, 481; palates of gastropods, 481; sections of horns, &c., 481; *Lepidoptera* scales, 982; hairs of insects, 982; eyes of insects, 986; blood, 1038
 — media, 517-522; camphor water, 518; salt solution, 519; white of egg, 519; syrup, 519; Ripart and Petit's fluid, 519; glucose media, 519; chloral hydrate, 519; gum and syrup, 519; glycerin jelly, 519; Farrant's medium, 520; glycerin and mixtures of, 520; Canada balsam, 521; Dammar, 521; Styraç, 521; monobromide of naphthalin, 521; phosphorus, 521
 Mouse, hair of, 1030-1031; cartilage in ear of, 1046
 Mouse's intestine, villi of, 1062
 Mouth, suctorial, of *Hemiptera*, 999
 — of *Acarina*, 1009
 Mouth-parts of insects, 989
 Movement, interpretation of, 431-434
 — of *Lieberkuehnia*, 732; of *Amaba*, 744; of *Dallingeria*, 758; of planarians, 946; of *Artemia*, 960; of *Branchipus*, 960; of fly on smooth surface, 1001; of white corpuscles, 1037; of connective tissue corpuscles, 1041; of *Oscillatoria*, 547; of desmids, 580; of diatoms, 601; of *Bacteria*, 652; of *Ciliata*, 774
 Mucilaginous sheath of desmids, 580

MYX

- Mucor*, fermentation by, 647
 — *mucedo*, 641
Mucorini, 640; spores of, 640; epispores of, 642
 Mucous membrane, 1041; capillaries in, 1062
 Mud of Levant, microscopic constituents of, 1085
 Mulberry, laticiferous tissue of, 695
 Mulberry-mass, 726
 Müller (J.), on the *Radiolaria*, 846; on larva of Nemerites, 951
 Müller's (Fr.) 'Common Nervous System' in *Polyzoa*, 907 and *note*
 Multicellular organisms, 726
 Multiplication of *Palmoglaea*, 541; of *Protooccus*, 543; of *Volvox*, 555; of *Palmella*, 558; of *Bacteria*, 652; of *Microgromia*, 736; of *Amaba*, 744; of *Dallingeria*, 758; of *Heteromita*, 760; of *Tetramitus*, 760; of *Noctiluca*, 769; of *Peridinium*, 770; of *Suctorina*, 784; of *Ciliata*, 777
 Multiplying power of eye-piece, 290
 Munier Chalmas and Schlumberger, on dimorphism of *Foraminifera*, 802
 Munier-Charles, on certain fossil *Foraminifera*, 564
Muricea elongata, spicules of, 880
Musca, eye of, 987; antennæ of, 988
 — *voncktoria*, eggs of, 1006
 'Muscardine,' 645
Musci, 670-674
Muscineæ, 673
 Muscle-cells, 1051
 Muscular fibre, 1048; structure of, 1049; capillary network in, 1062
 Muscular tissue, preparation of, 1050
 Mushroom, 647
 — spawn of, 647
 Musk-deer, hair of, 1030
 Musschenbroek's simple microscope, 132
 Mussels. See *Unionidae* and *Mytilacea*
Mya arenaria, hinge tooth of, 924
 Mycele of *Fungi*, 633; of *Ustilagineæ*, 636
Mycetozoa, 634
Myliobates, tooth of, 1025
Myobia, 1008; legs of, 1010; maxillæ of, 1010
Myobiidae, 1013
Myocoptes, legs of, 1010
 'Myophan-layer' of *Vorticella*, 773
 Myopy, 118
Myriophyllum a good weed to collect, 527
 MYRIOPODA, hairs of, 980
Myriothela, intracellular digestion in, 863
Mytilacea, sub-nacreous layer in, 924
Mytilus, for observation of ciliary motion, 940
Myxamabæ, 634
Myxogastres, 634
Myxomyces, 579 *note*, 634; development of, 634, 636; spores of, 634, 636; swarm-spores of, 634; affinity with *Monerozoa*, 727
Myxosporidia, 749, 752

NAC

N

- Nachet, on 'immersion system,' 27; his binocular, 97, 98, 99; his changing nose-piece, 293
- Nacreous layer in molluscan shells, 919, 922, 924
- Nægeli and Schwendener, on microscopical optics, 67
- Nägeli's theory of formation of starch, 695
- Nails, 1029, 1033
- Nais, 955
- Naphthalin, monobromide of, as a mounting medium, 521; refractive index of, 521
- Narcissus, spiral cells of pollen-chambers in, 720
- Nassula, mouth of, 774
- Nauplius, compared with *Pedalionida*, 792
- Nautiloid shell of *Foraminifera*, 797
- Nautilus*, 929
- Navicula*, 590, 597, 617; markings on, 593; cysts of, 597; zygospores of, 597; zoözygospores of, 597
- *bifrons*, presumed relation to *Suriella microcora*, 602 *note*
- in chalk, 1087
- *lyra*, as test for definition, 426
- *rhomboides*, markings on, 592; as test for definition, 426
- Naviculae*, frustule of, 589; ostioles in, 590
- characters of, 616
- Nebalia*, carapace of, 962
- Needles for dissection, their mode of use, 457
- Negative aberration, 27, 360 *note*
- crystals, 1074
- eye-pieces, 376, 377, 378
- Nelson, on the sub-stage condenser, 72 *note*; on ghostly diffraction images, 72 *note*; his model, with Swift's fine-adjustment screw, 172; his horse-shoe stage, 179, 228; his fine adjustment to the sub-stage, 185; his screw micrometer eye-piece, 271; his new micrometer eye-piece, 272; his 'black dot,' 277; his plan for estimating edges of minute objects, 277; his changing nose-piece, 294; his revolving nose-piece, 295; on rings and brushes, 319, 320; his means of obtaining monochromatic illumination, 323; his lamp, 404
- Nelson and Karop, on fine structure of diatoms, 591 *note*
- Nematium multigidum*, 631
- Nematodes, desiccation of, 945
- Nematoid worms, 944
- Nemertine larva, 951
- Nepa*, tracheal system, 995; wings of, 1000
- *ranatra*, eggs of, 1005
- Nepenthes*, spiral fibre-cells of, 698
- Nereida*, 948
- Nereocystis*, 627

NUC

- Nerve-cells, 1051
- Nerve-fibres, 1052
- Nerve-substance, 1051; mode of preparation, 1054
- Nerve-tubes, 1051
- Nervures of wing of *Agrion*, 994
- Nettle, hairs of, 714
- Neuroptera*, 973; eyes of, 987; circulation in wings of pupa, 994; wings of, 998
- Newt, red blood-corpuscles of, 1034; circulation in gills of larva, 1057
- Newton's reflecting microscope, 132
- suggestion of reflecting microscope, 145
- rings, 1097
- Nicol prisms, 318
- Nicol's analysing prism, 294; for resolving striae, 381
- Nicotiana*, seeds of, 724
- 'Nidamentum' of *Gastropoda*, 934
- Nitella*, 576
- Nitric acid as a test for albuminous substances, 517
- Nitrogenous substances, test for, 517
- Nitzschia*, 602
- *scalaris*, cyclois in, 587
- *sigmoidea*, 606
- Nitzschia*, 606
- Noctiluca*, collecting, 529; tentacle (flagellum) of, 766, 768; cilium of, 766 *note*; protoplasmic network of, 767; reproduction of, 769
- *miliaris*, 765-769
- Noctuid*, antennae of, 988
- Nodes of monocotyledons, 701
- Nodosaria*, 819
- Nodosarinae*, shell of, 797
- Nodosarine shell, sandy isomorphs of, 815
- Nonionina*, 829
- shell of, 797, 798
- Nonionine shell, sandy isomorph of, 814
- Non-stereoscopic binoculars, 105
- Non-striated muscle, 1048, 1050
- Nose-pieces, 291-295; centring, used as sub-stage, 228; Brooke's, 291; Beck's rotating, 291; Powell and Lealand's, 291; Watson's dustproof, 292; Zeiss's calotte, 292; centring, 293; Nachet's changing, 293; analysing, 294; Vogan's, 294; Nelson's revolving, 295
- Nosema bombycis*, cause of pebrine, 661
- Nostoc*, 548, 549; as gonid of lichen, 651; resemblance of *Ophrydium* to, 778
- Nostocacca*, 548; affinities with *Bacteria* and *Myxomycetes*, 652
- Notochord in *Tunicata*, 911; of *Appendicularia*, 918
- Notonecta*, 987; wings of, 1000
- Nucellus, 685
- Nuclear stains, 491-494
- spindle, 538; plate, 538
- Nuclein, 537
- Nucleoli, 534
- Nucleoplasm, 537

NUC

- Nucleus, 534
 — action of acetic acid on, 517; its importance to cell, 535; division of, 538; fragmentation of, 538; presumed absence of, in some forms, 727; initiative action in monads, 762
 — and cell division, 1019 *note*
 Nucule of *Chara*, 577, 579
 Nudibranchs, nidamentum of, 934; embryos of, 936
 Numerical aperture, 29, 53, 60, 390, 425; formula for, 390; problems on, 391
 — — of dry objective, 391; of water-immersion, 391; of oil-immersion, 391
 — — and resolving power of objective, 393
 — apertures, table of, 84-87
 Nummuline layer of *Eozoön*, 840
 — plan of growth, Parker and Rupert Jones on, 827 *note*
 Nummulinidæ, 826
 Nummulites, 826, 827, 831
 — *distans*, 832
 — *garvensis*, 832
 — *lævigata*, 832
 — *striata*, internal cast of, 834
 — tubuli in shell of, 800
 Nummulitic limestone, 831, 835, 1085, 1090
Nuphar lutea, parenchyme, 687; stellate cells of, 687
 Nymph of *Acarina*, 1009; of *Oribatida*, 1009

O

- Oak, size of ducts in, 699
 — galls, 1003
 Oberhäuser's spiral fine adjustment, 153
 Object-glass of compound microscope, 36, 39; of long focus, 40; of short focus, 40; capacity of, 382
 Object-glasses, power of, 44
 — — testing, 381; Abbe's method of testing, 384-387; diaphragms for use in testing, 385; Fripp's method of testing, 386
 Object-holder for Thoma's (Jung's) microtome, 464, 465, 466
 — — changer, Zeiss's, 293
 Objectives, achromatic, 19, 32; aplanatic, 19; apochromatic, 19, 30, 34, 80; corrected, 20, 21; immersion, 28, 34, 58; aperture of, 43, 65, 390; maximum aperture of, 44; comparison of, 46; illuminating power of, 54 *note*; immersion *v. dry*, 54, 79; dry, with balsam mounted objects, 55; dry, 58; dry, for study of life-histories, 81; penetrating power of, 83, 393; sliding plate with, 290; rotating disc with, 290; of wide aperture, 369; of small aperture, examination of, 388; tests for, 388, 394; resolving power of, and numerical aperture, 393
 Objectives, triple-back, 361; Wenham's single front, 361; duplex front, 362; Leitz's, 374; Reichert's, 374; adjusting, 357, 360
 — achromatic, Martin's, 147; Marzoli's, 353; Tully's, 354; Selligme's, 354; Amici's, 355; Ross's, 356, 360; Powell's, 356, 361; Smith's, 356, 360; Wenham's, 361; covers for use with, 439
 — apochromatic, 366, 370, 371-375
 — homogeneous immersion, introduction of, 364
 — 'semi-apochromatic,' 35, 374, 375
 — oil-immersion, Powell and Lealand's, 30; Amici's, 364; Tolles', 364; Zeiss's, 370; Leitz's, 374; Reichert's, 374; Swift's, 375; Beck's, 375; Bausch and Lomb's, 375; Watson's, 375
 — water-immersion, Powell and Lealand's, 362, 365; Prazmowski and Hartnack's, 362; Zeiss's, 370
 Oblique illumination, 190, 191, 387
 — illuminator, 190
 Obliteration of structure by diaphragms, 68
 Occhiale, Galileo's, 122, 123
 Occhialino, Galileo's, 121, 124
 Oceanic sediments, microscopic examination of, 1092
 Ocelli of planarians, 947; of insects, 982, 986
 Ocellites of compound eye, 982
 Ocular, 40, 375; spectral, 327
Edogoniaceæ, 572
Edogonium ciliatum, 573
Enothera, pollen-grain, 721; emission of pollen-tubes of, 722; embryo of, 723
 Oil for immersion lenses, suggested by Amici, 29
 — of cedar-wood, for immersion objectives, 29
 Oil-globules, 429-431
 Oil-immersion, 29
 — — objectives. See Objectives, oil-immersion
 Oils, solvents for, 517
 Okeden, on isolation of diatoms, 624 *note*
Oleander, epiderm of, 714; stomates of, 716
 Olivine, corroded crystals of, 1072
Onchidium, eyes of, 941
Oncidium, spiral cells of, 693
 Onion, raphides of, 696
 Oögones of *Vaucheria*, 563; of *Sphaeroplea*, 572; of *Edogonium*, 572; of *Chara*, 577; of *Fuaceæ*, 627, 628; of *Peromosporeæ*, 638
 Oölitic grains, 1084
 Oöphyte in ferns, 680
 Oösppheres, use of the term, 537 *note*; of *Volvox*, 556; of *Vaucheria*, 563; of *Sphaeroplea*, 570; of *Edogonium*, 572; of *Chara*, 577; of *Phaeosporeæ*, 627; of *Fuaceæ*, 628; of *Marchantia*, 668; of ferns, 679

OÖS

OÖS

- Oöspores, 540; of *Volvox*, 556; of *Vaucheria*, 563; of *Achlya*, 565; of *Sphaeroplea*, 572; of *Aedogonium*, 573; of *Chara*, 579; of *Fucaceae*, 628
- Ooze, *Globigerina*, organisms in, 811, 813, 820; compared with chalk, 1085
- Opalescent mirror as a substitute for polarising prism, 194
- Opalina*, 774
- Opaque illumination by side reflector, 333 — mounts, 336
- 'Open' bundles, 710
- Operculina*, 830; and *Nammulites* compared, 834
- Opercule of mosses, 671
- Ophiacantha vivipara*, development of, 900 *note*
- Ophioglossaceae*, development of prothallium of, 679
- Ophioglossum*, sporanges of, 676
- Ophiothrix pentaphyllum*, spines of, 891; teeth of, 892
- Ophiurida*, mounting, 481
- Ophiuroidea*, skeleton of, 891; spines of, 891; teeth of, 892; larva of, 898; direct development in, 900 *note*
- Ophrydia*, quantities of, 777
- Ophrydium*, cellulose in zoöcytium of, 778 — *versatile*, effect of light on, 775
- Ophryodendron*, 784
- Opium poppy, latex of, 695
- Optic axis of Powell and Lealand's No. 1, 194
- Optical anomalies in petrology, 1078 — centre, 24 — tube-length of microscope, 158, 159
- Orals of *Antedon*, 901
- Orbiculina*, 803, 804, 808 — compared with *Heterostegina*, 834
- Orbitoides*, 835 — and *Cycloclypeus* compared, 835 — *Fortisii*, 836
- Orbitolina*, 824
- Orbitolina*, occurring with flint instruments, 824
- Orbitolites*, 804-810 — shell of, 798; range of variation in, 810; structure of *Parkeria* resembling, 817; deposits of, 1085 — and *Cycloclypeus* compared, 801 — *complanata*, animal of, 807-809 — *italiana*, 806 *note*, 808 — *tennissima*, 808
- Orbulina*, 820
- Orbuline shell, sandy isomorph of, 815
- Orchidea*, pollinium of, 722
- Orchids, micropyle of, 723
- Orchis*, pollen-tubes of, 723; seeds of, 724
- Organised structure and living action, 530
- Organs, 533
- 'Organs of sense' in *Ciliata*, 775 *note*
- Oribatide*, nymph of, 1009; mouth-parts of, 1009; legs of, 1010; integument of, 1010; auditory organ, 1011; reproductive organs, 1011; supercoxal glands

PAL

- of, 1011; tracheae of, 1011; characters of, 1012
- Orienting small objects for sectioning, 499
- Origanum onites*, seeds of, 724
- Ornithorhynchus*, hair of, 1031
- Orobanche*, seeds of, 724
- Orthoptera*, eyes of, 987; antennae of, 988; wings of, 999; nymph of, 1009
- Orthoscopic effect, 95; with Ramsden's circles, 106 — eye-piece, 376
- Orthosira Dickiei*, sporangial frustule of, 595
- Oscillatoria*, movement of, 547
- Oscillatoriaceae*, 547 — movements of, 433
- of sponges, 856
- Osmic acid and fatty structures, 517
- Osmunda*, sporanges of, 676 — *regalis*, prothallium of, 679 *note*
- Ossem, of bone, 1023
- Ostiole of conceptacle of corallines, 632
- Ostioles of *Naviculaceae*, 590; of *Cymbellae*, 590
- Ostracoda*, 960
- Ostraceae*, shell of, 923
- Ostrich, egg-shell of, 1101
- Otoliths compared with artificial concretions, 1100 — of *Mollusca*, 941
- Ovary of *Polyzoa*, 907
- Over-amplification, 88
- Over-corrected objective, 20
- Over-correction, 358-360
- Overton, on *Volvox*, 556 *note*
- Ovipositor of *Oribatida*, 1012
- Ovipositors of insects, 1002-1004
- Ovule of *Phanerogams*, 684 — suspensor of, 534 — structure of, 684-685; development of, 722
- Ovum of *Hydra*, 866
- Oxytricha*, a phase in development of *Trichoda*, 780
- Oxyuris vermicularis*, 944
- Oysters, shell of, 923

P

- Pacinian corpuscles, 1053
- Palaentology, use of microscope in, 1083
- 'Palate' of *Gastropoda*, 919, 930; classificatory value of, 932; preparation of, 932; viewed with polariscope, 933; bibliography, 933
- Paleae of grasses, silex in, 715
- Palisade-parenchyma of leaves, 716
- Palm*, stem of, 701
- Palmella*, as gonid of lichen, 651 — *crucata*, 558
- Palmellaceae*, 557; frond of, 558
- Palmodyctyon*, 559; zoöspores of, 559
- Palmoglaia macrococca*, life-history of, 541, 542
- Palpicornia*, antennae of, 988

PAL

- Paludina*, infested by *Distoma*, 946
 Pancreas, 1047
Pandorina, 545
 — *morum*, generative process of, 557;
 swarm-spores of, 557
Papaveraceæ, laticiferous tissue of, 695
 Paper-cells, 446
 Parabolic illuminator, 316; speculum,
 333; reflector (Sorby's), 334
 Paraboloid illuminator, 316
 Paraffin, solvents for, 496
 — imbedding method, 496-503
 — for imbedding, melting point of, 500
 — mounting, sections, 501
 — cells, 446
Paramecium, Cohn's experiments on,
 743; contractile vesicles of, 776
 Paraphyses of *Puccinia*, 638; of lichens,
 650; of mosses, 671
 Parasites, nourishment of, 532
 Parasitic *Crustacea*, 965
 — *Fungi*, 633
 Parietal utricle, 533
 Parker (T. J.), on *Hydra*, 863
Parkeria, 817; a possible *Stromato-*
poroid, 817 note
Parnassia, seeds of, 724
 Parthenogenesis, 1007 note
 — in *Saprolegnia*, 640
Passiflora carulea, pollen-grains of, 721
Passifloræ, pollen-grains of, 721
 Paste-worm, 945
 Pasteur's solution for growing yeast, 646
 note; his experiments with *Bacteria*,
 660, 661
Patella, shell structure, 928; palate of,
 931
 Path of ray of light through a compound
 microscope, 40
 Pathogenic bacteria, 658
 Pavement epithelium, 1044
 Pear, constitution of fruit, 693
 'Pearl oyster.' See *Melcaagrina*
 Pearls, 923
 'Pébrine' in silkworms, 661
 Peccary, hair of, 1030
Peeten, prismatic layer in, 924; pallial
 eyes of, 940; fibres of adductor muscle,
 1050
Pectinibranchiata, 937
Pectinidæ, sub-nacreous layer in, 924
Pedalion, 792
Pedalionidæ, 792
Pedesis, 431; experiments in, 432
Pediastrea, 566; affinities of, 566
Pediastrum, zoöspores, 567; micro-
 zoöspores, 567
 — *Ehrenbergii*, 568
 — *granulatum*, 566-568
 — *pertusum*, 568
 — *tetras*, 568
 Pedicellariæ of echinids and asterids,
 889
Pedicellina, lophophore of, 909
Pedicularis palustris, 723
 — *sylvatica*, embryo of, 723
 Pedunculated cirripeds, 967

PHA

- Pelargonium*, petal of, 719; pollen-grain,
 721
Pelomyxa palustris, 744
Peneroplis, 801
 — variation in shape of shell in, 797;
 shell of, 799; varietal forms of, 803
 Penetrating power, 425
 — in objectives 83; of objective, com-
 pared with illuminating power, 393
 Penetration, 38, 82, 83
Penicillium, fermentation by, 647
 — *glaucum*, 643
Pentacrinus asterius, skeleton of, 892
Pentatoma, wings of, 1000
 Peony, starch in cells of, 694
 'Pepperworts,' 681
 Perception of depth, 94
 Perch, scales of, 1028
 Perforated shells of *Brachiopoda*, 926
 Perforation of shell in *Foraminifera*, 799,
 800
 Perianth, 718
Perichlamyidium praterxtum, 851
Peridinia, 770, 771
Peridinium uberrimum, 770
 Perigone of mosses, 670
 Periodic structures, 74
 Periostracum of molluscan shells, 922;
 of brachiopod shells, 926
Peripatus, tracheæ of, 1011
 Peritheces of lichens, 650
Peronosporæ, 638-640
Perophora, respiratory sac of, 915; cir-
 culation of, 915
 'Perspicillum,' Wodderborn's, 125
 Petals, 718
Petrobia lapidum, eggs of, 1009
 Petrological microscope, Swift's, 1068
 Petrology: micro-spectroscopy in, 1081;
 micro-chemistry in, 1082
 Pettenkofer's test, 517
Petunia, seeds of, 724
Peziza, botrytis-form of, 645
 Pfitzer, on reproduction of diatoms, 594
Phacolaria, 852
Phaeosporæ, 625-627
 Phagocytes, 1037 note
Phakellia ventilabrum, 858
Phallus, 647
 PHANEROGAMIA, woody structures, pre-
 paration of, 514
 — embryo-sac of, free-cell formation in,
 534-536
 — relation of, to Cryptogams, 682, 684
 and note; structure of stems, &c., 685,
 700; structure of cells, 686-688; inter-
 mediate lamella, 688; intercellular
 spaces, 688; cell-wall of, 692; sclerogen,
 693; spiral cells in, 693; laticiferous
 tissue of, 695; mineral deposits in cells
 of, 696; woody fibre in, 696 *et seq.*; fibro-
 vascular bundles, 697; root, structure
 of, 700; epiderm of leaves, 712-718;
 flowers of, 718; pollen-grains of, 719;
 fertilisation of, 722; ovules of, 722;
 seeds of, 723
 Phanerogams. See PHANEROGAMIA

PHI

- Philonthus*, antennæ of, 988
 Phloëm, 710
 — of *Exogens*, 697
Pholas, shell of, 924
Phoronis, 950
 Phosphorescence of sea, due to *Noctiluca*, 765
 Phosphorus, as a mounting medium, 521
 Photographic microscope, Zeiss's, 257, 258
 Photometrical equivalent of different apertures, 50
 Photo-micrograph through eye of *Lam-pyrus*, 984
 Photo-micrography for micrometry, 277; projection eye-pieces for, 380
 — Campbell's differential screw used in, 165
Phryganea, eye of, 983
 Phycocyanin in *Chroococcacea*, 547
 Phyco-erythrin, 631
Phycomyces nitens, 641
 Phycophæin, 626
Phylactolemata, 909
 Phyllite, 1077 *note*
Phyllo-poda, 962
Phyllosomata, skeleton of, 968
Physarum album, development of, 635
Physcia parietina, 650
Physma chalogannu, 650
Phytelephas, endosperm of seed of, 693
Phytophthora infestans, 639, 640
Phytopti, mouth-parts of, 1010
Phytoptide, 1008; characters of, 1014
Phytoptus, larva of, 1009
 Picric acid, 485
 Picro-carmin, 489
 Piedmontite, 1005
Picridæ, scales of, 975
 Pigment-cells of cuttles, 942; of vertebrate skin, 1042; of fishes, 1043; of Crustacea, 1043
Pignentum nigrum, of eye, 1043
 Pike, scales of, 1028
Pileorhiza, 710
 Pileus of *Acetabularia*, 563
Pilidium gyrans, 950
Pilulina Jeffreysii, 812
 Pimpernel, petals of, 719
 Pines, pollen-grains, showers of, 722 *note*
Pinna, structure of shell of, 919-922; prisms of shell of, in *Globigerina* ooze, 1086; prisms of, in chalk, 1087
 — *nigrina*, colour of shell of, 921
Pinnularia, 617
 — *dactylus*, 621
 — *nobilis*, 621
Pinus canadensis, 443
 Pipette, 351, 476
 Pisolithic grains, 1084
 Pistil, 722
 Pitcher-plant, spiral fibre cells of, 698
 Pith, arrangement of, 700, 762
 Pitted ducts of Phanerogams, 699
 Placoid scales, 1028
 Plagioclase felspar, 1080
Planaria, stomach of, 946

POL

- Planaria*, 946; movement of, 946; fission of, 947; ocelli of, 947; intracellular digestion in, 863
 Planarians. See *Planaria*
 — allied to *Ctenophora*, 883
 Plano-concave lens, 13
 Plano-convex lenses, 13, 15, 22, 37
Planorbulina, 824
Plantago, 'Plantain,' cyclosis in, 691
 Plants and animals, differences between, 531
 Planulæ, 868
Planularia hexas, in chalk, 1087
 Plasmode in cells of *Nitella*, 579 *note*;
 of *Æthalinum*, 634; of *Myxomycetes*, 635
 Plasmodium of *Protomyxa aurantiaca*, 729
 Plastid, contrasted with cytode, 727
 Plastidules, flagellated, of *Protomyxa*, 729
 Plates, calcareous, of *Holothurioidea*, 895
 Pleochroism, 1078, 1098
 Pleochroism, variations of, 1080
Pleurosigma, 588, 617
 — diffraction image of, 71
 — *angulatum*, 69-71; as test for definition, 426; markings on, 592, 593
 — *formosum*, as test for definition, 426
 — *Spencerii*, sporules of, 597
 Pliny, on cauterisation by focussing sun's rays, 117; on sight, 118
Ploimo, 791, 792
Plumatella, collecting, 528
 'Plumed-moth,' wings of, 999
 Plumule of *Pteridæ*, 975
 Plutarch, on myopy, 118
Pluteus larva of echinoids, 897-899
Podocystis cothurnata, 847
 — *mitra*, 847, 852
 — *Schomburgkii*, 849, 852
Podophrya quadripartita, 784; immature form, 785
 — *elongata*, 785
Podosphecia, sporules of, 597
Podura scale as test for high powers, 389
 'Podura scales,' 976, 979
Poduridæ, 979
 Pointer in eye-piece, 381
 Poisons, micro-chemistry of, 1103
 Polarisation tints, 1080
 Polariscope, condensers for use with, 314; for examination of gastropod palates, 933; crystals for use with, 1097; list of objects for, 1099
 Polarised light, rings and brushes of minerals under, 319, 320; for insect work, 423; use of, in micro-petrology, 1068
 Polariser, 318, 319; achromatic convergent for, 1070 *note*
 Polarising apparatus, 317-319; condenser for, 314; Swift's illuminating and, 319
 Polarising prism, substitution of opalescent mirror for, 194
 'Polierschiefer,' 617

POL

- Polishing ground sections, 511
 — sections of hard substances, 506
 — -slate, 617
 — -stones, 508, 617
Polistes (wasp), with attached mould, 642
 Pollen-chambers of anthers, 720
 — -grain and tube, 684
 — -grains, 719; form of, 720; experiments with, 721
 — mass, of orchids, 722
 — tube, 721
 — tubes, traced through the style, 723
 Pollinium of orchids and asclepiads, 722
 Pollinoids of *Floridæ*, 632; of lichens, 650
 Polyaxial spicules, 859
Polycelis levigatus, 947
Polyclinidæ, 913
Polycystina, 846, 851
Polycystinae, as test for low powers, 389; mounting, 481
Polydesmida, 981
 'Polygastrica,' Ehrenberg's erroneous views on, 753
Polygonum, pollen-grains of, 721
Polymorphina, 820
Polyommatus Argus, scales of, 976
 Polyparies of zoöphytes, 862
 Polypary of hydroids, 867
 Polypes, 863. See *Hydrozoa*
 Polypide, of *Polyzoa*, 906; formation of buds from, 907
 Polypidom of zoöphyte, 904
 Polypite, of hydroids, 867
Polypodium, sori of, 675
Polyporus, 647
Polystichum angulare, apospory in, 680
Polystomella, shell of, 797
 — *craticulata*, 827, 829
 — *crispa*, 827, 829
 Polythalamous *Foraminifera*, 796
Polytoma uvella, life-history of, 759
Polytrema, 824; mode of growth compared with *Eozöön*, 838
 — *miniaceum*, colour of, 799
Polytrichum commune, 670, 671
Polyænus lagurus, hair of, 981
 — — hair of, as test for objectives, 389; as test for definition, 426
Polyzoa, collecting, 527, 528; keeping alive, 528; 'cell' of, 904; structure of, 904; gemme of, 906; muscular system, 907; sexual reproduction of, 907; 'colonial nervous system,' 907 and *note*; fresh-water, lophophore of, 909; epistome of, 909; classification of the group, 909; bibliography of, 910; relation to *Brachiopoda*, 927; 'liver' of, 1047
 Polyzoaries in coralline crag, 1090
 Polyzoary, 904
 Pond-stick, 526
 Poplar, pollen-grains of, 723
 Poppy, laticiferous tissue, 695; seed of, 723
Porcellanea, 801-810

PRI

- Porcellanous shells of *Foraminifera*, 799; of *Gastropoda*, 928
 — and vitreous *Foraminifera*, difference in, 799-801
 Porcupine, hair of, 1030
 Pores of sponges, 856
Porphyra, trychogyne of, 632
 Porphyritic crystals, glass inclusions in, 1074
 'Portable' microscope, 245-247; Powell and Lealand's, 245; Rousselet's binocular, 245; Swift's, 245; Baker's, 246; Bausch and Lomb's, 247
Portunus, skeleton of, 968
 Positive aberration, 360 *note*
 — eye-piece, 43
 — eye-pieces, 377, 378
 Potash, caustic, action on horny substances, 517
 Potato-disease, 640
 — starch-grains of, 695
 — tubers, starch in, 694
 Powell (T.), formula for objective, 34
 Powell and Lealand's homogeneous immersion objective, 30; fluorite lenses, 35; high-power binocular, 105; sub-stage, 186, 195, 196; their microscopes, 194, 218, 237; portable microscope, 245; rotating nose-pieces, 291; achromatic condenser, 301; achromatic oil condenser, 302; apochromatic condenser, 302; dry achromatic condenser, 309; chromatic oil condenser, 310; condenser for polariscope, 314; bull's-eye, 333; vertical illuminator, 337; protecting ring for coarse adjustment, 352; water-immersion objectives, 362, 364; $\frac{1}{3}$ -inch objective, for observation of cyclosis, 689; objectives for study of monads, 762
 Powell's (H.) microscope, 155; fine adjustment applied to the stage, 155
 — lenses, 361
 — fine adjustment, 174
 Prasmowski and Hartnack's water-immersion objectives, 362
 Prawn, skeleton of, pigment of, 969
 Preparation of vegetable tissues, 514
 Presbyopy, 118
 Preservative media, 517-522
 Primary tissues of *Vertebrata*, 1017
 Primordial cells, 535, 536
 — utricle, 533; of desmids, 580; of Phanerogam cells, 688
 — chamber in *Foraminifera*, 798; of *Orbitolites*, 806
 Primrose, cells of pollen-chambers, 720
 'Prince's feather,' seed of, 723
 Principle of microscopic vision, 43
 Principles of microscopical optics, 1
 Pringsheim, on generative process of *Pandorina*, 557; on *Vaucheria*, 563
 Prism, refraction by, 8, 9; Wenham's, 98; Stephenson's erecting, 100
 — polarising, substitution of opalescent mirror for, 194
 — rectangular, in place of mirror, 192

PRI

- Prism, Nicol's, 318; Nicol's analysing, for resolving striae, 381; Abraham's, 401
 — refracting angle of, 9, 18
 Prismatic epithelium, 1044
 — layer in molluscan shells, 919-925
 — layer of shells compared with enamel, 920, 1025
 — shell-substances imitated, 1102
 Prisms, recombination of light by, 18
Pristis, tooth of, 1024
 Pritchard's doublets, 298
 — microscope with Continental fine adjustment, 153
 Privet hawk-moth, eggs of, 1005
 Problems on refractive index, 5
 Procarp, of *Florideae*, 632
 Projection eye-piece, 380
 Promycele of *Puccinia*, 637
 Prosenchymatous tissue, 696
Proteus, red blood-corpusele of, 1036
 Prothallium of *Sphagnaceae*, 674; of ferns, 677; of *Equisetaceae*, 681; of *Rhizocarpeae*, 681; of *Lycopodiaceae*, 681
Protococcus, as gonid of lichens, 651
 — *pluvialis*, 543-547; life-history of, 543; multiplication of, 544; zoöspores of, 544; mobile and still forms of, 545-547; encysted, 551
Protomyxa aurantiaca, 727-729
 Protoneme of *Batrachospermum*, 575
 Protophytes, 530, 651, 726
 — mounting, 518; mode of nourishment of, 532; movement by cilia and contracting vacuoles of, 535
 Protoplasm, 530; vital attributes of, 531; continuity of, 538, 630; of *Rhizopoda*, 733; of *Noctiluca*, 767
 Protoplasmic substance in *Vertebrata*, 1017
 PROTOZOA, 726-785
 — mode of nourishment of, 532
 'Pseudembryo' of *Antedon*, 903
 Pseudo-navicella, 751
 Pseudo-parenchyme of *Fungi*, 633
 Pseudopodia of *Protomyxa*, 728; of *Famphyrella*, 730; of *Lieberkuchnia*, 731; of *Rhizopoda*, 733; of *Reticularia*, 734; of *Heliozoa*, 734; of *Lobosa*, 734; of *Gromia*, 735; of *Microgromia*, 736; of *Actinophrys*, 738; of *Amaba*, 743; of *Arcella*, &c., 746; in *Amaba* phase of monad, 757; of *Eozoön*, 841; of *Globigerina*, 822; of *Radiolaria*, 847; of endoderm cells in zoöphytes, 862
Pseudoraphideae, 539
 Pseudoscope, Wheatstone's, 92
 Pseudoscopic effects, 95
 — effect with Ramsden's circles, 106
 — vision, 92
 Pseudo-scorpions, 1008
 Pseudo-stigmata of *Oribatida*, 1011, 1012
 Pseudo-tracheae, on fly's proboscis, 990
note

RAY

- 'Psorosperms,' 752
Pteris, sori of, 675; indusium of, 675
 — *serrulata*, apogamy in, 680
Pterocanium, 852
Pterodactylus, bones of, 1092
Pterophorus, wings of, 999
Pteroptus, 1012
Ptilota, 630
Puccinia graminis, 637
 Puff-ball, 647
 Pulvilli of insects, 1001; cockroach, 1000
note
 Pupa of *Neuroptera*, circulation in, 994
 — stage of fly, 1007
 'Purple laver,' 632
Purpura, method of examination of egg-capsules of, 939; supplemental yolk of, 938, 1007
 — *lapillus*, nidamentum of, 934; development of yolk-segments of, 937
 'Puss-moth,' eggs of, 1005
Pyrenogonida, 957; related to *Arachnida*, 959
note
Pyrola, seeds of, 724
 Pyroxene, andesite, 1076

Q

- Quadrula symmetrica*, 747
 Quartz-porphyrines, 1072
 Quartzite, 1077
 Quekett (E.), on Martin's microscope, 140; on production of raphides, 696; on preparation of tracheae of insects, 997; on minute structure of bone, 1092
 'Quills' of porcupine, 1030
Quinqueloculina, 802

R

- Radials of *Antedon*, 901
 Radiating crystallisation, 1097
 Radiation of light in different media, 53-58; in air and balsam, 55-57
Radiolaria, collecting, 529; fossilised forms of, 846, 854
note; central capsule of, 847; skeleton of, 848-854; zoö-xanthelle in, 848; bibliography of, 853
 — colonies of, 848; distribution of, 853-854; mounting, 854
 Radiolarian, shells in 'ooze,' 1086
 Rainey, on presumed cause of cattle plague, 752; on molecular coalescence, 1100
 Ralls, on British desmids, 579
note; classification, 585; on *Nitzschia* and *Bacillaria*, 606
 Ramsden circles, 106
 Ramsden's 'screw micrometer eye-piece,' 272; positive eye-piece, 42, 378, 380
Raphideae, 599
 Raphides of *Phanerogams*, 696; of plants and sponge-spicules compared, 860
 Rays, scales of, 1028

REA

- Reagents, mode of labelling bottles, 402
 Real image, 14 *note*; formation of, 23, 24
 — object image, 375
 Recomposition of light by prisms, 18
 Red ant, integument of, 974
 — blood-corpuscles of *Vertebrata*, 1034;
 size of, in various *Vertebrata*, 1035;
 relative sizes of, in various *Vertebrata*,
 1036
 — coral, 877
 — corpuscles, flow of, 1056
 'Red snow,' due to *Palmella cruenta*,
 558
 'Red spider,' 1013
 Red spots in *Infusoria*, 775
 Reflector, Sorby's parabolic, 334
 Refracted ray, 2
 Refracting angle of a prism, 9, 18
 Refraction, 57
 — angle of, 3
 — of light, laws of, 2, 3
 — by plane surface, 3, 4; by curved sur-
 face, 5; by prisms, 8, 9; by lenses, 10-
 25
 Refractive index, absolute, 2; of water,
 3; relative, 4, 5; of crown glass, 5;
 of flint glass, 5; of balsam, 77; of gum
 styrax, 521; of Canada balsam, 521;
 of monobromide of naphthalin, 521; of
 phosphorus, 521
 — — of silicious coat of diatoms, 521
 — indices of air, of cedar oil, of water, 60
 Reichert's loupes, 38; his lever fine ad-
 justment, 171; his microscopes, 206,
 210, 224, 241, 242, 264-266; his objec-
 tives, 374, 375; his thermo-regulator,
 453
 Reindeer, hair of, 1030
 Reproduction in *Actinophrys*, 740; of
Actinospherium, 741; of *Clathrutina*,
 742; of *Euglypha*, 746; of sponges,
 857; of *Campanulariida*, 870; sexual,
 of *Polyzoa*, 907; agamic, of *Entomo-*
straca, 963; agamic, of *Aphides*, &c.,
 1006
 Reproductive organs of *Acarina*, 1011
 REPTILES, lacunæ in bone of, 1022;
 cement in teeth of, 1026; plates in skin
 of, 1026; epidermic appendages of,
 1029; red blood-corpuscles of, 1034,
 1035; muscle-fibre of, 1049; lungs of,
 1063
Reseda, seeds of, 724
 Residuary secondary spectrum, 365
 Resins, solvents for, 517
 Resolving power of objectives, 83, 425
 — — of object-glasses, 44; of lenses, 64;
 of objective and numerical aperture,
 75, 393
 Respiration of insects, apparatus of, 994
 Respiratory organ of spiders, 1014
Rete mucosum, 1042
Retepora, calcareous polyzoaries of, 909
Reticularia, 733; characters of, 733; ex-
 amples of, 734-737
 Reticulated ducts of Phanerogams, 698
 Retinule, 983

ROS

- Revolving nose-piece, Nelson's, 295
 Rezzi, on invention of compound micro-
 scope, 125
Rhabdammina, 813
 — *abyssorum*, 815
Rhabdolithus pipa, 847
 — *sceptrum*, 847
 Rhabdoliths, in chalk and limestone,
 1084
 Rhabdom, 983
Rhabdopleura, 909
Rhamnus, stem of, 703
Rheophax sabulosa, 815
 — *scorpiurus*, 815
 Rhinoceros, horn of, 1033
Rhizocarpeæ, 681
 Rhizoids of mosses, 669
 Rhizome of ferns, 675
 RHIZOPODA, 733-747
 — protoplasm of, 531; ectosarc of, 534;
 skeletons of, 795; sarcode of, 1018;
 pseudopodial network of, 1053
Rhizosolenia, 614
 — cyclosis in, 587
Rhizostoma, 874, 876
Rhizota, 790, 791
Rhododendron, pollen-grains of, 722
Rhodospermeæ, 574
 Rhodospermin, 631
Rhodosporeæ, 625
Rhopalocanium ornatum, 859
 Rhubarb, stellate raphides of, 696; spiral
 ducts of, 699
Rhynchonellidæ, shell structure of, 927
 Ribbons of sections, 464, 469
Ribes, pollen-tubes of, 723
 Rice, silicified epiderm of, 715
 'Rice-paper,' 687
 Rice-starch, 695
 Riddell's binocular microscope, 97
 Ring-cells, 446-448
 Rivalto (Giordano da), on invention of
 spectacles, 118
Rivulariacea, hormogones of, 548
 Roach, scales of, 1028
Rochca falcata, epiderm of, 714
 Rock, ground-mass of, 1072; fluxion-
 structure of, 1073
 — sections, method of examining, 1081
 Rocks, method of making sections of,
 1066-1068; metamorphism of, 1076
 Rodents, hair of, 1030
 Root of Phanerogams, structure of, 700
et seq.
 Root-cap, 710
Rosalina varians, 798
 Rose, glandular hairs of, 714
 Ross (Andrew), on correction of objec-
 tive-glass, 19-21; his early form of achro-
 matic microscope, 152; mechanical
 movements of his stage, 153; his fine
 adjustment, 153, 173; on illumination of
 objects, 300; his arrangement for
 locking coarse adjustment, 352; his
 achromatic objectives, 356-358; his
 lever of contact for testing covers,
 440

ROS

- Ross's (Andrew) 'Lister' microscope, 153
 Ross, model, 197
 — and Co.'s microscopes, 196, 230–233;
 camera lucida, 285, 286
 Ross-Jackson model, 199
 Ross-Wenham's radial microscope, 199
 Ross-Zentmayer model, 198
Rotalia, 824; intermediate skeleton of,
 825
 — *aspera*, in chalk, 1087
 — *Beccarii*, shell of, 797
 — *Schroeteriana*, 825
 Rotalian series, 823
Rotaliina, colour of shell, 799
 Rotaline shells of *Foraminifera*, 797
 — shell, sandy isomorph of, 814
 Rotating disc of objectives, 290
Rotatoria, 753. See ROTIFERA
Rotifer vulgaris, 787
 ROTIFERA, collecting, 527; keeping alive,
 528; a food of *Actinophrys*, 739; de-
 scription of, 786–792; habitats of, 786;
 structure of, 787–790; *mastax* of, 787;
lorica of, 787; contractile vesicle of,
 789; males of, 790; eggs of, 790; clas-
 sification of, 790, 791; desiccation of,
 791; bibliography of, 792; preparation
 and preservation of, 793, 794; wheel
 apparatus of, compared with velum of
 gastropods, 936, 939; winter eggs of,
 964; non-sexual reproduction of, 1006
 Rotten-stone, 617
 'Round worm,' 944
 Rousselet's binocular portable micro-
 scope, 245; his tank microscope, 268;
 his compressorium, 346; his live-box,
 346; his method of preparing rotifers,
 793
 Royston-Piggott constructs first aperture
 table, 30
Rugosa, 877
Rumia cratagata, eggs of, 1005
 Rush, stellate tissue in, 687
 Rutile in clastic rocks, 1075; a secondary
 mineral in slates, 1076 *note*
 Ryder's microtome, 401

S

- Sabellaria*, tubes of, 948
 Sable, hair of, 1030
Saccamina in limestone, 1090
 — *Carteri*, 812
 — *spherica*, 812
Saccharomyces cerevisiae, 645
Saccharomyces, 645; zymotic action
 of, 645; endospores of, 646
Saccolabium guttatum, spiral cells of,
 633
 Sachs, on *Chara*, 579 *note*
 Sago, starch-grains of, 695
 Salivary glands, 1047
 Salmon, scales of, 1028
 — disease, 640
Salpa, diatoms in stomach of, 614, 623
Salpidae, 911

SCH

- Salpingoeca*, calyx of, 764
 Salt solution as a preservative medium,
 519
 Salter (J.), on the 'teeth' of *Echinus*,
 890
Salvia verbenaca, spiral fibres in seeds
 of, 693
 Sand-grains surrounded by silica, 1075
 'Sand-stars.' See *Ophiuroidea*
 'Sand-wasp,' 974
 Sandy isomorphs (*Foraminifera*), 814
 — tests of *Lituolida*, 814
 Santonine, crystallisation of, 1096
 Sap-wood, 704
Saprolegnia, alliance with *Achlya*, 564
note
 — *ferax*, 640
Saprolegnia, 640
 Saprophytic, *Bacteria*, 658
 — fungi, 633, 642, 647
 Sarcocystids, 752
 Sarcode, 530 *note*, 531; of *Rhizopoda*,
 733
 Sarcolemma, 1049
Sarcoptes scabiei, 1013
Sarcoptidae, mandibles of, 1009; maxillae
 of, 1010; hairs of, 1010; legs of, 1010;
 characters of, 1013
Sarcoptinae, 1013
Sarcosporidia, 749
Sargassum bacciferum, 630
Sarsia (Medusa of *Syncoryne*), 869
 'Saw-flies,' ovipositor of, 1003
Saxifraga, seeds of, 724
 — *umbrosa*, parenchyme of, 688
 Saxifrage, cells of pollen-chambers, 720
 Scalariform ducts of ferns, 674; as modi-
 fied spiral ducts, 699
 'Scales,' covering epiderm of leaves, 714;
 of *Eleagnus*, 714
 — of *Lepidoptera*, 975, 976; of *Coleo-
 ptera*, 975; of *Curculio imperialis*, 975;
 of *Lycaenidae*, 975, 977; of *Pieridae*,
 975; as tests for objectives, 976;
 of insects, markings of, 976; of
Thysanura, 977; on wing of *Lepido-
 ptera*, 999; of fishes, 1026; of reptiles,
 1026, 1029
 Scallops. See *Pecten*
Scarabaei, antennae of, 988
 'Searfskin,' 1041
Scatophaga stercoraria, eggs of, 1005
Scenedesmus, megazoöspores of, 566
 Schists, 1077
 Schizogenous spaces in Phanerogams,
 688
Schizomyces, 651–664
Schizonema, 602, 617
 — *Gravillii*, 618
 — gelatinous sheath of, 588, 617
Schizoneura, character of, 617
 Schmetzler, on movement of *Oscillatoria*,
 548
 Schott (Dr.) and the improvement of
 object-glasses, 32
 Schröder on binocular vision, 105; his
 camera lucida, 285

SCH

- Schultz's method of macerating vegetable tissues, 700
 Schultze (Prof. Max), on identity of 'sarcode' and 'protoplasm,' 530 *note*; on cyclosis in *Diatomacæ*, 587; on affinity of *Carpenteria*, 823
 Schulze (Prof. F. E.), on soft parts of *Euplectella*, 860 *note*
 Schwendener, on lichens, 648
Scirtopoda, 791, 792
 Scissors, spring, 457
 Sclerenchyme of ferns, 674
 Sclerogen, 693
 Sclerotes in *Fungi*, 633; of *Myxomycetes*, 636
Scolopendrium, indusium of, 675; sori of, 675; sporanges of, 676
 Scorpions, 957, 1008
 Screw-collar adjustment, 358
Scrophularia, seeds of, 724
 'Scyphistoma' of *Cyanea*, 875
Scytonema, as gonid of lichen, 651
Scytonemacæ, 548; homogones of, 548
Scytosiphon, conjugation of, 627
 Sea-anemone. See *Actinia*
 Sea-anemones, intracellular digestion in, 863
 Sea-fans, 877. See *Gorgonie*
 'Sea-jellies,' 853
 Sealing-wax varnish, 444
 'Sea-mats,' 908. See *Flustra* and *Membranipora*
 Searcher eye-pieces, 378
 'Sea-slugs,' See *Doris*, *Eolis*
 'Sea-urchin,' 884. See *Echinus*
 Sea-weeds, 625-632
 — continuity of protoplasm in, 538, 630
 — red, 630
 Secondary spectrum, 19, 31; overcome by Abbe's objectives, 365
 Section lifters, 477; cover-glass as, 478
 — mounting, 477, 501, 506
 Sections, ribbons of, 464, 469; of hard substances, 506; of bones, 506, 510; of coral, 506, 510; of enamel, 506; of fossils, 506; of shells, 506; of teeth, 506, 510; of hard and soft substances together, 510; of Phanerogam tissues, 699
Sedum, pollen-grains of, 721; seeds of, 724
 Seeds, 685, 723
 Segmentation of *Gastropoda* egg, 935; of annelid body, 948
 Seiler's solution for cleaning slides, 439
Selaginella, archegone of, homology of, 685
Selaginella, 682
 Selenite plates, 318
 — blue and red, 319
 — stage, 319
 — with mica film, 319
 Selligne's achromatic microscope, 148, 150; objectives, 354
 Semi-apochromatic objectives, 35; of Leitz, 374; of Reichert, 374; of Swift, 375

SIL

- Semperivum*, seeds of, 724
 Seneca, on magnifying by water, 118
 Sense, organs of, in *Mollusca*, 940
 Sensory nerves, 1053
 — organs of sponges, 856
 Sepals, 718
Sepia, pigment-cells, 942
Sepiola, eggs of, 942
 'Sepiostaire' of cuttle-fish, structure of, 924; imitations of, 1102
 Septa in shell of *Foraminifera*, 796, 803, 804
Serialaria, presumed nervous system in, 907
 Serous membrane, 1041, 1042
Serpula, tubes of, 948
Serricornia, antennæ of, 987
Sertularia cupressina, 871
Sertulariida, gonozooids of, 870; zoöphytic stage of, 877
 Sessile cirripeds, 967
 Seta of *Tomopteris*, 953
 'Sewage fungus,' 653
 Sexual fructification of *Thallophytes*, 540
 — generation of *Volvox*, 555
 Shadbolt, on structure of *Arachnoidiscus*, 612
 Shadbolt's turn-table, 451
 Shadow effects, 61
 Shark, dentine of, 1023
 Sharks, scales of, 1028
 Sheep-rot, 945
 Shell, bivalve, of *Ostracoda*, 960
 — calcareous, of *Reticularia*, 733; of *Microgromia*, 736
 — silicious, of *Dictyocysta*, *Codonella*, 773
 — of *Foraminifera*, 796-801; of *Lamelibranchiata*, 919; of *Brachiopoda*, 919
 Shellac cement, protection against cedar oil, 444
 'Shell-fish,' 919. See *Mollusca*
 Shells of *Mollusca*, nacreous layer of, 919, 922, 923, 924; prismatic layer of, 919, 920, 921; colour of, 921; an excretory product, 922; sub-nacreous layer of, 923, 924
 — of *Brachiopoda*, 925; periostracum of, 926; perforations of, 926
 — of *Gastropoda*, structure of, 928
 — of *Cirripedia*, 968
 'Shield' of *Ciliata*, 773
 Shrimp, concretionary spheroids in skin of, 1100
 Shrimps, skeleton of, 969
 Side reflector, 333
 — lever, short, fine adjustment, 174
 — — Swift's vertical fine adjustment, 173
 Siebold, on agamic reproduction in bees, 1006
 Sieve-plates, 710
 Sieve-tubes, 710; in *Exogens*, 697
Sigillaria, 682, 1084
Silene, seeds of, 724

SIL

- Silex in *Equisetaceae*, 680; in epiderm of grasses, 715
 Silk glands of spiders, 1015
 'Silk-weeds,' 569
 'Silkworm,' eggs of, 1005
 Silkworm diseases, 645, 661
Silpha, antennæ of, 988
 Simple magnifier, 37
 — microscope, 248
 Sines, law of, 3
Siphonaceae, 562-564; Munier-Charles on fossil forms of, 564
Siphonostomata, 965 *note*
Siricidae, ovipositor of, 1003
 Sirodot, on alternation of generations in *Batrachospermum*, 575
 Skate, muscle fibre, 1049
 Skeleton, dermal, of *Vertebrata*, 1026; fossilised, 1020
 — fibrous, of sponges, 857
 — silicious, of *Heliozoa*, 734; of *Radio-laria*, 846
 — of sponges, 855; of zoöphytes, 862; of *Echnoidea*, 884; of *Asteroidea*, 891; of *Ophiuroidea*, 891; of *Crinoidea*, 892; of *Holothurioidea*, 894; of *Ante-don*, 901; of *Vertebrata*, structure of, 1020
 Skin, 1041; pigment-cells in, 1042; capillaries in, 1062
 Skip-jack, antennæ of, 987
 Slack, on the costæ of *Pinnularia*, 617
 Slack's optical illusion, 428
 Slide-forceps, 453
 Slides, glass for, 438
 Slides for cultures, 340, 341
 — Seiler's solution for cleansing, 439
 Sliding-plate of objectives, 290
 Sloths, fossil, teeth of, 1024
 Slug. See *Limax*
 Slug's eye, 941
 Slugs, *Rotifera* in, 787
 Smell, organ of, in insects, 1000
 Smith's Cassegrainian microscope, 145, 146
 Smith (H. L.), on Tolles' binocular eye-piece, 101; his vertical illuminator, 336; on classification of diatoms, 599
 Smith (James), his microscope, 155; on use of bull's-eye with high powers, 331; his achromatic lenses, 356; his separating lenses, 360; his mounting instrument, 454
 Smith (T. F.), on markings of diatoms, 593
 Smith (W.), on cyclosis in *Diatomaceae*, 587; on species of diatoms, 600 *note*; on habits of diatoms, 619
 Smith (W. H.), on structure of frustules, 590 *note*; on movements of diatoms, 602
 Snail, 930; eye of, 941. See *Helix*
 muscle of odontophore, 1050
 Snake, lung of, 1063
 Snapdragon, seed of, 723
 Snell's 'Law of Sines,' 49
 Snow, crystals of, 1025

SPH

- Snowberry, parenchyme of fruit of, 688
 Snowdrop, pollen-grains of, 722
 Soda, caustic, action on horny substances, 517
 Soemmering's simple camera, 278
 Sole, scales of, 1026, 1027, 1028
Solen, prismatic layer in, 924
 Solid cones of light for minute observation, 419
 — eye-pieces, 378
 — image, 95
 — objects, delineation of, 88; correct appreciation of, 88
 — vision and oblique illumination, 61
 Sollas, on sponges, 855 *note*; on the extensions of the perivisceral cavity in *Polyzoa*, 927
 Sorby (H. C.), on microscopic structure of crystals, 1066
 Sorby's parabolic reflector, 334
 Sorby-Browning's micro-spectroscope, 323
 Soredes of lichens, 649
 Sori of ferns, 675
 Sound-producing apparatus of crickets, 999
Spatangidium, 610
Spatangus, spines of, 889
 'Spawn' of mushroom, 647
 Spectacles, invention of, 118
 Spectra, diffraction, 67
 — artificial, 324
 Spectral, ocular, Zeiss's, 327
 Spectro-micrometer, bright-line, 325
 Spectroscope in micro-chemical operations, 1103
 Spectroscopic test, 324
 Spectrum, 19; irrationality of, 19
 — binocular, microscope, 327
 — map, 325
 — natural, 324
 — of dark lines, 323; of bright lines, 323
 Speculum, parabolic, 333; Lieberkuhn's, 334-336; in Smith's illuminator, 336
 Spencer Lens Company's Microscopes, 214, 215
 Spermathecae of *Gamasida*, 1012; of *Tyroglyphida*, 1012
 Spermata of *Puccinia*, 638; of lichens, 650
 Sperm-cells of *Thallophytes*, 536; of *Volvox*, 555; of ferns, 678; of sponges, 857; of *Hydra*, 866; of *Polyzoa*, 907
 Spermogones of *Puccinia*, 638; of lichens, 651
Sphaclaria, 626
Sphaelle, 626
Sphæria in caterpillars, 645
Sphaeroplea annulina, 570-572
Sphaerosoma, rows of cells in, 583
Sphaerozoum ovoidimare, 853
Sphagnacca, 673
Sphagnum, leaf of, 673
Sphenogyne speciosa, winged seed of, 724
 Spherical aberration, 14, 15, 31, 299, 301, 306, 387
 — — diminished by Huyghens' objective, 42

SPH

Spheroidal concretions of carbonate of lime, 1100
Sphingide, antennæ of, 988
Sphinx, eye of, 987; antennæ of, 988
 — *ligustri*, eggs of, 1005
 Spicules of alcyonarians, 880
 — of sponges, 857; their names, 859-860
 — silicious, of sponges, 857
 — calcareous, of sponges, 857
 Spiders, 1008, 1014-1016; microscopic objects furnished by, 1014; spinning apparatus, 1015
 Spindle fibres, 538
 Spinnerets of spiders, 1015
 Spiny lobster, metamorphosis, 969
 Spiracles of insects, 995, 996
 Spiral cells in Phanerogams, 693; mode of preparation of, 694
 — crystallisation, 1096
 — focussing arrangement for projection-lens, 380
 — vessels of Phanerogams, 698; observation of, *in situ*, 719; of plants compared with tracheæ of insects, 995
Spiriferide, perforation in shells of, 927
Spiriferina rostrata, shell of, 927
Spirulina, 819
 — sandy isomorph of, 814
Spirillum, movement of, 433; granular spheres of, 660 *note*
 — *undula*, 659
 — *volutans*, movement of, 652, 653, 659
 Spirit, dilute, as a preservative medium, 518
Spirochæte, 653
Spirogyra, 549, 550; attacked by *Vampyrella*, 730
Spirolina, a varietal form of *Pencroplis*, 803
Spiroloculina, 802
Spirula, 929
 — shells of, bearing *Protomyxa*, 727
Spirulina, movement of, 548
Splachnum, sporange of, 669
 Splenic fever due to *Bacillus anthracis*, 656, 661
 Sponge-spicules, 857-860
 — mounting, 481
 — in *Carpenteria*, 822; in mud of Levault, 1085
 Sponges, 855-862; skeleton of, structure of, 855, 856; reproduction of, 857; habitat of, 861; preparation of, 861; bibliography of, 862 *note*
 — fossil, 1089
Spongilla, 861
Spongolithis acicularis, 620
 Spongy parenchyma of leaves, 716
 Spontaneous generation, 761
 Sporangium of *Funghi*, 633; of *Myromyces*, 636; of *Marchantia*, 665, 668; of mosses, 671; of *Sphagnaceæ*, 673; of ferns, 675; of *Equisetaceæ*, 680
 Sporangia of *Lycopodiaceæ* in coal, 1084
 Sporangio-phores of *Mucorini*, 640
 Spore, use of the term, 537 *note*

STA

Spores of *Nostoc*, 549; of *Myromyces*, 634, 636; of *Peronosporæ*, 639; of *Bacteria*, 655, 657, 660; of *Marchantia*, 668; of mosses, 670; of ferns, 676; of ferns, method for studying development of, 679 *note*; of *Equisetaceæ*, 680; of *Lycopodiæ*, 682; of gregarines, 751; of *Monas Dallingeri*, 757; of *Lycopodiaceæ* in coal, 1084
 — different kinds of, 541 *note*
 — resting, of *Chactophoraceæ*, 574
 Sporids of *Ustilaginæ*, 636; of *Puccinia*, 638
 Sporocarp of *Ascomyces*, 614
 Sporogone of mosses, 672
 Sporophores of *Myromyces*, 636; of *Peronosporæ*, 639; of *Ascomyces*, 643
 Sporophyte in ferns, 680
Sporozoa, 749-752
 Sporules of *Melosira*, 597; of *Pleurosigma*, 597; of *Podosphenia*, 597
 Spot-lens, 316
 Spring-clip, 153
 — press, 453
 — scissors, 457
 'Spring-tails,' 979. See *Poduride*
 Squid, 942
 Squirrel, hair of, 1030
 Stag-beetle, antennæ of, 988
 Stage, horse-shoe, Nelson's, 179, 228; of the microscope, 175-184; qualities needful in a, 177; concentric, rotatory motion of, 179; in the 'Continental' model, 259; graduated rotary for use with apertometer, 395
 — attachable, simple form, 180; Swift's, 180; Allen's (Baker's), 181; Reichert's, 183; Bausch and Lomb's, 183, 184; Mayall's, 183; Zeiss's, 183; Beck's, 184
 — forceps, 338
 — micrometer, 270, 274, 288, 290
 — moist, 341
 — plate, glass, 340
 — thermostatic, 344-346
 — Turrell's, 176; Watson's, 177; Zeiss's, 179; Tolles', 204
 — vice, 339
 'Staggers' of sheep, due to *Cœnurus*, 944
 Stall, on movement of desmids, 581
 Staining, 488
 — regressive, 491
 — *Bacteria*, 514-516
 — flagella, 516
 Stains, *intra-vitam*, 488, 489
 — for unfixed tissues, 489
 — for fixed tissues, 490, 491
 — nuclear, 491-494
 — plasma, 494, 495
 Stains, solutions of, methylen blue, 488; Bismarck brown, 489; Congo red, 489; methyl green, 489; neutral-red, 489; alcoholic borax-carmin, 490; alum-cochineal, 490; carmalum, 490; hæmalum, 490; alcoholic cochineal, 491; iron-hæmatoxylin, 492; 'Kernschwarz,'

STA

- 492; saframin, 493; acid-fuchsin, 494; basic-fuchsin, 494; Lyons blue, 494; picric acid, 494; water-blue, 494; thionin, 494
- Stanhope lens, 37
- Stanhoscope, 38
- Staphylinus*, antennæ of, 988
- Star-anise, tissue of testa of, 692; testa of seeds of, 725
- Starch, tests for, 517; formation of, 694 — grains, 534, 535; mode of growth, 694; hilum of, 695; in *Canna*, 695; in potato, 695; in wheat, 695; in rice, 695
- 'Star-fish,' 891. See *Asteroidea*
- Statospore of *Protomyxa*, 728
- Staurostrum*, binary division of, 582; form of cell, 585 — *dejectum*, 568
- Stauroncis*, 617
- 'Stauros' of *Achnanthes*, 616
- Steenstrup on alternation of generations, 877
- Stein, on affinities of *Volvox*, 551 *note*; on contractile vacuoles of *Volvox*, 552 *note*; on *Flagellata*, 764; on *Noctiluca*, 769 *note*; on *Acinetina*, 785 *note*
- Steinheil's loupes, 38; his combination of lenses, 38; his aplanatic loup, 249; his loup for tank work, 268; his formula for combination of lenses, 316; his triple loupes, 378
- Stellaria*, seeds of, 724 — *media*, petals of, 719
- Stem of mosses, 669; of *Bryaceæ*, 673; of *Sphagnaceæ*, 673; structure of, in Phanerogams, 700; of Phanerogams, development of, 709; treatment of, for examination of their structure, 711
- Stemmata of insects, 986; of spiders, 1014
- Stentor*, collecting, 527; contractile vesicle of, 774; impressionable organs of, 775; conjugation of, 782
- Stephanoceros*, collecting, 527; in confinement, 528
- Stephanolithis spinescens*, 847 — *nudosa*, 847
- Stephanosphaera pluvialis*, amœboid phase of, 557 *note*
- Stephenson, on *Pleurosigma angulatum*, 70; on 'intercostal points,' 73 — his suggestion on homogeneous immersion, 28 — on *Coscinodiscus*, 609
- Stephenson's stereoscopic binocular, 100; its erecting arrangement, 101, 102; as a dissecting microscope, 248, 456; his tank microscope, 267
- Stereocaulon ramulosus*, 650
- Stereoscope, 91; Brewster's modification of, 91
- Stereoscopic binocular, Wenham's, 98; for study of opaque objects, 103-105 — eye-piece, Tolles's, 101; Abbe's, 102 — vision, 90-97
- Sterigmata of *Puccinia*, 637

SUP

- Sterile cells of *Volvox*, 555
- Stichopus Kefersteini*, 895
- Stick-net for marine work, 529
- Stickleback, parasite of, 966; circulation in tail of, 1057
- Stigmata of insects, 995, 996
- 'Stinging hairs' of nettle, 714
- Stings of insects, 1002, 1003
- Stipe of diatoms, 588; of *Liemophora*, 604; of *Gomphonema*, 616
- Stolon of *Foraminifera*, 796; of *Eozoön*, 839; of *Laguncula*, 904; of ascidians, 914
- Stomach, follicles of, 1047
- Stomates, 715 — of *Marchantia*, 666
- Stomopneustes variolaris*, spines of, 888
- Stone-cavities in crystals, 1073
- Stone-mite, eggs of, 1009
- Stones of fruit, preparing sections of, 699 — of stone fruit, constitution of, 693
- Stone-wort, 576
- Stony corals, resembled by polyzoaries, 904
- Stop, introduction of, 37; in the eye-piece, 42; use of, 312, 316
- 'Straight extinction,' 1079
- Strawberry, parenchyme of fruit, 688
- Streptocaulus pulcherrimus*, 871
- Striated muscle, 1048; size of fibres in different groups, 1049
- Striatella unipunctata*, 598
- Striatellea*, characters of, 607
- 'Strobila' of *Cyanca*, 875
- Stromatopora*, doubtful character of, 842
- Stromatoporoids, 817 *note*
- Strophomenideæ*, perforations in shells of, 927
- Stylodyctya gracilis*, 851
- Suberous layer of bark, 708
- Sub-nacreous layer in molluscan shells, 923, 924
- Sub-stage, 184-191, 262; Nelson's fine adjustment to, 185; Powell and Lealand's, 186; Karop's fine adjustment to, 187; Watson's, 187; Baker's, 188; centring nose-piece used as, 230
- 'Sub-stage condenser,' Nelson on, 72 *note*; compound, 134 — illumination, 298-316 — simplest form of, 313
- Succulent plants, stomates in, 716
- Sucker on legs of *Sarcoptida*, 1010
- Suckers on foot of *Dyctiscus*, 1001; of *Curculionideæ*, 1002
- Suctorina* (*Protozoa*), 783-785 — (*Crustacea*), 965, 966
- 'Sugar-louse,' 977. See *Lepisma*
- Sulphuric acid, as a test, 517
- 'Sun-animalcule,' 737
- 'Sundew,' glands of, 714
- Sunk-cells, 449
- Super-amplification, 33
- Super-stage, *see* attachable mechanical stage, 180

SUP

- Supplemental yolk in *Purpura*, 988, 939, 1007
Survirella, 588, 606; conjugation of, 599; zygospores of, 599; movements of, 602; frustule of, 606
 — *biseriata*, cyclosis in, 587
 — *caledonica*, 621
 — *constricta*, 606
 — *craticula*, 621
 — *plicata*, 621
Survirella, 606
 Suspensor of ovule of Phanerogams, 534
 Suture line of desmids, 580
 Swarm-spores, 536; meaning of term, 537 note; of *Pandorina*, 557; of *Cutleria*, 627; of *Clathrulina*, 742; presumed, of *Pelomyxa*, 745
 Sweat-glands, 1042
 'Sweetbread,' 1047
 Swift's side-lever, 162; vertical side-lever fine adjustment, 173, 174; attachable stage, 180; microscopes, 203, 224, 228, 233; portable microscope, 245; condenser, 302, 305; condenser for polariscope, 314; microspectroscope, 325 note; objectives, 375; petrological microscope, 1068
 Symbiosis in lichens, 650
Symbiotes tripilis, hairs of, 1010
 Symbiotic algae in radiolarians, 848
 Sympathetic nerves, 1054
Symphytum asperrimum, seeds of, 724
Synalissa symphorea, 650
Synapta digitata, 'anchors' of, 895
 — *inherens*, 'anchors' of, 895
Synapta, rotifers in, 787
Syncoryne Sarsii, gonozooids of, 868
Syncrypta, 545
Synedra, 606
Syringamina, 811
 Syringe for catching minute aquatic objects, 351
 Syrup, as a preservative medium, 519
 — and gum, as a preservative medium, 519

T

- Tabanus*, eyes of, 987; ovipositor of, 1004
Tabellaria vulgaris, 621
 Table of numerical apertures, 84-87
 — for microscopists, 398-402; for dissecting and mounting, 399
 Tactile papillae of skin, 1042; nerve to, 1053
 Tadpole, pigment-cells of, 1043; circulation in tail of, 1056; general circulation in, 1057; blood-vessels of, 1059, 1060
 — of ascidians, 917
 Tadpole's tail, epithelium of, 1044
Tænia, 943
 Tank microscopes, 266-269
 Tannin, test for, 517
 Tapetal cells in fern antherid, 678
 'Tape-worm,' 943

THA

- Tardigrada*, desiccation of, 945
Tarsonemidæ, 1013
 Taste, organs of, in insects, 993, 1000
 Teeth, decalcification of, 512
 — fossilised, 1090
 — of palate of *Helix*, 930; of *Limax*, 930; of *Buccinum*, 930; of *Mollusca*, 930
 — preparation of, 1023 and note
 — of *Echinus*, 890; of *Ophiothrix*, 892; of *Vertebrata*, 1023
 — of elephant, Rolleston on enamel in, 928; of *Rhodentia*, Tomes on enamel in, 928
Tegeocranus cepheiformis, 1008
 — *dentatus*, 1008
 Tegumentary appendages of insects, 974
 Telescope, Barker's Gregorian, 145
 Teleutospore generation of *Puccinia*, 637
 Temperature, effect of, on various monads, 761
 Tendon, 1019
 Tentacle of *Noctiluca*, 766, 768
 'Tentacles' of *Drosera*, 714; of *Suctorina*, 785; of *Hydra*, 864; of annelids, 949
Tenthredinidæ, ovipositor of, 1003
Terebella, tubes of, 948; gills of, 949
 — *conchilega*, 948
Terebratulæ bullata, shell of, 927
Terebratulæ, shells of, 925, 926
Terpsinoë musica, 608
Terpsinoëæ, character of, 607
 Tertiary tints in crystalline bodies, 1097
 Tessellated epithelium, 1044
 Test of *Gromia*, 735; of *Arcella*, 746; of *Difflugia*, 746
 Testa of seeds, 725
 Testaceous amoebans, 746, 747
 Testing object-glasses, 381; diaphragm for use in, 385; Frapp's method, 386; Abbe's method, 384-387
 Test-plate, Abbe's, 387
 Tests, sandy, of *Lituolida*, 814
Tethya, spicules of, 1086
Tetramitus rostratus, life-history of 760; nucleus of, 763
Tetrynychii, 1013
Tetrynychus, mandibles of, 1009
 Tetraspores of *Floridea*, 631; of *Vampyrella*, 730
Textularia, 823
 — *aculeata*, in chalk, 1087
 — *globulosa*, in chalk, 1087
 Textularian form of shell, 798
 — series, 823
Textulariæ, 811
Textularinæ, arenaceous character of, 823
Thalassicolla, 846, 853
 Thallophytes, 530-632
 Thallophytic type, passage to cormo-phytic, 668
 Thallus of *Ulva*, 560; of *Phæosporeæ*, 626; of lichens, 649
Thaumantias Eschscholtzii, 873
 — *pilosella*, 873

THE

'Theca' of mosses, 671
Thecaphora, 868
Thecata, 868, 870
 — zoöphytic stage of, 877
 Thermo-regulator, Reichert's, 453
 Thermostatic stage, Dallinger's, 344-346
 Thoma's (Jung) microtome, 461-469
 Thompson (J. Vaughan), on pentacrinoid larva of *Antedon*, 901; on *Cirripectia*, 967
 Thomson (Wyville), on development of *Antedon*, 903
 Thread-cells of *Ciliata*, 773; of *Hydra*, 864; of *Zoantharia*, 878, 879; of planarians, 947
 'Thread-worm,' 944
 Threads of spiders' webs, 1015
Thurammina papillata, 815
 Thwaites, on conjugation of *Epithemia*, 599; of *Melosira*, 560
Thysanura, scales of, 977
 Ticks, 1008. See *Acarina*
Tineidæ, wings of, 999
Tinoporos buculatus, 824
Tipula, spiracle of, 976; eye of, 987; antennæ of, 988
 Tolles' binocular eye-piece, 101; his mechanical stage, 204; his immersion objectives, 362, 364; his apertometer, 390
 Tomes (Charles), on teeth, 1025
Tomopteris onisciformis, 952, 953; development of, 954
 — *quadricornis*, 954
 'Tongue' of *Gastropoda*. See Palate
 'Tortoiseshell butterfly,' eggs of, 1005
Torula cerevisiæ, 645
 Total reflexion, 6, 7
 Tourmaline, pleochroism in, 1078
 Tow-net, 528
 Tow-nets of *Challenger* Expedition, 529 note
 Tracheæ of insects, 994; of *Acarina*, 1011
 Tracheïdes of ferns, 674; of conifers, 698, 703
Trachelomonas, 545
Tradescantia virginica, cyclosis in hairs of, 691
Tragulid javanicus, red blood-corpuscle of, 1035
 Trematodes, 945
Triceratium, 588, 613
 — as test for illumination, 415, 416
 — *favus*, 593, 613
 — *fimbriatum*, as test for medium powers, 389
 Trichocysts of *Ciliata*, 773
Trichoda lynceus, crawling of, 774; reproduction of, 780, 781
Trichodina grandinella, a phase in development of *Forticella*, 780
 Trichogyne of *Colcochate*, 575
 — of *Florideæ*, 632; in lichens, 650
Trichonympha, 774
 Trichophore of *Florideæ*, 632

UNG

Trichophrya, a phase in development of *Suctorïa*, 785
Trigonia, prismatic layer in, 924
Triloculina, 802
 Triple-backed objectives, 361
 Triplet, Holland's, 37
 Triplex front to objectives, 370
 Tripoli stone, 617
Trochus zizyphinus, palate of, 931
Trombididæ, 1008, 1009; legs of, 1010; hairs of, 1010; eyes of, 1011; tracheæ of, 1011; characters of, 1012
Trombidium, maxillæ of, 1010; larvæ of, 1013
 — *holosericum*, 1013
 Trophi of *Rotifera*, 788
Truncatulina rosea, colour of, 799
 'Tube-cells,' cements for, 442
 Tube-length, English and Continental, 158, 159
 Tuberculosis, bacillus of, 661; methods of staining, 515, 516
Tubifex rivulorum, gregarine of, 751
Tubipora, 877
Tubularia, gonozooids of, 869
 — *indivisa*, 869
 Tubuli in *Nummulites*, 827; of dentine, 1024
Tubulipora, 909
 Tulip, raphides of, 696
 Tully's (Lister's) achromatic microscope, 149; his live-box, 345; his triplet, 354; his achromatic objective, 354
 'Tunic' of *Tunicata*, 911
 TUNICATA, 904, 911-918; zoölogical position of, 911; bibliography of, 918; 'liver' of, 1047
Turbellaria, 946, 947
 — larvæ of, collecting, 529
 Turbinoid shell of *Foraminifera*, 797
Turbo, shell structure of, 928
 Turkey-stone, use of, 508; constituents of, 617
 Turn-table, Shadbolt's, 451; Griffith's, 451
 Turpentine, uses of, 444, 518
 Turrell's mechanical stage, 176
 Twin lamellæ in leucite, 1078
Tylenchus tritici, 945
 Tympanum of cricket, 999
Tyroglyphi, nymph of, 1009; legs of, 1010
Tyroglyphidæ, reproductive organs of, 1012; characters of, 1013

U

Ulothrix, conjugation of, 557
Utra, 560, 561
Ulvacea, 559-561
 Umbelliferous plants, seeds of, 724
Umbonula verrucosa, 906
 Under-corrected objective, 20, 21
 Under-correction, 355-360
 Unger, on the zoöspores of *Faucheria*, 563

UNI

- Unicellular plants, 538
Unio, pearls in, 923; glochidia of, 933
 — *occidens*, formation of shell in, 925
Unionida, nacreous layer of, 923
 Unit (standard) for microscopy, 460
Uredinea, 636-638; alternation of generations in, 636
 Uredo-form of *Puccinia*, 638
 Uredospores of *Puccinia*, 638
 Urinary calculi and molecular coalescence, 1102
 Urine, micro-chemical examination, 1103
Urochordata, 911
Uropoda, tracheae of, 1011
 'Urticating organs.' See Thread-cells
Ustilagineae, 636
Uvella, 545
- V
- Vacuoles in vegetable cell, 534
 — contractile, in protophytes, 535; of *Volvox*, 552
 — of *Actinophrys*, 737
 Vagine of mosses, 671
Vallisneria, habitat, 689; mode of demonstration of cyclosis, 689, 690
Valvulina, shell of, 798
Vampyrella, 729, 730
 — *gomphonematis*, 729
 — *spirogyra*, 729
Vanessa, eye of, 987; haustellium of, 992
 — *urtica*, eggs of, 1005
 Variation, range of, in *Astromma*, 849
 Varley's live-box, 346
 Varnish, test for, 443; asphalte, 443
 Varnishes, 442-445; sealing-wax in alcohol, 444; red, 445; white, 445; various colours, 445
 'Vascular Cryptogams,' links with Phanerogams, 682
 Vascular papillae of skin, 1042
Vaucheria, 562, 563
 — *Rotifera* in, 787
 'Vegetable ivory,' endosperm of, 693
 Vegetable substance, preparation of, 514; gum-embedding for, 514; bleaching of, 514
 Veins of vertebrates, 1056
 Velum, in gastropod larva, 936
 Venice turpentine cement, for glycerin mounts, 444
Ventriculites, 861, 1088
 Venus' flower basket, 859, 860; spicules of, 860
Verbena, seeds of, 724
Vertebrata, 1017-1065; bone of, 1020; teeth of, 1023; dermal skeleton of, 1026; blood of, 1034; red blood-corpuscles, 1034; white blood-corpuscles, 1036; fibrous tissues, 1038; skin, mucous and serous membrane, 1041; distribution of ciliated epithelium, 1044; fat, 1045; cartilage, 1046; glands of, 1047; muscle, 1048; nervous tissue, 1051; circulation, 1054; respiration, 1063

WAR

- Vertebrated animals, 1017. See *Vertebrata*
 Vertical illuminator, 336-338; how to use, 337; for examination of metals, 337; for ascertaining 'aperture,' 338
Vespidæ, eye of, 987
Vibracula of *Polyzoa*, 910, 911
Vibrio, movement of, 433
 — *rugula*, 659
 'Vibriones,' as applied to certain nematodes, 945
Vibriones, form of, 653, 659
 Vigeliu, on tentacular cavity of *Polyzoa*, 905 *note*
 Vine, size of ducts of, 699
Viola tricolor, pollen-tubes of, 723
 Violet, cells of pollen-chamber, 720
 Virginian spider-wort, cyclosis in, 691
 Virtual image, 14 *note*, 24, 25, 376
 Vision, depth of, 88, 89, 90; stereoscopic, 89
 Visual angle, 27
Vitrea (*Foraminifera*), 819
 Vitreous cells (arthropod eye), 983
 — optical compounds, 31
 — shells of *Foraminifera*, 799
 'Vittæ' of *Licmophorea*, 604; of seeds of umbellifers, 724
 Vocal cords, structure of, 1040
 Vogan's changing nose-piece, 294
 Volcanic ashes and dust, microscopical examination of, 1076
Volvoceae, 550-557
Volvox associated with *Astasia*, 765
 — vegetable nature of, 556 *note*: amcebiform phase of, 556; *Rotifera* in, 787
 — *aureus*, cellulose in, 552; starch in, 552
 — *globator*, 550-557; flagellate affinities of, 551 *note*; contractile vacuoles in, 552; endochrome of, 552; development and reproductive cells of, 554-556
Forticella, foot-stalk of, 773; contraction of foot-stalk, 774, 775; fission of, 777; encystment of, 778; classification of, 782; gemmiparous reproduction of, 782; conjugation of, 782
 — *microstoma*, 779

W

- Waldheimia australis*, shell of, 926
 Wale's model, 224; his limb, 224; his coarse adjustment, 226; his fine adjustment, 226
 Wallflower, pollen-grains of, 722
 Wall-lichens, 649
 Wallich, on structure of diatom frustule, 590 *note*; on *Triceratium*, 613 *note*; on *Chaetocera*, 614 *note*; on coccospheres, 747; on *Polycystina*, 852 *note*
 — his plan for sectioning a number of hard objects, 508 *note*
 'Wanghie cane,' stem of, 701
 'Warm-stage' for observing blood-corpuscles, 1034

WAR

Warmth, mode of applying, for cyclosis, 692
 Wasps, wings of, 998, 999; sting of, 1003
 Water, refractive index of, 3, 7
 — distilled, for mounting *Protophytes*, 518
 — milfoil, collecting, 527
 Water-angle, 50
 Water-bath, 452
 Water-boatman, wings of, 1000
 'Water-fleas,' 959, 962
 Water-globules in oil, 429, 430
 Water-immersion objectives, 362; Zeiss's, 370
 Water-lily, leaf-structure of, 717; cells of pollen-chambers, 720
 'Water-mites,' 1013
 'Water-net,' or *Hydrodictyon*, 565
 Water-of-Ayr stone, 508
 Water-scorpion, 995. See *Nepa*
 'Water-snail.' See *Limnæus*
 Water-vascular system of *Tænia*, 943
 Watson's microscopes, 199-202, 218, 224, 234, 237; coarse adjustment, 161, 202; fine adjustment, 162, 172, 174, 175; mechanical stage, 177; sub-stage, 187; nose-piece, 292; condensers, 303, 304; objectives, 375; eye-pieces, 379
 Wavellite in *Mya*, 924
 Web of spiders, 1015
 Weber's annular cells, 350
 Webster condenser, 308
 Weismann, on development of *Diptera*, 1007
 Wenham, on binocular vision, 105; on cyclosis of *Vallisneria*, 690
 Wenham's suggestion of homogeneous immersion, 29; his stereoscopic binocular, 98, 99; his prism, 98; his paraboloid, 316-317; his achromatic objective with single front, 361; his duplex front objective, 362
 West, on *Chatocæra*, 614 note
 'Whalebone,' 1033
 Wheat, starch-grains of, 695
 Wheatstone's stereoscope, 91; his pseudoscope, 92
 'Wheel-animalcules,' 753, 786. See ROTIFERA
 Wheel-like plates of *Chirodota*, 896
 'Wheels' of *Rotifera*, 787
 Whelk. See *Buccinum*
 'White ant,' ciliate parasite of, 774
 White blood-corpuscles of *Vertebrata*, 1036; flow of, 1056
 — fibrous tissue, 1038-1041
 — of egg, as a preservative medium, 519
 Whitney's directions for examination of frog's circulation, 1060
 Wild clary, spiral fibres of, 693
 Williamson (W. C.), on *Folvor*, 556 note; on structure of fish-scales, 1027; on structure of coal-plants, 1084
 Willow-herb, emission of pollen-tubes, 722
 Wing of *Agrion*, circulation in, 994
 Winged seeds, 724

ZÖÖ

Wings of insects, 998-1000; of *Pterophorus*, 999; venation of, in *Neuroptera*, 998
 Wodderborn, on Galileo's invention of compound microscope, 121, 125
 Wodderborn's 'perspicillum,' 125
 Wollaston's doublets, 36, 153; his camera lucida, 278
 Wood, arrangement of, 700, 702; concentric rings of, 703; fossilised, 705, 1083
 Wooden slides for opaque objects, 450
 Woody fibre, 696
 — tissue of ferns, 674
 Working eye-pieces, 378
 Worms, 943-956

X

Xylem of Exogens, 697, 698, 710
 Xylol-balsam as a preservative medium, 518, 521

Y

Yeast, 646; fermentation due to, 646
 Yellow cells, in *Actinæ*, 848; in radiolarians, 848
 — fibrous tissue, 1039, 1040
 Yolk-bag of young fish, circulation on, 1057
Yucca, epiderm of, 712; guard-cells of stomates in, 715, 716

Z

Zanardinia, swarm-spores of, 627
Zea Mais, epiderm of, 712; stomates of, 715
 Zeiss's oil-immersion objectives, 29; his eye-pieces and objectives, 34; his photographic microscope, 178, 257, 258; his mechanical stage, 179, 183; his latest microscope, 206, 237; his dissecting microscope, 248, 253; his applanatic loup, 249, 268; his calotte nose-piece, 292; his sliding objective changer, 293; his iris-diaphragm, 297; his spectral ocular, 327; his apochromatic objective, 366-374; his water-immersion, 370; his apochromatic, for resolving diatom markings, 592; his apochromatic for study of monads, 762
 Zeiss-Steinheil's loupes, 249, 268
 Zentmayer's microscope, 204; swinging sub-stage in, 204
 Zeolite, 1095
 Zinc, chlor-iodide of, as a test, 516
 — cement, Cole's, 445; Zeigler's, 445
Zoantharia, 877
 Zoëa, 970
 Zonal structure in crystals, 1073
 Zoëchlorellæ of *Heliozoa*, 734
 Zoëcytium of *Ophrydium*, chemical composition of, 778

ZÖÖ

- Zoöglœa of *Beggiatoa*, 653
 Zoöglœæ, 655, 657
 ZoöPHYTES, 862-883
 — cells for mounting, 448, 449
 — non-sexual reproduction of, 1006
 Zoöphyte troughs, 348-350
 Zoösporangium of *Volvox*, 554, 555
 Zoösporangia of *Phæosporeæ*, 626
 Zoöspores, 536; of *Protococcus*, 544, 545;
 of *Palmodictyon*, 559; of *Ulva*, 560;
 of *Vaucheria*, 562; of *Achlya*, 565;
 development of, 565; of *Hydrodictyon*,
 566; of *Confervaceæ*, 570; of *Ædono-*
gonium, 572; of *Chatophoraceæ*, 574;
 of *Coleochætaceæ*, 575; of *Phæosporeæ*,
 626; of *Fungi*, 633; of radiolarians,
 849
Zoöthamium, collecting, 527

ZYM

- Zoöxanthellæ in radiolarians, 848
 Zoözygospores of *Navicula*, 597
 Zukal, on movement of *Spirulina*, 548
Zygnemaceæ, characters of, 549; habitats
 of, 549; conjugation of, 549
 Zygnosis in *Actinophrys*, 740; of *Amœba*,
 744; of gregarines, 751
 Zygosporium, 537; formation of, 540; of
Hydrodictyon, 565; in *Desmidiaceæ*,
 584, 585
 Zygosporia of *Palmoglœa*, 542; of *Meso-*
carpus, 550; of *Spirogyra*, 550; of
Pandorina, 557; of *Ulva*, 561; of
Navicula, 597; of diatoms, 599; of
Mucorini, 641
 Zygote of *Glenodinium*, 770
 Zymotic or fermentative action of *Fungi*,
 633

PRINTED BY

SPOTTISWOODE AND CO. LTD., NEW-STREET SQUARE

LONDON



